

LM3538 6-Channel WLED Driver with Four Integrated LDOs

Check for Samples: [LM3538](#)

FEATURES

Lighting:

- **6-channel Backlight Capability**
- **Internal ALS Engine; PWM Input to Support CABC**
- **Built-in Power Supply and Gain Control for Ambient Light Sensor**
- **Up to 90% Efficiency**
- **Adaptive Charge Pump with 1x and 1.5x Gains for Maximum Efficiency**
- **128 Dimming Steps for Group A, Exponential or Linear Dimming Selectable by Register Setup**
- **8 Linear Dimming States for Group B**

LDOs:

- **4 Programmable LDOs (300mA/150mA Output Currents)**
- **Default Startup Voltage States**
- **Low Dropout Voltage: 100mV typ. at 150mA Load Current**
- **LDO Input Voltage = 1.8V to V_{IN_A}**
- **Overload Protection**

Combined Common Features:

- **Wide Input Voltage Range: 2.7V to 5.5V**
- **I²C-compatible Serial Interface**
- **2 General-purpose Outputs**

APPLICATIONS

- **Smartphone Lighting**
- **MP3 players, Gaming Devices**
- **Digital Cameras**

DESCRIPTION

The LM3538 is a highly integrated LED driver capable of driving 6 LEDs in parallel for single display backlighting applications. Independent LED control allows for a subset of the main display LEDs to be selected for partial illumination applications.

I²C-compatible control allows full configurability of the backlighting function. The LM3538 provides multi-zone Ambient Light Sensing allowing autonomous backlight intensity control in the event of changing ambient light conditions. A PWM input is also provided to give the user a means to adjust the backlight intensity dynamically based upon the content of the display.

Four integrated LDOs are fully configurable through I²C capable of addressing point-of-load regulation needs for functions such as integrated camera modules. The LDOs can be powered from main battery source, or by a fixed output voltage of an external buck converter (post regulation) leading to higher conversion efficiency.

The LM3538 provides excellent efficiency without the use of an inductor by operating the charge pump in a gain of 3/2 or in Pass-Mode. The proper gain for maintaining current regulation is chosen, based on LED forward voltage, so that efficiency is maximized over the input voltage range.

LM3538 is offered in a tiny 30-bump DSBGA package.



Please be aware that an important notice concerning availability, standard warranty, and use in critical applications of Texas Instruments semiconductor products and disclaimers thereto appears at the end of this data sheet.

All trademarks are the property of their respective owners.

PIN DESCRIPTIONS

Bump	Name	Description
C5	V _{IN_A}	Input voltage for LED driver and sensor interface. Input range: 2.7V to 5.5V.
E5	V _{IN_B}	Input voltage for the regulators. This must be connected to the same voltage supply as V _{IN_A} .
F5	V _{IN_C}	Input voltage (power rail) for the LDO regulators. $1.8V \leq V_{IN_C} \leq V_{IN_A}$
B1	SCL	Serial interface clock
B3	SDA	Serial interface data
A1	HWEN	Hardware enable pin. High = normal operation, low = RESET
B2	PWM	External PWM Input - Allows the current sinks to be turned on and off at a frequency and duty cycle externally controlled. Minimum on-time pulse width = 15µsec.
E4	SBIAS	Power supply for a light sensor. Leave unconnected if not used.
E3	GPO1	General purpose output. Can be used as a sensor gain control signal. When functioning as a general purpose output, it is open drain and requires an external pullup. Leave unconnected if not used.
E2	GPO2	General purpose output. Can be used as a sensor gain control signal. When functioning as a general purpose output, it is open drain and requires an external pullup. Leave unconnected if not used.
D5	ALS	Ambient Light Sensor input. Connect to ground if not used.
F3	GND	Regulator ground
A2	PGND	LED driver and charge pump ground
F2	LDO4	Programmable V _{OUT} of 1.2-3.3 V. Max load = 150mA.
F4	LDO3	Programmable V _{OUT} of 1.2-3.3 V. Max load = 150mA.
E1	LDO2	Programmable V _{OUT} of 1.2-3.3 V. Max load = 150mA.
F1	LDO1	Programmable V _{OUT} of 1.2-3.3 V. Max load = 300mA.
C3	NC	Not Connected, keep floating.
C4	INT	ALS interrupt. A pullup resistor is required. A '0' means a change has occurred, while a '1' means no ALS adjustment has been made.
D4	D6	LED driver
D3	D5	LED driver
D2	D4	LED driver
D1	D3	LED driver
C1	D2	LED driver
C2	D1	LED driver
B5	V _{OUT}	Charge pump output
B4	C2-	Flying capacitor 2 negative terminal
A4	C2+	Flying capacitor 2 positive terminal
A3	C1-	Flying capacitor 1 negative terminal
A5	C1+	Flying capacitor 1 positive terminal



These devices have limited built-in ESD protection. The leads should be shorted together or the device placed in conductive foam during storage or handling to prevent electrostatic damage to the MOS gates.

Absolute Maximum Ratings⁽¹⁾⁽²⁾⁽³⁾

V_{IN_A} , V_{IN_B} , V_{IN_C} pin voltage	-0.3V to 6.0V
Voltage on Logic Pins (SCL, SDA, GPO1, GPO2, HWEN, PWM)	-0.3V to ($V_{IN_A}+0.3V$) with 6.0V max
LED driver (D1 to D6) Pin Voltages	-0.3V to ($V_{OUT}+0.3V$) with 6.0V max
Voltage on All Other Pins	-0.3V to ($V_{IN_A} + 0.3V$) with 6.0V max
Continuous Power Dissipation ⁽⁴⁾	Internally Limited
Junction Temperature (T_{J-MAX})	150°C
Storage Temperature Range	-40°C to +150°C
Maximum Lead Temperature (Soldering)	See ⁽⁵⁾
ESD Rating ⁽⁶⁾	Human Body Model
	2 kV

- (1) Absolute Maximum Ratings indicate limits beyond which damage to the component may occur. Operating Ratings are conditions under which operation of the device is ensured. Operating Ratings do not imply ensured performance limits. For ensured performance limits and associated test conditions, see the Electrical Characteristics tables.
- (2) All voltages are with respect to the potential at the GND pins.
- (3) If Military/Aerospace specified devices are required, please contact the Texas Instruments Sales Office/ Distributors for availability and specifications.
- (4) Internal thermal shutdown circuitry protects the device from permanent damage. Thermal shutdown engages at $T_J = 160^\circ\text{C}$ (typ.) and disengages at $T_J = 155^\circ\text{C}$ (typ.).
- (5) For detailed soldering specifications and information, please refer to Application Note 1112 ([SNVA009](#)): DSBGA Wafer Level Chip Scale Package (AN-1112).
- (6) The human body model is a 100pF capacitor discharged through a 1.5k Ω resistor into each pin. (MIL-STD-883 3015.7)

Operating Rating⁽¹⁾⁽²⁾

V_{IN_A} , V_{IN_B} Input Voltage Range	2.7V to 5.5V
LED Voltage Range	2.0V to 4.0V
V_{IN_C} Input Voltage Range (Note: must stay > $V_{OUTLDO} + 0.3V$)	1.8V to V_{IN_B}
Junction Temperature (T_J) Range	-30°C to +110°C
Ambient Temperature (T_A) Range ⁽³⁾	-30°C to +85°C

- (1) Absolute Maximum Ratings indicate limits beyond which damage to the component may occur. Operating Ratings are conditions under which operation of the device is ensured. Operating Ratings do not imply ensured performance limits. For ensured performance limits and associated test conditions, see the Electrical Characteristics tables.
- (2) If Military/Aerospace specified devices are required, please contact the Texas Instruments Sales Office/ Distributors for availability and specifications.
- (3) In applications where high power dissipation and/or poor package thermal resistance is present, the maximum ambient temperature may have to be derated. Maximum ambient temperature (T_{A-MAX}) is dependent on the maximum operating junction temperature ($T_{J-MAX-OP} = 110^\circ\text{C}$), the maximum power dissipation of the device in the application (P_{D-MAX}), and the junction-to ambient thermal resistance of the part/package in the application (θ_{JA}), as given by the following equation: $T_{A-MAX} = T_{J-MAX-OP} - (\theta_{JA} \times P_{D-MAX})$.

Thermal Properties⁽¹⁾

Junction-to-Ambient Thermal Resistance (θ_{JA}), YFQ0030 Package	45°C/W
---	--------

- (1) Junction-to-ambient thermal resistance is highly dependent on application and board layout. In applications where high maximum power dissipation exists, special care must be paid to thermal dissipation issues in board design. For more information, please refer to Application Note 1112 ([SNVA009](#)): DSBGA Wafer Level Chip Scale Package (AN-1112).

Charge Pump and LED Drivers Electrical Characteristics⁽¹⁾⁽²⁾

Limits in standard typeface are for $T_J = 25^\circ\text{C}$, and limits in **boldface** type apply over the operating ambient temperature range (-30°C to $+85^\circ\text{C}$). Unless otherwise specified: $V_{IN_A} = 3.6\text{V}$; $V_{HWEN} = V_{IN_A}$; $V_{Dx} = 0.4\text{V}$; Group A = Group B = Fullscale Current; $C_1 = C_2 = C_{IN_A} = C_{OUT} = 1.0\mu\text{F}$.⁽³⁾

Symbol	Parameter	Condition	Min	Typ	Max	Units
I_{Dx}	Output Current Regulation GroupA	$2.7\text{V} \leq V_{IN_A} \leq 5.5\text{V}$ 6 LEDs in Group A	-7.5%	25	+7.5%	mA
	Output Current Regulation GroupB	$2.7\text{V} \leq V_{IN_A} \leq 5.5\text{V}$ 2 LEDs in Group B	-7.5%	25	+7.5%	mA
	Output Current Regulation All LED Drivers Enabled All LED Drivers on BankA ⁽⁴⁾	$3.2\text{V} \leq V_{IN_A} \leq 5.5\text{V}$ $V_{LED} = 3.6\text{V}$ BankA current code = 1111101b, exp dimming scale		22.3 DxA		mA
$I_{Dx-MATCH}$	LED Current Matching ⁽⁵⁾	$2.7\text{V} \leq V_{IN} \leq 5.5\text{V}$ LED Current = Fullscale current Group A (6 LEDs)		0.8	3	%
		Group B (2 LEDs)		0.4	3	
V_{DxTH}	V_{Dx} 1x to 3/2x Gain Transition Threshold	V_{Dx} Falling		135		mV
V_{HR}	Current sink Headroom Voltage Requirement ⁽⁶⁾	$I_{Dx} = 95\% \times I_{Dx}(\text{nom.})$ ($I_{Dx}(\text{nom.}) \approx 20\text{mA}$)		100		mV
R_{OUT}	Open-Loop Charge Pump Output Resistance ⁽⁷⁾	Gain = 3/2		2.4		Ω
		Gain = 1		0.5		
I_Q	Quiescent Supply Current	Gain = 1.5x, No Load. Current through V_{IN_A} pin. Sensor Bias OFF		2.9	4.4	mA
		Gain = 1x, No Load. Current through V_{IN_A} pin. Sensor Bias OFF		1.1	2.4	
I_{SB}	Standby Supply Current	$HWEN = 1.8\text{V}$. All registers in factory defaults state. Current through V_{IN_A} pin.		1.2		μA
I_{SD}	Shutdown Supply Current	$HWEN = 0\text{V}$. Current through V_{IN_A} pin.		0.2	1.0	μA
f_{SW}	Switching Frequency		1.1	1.3	1.6	MHz
t_{START}	Start-up Time	See ⁽⁸⁾		250		μs
V_{ALS}	ALS Reference Voltage		-6%	1.0	+6%	V
R_{ALS}	Internal ALS Resistor	R_{ALS} register setting = 00010b	-6%	10.1	+6%	k Ω
		R_{ALS} register setting = 00100b	-6%	5.0	+6%	

- (1) All voltages are with respect to the potential at the GND pins.
- (2) Min and Max limits are specified by design, test, or statistical analysis. Typical numbers are not ensured, but do represent the most likely norm.
- (3) C_{IN_X} , C_{OUT} , C_{LDOX} , C_{SEN} , C_1 , and C_2 : Low-ESR Surface-Mount Ceramic Capacitors (MLCCs) used in setting electrical characteristics.
- (4) The total output current can be split between the two groups ($I_{Dx} = 25\text{mA}$ Max). Under maximum output current conditions, special attention must be given to input voltage and LED forward voltage to ensure proper current regulation. The maximum total output current for the LM3538 should be limited to 150mA.
- (5) For the two groups of current sinks on a part (Group A and Group B), the following are determined: the maximum sink current in the group (MAX), the minimum sink current in the group (MIN), and the average sink current of the group (AVG). For each group, two matching numbers are calculated: $(\text{MAX}-\text{AVG})/\text{AVG}$ and $(\text{AVG}-\text{MIN})/\text{AVG}$. The largest number of the two (worst case) is considered the matching figure for the group. The matching figure for a given part is considered to be the highest matching figure of the two groups. The typical specification provided is the most likely norm of the matching figure for all parts.
- (6) For each Dxpin, headroom voltage is the voltage across the internal current sink connected to that pin. For Group A and B current sinks, $V_{HRx} = V_{OUT} - V_{LED}$. If headroom voltage requirement is not met, LED current regulation will be compromised.
- (7) Specified by design.
- (8) Turn-on time is measured from the moment the charge pump is activated until the V_{OUT} crosses 90% of its target value.

Logic Interface Characteristics⁽¹⁾⁽²⁾

Symbol	Parameter	Condition	Min	Typ	Max	Units
I²C Compatible Interface Timing Specifications (SCL, SDA) ⁽³⁾						
t ₁	SCL (Clock Period)	See ⁽⁴⁾	2.5			μs
t ₂	Data In Setup Time to SCL High		100			ns
t ₃	Data Out stable After SCL Low		0			ns
t ₄	SDA Low Setup Time to SCL Low (Start)		100			ns
t ₅	SDA High Hold Time After SCL High (Stop)		100			ns
I²C-Compatible Interface Voltage Specifications (SCL, SDA)						
V _{IL}	Input Logic Low "0"	2.7V ≤ V _{IN_A} ≤ 5.5V	0		0.45	V
V _{IH}	Input Logic High "1"	2.7V ≤ V _{IN_A} ≤ 5.5V	1.25		V _{IN_A}	V
V _{OL}	Output Logic Low "0"	I _{LOAD} = 3mA			400	mV
Logic inputs HWEN and PWM						
V _{HWEN}	HWEN Voltage Thresholds	2.7V ≤ V _{IN_A} ≤ 5.5V	Reset	0	0.45	V
			Normal Operation	1.2	V _{IN_A}	
V _{PWM}	PWM Voltage Thresholds	2.7V ≤ V _{IN_A} ≤ 5.5V	LEDs Off	0	0.45	V
			LEDs On	1.2	V _{IN_A}	
ALS Interrupt						
V _{OL-INT}	Interrupt Output Logic Low '0'	I _{LOAD} = 3mA			400	mV
Logic outputs GPO1, GPO2 ⁽⁵⁾						
V _{OL}	Output Low Level	I _{OUT} = 3mA		0.3	0.5	V
V _{OH}	Output High Level	I _{OUT} = -2mA	V _{OUT_S} -0.5	V _{OUT_S} -0.3		V

(1) All voltages are with respect to the potential at the GND pins.

(2) Min and Max limits are specified by design, test, or statistical analysis. Typical numbers are not ensured, but do represent the most likely norm.

(3) SCL and SDA should be glitch-free in order for proper device control to be realized. See [Timing Parameters](#) for timing specification details.

(4) SCL is tested with a 50% duty-cycle clock.

(5) V_{OUT_S} = SBIAS pin output voltage. The voltage level of the GPOs depends on the sbias_en-bit: '1'; GPOs will behave as push-pull outputs and will reference the high-side to the voltage of SBIAS. '0'; GPOs will act as open-drain outputs (default). In the open-drain configuration, they can be high-side referenced to any voltage equal or less than the V_{IN_A} of the LM3538. Output High Level (V_{OH}) specification is valid only for push-pull -type outputs.

Voltage Regulators Electrical Characteristics⁽¹⁾⁽²⁾

Unless otherwise noted, $V_{IN_A} = V_{IN_B} = V_{IN_C} = 3.6V$, $C_{IN_A} = 1 \mu F$, $C_{IN_B} = 100 \text{ nF}$, $C_{IN_C} = 2.2 \mu F$, $C_{LDOX} = 1 \mu F$, HWEN = high. Limits in standard typeface are for $T_J = 25^\circ C$, and limits in **boldface** type apply over the operating ambient temperature range ($-30^\circ C$ to $+85^\circ C$).⁽³⁾

Symbol	Parameter	Condition	Min	Typ	Max	Units	
LDO1							
V_{OUT}	Output Voltage Accuracy	$I_{OUTLDO} = 1 \text{ mA}$, $V_{OUTLDO} = 2.80V$	-2		+2	%	
			-3		+3		
	Default Output Voltage			2.80		V	
I_{OUT}	Output Current	$1.8V \leq V_{IN_C} \leq 5.5V$			300	mA	
	Output Current Limit (short circuit)	$V_{OUTLDO} = 0V$		600			
V_{DO}	Dropout Voltage	$I_{OUTLDO} = 300 \text{ mA}$		220	300	mV	
ΔV_{OUT}	Line Regulation	$V_{OUTLDO} + 0.5V \leq V_{IN_C} \leq 4.5V$ $I_{OUTLDO} = 1 \text{ mA}$		2		mV	
	Load Regulation	$1 \text{ mA} \leq I_{OUTLDO} \leq 300 \text{ mA}$		20			
PSRR	Power Supply Ripple Rejection Ratio	$f = 100 \text{ Hz}$, $C_{LDO1} = 1 \mu F$, $I_{OUTLDO} = 20 \text{ mA}$ Output Voltage = 1.20V		65		dB	
LDO2, LDO3, LDO4							
V_{OUT}	Output Voltage Accuracy	$I_{OUTLDO} = 1 \text{ mA}$, $V_{OUTLDO} = 2.80V$	-2		+2	%	
			-3		+3		
	Default Output Voltage	LDO2			1.80		V
		LDO3			1.80		V
LDO4				2.80			
I_{OUT}	Output Current	$1.8V \leq V_{IN_C} \leq 5.5V$			150	mA	
	Output Current Limit (short circuit)	$V_{OUTLDO} = 0V$		400			
V_{DO}	Dropout Voltage	$I_{OUTLDO} = 150 \text{ mA}$		100	200	mV	
ΔV_{OUT}	Line Regulation	$V_{OUTLDO} + 0.5V \leq V_{IN_C} \leq 4.5V$ $I_{OUTLDO} = 1 \text{ mA}$		2		mV	
	Load Regulation	$1 \text{ mA} \leq I_{OUTLDO} \leq 150 \text{ mA}$		10			
PSRR	Power Supply Ripple Rejection Ratio	$f = 100 \text{ Hz}$, $C_{LDOX} = 1 \mu F$, $I_{OUTLDO} = 20 \text{ mA}$ Output Voltage = 1.20V		65		dB	
LDO Combined Common Electrical Characteristics							
I_{GND}	Ground Pin Current (GND and PGND-pin)	Note: $I_{OUTLDOX} = 0 \text{ mA}$	All LDOs Disabled		0.2	1	μA
			One LDO Enabled		70	130	
			Two LDOs Enabled		100		
			Three LDOs Enabled		130		
			Four LDOs Enabled		160		
$t_{START-UP}$	Turn-on Time from Shut-down ⁽⁴⁾	$C_{LDOX} = 1 \mu F$, $I_{OUTLDO} = 150 \text{ mA}$ $V_{OUT} = 2.8V$. Enable of First LDO		130		μs	
		$C_{LDOX} = 1 \mu F$, $I_{OUTLDO} = 150 \text{ mA}$ $V_{OUT} = 2.8V$. Enable of Each Subsequent LDO after First Enabled		70			
$T_{Transient}$	Start-Up Transient Overshoot	$C_{LDOX} = 1 \mu F$, $I_{OUTLDO} = 150 \text{ mA}$			30	mV	

(1) All voltages are with respect to the potential at the GND pins.

(2) Min and Max limits are specified by design, test, or statistical analysis. Typical numbers are not ensured, but do represent the most likely norm.

(3) C_{IN_C} , C_{LDOX} : Low-ESR Surface-Mount Ceramic Capacitors (MLCCs) used in setting electrical characteristics.

(4) Time needed for V_{OUTLDO} to reach 95% of final value.

Sensor Interface Electrical Characteristics

Unless otherwise noted, $V_{IN_A} = 3.6V$, $C_{IN_A} = 1 \mu F$, $C_{IN_B} = 100 \text{ nF}$, $C_{IN_C} = 2.2 \mu F$, $C_{SEN} = 1 \mu F$, $HWEN = \text{high}$. Limits in standard typeface are for $T_J = 25^\circ C$, and limits in **boldface** type apply over the operating ambient temperature range ($-30^\circ C$ to $+85^\circ C$).

Symbol	Parameter	Condition	Min	Typ	Max	Units
SBIAS						
I_{OUT_S}	SBIAS Output Current	$2.7V \leq V_{IN_A} \leq 5.5V$. $V_{OUT_S} < (V_{IN_A} + 0.3V)$			20	mA
V_{OUT_S}	SBIAS Output Voltage	$2.7V \leq V_{IN_A} \leq 5.5V$. $I_{OUT_S} = 1.0mA$. 2.4V option selected via register.	-5%	2.4	+5%	V
		$3.3V \leq V_{IN_A} \leq 5.5V$. $I_{OUT_S} = 1.0mA$. 3.0V option selected via register.	-5%	3.0	+5%	
I_{QIF}	Sensor Interface Quiescent Supply Current ⁽¹⁾⁽²⁾	No Load		35		μA

- (1) In addition to Quiescent Supply Current (I_Q) drawn by the charge pump (See Table Charge Pump and LED Drivers Electrical Characteristics).
 (2) Specified by design.

Timing Parameters

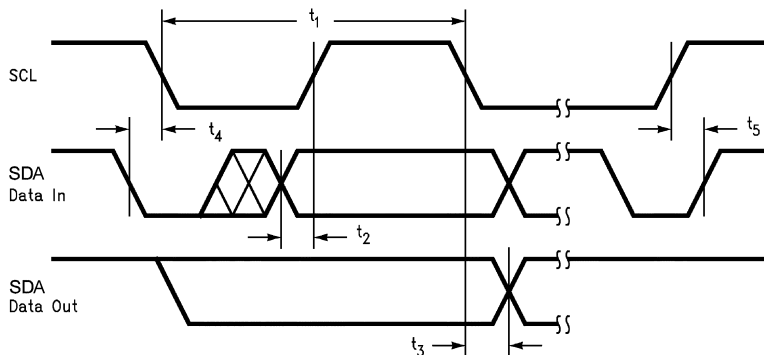

Typical Performance Characteristics

Unless otherwise specified: $V_{IN,A,B,C} = 3.6V$, $C_{IN,A} = C_{OUT} = 1.0\mu F$, $C_{IN,B} = 0.1\mu F$, $C_{IN,C} = 4.7\mu F$, $C_1 = C_2 = 1.0\mu F$, $C_{LDOX} = 1.0\mu F$, $T_A = 25^\circ C$.

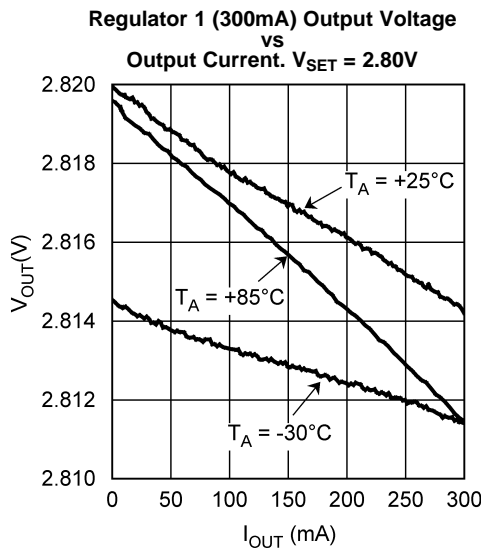

Figure 2.

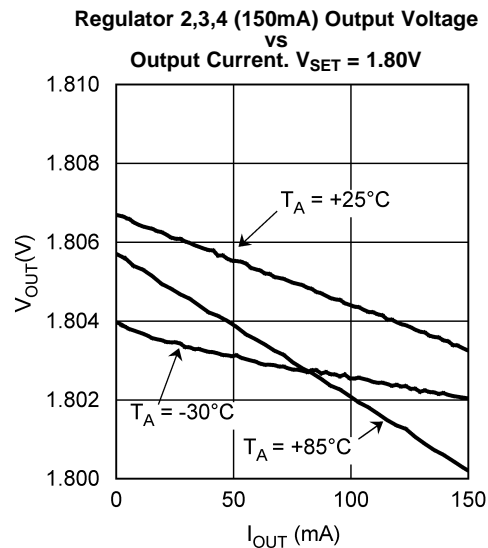

Figure 3.

Power Supply Rejection Ratio, $V_{OUT} = 1.20V$, $I_{LOAD} = 20mA$. $V_{IN,C}$ is shorted to $V_{IN,A}$, $V_{IN,B}$.

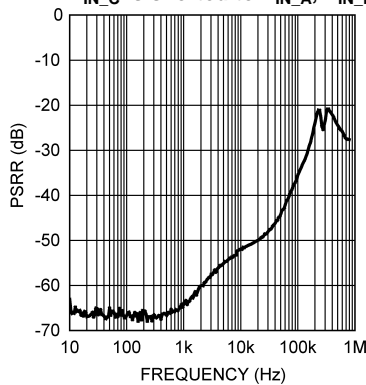

Figure 4.

Power Supply Rejection Ratio, $V_{OUT} = 1.20V$, $I_{LOAD} = 20mA$. Signal Applied on $V_{IN,C}$. $V_{IN,A}$ and $V_{IN,B}$ Clear.

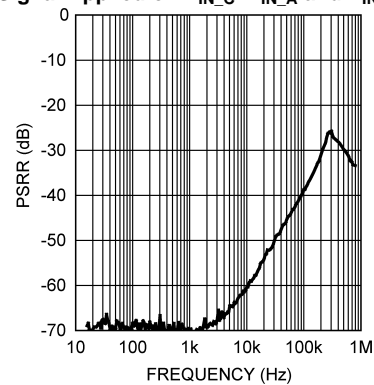

Figure 5.

Load Transient. V_{OUT} setting = 1.80V, I_{LOAD} 1mA to 150mA to 1mA; $t_{RISE} = t_{FALL} = 5\mu s$.

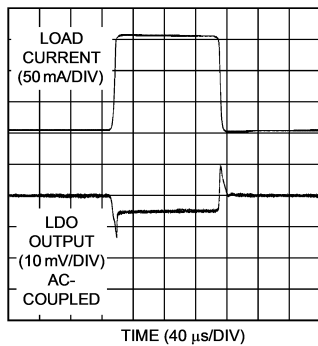

Figure 6.

Line Transient Response. V_{OUT} setting = 1.80V, I_{LOAD} 1mA.

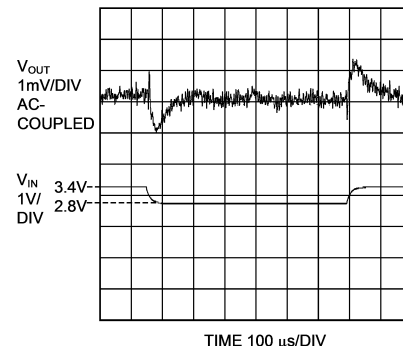
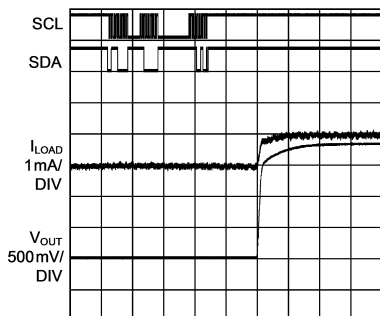

Figure 7.

Typical Performance Characteristics (continued)

Unless otherwise specified: $V_{IN_A,B,C} = 3.6V$, $C_{IN_A} = C_{OUT} = 1.0\mu F$, $C_{IN_B} = 0.1\mu F$, $C_{IN_C} = 4.7\mu F$, $C_1 = C_2 = 1.0\mu F$, $C_{LDOx} = 1.0\mu F$, $T_A = 25^\circ C$.

Regulator Enable Response; Enable of First Regulator (1mA load, 1.80V) via Reg. Write.



TIME 40 $\mu s/DIV$
Figure 8.

Regulator Enable Response; Enable of First Regulator (150mA load, 2.80V) via Reg. Write.

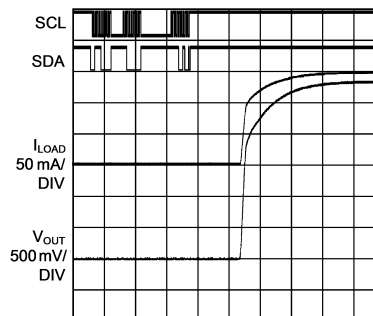

TIME 40 $\mu s/DIV$
Figure 9.

Regulator 2,3,4 Short Circuit Current V_{OUT} setting = 1.80V

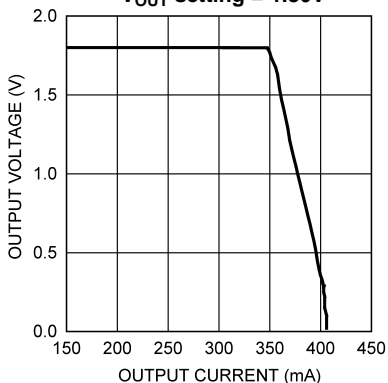

Figure 10.

Regulator 1 Short Circuit Current V_{OUT} setting = 2.80V

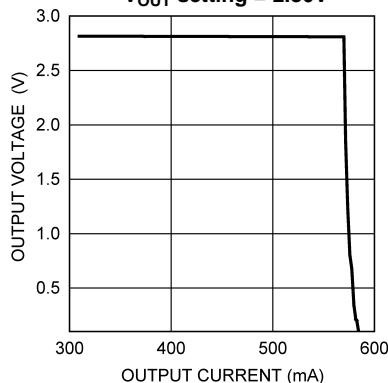

Figure 11.

Shutdown Supply Current $HWEN = 0V$. Current through V_{IN_A} pin.

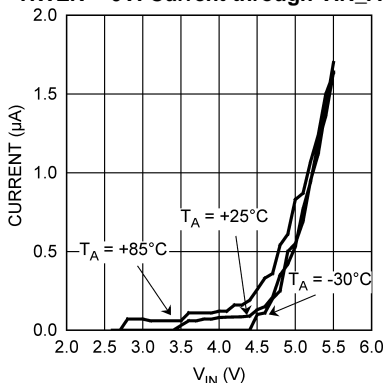

Figure 12.

Standby Supply Current $HWEN = 1.8V$. Current through V_{IN_A} pin.

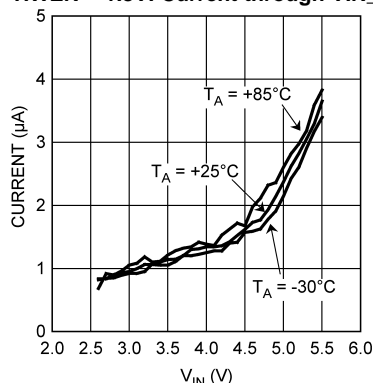

Figure 13.

Typical Performance Characteristics (continued)

Unless otherwise specified: $V_{IN,A,B,C} = 3.6V$, $C_{IN,A} = C_{OUT} = 1.0\mu F$, $C_{IN,B} = 0.1\mu F$, $C_{IN,C} = 4.7\mu F$, $C_1 = C_2 = 1.0\mu F$, $C_{LDOx} = 1.0\mu F$, $T_A = 25^\circ C$.

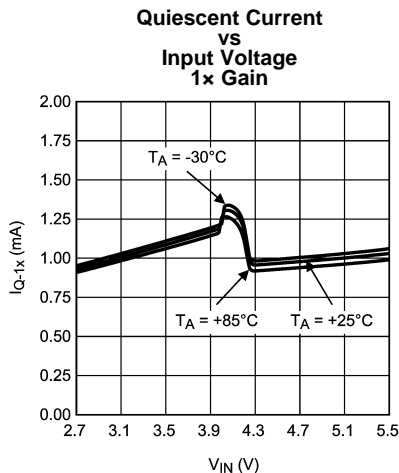

Figure 14.

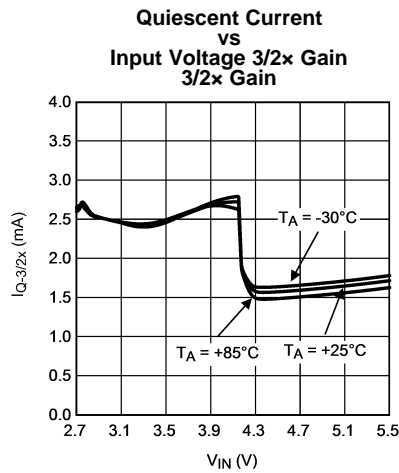

Figure 15.

LED Current Matching Distribution. 6 Drivers on Group A, Output Set to 25 mA. (1)

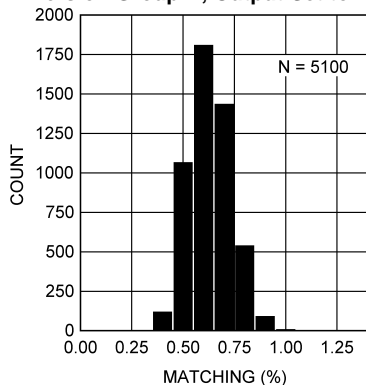

Figure 16.

Charge Pump 1.5x Efficiency vs Load Current

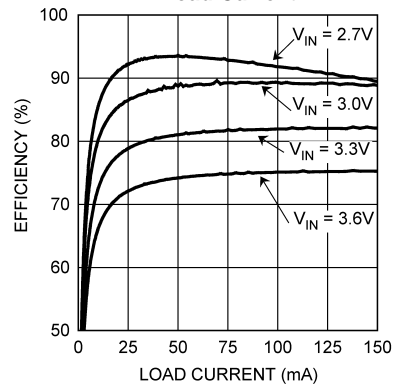
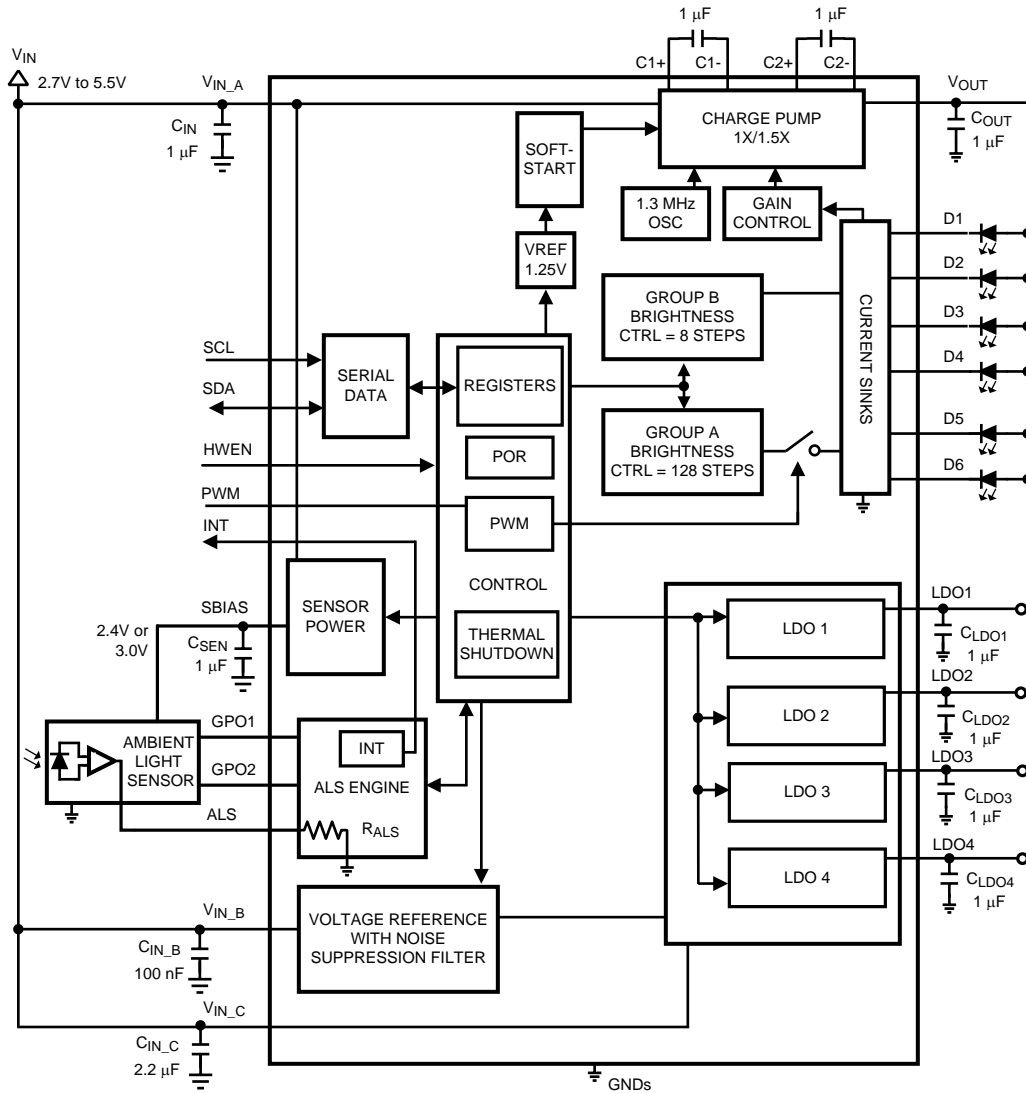

Figure 17.

(1) For the two groups of current sinks on a part (Group A and Group B), the following are determined: the maximum sink current in the group (MAX), the minimum sink current in the group (MIN), and the average sink current of the group (AVG). For each group, two matching numbers are calculated: $(MAX-AVG)/AVG$ and $(AVG-MIN)/AVG$. The largest number of the two (worst case) is considered the matching figure for the group. The matching figure for a given part is considered to be the highest matching figure of the two groups. The typical specification provided is the most likely norm of the matching figure for all parts.

Block Diagram



CIRCUIT DESCRIPTION

OVERVIEW

The LM3538 is a white LED driver system based upon an adaptive 3/2x - 1x CMOS charge pump capable of supplying up to 150mA of total output current. With two separately controlled groups of constant current sinks, the LM3538 is an ideal solution for platforms requiring a single white LED driver for main display and sub display (or keypad). The tightly matched current sinks ensure uniform brightness from the LEDs across the entire small-format display.

Each LED is configured in a common anode configuration, with the peak drive current set to 25mA. An I²C-compatible interface is used to enable the device and vary the brightness within the individual current sink groups. For Group A, 128 brightness control levels are available (user defined linear or exponential dimming curve). Group B has 8 linearly-spaced analog brightness levels.

The LM3538 provides an input for an Ambient Light Sensor to adaptively adjust the diode current based on ambient conditions, and a PWM pin to allow the diode current to be pulse width modulated to work with a display driver utilizing dynamic or content adjusted backlight control (DBC or CABC). Additionally, the device provides 20mA power supply output for the sensor. The GPOs can also be configured to serve as a gain control interface for sensors with HW controlled gain.

The LM3538 also integrates three 150-mA LDOs and one 300-mA LDO voltage regulator which can be turned on/off using separate enable bits on each LDO. Each LDO operates with a power rail input voltage range between 1.8V and 5.5V allowing them to be supplied from the battery or a step-down converter. Furthermore, the regulated output voltages can be adjusted through the serial bus.

CIRCUIT COMPONENTS

Charge Pump

The input to the 3/2x - 1x charge pump is connected to the V_{IN_A} pin, and the regulated output of the charge pump is connected to the V_{OUT} pin. The operating input voltage range of the LM3538 is 2.7V to 5.5V. The device's regulated charge pump has both open loop and closed loop modes of operation. When the device is in open loop, the voltage at V_{OUT} is equal to the gain times the voltage at the input. When the device is in closed loop, the voltage at V_{OUT} is regulated to 4.2V (typ.). The charge pump gain transitions are actively selected to maintain regulation based on LED forward voltage and load requirements.

Diode Current Sinks

The matched current outputs are generated with a precision current mirror that is biased off the charge pump output. Matched currents are ensured with the use of tightly matched internal devices and internal mismatch cancellation circuitry. There are six regulated current sinks configurable into two different lighting regions.

Ambient Light Sensing (ALS) and Interrupt

The LM3538 provides an Ambient Light Sensing input for use with ambient backlight control. Connecting the anode of a photo diode to this pin and configuring the appropriate ALS resistor, the LM3538 can be configured to adjust the LED current to five unique settings corresponding to four adjustable light region trip points. Additionally, when the LM3538 determines that an ambient condition has changed, the interrupt pin, when connected to a pullup resistor, will toggle to a '0' alerting the controller. Available resistor values are shown in [Table 1](#) below.

Table 1. ALS Resistor Values

r_als[4]	r_als[3]	r_als[2]	r_als[1]	r_als[0]	R _{ALS} (typ) Value	Unit
1	1	1	1	1	0.651	kΩ
1	1	1	1	0	0.672	kΩ
1	1	1	0	1	0.695	kΩ
1	1	1	0	0	0.720	kΩ
1	1	0	1	1	0.747	kΩ
1	1	0	1	0	0.776	kΩ

Table 1. ALS Resistor Values (continued)

r_als[4]	r_als[3]	r_als[2]	r_als[1]	r_als[0]	R _{ALS} (typ) Value	Unit
1	1	0	0	1	0.806	kΩ
1	1	0	0	0	0.840	kΩ
1	0	1	1	1	0.876	kΩ
1	0	1	1	0	0.916	kΩ
1	0	1	0	1	0.960	kΩ
1	0	1	0	0	1.01	kΩ
1	0	0	1	1	1.06	kΩ
1	0	0	1	0	1.12	kΩ
1	0	0	0	1	1.19	kΩ
1	0	0	0	0	1.26	kΩ
0	1	1	1	1	1.34	kΩ
0	1	1	1	0	1.44	kΩ
0	1	1	0	1	1.55	kΩ
0	1	1	0	0	1.68	kΩ
0	1	0	1	1	1.83	kΩ
0	1	0	1	0	2.02	kΩ
0	1	0	0	1	2.24	kΩ
0	1	0	0	0	2.52	kΩ
0	0	1	1	1	2.88	kΩ
0	0	1	1	0	3.36	kΩ
0	0	1	0	1	4.03	kΩ
0	0	1	0	0	5.00	kΩ
0	0	0	1	1	6.72	kΩ
0	0	0	1	0	10.1	kΩ
0	0	0	0	1	20.2	kΩ
0	0	0	0	0	HighZ	--

Automatic Gain Change

GPO pins of the LM3538 can be configured to serve as a gain control interface for sensors with HW controlled gain, like ROHM BH1600-series. Please see [Table 2](#). LM3538 changes sensor gain automatically based on ambient light intensity changes.

Table 2. Sensor Gain Control

REGISTER SETTING	OUTPUT PIN STATUS	
	GPO1	GPO2
autogain_en = "0"	Can be set to "1" or "0" with REG 52H, bit gpo1	Can be set to "1" or "0" with REG 52H, bit gpo2
autogain_en = "1" (enables autogain functionality) LOW GAIN	0	1
autogain_en = "1" (enables autogain functionality) HIGH GAIN	1	0

The ambient light sensing circuit has 4 configurable Ambient Light Boundaries (ZB0 – ZB3) programmed through the four (8-bit) Zone Boundary Registers. These zone boundaries **define 5 ambient brightness zones**.

The ambient light sensor input has a 0 to 1V operational input voltage range. The Typical Application Circuit shows the LM3538 with an ambient light sensor (ROHM, BH1621FVC). If the internal ALS Resistor Select Register is set to 0x14 (1.44kΩ), this circuit will convert 0 to 1000 LUX light into approximately a 0 to 850mV linear output voltage (High-gain mode). The voltage at the active ambient light sensor input is compared against the 8 bit values programmed into the Zone Boundary Registers (ALS ZONE BOUNDARY#0 - ALS ZONE BOUNDARY#3). When the ambient light sensor output crosses one of the programmed thresholds the internal ALS circuitry will smoothly transition the LED current to the new 7-bit brightness level as programmed into the appropriate Zone Target Register (ALS BRIGHTNESS ZONE#0 to ALS BRIGHTNESS ZONE#4).

Ambient light sensor samples are averaged and then further processed by the discriminator block to provide rejection of noise and transient signals. The averager is configurable with 8 different averaging times to provide varying amounts of noise and transient rejection. The discriminator block algorithm has a maximum latency of two averaging cycles; therefore, the averaging time selection determines the amount of delay that will exist between a steady-state change in the ambient light conditions and the associated change of the backlight illumination. For example, the A/D converter samples the ALS inputs at 16kHz. If the averaging time is set to 800ms, the averager will send the updated zone information to the discriminator every 800ms. This zone information contains the average of approximately 12800 samples (800ms x 16kHz). Due to the latency of 2 averaging cycles, when there is a steady state change in the ambient light, the LED current will begin to transition to the appropriate target value after approximately 1600ms have elapsed.

ALS Zone to LED Brightness Mapping principle without AutoGain is shown in Figure 18 below. Here, the exponential dimming scheme is used.

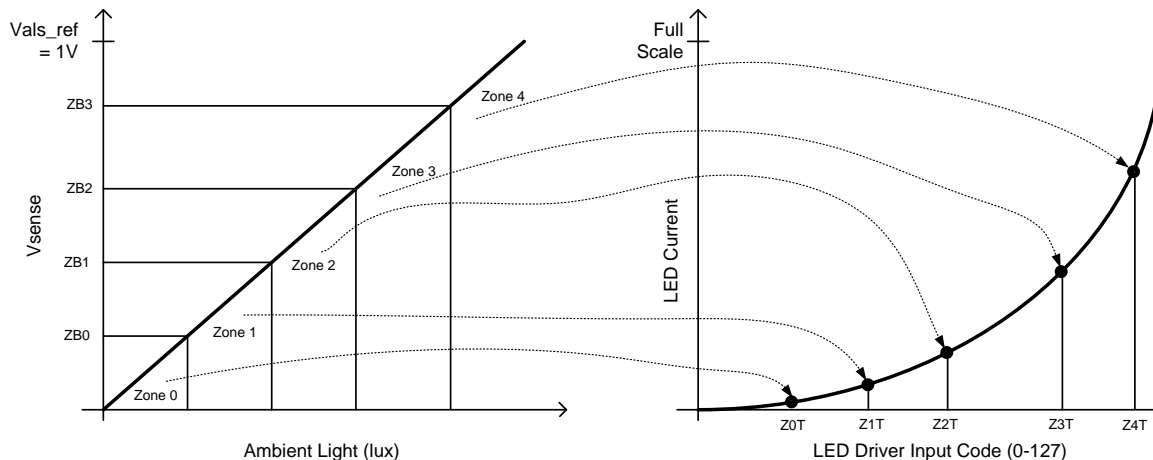
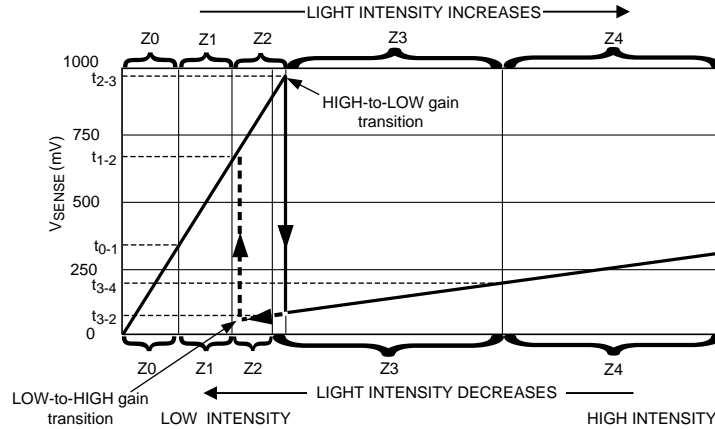

Figure 18. ALS Zone to LED Brightness Mapping

ALS Zone transitions with AutoGain is shown in Figure 19. When the light intensity increases, the LM3538 configures the sensor for low-gain mode. Transition from Zone2 to Zone3 triggers the shift to lower gain mode. When the light intensity decreases, the LM3538 configures the sensor to high-gain mode. The trip point to this transition is set by the ALS LOW_to_HIGH_TP register, and it should be set lower than the Zone2 to Zone3 transition, in order to have hysteresis. Zone3 to Zone2 transition trip point must be set separately for lower gain mode, by the ALS ZONE BOUNDARY Z3_to_Z2 register. This register value should be set higher than the ALS LOW_to_HIGH_TP. In low-gain mode the sensor will have a lower output current which helps save battery power. High-gain mode will allow better resolution, but will result in higher output current. Thus, there is a tradeoff between increased resolution and increased power consumption. High-gain mode is the default mode of operation after enabling the autogain.



- (1) The higher X-axis is for increasing light intensity, while the lower axis is for decreasing light intensity.
- A. There are some limits in Zone transitions when the autogain is enabled; for example, a direct transition from the lowest Zone0 to the highest Zone4 (and vice versa) is not possible, because the device must go through the gain change process first.

Figure 19. ALS Zone transitions with AutoGain.

Countdown Timer

The ALS engine includes a pre-defined countdown timer function. This function is targeted to applications where it's favorable to only increase through the zones; i.e., the LM3538 will stick to the highest zone reached, but won't allow transitions to lower Zones until the countdown has completed. At the end of every countdown, the timer sets the countdown timerflag (reg 40H), and after that, any Zone transition to a lower Zone re-loads the timer and starts the next timer period. See Table 3 and Figure 20 for details.

Table 3. Countdown Timer

Pre-defined Countdown Timer Function		
TIMER[1]	TIMER[0]	Timer Function
0	0	Countdown timer is disabled
0	1	10s countdown timer is enabled (stick to the highest zone for 10s).
1	0	Always stick to the highest zone the ALS reached.
1	1	Always stick to the highest zone the ALS reached.

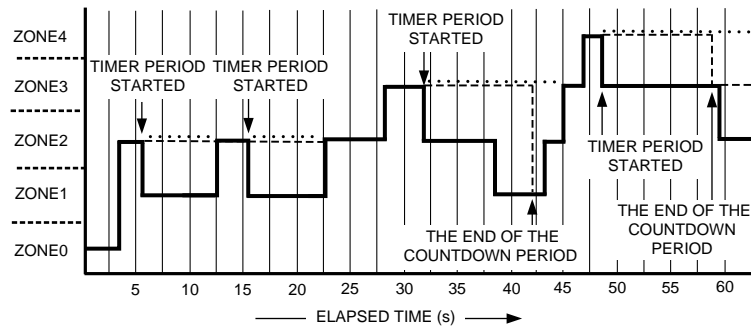

Solid line shows the ALS operation when the timer is disabled. Dashed line shows the operation when the 10s timer is enabled. Dotted line shows the operation when the device sticks to the highest zone.

Figure 20. Countdown Timer Principle.

PWM Input

A PWM (Pulse Width Modulation) pin is provided on the LM3538 to allow a display driver utilizing dynamic backlight control (DBC) to adjust the LED brightness based on the content. The PWM input can be turned on or off (Acknowledge or Ignore), and the polarity can be flipped (active high or active low) through the I²C interface. The current sinks of the LM3538 require approximately 15μs to reach steady-state target current. This turn-on time sets the minimum usable PWM pulse width for DBC. The external PWM input is effective for Group A LEDs only.

LED Forward Voltage Monitoring

The LM3538 has the ability to switch gains (1x or 3/2x) based on the forward voltage of the LED load. This ability to switch gains maximizes efficiency for a given load. Forward voltage monitoring occurs on all diode pins. At higher input voltages, the LM3538 will operate in pass mode, allowing the V_{OUT} voltage to track the input voltage. As the input voltage drops, the voltage on the Dx pins will also drop ($V_{DX} = V_{VOUT} - V_{LEDX}$). Once any of the active Dx pins reaches a voltage approximately equal to 150mV, the charge pump will switch to the gain of 3/2. This switch-over ensures that the current through the LEDs never becomes pinched off due to a lack of headroom across the current sinks. **Once a gain transition occurs, the LM3538 will remain in the gain of 3/2 until an I²C write to the part occurs. At that time, the LM3538 will re-evaluate the LED conditions and select the appropriate gain.**

Only active Dx pins will be monitored.

Configurable Gain Transition Delay

To optimize efficiency, the LM3538 has a user-selectable gain transition delay that allows the part to ignore short duration input voltage drops. By default, the LM3538 will not change gains if the input voltage dip is shorter than 3 to 6 milliseconds. There are four selectable gain transition delay ranges available on the LM3538.

Hardware Enable (HWEN)

The LM3538 has a hardware enable/reset pin (HWEN) that allows the device to be disabled by an external controller without requiring an I²C write command. Under normal operation, the HWEN pin should be held high (logic '1') to prevent an unwanted reset. When the HWEN is driven low (logic '0'), all internal control registers reset to the default states and the part becomes disabled. Please see the [Charge Pump and LED Drivers Electrical Characteristics](#)⁽¹⁾⁽²⁾ section of the datasheet for required voltage thresholds.

Low Dropout Voltage Regulators

The four low dropout voltage regulators are designed to operate with small-size ceramic input and output capacitors. They can operate with power rail voltages down to 1.8V. The LDOs 2, 3 and 4 offer a typical dropout voltage of 100 mV at 150mA output current. The single, higher-current LDO 1 offers a typical dropout voltage of 220mV at 300mA output current. The LDOs are enabled by the EN_LDO1, EN_LDO2, EN_LDO3 and EN_LDO4 bits (see [Table 5](#) for details). [Table 4](#) summarizes the supported output voltages. At startup, the LDOs are off but are preset to 1.8V (for LDO2 and LDO3) and 2.8V (for LDO1 and LDO4).

Table 4. Regulator Voltage Options

LDOX_VOUT[4]	LDOX_VOUT[3]	LDOX_VOUT[2]	LDOX_VOUT[1]	LDOX_VOUT[0]	Output Voltage (typ.)
1	1	1	1	1	3.30V
1	1	1	1	0	3.20V
1	1	1	0	1	3.10V
1	1	1	0	0	3.00V
1	1	0	1	1	2.95V
1	1	0	1	0	2.90V
1	1	0	0	1	2.85V
1	1	0	0	0	2.80V

(1) All voltages are with respect to the potential at the GND pins.

(2) Min and Max limits are specified by design, test, or statistical analysis. Typical numbers are not ensured, but do represent the most likely norm.

Table 4. Regulator Voltage Options (continued)

LDOX_VOUT[4]	LDOX_VOUT[3]	LDOX_VOUT[2]	LDOX_VOUT[1]	LDOX_VOUT[0]	Output Voltage (typ.)
1	0	1	1	1	2.75V
1	0	1	1	0	2.70V
1	0	1	0	1	2.65V
1	0	1	0	0	2.60V
1	0	0	1	1	2.55V
1	0	0	1	0	2.50V
1	0	0	0	1	2.40V
1	0	0	0	0	2.20V
0	1	1	1	1	2.00V
0	1	1	1	0	1.90V
0	1	1	0	1	1.85V
0	1	1	0	0	1.80V
0	1	0	1	1	1.75V
0	1	0	1	0	1.70V
0	1	0	0	1	1.65V
0	1	0	0	0	1.60V
0	0	1	1	1	1.55V
0	0	1	1	0	1.50V
0	0	1	0	1	1.45V
0	0	1	0	0	1.40V
0	0	0	1	1	1.35V
0	0	0	1	0	1.30V
0	0	0	0	1	1.25V
0	0	0	0	0	1.20V

The power input voltage applied between V_{IN_C} and GND should be at least 0.3V above the output voltage of the regulators. The bias input voltage applied between V_{IN_B} and GND should be equal to V_{IN_A} , and at least 0.3V above the output voltage of the regulators.

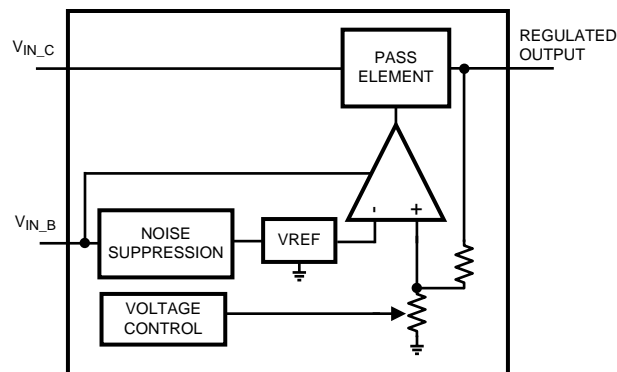

- (1) V_{IN_B} supplies internal circuitry.
- (2) V_{IN_C} , the power input voltage, is regulated to the fixed output voltage.

Figure 21. LDO Block Diagram.

I²C-COMPATIBLE INTERFACE

The LM3538 is controlled via an I²C compatible interface. START and STOP (Figure 22) conditions classify the beginning and the end of the I²C session. A START condition is defined as SDA transitioning from HIGH to LOW while SCL is HIGH. A STOP condition is defined as SDA transitioning from LOW to HIGH while SCL is HIGH. The I²C master always generates START and STOP conditions. The I²C bus is considered busy after a START condition and free after a STOP condition. During data transmission, the I²C master can generate repeated START conditions. A START and a repeated START conditions are equivalent function-wise. The data on SDA must be stable during the HIGH period of the clock signal (SCL). In other words, the state of SDA can only be changed when SCL is LOW.

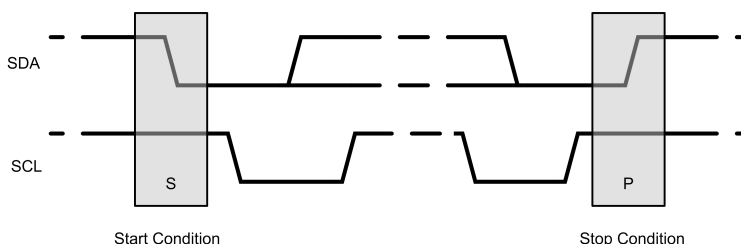

Figure 22. Start and Stop Sequences

I²C-COMPATIBLE CHIP ADDRESS

The chip address for the LM3538 is 0111000 (38h). After the START condition, the I²C master sends the 7-bit chip address followed by a read or write bit (R/W). R/W= 0 indicates a WRITE and R/W = 1 indicates a READ. The second byte following the chip address selects the register address to which the data will be written. The third byte contains the data for the selected register.

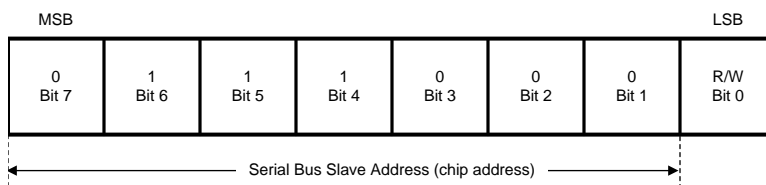

Figure 23. Chip Address

TRANSFERRING DATA

Every byte on the SDA line must be eight bits long, with the most significant bit (MSB) transferred first. Each byte of data must be followed by an acknowledge bit (ACK). The acknowledge related clock pulse (9th clock pulse) is generated by the master. The master releases SDA (HIGH) during the 9th clock pulse. The LM3538 pulls down SDA during the 9th clock pulse, signifying an acknowledge. An acknowledge is generated after each byte has been received. Figure 24 is an example of a write sequence to the DIODE ENABLE register of the LM3538.

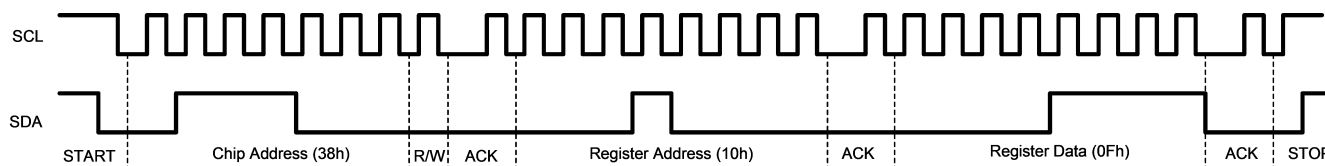

Figure 24. Write Sequence to the LM3538

INTERNAL REGISTERS OF LM3538

The LM3538 is controlled by a set of registers through the two-wire serial interface port. Table [Table 5](#) below lists device registers and their addresses together with a short description.

Table 5. Control Register Map

Hex Addr.	Register Name	Bit(s)	Read/W rite	Default Value After Reset	Bit Mnemonic and Description
00	MASTER ENABLE	[2]	R/W	xxxxx0xx	Group_A_en Master enable for all the LEDs, which are assigned to group A. '1' = LEDs ON '0' = LEDs OFF.
		[1]	R/W	xxxxx0x	Group_B_en Master enable for all the LEDs, which are assigned to group B. '1' = LEDs ON '0' = LEDs OFF.
		[0]	W	xxxxxx0	softw_rst Writing = '1' to this register bit resets all the registers to factory defaults. After writing, this bit is forced back to '0' automatically.
10	DIODE ENABLE	[5]	R/W	xx0xxxxx	enD6 ON/OFF Control for D6 output
		[4]	R/W	xxx0xxxx	enD5 ON/OFF Control for D5 output
		[3]	R/W	xxx0xxx	enD4 ON/OFF Control for D4 output
		[2]	R/W	xxxxx0xx	enD3 ON/OFF Control for D3 output
		[1]	R/W	xxxxxx0x	enD2 ON/OFF Control for D2 output
		[0]	R/W	xxxxxx0	enD1 ON/OFF Control for D1 output
20	CONFIGURATION	[7]	R/W	0xxxxxxx	int Enables the Interrupt Pin. 1 = interrupt output enabled. 0 = interrupt output disabled. Reading the 0x40 register clears the interrupt.
		[6]	R/W	x0xxxxxx	lin Selects between linear and exponential dimming curve. Effective for Group A only. 1 = linear dimming curve. 0 = exponential dimming curve.
		[3]	R/W	xxx1xxx	D6_A Assign D6 diode to Group A Writing a '1' assigns D6 to BankA (default) and a '0' assigns D6 to Group B.
		[2]	R/W	xxxx1xx	D5_A Assign D5 diode to Group A . Writing a '1' assigns D5 to BankA (default) and a '0' assigns D5 to Group B.
		[1]	R/W	xxxxxx0x	pwm_p PWM input polarity. Writing a '0' = active high (default) and a '1' = active low.
		[0]	R/W	xxxxxx0	pwm_en PWM input enable. Writing a '1' = Enable, and a '0' = Ignore (default).
30	OPTIONS	[7:6]	R/W	00xxxxxx	gt Charge pump gain transition filter. The value stored in this register determines the filter time used to make a gain transition in the event of an input line $V_{IN,A}$ step. Filter Times (typ.) = '00' = 3-6ms, '01' = 0.8-1.5ms, '10' = 20 μ s, '11' = 1 μ s,
		[5:3]	R/W	xx000xxx	rd Diode current ramp down step time: '000' = 6 μ s, '001' = 0.77ms, '010' = 1.5ms, '011' = 3ms, '100' = 6ms, '101' = 12ms, '110' = 25ms, '111' = 50ms
		[2:0]	R/W	xxxxx000	ru Diode current ramp up step time : '000' = 6 μ s, '001' = 0.77ms, '010' = 1.5ms, '011' = 3ms, '100' = 6ms, '101' = 12ms, '110' = 25ms, '111' = 50ms

Table 5. Control Register Map (continued)

Hex Addr.	Register Name	Bit(s)	Read/W rite	Default Value After Reset	Bit Mnemonic and Description
40	ALS ZONE READBACK	[7:6]	R	00xxxxxx	rev Stores the silicon revision value. LM3538 = '00'
		[5]	R	xx0xxxxx	als_gain Gain_status indicator: '1' = high gain, '0' = low gain.
		[4]	R	xxx0xxxx	timerflag At the end of every countdown, the timer sets the timerflag = '1'. The flag bit is cleared once the 0x40 register has been read.
		[3]	R	xxxx0xxx	zoneflag ALS transition flag. '1' = Transition has occurred. '0' = No transition. The flag bit is cleared once the 0x40 register has been read.
		[2:0]	R	xxxxx000	zone ALS Zone information: '000' = Zone0, '001' = Zone1, '010' = Zone2, '011' = Zone3, '100' = Zone4. Other combinations not used.
50	ALS CONTROL	[7:5]	R/W	000xxxxx	ave Sets averaging time for the ALS sampling. Need two to three averaging periods to make transition decision. '000' = 25ms, '001' = 50ms, '010' = 100ms, '011' = 200ms, '100' = 400ms, '101' = 800ms, '110' = 1.6s, '111' = 3.2s.
		[4:3]	R/W	xxx00xxx	timer Pre-defined countdown timer function. '00' = countdown timer is disabled '01' = 10s countdown timer is enabled (stick to the highest zone for 10s) '10' = Always stick to the highest zone the ALS reached '11' = Always stick to the highest zone the ALS reached. At the end of every countdown, the timer sets the countdown timerflag (reg 40H), and after that, a Zone transition to a lower Zone re-loads the timer and starts the next timer period.
		[2]	R/W	xxxxx0xx	als_en Enables ALS monitoring. Writing a '1' enables the ALS monitoring circuitry and a '0' disables it. This feature can be enabled without having the current sinks or charge pump active. The ALS value is updated in register 0x40 ALS ZONE READBACK.
		[1]	R/W	xxxxxx0x	als_en_a Enable ALS on Group A. Writing a '1' enables ALS control of diode current and a '0' (default) forces the Group A current to the value stored in the Group A brightness register. The als_en bit must be set to a '1' for the ALS block to control the Group A brightness.
		[0]	R/W	xxxxxxx0	als_en_b Enable ALS on Group B. Writing a '1' enables ALS control of diode current and a '0' (default) forces the Group B current to the value stored in the Group B brightness register. The als_en bit must be set to a '1' for the ALS block to control the Group B brightness. The ALS function for Group B is different than Group A in that the ALS will only enable and disable the Group B diodes depending on the ALS zone chosen by the user. Group A utilizes the 5 different zone brightness registers (Addresses 0x70 to 0x74).
51	ALS RESISTOR	[4:0]	R/W	xxx00010	r_als Sets the internal ALS resistor value. See Table 1 for details.

Table 5. Control Register Map (continued)

Hex Addr.	Register Name	Bit(s)	Read/W rite	Default Value After Reset	Bit Mnemonic and Description
52	ALS CONFIG	[7]	R/W	0xxxxxxx	autogain_en '1' = Enables autogain for the external ambient light sensor. '0' = disables autogain and GPO's are controlled by the gpo1 and gpo2 -bits. See Table 2 for details.
		[6]	R/W	x0xxxxxx	sbias_en '1' = External sensor power output enabled. '0' = External sensor power output disabled. Note: '1' -> GPOs will behave as push-pull CMOS outputs referenced to voltage on SBIAS. '0' -> GPOs will act as open-drain outputs (default).
		[5]	R/W	xx0xxxxx	sbias_volt Sensor bias output voltage selection. '1' = 3.0V output voltage. '0' = 2.4V output voltage.
		[3]	R/W	xxxx0xxx	cp_en Writing = '1' to this register bit enables the Charge-Pump block. Forces the LM3538 to operate in the gain of 1.5x. This mode DOES NOT require the Dx current sinks to be enabled for operation.
		[2]	R/W	xxxxx0xx	pass_en Writing = '1' to this register bit forces the LM3538 to operate in the gain of 1x (pass-mode). This mode DOES NOT require the Dx current sinks to be enabled for operation. Note: 1.5x gain (cp_en bit) has a higher priority.
		[1]	R/W	xxxxxx0x	gpo1 '0' = GPO1 pin state is low. '1' = GPO1 pin state is high. Effective only when the autogain is disabled. (1)
		[0]	R/W	xxxxxxx0	gpo2 '0' = GPO2 pin state is low. '1' = GPO2 pin state is high. Effective only when the autogain is disabled. (1)
60	ALS ZONE BOUNDARY#0	[7:0]	R/W	00110011	zb0 Sets Zone0 to Zone1 transition trip point
61	ALS ZONE BOUNDARY#1	[7:0]	R/W	01100110	zb1 Sets Zone1 to Zone2 transition trip point
62	ALS ZONE BOUNDARY#2	[7:0]	R/W	10011001	zb2 Sets Zone2 to Zone3 transition trip point
63	ALS ZONE BOUNDARY#3	[7:0]	R/W	11001100	zb3 Sets Zone3 to Zone4 transition trip point
64	ALS LOW to HIGH TP	[7:0]	R/W	00001011	LtoH Sets the trip point for low gain to high gain transition. Effective only when autogain = '1'.
65	ALS ZONE BOUNDARY Z3 to Z2	[7:0]	R/W	00010000	zb3to2 Zone3 to Zone2 transition trip point when the autogain is enabled.
70	ALS BRIGHTNESS ZONE#0	[6:0]	R/W	x0111100	z0b Sets the Zone Brightness code for Zone0.
71	ALS BRIGHTNESS ZONE#1	[6:0]	R/W	x1001101	z1b Sets the Zone Brightness code for Zone1.
72	ALS BRIGHTNESS ZONE#2	[6:0]	R/W	x1011001	z2b Sets the Zone Brightness code for Zone2.
73	ALS BRIGHTNESS ZONE#3	[6:0]	R/W	x1100110	z3b Sets the Zone Brightness code for Zone3.
74	ALS BRIGHTNESS ZONE#4	[6:0]	R/W	x1110010	z4b Sets the Zone Brightness code for Zone4.

- (1) V_{OUT_S} = SBIAS pin output voltage. The voltage level of the GPOs depends on the sbias_en-bit: '1'; GPOs will behave as push-pull outputs and will reference the high-side to the voltage of SBIAS. '0'; GPOs will act as open-drain outputs (default). In the open-drain configuration, they can be high-side referenced to any voltage equal or less than the VIN_A of the LM3538. Output High Level (V_{OH}) specification is valid only for push-pull -type outputs.

Table 5. Control Register Map (continued)

Hex Addr.	Register Name	Bit(s)	Read/W rite	Default Value After Reset	Bit Mnemonic and Description
A0	GROUP A BRIGHTNESS	[6:0]	R/W	x0000000	dxa Sets Brightness for Group A. 128 steps, 1111111 = Fullscale.
B0	GROUP B BRIGHTNESS	[5:3]	R/W	xx000xxx	alsZT Sets the Brightness Zone boundary used to enable and disable Group B diodes based upon ambient lighting conditions.
		[2:0]	R/W	xxxxx000	dxb Sets Brightness for Group B. 8 steps, 111 = Fullscale.
C0	LDO ENABLE	[3]	R/W	xxxx0xxx	en_Idx4 '1' = Regulator 4 enabled. '0' = Regulator 4 disabled.
		[2]	R/W	xxxx0xx	en_Idx3 '1' = Regulator 3 enabled. '0' = Regulator 3 disabled.
		[1]	R/W	xxxxx0x	en_Idx2 '1' = Regulator 2 enabled. '0' = Regulator 2 disabled.
		[0]	R/W	xxxxxxx0	en_Idx1 '1' = Regulator 1 enabled. '0' = Regulator 1 disabled.
C1	LDO1 VOUT	[4:0]	R/W	xxx11000	Idx1_vout Regulator 1 output voltage programming. See Table 4 for voltage options.
C2	LDO2 VOUT	[4:0]	R/W	xxx01100	Idx2_vout Regulator 2 output voltage programming.
C3	LDO3 VOUT	[4:0]	R/W	xxx01100	Idx3_vout Regulator 3 output voltage programming.
C4	LDO4 VOUT	[4:0]	R/W	xxx11000	Idx4_vout Regulator 4 output voltage programming.

Current Control Registers

A0 GROUP A BRIGHTNESS

This is the LED driver current control register for Group A. The register is effective when the ALS isn't used. The resolution is 7 bits, so in linear dimming mode the step size from zero up to full brightness is fixed (25.0mA/127) = 197µA. Exponential dimming scheme provides a more fine-grained level of control over low level LED currents. Group A exponential dimming curve current can be approximated by the following equation (where N = the decimal value stored in the Group A Brightness register):

$$I_{LED} (mA) \approx 25 \times 0.85^{[44 - \{(N+1)/2.91\}]}$$

Current vs. code is shown below.

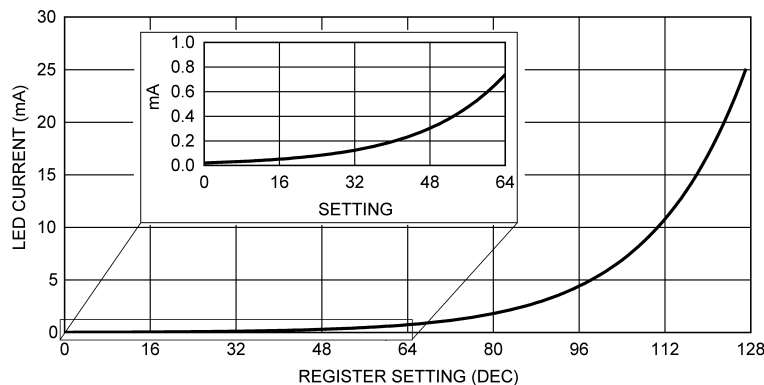

Figure 25. LED current (typ.) vs. register code, exponential dimming curve

B0 GROUP B BRIGHTNESS

Bits [2:0] set the Group B Brightness Levels, as shown in [Table 6](#) below:

Table 6. Group B Brightness Levels

dxb[2]	dxb[1]	dxb[0]	Group B LED Current (typ.)
1	1	1	25.0mA
1	1	0	17.5mA
1	0	1	15.0mA
1	0	0	12.5mA
0	1	1	10.0mA
0	1	0	7.5mA
0	0	1	5.0mA
0	0	0	2.5mA

Application Information

LED CONFIGURATIONS

The LM3538 has a total of 6 current sinks capable of sinking 150mA of total diode current. These 6 current sinks are configured to operate in one or two independently controlled lighting regions. Group A has six dedicated current sinks, while Group B has 0 by default. However, drivers D5 and D6 can be assigned to either Group A or Group B one-by-one through a setting in the configuration register. With this added flexibility, the LM3538 is capable of supporting applications requiring 4 or 5 LEDs for main display lighting, while still providing additional current sink(s) that can be used for a wide variety of lighting functions.

PARALLEL CONNECTED AND UNUSED OUTPUTS

Connecting the outputs in parallel does not affect internal operation of the LM3538 and has no impact on the Electrical Characteristics and limits previously presented. The available diode output current, maximum diode voltage, and all other specifications provided in the Electrical Characteristics table apply to this parallel output configuration, just as they do to the standard LED application circuit.

All Dx current sinks utilize LED forward voltage sensing circuitry to optimize the charge-pump gain for maximum efficiency.

If some of the drivers are not going to be used, make sure that the enable bits in the DIODE ENABLE register are set to '0' to ensure optimal efficiency.

THERMAL PROTECTION

Internal thermal protection circuitry disables the LM3538 when the junction temperature exceeds 160°C (typ.). This feature protects the device from being damaged by high die temperatures that might otherwise result from excessive power dissipation. The device will recover and operate normally when the junction temperature falls below 155°C (typ.). It is important that the board layout provide good thermal conduction to keep the junction temperature within the specified operating ratings.

CAPACITOR SELECTION

The LM3538 circuit requires 11 external capacitors for proper operation. Surface-mount multi-layer ceramic capacitors are recommended. These capacitors are small, inexpensive and have very low equivalent series resistance (ESR <20mOhm typ.). Tantalum capacitors, OS-CON capacitors, and aluminum electrolytic capacitors are not recommended for use with the LM3538 due to their high ESR, as compared to ceramic capacitors.

For most applications, ceramic capacitors with X7R or X5R temperature characteristic are preferred for use with the LM3538. These capacitors have tight capacitance tolerance (as good as ±10%) and hold their value over temperature (X7R: ±15% over -55°C to 125°C; X5R: ±15% over -55°C to 85°C).

Capacitors with Y5V or Z5U temperature characteristic are generally not recommended for use with the LM3538. Capacitors with these temperature characteristics typically have wide capacitance tolerance (+80%, –20%) and vary significantly over temperature (Y5V: +22%, –82% over –30°C to +85°C range; Z5U: +22%, –56% over +10°C to +85°C range). Under some conditions, a nominal 1µF Y5V or Z5U capacitor could have a capacitance of only 0.1µF. Such detrimental deviation is likely to cause Y5V and Z5U capacitors to fail to meet the minimum capacitance requirements of the LM3538.

Table 7 below lists recommended external capacitors from some leading ceramic capacitor manufacturers. It is strongly recommended that the LM3538 circuit be thoroughly evaluated early in the design-in process with the mass-production capacitors of choice. This will help ensure that any variability in capacitance does not negatively impact circuit performance.

Table 7. Suggested Capacitors

Model	Type	Vendor	Voltage Rating	Package Size
1µF for C _{OUT} , C _{LDO1} , C _{LDO2} , C _{LDO3} , C _{LDO4} , C _{SEN} , C ₁ , C ₂ and C _{IN_A} ⁽¹⁾				
C1005X5R1A105K	Ceramic X5R	TDK	10V	0402
LMK105BJ105KV-F	Ceramic X5R	Taiyo Yuden	10V	0402
GRM155R61A105K	Ceramic X5R	Murata	10V	0402
0.1µF for C _{IN_B} ⁽¹⁾				
GRM155R61A104K	Ceramic X5R	Murata	10V	0402
LMK105BJ104KV-F	Ceramic X5R	Taiyo Yuden	10V	0402
C1005X5R1A104K	Ceramic X5R	TDK	10V	0402
2.2µF for C _{IN_C}				
JMK105BJ225MV-F	Ceramic X5R	Taiyo Yuden	6.3V	0402
GRM155R60J225ME15D	Ceramic X5R	Murata	6.3V	0402

(1) The recommended voltage rating for these capacitors is 10V to account for DC bias capacitance losses.

REVISION HISTORY

Changes from Original (May 2013) to Revision A	Page
• Changed layout of National Data Sheet to TI format	25

PACKAGING INFORMATION

Orderable Device	Status (1)	Package Type	Package Drawing	Pins	Package Qty	Eco Plan (2)	Lead finish/ Ball material (6)	MSL Peak Temp (3)	Op Temp (°C)	Device Marking (4/5)	Samples
LM3538TME/NOPB	ACTIVE	DSBGA	YFQ	30	250	RoHS & Green	SNAGCU	Level-1-260C-UNLIM	-30 to 110	3538	Samples
LM3538TMX/NOPB	ACTIVE	DSBGA	YFQ	30	3000	RoHS & Green	SNAGCU	Level-1-260C-UNLIM	-30 to 110	3538	Samples

(1) The marketing status values are defined as follows:

ACTIVE: Product device recommended for new designs.

LIFEBUY: TI has announced that the device will be discontinued, and a lifetime-buy period is in effect.

NRND: Not recommended for new designs. Device is in production to support existing customers, but TI does not recommend using this part in a new design.

PREVIEW: Device has been announced but is not in production. Samples may or may not be available.

OBSOLETE: TI has discontinued the production of the device.

(2) **RoHS:** TI defines "RoHS" to mean semiconductor products that are compliant with the current EU RoHS requirements for all 10 RoHS substances, including the requirement that RoHS substance do not exceed 0.1% by weight in homogeneous materials. Where designed to be soldered at high temperatures, "RoHS" products are suitable for use in specified lead-free processes. TI may reference these types of products as "Pb-Free".

RoHS Exempt: TI defines "RoHS Exempt" to mean products that contain lead but are compliant with EU RoHS pursuant to a specific EU RoHS exemption.

Green: TI defines "Green" to mean the content of Chlorine (Cl) and Bromine (Br) based flame retardants meet JS709B low halogen requirements of <=1000ppm threshold. Antimony trioxide based flame retardants must also meet the <=1000ppm threshold requirement.

(3) MSL, Peak Temp. - The Moisture Sensitivity Level rating according to the JEDEC industry standard classifications, and peak solder temperature.

(4) There may be additional marking, which relates to the logo, the lot trace code information, or the environmental category on the device.

(5) Multiple Device Markings will be inside parentheses. Only one Device Marking contained in parentheses and separated by a "~" will appear on a device. If a line is indented then it is a continuation of the previous line and the two combined represent the entire Device Marking for that device.

(6) Lead finish/Ball material - Orderable Devices may have multiple material finish options. Finish options are separated by a vertical ruled line. Lead finish/Ball material values may wrap to two lines if the finish value exceeds the maximum column width.

Important Information and Disclaimer:The information provided on this page represents TI's knowledge and belief as of the date that it is provided. TI bases its knowledge and belief on information provided by third parties, and makes no representation or warranty as to the accuracy of such information. Efforts are underway to better integrate information from third parties. TI has taken and continues to take reasonable steps to provide representative and accurate information but may not have conducted destructive testing or chemical analysis on incoming materials and chemicals. TI and TI suppliers consider certain information to be proprietary, and thus CAS numbers and other limited information may not be available for release.

In no event shall TI's liability arising out of such information exceed the total purchase price of the TI part(s) at issue in this document sold by TI to Customer on an annual basis.

TAPE AND REEL INFORMATION

QUADRANT ASSIGNMENTS FOR PIN 1 ORIENTATION IN TAPE

*All dimensions are nominal

Device	Package Type	Package Drawing	Pins	SPQ	Reel Diameter (mm)	Reel Width W1 (mm)	A0 (mm)	B0 (mm)	K0 (mm)	P1 (mm)	W (mm)	Pin1 Quadrant
LM3538TME/NOPB	DSBGA	YFQ	30	250	178.0	8.4	2.18	2.69	0.76	4.0	8.0	Q1
LM3538TMX/NOPB	DSBGA	YFQ	30	3000	178.0	8.4	2.18	2.69	0.76	4.0	8.0	Q1

TAPE AND REEL BOX DIMENSIONS

*All dimensions are nominal

Device	Package Type	Package Drawing	Pins	SPQ	Length (mm)	Width (mm)	Height (mm)
LM3538TME/NOPB	DSBGA	YFQ	30	250	208.0	191.0	35.0
LM3538TMX/NOPB	DSBGA	YFQ	30	3000	208.0	191.0	35.0

YFQ0030

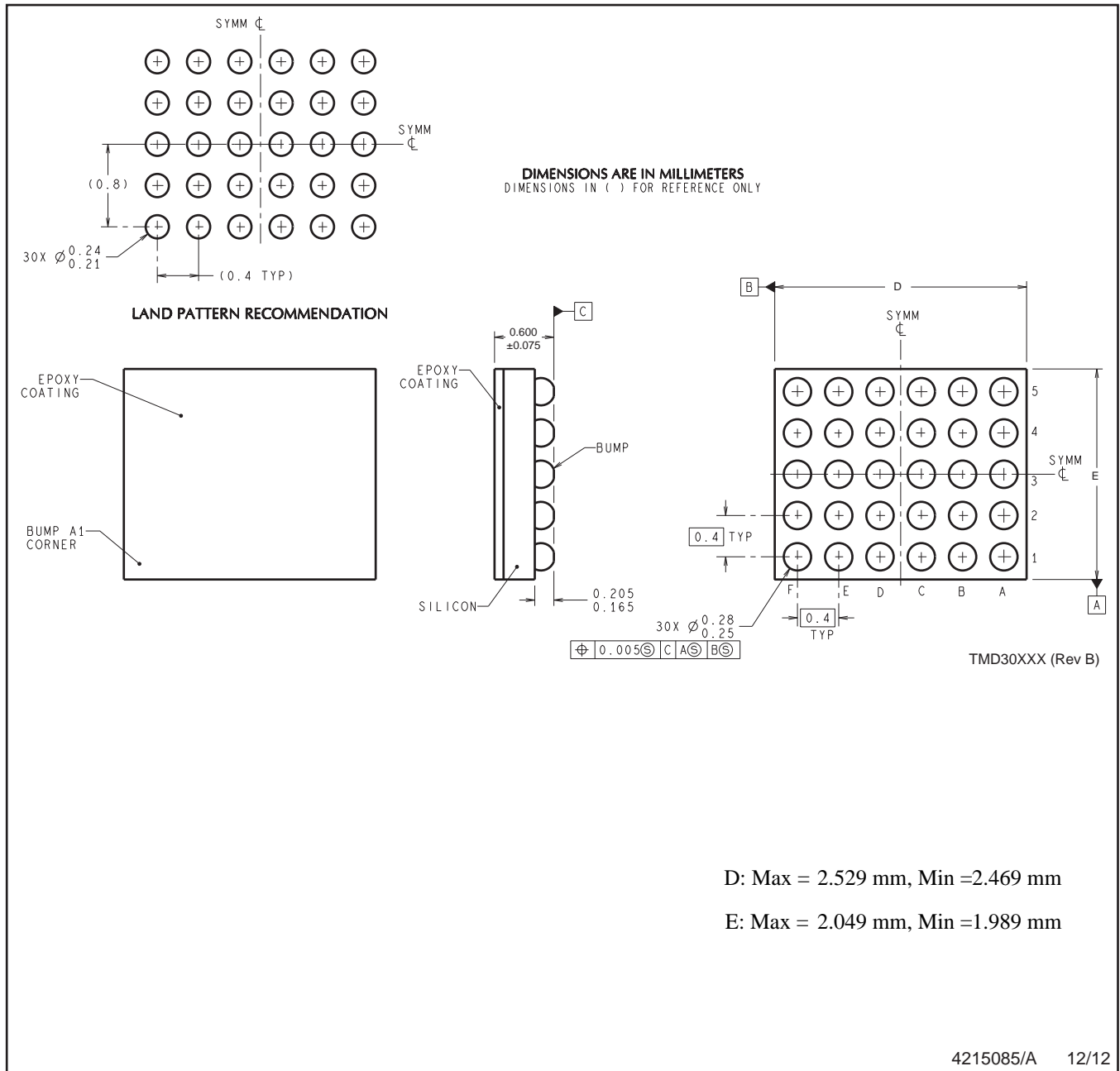

NOTES: A. All linear dimensions are in millimeters. Dimensioning and tolerancing per ASME Y14.5M-1994.
B. This drawing is subject to change without notice.

IMPORTANT NOTICE AND DISCLAIMER

TI PROVIDES TECHNICAL AND RELIABILITY DATA (INCLUDING DATA SHEETS), DESIGN RESOURCES (INCLUDING REFERENCE DESIGNS), APPLICATION OR OTHER DESIGN ADVICE, WEB TOOLS, SAFETY INFORMATION, AND OTHER RESOURCES "AS IS" AND WITH ALL FAULTS, AND DISCLAIMS ALL WARRANTIES, EXPRESS AND IMPLIED, INCLUDING WITHOUT LIMITATION ANY IMPLIED WARRANTIES OF MERCHANTABILITY, FITNESS FOR A PARTICULAR PURPOSE OR NON-INFRINGEMENT OF THIRD PARTY INTELLECTUAL PROPERTY RIGHTS.

These resources are intended for skilled developers designing with TI products. You are solely responsible for (1) selecting the appropriate TI products for your application, (2) designing, validating and testing your application, and (3) ensuring your application meets applicable standards, and any other safety, security, regulatory or other requirements.

These resources are subject to change without notice. TI grants you permission to use these resources only for development of an application that uses the TI products described in the resource. Other reproduction and display of these resources is prohibited. No license is granted to any other TI intellectual property right or to any third party intellectual property right. TI disclaims responsibility for, and you will fully indemnify TI and its representatives against, any claims, damages, costs, losses, and liabilities arising out of your use of these resources.

TI's products are provided subject to [TI's Terms of Sale](#) or other applicable terms available either on [ti.com](https://www.ti.com) or provided in conjunction with such TI products. TI's provision of these resources does not expand or otherwise alter TI's applicable warranties or warranty disclaimers for TI products.

TI objects to and rejects any additional or different terms you may have proposed.

Mailing Address: Texas Instruments, Post Office Box 655303, Dallas, Texas 75265
Copyright © 2023, Texas Instruments Incorporated