

LM3648 Synchronous Boost LED Flash Driver with 1.5-A High-Side Current Source

1 Features

- 1.5-A LED Current Source Programmability
- Accurate and Programmable LED Current Range from 1.954 mA to 1.5 A
- Torch Currents up to 500 mA (LM3648TT)
- Flash Timeout Values up to 1.6 Seconds (LM3648TT)
- Optimized Flash LED Current During Low Battery Conditions (IVFM)
- > 85% Efficiency in Torch Mode (at 100 mA) and Flash Mode (at 1 A to 1.5 A)
- Grounded Cathode LED Operation for Improved Thermal Management
- Small Solution Size: < 16 mm²
- Hardware Strobe Enable (STROBE)
- Synchronization Input for RF Power Amplifier Pulse Events (TX)
- Hardware Torch Enable (TORCH/TEMP)
- Remote NTC Monitoring (TORCH/TEMP)
- 400-kHz I²C-Compatible Interface
 - LM3648 (I²C Address = 0x63)

2 Applications

- Camera Phone White-LED Flash
- Digital Still Cameras
- Fire-Alarm Notification
- Emergency Strobe Lighting
- Intruder Alert Notification
- Barcode Scanners
- Handheld Data Terminals

3 Description

The LM3648 is an LED flash driver that provides a high level of adjustability within a small solution size. The LM3648 utilizes a 2-MHz or 4-MHz fixed-frequency synchronous boost converter to provide power to the 1.5-A constant current LED source. An adaptive regulation method ensures the current source remains in regulation and maximizes efficiency.

Features of the LM3648 are controlled via an I²C-compatible interface. These features include: hardware flash and hardware torch pins (STROBE and TORCH/TEMP), a TX interrupt, and an NTC thermistor monitor. The device offers 64 programmable currents in Flash and 128 levels in Movie Mode (Torch) condition.

The 2-MHz or 4-MHz switching frequency options, overvoltage protection (OVP), and adjustable current limit allow for the use of tiny, low-profile inductors and (10- μ F) ceramic capacitors. The device operates over a -40°C to $+85^{\circ}\text{C}$ ambient temperature range.

Device Information⁽¹⁾

PART NUMBER	PACKAGE	BODY SIZE (MAX)
LM3648	DSBGA (12)	1.69 mm x 1.31 mm

(1) For all available packages, see the orderable addendum at the end of the data sheet.

Simplified Schematic

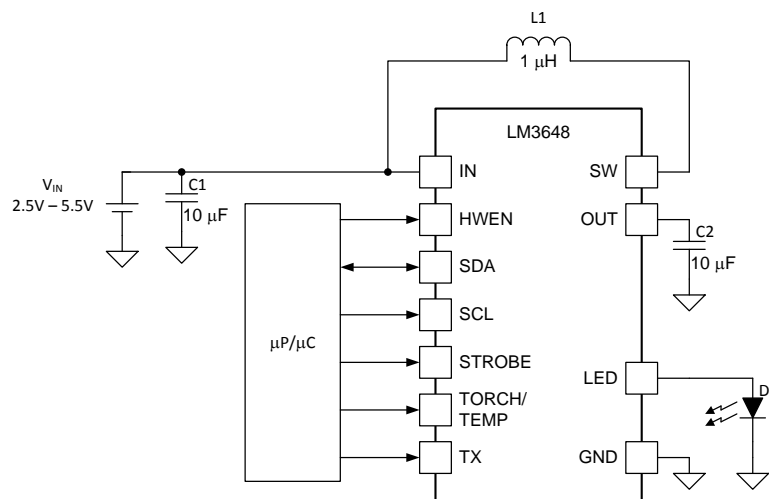

Table of Contents

<p>1 Features 1</p> <p>2 Applications 1</p> <p>3 Description 1</p> <p>4 Revision History 2</p> <p>5 Pin Configuration and Functions 3</p> <p>6 Specifications 4</p> <p> 6.1 Absolute Maximum Ratings 4</p> <p> 6.2 ESD Ratings 4</p> <p> 6.3 Recommended Operating Conditions 4</p> <p> 6.4 Thermal Information 4</p> <p> 6.5 Electrical Characteristics 5</p> <p> 6.6 Timing Requirements 5</p> <p> 6.7 Switching Characteristics 6</p> <p> 6.8 Typical Characteristics 6</p> <p>7 Detailed Description 10</p> <p> 7.1 Overview 10</p> <p> 7.2 Functional Block Diagram 11</p> <p> 7.3 Feature Description 11</p> <p> 7.4 Device Functioning Modes 13</p>	<p> 7.5 Programming 16</p> <p> 7.6 Register Descriptions 18</p> <p>8 Applications and Implementation 22</p> <p> 8.1 Application Information 22</p> <p> 8.2 Typical Application 22</p> <p>9 Power Supply Recommendations 27</p> <p>10 Layout 27</p> <p> 10.1 Layout Guidelines 27</p> <p> 10.2 Layout Example 28</p> <p>11 Device and Documentation Support 29</p> <p> 11.1 Device Support 29</p> <p> 11.2 Documentation Support 29</p> <p> 11.3 Receiving Notification of Documentation Updates 29</p> <p> 11.4 Community Resources 29</p> <p> 11.5 Trademarks 29</p> <p> 11.6 Electrostatic Discharge Caution 29</p> <p> 11.7 Glossary 30</p> <p>12 Mechanical, Packaging, and Orderable Information 30</p>
---	--

4 Revision History

NOTE: Page numbers for previous revisions may differ from page numbers in the current version.

Changes from Revision C (September 2016) to Revision D	Page
• Changed "(Default)" from "011111 = 748.75 mA" to "111111 = 1.5 A" in <i>LED Flash Brightness Register</i>	19
<hr/>	
Changes from Revision B (September 2015) to Revision C	Page
• Added several additional <i>Applications</i>	1
<hr/>	
Changes from Revision A (August 2015) to Revision B	Page
• Added "or 0x04 for LM3648TT" to Device ID Register row, <i>Register Descriptions</i> table.....	18
• Changed "'011'" to "'000'" in Device Register Bits 5-3 description.....	21
<hr/>	
Changes from Original (October 2014) to Revision A	Page
• Added Torch Currents up to 500 mA (LM3648TT).....	1
• Added Flash Timeout Values up to 1.6 seconds (LM3648TT)	1
• Changed <i>Handling Ratings</i> to <i>ESD Ratings</i> ; moved storage temperature to <i>Abs Max</i>	4
• Added I_{LED} row for LM3648TT option	5
• Added V_{HR} row for LM3648TT option	5
• Added several new graphs related to LM3648TT option performance	5
• Added to 1.6 s on LM3648TT in <i>Flash Time-Out</i>	15
• Added new eq. and LM3648TT values in LED Torch Brightness Reg.; added NOTE below LED Torch Brightness Reg. description	19
• Added LM3648TT values for Timing Config. Reg.; added NOTE below Timing Config. Reg. description	20
• Added "or '100'" for LM3648TT in Device ID Register Bits 2-0 description	21
• Added Application curves for LM3648TT performance	24

5 Pin Configuration and Functions

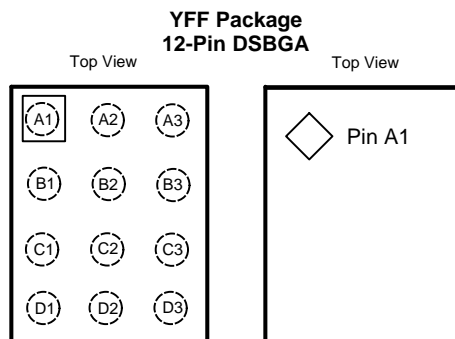

Pin Functions

PIN		TYPE ⁽¹⁾	DESCRIPTION
NUMBER	NAME		
A1	GND	G	Ground
A2	IN	P	Input voltage connection. Connect IN to the input supply and bypass to GND with a 10- μ F or larger ceramic capacitor.
A3	SDA	I/O	Serial data input/output in the I ² C Mode on LM3648.
B1	SW	P	Drain connection for Internal NMOS and synchronous PMOS Switches.
B2	STROBE	I	Active high hardware flash enable. Drive STROBE high to turn on Flash pulse. Internal pulldown resistor of 300 k Ω between STROBE and GND.
B3	SCL	I	Serial clock input for LM3648.
C1	OUT	P	Step-up DC-DC converter output. Connect a 10- μ F ceramic capacitor between this terminal and GND.
C2	HWEN	I	Active high enable pin. High = Standby, Low = Shutdown/Reset. Internal pulldown resistor of 300 k Ω between HWEN and GND.
C3	TORCH/TEMP	I/P	Torch terminal input or threshold detector for NTC temperature sensing and current scale back.
D1	LED	P	High-side current source output for flash LED. Connect pin D1 to D3 externally.
D2	TX	I	Configurable dual polarity power amplifier synchronization input. Internal pulldown resistor of 300 k Ω between TX and GND.
D3	LED	P	High-side current source output for flash LED. Connect pin D1 to D3 externally.

(1) A: Analog Pin, G: Ground Pin, P: Power Pin, I: Digital Input Pin

6 Specifications

6.1 Absolute Maximum Ratings

 over operating free-air temperature range (unless otherwise noted)⁽¹⁾⁽²⁾

	MIN	MAX	UNIT
IN, SW, OUT, LED	-0.3	6	V
SDA, SCL, TX, TORCH/TEMP, HWEN, STROBE	-0.3	(V _{IN} + 0.3) w/ 6 V max	
Continuous power dissipation ⁽³⁾	Internally limited		
Junction temperature (T _{J-MAX})		150	°C
Maximum lead temperature (soldering)	See ⁽⁴⁾		
Storage temperature, T _{stg}	-65	150	°C

- (1) Stresses beyond those listed under *Absolute Maximum Ratings* may cause permanent damage to the device. These are stress ratings only, which do not imply functional operation of the device at these or any other conditions beyond those indicated under *Recommended Operating Conditions*. Exposure to absolute-maximum-rated conditions for extended periods may affect device reliability.
- (2) All voltages are with respect to the potential at the GND pin.
- (3) Internal thermal shutdown circuitry protects the device from permanent damage. Thermal shutdown engages at T_J = 150°C (typical) and disengages at T_J = 135°C (typical). Thermal shutdown is ensured by design.
- (4) For detailed soldering specifications and information, refer to Texas Instruments Application Note 1112: *DSBGA Wafer Level Chip Scale Package* (SNVA009).

6.2 ESD Ratings

		VALUE	UNIT
V _(ESD) Electrostatic discharge	Human-body model (HBM), per ANSI/ESDA/JEDEC JS-001 ⁽¹⁾	±2500	V
	Charged-device model (CDM), per JEDEC specification JESD22-C101 ⁽²⁾	±150	

- (1) JEDEC document JEP155 states that 500-V HBM allows safe manufacturing with a standard ESD control process.
- (2) JEDEC document JEP157 states that 250-V CDM allows safe manufacturing with a standard ESD control process.

6.3 Recommended Operating Conditions

 over operating free-air temperature range (unless otherwise noted)⁽¹⁾⁽²⁾

	MIN	MAX	UNIT
V _{IN}	2.5	5.5	V
Junction temperature (T _J)	-40	125	°C
Ambient temperature (T _A) ⁽³⁾	-40	85	°C

- (1) Stresses beyond those listed under *absolute maximum ratings* may cause permanent damage to the device. These are stress ratings only, and functional operation of the device at these or any other conditions beyond those indicated under *recommended operating conditions* is not implied. Exposure to absolute-maximum-rated conditions for extended periods may affect device reliability.
- (2) All voltages are with respect to the potential at the GND terminal.
- (3) In applications where high power dissipation and/or poor package thermal resistance is present, the maximum ambient temperature may have to be derated. Maximum ambient temperature (T_{A-MAX}) is dependent on the maximum operating junction temperature (T_{J-MAX-OP} = 125°C), the maximum power dissipation of the device in the application (P_{D-MAX}), and the junction-to-ambient thermal resistance of the part/package in the application (R_{θJA}), as given by the following equation: T_{A-MAX} = T_{J-MAX-OP} - (R_{θJA} × P_{D-MAX}).

6.4 Thermal Information

THERMAL METRIC ⁽¹⁾		LM3648	UNIT
		YFF (DSBGA)	
		12 PINS	
R _{θJA}	Junction-to-ambient thermal resistance	90.2	°C/W
R _{θJC(top)}	Junction-to-case (top) thermal resistance	0.5	°C/W
R _{θJB}	Junction-to-board thermal resistance	40.0	°C/W
Ψ _{JT}	Junction-to-top characterization parameter	3.0	°C/W
Ψ _{JB}	Junction-to-board characterization parameter	39.2	°C/W

- (1) For more information about traditional and new thermal metrics, see the [Semiconductor and IC Package Thermal Metrics](#).

6.5 Electrical Characteristics

Typical limits tested at $T_A = 25^\circ\text{C}$. Minimum and maximum limits apply over the full operating ambient temperature range ($-40^\circ\text{C} \leq T_A \leq +85^\circ\text{C}$). Unless otherwise specified, $V_{IN} = 3.6\text{ V}$, $HWEN = V_{IN}$.⁽¹⁾⁽²⁾

PARAMETER		TEST CONDITIONS		MIN	TYP	MAX	UNIT
CURRENT SOURCE SPECIFICATIONS							
I_{LED}	Current source accuracy	$V_{OUT} = 4\text{ V}$, flash code = 0x3F = 1.5 A flash		-7%	1.5	7%	A
		$V_{OUT} = 4\text{ V}$, torch code = 0x3F = 178.6 mA torch		-10%	178.6	10%	mA
I_{LED}	Current source accuracy (LM3648TT)	$V_{OUT} = 4\text{ V}$, torch code = 0x3F = 357.2 mA torch		-10%	357.2	10%	mA
V_{HR}	LED current source regulation voltage	$I_{LED} = 1.5\text{ A}$	Flash	290			mV
		$I_{LED} = 178.6\text{ mA}$	Torch	158			
V_{HR}	LED current source regulation voltage (LM3648TT)	$I_{LED} = 357.2\text{ mA}$		270			mV
V_{OVP}	ON threshold		4.86	5	5.1	V	
	OFF threshold		4.75	4.88	4.99		
STEP-UP DC-DC CONVERTER SPECIFICATIONS							
R_{PMOS}	PMOS switch on-resistance			86			m Ω
R_{NMOS}	NMOS switch on-resistance			65			
I_{CL}	Switch current limit	Reg 0x07, bit[0] = 0		-12%	1.9	12%	A
		Reg 0x07, bit[0] = 1		-12%	2.8	12%	
V_{UVLO}	Undervoltage lockout threshold	Falling V_{IN}		-2%	2.5	2%	V
V_{TRIP}	NTC comparator trip threshold	Reg 0x09, bits[3:1] = '100'		-5%	0.6	5%	V
I_{NTC}	NTC current			-6%	50	6%	μA
V_{IVFM}	Input voltage flash monitor trip threshold	Reg 0x02, bits[5:3] = '000'		-3%	2.9	3%	V
I_Q	Quiescent supply current	Device not switching pass mode		0.3		0.75	mA
I_{SD}	Shutdown supply current	Device disabled, $HWEN = 0\text{ V}$ $2.5\text{ V} \leq V_{IN} \leq 5.5\text{ V}$		0.1		4	μA
I_{SB}	Standby supply current	Device disabled, $HWEN = 1.8\text{ V}$ $2.5\text{ V} \leq V_{IN} \leq 5.5\text{ V}$		2.5		10	μA
HWEN, TORCH/TEMP, STROBE, TX VOLTAGE SPECIFICATIONS							
V_{IL}	Input logic low	$2.5\text{ V} \leq V_{IN} \leq 5.5\text{ V}$		0	0.4		V
V_{IH}	Input logic high			1.2	V_{IN}		V
I²C-COMPATIBLE INTERFACE SPECIFICATIONS (SCL, SDA)							
V_{IL}	Input logic low	$2.5\text{ V} \leq V_{IN} \leq 4.2\text{ V}$		0	0.4		V
V_{IH}	Input logic high			1.2	V_{IN}		
V_{OL}	Output logic low	$I_{LOAD} = 3\text{ mA}$		400		mV	

- (1) Minimum (MIN) and Maximum (MAX) limits are specified by design, test, or statistical analysis. Typical (TYP) numbers are not verified, but do represent the most likely norm. Unless otherwise specified, conditions for typical specifications are: $V_{IN} = 3.6\text{ V}$ and $T_A = 25^\circ\text{C}$.
 (2) All voltages are with respect to the potential at the GND pin.

6.6 Timing Requirements

		MIN	NOM	MAX	UNIT
t_1	SCL clock period	2.4			μs
t_2	Data in set-up time to SCL high	100			ns
t_3	Data out stable After SCL low	0			ns
t_4	SDA low set-up time to SCL low (start)	100			ns
t_5	SDA high hold time after SCL high (stop)	100			ns

6.7 Switching Characteristics

over operating free-air temperature range (unless otherwise noted)

PARAMETER	TEST CONDITIONS	MIN	TYP	MAX	UNIT
f_{SW} Switching frequency	$2.5\text{ V} \leq V_{IN} \leq 5.5\text{ V}$	-6%	4	6%	MHz

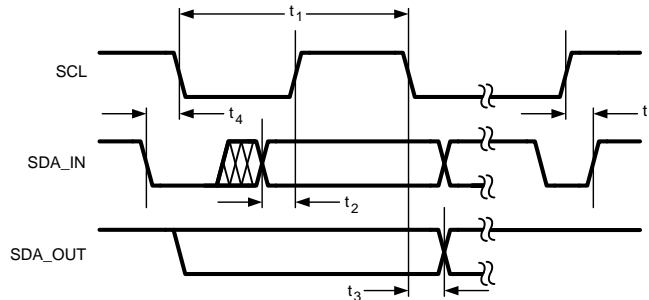

Figure 1. I²C-Compatible Interface Specifications

6.8 Typical Characteristics

$T_A = 25^\circ\text{C}$, $V_{IN} = 3.6\text{ V}$, $HWEN = V_{IN}$, $C_{IN} = C_{OUT} = 2 \times 10\ \mu\text{F}$ and $L = 1\ \mu\text{H}$, unless otherwise noted.

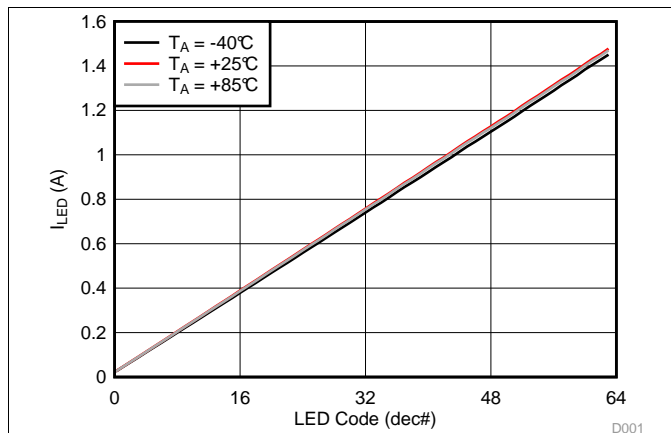

Figure 2. LED Flash Current vs Brightness Code

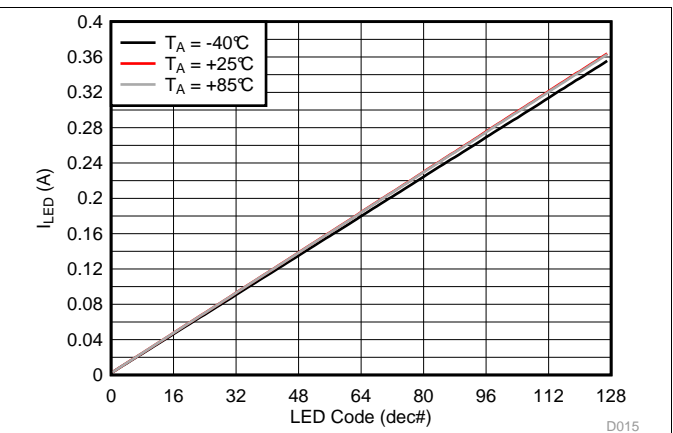

Figure 3. LED Torch Current vs Brightness Code

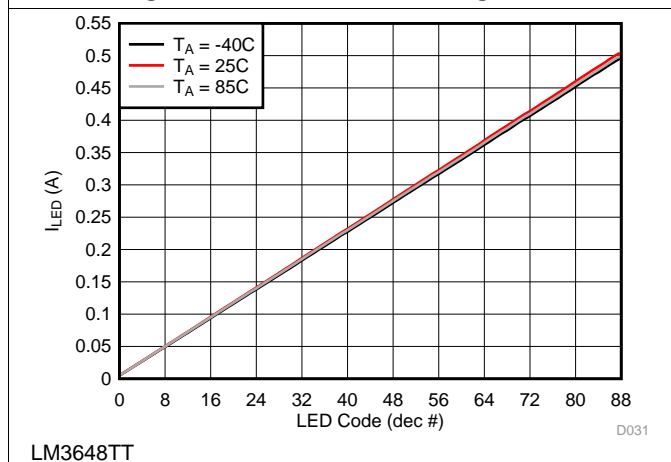

Figure 4. LED Torch Current vs Brightness Code

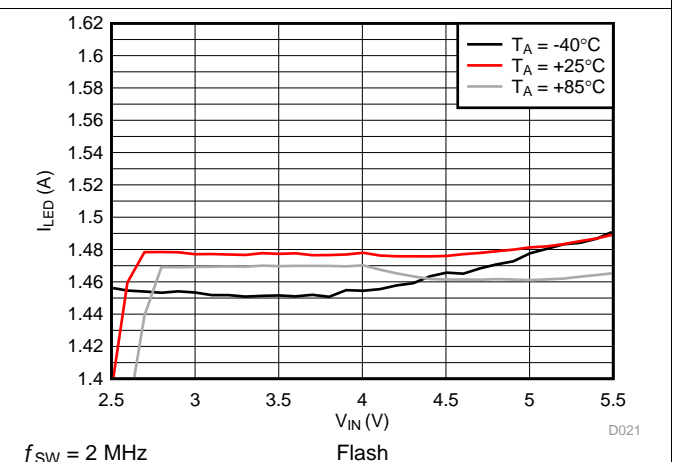
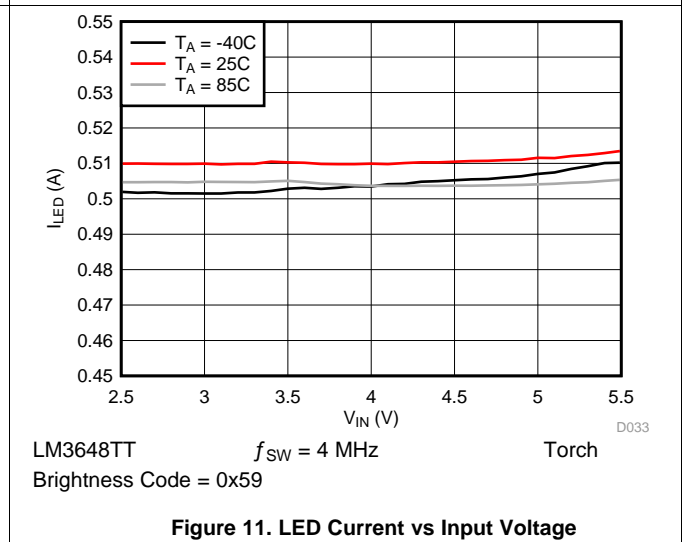
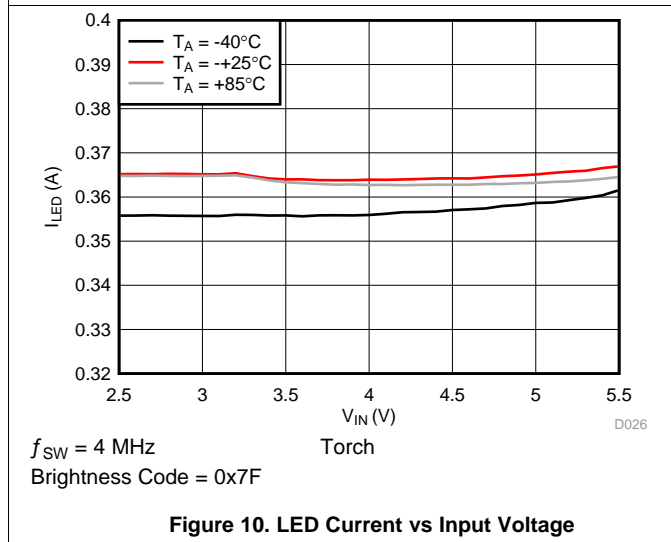
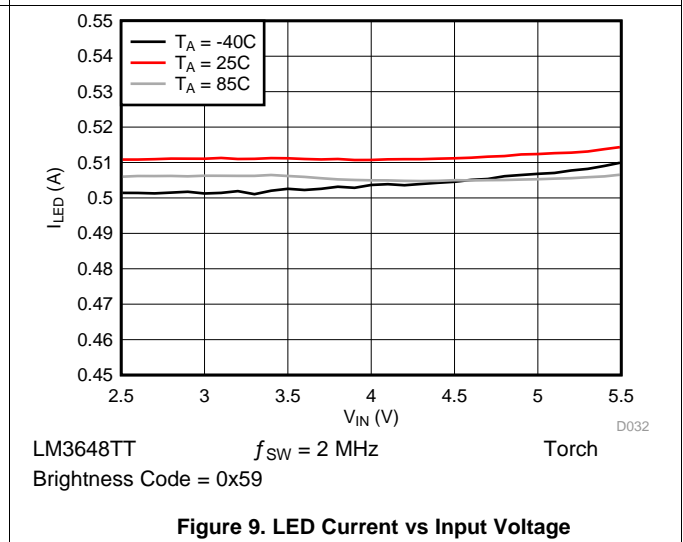
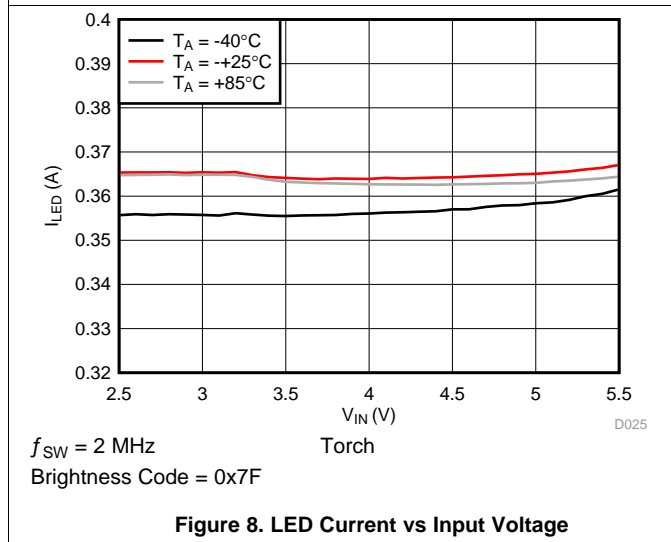
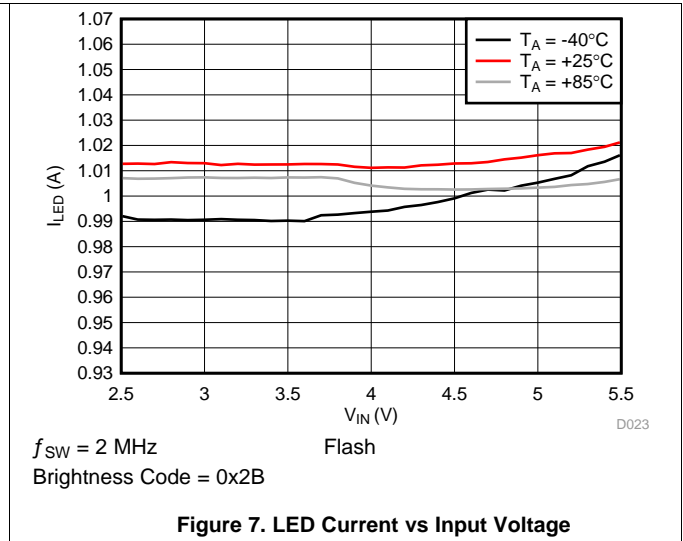
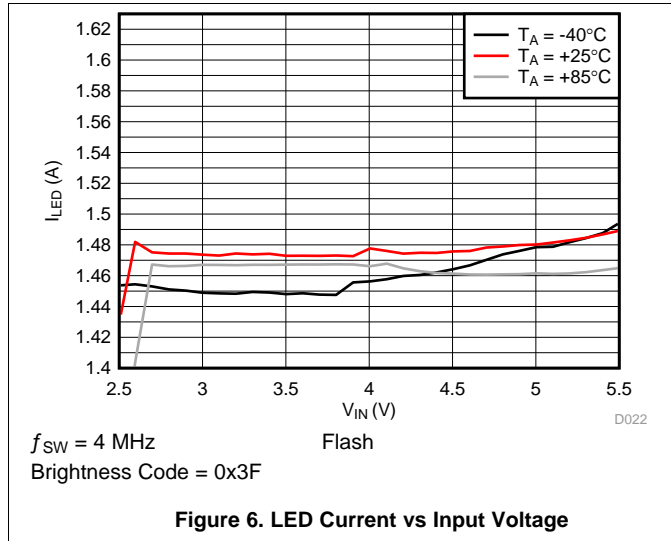

Figure 5. LED Current vs Input Voltage

Typical Characteristics (continued)

$T_A = 25^\circ\text{C}$, $V_{IN} = 3.6\text{ V}$, $\text{HWEN} = V_{IN}$, $C_{IN} = C_{OUT} = 2 \times 10\ \mu\text{F}$ and $L = 1\ \mu\text{H}$, unless otherwise noted.



Typical Characteristics (continued)

$T_A = 25^\circ\text{C}$, $V_{IN} = 3.6\text{ V}$, $HWEN = V_{IN}$, $C_{IN} = C_{OUT} = 2 \times 10\ \mu\text{F}$ and $L = 1\ \mu\text{H}$, unless otherwise noted.

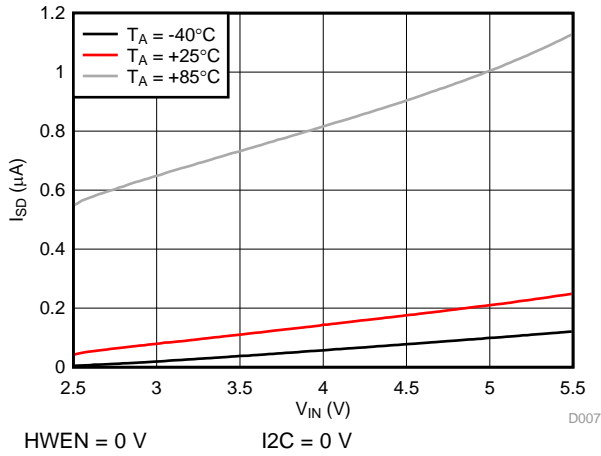

Figure 12. Shutdown Current vs Input Voltage

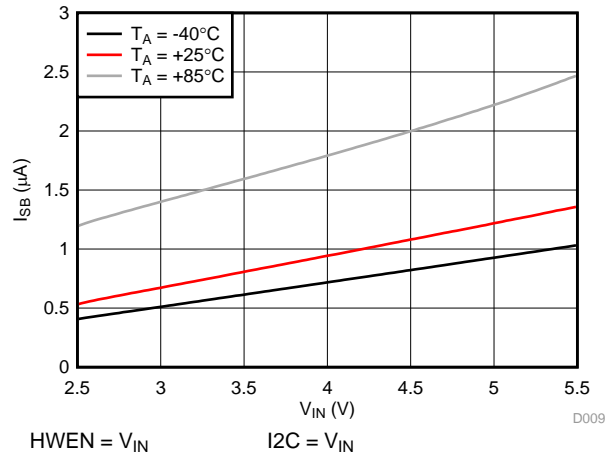

Figure 13. Standby Current vs Input Voltage

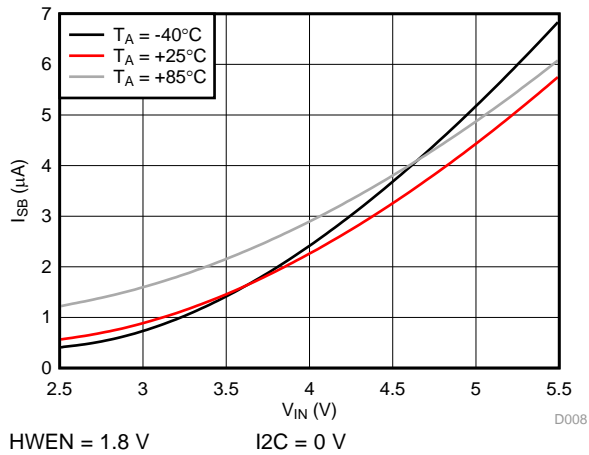

Figure 14. Standby Current vs Input Voltage

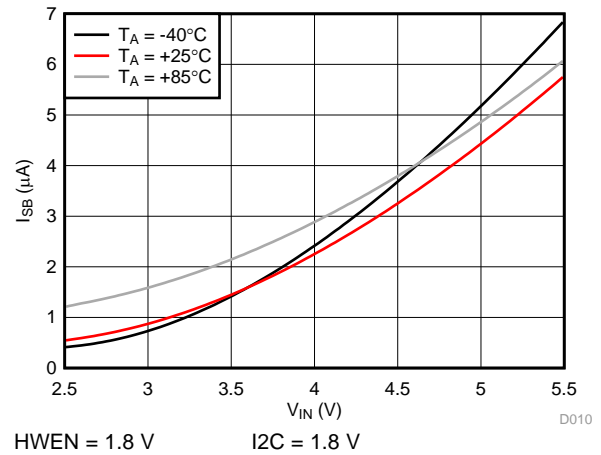

Figure 15. Standby Current vs Input Voltage

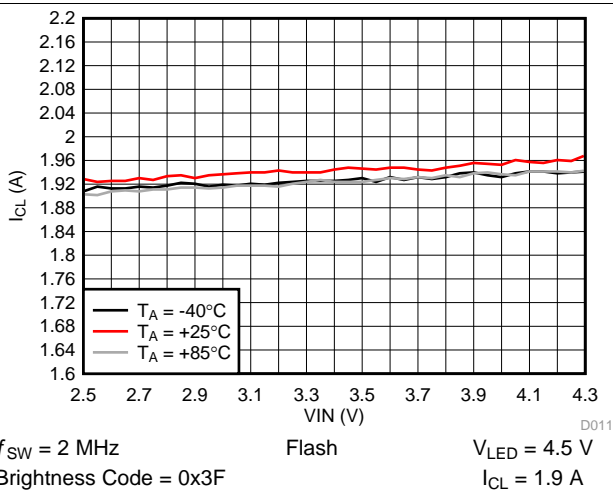

Figure 16. Inductor Current Limit vs Input Voltage

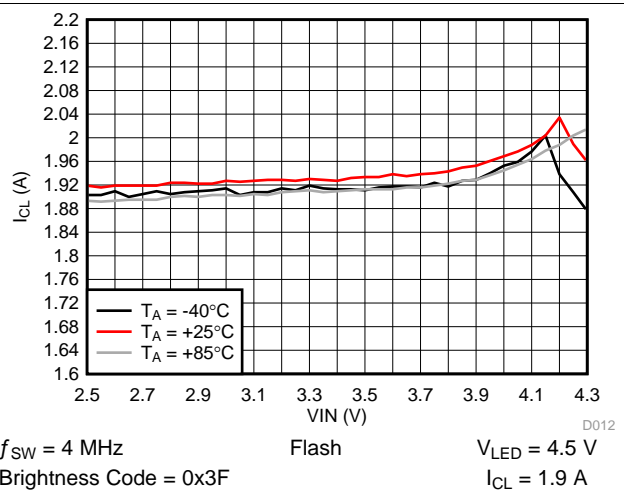

Figure 17. Inductor Current Limit vs Input Voltage

Typical Characteristics (continued)

$T_A = 25^\circ\text{C}$, $V_{IN} = 3.6\text{ V}$, $HWEN = V_{IN}$, $C_{IN} = C_{OUT} = 2 \times 10\ \mu\text{F}$ and $L = 1\ \mu\text{H}$, unless otherwise noted.

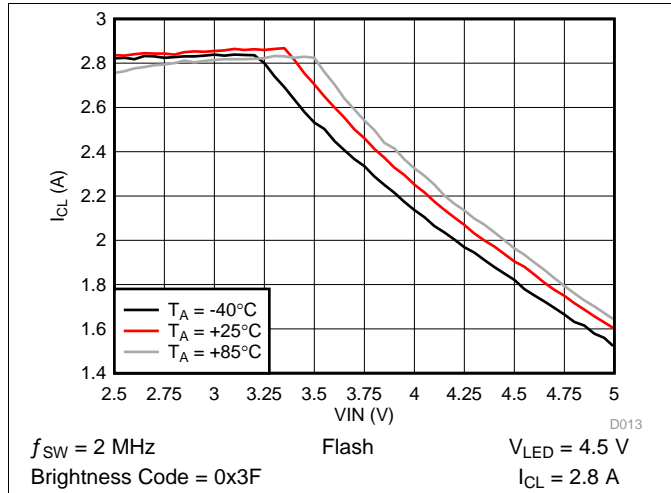

Figure 18. Inductor Current Limit vs Input Voltage

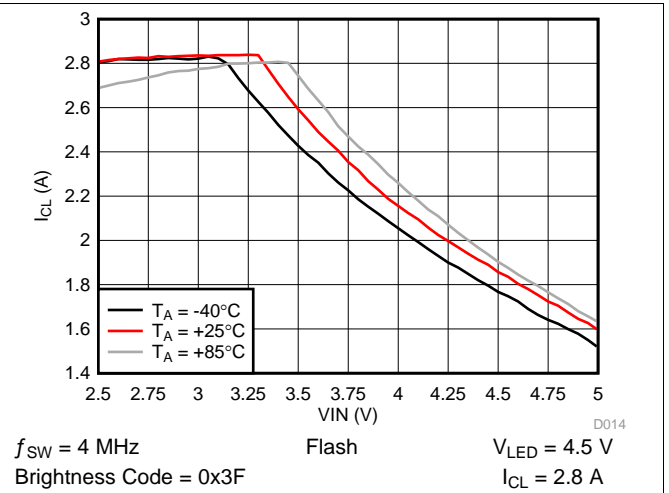

Figure 19. Inductor Current Limit vs Input Voltage

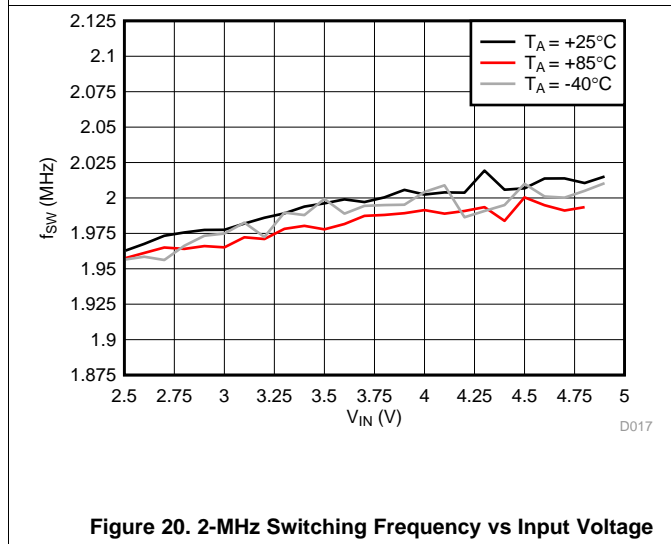

Figure 20. 2-MHz Switching Frequency vs Input Voltage

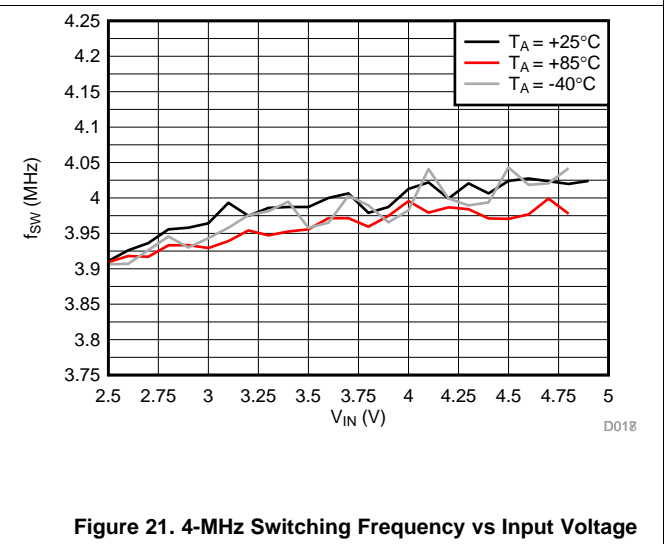

Figure 21. 4-MHz Switching Frequency vs Input Voltage

7 Detailed Description

7.1 Overview

The LM3648 is a high-power white LED flash driver capable of delivering up to 1.5 A to the LED. The device incorporates a 2-MHz or 4-MHz constant frequency-synchronous current-mode PWM boost converter and a high-side current source to regulate the LED current over the 2.5-V to 5.5-V input voltage range.

The LM3648 PWM DC/DC boost converter switches and boosts the output to maintain at least V_{HR} across the current source. This minimum headroom voltage ensures that the current source remains in regulation. If the input voltage is above the LED voltage + current source headroom voltage the device does not switch, but turns the PFET on continuously (Pass mode). In Pass mode the difference between $(V_{IN} - I_{LED} \times R_{PMOS})$ and the voltage across the LED is dropped across the current source.

The LM3648 has three logic inputs including a hardware Flash Enable (STROBE), a hardware Torch Enable (TORCH/TEMP, TORCH = default), and a Flash Interrupt input (TX) designed to interrupt the flash pulse during high battery-current conditions. These logic inputs have internal 300-k Ω (typical) pulldown resistors to GND.

Additional features of the LM3648 include an internal comparator for LED thermal sensing via an external NTC thermistor and an input voltage monitor that can reduce the Flash current during low V_{IN} conditions. It also has a Hardware Enable (HWEN) pin that can be used to reset the state of the device and the registers by pulling the HWEN pin to ground.

Control is done via an I²C-compatible interface. This includes adjustment of the Flash and Torch current levels, changing the Flash Timeout Duration, and changing the switch current limit. Additionally, there are flag and status bits that indicate flash current time-out, LED overtemperature condition, LED failure (open/short), device thermal shutdown, TX interrupt, and V_{IN} undervoltage conditions.

7.2 Functional Block Diagram

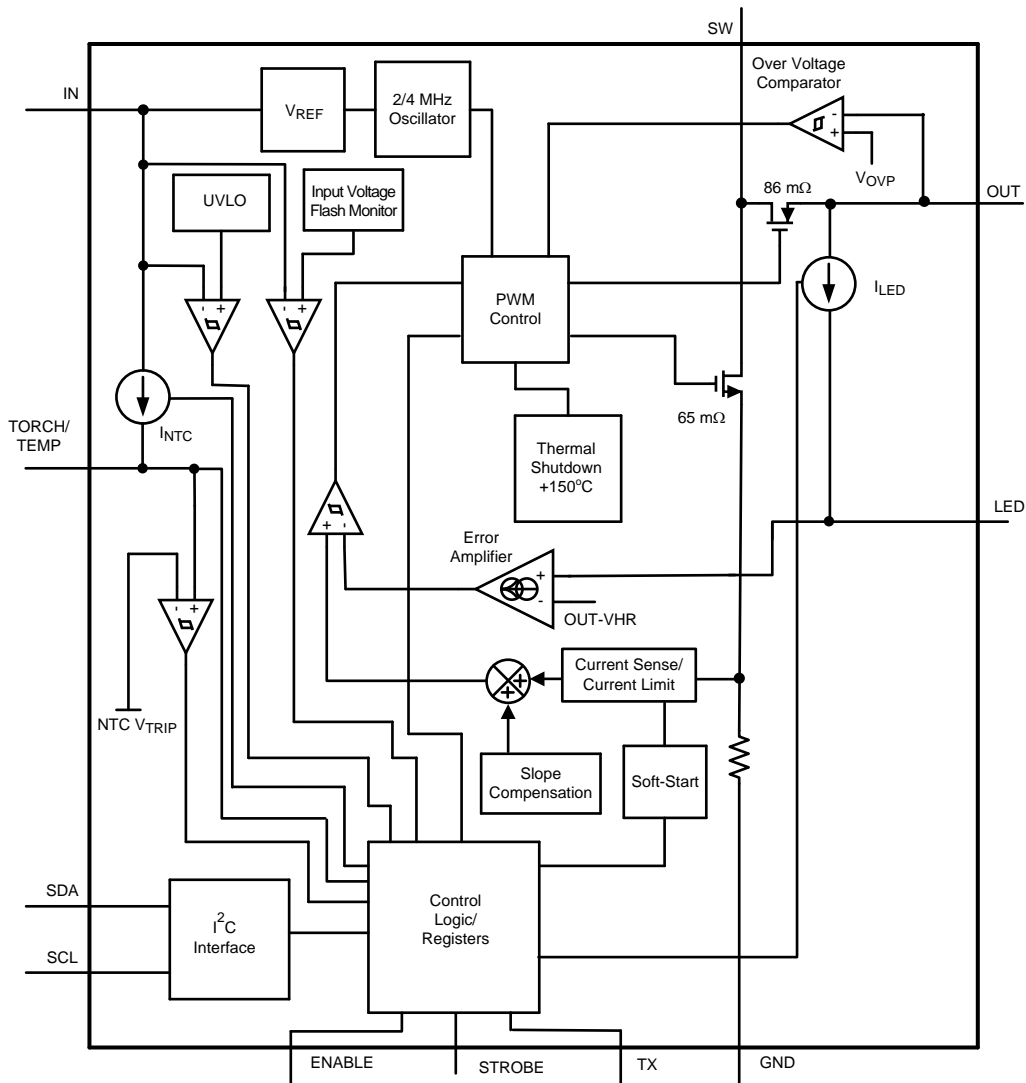

7.3 Feature Description

7.3.1 Flash Mode

In Flash Mode, the LED current source (LED) provides 64 target current levels from 21.8 mA to 1500 mA. Once the Flash sequence is activated the current source (LED) ramps up to the programmed Flash current by stepping through all current steps until the programmed current is reached. The headroom in the current source can be regulated to provide 21.8 mA to 1.5 A.

When the device is enabled in Flash Mode through the Enable Register, all mode bits in the Enable Register are cleared after a flash time-out event.

Feature Description (continued)

7.3.2 Torch Mode

In Torch mode, the LED current source (LED) provide 128 target current levels from 1.954 mA to 358 mA or 3.908 mA to 502.308 mA on LM3648TT. The Torch current is adjusted via the LED Torch Brightness Register. Torch mode is activated by the Enable Register (setting M1, M0 to '10'), or by pulling the TORCH/TEMP pin HIGH when the pin is enabled (Enable Register) and set to Torch Mode. Once the TORCH sequence is activated the active current source (LED) ramps up to the programmed Torch current by stepping through all current steps until the programmed current is reached. The rate at which the current ramps is determined by the value chosen in the Timing Register.

Torch Mode is not affected by Flash Timeout or by a TX Interrupt event.

7.3.3 IR Mode

In IR Mode, the target LED current is equal to the value stored in the LED Flash Brightness Registers. When IR mode is enabled (setting M1, M0 to '01'), the boost converter turns on and sets the output equal to the input (pass-mode). At this point, toggling the STROBE pin enables and disables the LED current source (if enabled). The STROBE pin can only be set to be Level sensitive, meaning all timing of the IR pulse is externally controlled. In IR Mode, the current source does not ramp the LED output to the target. The current transitions immediately from off to on and then on to off.

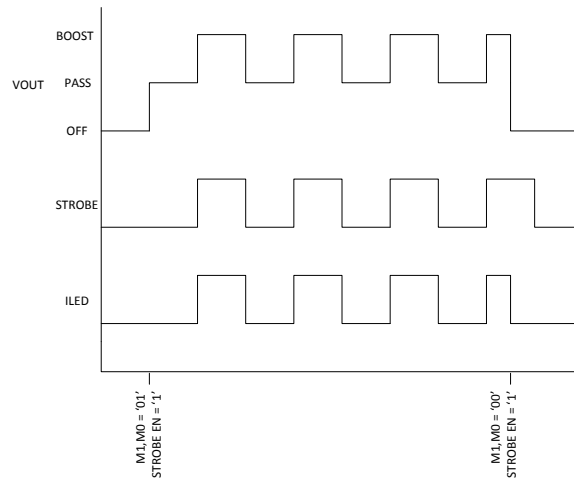

Figure 22. IR Mode with Boost

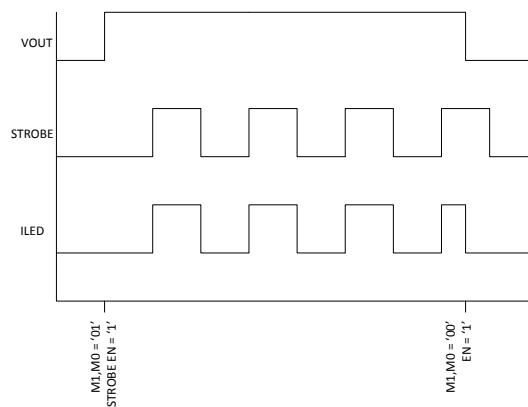

Figure 23. IR Mode Pass Only

Feature Description (continued)

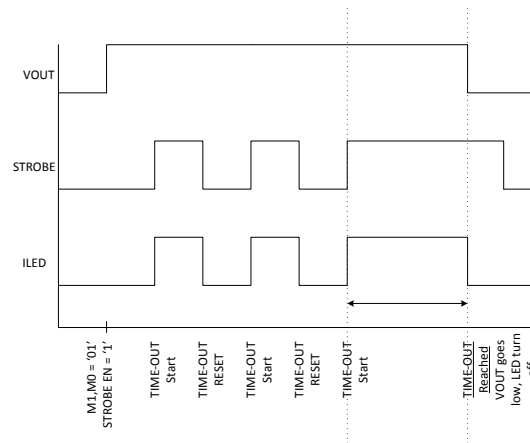

Figure 24. IR Mode Timeout

7.4 Device Functioning Modes

7.4.1 Start-Up (Enabling The Device)

Turnon of the LM3648 Torch and Flash modes can be done through the Enable Register. On start-up, when V_{OUT} is less than V_{IN} the internal synchronous PFET turns on as a current source and delivers 200 mA (typ.) to the output capacitor. During this time the current source (LED) is off. When the voltage across the output capacitor reaches 2.2 V (typ.), the current source turns on. At turnon the current source steps through each FLASH or TORCH level until the target LED current is reached. This gives the device a controlled turnon and limits inrush current from the V_{IN} supply.

7.4.2 Pass Mode

The LM3648 starts up in Pass Mode and stays there until Boost Mode is needed to maintain regulation. If the voltage difference between V_{OUT} and V_{LED} falls below V_{HR} , the device switches to Boost Mode. In Pass Mode the boost converter does not switch, and the synchronous PFET turns fully on bringing V_{OUT} up to $V_{IN} - I_{LED} \times R_{PMOS}$. In Pass Mode the inductor current is not limited by the peak current limit.

7.4.3 Power Amplifier Synchronization (TX)

The TX pin is a Power Amplifier Synchronization input. This is designed to reduce the flash LED current and thus limit the battery current during high battery current conditions such as PA transmit events. When the LM3648 is engaged in a Flash event, and the TX pin is pulled high, the LED current is forced into Torch Mode at the programmed Torch current setting. If the TX pin is then pulled low before the Flash pulse terminates, the LED current returns to the previous Flash current level. At the end of the Flash time-out, whether the TX pin is high or low, the LED current turns off.

7.4.4 Input Voltage Flash Monitor (IVFM)

The LM3648 has the ability to adjust the flash current based upon the voltage level present at the IN pin utilizing the Input Voltage Flash Monitor (IVFM). The adjustable threshold IVFM-D ranges from 2.9 V to 3.6 V in 100-mV steps, with three different usage modes (Stop and Hold, Adjust Down Only, Adjust Up and Down). The Flags2 Register has the IVFM flag bit set when the input voltage crosses the IVFM-D value. Additionally, the IVFM-D threshold sets the input voltage boundary that forces the LM3648 to either stop ramping the flash current during start-up (Stop and Hold Mode) or to start decreasing the LED current during the flash (Down Adjust Only and Up and Down Adjust). In Adjust Up and Down mode, the IVFM-D value plus the hysteresis voltage threshold set the input voltage boundary that forces the LM3648 to start ramping the flash current back up towards the target.

Device Functioning Modes (continued)

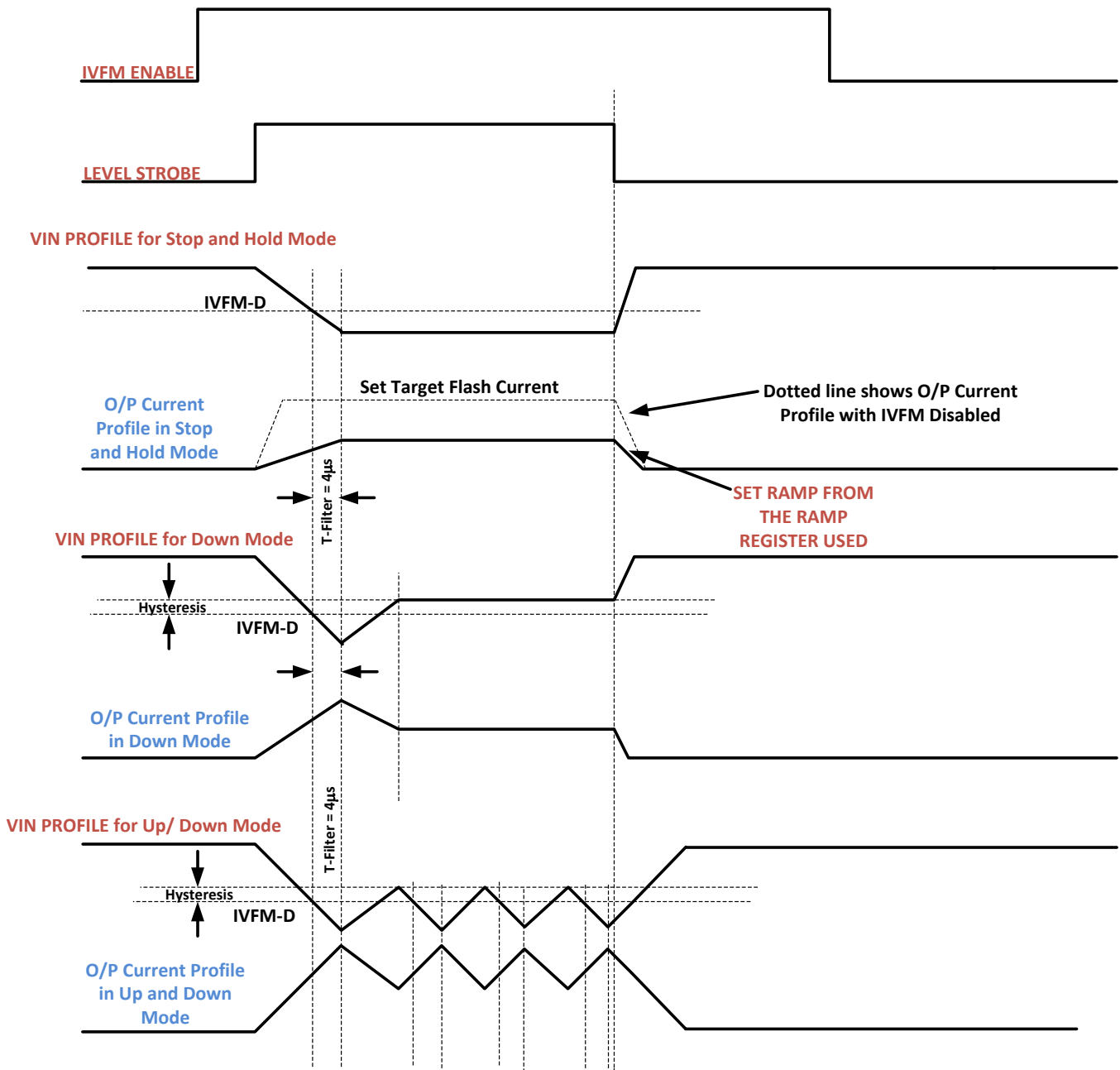

Figure 25. IVFM Modes

Device Functioning Modes (continued)

7.4.5 Fault/Protections

7.4.5.1 Fault Operation

If the LM3648 enters a fault condition, the device sets the appropriate flag in the Flags1 and Flags2 Registers (0x0A and 0x0B), and places the device into standby by clearing the Mode Bits ([1],[0]) in the Enable Register. The LM3648 remains in standby until an I²C read of the Flags1 and Flags2 Registers are completed. Upon clearing the flags/faults, the device can be restarted (Flash, Torch, IR, etc.). If the fault is still present, the LM3648 re-enters the fault state and enters standby again.

7.4.5.2 Flash Time-Out

The Flash Time-Out period sets the amount of time that the Flash Current is being sourced from the current source (LED). The LM3648 has 16 timeout levels ranging from 10 ms to 400 ms or 40 ms (see [Timing Configuration Register \(0x08\)](#) for more detail).

7.4.5.3 Overvoltage Protection (OVP)

The output voltage is limited to typically 5 V (see V_{OVP} spec in the [Electrical Characteristics](#)). In situations such as an open LED, the LM3648 raises the output voltage in order to keep the LED current at its target value. When V_{OUT} reaches 5 V (typical), the overvoltage comparator trips and turns off the internal NFET. When V_{OUT} falls below the “ V_{OVP} Off Threshold”, the LM3648 begins switching again. The mode bits are cleared, and the OVP flag is set, when an OVP condition is present for three rising OVP edges. This prevents momentary OVP events from forcing the device to shut down.

7.4.5.4 Current Limit

The LM3648 features two selectable inductor current limits that are programmable through the I²C-compatible interface. When the inductor current limit is reached, the LM3648 terminates the charging phase of the switching cycle. Switching resumes at the start of the next switching period. If the overcurrent condition persists, the device operates continuously in current limit.

Because the current limit is sensed in the NMOS switch, there is no mechanism to limit the current when the device operates in Pass Mode (current does not flow through the NMOS in pass mode). In Boost mode or Pass mode if V_{OUT} falls below 2.3 V, the device stops switching, and the PFET operates as a current source limiting the current to 200 mA. This prevents damage to the LM3648 and excessive current draw from the battery during output short-circuit conditions. The mode bits are not cleared upon a Current Limit event, but a flag is set.

7.4.5.5 NTC Thermistor Input (Torch/Temp)

The TORCH/TEMP pin, when set to TEMP mode, serves as a threshold detector and bias source for negative temperature coefficient (NTC) thermistors. When the voltage at TEMP goes below the programmed threshold, the LM3648 is placed into standby mode. The NTC threshold voltage is adjustable from 200 mV to 900 mV in 100-mV steps. The NTC bias current is set to 50 μ A. The NTC detection circuitry can be enabled or disabled via the Enable Register. If enabled, the NTC block turns on and off during the start and stop of a Flash/Torch event.

Additionally, the NTC input looks for an open NTC connection and a shorted NTC connection. If the NTC input falls below 100 mV, the NTC short flag is set, and the device is disabled. If the NTC input rises above 2.3 V, the NTC Open flag is set, and the device is disabled. These fault detections can be individually disabled/enabled via the NTC Open Fault Enable bit and the NTC Short Fault Enable bit.

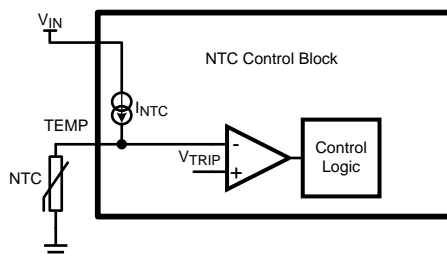

Figure 26. Temp Detection Diagram

Device Functioning Modes (continued)

7.4.5.6 Undervoltage Lockout (UVLO)

The LM3648 has an internal comparator that monitors the voltage at IN and forces the LM3648 into standby if the input voltage drops to 2.5 V. If the UVLO monitor threshold is tripped, the UVLO flag bit is set in the Flags1 Register (0x0A). If the input voltage rises above 2.5 V, the LM3648 is not available for operation until there is an I²C read of the Flags1 Register (0x0A). Upon a read, the Flags1 register is cleared, and normal operation can resume if the input voltage is greater than 2.5 V.

7.4.5.7 Thermal Shutdown (TSD)

When the LM3648 die temperature reaches 150°C, the thermal shutdown detection circuit trips, forcing the LM3648 into standby and writing a '1' to the corresponding bit of the Flags1 Register (0x0A) (Thermal Shutdown bit). The LM3648 is only allowed to restart after the Flags1 Register (0x0A) is read, clearing the fault flag. Upon restart, if the die temperature is still above 150°C, the LM3648 resets the Fault flag and re-enters standby.

7.4.5.8 LED and/or V_{OUT} Short Fault

The LED Fault flags read back a '1' if the device is active in Flash or Torch mode and the LED output experiences a short condition. The Output Short Fault flag reads back a '1' if the device is active in Flash or Torch mode and the boost output experiences a short condition. An LED short condition is determined if the voltage at LED goes below 500 mV (typ.) while the device is in Torch or Flash mode. There is a deglitch time of 256 μs before the LED Short flag is valid, and a deglitch time of 2.048 ms before the V_{OUT} Short flag is valid. The LED Short Faults can be reset to '0' by removing power to the LM3648, setting HWEN to '0', setting the SW RESET bit to a '1', or by reading back the Flags1 Register (0x0A on LM3648). The mode bits are cleared upon an LED and/or V_{OUT} short fault.

7.5 Programming

7.5.1 Control Truth Table

MODE1	MODE0	STROBE EN	TORCH EN	STROBE PIN	TORCH PIN	ACTION
0	0	0	0	X	X	Standby
0	0	0	1	X	pos edge	Ext Torch
0	0	1	0	pos edge	X	Ext Flash
0	0	1	1	0	pos edge	Standalone Torch
0	0	1	1	pos edge	0	Standalone Flash
0	0	1	1	pos edge	pos edge	Standalone Flash
1	0	X	X	X	X	Int Torch
1	1	X	X	X	X	Int Flash
0	1	0	X	X	X	IRLED Standby
0	1	1	X	0	X	IRLED Standby
0	1	1	X	pos edge	X	IRLED enabled

7.5.2 I²C-Compatible Interface

7.5.2.1 Data Validity

The data on SDA must be stable during the HIGH period of the clock signal (SCL). In other words, the state of the data line can only be changed when SCL is LOW.

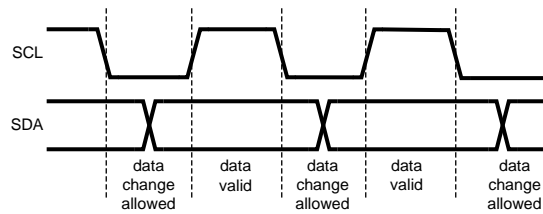

Figure 27. Data Validity Data

A pullup resistor between the controller's VIO line and SDA must be greater than $[(VIO - V_{OL}) / 3mA]$ to meet the V_{OL} requirement on SDA. Using a larger pullup resistor results in lower switching current with slower edges, while using a smaller pullup results in higher switching currents with faster edges.

7.5.2.2 Start and Stop Conditions

START and STOP conditions classify the beginning and the end of the I²C session. A START condition is defined as the SDA signal transitioning from HIGH to LOW while SCL line is HIGH. A STOP condition is defined as the SDA transitioning from LOW to HIGH while SCL is HIGH. The I²C master always generates START and STOP conditions. The I²C bus is considered busy after a START condition and free after a STOP condition. During data transmission, the I²C master can generate repeated START conditions. First START and repeated START conditions are equivalent, function-wise.

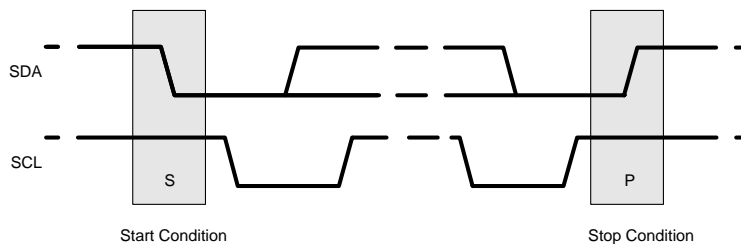

Figure 28. Start and Stop Conditions

7.5.2.3 Transferring Data

Every byte put on the SDA line must be eight bits long, with the most significant bit (MSB) transferred first. Each byte of data has to be followed by an acknowledge bit. The acknowledge related clock pulse is generated by the master. The master releases the SDA line (HIGH) during the acknowledge clock pulse. The LM3648 pulls down the SDA line during the 9th clock pulse, signifying an acknowledge. The LM3648 generates an acknowledge after each byte is received. There is no acknowledge created after data is read from the device.

After the START condition, the I²C master sends a chip address. This address is seven bits long followed by an eighth bit which is a data direction bit (R/W). The LM3648 7-bit address is 0x63. For the eighth bit, a '0' indicates a WRITE and a '1' indicates a READ. The second byte selects the register to which the data is written. The third byte contains data to write to the selected register.

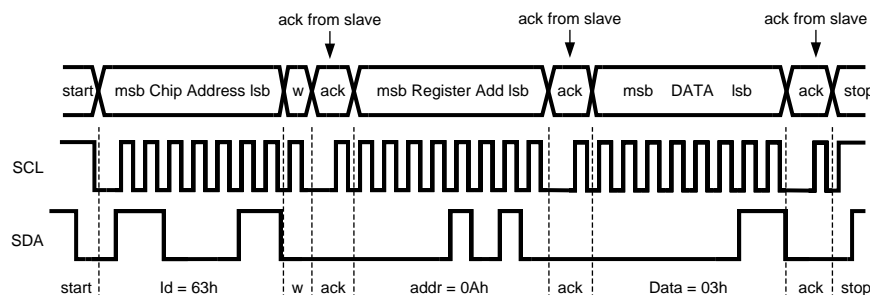

Figure 29. Write Cycle W = Write (SDA = "0") R = Read (SDA = "1") Ack = Acknowledge (SDA Pulled Down by Either Master or Slave) ID = Chip Address, 63h for LM3648

7.5.2.4 I²C-Compatible Chip Address

The device address for the LM3648 is 1100011 (0x63). After the START condition, the I²C-compatible master sends the 7-bit address followed by an eighth read or write bit (R/W). R/W = 0 indicates a WRITE and R/W = 1 indicates a READ. The second byte following the device address selects the register address to which the data is written. The third byte contains the data for the selected register.

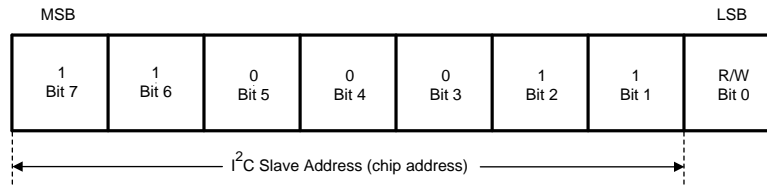

Figure 30. I²C-Compatible Chip Address

7.6 Register Descriptions

REGISTER NAME	INTERNAL HEX ADDRESS	POWER ON/RESET VALUE
		LM3648
Enable Register	0x01	0x80
IVFM Register	0x02	0x01
LED Flash Brightness Register	0x03	0xBF
LED Torch Brightness Register	0x05	0xBF
Boost Configuration Register	0x07	0x09
Timing Configuration Register	0x08	0x1A
TEMP Register	0x09	0x08
Flags1 Register	0x0A	0x00
Flags2 Register	0x0B	0x00
Device ID Register	0x0C	0x02 or 0x04 for LM3648TT
Last Flash Register	0x0D	0x00

7.6.1 Enable Register (0x01)

Bit 7	Bit 6	Bit 5	Bit 4	Bit 3	Bit 2	Bit 1	Bit 0
TX Pin Enable 0 = Disabled 1 = Enabled (Default)	Strobe Type 0 = Level Triggered (Default) 1 = Edge Triggered	Strobe Enable 0 = Disabled (Default) 1 = Enabled	TORCH/TEMP Pin Enable 0 = Disabled (Default) 1 = Enabled	Mode Bits: M1, M0 '00' = Standby (Default) '01' = IR Drive '10' = Torch '11' = Flash		LED Enable 00 = OFF (Default) 11 = ON 01 and 10 are not valid settings	

NOTE

Edge Strobe Mode is not valid in IR MODE. Switching between Level and Edge Strobe Types while the device is enabled is not recommended.

In Edge or Level Strobe Mode, it is recommended that the trigger pulse width be set greater than 1 ms to ensure proper turn-on of the device.

7.6.2 IVFM Register (0x02)

Bit 7	Bit 6	Bit 5	Bit 4	Bit 3	Bit 2	Bit 1	Bit 0
RFU	UVLO Circuitry (Default) 0 = Disabled (Default) 1 = Enabled	IVFM Levels 000 = 2.9 V (Default) 001 = 3 V 010 = 3.1 V 011 = 3.2 V 100 = 3.3 V 101 = 3.4 V 110 = 3.5 V 111 = 3.6 V			IVFM Hysteresis 0 = 0 mV (Default) 1 = 50 mV	IVFM Selection 00 = Disabled 01 = Stop and Hold Mode (Default) 10 = Down Mode 11 = Up and Down Mode	

NOTE

IVFM Mode Bits are static once the LM3648 is enabled in Torch, Flash or IR modes. If the IVFM mode needs to be updated, disable the device and then change the mode bits to the desired state.

7.6.3 LED Flash Brightness Register (0x03)

Bit 7	Bit 6	Bit 5	Bit 4	Bit 3	Bit 2	Bit 1	Bit 0
MUST BE SET TO '10' FOR PROPER OPERATION		LED Flash Brightness Level $I_{FLASH} \text{ (mA)} \approx (\text{Brightness Code} \times 23.45 \text{ mA}) + 21.8 \text{ mA}$ 000000 = 21.8 mA 011111 = 748.75 mA 111111 = 1.5 A (Default)					

7.6.4 LED Torch Brightness Register (0x05)

Bit 7	Bit 6	Bit 5	Bit 4	Bit 3	Bit 2	Bit 1	Bit 0
MUST BE SET TO '1' FOR PROPER OPERATION		LED Torch Brightness Levels $I_{TORCH} \text{ (mA)} \approx (\text{Brightness Code} \times 2.8 \text{ mA}) + 1.954 \text{ mA}$ or $I_{TORCH} \text{ (mA)} \approx (\text{Brightness Code} \times 5.6 \text{ mA}) + 3.908 \text{ mA}$ 0000000 = 1.954 mA or 3.908 mA for LM3648TT 0111111 = 178.35 mA (Default) or 356.71 mA for LM3648TT 1011001 = 251.15 mA or 502.31 mA for LM3648TT 1111111 = 357.6 mA					

NOTE

Maximum Torch Brightness Code allowed for the LM3648TT is 0x59 (1011001), which results in 502.31 mA current setting. Higher settings may result in over-heating and potentially damaging the device.

7.6.5 Boost Configuration Register (0x07)

Bit 7	Bit 6	Bit 5	Bit 4	Bit 3	Bit 2	Bit 1	Bit 0
Software Reset Bit 0 = Not Reset (Default) 1 = Reset	RFU	RFU	RFU	LED Pin Short Fault Detect 0 = Disabled (Default) 1 = Enabled (Default)	Boost Mode 0 = Normal (Default) 1 = Pass Mode Only	Boost Frequency Select 0 = 2 MHz (Default) 1 = 4 MHz	Boost Current Limit Setting 0 = 1.9 A (Default) 1 = 2.8 A (Default)

7.6.6 Timing Configuration Register (0x08)

Bit 7	Bit 6	Bit 5	Bit 4	Bit 3	Bit 2	Bit 1	Bit 0
RFU	Torch Current Ramp Time 000 = No Ramp 001 = 1 ms (Default) 010 = 32 ms 011 = 64 ms 100 = 128 ms 101 = 256 ms 110 = 512 ms 111 = 1024 ms			Flash Time-Out Duration 0000 = 10 ms or 40 ms (LM3648TT) 0001 = 20 ms or 80 ms (LM3648TT) 0010 = 30 ms or 120 ms (LM3648TT) 0011 = 40 ms or 160 ms (LM3648TT) 0100 = 50 ms or 200 ms (LM3648TT) 0101 = 60 ms or 240 ms (LM3648TT) 0110 = 70 ms or 280 ms (LM3648TT) 0111 = 80 ms or 320 ms (LM3648TT) 1000 = 90 ms or 360 ms (LM3648TT) 1001 = 100 ms or 400 ms (LM3648TT) 1010 = 150 ms (Default) or 600 ms (LM3648TT) 1011 = 200 ms or 800 ms (LM3648TT) 1100 = 250 ms or 1000 ms (LM3648TT) 1101 = 300 ms or 1200 ms (LM3648TT) 1110 = 350 ms or 1400 ms (LM3648TT) 1111 = 400 ms or 1600 ms (LM3648TT)			

NOTE

On the LM3648TT, special care must be taken with regards to thermal management when using time-out values greater than 400 ms. Depending on the PCB layout, input voltage, and output current, it is possible to have the internal thermal shutdown circuit trip prior to reaching the desired flash time-out value.

7.6.7 TEMP Register (0x09)

Bit 7	Bit 6	Bit 5	Bit 4	Bit 3	Bit 2	Bit 1	Bit 0
RFU	TORCH Polarity 0 = Active High (Default) (Pull-down Resistor Enabled) 1 = Active Low (Pull-down Resistor Disabled)	NTC Open Fault Enable 0 = Disabled (Default) 1 = Enable	NTC Short Fault Enable 0 = Disabled (Default) 1 = Enable	TEMP Detect Voltage Threshold 000 = 0.2 V 001 = 0.3 V 010 = 0.4 V 011 = 0.5 V 100 = 0.6 V (Default) 101 = 0.7 V 110 = 0.8 V 111 = 0.9 V		TORCH/TEMP Function Select 0 = TORCH (Default) 1 = TEMP	

NOTE

The Torch Polarity bit is static once the LM3648 is enabled in Torch, Flash, or IR modes. If the Torch Polarity bit needs to be updated, disable the device and then change the Torch Polarity bit to the desired state.

7.6.8 Flags1 Register (0x0A)

Bit 7	Bit 6	Bit 5	Bit 4	Bit 3	Bit 2	Bit 1	Bit 0
TX Flag	V _{OUT} Short Fault	VLED Short Fault	VLED Short Fault	Current Limit Flag	Thermal Shutdown (TSD) Fault	UVLO Fault	Flash Time-Out Flag

7.6.9 Flags2 Register (0x0B)

Bit 7	Bit 6	Bit 5	Bit 4	Bit 3	Bit 2	Bit 1	Bit 0
RFU	RFU	RFU	NTC Short Fault	NTC Open Fault	IVFM Trip Flag	OVP Fault	TEMP Trip Fault

7.6.10 Device ID Register (0x0C)

Bit 7	Bit 6	Bit 5	Bit 4	Bit 3	Bit 2	Bit 1	Bit 0
RFU	RFU	Device ID '000'			Silicon Revision Bits '010' or '100' for LM3648TT		

7.6.11 Last Flash Register (0x0D)

Bit 7	Bit 6	Bit 5	Bit 4	Bit 3	Bit 2	Bit 1	Bit 0
RFU	The value stored is always the last current value the IVFM detection block set. $I_{LED} = I_{FLASH-TARGET} \times ((Code + 1) / 128)$						

8 Applications and Implementation

NOTE

Information in the following applications sections is not part of the TI component specification, and TI does not warrant its accuracy or completeness. TI's customers are responsible for determining suitability of components for their purposes. Customers should validate and test their design implementation to confirm system functionality.

8.1 Application Information

The LM3648 can drive a flash LED at currents up to 1.5 A. The 2-MHz or 4-MHz DC-DC boost regulator allows for the use of small value discrete external components.

8.2 Typical Application

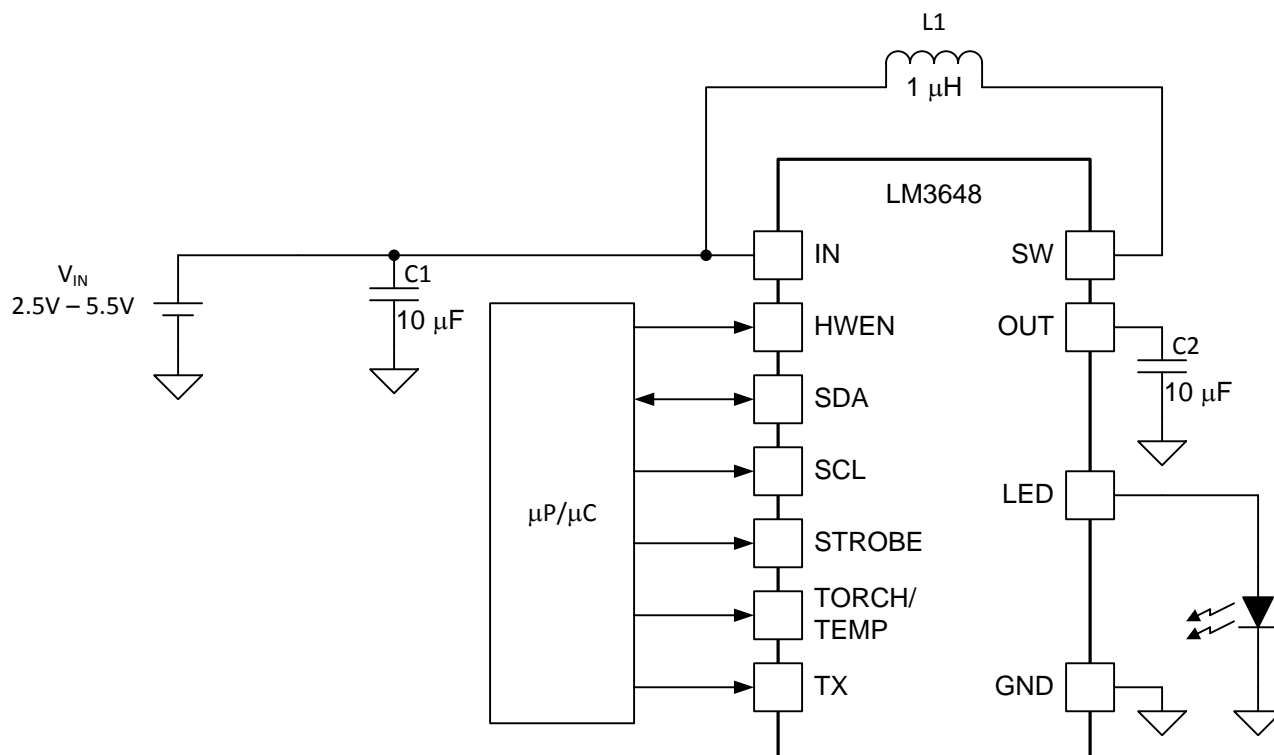

Figure 31. LM3648 Typical Application

8.2.1 Design Requirements

Example requirements based on default register values:

Table 1. Design Parameters

DESIGN PARAMETER	EXAMPLE VALUE
Input Voltage Range	2.5 V to 5.5 V
Brightness Control	I ² C Register
LED Configuration	1 Flash LED
Boost Switching Frequency	2 MHz (4 MHz selectable)
Flash Brightness	1.5-A Max Current

8.2.2 Detailed Design Procedure

8.2.2.1 Output Capacitor Selection

The LM3648 is designed to operate with a 10- μ F ceramic output capacitor. When the boost converter is running, the output capacitor supplies the load current during the boost converter on-time. When the NMOS switch turns off, the inductor energy is discharged through the internal PMOS switch, supplying power to the load and restoring charge to the output capacitor. This causes a sag in the output voltage during the on-time and a rise in the output voltage during the off-time. The output capacitor is therefore chosen to limit the output ripple to an acceptable level depending on load current and input or output voltage differentials and also to ensure the converter remains stable.

Larger capacitors such as a 22- μ F or capacitors in parallel can be used if lower output voltage ripple is desired. To estimate the output voltage ripple considering the ripple due to capacitor discharge (ΔV_Q) and the ripple due to the capacitors ESR (ΔV_{ESR}) use the following equations:

For continuous conduction mode, the output voltage ripple due to the capacitor discharge is:

$$\Delta V_Q = \frac{I_{LED} \times (V_{OUT} - V_{IN})}{f_{SW} \times V_{OUT} \times C_{OUT}} \quad (1)$$

The output voltage ripple due to the output capacitors ESR is found by:

$$\Delta V_{ESR} = R_{ESR} \times \left(\frac{I_{LED} \times V_{OUT}}{V_{IN}} + \Delta I_L \right)$$

where

$$\Delta I_L = \frac{V_{IN} \times (V_{OUT} - V_{IN})}{2 \times f_{SW} \times L \times V_{OUT}} \quad (2)$$

In ceramic capacitors the ESR is very low so the assumption is that 80% of the output voltage ripple is due to capacitor discharge and 20% from ESR. [Table 2](#) lists different manufacturers for various output capacitors and their case sizes suitable for use with the LM3648.

8.2.2.2 Input Capacitor Selection

Choosing the correct size and type of input capacitor helps minimize the voltage ripple caused by the switching of the LM3648 boost converter and reduce noise on the boost converter's input pin that can feed through and disrupt internal analog signals. In the typical application circuit a 10- μ F ceramic input capacitor works well. It is important to place the input capacitor as close as possible to the LM3648 input (IN) pin. This reduces the series resistance and inductance that can inject noise into the device due to the input switching currents. [Table 2](#) lists various input capacitors recommended for use with the LM3648.

Table 2. Recommended Input/Output Capacitors (X5R/X7R Dielectric)

MANUFACTURER	PART NUMBER	VALUE	CASE SIZE	VOLTAGE RATING
TDK Corporation	C1608JB0J106M	10 μ F	0603 (1.6 mm \times 0.8 mm \times 0.8 mm)	6.3 V
TDK Corporation	C2012JB1A106M	10 μ F	0805 (2.0 mm \times 1.25 mm \times 1.25 mm)	10 V
Murata	GRM188R60J106M	10 μ F	0603 (1.6 mm \times 0.8 mm \times 0.8 mm)	6.3 V
Murata	GRM21BR61A106KE19	10 μ F	0805 (2.0 mm \times 1.25 mm \times 1.25 mm)	10 V

8.2.2.3 Inductor Selection

The LM3648 is designed to use a 0.47- μ H or 1- μ H inductor. [Table 3](#) lists various inductors and their manufacturers that work well with the LM3648. When the device is boosting ($V_{OUT} > V_{IN}$) the inductor is typically the largest area of efficiency loss in the circuit. Therefore, choosing an inductor with the lowest possible series resistance is important. Additionally, the saturation rating of the inductor must be greater than the maximum operating peak current of the LM3648. This prevents excess efficiency loss that can occur with inductors that operate in saturation. For proper inductor operation and circuit performance, ensure that the inductor saturation and the peak current limit setting of the LM3648 are greater than I_{PEAK} in [Equation 3](#):

$$I_{PEAK} = \frac{I_{LOAD}}{\eta} \times \frac{V_{OUT}}{V_{IN}} + \Delta I_L \quad \text{where} \quad \Delta I_L = \frac{V_{IN} \times (V_{OUT} - V_{IN})}{2 \times f_{SW} \times L \times V_{OUT}}$$

where

- $f_{SW} = 2$ or 4 MHz

(3)

Efficiency details can be found in the [Application Curves](#).

Table 3. Recommended Inductors

MANUFACTURER	L	PART NUMBER	DIMENSIONS (LxWxH)	I _{SAT}	R _{DC}
TOKO	0.47 μH	DFE201610P-R470M	2.0 mm x 1.6 mm x 1.0 mm	4.1 A	32 mΩ
TOKO	1 μH	DFE201610P-1R0M	2.0 mm x 1.6 mm x 1.0 mm	3.7 A	58 mΩ

8.2.3 Application Curves

Ambient temperature is 25°C, input voltage is 3.6 V, HWEN = V_{IN}, C_{IN} = 2 × 10 μF, C_{OUT} = 2 × 10 μF and L = 1 μH, unless otherwise noted.

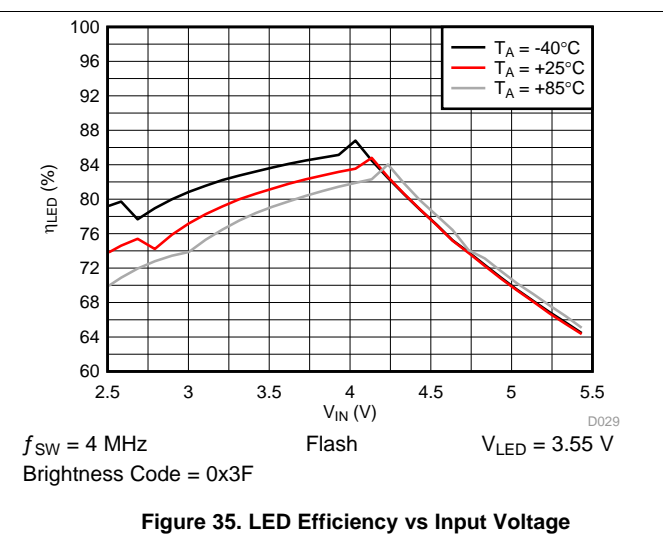
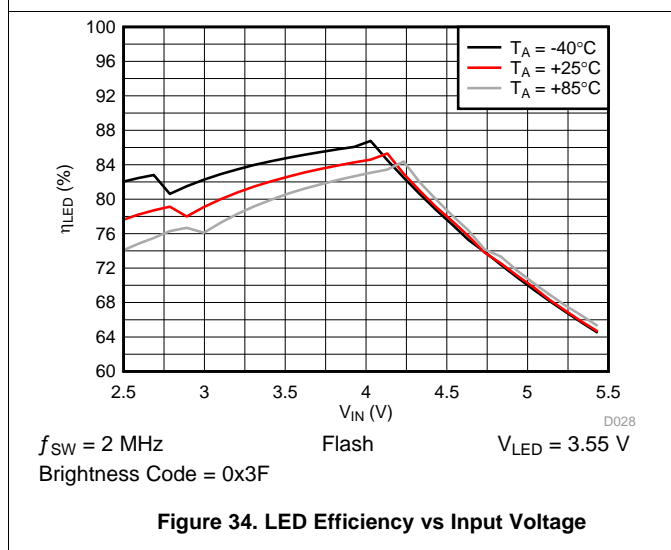
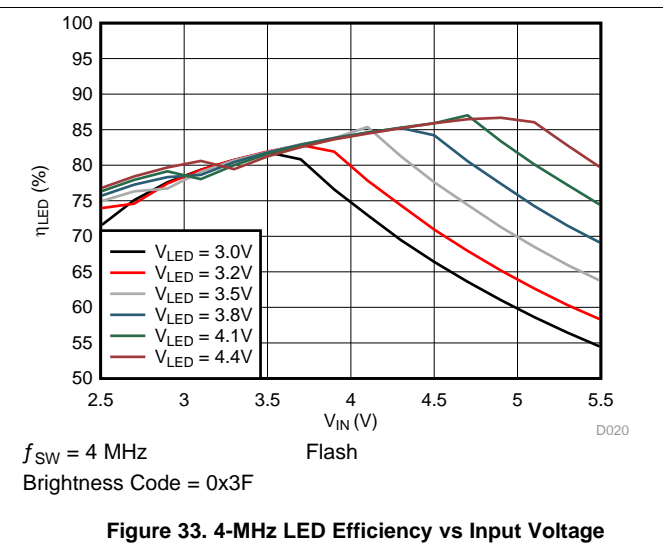
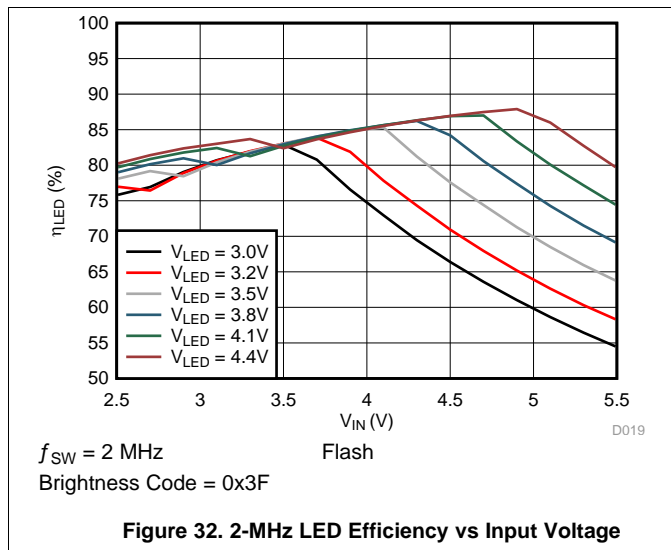

Ambient temperature is 25°C, input voltage is 3.6 V, $H_{WEN} = V_{IN}$, $C_{IN} = 2 \times 10 \mu F$, $C_{OUT} = 2 \times 10 \mu F$ and $L = 1 \mu H$, unless otherwise noted.

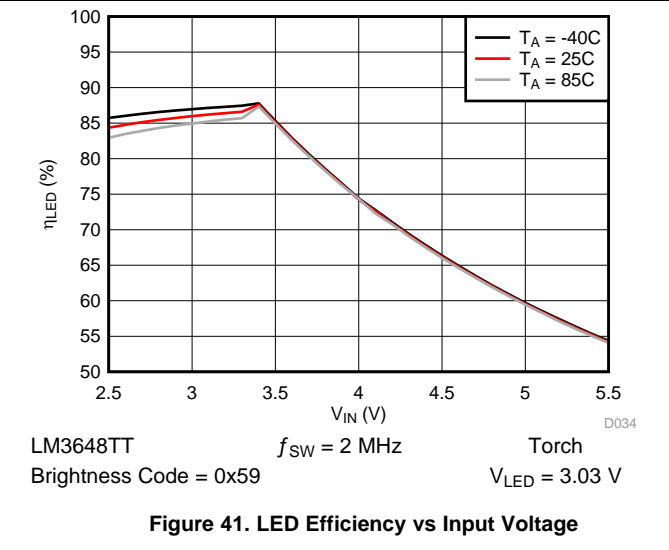
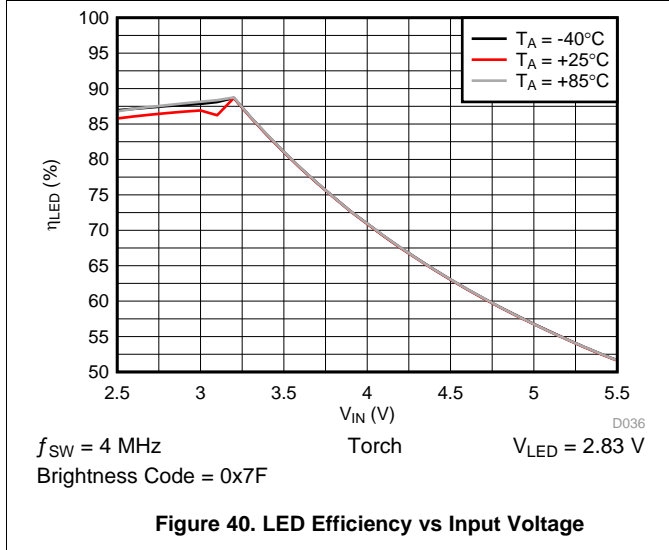
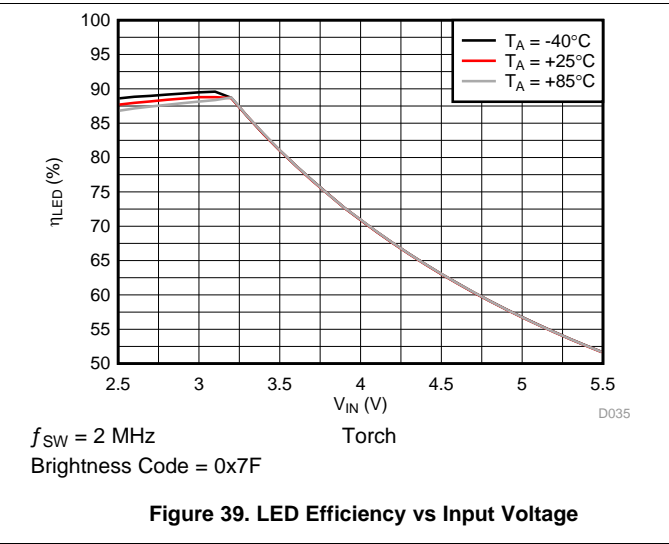
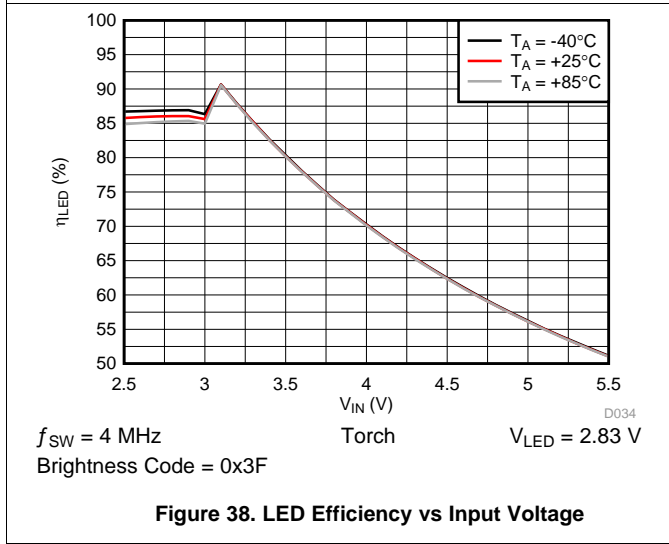
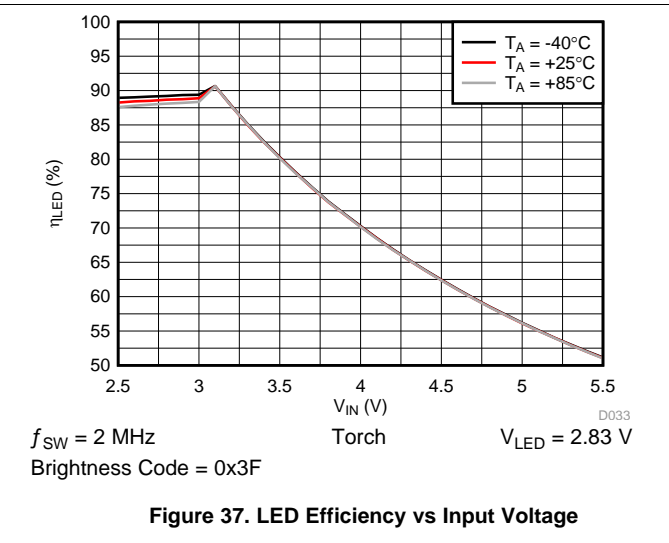
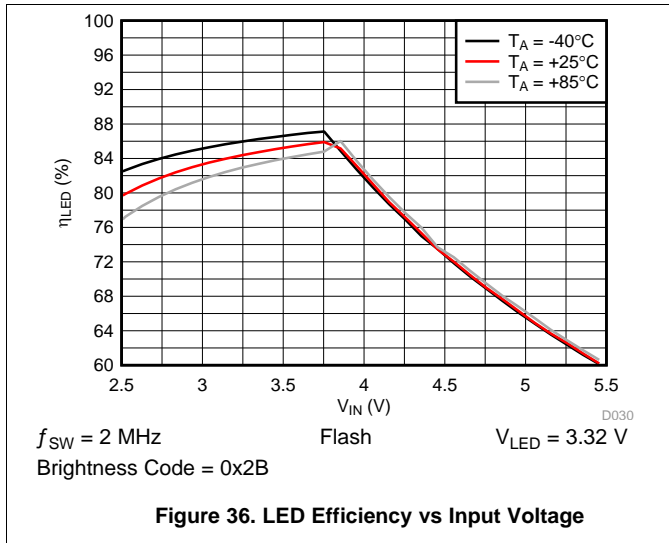

LM3648, LM3648TT

SNVSA68D – OCTOBER 2014 – REVISED NOVEMBER 2016

www.ti.com

Ambient temperature is 25°C, input voltage is 3.6 V, HWEN = V_{IN}, C_{IN} = 2 × 10 μF, C_{OUT} = 2 × 10 μF and L = 1 μH, unless otherwise noted.

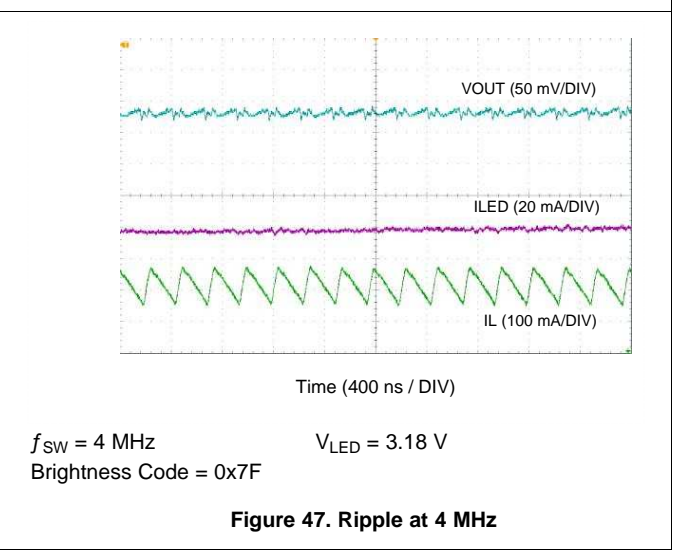
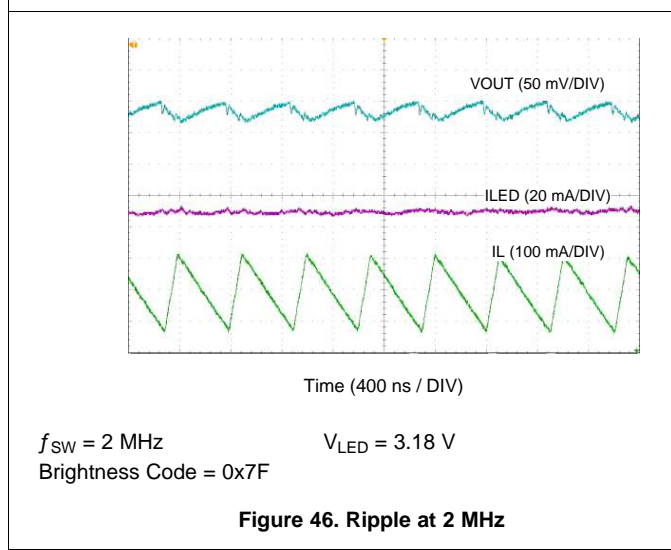
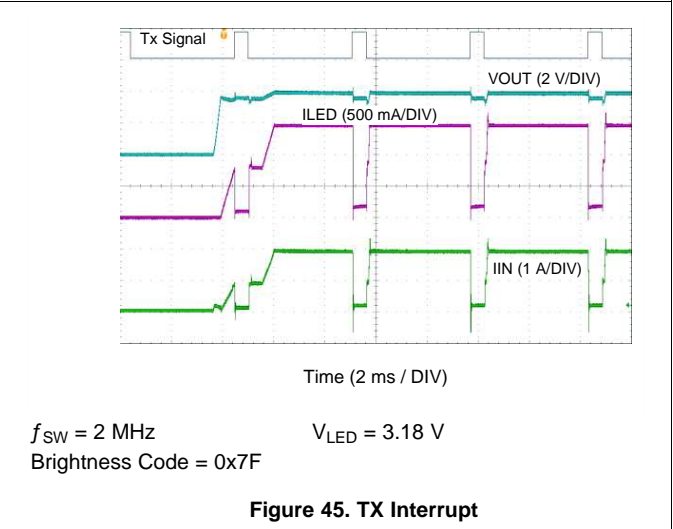
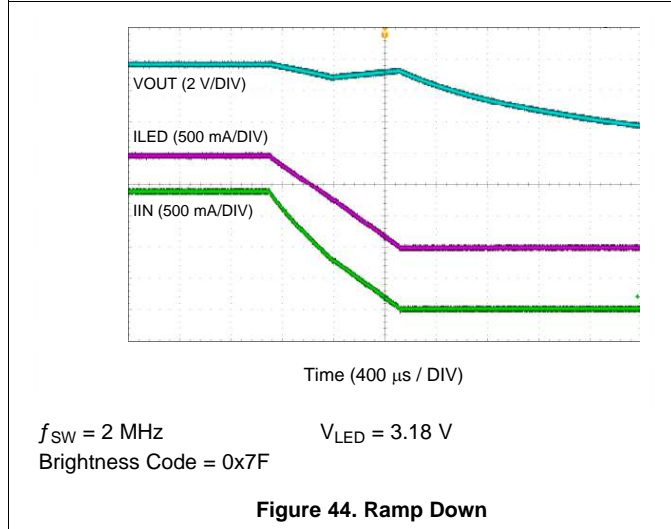
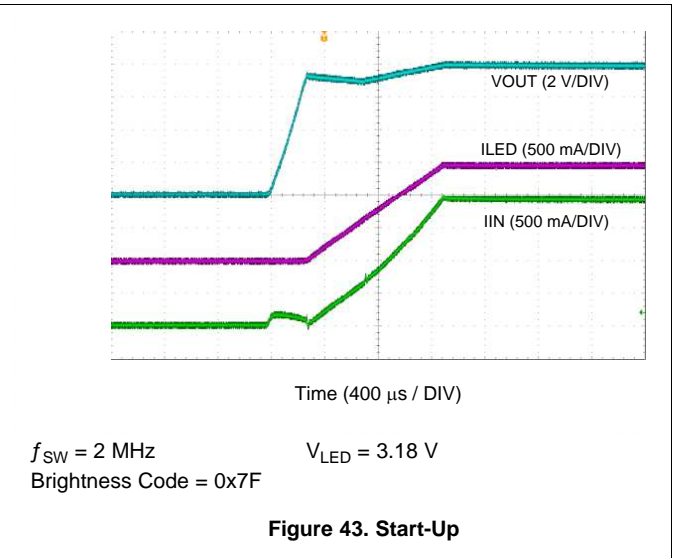
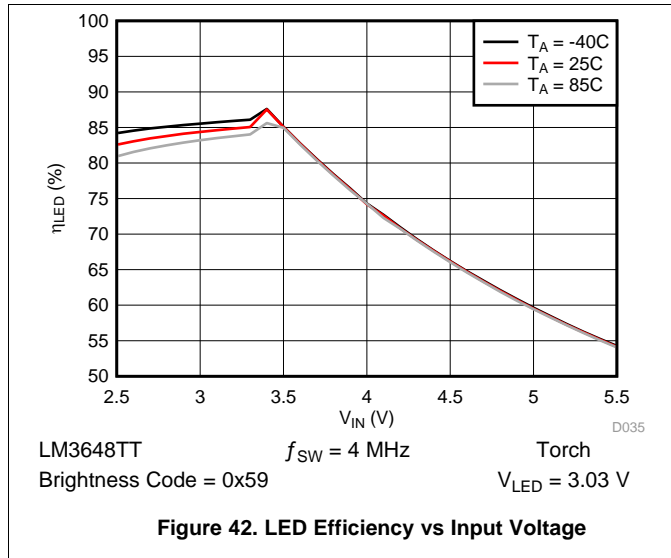

9 Power Supply Recommendations

The LM3648 is designed to operate from an input voltage supply range between 2.5 V and 5.5 V. This input supply must be well regulated and capable to supply the required input current. If the input supply is located far from the LM3648 additional bulk capacitance may be required in addition to the ceramic bypass capacitors.

10 Layout

10.1 Layout Guidelines

The high switching frequency and large switching currents of the LM3648 make the choice of layout important. The following steps are to be used as a reference to ensure the device is stable and maintains proper LED current regulation across its intended operating voltage and current range.

1. Place C_{IN} on the top layer (same layer as the LM3648) and as close as possible to the device. The input capacitor conducts the driver currents during the low-side MOSFET turnon and turnoff and can detect current spikes over 1 A in amplitude. Connecting the input capacitor through short, wide traces to both the IN and GND pins reduces the inductive voltage spikes that occur during switching which can corrupt the V_{IN} line.
2. Place C_{OUT} on the top layer (same layer as the LM3648) and as close as possible to the OUT and GND pins. The returns for both C_{IN} and C_{OUT} must come together at one point, as close as possible to the GND pin. Connecting C_{OUT} through short, wide traces reduce the series inductance on the OUT and GND pins that can corrupt the V_{OUT} and GND lines and cause excessive noise in the device and surrounding circuitry.
3. Connect the inductor on the top layer close to the SW pin. There must be a low-impedance connection from the inductor to SW due to the large DC inductor current, and at the same time the area occupied by the SW node must be small so as to reduce the capacitive coupling of the high dV/dT present at SW that can couple into nearby traces.
4. Avoid routing logic traces near the SW node so as to avoid any capacitively coupled voltages from SW onto any high-impedance logic lines such as TORCH/TEMP, STROBE, HWEN, SDA, and SCL. A good approach is to insert an inner layer GND plane underneath the SW node and between any nearby routed traces. This creates a shield from the electric field generated at SW.
5. Terminate the flash LED cathode directly to the GND pin of the LM3648. If possible, route the LED return with a dedicated path so as to keep the high amplitude LED current out of the GND plane. For a flash LED that is routed relatively far away from the LM3648, a good approach is to sandwich the forward and return current paths over the top of each other on two layers. This helps reduce the inductance of the LED current path.

10.2 Layout Example

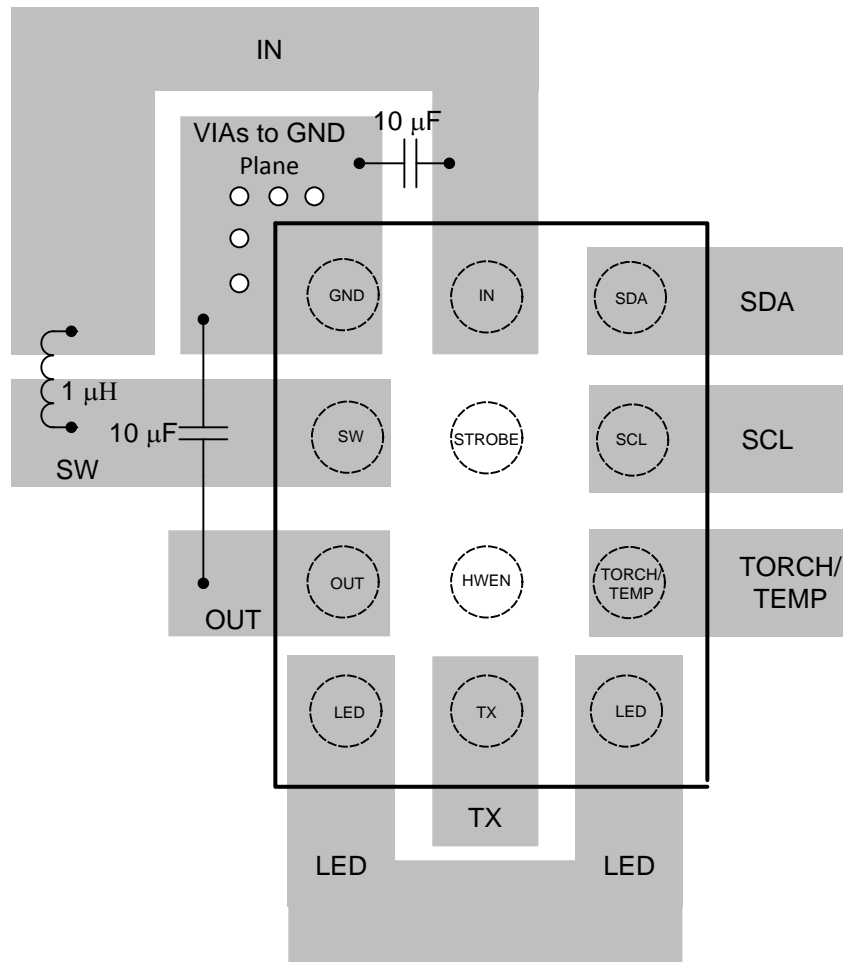

Figure 48. LM3648 Layout Example

11 Device and Documentation Support

11.1 Device Support

11.1.1 Third-Party Products Disclaimer

TI'S PUBLICATION OF INFORMATION REGARDING THIRD-PARTY PRODUCTS OR SERVICES DOES NOT CONSTITUTE AN ENDORSEMENT REGARDING THE SUITABILITY OF SUCH PRODUCTS OR SERVICES OR A WARRANTY, REPRESENTATION OR ENDORSEMENT OF SUCH PRODUCTS OR SERVICES, EITHER ALONE OR IN COMBINATION WITH ANY TI PRODUCT OR SERVICE.

11.2 Documentation Support

11.2.1 Related Documentation

For related documentation, see the following:

[DSBGA Wafer Level Chip Scale Package](#)

11.2.2 Related Links

[Table 4](#) lists quick access links. Categories include technical documents, support and community resources, tools and software, and quick access to sample or buy.

Table 4. Related Links

PARTS	PRODUCT FOLDER	SAMPLE & BUY	TECHNICAL DOCUMENTS	TOOLS & SOFTWARE	SUPPORT & COMMUNITY
LM3648	Click here	Click here	Click here	Click here	Click here
LM3648TT	Click here	Click here	Click here	Click here	Click here

11.3 Receiving Notification of Documentation Updates

To receive notification of documentation updates, navigate to the device product folder on ti.com. In the upper right corner, click on *Alert me* to register and receive a weekly digest of any product information that has changed. For change details, review the revision history included in any revised document.

11.4 Community Resources

The following links connect to TI community resources. Linked contents are provided "AS IS" by the respective contributors. They do not constitute TI specifications and do not necessarily reflect TI's views; see TI's [Terms of Use](#).

TI E2E™ Online Community *TI's Engineer-to-Engineer (E2E) Community*. Created to foster collaboration among engineers. At e2e.ti.com, you can ask questions, share knowledge, explore ideas and help solve problems with fellow engineers.

Design Support *TI's Design Support* Quickly find helpful E2E forums along with design support tools and contact information for technical support.

11.5 Trademarks

E2E is a trademark of Texas Instruments.
All other trademarks are the property of their respective owners.

11.6 Electrostatic Discharge Caution



This integrated circuit can be damaged by ESD. Texas Instruments recommends that all integrated circuits be handled with appropriate precautions. Failure to observe proper handling and installation procedures can cause damage.

ESD damage can range from subtle performance degradation to complete device failure. Precision integrated circuits may be more susceptible to damage because very small parametric changes could cause the device not to meet its published specifications.

11.7 Glossary

[SLYZ022](#) — *TI Glossary*.

This glossary lists and explains terms, acronyms, and definitions.

12 Mechanical, Packaging, and Orderable Information

The following pages include mechanical, packaging, and orderable information. This information is the most current data available for the designated devices. This data is subject to change without notice and revision of this document. For browser-based versions of this data sheet, refer to the left-hand navigation.

PACKAGING INFORMATION

Orderable Device	Status (1)	Package Type	Package Drawing	Pins	Package Qty	Eco Plan (2)	Lead finish/ Ball material (6)	MSL Peak Temp (3)	Op Temp (°C)	Device Marking (4/5)	Samples
LM3648TTYFFR	ACTIVE	DSBGA	YFF	12	3000	RoHS & Green	SNAGCU	Level-1-260C-UNLIM	-40 to 85	3648TT	Samples
LM3648YFFR	ACTIVE	DSBGA	YFF	12	3000	RoHS & Green	SNAGCU	Level-1-260C-UNLIM	-40 to 85	3648	Samples

(1) The marketing status values are defined as follows:

ACTIVE: Product device recommended for new designs.

LIFEBUY: TI has announced that the device will be discontinued, and a lifetime-buy period is in effect.

NRND: Not recommended for new designs. Device is in production to support existing customers, but TI does not recommend using this part in a new design.

PREVIEW: Device has been announced but is not in production. Samples may or may not be available.

OBSOLETE: TI has discontinued the production of the device.

(2) **RoHS:** TI defines "RoHS" to mean semiconductor products that are compliant with the current EU RoHS requirements for all 10 RoHS substances, including the requirement that RoHS substance do not exceed 0.1% by weight in homogeneous materials. Where designed to be soldered at high temperatures, "RoHS" products are suitable for use in specified lead-free processes. TI may reference these types of products as "Pb-Free".

RoHS Exempt: TI defines "RoHS Exempt" to mean products that contain lead but are compliant with EU RoHS pursuant to a specific EU RoHS exemption.

Green: TI defines "Green" to mean the content of Chlorine (Cl) and Bromine (Br) based flame retardants meet JS709B low halogen requirements of <=1000ppm threshold. Antimony trioxide based flame retardants must also meet the <=1000ppm threshold requirement.

(3) MSL, Peak Temp. - The Moisture Sensitivity Level rating according to the JEDEC industry standard classifications, and peak solder temperature.

(4) There may be additional marking, which relates to the logo, the lot trace code information, or the environmental category on the device.

(5) Multiple Device Markings will be inside parentheses. Only one Device Marking contained in parentheses and separated by a "~" will appear on a device. If a line is indented then it is a continuation of the previous line and the two combined represent the entire Device Marking for that device.

(6) Lead finish/Ball material - Orderable Devices may have multiple material finish options. Finish options are separated by a vertical ruled line. Lead finish/Ball material values may wrap to two lines if the finish value exceeds the maximum column width.

Important Information and Disclaimer:The information provided on this page represents TI's knowledge and belief as of the date that it is provided. TI bases its knowledge and belief on information provided by third parties, and makes no representation or warranty as to the accuracy of such information. Efforts are underway to better integrate information from third parties. TI has taken and continues to take reasonable steps to provide representative and accurate information but may not have conducted destructive testing or chemical analysis on incoming materials and chemicals. TI and TI suppliers consider certain information to be proprietary, and thus CAS numbers and other limited information may not be available for release.

In no event shall TI's liability arising out of such information exceed the total purchase price of the TI part(s) at issue in this document sold by TI to Customer on an annual basis.

TAPE AND REEL INFORMATION

QUADRANT ASSIGNMENTS FOR PIN 1 ORIENTATION IN TAPE

*All dimensions are nominal

Device	Package Type	Package Drawing	Pins	SPQ	Reel Diameter (mm)	Reel Width W1 (mm)	A0 (mm)	B0 (mm)	K0 (mm)	P1 (mm)	W (mm)	Pin1 Quadrant
LM3648TTYFFR	DSBGA	YFF	12	3000	180.0	8.4	1.36	1.76	0.77	4.0	8.0	Q1
LM3648YFFR	DSBGA	YFF	12	3000	180.0	8.4	1.36	1.76	0.77	4.0	8.0	Q1

TAPE AND REEL BOX DIMENSIONS

*All dimensions are nominal

Device	Package Type	Package Drawing	Pins	SPQ	Length (mm)	Width (mm)	Height (mm)
LM3648TTYFFR	DSBGA	YFF	12	3000	182.0	182.0	20.0
LM3648YFFR	DSBGA	YFF	12	3000	182.0	182.0	20.0

YFF0012

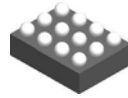

PACKAGE OUTLINE

DSBGA - 0.625 mm max height

DIE SIZE BALL GRID ARRAY

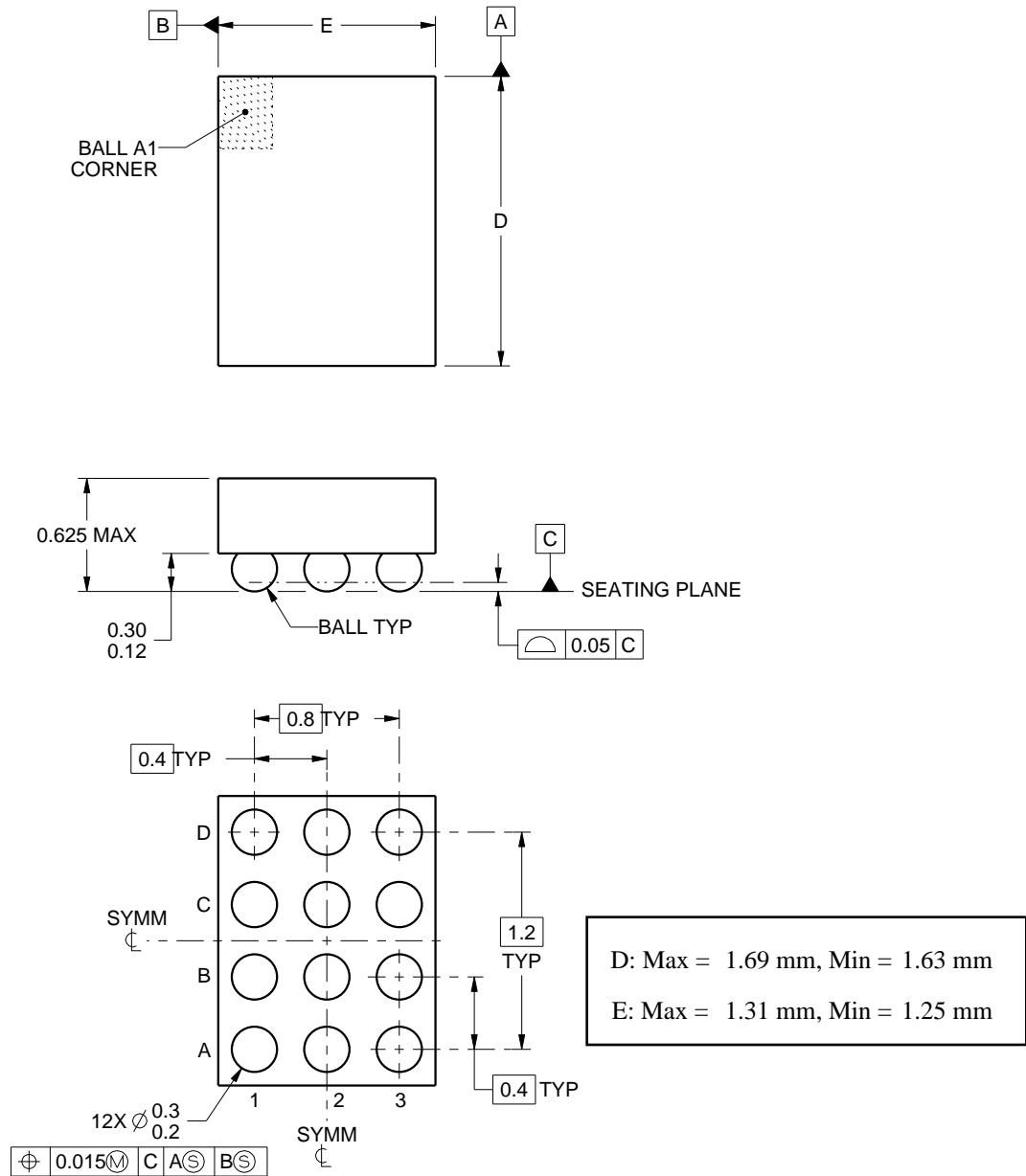

4222191/A 07/2015

NOTES:

1. All linear dimensions are in millimeters. Any dimensions in parenthesis are for reference only. Dimensioning and tolerancing per ASME Y14.5M.
2. This drawing is subject to change without notice.

EXAMPLE BOARD LAYOUT

YFF0012

DSBGA - 0.625 mm max height

DIE SIZE BALL GRID ARRAY

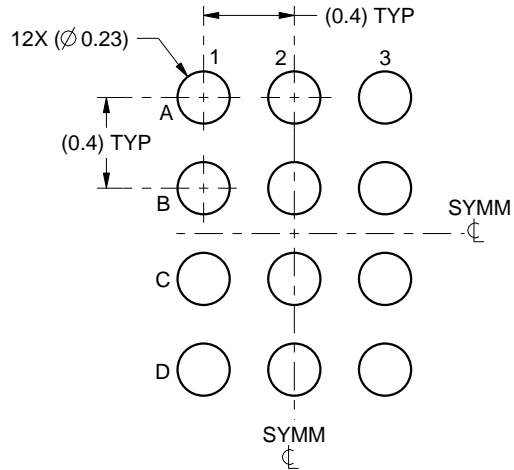

LAND PATTERN EXAMPLE
SCALE:30X

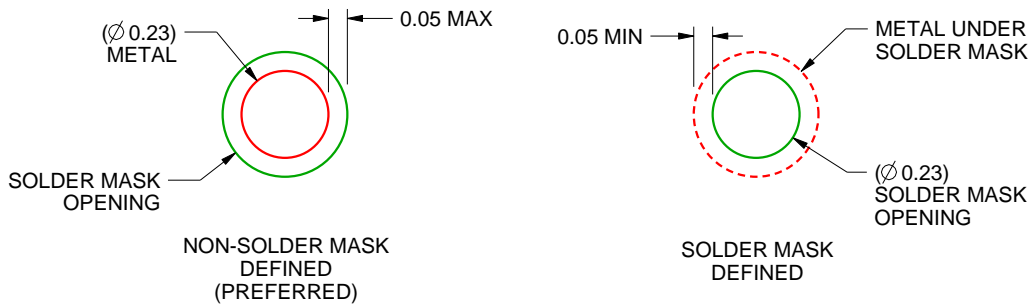

SOLDER MASK DETAILS
NOT TO SCALE

4222191/A 07/2015

NOTES: (continued)

3. Final dimensions may vary due to manufacturing tolerance considerations and also routing constraints. For more information, see Texas Instruments literature number SNVA009 (www.ti.com/lit/snva009).

EXAMPLE STENCIL DESIGN

YFF0012

DSBGA - 0.625 mm max height

DIE SIZE BALL GRID ARRAY

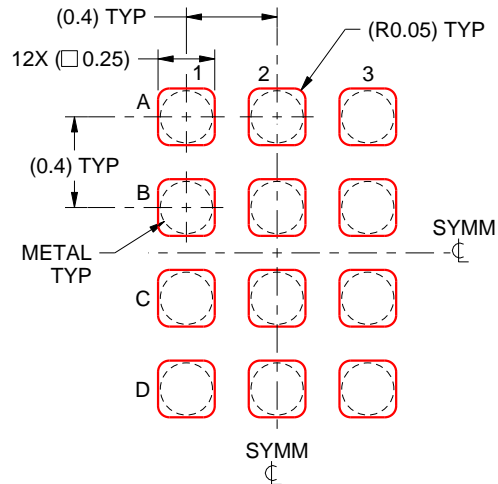

SOLDER PASTE EXAMPLE
BASED ON 0.1 mm THICK STENCIL
SCALE:30X

4222191/A 07/2015

NOTES: (continued)

4. Laser cutting apertures with trapezoidal walls and rounded corners may offer better paste release.

IMPORTANT NOTICE AND DISCLAIMER

TI PROVIDES TECHNICAL AND RELIABILITY DATA (INCLUDING DATA SHEETS), DESIGN RESOURCES (INCLUDING REFERENCE DESIGNS), APPLICATION OR OTHER DESIGN ADVICE, WEB TOOLS, SAFETY INFORMATION, AND OTHER RESOURCES "AS IS" AND WITH ALL FAULTS, AND DISCLAIMS ALL WARRANTIES, EXPRESS AND IMPLIED, INCLUDING WITHOUT LIMITATION ANY IMPLIED WARRANTIES OF MERCHANTABILITY, FITNESS FOR A PARTICULAR PURPOSE OR NON-INFRINGEMENT OF THIRD PARTY INTELLECTUAL PROPERTY RIGHTS.

These resources are intended for skilled developers designing with TI products. You are solely responsible for (1) selecting the appropriate TI products for your application, (2) designing, validating and testing your application, and (3) ensuring your application meets applicable standards, and any other safety, security, regulatory or other requirements.

These resources are subject to change without notice. TI grants you permission to use these resources only for development of an application that uses the TI products described in the resource. Other reproduction and display of these resources is prohibited. No license is granted to any other TI intellectual property right or to any third party intellectual property right. TI disclaims responsibility for, and you will fully indemnify TI and its representatives against, any claims, damages, costs, losses, and liabilities arising out of your use of these resources.

TI's products are provided subject to [TI's Terms of Sale](#) or other applicable terms available either on [ti.com](https://www.ti.com) or provided in conjunction with such TI products. TI's provision of these resources does not expand or otherwise alter TI's applicable warranties or warranty disclaimers for TI products.

TI objects to and rejects any additional or different terms you may have proposed.

Mailing Address: Texas Instruments, Post Office Box 655303, Dallas, Texas 75265
Copyright © 2024, Texas Instruments Incorporated