

# LM63635C-Q1 3.5V~36V、3.25A の車載用降圧型電圧コンバータ

## 1 特長

- 車載アプリケーション用に AEC-Q100 認定済み
  - デバイス温度グレード 1: 動作時周囲温度範囲:  $-40^{\circ}\text{C} \sim +125^{\circ}\text{C}$
- 機能安全対応
  - 機能安全システムの設計に役立つ資料を利用可能
- 車載用システムの要件をサポート
  - 入力電圧範囲: 3.5V~36V
  - 短い最小オン時間: 50ns
  - 優れた EMI 性能
  - 疑似ランダム拡散スペクトラム
  - CISPR 25 と互換
  - 低い動作時静止電流: 23 $\mu\text{A}$
  - 接合部温度範囲:  $-40^{\circ}\text{C} \sim +150^{\circ}\text{C}$
- 最小の外付け部品点数で高い設計フレキシビリティを実現
  - 固定  $V_{\text{OUT}}$ : 3.3V または 5V
  - 固定スイッチング周波数: 400kHz または 2.1MHz
  - 最大 3.25A の出力電流
- 小型デザイン サイズ
  - 最小サイズ: 14mm  $\times$  14mm の WSON パッケージで 3.25A、2.2MHz
  - 外付け部品点数が少ない高集積設計

## 2 アプリケーション

- 車載用インフォテインメントおよびクラスタ
- 車載ボディ エレクトロニクス / ライティング
- 車載用 ADAS

## 3 概要

LM63635C-Q1 レギュレータは、堅牢な車載アプリケーション向けに設計された、使いやすい同期整流降圧型 DC/DC コンバータです。LM63635C-Q1 は最大 3.25A の負荷電流を最大 36V の入力から駆動できます。このコンバータは、高い軽負荷時効率と出力精度を小さなデザイン サイズで実現しています。RESET フラグや高精度イネーブルなどの機能を使用すると、幅広いアプリケーションに対して柔軟で使いやすいソリューションを実現できます。軽負荷時には自動的に周波数フォールドバック モードになるため、負荷を厳密に制御しながら効率を上げることが可能です。高度な統合により、多くの外付け部品が不要で、PCB レイアウトが単純になるようにピン配置が設計されています。保護機能として、サーマル シャットダウン、入力低電圧誤動作防止、サイクル単位の電流制限、ヒックアップ短絡保護機能が搭載されています。LM63635C-Q1 は、WSON 12 ピン パワー パッケージで供給されます。

### パッケージ情報

| 部品番号        | パッケージ <sup>(1)</sup> | パッケージ サイズ <sup>(2)</sup> |
|-------------|----------------------|--------------------------|
| LM63635C-Q1 | DRR (WSON, 12)       | 3.00mm $\times$ 3.00mm   |

(1) 詳細については、[セクション 11](#) を参照してください。

(2) パッケージ サイズ (長さ $\times$ 幅) は公称値であり、該当する場合はピンも含まれます。

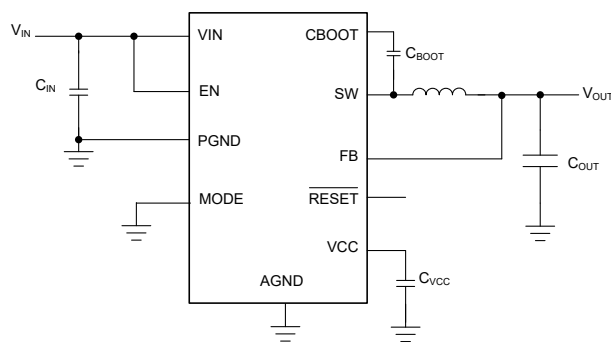

概略回路図

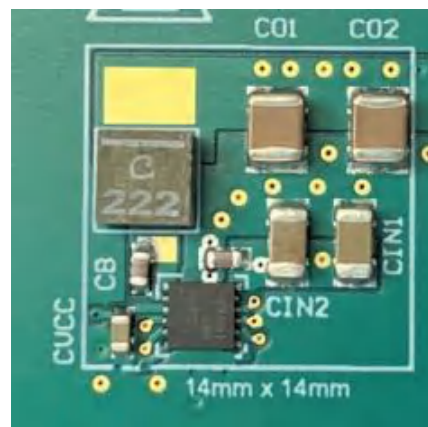

代表的な設計例:  $I_{\text{OUT}} = 3.25\text{A}$ 、 $f_{\text{sw}} = 2200\text{kHz}$



## Table of Contents

|  |    |  |    |
|--|----|--|----|
| <b>1 特長</b> .....                              | 1  | 7.4 Device Functional Modes.....                                 | 14 |
| <b>2 アプリケーション</b> .....                        | 1  | <b>8 Application and Implementation</b> .....                    | 19 |
| <b>3 概要</b> .....                              | 1  | 8.1 Application Information.....                                 | 19 |
| <b>4 Device Comparison Table</b> .....         | 3  | 8.2 Typical Application.....                                     | 19 |
| <b>5 Pin Configuration and Functions</b> ..... | 4  | 8.3 Best Design Practices.....                                   | 28 |
| <b>6 Specifications</b> .....                  | 5  | 8.4 Power Supply Recommendations.....                            | 29 |
| 6.1 Absolute Maximum Ratings.....              | 5  | 8.5 Layout.....  | 29 |
| 6.2 ESD Ratings.....                           | 5  | <b>9 Device and Documentation Support</b> .....                  | 33 |
| 6.3 Recommended Operating Conditions.....      | 5  | 9.1 Device Support.....  | 33 |
| 6.4 Thermal Information.....                   | 6  | 9.2 Documentation Support.....                                   | 33 |
| 6.5 Electrical Characteristics.....            | 7  | 9.3 ドキュメントの更新通知を受け取る方法.....                                      | 33 |
| 6.6 Timing Characteristics.....                | 8  | 9.4 サポート・リソース.....   | 33 |
| 6.7 Switching Characteristics.....             | 9  | 9.5 Trademarks.....  | 33 |
| 6.8 System Characteristics.....                | 9  | 9.6 用語集.....   | 33 |
| 6.9 Typical Characteristics.....               | 10 | 9.7 静電気放電に関する注意事項.....   | 34 |
| <b>7 Detailed Description</b> .....            | 11 | <b>10 Revision History</b> .....                                 | 34 |
| 7.1 Overview.....                              | 11 | <b>11 Mechanical, Packaging, and Orderable Information</b> ..... | 34 |
| 7.2 Functional Block Diagram.....              | 11 |  |    |
| 7.3 Feature Description.....                   | 11 |  |    |

## 4 Device Comparison Table

| ORDER NUMBER <sup>(1)</sup> | PACKAGE           | RATED CURRENT | F <sub>sw</sub> | V <sub>OUT</sub> | PACKAGE SIZE    |
|-----------------------------|-------------------|---------------|-----------------|------------------|-----------------|
| LM63635CC3QDRRRQ1           | DRR0012<br>(WSON) | 3.25A         | Fixed 2.1MHz    | Fixed 3.3V       | 3.00mm × 3.00mm |
| LM63635CC5QDRRRQ1           |                   |               |                 | Fixed 5V         |                 |
| LM63635CA3QDRRRQ1           |                   |               | Fixed 400kHz    | Fixed 3.3V       |                 |
| LM63635CA5QDRRRQ1           |                   |               |                 | Fixed 5V         |                 |

(1) For more information on device orderable part numbers, see [Device Nomenclature](#).

## 5 Pin Configuration and Functions



図 5-1. DRR Package, 12-Pin WSON With PowerPAD™ Integrated Circuit Package— LM63635C-Q1 (Top View)

表 5-1. Pin Functions

| PIN   |               |      | DESCRIPTION  |
|-------|---------------|------|--|
| NAME  | WSON LM63635C | TYPE |  |
| SW    | 1             | P    | Regulator switch node. Connect to power inductor.  |
| CBOOT | 2             | P    | Bootstrap supply voltage for internal high-side driver. Connect a high-quality, 220nF capacitor from this pin to the SW pin.   |
| NC    | 3             | —    | No internal connection to device   |
| VCC   | 4             | A    | Internal 5V LDO output. Used as supply to internal control circuits. Do not connect to external loads. Can be used as logic supply for regulator functions. Connect a high-quality, 1µF capacitor from this pin to PGND. |
| MODE  | 5             | A    | MODE PIN must be tied to AGND  |
| RESET | 6             | A    | Open-drain power-good flag output. Connect to a voltage supply that can be used through a current limiting resistor. High = power OK, low = power bad. Flag pulls low when EN = Low. Can be open when not used.          |
| FB    | 7             | A    | Feedback input to regulator. Connect to output capacitor. Do not float; do not ground.   |
| NC    | 8             | —    | No internal connection to device   |
| AGND  | 9             | G    | Analog ground for regulator and system. Ground reference for internal references and logic. All electrical parameters are measured with respect to this pin. Connect to system ground on PCB.                            |
| EN    | 10            | A    | Enable input to regulator. High = ON, Low = OFF. Can be connected directly to VIN. Do not float.   |
| NC    | 11            | —    | No internal connection to device   |
| VIN   | 12            | P    | Input supply to regulator. Connect a high-quality bypass capacitors directly to this pin and PGND.   |
| PGND  | 13            | G    | Power ground terminal. Connect to system ground and AGND. Connect to bypass capacitor with short wide traces.  |
| DAP   | —             | G    | Electrical ground and heat sink connection. Solder directly to system ground plane.  |

A = Analog, P = Power, G = Ground

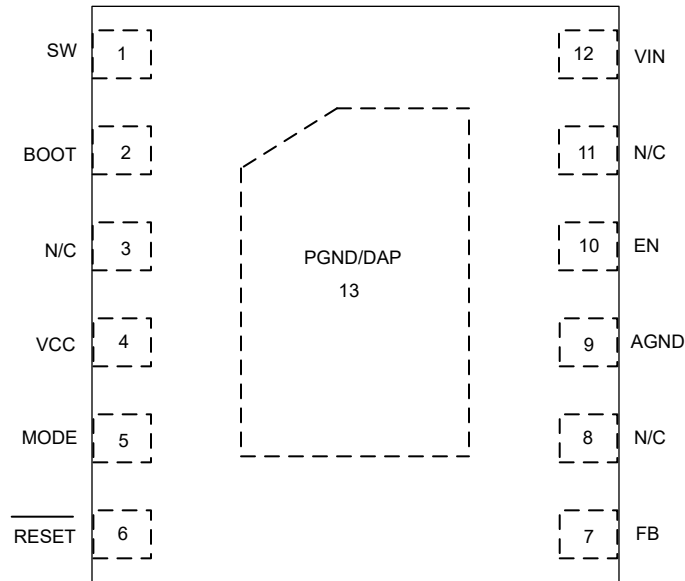
## 6 Specifications

### 6.1 Absolute Maximum Ratings

Over the recommended junction temperature range <sup>(1)</sup>

| PARAMETER        |   | MIN  | MAX | UNIT |
|------------------|---|------|-----|------|
|                  | VIN to PGND                                 | −0.3 | 42  | V    |
|                  | EN to AGND                                  | −0.3 | 42  | V    |
|                  | RESET to AGND                               | −0.3 | 16  | V    |
|                  | FB to AGND (Fixed VOUT mode)                | −0.3 | 16  | V    |
|                  | AGND to PGND                                | −0.3 | 0.3 | V    |
|                  | SW to PGND for transients of less than 10ns | −6   | 42  | V    |
|                  | BOOT to SW                                  | −0.3 | 5.5 | V    |
|                  | VCC to AGND                                 | −0.3 | 5.5 | V    |
| T <sub>J</sub>   | Junction temperature                        | −40  | 150 | °C   |
| T <sub>stg</sub> | Storage temperature                         | −65  | 150 | °C   |

- (1) Operation outside the Absolute Maximum Ratings may cause permanent device damage. Absolute Maximum Ratings do not imply functional operation of the device at these or any other conditions beyond those listed under Recommended Operating Conditions. If used outside the Recommended Operating Conditions but within the Absolute Maximum Ratings, the device may not be fully functional, and this may affect device reliability, functionality, performance, and shorten the device lifetime.

### 6.2 ESD Ratings

|                    |                         |  | VALUE | UNIT |
|--------------------|-------------------------|--|-------|------|
| V <sub>(ESD)</sub> | Electrostatic discharge | Human-body model (HBM), per AEC Q100-002 <sup>(1)</sup> HBM ESD Classification Level 2 | ±2000 | V    |
|                    |                         | Charged-device model (CDM), per AEC Q100-011 CDM ESD classification Level C5           | ±750  | V    |

- (1) AEC Q100-002 indicates that HBM stressing must be in accordance with the ANSI/ESDA/JEDEC JS-001 specification.

### 6.3 Recommended Operating Conditions

Over the recommended junction temperature range of −40°C to 150°C (unless otherwise noted) <sup>(1)</sup>

|  |                  | MIN | MAX  | UNIT |
|--|------------------|-----|------|------|
|  | VIN to PGND      | 3.5 | 36   | V    |
|  | EN               | 0   | 36   | V    |
|  | RESET            | 0   | 5    | V    |
|  | V <sub>CC</sub>  | 2.7 | 5.25 | V    |
|  | I <sub>OUT</sub> | 0   | 3.25 | A    |

- (1) Recommended operating conditions indicate conditions for which the device is intended to be functional. For ensured specifications, see the *Electrical Characteristics Table*.

## 6.4 Thermal Information

| THERMAL METRIC <sup>(1)</sup> |   | LM63635C-Q1   | UNIT |
|-------------------------------|---|---------------|------|
|                               |   | DRR0012 (WSO) |      |
|                               |   | 12 PINS       |      |
| $R_{\theta JA}$               | Junction-to-ambient thermal resistance <sup>(2)</sup> | 47.4          | °C/W |
| $R_{\theta JC(top)}$          | Junction-to-case (top) thermal resistance             | 44.6          | °C/W |
| $R_{\theta JB}$               | Junction-to-board thermal resistance                  | 20.7          | °C/W |
| $\Psi_{JT}$                   | Junction-to-top characterization parameter            | 0.7           | °C/W |
| $\Psi_{JB}$                   | Junction-to-board characterization parameter          | 20.7          | °C/W |
| $R_{\theta JC(bot)}$          | Junction-to-case (bottom) thermal resistance          | 6.3           | °C/W |

- (1) For more information about traditional and new thermal metrics, see the [Semiconductor and IC Package Thermal Metrics](#) application report.
- (2) The value of  $R_{\theta JA}$  given in this table is only valid for comparison with other packages and can not be used for design purposes. These values were calculated in accordance with JESD 51-7, and simulated on a 4-layer JEDEC board. They do not represent the performance obtained in an actual application. For design information please see the *Maximum Ambient Temperature* section.

## 6.5 Electrical Characteristics

Limits apply over the junction temperature ( $T_J$ ) range of  $-40^{\circ}\text{C}$  to  $+150^{\circ}\text{C}$ , unless otherwise stated. Minimum and maximum limits are specified through test, design or statistical correlation. Typical values represent the most likely parametric norm at  $T_J = 25^{\circ}\text{C}$ , and are provided for reference purposes only. Unless otherwise stated, the following conditions apply:  $V_{IN} = 13.5\text{V}$ . <sup>(1)</sup>

| PARAMETER                         |   | TEST CONDITIONS   | MIN   | TYP  | MAX   | UNIT          |
|-----------------------------------|---|---|-------|------|-------|---------------|
| <b>SUPPLY VOLTAGE (VIN PIN)</b>   |   |   |       |      |       |               |
| $V_{IN}$                          | Minimum operating input voltage                                 |   |       |      | 3.5   | V             |
| $I_Q$                             | Non-switching input current; measured at VIN pin <sup>(2)</sup> | $V_{EN} = 3.3\text{V}$ , $V_{FB} = 1.2 \times$ regulation point |       | 23   | 40    | $\mu\text{A}$ |
| $I_{SD}$                          | Shutdown quiescent current; measured at VIN pin                 | $V_{EN} = 0$  |       | 5.3  | 10    | $\mu\text{A}$ |
| $V_{UVLO\_R}$                     | Minimum operating voltage threshold                             | Rising $V_{IN}$ , $I_{VCC} = 0$                                 |       |      | 3.5   | V             |
| $V_{UVLO\_F}$                     | Minimum operating voltage threshold                             | Falling $V_{IN}$ , $I_{VCC} = 0$                                | 2.6   |      | 3     | V             |
| $I_{POR}$                         | Pulldown current on SW when OVP is triggered                    | $V_{EN} = 0$ $V_{SW} = 5\text{V}$                               | 0.5   | 1.5  | 2.5   | mA            |
| <b>ENABLE (EN PIN)</b>            |   |   |       |      |       |               |
| $V_{EN-VCC}$                      | VCC enable voltage  | $V_{EN}$ rising   |       | 0.85 |       | V             |
| $V_{EN-H}$                        | Precision enable high level for VOUT                            | $V_{EN}$ rising   | 1.425 | 1.5  | 1.575 | V             |
| $V_{EN-L}$                        | Precision enable low level for VOUT                             | $V_{EN}$ falling  | 0.9   | 0.94 |       | V             |
| $I_{LKG-EN}$                      | Enable input leakage current                                    | $V_{EN} = 13.5\text{V}$   | -100  | 0.2  | 300   | nA            |
| <b>INTERNAL LDO</b>               |   |   |       |      |       |               |
| $V_{CC}$                          | Internal VCC voltage  | $6\text{V} \leq V_{IN} \leq$ Max Operating $V_{IN}$             | 4.75  | 5    | 5.25  | V             |
| $V_{CCM}$                         | VCC Clamp voltage   | 1mA sourced into VCC  | 5.25  | 5.55 | 5.8   | V             |
| <b>VOLTAGE REFERENCE (FB PIN)</b> |   |   |       |      |       |               |
| $V_{FB\_5V}$                      | Feedback voltage  | $V_{IN} = 5.5\text{V} -$ Max Operating $V_{IN}$                 | 4.925 | 5    | 5.075 | V             |
| $V_{FB\_3p3V}$                    | Feedback voltage  | $V_{IN} = 3.8\text{V} -$ Max Operating $V_{IN}$                 | 3.25  | 3.3  | 3.35  | V             |
| $I_{FB\_5V}$                      | Input leakage current at FB PIN                                 | FB = 5.0V   |       | 2.89 | 3.4   | $\mu\text{A}$ |
| $I_{FB\_3p3V}$                    | Input leakage current at FB PIN                                 | FB = 3.3V   |       | 1.67 | 2     | $\mu\text{A}$ |
| <b>CURRENT LIMITS</b>             |   |   |       |      |       |               |
| $I_{SC}$                          | Short circuit high side current Limit                           |   | 3.9   | 4.4  | 5.4   | A             |
| $I_{LS-LIMIT}$                    | Low side current limit  |   | 3.2   | 3.7  | 4.4   | A             |
| $I_{PEAK-MIN}$                    | Minimum peak inductor current                                   |   |       | 0.62 | 1.25  | A             |
| $V_{HICCUP}$                      | Hiccup threshold on FB pin                                      |   | 37    | 42   | 47    | %             |

## 6.5 Electrical Characteristics (続き)

Limits apply over the junction temperature ( $T_J$ ) range of  $-40^{\circ}\text{C}$  to  $+150^{\circ}\text{C}$ , unless otherwise stated. Minimum and maximum limits are specified through test, design or statistical correlation. Typical values represent the most likely parametric norm at  $T_J = 25^{\circ}\text{C}$ , and are provided for reference purposes only. Unless otherwise stated, the following conditions apply:  $V_{IN} = 13.5\text{V}$ . <sup>(1)</sup>

| PARAMETER                     |  | TEST CONDITIONS  | MIN | TYP  | MAX  | UNIT       |
|-------------------------------|--|--|-----|------|------|------------|
| <b>POWER GOOD (RESET PIN)</b> |  |  |     |      |      |            |
| $V_{\text{RESET-HIGH}}$       | RESET upper threshold - rising                       | % of FB voltage  | 110 | 112  | 115  | %          |
| $V_{\text{RESET-LOW}}$        | RESET lower threshold - falling                      | % of FB voltage  | 91  | 93   | 95   | %          |
| $V_{\text{RESET-HYS}}$        | RESET hysteresis                                     | % of FB voltage,   | 1.1 | 1.8  | 2.5  | %          |
| $V_{\text{RESET\_VALID}}$     | Minimum input voltage for proper PG function         | Measured when $V_{\text{RESET}} < 0.4\text{V}$ with 10kOhm pullup to external 5V | 0.7 | 1.04 | 1.25 | V          |
| $R_{\text{RESET}}$            | RESET ON resistance                                  | $V_{\text{EN}} = 5.0\text{V}$ , 1 mA pullup current                              |     | 60   | 150  | $\Omega$   |
| $R_{\text{RESET}}$            | RESET ON resistance                                  | $V_{\text{EN}} = 0\text{V}$ , 1mA pullup current                                 |     | 40   | 125  | $\Omega$   |
| <b>MOSFETS</b>                |  |  |     |      |      |            |
| $R_{\text{DS-ON-HS}}$         | High-side MOSFET on-resistance                       | Load = 1A  |     | 93   |      | m $\Omega$ |
| $R_{\text{DS-ON-LS}}$         | Low-side MOSFET on-resistance                        | Load = 1A  |     | 61   |      | m $\Omega$ |
| $V_{\text{CBOOT-UVLO}}$       | $C_{\text{BOOT}}$ - SW UVLO threshold <sup>(3)</sup> |  |     | 2.13 |      | V          |

- (1) MIN and MAX limits are 100% production tested at  $25^{\circ}\text{C}$ . Limits over the operating temperature range verified through correlation using Statistical Quality Control (SQC) methods. Limits are used to calculate Average Outgoing Quality Level (AOQL).
- (2) This is the current used by the device open loop. It does not represent the total input current of the system when in regulation.
- (3) When the  $C_{\text{BOOT}}$  capacitor voltage falls below  $V_{\text{CBOOT-UVLO}}$ , the low side MOSFET is turned on to recharge the boot capacitor

## 6.6 Timing Characteristics

Limits apply over the junction temperature ( $T_J$ ) range of  $-40^{\circ}\text{C}$  to  $+150^{\circ}\text{C}$ , unless otherwise stated. Minimum and maximum limits are specified through test, design or statistical correlation. Typical values represent the most likely parametric norm at  $T_J = 25^{\circ}\text{C}$ , and are provided for reference purposes only. Unless otherwise stated, the following conditions apply:  $V_{IN} = 13.5\text{V}$ . <sup>(1)</sup>

| PARAMETER   |  | TEST CONDITIONS   | MIN | TYP | MAX | UNIT          |
|---|--|---|-----|-----|-----|---------------|
| <b>CURRENT LIMITS AND HICCUP</b>                          |  |   |     |     |     |               |
| $N_{\text{OC}}$   | Number of switching current limit continuous events before hiccup is tripped |   |     | 128 |     | Cycles        |
| $t_{\text{OC}}$   | Overcurrent hiccup retry delay time  |   | 70  | 104 | 140 | ms            |
| $t_{\text{OC\_active}}$                                   | Time after soft start done timer before hiccup current protection is enabled |   | 11  | 16  | 22  | ms            |
| <b>SOFT START</b>   |  |   |     |     |     |               |
| $t_{\text{SS}}$   | Internal soft-start time   |   | 1   | 1.6 | 2.2 | ms            |
| $t_{\text{SS\_DONE}}$                                     | Soft-start done timer  |   | 5   | 8   | 11  | ms            |
| <b>POWER GOOD (/RESET PIN) and OVERVOLTAGE PROTECTION</b> |  |   |     |     |     |               |
| $t_{\text{dg}}$   | RESET edge deglitch delay  |   | 10  | 17  | 30  | $\mu\text{s}$ |
| $t_{\text{RISE-DELAY}}$                                   | RESET active time  | Time FB must be valid before $\overline{\text{RESET}}$ is released. | 2   | 3   | 5   | ms            |

- (1) MIN and MAX limits are 100% production tested at  $25^{\circ}\text{C}$ . Limits over the operating temperature range are verified through correlation using Statistical Quality Control (SQC) methods. Limits are used to calculate Average Outgoing Quality Level (AOQL).



## 6.7 Switching Characteristics

Limits apply over the junction temperature ( $T_J$ ) range of  $-40^{\circ}\text{C}$  to  $+150^{\circ}\text{C}$ , unless otherwise stated. Minimum and maximum limits are specified through test, design or statistical correlation. Typical values represent the most likely parametric norm at  $T_J = 25^{\circ}\text{C}$ , and are provided for reference purposes only. Unless otherwise stated, the following s apply:  $V_{IN} = 13.5\text{ V}$ . <sup>(1)</sup>

| PARAMETER                   |   | TEST CONDITIONS                              | MIN  | TYP  | MAX  | UNIT          |
|-----------------------------|---|--|------|------|------|---------------|
| <b>PWM LIMITS (SW PINS)</b> |   |  |      |      |      |               |
| $t_{ON-MIN}$                | Minimum switch on-time                          | $V_{IN} = 12\text{V}$ , $I_{SW} = 1\text{A}$ |      | 50   | 75   | ns            |
| $t_{OFF-MIN}$               | Minimum switch off-time                         | $V_{IN} = 5\text{V}$                         |      | 50   | 100  | ns            |
| $t_{ON-MAX}$                | Maximum switch on-time                          | HS timeout in dropout                        | 5.4  | 7    | 10   | $\mu\text{s}$ |
| <b>OSCILLATOR</b>           |   |  |      |      |      |               |
| $f_{OSC}$                   | Internal oscillator frequency                   | 2.1MHz Fsw version                           | 1.85 | 2.1  | 2.35 | MHz           |
| $f_{OSC}$                   | Internal oscillator frequency                   | 400kHz Fsw version                           | 360  | 400  | 440  | kHz           |
| <b>SPREAD SPECTRUM</b>      |   |  |      |      |      |               |
| $f_{PSS(2)}$                | Spread spectrum pseudo random pattern frequency | $f_{OSC} = 2.1\text{MHz}$                    |      | 0.98 |      | Hz            |

(1) MIN and MAX limits are 100% production tested at  $25^{\circ}\text{C}$ . Limits over the operating temperature range are verified through correlation using Statistical Quality Control (SQC) methods. Limits are used to calculate Average Outgoing Quality Level (AOQL).

## 6.8 System Characteristics

The following specifications apply only to the typical applications circuit with nominal component values. Specifications in the typical (TYP) column apply to  $T_J = 25^{\circ}\text{C}$  only. Specifications in the minimum (MIN) and maximum (MAX) columns apply to the case of typical components over the temperature range of  $T_J = -40^{\circ}\text{C}$  to  $150^{\circ}\text{C}$ . These specifications are not ensured by production testing.

| PARAMETER                         |  | TEST CONDITIONS   | MIN  | TYP  | MAX | UNIT               |
|-----------------------------------|--|---|------|------|-----|--------------------|
| <b>SUPPLY VOLTAGE (VIN PIN)</b>   |  |   |      |      |     |                    |
| $I_{SUPPLY}$                      | Input supply current when in regulation  | $V_{IN} = 12\text{V}$ , $V_{OUT} = 3.3\text{V}$ , $I_{OUT} = 0\text{A}$ , $R_{FBT} = 1\text{M}\Omega$   |      | 23   |     | $\mu\text{A}$      |
| $V_{DROP}$                        | Dropout voltage; ( $V_{IN} - V_{OUT}$ )  | $V_{OUT} = 5\text{V}$ , $I_{OUT} = 1\text{A}$ , $F_{SW} = 1850\text{kHz}$                               |      | 0.95 |     | V                  |
| $V_{DROP}$                        | Dropout voltage; ( $V_{IN} - V_{OUT}$ )  | $V_{OUT} = 5\text{V}$ , $I_{OUT} = 1\text{A}$ , $V_{OUT} - 1\%$ of regulation, $F_{SW} = 140\text{kHz}$ |      | 150  |     | mV                 |
| $D_{MAX}$                         | Maximum switch duty cycle <sup>(2)</sup> | $V_{IN} = V_{OUT} = 12\text{V}$ , $I_{OUT} = 1\text{A}$   |      | 98   |     | %                  |
| <b>VOLTAGE REFERENCE (FB PIN)</b> |  |   |      |      |     |                    |
| $V_{OUT(1)}$                      | $V_{OUT} = 5\text{V}$                    | $V_{IN} = 7\text{V}$ to $30\text{V}$ , $I_{OUT} = 1\text{A}$ to full load, CCM                          | -1.5 |      | 1.5 | %                  |
|                                   |  | $V_{IN} = 7\text{V}$ to $30\text{V}$ , $I_{OUT} = 0\text{A}$ to full load, AUTO mode                    | -1.5 |      | 2.5 | %                  |
|                                   | $V_{OUT} = 3.3\text{V}$                  | $V_{IN} = 3.8\text{V}$ to $30\text{V}$ , $I_{OUT} = 1\text{A}$ to full load, CCM                        | -1.5 |      | 1.5 | %                  |
|                                   |  | $V_{IN} = 3.8\text{V}$ to $30\text{V}$ , $I_{OUT} = 0\text{A}$ to full load, AUTO mode                  | -1.5 |      | 2.5 | %                  |
| <b>THERMAL SHUTDOWN</b>           |  |   |      |      |     |                    |
| $T_{SD}$                          | Thermal shutdown temperature             | Shutdown temperature  | 155  | 163  | 175 | $^{\circ}\text{C}$ |
| $T_{SDR}$                         | Thermal shutdown temperature             | Recovery temperature  |      | 150  |     | $^{\circ}\text{C}$ |

(1) Deviation is with respect to  $V_{IN} = 13.5\text{ V}$ ,  $I_{OUT} = 1\text{ A}$ .

(2) In dropout the switching frequency drops to increase the effective duty cycle. The lowest frequency is clamped at approximately:  $f_{MIN} = 1 / (t_{ON-MAX} + T_{OFF-MIN})$ .  $D_{MAX} = t_{ON-MAX} / (t_{ON-MAX} + t_{OFF-MIN})$ .

## 6.9 Typical Characteristics

Unless otherwise specified the following conditions apply:  $T_A = 25^\circ\text{C}$ ,  $V_{IN} = 13.5\text{ V}$

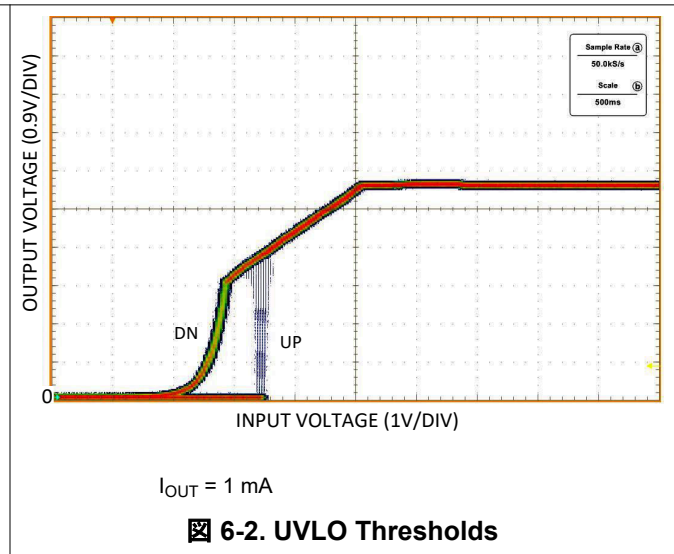
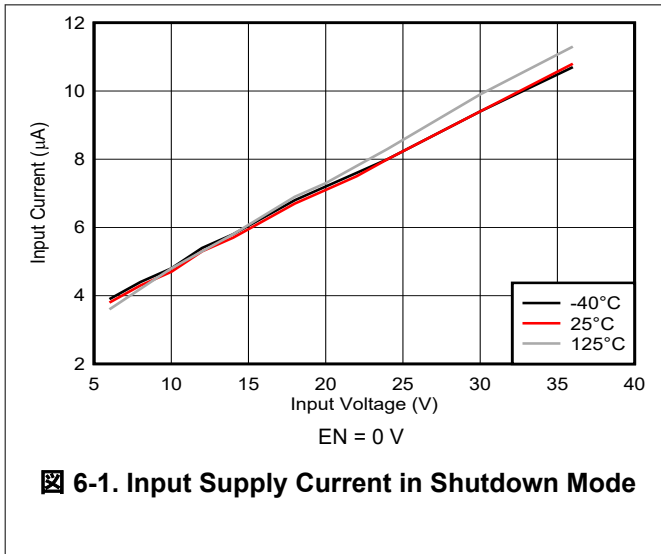

## 7 Detailed Description

### 7.1 Overview

The LM63635C-Q1 device is a synchronous peak-current-mode buck regulator designed for a wide variety of automotive applications. The regulator automatically switches modes between PFM and PWM, depending on load. At heavy loads, the device operates in PWM at a constant switching frequency. At light loads, the mode changes to PFM with diode emulation, allowing DCM. This action reduces the input supply current and keeps efficiency high. The device features the following:

- Fixed switching frequency at 400kHz or 2.1MHz
- Fixed output voltage at 3.3V or 5V

The  $\overline{\text{RESET}}$  output allows easy system sequencing. In addition, internal compensation reduces design time and requires fewer external components than externally compensated regulators.

### 7.2 Functional Block Diagram

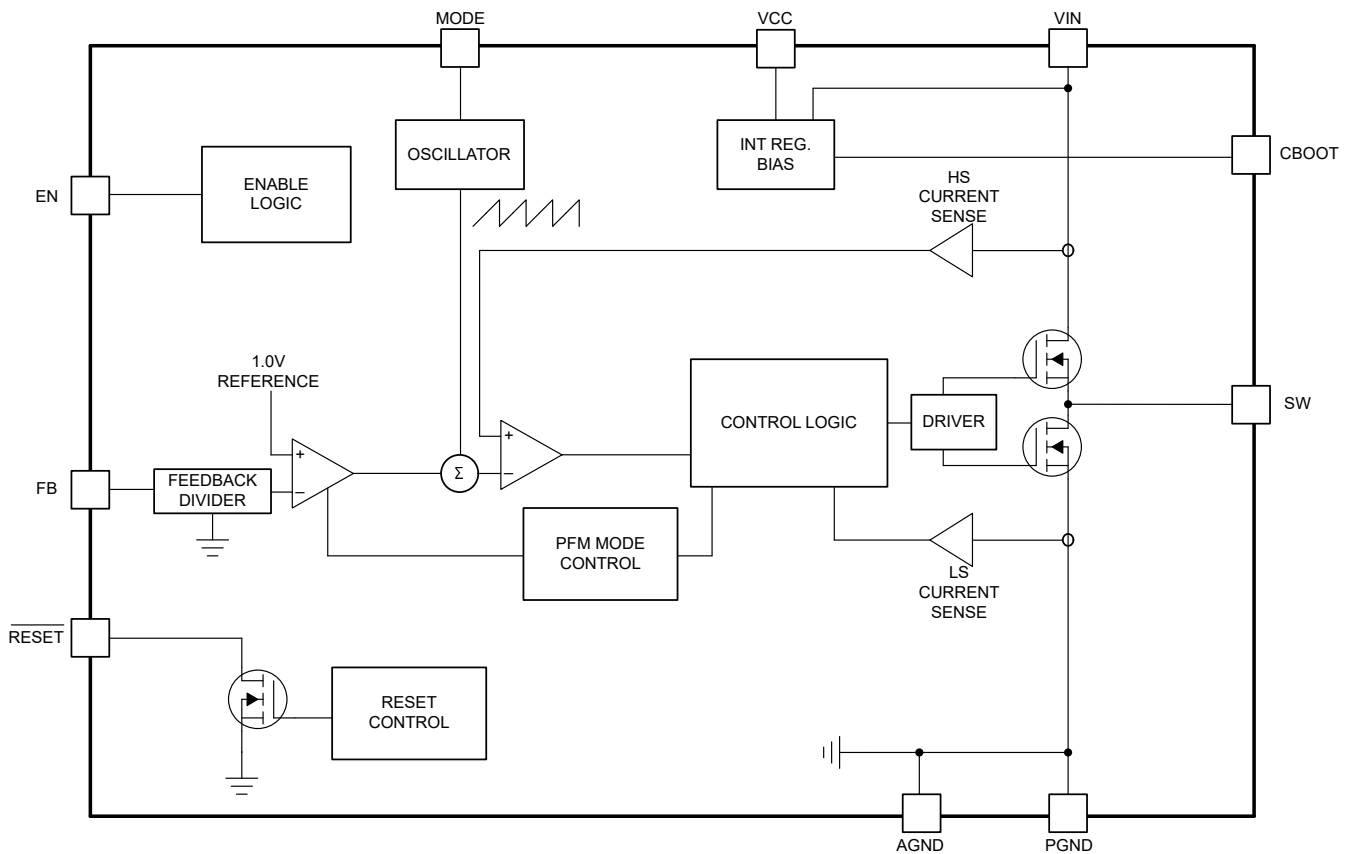

### 7.3 Feature Description

#### 7.3.1 Output Voltage Selection

The LM63635C-Q1 contains an integrated voltage divider connected to the FB input. The converter regulates the output voltage to 3.3V or 5V depending on the device selected. See [セクション 6](#) for ensured specifications regarding the accuracy of the FB voltage and input current to the FB pin.

Providing internal voltage dividers for the 3.3V and 5V modes saves external components, reducing both board space and component cost. The relatively large values of the internal dividers reduce the load on the output, helping to improve the light load efficiency of the converter. In addition, because the divider is inside the device, the divider is less likely to pick up externally generated noise.

### 7.3.2 Switching Frequency Selection

The switching frequency is set based on the device that is selected. The switching frequency is either 400kHz or 2.1MHz. See [セクション 4](#) for more information.

#### 7.3.2.1 Spread Spectrum Option

The LM63635C-Q1 is available with a spread spectrum clock dithering feature. This feature uses a pseudo-random pattern to dither the internal clock frequency. The pattern repeats at a 0.98Hz rate while the depth of modulation is  $\pm 3\%$ .

The purpose of the spread spectrum is to eliminate peak emissions at specific frequencies by spreading emissions across a wider range of frequencies than a part with fixed frequency operation. In most systems containing the LM63635C-Q1, low frequency conducted emissions from the first few harmonics of the switching frequency can be easily filtered. A more difficult design criterion is reduction of emissions at higher harmonics which fall in the FM band. These harmonics often couple to the environment through electric fields around the switch node. The LM63635C-Q1 uses a  $\pm 3\%$  spread of frequencies, which spreads energy smoothly across the FM band but is small enough to limit subharmonic emissions below the switching frequency.

### 7.3.3 Enable and Start-Up

Start-up and shutdown are controlled by the EN input. This input features precision thresholds, allowing the use of an external voltage divider to provide an adjustable input UVLO (see [セクション 8.2.2.7](#)). Applying a voltage greater than  $V_{EN-VCC}$  causes the device to enter standby mode, powering the internal VCC, but not producing an output voltage. Increasing the EN voltage to  $V_{EN-H}$  fully enables the device, allowing the device to enter start-up mode and begin the soft-start period. When the EN input is brought below  $V_{EN-L}$ , the regulator stops running and enters standby mode. Further decrease in the EN voltage to below  $V_{EN-VCC}$  completely shuts down the device. [図 7-1](#) shows this behavior. The EN input can be connected directly to VIN if this feature is not needed. This input must not be allowed to float. The values for the various EN thresholds can be found in [セクション 6](#).

The LM63635C-Q1 uses a reference-based soft start that prevents output voltage overshoots and large inrush currents as the regulator is starting up. [図 7-2](#) shows a typical start-up waveform along with typical timings. After the EN goes high, there is a delay of about 1ms before the soft-start period begins. The output voltage begins to rise and reaches the final value in about 1.5ms ( $t_{ss}$ ). After a delay of about 3ms ( $t_{rise-delay}$ ), the RESET flag goes high. This time is measured from the rising edge of EN. TI does not recommend to start up with a prebiased output voltage of greater than 1V.



図 7-1. Precision Enable Behavior



図 7-2. Typical Start-Up Behavior  $V_{IN} = 12V$ ,  $V_{OUT} = 5V$ ,  $I_{OUT} = 3.25A$

### 7.3.4 $\overline{RESET}$ Flag Output

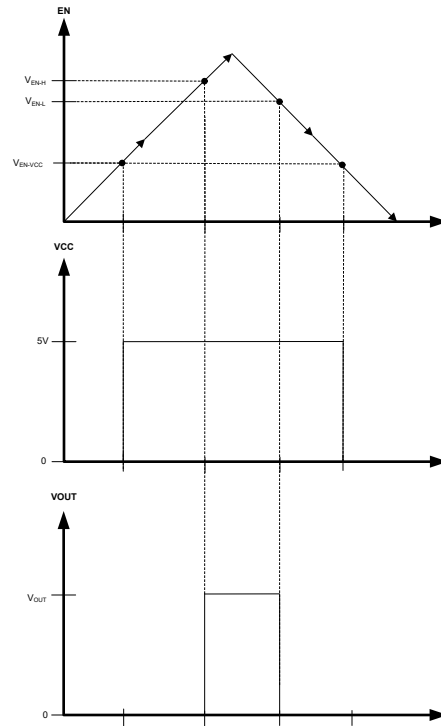
The  $\overline{RESET}$  flag function ( $\overline{RESET}$  output pin) of the LM63635C-Q1 device can be used to reset a system microprocessor whenever the output voltage is out of regulation. This open-drain output goes low under fault conditions, such as current limit and thermal shutdown, as well as during normal start-up. A glitch filter prevents false flag operation for short excursions of the output voltage, such as during line and load transients. Output voltage excursions lasting less than  $t_{dg}$  do not trip the  $\overline{RESET}$  flag. After the FB voltage has returned to the regulation value and after a delay of  $t_{rise-delay}$ , the  $\overline{RESET}$  flag goes high.  $\overline{RESET}$  operation can best be understood by reference to 図 7-3 and 図 7-4.

The  $\overline{\text{RESET}}$  output consists of an open-drain NMOS, requiring an external pullup resistor to a logic supply that can be used. The  $\overline{\text{RESET}}$  output can also be pulled up to either VCC or  $V_{\text{OUT}}$  through an appropriate resistor, as desired. Pullup resistor values in the range of 10k $\Omega$  to 100k $\Omega$  are reasonable. If this function is not needed, the  $\overline{\text{RESET}}$  pin can be left floating. When EN is pulled low, the flag output is also forced low. With EN low,  $\overline{\text{RESET}}$  remains valid as long as the input voltage is  $\geq 1.2\text{V}$  (typical). Limit the current into the  $\overline{\text{RESET}}$  flag pin to approximately 5mA. The maximum current is internally limited to approximately 50mA when the device is enabled and approximately 65mA when the device is disabled. The internal current limit protects the device from any transient currents that can occur when discharging a filter capacitor connected to this output.

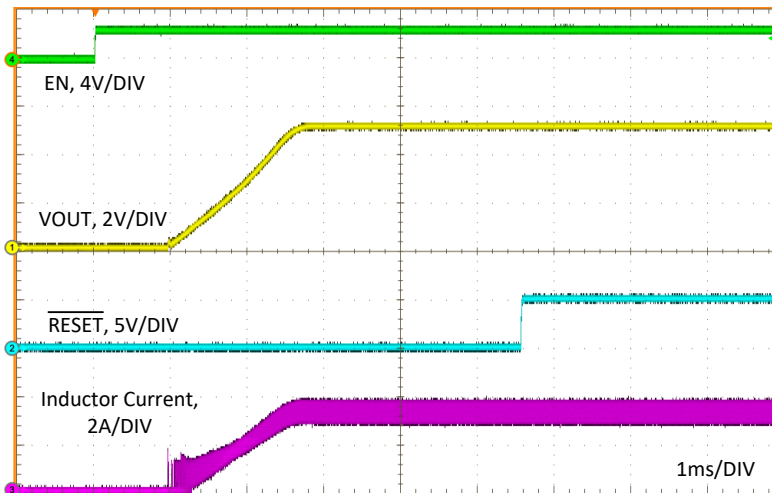

図 7-3. Static RESET Operation



図 7-4. RESET Timing Behavior

### 7.3.5 Undervoltage Lockout, Thermal Shutdown, and Output Discharge

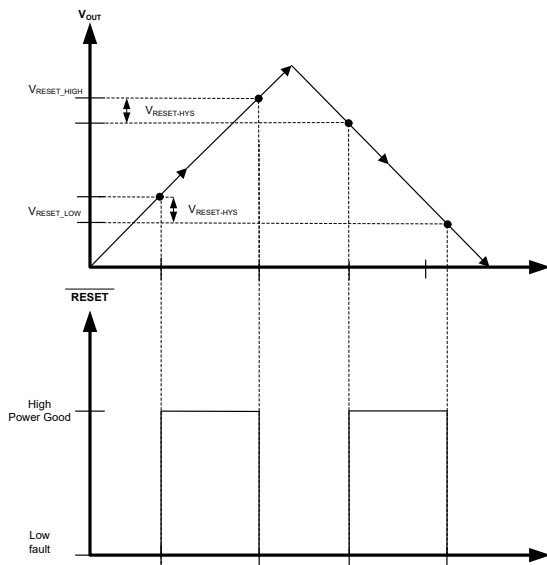
The LM63635C-Q1 incorporates an undervoltage lockout feature on the output of the internal LDO (at the VCC pin). When  $V_{\text{IN}}$  reaches approximately  $V_{\text{POR-R}}$ , the device is ready to receive an EN signal and start up. When  $V_{\text{IN}}$  falls below  $V_{\text{POR-F}}$ , the device shuts down, regardless of EN status. Because the LDO is in dropout during these transitions, the above values roughly represent the VCC voltage levels during the transitions. An extended input voltage UVLO can also be accomplished as shown in [セクション 8.2.2.7](#).

Thermal shutdown is provided to protect the regulator from excessive junction temperature. When the junction temperature reaches about 163°C, the device shuts down; restart occurs when the temperature falls to about 150°C.

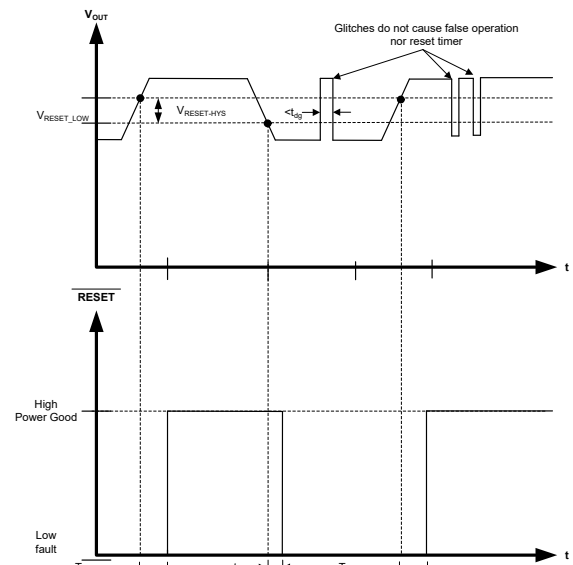
The LM63635C-Q1 features an output voltage discharge FET connected from the SW pin to ground. This FET is activated when the EN input is below  $V_{\text{EN-L}}$ , or when the output voltage exceeds  $V_{\text{RESET-HIGH}}$ . This way, the output capacitors are discharged through the power inductor. At output voltages above about 5V, the discharge current is approximately constant at  $I_{\text{POR}}$  or about 1.4mA. Below this voltage, the FET characteristic looks approximately resistive at a value of 2.5k $\Omega$ .

## 7.4 Device Functional Modes

### 7.4.1 Overview

In auto mode, the device moves between PWM and PFM as the load changes. At light loads, the regulator operates in PFM where the switching frequency is varied to regulate the output voltage. At higher loads, the mode changes to PWM with the switching frequency of the selected device.

In PWM mode, the regulator operates as a current mode, constant frequency converter using PWM to regulate the output voltage. While operating in this mode, the output voltage is regulated by switching at a constant frequency and modulating the duty cycle to control the power to the load. This action provides excellent line and load regulation and low output voltage ripple.

In PFM mode, the high-side MOSFET is turned on in a burst of one or more pulses to provide energy to the load. The duration of the burst depends on how long the inductor current takes to reach  $I_{PEAK-MIN}$ . The periodicity of these bursts is adjusted to regulate the output, while diode emulation (DEM) is used to maximize efficiency (see the [Glossary](#)). This mode provides high light-load efficiency by reducing the amount of input supply current required to regulate the output voltage at small loads. This action trades off very good light-load efficiency for larger output voltage ripple and variable switching frequency. Also, a small increase in output voltage occurs at light loads. See [セクション 8.2.3](#) for output voltage variation with load in PFM mode. [図 7-5](#) and [図 7-6](#) show the typical switching waveforms in PFM and PWM.

There are four cases where the switching frequency does not conform to the condition set by the switching frequency:

- Light load operation (auto mode)
- Dropout
- Minimum on-time operation
- Current limit

Under all of these cases, the switching frequency *folds back*, meaning less than the programmed frequency. During these conditions, by definition, the output voltage remains in regulation, except for current limit operation.

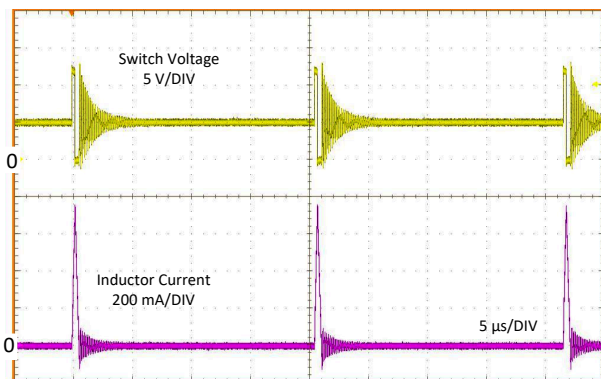

**図 7-5. Typical PFM Switching Waveforms  $V_{IN} = 12V$ ,  $V_{OUT} = 5V$ ,  $I_{OUT} = 10mA$**

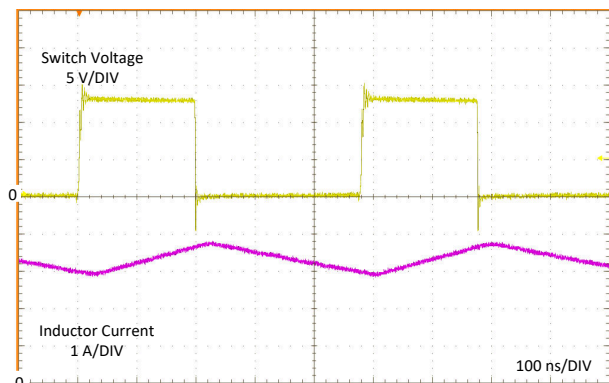

**図 7-6. Typical PWM Switching Waveforms Without Spread Spectrum  $V_{IN} = 12V$ ,  $V_{OUT} = 5V$ ,  $I_{OUT} = 3.25A$ ,  $f_{SW} = 2100kHz$**



図 7-7. Typical PWM Switching Waveforms With Spread Spectrum  $V_{IN} = 12V$ ,  $V_{OUT} = 5V$ ,  $I_{OUT} = 2.5A$ ,  $f_{SW} = 2100kHz$

### 7.4.2 Light Load Operation

During light load operation, the device is in PFM mode with DEM. This mode provides high efficiency at the lower load currents. The actual switching frequency and output voltage ripple depend on the input voltage, output voltage, and load. The output current at which the device moves in and out of PFM can be found in [セクション 8.2.3](#). The output current for mode change depends on the input voltage, inductor value, and the programmed switching frequency. The curves apply for the BOM shown in [表 8-1](#). At higher programmed switching frequencies, the load at which the mode change occurs is greater. For applications where the switching frequency must be known for a given condition, the transition between PFM and PWM must be carefully tested before the design is finalized.

### 7.4.3 Dropout Operation

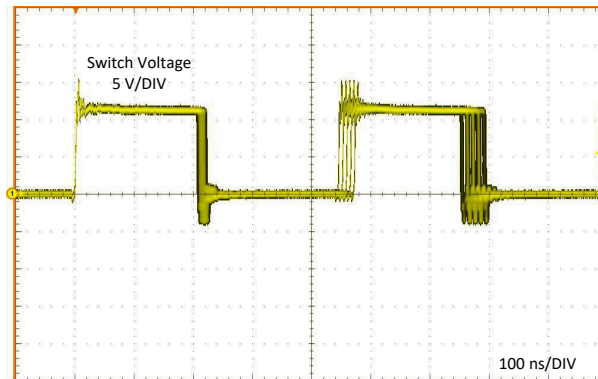
The dropout performance of any buck regulator is affected by the  $R_{DS(ON)}$  of the power MOSFETs, the DC resistance of the inductor, and the maximum duty cycle that the controller can achieve. As the input voltage level approaches the output voltage, the off-time of the high-side MOSFET starts to approach the minimum value (see [セクション 6](#)). Beyond this point, the switching can become erratic and the output voltage can fall out of regulation. To avoid this problem, the LM63635C-Q1 automatically reduces the switching frequency to increase the effective duty cycle and maintain regulation. There are two definitions of *dropout* voltage used in this data sheet. For both definitions, the dropout voltage is the difference between the input and output voltage under a specific condition. For the first definition, the difference is taken when the switching frequency has dropped to 1850kHz (this applies to cases where the nominal switching frequency is > 1850kHz). For this condition, the output voltage is within regulation. For the second definition, the difference is taken when the output voltage has fallen by 1% of the nominal regulation value. In this condition, the switching frequency has reached the lower limit of about 130kHz. See [セクション 8.2.3](#) for details on these characteristics. Typical overall dropout characteristics can be found in [図 7-8](#).





図 7-8. Overall Dropout Characteristic  $V_{OUT} = 5V$ ,  $I_{OUT} = 3.25A$

#### 7.4.4 Minimum On-Time Operation

Every switching regulator has a minimum controllable on-time dictated by the inherent delays and blanking times associated with the control circuits. This on-time imposes a minimum switch duty cycle and, therefore, a minimum conversion ratio. The constraint is encountered at high input voltages and low output voltages. To help extend the minimum controllable duty cycle, the LM63635-Q1 automatically reduces the switching frequency when the minimum on-time limit is reached. This way, the converter can regulate the lowest programmable output voltage at the maximum input voltage. Use 式 1 to find an estimate for the approximate input voltage for a given output voltage before frequency foldback occurs. The values of  $t_{ON}$  and  $f_{SW}$  can be found in セクション 6. As the input voltage is increased, the switch on-time (duty-cycle) reduces to regulate the output voltage. When the on-time reaches the limit, the switching frequency drops while the on-time remains fixed. This relationship is highlighted in  $f_{SW}$  versus  $V_{IN}$  curves in セクション 8.2.3.

$$V_{IN} \leq \frac{V_{OUT}}{t_{ON} \times f_{SW}} \quad (1)$$

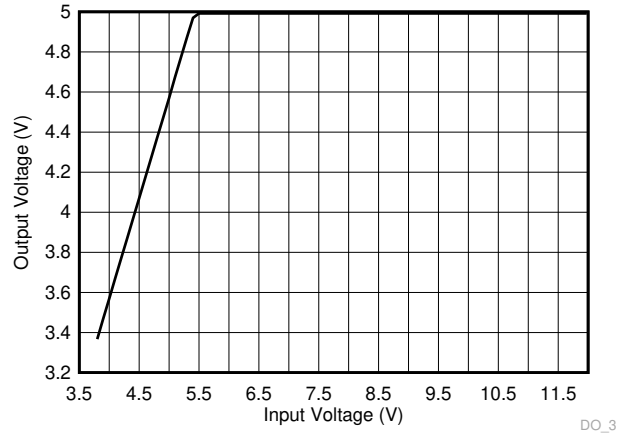
#### 7.4.5 Current Limit and Short-Circuit Operation

The LM63635C-Q1 incorporates both peak and valley inductor current limits to provide protection to the device from overloads and short circuits and limit the maximum output current. Valley current limit prevents inductor current run-away during short circuits on the output, while both peak and valley limits work together to limit the maximum output current of the converter. A hiccup type mode is also incorporated for sustained short circuits. Finally, a zero current detector is used on the low-side power MOSFET to implement DEM at light loads (see the Glossary). The nominal value of this limit is about 0A.

As the device is overloaded, a point is reached where the valley of the inductor current cannot reach below  $I_{LS-LIMIT}$  before the next clock cycle. When this event occurs, the valley current limit control skips that cycle, causing the switching frequency to drop. Further overload causes the switching frequency to continue to drop, but the output voltage remains in regulation. As the overload is increased, both the inductor current ripple and peak current increase until the high-side current limit,  $I_{SC}$ , is reached. When this limit is activated, the switch duty cycle is reduced and the output voltage falls out of regulation. This event represents the maximum output current from the converter and is given approximately by 式 2. The output voltage and switching frequency continue to drop as the device moves deeper into overload while the output current remains at approximately  $I_{OMAX}$ . If the inductor ripple current is large, the high-side current limit can be tripped before the low-side limit is reached. In this case, 式 3 gives the approximate maximum output current.

$$I_{OMAX} \approx \frac{I_{SC} + I_{LS-LIMIT}}{2} \quad (2)$$

$$I_{OMAX} \approx I_{SC} - \frac{(V_{IN} - V_{OUT})}{2 \times L \times f_{SW}} \times \frac{V_{OUT}}{V_{IN}} \quad (3)$$

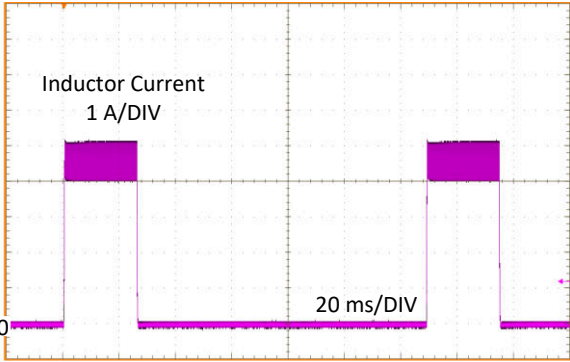
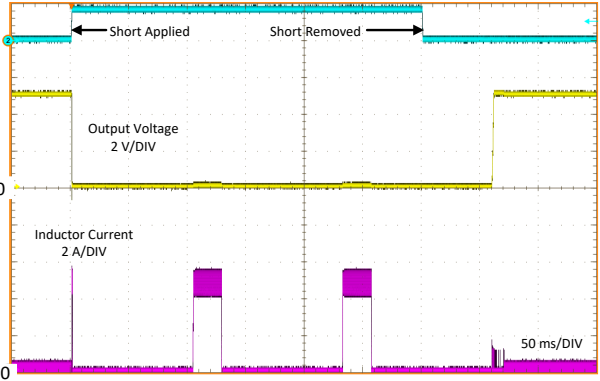
If a severe overload or short circuit causes the FB voltage to fall below  $V_{HICCUP}$ , the convert enters hiccup mode.  $V_{HICCUP}$  represents about 40% of the nominal programmed output voltage. In this mode, the device stops switching for  $t_{OC}$ , or about 100ms, and then goes through a normal restart with soft start. If the short-circuit condition remains, the device runs in current limit for a little longer than  $t_{OC\_active}$ , or about 23ms, and then shuts down again. This cycle repeats (as shown in ) as long as the short-circuit condition persists. This mode of operation reduces the temperature rise of the device during a sustained short on the output. The output current in this mode is approximately 20% of  $I_{OMAX}$ . After the output short is removed and the  $t_{OC}$  delay is passed, the output voltage recovers normally as shown in .

See  for the overall output voltage versus output current characteristic.

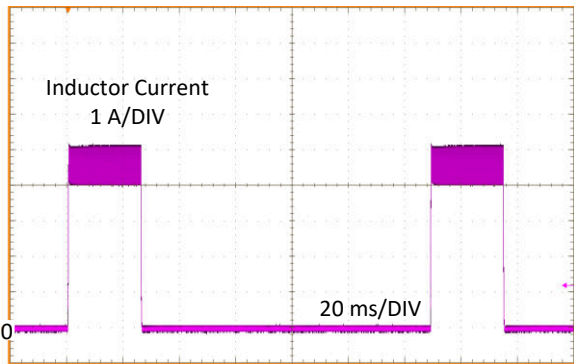

 7-9. Inductor Current Burst in Short-Circuit Mode

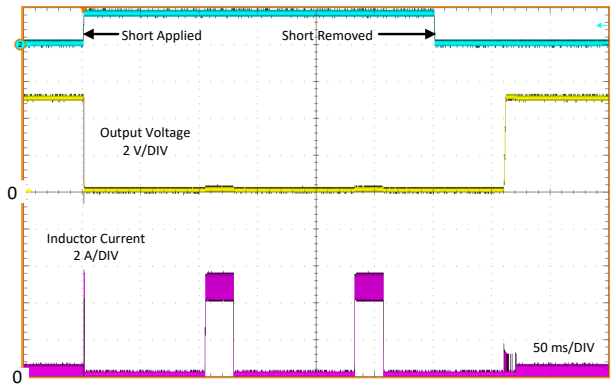

 7-10. Short-Circuit Transient and Recovery

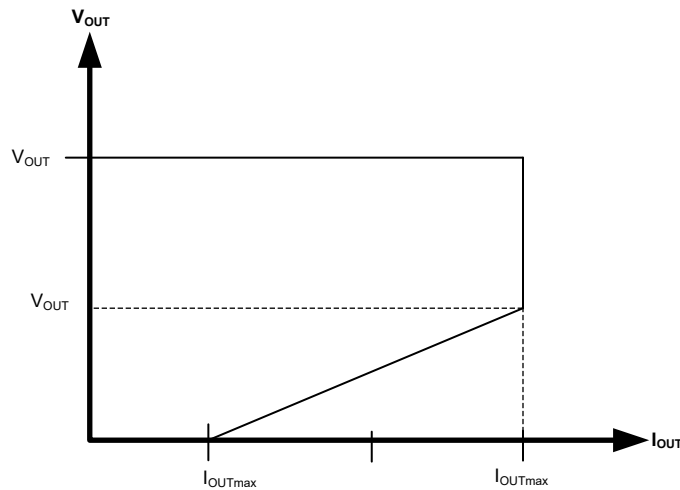

 7-11. Output Voltage versus Output Current in Current Limit

## 8 Application and Implementation

### 注

Information in the following applications sections is not part of the TI component specification, and TI does not warrant its accuracy or completeness. TI's customers are responsible for determining suitability of components for their purposes, as well as validating and testing their design implementation to confirm system functionality.

### 8.1 Application Information

The LM63635C-Q1 step-down DC-to-DC converter is typically used to convert a higher DC voltage to a lower DC voltage with a maximum output current of 3.25A. The following design procedure can be used to select components for the LM63635C-Q1.

### 注

In this data sheet, the *effective* value of capacitance is defined as the actual capacitance under D.C. bias and temperature, not the rated or nameplate values. Use high-quality, low-ESR, ceramic capacitors with an X5R or better dielectric throughout. All high value ceramic capacitors have a large voltage coefficient in addition to normal tolerances and temperature effects. Under D.C. bias, the capacitance drops considerably. Large case sizes and higher voltage ratings are better in this regard. To help mitigate these effects, multiple capacitors can be used in parallel to bring the minimum *effective* capacitance up to the required value. This use can also ease the RMS current requirements on a single capacitor. A careful study of bias and temperature variation of any capacitor bank must be made to make sure that the minimum value of *effective* capacitance is provided.

### 8.2 Typical Application

Figure 8-1 shows a typical application circuit for the LM63635C-Q1. This device is designed to function over a wide range of external components and system parameters. However, the internal compensation is optimized for a certain range of external inductance and output capacitance. As a quick start guide, see Table 8-1 for typical component values.

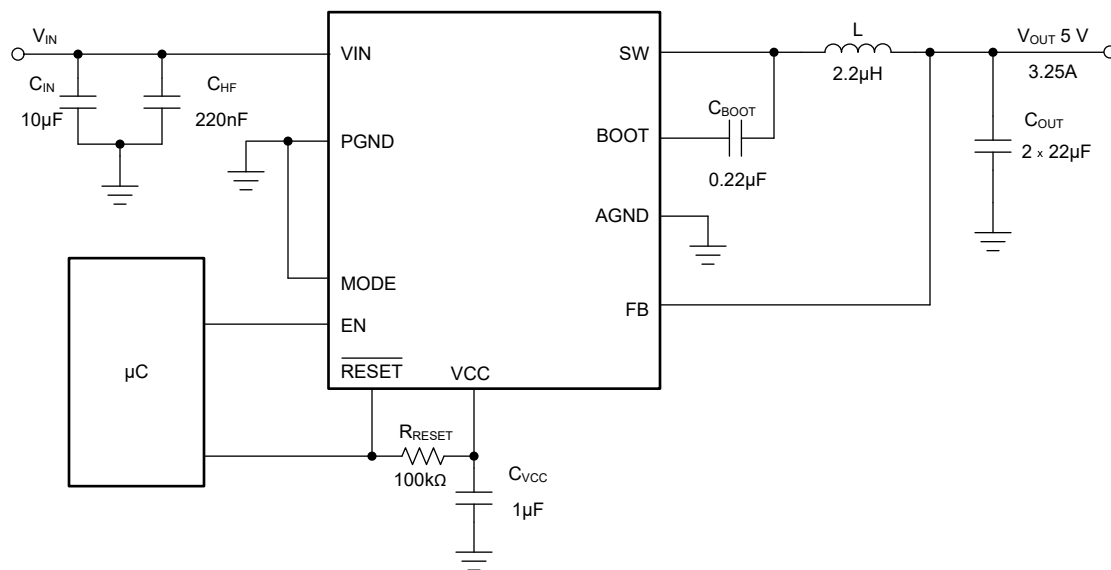

Figure 8-1. Example Application Circuit  $V_{IN} = 12V$ ,  $V_{OUT} = 5V$ ,  $I_{OUT} = 3.25A$ ,  $f_{SW} = 2.1MHz$

表 8-1. Typical External Component Values for 3.25A Output Current

| $f_{SW}$ (kHz) | $V_{OUT}$ | L ( $\mu$ H) <sup>(1)</sup> | TYPICAL <sup>(2)</sup> $C_{OUT}$ | MINIMUM <sup>(2)</sup> $C_{OUT}$ | $C_{IN}$           | $C_{BOOT}$ | $C_{VCC}$ |
|----------------|-----------|-----------------------------|----------------------------------|----------------------------------|--------------------|------------|-----------|
| 400            | 3.3       | 10                          | 3 × 22 $\mu$ F                   | 2 × 22 $\mu$ F                   | 10 $\mu$ F + 220nF | 220nF      | 1 $\mu$ F |
| 2100           | 3.3       | 2.2                         | 2 × 22 $\mu$ F                   | 1 × 22 $\mu$ F + 1 × 10 $\mu$ F  | 10 $\mu$ F + 220nF | 220nF      | 1 $\mu$ F |
| 400            | 5         | 10                          | 3 × 22 $\mu$ F                   | 2 × 22 $\mu$ F                   | 10 $\mu$ F + 220nF | 220nF      | 1 $\mu$ F |
| 2100           | 5         | 2.2                         | 2 × 22 $\mu$ F                   | 1 × 22 $\mu$ F + 1 × 10 $\mu$ F  | 10 $\mu$ F + 220nF | 220nF      | 1 $\mu$ F |

(1) See the [セクション 8.2.2.2](#).(2) See the [セクション 8.2.2.3](#).

## 8.2.1 Design Requirements

表 8-2 provides the parameters for the detailed design procedure:

表 8-2. Detailed Design Parameters

| DESIGN PARAMETER       | EXAMPLE VALUE   |
|------------------------|-----------------|
| Input voltage          | 12V (6V to 32V) |
| Output voltage         | 5V              |
| Maximum output current | 0A to 3.25A     |
| Switching frequency    | 2.1MHz          |

## 8.2.2 Detailed Design Procedure

The following design procedure applies to [図 8-1](#) and [表 8-2](#).

### 8.2.2.1 Choosing the Switching Frequency

The choice of switching frequency is a compromise between conversion efficiency and overall design size. Lower switching frequency implies reduced switching losses and usually results in higher system efficiency. However, higher switching frequency allows the use of smaller inductors and output capacitors, and hence, a more compact design. There are several options to set the switching frequency of the LM63635C-Q1. The internal switching frequency is set at 400kHz or 2.1MHz. For the application example, the switching frequency ( $F_{sw}$ ) was chosen to be 2.1MHz.

### 8.2.2.2 Inductor Selection

The parameters for selecting the inductor are the inductance and saturation current. The inductance is based on the desired peak-to-peak ripple current and is normally chosen to be in the range of 20% to 40% of the maximum output current. Experience shows that the best value for inductor ripple current is 30% of the maximum load current. Larger values of ripple current can restrict the maximum output current, before current limit is reached. This trade-off can be examined with the help of [式 2](#) and the ensured current limits found in [セクション 6](#). Smaller values of ripple current reduce the SNR of the current mode controller and can lead to increased jitter in the duty cycle. Both the inductor and switching frequency tolerance have an impact on the selection of ripple current, and, therefore, inductor value. Use the maximum device current when calculating the ripple current for applications with much smaller maximum load than the maximum available from the device. The ratio of inductor ripple current over maximum output current is designated as K in the following equations. [式 4](#) can be used to determine the value of inductance. K = 0.2 was chosen for this example and L = 2.1 $\mu$ H inductance was found. A standard value of 2.2 $\mu$ H was selected. This gives a new K = 0.19.

$$L = \frac{(V_{IN} - V_{OUT})}{f_{SW} \times K \times I_{OUTmax}} \times \frac{V_{OUT}}{V_{IN}} \quad (4)$$

Ideally, the saturation current rating of the inductor is at least as large as the high-side switch current limit,  $I_{SC}$  (see [セクション 6](#)). This size makes sure that the inductor does not saturate even during a short circuit on the output. When the inductor core material saturates, the inductance falls to a very low value, causing the inductor

current to rise very rapidly. Although the valley current limit,  $I_{LIMIT}$ , is designed to reduce the risk of current run-away, a saturated inductor can cause the current to rise to high values very rapidly. This can lead to component damage. Do not allow the inductor to saturate. Inductors with a ferrite core material have very *hard* saturation characteristics, but usually have lower core losses than powdered iron cores. Powdered iron cores exhibit a *soft* saturation, allowing some relaxation in the current rating of the inductor. However, powdered iron cores have more core losses at frequencies above about 1MHz. In any case, the inductor saturation current must not be less than the maximum peak inductor current at full load.

To avoid subharmonic oscillation, the inductance value must not be less than that given in 式 5. The maximum inductance is limited by the minimum current ripple required for the current mode control to perform correctly. As a rule-of-thumb, the minimum inductor ripple current must be no less than about 10% of the device maximum rated current under nominal conditions.

$$L_{MIN} \geq M \times \frac{V_{OUT}}{f_{SW}} \quad (5)$$

where

- $M = 0.37$  for 3.25A device

### 8.2.2.3 Output Capacitor Selection

The value of the output capacitor and the ESR determine the output voltage ripple and load transient performance. The output capacitor bank is usually limited by the load transient requirements rather than the output voltage ripple. Use 式 6 to estimate a lower bound on the total output capacitance, and an upper bound on the ESR, which are required to meet a specified load transient.

$$C_{OUT} \geq \frac{\Delta I_{OUT}}{f_{SW} \times \Delta V_{OUT} \times K} \times \left[ (1 - D) \times (1 + K) + \frac{K^2}{12} \times (2 - D) \right] \quad D = \frac{V_{OUT}}{V_{IN}} \quad (6)$$

$$ESR \leq \frac{(2 + K) \times \Delta V_{OUT}}{2 \times \Delta I_{OUT} \times \left[ 1 + K + \frac{K^2}{12} \times \left( 1 + \frac{1}{(1 - D)} \right) \right]}$$

where

- $\Delta V_{OUT}$  = output voltage transient
- $\Delta I_{OUT}$  = output current transient
- $K$  = ripple factor from [セクション 8.2.2.2](#)

After the output capacitor and ESR have been calculated, use 式 7 to check the peak-to-peak output voltage ripple,  $V_r$ .

$$V_r \cong \Delta I_L \times \sqrt{ESR^2 + \frac{1}{(8 \times f_{SW} \times C_{OUT})^2}} \quad (7)$$

The output capacitor and ESR can then be adjusted to meet both the load transient and output ripple requirements.

This example requires a  $\Delta V_{OUT}$  of  $\leq 200\text{mV}$  for an output current step of  $\Delta I_{OUT} = 3.25\text{A}$ . 式 6 gives a minimum value of  $28\mu\text{F}$  and a maximum ESR of  $0.056\Omega$ . Assuming a 20% tolerance and a 10% bias derating, the user arrives at a minimum capacitance of  $39\mu\text{F}$ . This capacitance can be achieved with a bank of  $2 \times 22\mu\text{F}$ , 16V, ceramic capacitors in the 1210 case size. More output capacitance can be used to improve the load transient response. Ceramic capacitors can easily meet the minimum ESR requirements. In some cases, an aluminum electrolytic capacitor can be placed in parallel with the ceramics to build up the required value of capacitance. When using a mixture of aluminum and ceramic capacitors, use the minimum recommended value of ceramics and add aluminum electrolytic capacitors as needed.

In general, use a capacitor rating of at least 10V for output voltages of 3.3V or less, and use a capacitor of 16V or more for output voltages of 5V and above.

The recommendations given in 表 8-1 provide typical and minimum values of output capacitance for the given conditions. These values are the rated or nameplate figures. If the minimum values are to be used, the design must be tested over all of the expected application conditions, including input voltage, output current, and ambient temperature. This testing must include both bode plot and load transient assessments. The maximum value of total output capacitance must be limited to about 10 times the design value, or 1000μF, whichever is smaller. Large values of output capacitance can adversely affect the start-up behavior of the regulator as well as the loop stability. If values larger than noted here must be used, then a careful study of start-up at full load and loop stability must be performed.

In practice, the output capacitor has the most influence on the transient response and loop phase margin. Load transient testing and bode plots are the best way to validate any given design and must always be completed before the application goes into production. In addition to the required output capacitance, a small ceramic placed on the output can reduce high frequency noise. Small case size ceramic capacitors in the range of 1nF to 100nF can help reduce spikes on the output caused by inductor and board parasitics.

#### 8.2.2.4 Input Capacitor Selection

The ceramic input capacitors provide a low impedance source to the regulator in addition to supplying the ripple current and isolating switching noise from other circuits. A minimum of 4.7μF of ceramic capacitance is required on the input of the LM63635C-Q1, connected directly between VIN and PGND. This must be rated for at least the maximum input voltage that the application requires; preferably twice the maximum input voltage. This capacitance can be increased to help reduce input voltage ripple and maintain the input voltage during load transients. More input capacitance is required for larger output currents. In addition, a small case size, 220nF ceramic capacitor must be used at the input as close a possible to the regulator, typically within 1mm of the VIN and PGND pins. This placement provides a high frequency bypass for the control circuits internal to the device. For this example, a 10μF, 50V, X7R (or better) ceramic capacitor is chosen. Two 4.7μF capacitors can also be used. The 220nF must also be rated at 50V with an X7R dielectric and preferably a small case size, such as an 0603.

Many times, Using an electrolytic capacitor on the input in parallel with the ceramics is desirable. This statement is especially true if long leads or traces are used to connect the input supply to the regulator. The moderate ESR of this capacitor can help damp any ringing on the input supply caused by the long power leads. The use of this additional capacitor also helps with voltage dips caused by input supplies with unusually high impedance.

Most of the input switching current passes through the ceramic input capacitor or capacitors. Use 式 8 to calculate the approximate RMS current. Check this value against the manufacturer maximum ratings.

$$I_{RMS} \cong \frac{I_{OUT}}{2} \quad (8)$$

#### 8.2.2.5 C<sub>BOOT</sub>

The LM63635C-Q1 requires a bootstrap capacitor to be connected between the BOOT pin and the SW pin. This capacitor stores energy that is used to supply the gate drivers for the power MOSFETs. A high-quality ceramic capacitor of 220nF and at least 16V is required.

#### 8.2.2.6 VCC

The VCC pin is the output of the internal LDO used to supply the control circuits of the regulator. This output requires a 1μF, 16V ceramic capacitor connected from VCC to PGND for proper operation. In general, this output must not be loaded with any external circuitry. However, this output can be used to supply the pullup for the RESET function and as a logic supply for the various control inputs of the device. A value of 100kΩ is a good choice for the RESET flag pullup resistor. The nominal output voltage on VCC is 5V.

### 8.2.2.7 External UVLO

In some cases, an input UVLO level different than that provided internal to the device is needed. This need can be accomplished by using the circuit shown in [Figure 8-2](#). The input voltage at which the device turns on is designated as  $V_{ON}$  while the turnoff voltage is  $V_{OFF}$ . First, a value for  $R_{ENB}$  is chosen in the range of 10kΩ to 100kΩ. Then, use [Equation 9](#) to calculate  $R_{ENT}$  and  $V_{OFF}$ .

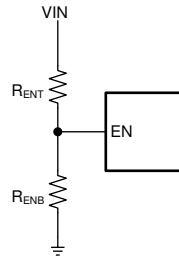

**Figure 8-2. Setup for External UVLO Application**

$$R_{ENT} = R_{ENB} \times \left( \frac{V_{ON}}{V_{EN-H}} - 1 \right) V_{OFF} = V_{EN-l} \times \left( \frac{V_{ON}}{V_{EN-H}} \right) \quad (9)$$

where

- $V_{ON} = V_{IN}$  turn-on voltage
- $V_{OFF} = V_{IN}$  turn-off voltage

### 8.2.2.8 Maximum Ambient Temperature

As with any power conversion device, the LM63635C-Q1 dissipates internal power while operating. The effect of this power dissipation is to raise the internal temperature of the converter above ambient. The internal die temperature ( $T_J$ ) is a function of the ambient temperature, the power loss, and the effective thermal resistance,  $R_{\theta JA}$ , of the device, and PCB combination. The maximum internal die temperature for the LM63635C-Q1 must be limited to 150°C. This limit establishes a limit on the maximum device power dissipation and, therefore, the load current. [Equation 10](#) shows the relationships between the important parameters. Seeing that larger ambient temperatures ( $T_A$ ) and larger values of  $R_{\theta JA}$  reduce the maximum available output current is easy. The converter efficiency can be estimated by using the curves provided in this data sheet. Note that these curves include the power loss in the inductor. If the desired operating conditions cannot be found in one of the curves, then interpolation can be used to estimate the efficiency. Alternatively, the EVM can be adjusted to match the desired application requirements and the efficiency can be measured directly. The correct value of  $R_{\theta JA}$  is more difficult to estimate. As stated in the [Semiconductor and IC Package Thermal Metrics application report](#), the value of  $R_{\theta JA}$  given in the [Section 6.4](#) table is not valid for design purposes and must not be used to estimate the thermal performance of the application. The values reported in that table were measured under a specific set of conditions that are rarely obtained in an actual application. The data given for  $R_{\theta JC(bott)}$  and  $\Psi_{JT}$  can be useful when determining thermal performance. See the [Semiconductor and IC Package Thermal Metrics application report](#) for more information and the resources given at the end of this section.

$$I_{OUTmax} = \frac{(T_J - T_A)}{R_{\theta JA}} \times \frac{\eta}{(1 - \eta)} \times \frac{1}{V_{OUT}} \quad (10)$$

where

- $\eta$  = efficiency

The effective  $R_{\theta JA}$  is a critical parameter and depends on many factors such as the following:

- Power dissipation
- Air temperature and flow
- PCB area

- Copper heat-sink area
- Number of thermal vias under the package
- Adjacent component placement

The WSON12 package uses a die attach paddle, or "thermal pad" (DAP), to provide a place to solder down to the PCB heat-sinking copper. This usage provides a good heat conduction path from the regulator junction to the heat sink and must be properly soldered to the PCB heat sink copper. Typical examples of  $R_{\theta JA}$  versus copper board area can be found in [Figure 8-3](#). The copper area given in the graph is for each layer. The top and bottom layers are 2oz copper each, while the inner layers are 1 oz. [Figure 8-4](#) shows a typical curve of maximum output current versus ambient temperature. This data was taken with a device and PCB combination, giving an  $R_{\theta JA}$  of approximately 22°C/W. Remember that the data given in these graphs are for illustration purposes only, and the actual performance in any given application depends on all of the previously mentioned factors.

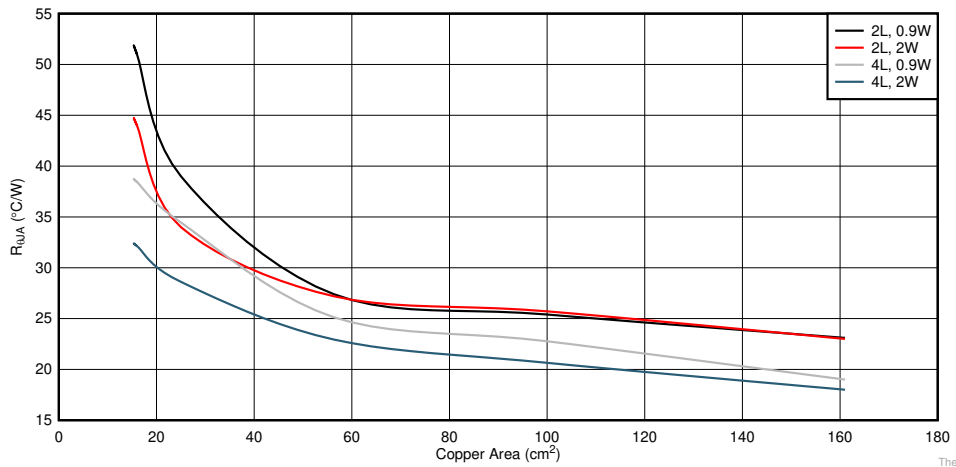

**Figure 8-3. Typical  $R_{\theta JA}$  vs Copper Area for the WSON Package**

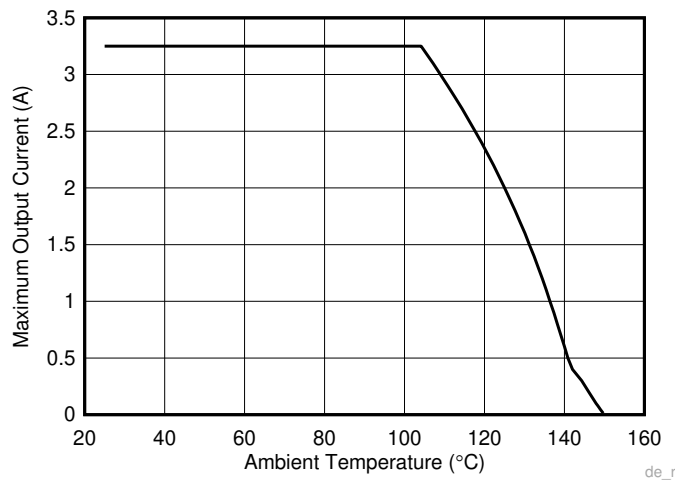

**Figure 8-4. Maximum Output Current versus Ambient Temperature  $V_{IN} = 12V$ ,  $V_{OUT} = 5V$ ,  $f_{SW} = 400kHz$ ,  $R_{\theta JA} = 22^\circ C/W$**



The following resources can be used as a guide to excellent thermal PCB design and estimating  $R_{\theta JA}$  for a given application environment:

- [AN-2020 Thermal Design By Insight, Not Hindsight application report](#)
- [A Guide to Board Layout for Best Thermal Resistance for Exposed Pad Packages application report](#)
- [Semiconductor and IC Package Thermal Metrics application report](#)
- [Thermal Design Made Simple with LM43603 and LM43602 application report](#)



- [Using New Thermal Metrics application report](#)

### 8.2.3 Application Curves

Unless otherwise specified, the following conditions apply:  $V_{IN} = 13.5V$ ,  $T_A = 25^\circ C$ .  8-1 shows the circuit with the appropriate BOM from  8-1.

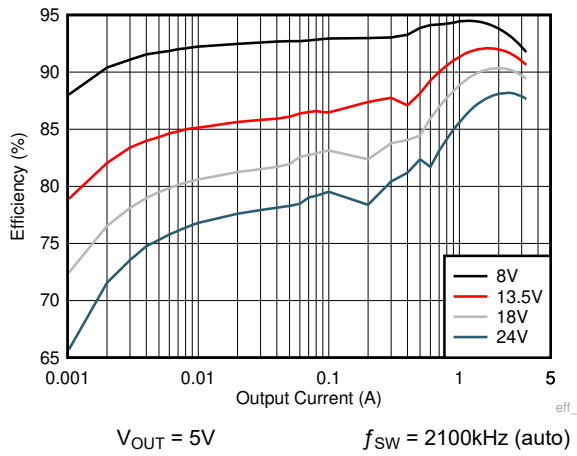

 8-5. Efficiency

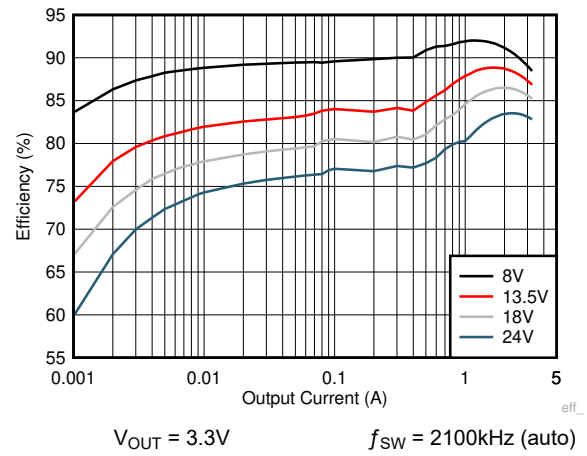

 8-6. Efficiency

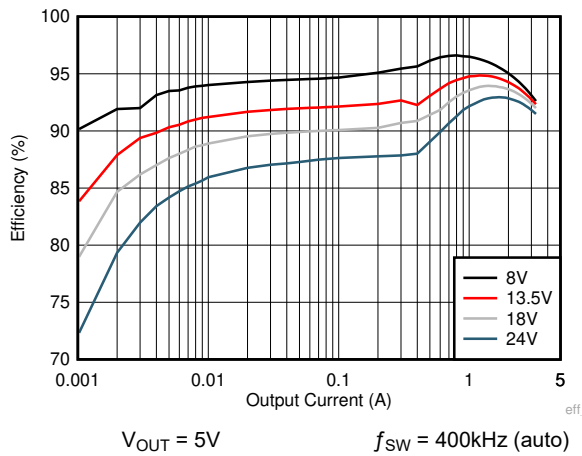

 8-7. Efficiency

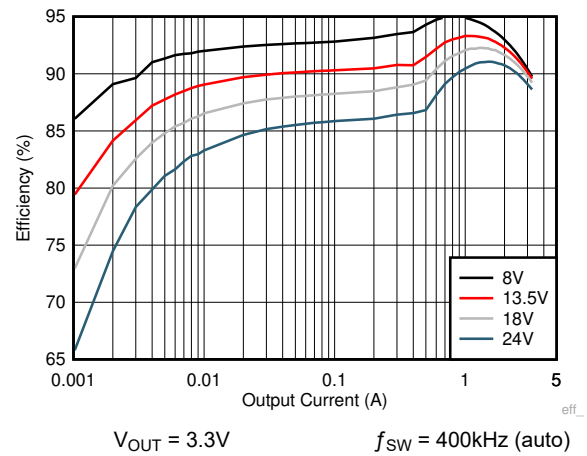

 8-8. Efficiency

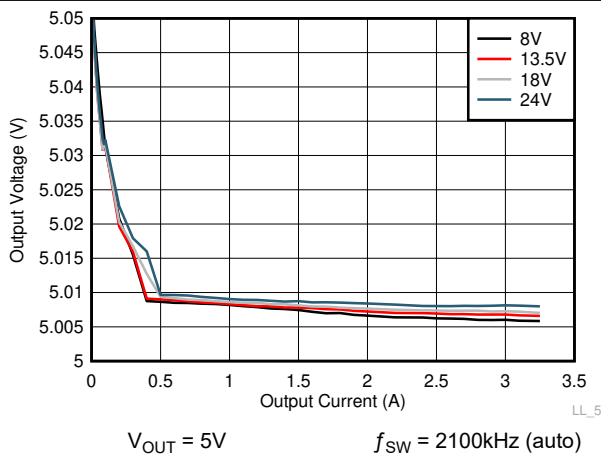

 8-9. Line and Load Regulation

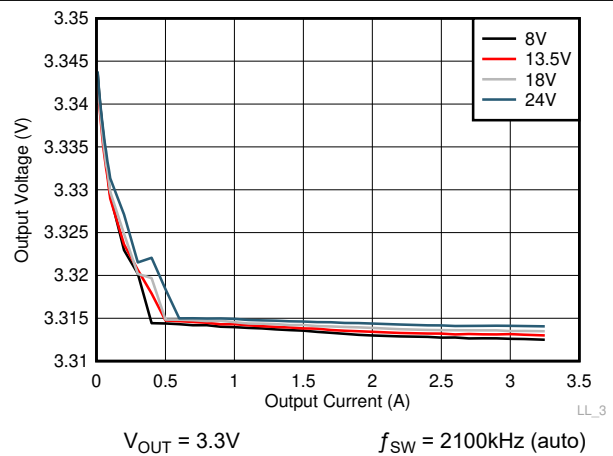

 8-10. Line and Load Regulation

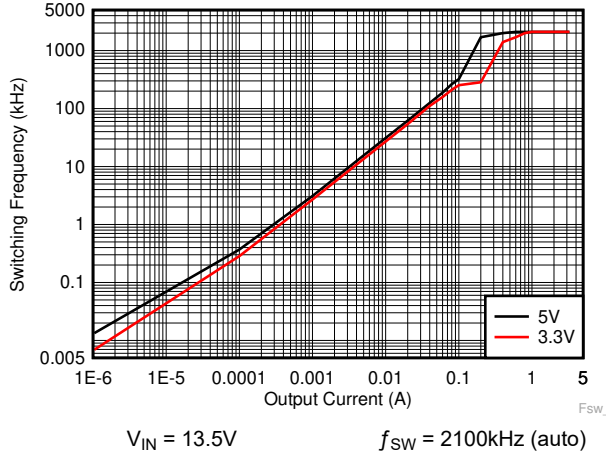

8-11. Switching Frequency versus Output Current

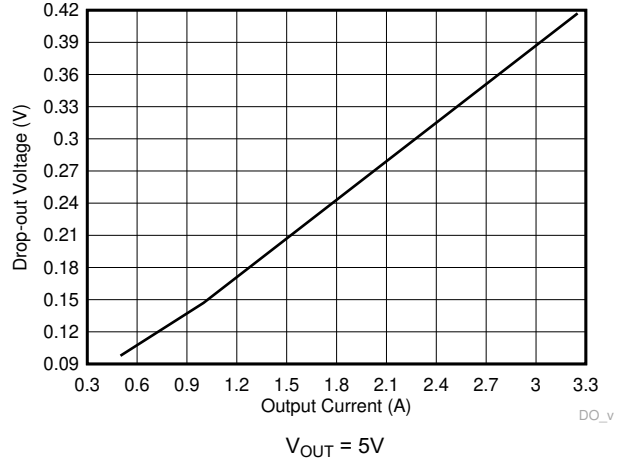

8-12. Dropout Voltage versus Output Current for -1% Drop

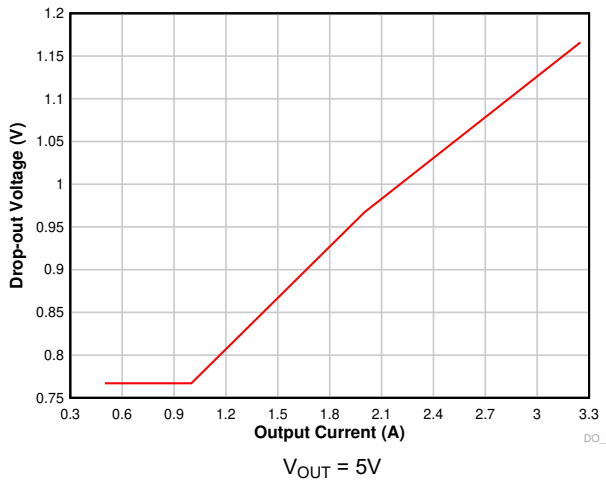

8-13. Dropout Voltage versus Output Current to 1.85MHz

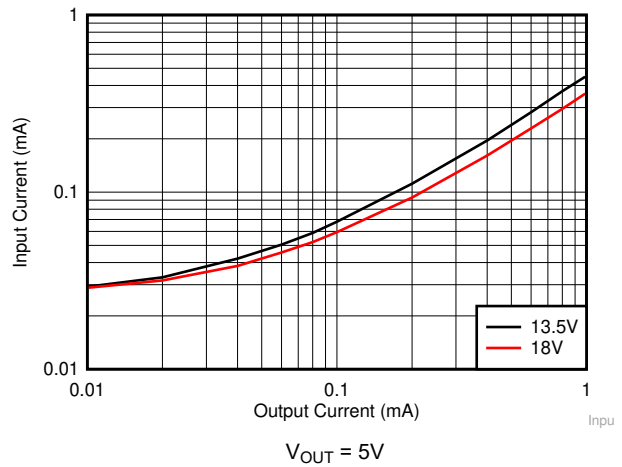

8-14. Input Supply Current versus Output Current

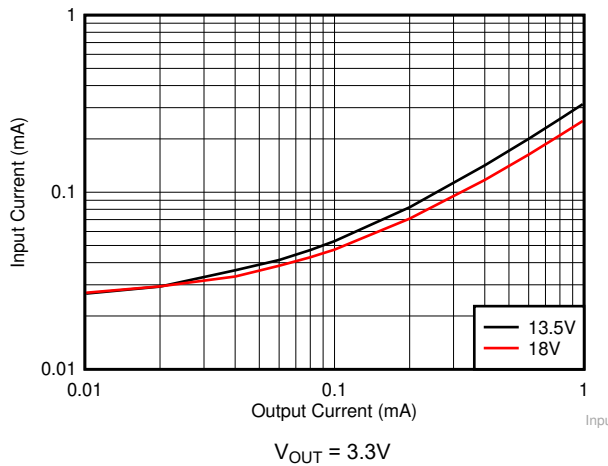

8-15. Input Supply Current versus Output Current

### 8.2.4 EMI Performance Curves

EMI results critically depend on PCB layout and test setup. The results given here are typical and given for information purposes only. [図 8-18](#) shows the used EMI filter. The limit lines shown refer to CISPR25 class 5.

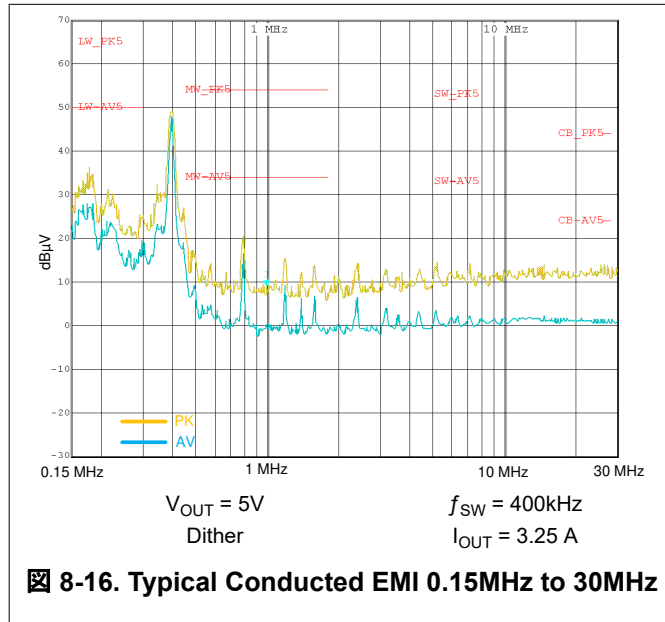

**図 8-16. Typical Conducted EMI 0.15MHz to 30MHz**

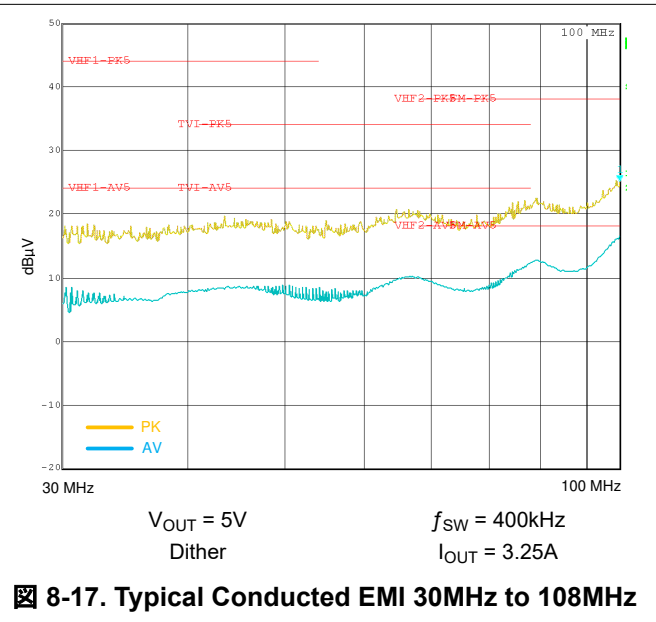

**図 8-17. Typical Conducted EMI 30MHz to 108MHz**

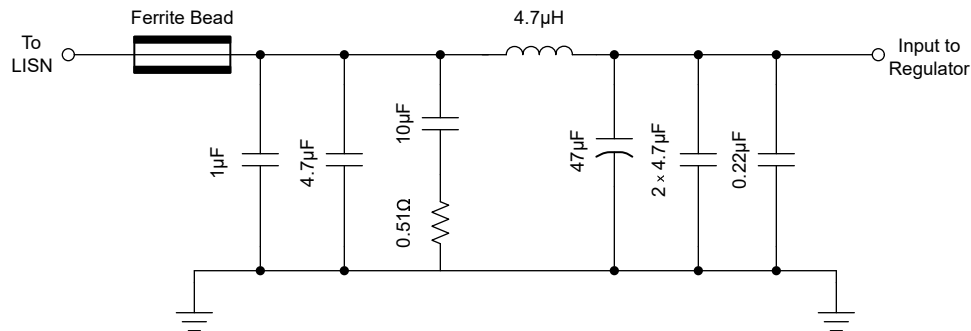

A. Input filter used only for EMI measurements shown in [セクション 8.2.4](#).

**図 8-18. Typical Input EMI Filter**

### 8.3 Best Design Practices

- Do not exceed the [Absolute Maximum Ratings](#).
- Do not exceed the [Recommended Operating Conditions](#).
- Do not exceed the [ESD Ratings](#).
- Do not allow the EN input to float.
- Do not allow the output voltage to exceed the input voltage, nor go below ground.
- Do not use the value of  $R_{\theta JA}$  given in the [Thermal Information](#) table to design your application. See [セクション 8.2.2.8](#).
- Follow all the guidelines and suggestions found in this data sheet before committing the design to production. TI application engineers are ready to help critique your design and PCB layout to help make your project a success.
- Use a 220nF capacitor connected directly to the VIN and PGND pins of the device. See [セクション 8.2.2.4](#) for details.

## 8.4 Power Supply Recommendations

The characteristics of the input supply must be compatible with the limits found in [セクション 6](#) of this data sheet. In addition, the input supply must be capable of delivering the required input current to the loaded regulator. Estimate the average input current with [式 11](#).

$$I_{IN} = \frac{V_{OUT} \times I_{OUT}}{V_{IN} \times \eta} \quad (11)$$

where

- $\eta$  is the efficiency

If the regulator is connected to the input supply through long wires or PCB traces, special care is required to achieve good performance. The parasitic inductance and resistance of the input cables can have an adverse effect on the operation of the regulator. The parasitic inductance, in combination with the low-ESR, ceramic input capacitors, can form an under-damped resonant circuit, resulting in overvoltage transients at the input to the regulator. The parasitic resistance can cause the voltage at the VIN pin to dip whenever a load transient is applied to the output. If the application is operating close to the minimum input voltage, this dip can cause the regulator to momentarily shutdown and reset. The best way to solve these kind of issues is to reduce the distance from the input supply to the regulator and use an aluminum or tantalum input capacitor in parallel with the ceramics. The moderate ESR of these types of capacitors help damp the input resonant circuit and reduce any overshoots. A value in the range of 20 $\mu$ F to 100 $\mu$ F is usually sufficient to provide input damping and help hold the input voltage steady during large load transients.

TI recommends that the input supply must not be allowed to fall below the output voltage by more than 0.3V. Under such conditions, the output capacitors discharges through the body diode of the high-side power MOSFET. The resulting current can cause unpredictable behavior, and in extreme cases, possible device damage. If the application allows for this possibility, then use a Schottky diode from VIN to VOUT to provide a path around the regulator for this current.

In some cases, a transient voltage suppressor (TVS) is used on the input of regulators. One class of this device has a *snap-back* characteristic (thyristor type). TI does not recommend the use of a device with this type of characteristic. When the TVS fires, the clamping voltage falls to a very low value. If this voltage is less than the output voltage of the regulator, the output capacitors discharges through the device, as mentioned above.

Sometimes, for other system considerations, an input filter is used in front of the regulator. This use can lead to instability as well as some of the effects mentioned above, unless designed carefully. The [AN-2162 Simple Success with Conducted EMI from DCDC Converters application report](#) provides helpful suggestions when designing an input filter for any switching regulator.

## 8.5 Layout

### 8.5.1 Layout Guidelines

The PCB layout of any DC/DC converter is critical to the optimal performance of the design. Bad PCB layout can disrupt the operation of an otherwise good schematic design. Even if the converter regulates correctly, bad PCB layout can mean the difference between a robust design and one that cannot be mass produced. Furthermore, the EMI performance of the regulator is dependent on the PCB layout to a great extent. In a buck converter, the most critical PCB feature is the loop formed by the input capacitors and power ground, as shown in [図 8-19](#). This loop carries large transient currents that can cause large transient voltages when reacting with the trace inductance. These unwanted transient voltages disrupt the proper operation of the converter. Because of this disruption, the traces in this loop must be wide and short, and the loop area as small as possible to reduce the parasitic inductance. [図 8-20](#) shows a recommended layouts for the critical components of the LM63635-Q1.

1. *Place the input capacitors as close as possible to the VIN and PGND terminals.* VIN and PGND pins are adjacent, simplifying the input capacitor placement. TI does not recommend thermal reliefs in this area.
2. *Place a bypass capacitor for VCC close to the VCC pin.* Place this capacitor close to the device and routed with short, wide traces to the VCC and PGND pins. TI does not recommend thermal reliefs in this area.

3. *Use wide traces for the  $C_{BOOT}$  capacitor.* Place  $C_{BOOT}$  close to the device with short and wide traces to the BOOT and SW pins. TI does not recommend thermal reliefs in this area.
4. *Place the feedback divider as close as possible to the FB pin of the device.* If an external feedback divider is used with the ADJ option, place  $R_{FBB}$ ,  $R_{FBT}$ , and  $C_{FF}$  close to the device. The connections to FB and AGND must be short and close to those pins on the device. The connection to  $V_{OUT}$  can be somewhat longer. However, this latter trace must not be routed near any noise source (such as the SW node) that can capacitively couple into the feedback path of the regulator.
5. *Use at least one ground plane in one of the middle layers.* This plane acts as a noise shield and also act as a heat dissipation path.
6. *Connect the thermal pad to the ground plane.* The thermal pad (DAP) connection must be soldered down to the PCB ground plane. This pad acts as a heat-sink connection and an electrical ground connection for the regulator. The integrity of this solder connection has a direct bearing on the total effective  $R_{\theta JA}$  of the application. TI does not recommend thermal reliefs in this area.
7. *Provide wide paths for VIN, VOUT, SW, and PGND.* Making these paths as wide and direct as possible reduces any voltage drops on the input or output paths of the converter and maximizes efficiency. TI does not recommend thermal reliefs in this area.
8. *Provide enough PCB area for proper heat-sinking.* As stated in [セクション 8.2.2.8](#), enough copper area must be used to make sure of a low  $R_{\theta JA}$ , commensurate with the maximum load current and ambient temperature. The top and bottom PCB layers must be made with 2oz copper and no less than one ounce. Use an array of heat-sinking vias to connect the thermal pad (DAP) to the ground plane on the bottom PCB layer. If the PCB design uses multiple copper layers (recommended), these thermal vias can also be connected to the inner layer heat-spreading ground planes.
9. *Keep switch area small.* Keep the copper area connecting the SW pin to the inductor as short and wide as possible. At the same time, the total area of this node must be minimized to help reduce radiated EMI.

See the following PCB layout resources for additional important guidelines:

- [Layout Guidelines for Switching Power Supplies application report](#)
- [Simple Switcher PCB Layout Guidelines Application Report](#)
- [Construction Your Power Supply- Layout Considerations seminar](#)
- [Low Radiated EMI Layout Made Simple with LM4360x and LM4600x application report](#)



图 8-19. Current Loops With Fast Edges

### 8.5.1.1 Ground and Thermal Considerations

As mentioned above, TI recommends using one of the middle layers as a solid ground plane. A ground plane provides shielding for sensitive circuits and traces. A ground plane also provides a quiet reference potential for the control circuitry. Connect the AGND and PGND pins to the ground planes using vias next to the bypass

capacitors. PGND pins are connected directly to the source of the low-side MOSFET switch and also connected directly to the grounds of the input and output capacitors. The PGND net contains noise at the switching frequency and can bounce due to load variations. The PGND trace, as well as the VIN and SW traces, must be constrained to one side of the ground planes. The other side of the ground plane contains much less noise and must be used for sensitive routes.

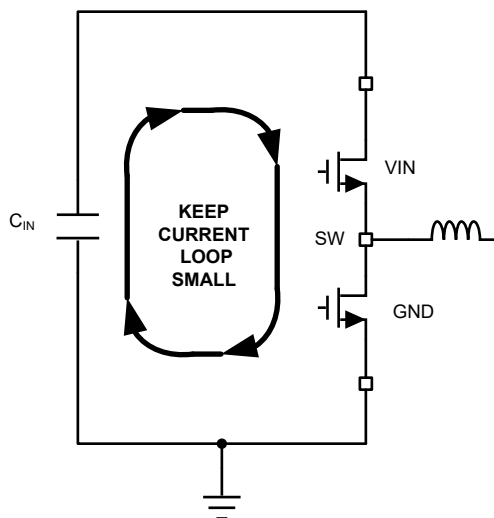
TI recommends providing adequate device heat sinking by using the thermal pad (DAP) of the device as the primary thermal path. Use a minimum 4 × 3 array of 10 mil thermal vias to connect the DAP to the system ground plane heat sink. The vias must be evenly distributed under the DAP. Use as much copper as possible for system ground plane, on the top and bottom layers for the best heat dissipation. Use a four-layer board with the copper thickness for the four layers, starting from the top as: 2 oz / 1 oz / 1 oz / 2 oz. A four-layer board with enough copper thickness and proper layout provides low current conduction impedance, proper shielding, and lower thermal resistance.

### 8.5.2 Layout Example



図 8-20. Example Layout for WSON Package



## 9 Device and Documentation Support

### 9.1 Device Support

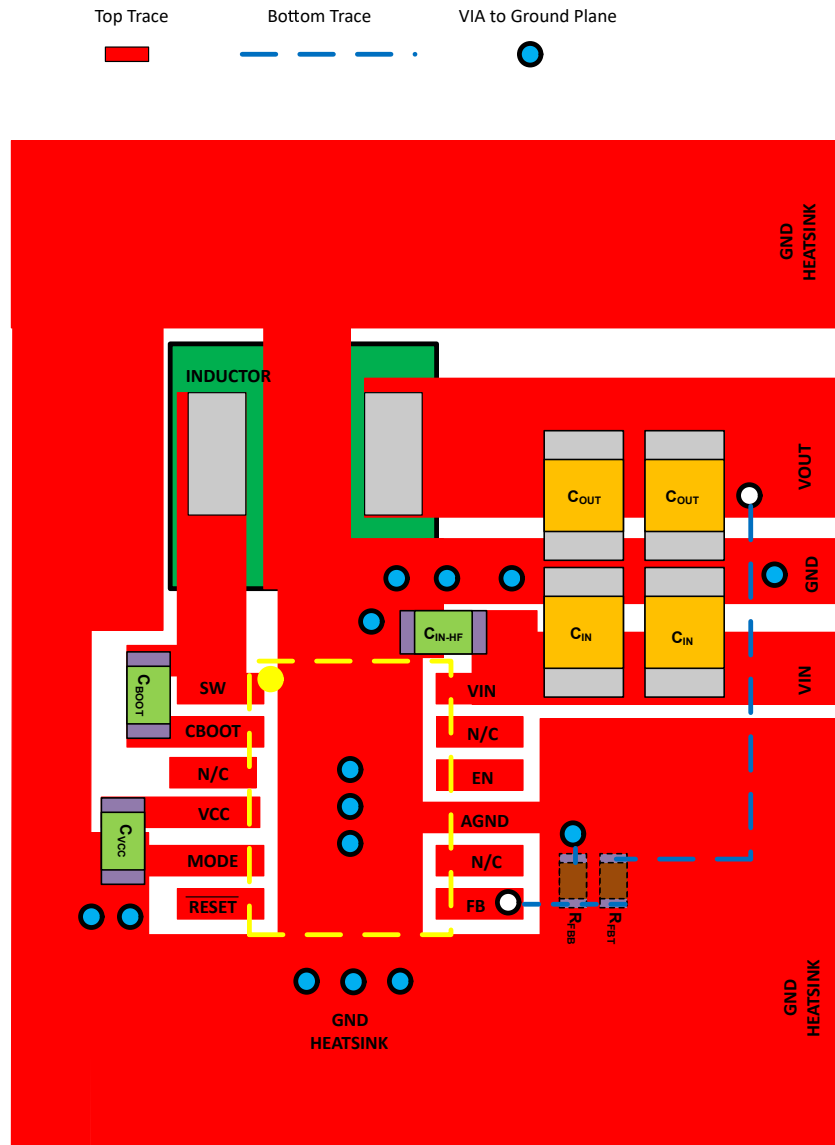
#### 9.1.1 Device Nomenclature

図 9-1 shows the device naming nomenclature of the LM63635-Q1. See セクション 4 for the availability of each variant. Contact TI sales representatives or on TI's E2E™ technical support forum for detail and availability of other options; minimum order quantities apply.



図 9-1. Device Naming Nomenclature

### 9.2 Documentation Support

#### 9.2.1 Related Documentation

For related documentation see the following:

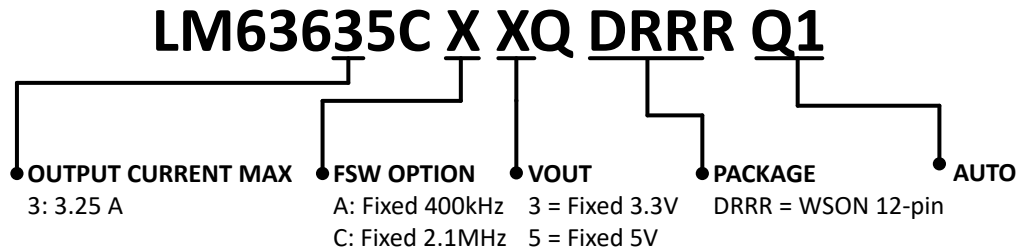
- Texas Instruments, [AN-2020 Thermal Design By Insight, Not Hindsight](#) application report
- Texas Instruments, [AN-2162 Simple Success with Conducted EMI from DCDC Converters](#) application report
- Texas Instruments, [A Guide to Board Layout for Best Thermal Resistance for Exposed Pad Packages](#) application report
- Texas Instruments, [Semiconductor and IC Package Thermal Metrics](#) application report
- Texas Instruments, [Thermal Design Made Simple with LM43603 and LM43602](#) application report
- Texas Instruments, [Using New Thermal Metrics](#) application report
- Texas Instruments, [Layout Guidelines for Switching Power Supplies](#) application report
- Texas Instruments, [Simple Switcher PCB Layout Guidelines](#) application report
- Texas Instruments, [Constructing Your Power Supply-layout Considerations](#) seminar
- Texas Instruments, [Low Radiated EMI Layout Made Simple with LM4360x and LM4600x](#) application report

### 9.3 ドキュメントの更新通知を受け取る方法

ドキュメントの更新についての通知を受け取るには、[www.tij.co.jp](http://www.tij.co.jp) のデバイス製品フォルダを開いてください。[通知] をクリックして登録すると、変更されたすべての製品情報に関するダイジェストを毎週受け取ることができます。変更の詳細については、改訂されたドキュメントに含まれている改訂履歴をご覧ください。

### 9.4 サポート・リソース

テキサス・インスツルメンツ E2E™ サポート・フォーラムは、エンジニアが検証済みの回答と設計に関するヒントをエキスパートから迅速かつ直接得ることができる場所です。既存の回答を検索したり、独自の質問をしたりすることで、設計に必要な支援を迅速に得ることができます。

リンクされているコンテンツは、各寄稿者により「現状のまま」提供されるものです。これらはテキサス・インスツルメンツの仕様を構成するものではなく、必ずしもテキサス・インスツルメンツの見解を反映したものではありません。テキサス・インスツルメンツの[使用条件](#)を参照してください。

### 9.5 Trademarks

PowerPAD™ and テキサス・インスツルメンツ E2E™ are trademarks of Texas Instruments.  
すべての商標は、それぞれの所有者に帰属します。

### 9.6 用語集

[テキサス・インスツルメンツ用語集](#) この用語集には、用語や略語の一覧および定義が記載されています。

## 9.7 静電気放電に関する注意事項



この IC は、ESD によって破損する可能性があります。テキサス・インスツルメンツは、IC を取り扱う際には常に適切な注意を払うことを推奨します。正しい取り扱いおよび設置手順に従わない場合、デバイスを破損するおそれがあります。

ESD による破損は、わずかな性能低下からデバイスの完全な故障まで多岐にわたります。精密な IC の場合、パラメータがわずかに変化するだけで公表されている仕様から外れる可能性があるため、破損が発生しやすくなっています。

## 10 Revision History

資料番号末尾の英字は改訂を表しています。その改訂履歴は英語版に準じています。

| DATE         | REVISION | NOTES           |
|--------------|----------|-----------------|
| January 2024 | *        | Initial Release |

## 11 Mechanical, Packaging, and Orderable Information

The following pages include mechanical, packaging, and orderable information. This information is the most current data available for the designated devices. This data is subject to change without notice and revision of this document. For browser-based versions of this data sheet, refer to the left-hand navigation.

## 重要なお知らせと免責事項

テキサス・インスツルメンツは、技術データと信頼性データ(データシートを含みます)、設計リソース(リファレンス デザインを含みます)、アプリケーションや設計に関する各種アドバイス、Web ツール、安全性情報、その他のリソースを、欠陥が存在する可能性のある「現状のまま」提供しており、商品性および特定目的に対する適合性の黙示保証、第三者の知的財産権の非侵害保証を含むいかなる保証も、明示的または黙示的にかかわらず拒否します。

これらのリソースは、テキサス・インスツルメンツ製品を使用する設計の経験を積んだ開発者への提供を意図したものです。(1) お客様のアプリケーションに適したテキサス・インスツルメンツ製品の選定、(2) お客様のアプリケーションの設計、検証、試験、(3) お客様のアプリケーションに該当する各種規格や、その他のあらゆる安全性、セキュリティ、規制、または他の要件への確実な適合に関する責任を、お客様のみが単独で負うものとします。

上記の各種リソースは、予告なく変更される可能性があります。これらのリソースは、リソースで説明されているテキサス・インスツルメンツ製品を使用するアプリケーションの開発の目的でのみ、テキサス・インスツルメンツはその使用をお客様に許諾します。これらのリソースに関して、他の目的で複製することや掲載することは禁止されています。テキサス・インスツルメンツや第三者の知的財産権のライセンスが付与されている訳ではありません。お客様は、これらのリソースを自身で使用した結果発生するあらゆる申し立て、損害、費用、損失、責任について、テキサス・インスツルメンツおよびその代理人を完全に補償するものとし、テキサス・インスツルメンツは一切の責任を拒否します。

テキサス・インスツルメンツの製品は、[テキサス・インスツルメンツの販売条件](#)、または [ti.com](https://www.ti.com) やかかるテキサス・インスツルメンツ製品の関連資料などのいずれかを通じて提供する適用可能な条項の下で提供されています。テキサス・インスツルメンツがこれらのリソースを提供することは、適用されるテキサス・インスツルメンツの保証または他の保証の放棄の拡大や変更を意味するものではありません。

お客様がいかなる追加条項または代替条項を提案した場合でも、テキサス・インスツルメンツはそれらに異議を唱え、拒否します。

郵送先住所: Texas Instruments, Post Office Box 655303, Dallas, Texas 75265  
Copyright © 2024, Texas Instruments Incorporated

**PACKAGING INFORMATION**

| Orderable Device  | Status<br>(1) | Package Type | Package Drawing | Pins | Package Qty | Eco Plan<br>(2) | Lead finish/<br>Ball material<br>(6) | MSL Peak Temp<br>(3) | Op Temp (°C) | Device Marking<br>(4/5) | Samples |
|-------------------|---------------|--------------|-----------------|------|-------------|-----------------|--------------------------------------|----------------------|--------------|-------------------------|---------|
| LM63635CA3QDRRRQ1 | ACTIVE        | WSON         | DRR             | 12   | 3000        | RoHS & Green    | NIPDAU                               | Level-2-260C-1 YEAR  | -40 to 125   | 635CA3                  | Samples |
| LM63635CA5QDRRRQ1 | ACTIVE        | WSON         | DRR             | 12   | 3000        | RoHS & Green    | NIPDAU                               | Level-2-260C-1 YEAR  | -40 to 125   | 635CA5                  | Samples |
| LM63635CC3QDRRRQ1 | ACTIVE        | WSON         | DRR             | 12   | 3000        | RoHS & Green    | NIPDAU                               | Level-2-260C-1 YEAR  | -40 to 125   | 635CC3                  | Samples |
| LM63635CC5QDRRRQ1 | ACTIVE        | WSON         | DRR             | 12   | 3000        | RoHS & Green    | NIPDAU                               | Level-2-260C-1 YEAR  | -40 to 125   | 635CC5                  | Samples |

(1) The marketing status values are defined as follows:

**ACTIVE:** Product device recommended for new designs.

**LIFEBUY:** TI has announced that the device will be discontinued, and a lifetime-buy period is in effect.

**NRND:** Not recommended for new designs. Device is in production to support existing customers, but TI does not recommend using this part in a new design.

**PREVIEW:** Device has been announced but is not in production. Samples may or may not be available.

**OBSELETE:** TI has discontinued the production of the device.

(2) **RoHS:** TI defines "RoHS" to mean semiconductor products that are compliant with the current EU RoHS requirements for all 10 RoHS substances, including the requirement that RoHS substance do not exceed 0.1% by weight in homogeneous materials. Where designed to be soldered at high temperatures, "RoHS" products are suitable for use in specified lead-free processes. TI may reference these types of products as "Pb-Free".

**RoHS Exempt:** TI defines "RoHS Exempt" to mean products that contain lead but are compliant with EU RoHS pursuant to a specific EU RoHS exemption.

**Green:** TI defines "Green" to mean the content of Chlorine (Cl) and Bromine (Br) based flame retardants meet JS709B low halogen requirements of <=1000ppm threshold. Antimony trioxide based flame retardants must also meet the <=1000ppm threshold requirement.

(3) MSL, Peak Temp. - The Moisture Sensitivity Level rating according to the JEDEC industry standard classifications, and peak solder temperature.

(4) There may be additional marking, which relates to the logo, the lot trace code information, or the environmental category on the device.

(5) Multiple Device Markings will be inside parentheses. Only one Device Marking contained in parentheses and separated by a "-" will appear on a device. If a line is indented then it is a continuation of the previous line and the two combined represent the entire Device Marking for that device.

(6) Lead finish/Ball material - Orderable Devices may have multiple material finish options. Finish options are separated by a vertical ruled line. Lead finish/Ball material values may wrap to two lines if the finish value exceeds the maximum column width.

**Important Information and Disclaimer:**The information provided on this page represents TI's knowledge and belief as of the date that it is provided. TI bases its knowledge and belief on information provided by third parties, and makes no representation or warranty as to the accuracy of such information. Efforts are underway to better integrate information from third parties. TI has taken and

continues to take reasonable steps to provide representative and accurate information but may not have conducted destructive testing or chemical analysis on incoming materials and chemicals. TI and TI suppliers consider certain information to be proprietary, and thus CAS numbers and other limited information may not be available for release.

In no event shall TI's liability arising out of such information exceed the total purchase price of the TI part(s) at issue in this document sold by TI to Customer on an annual basis.

## GENERIC PACKAGE VIEW

**DRR 12**

**WSON - 0.8 mm max height**

3 x 3, 0.5 mm pitch

PLASTIC SMALL OUTLINE - NO LEAD

This image is a representation of the package family, actual package may vary.  
Refer to the product data sheet for package details.

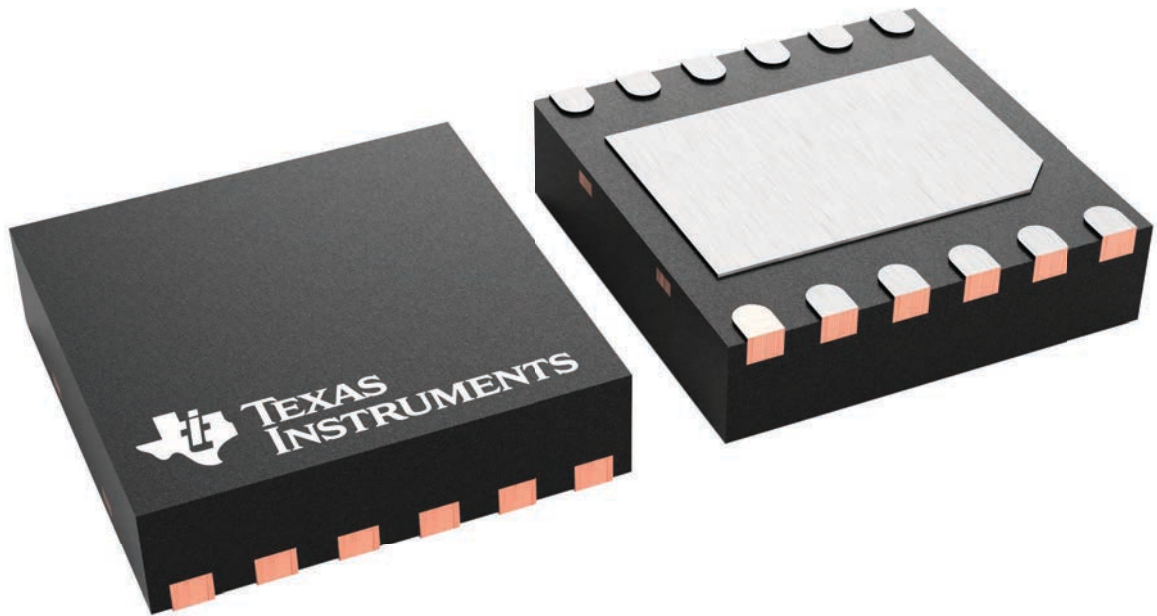

4223490/B

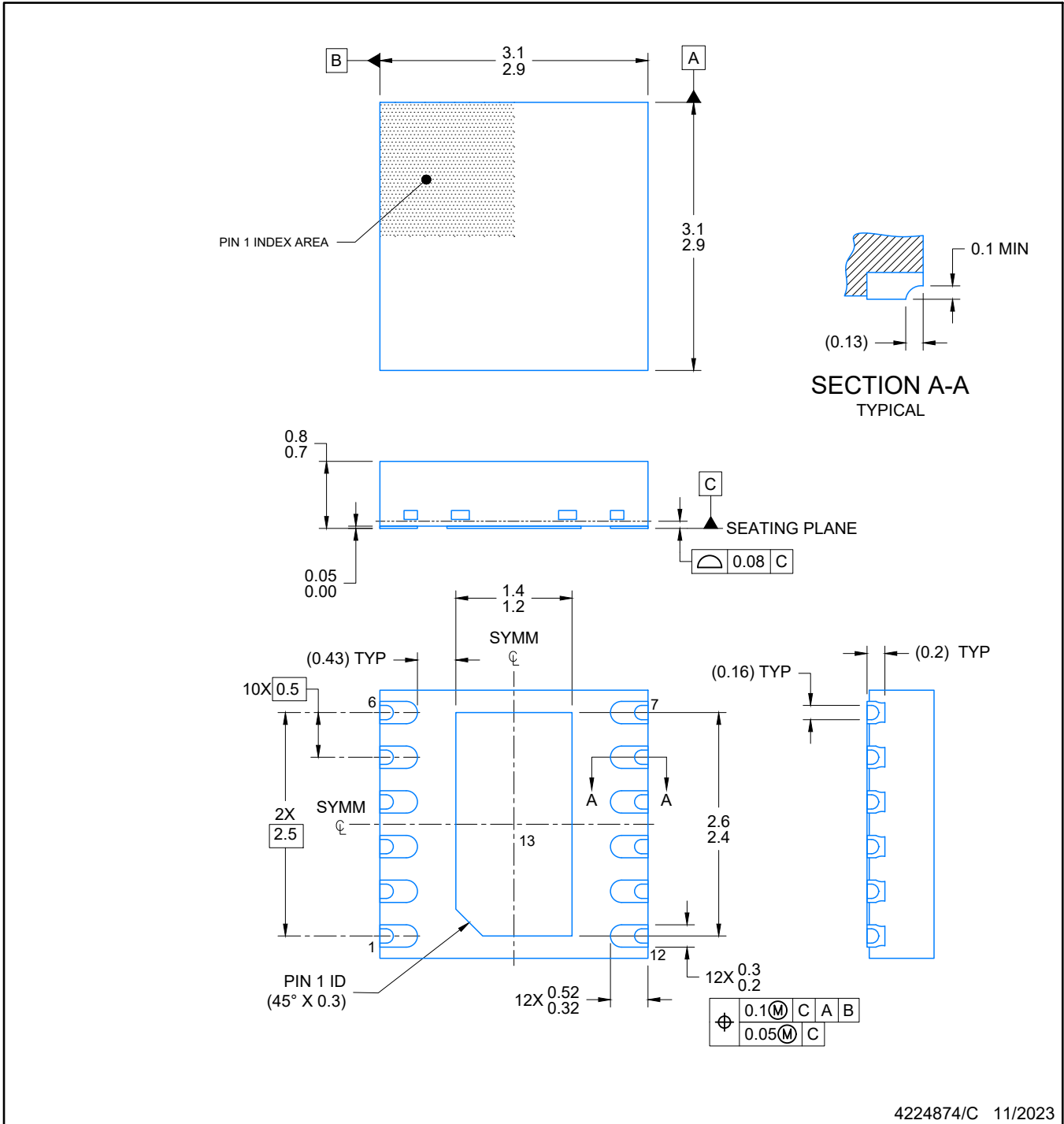

4224874/C 11/2023

**NOTES:**

1. All linear dimensions are in millimeters. Any dimensions in parenthesis are for reference only. Dimensioning and tolerancing per ASME Y14.5M.
2. This drawing is subject to change without notice.
3. The package thermal pad must be soldered to the printed circuit board for optimal thermal and mechanical performance.

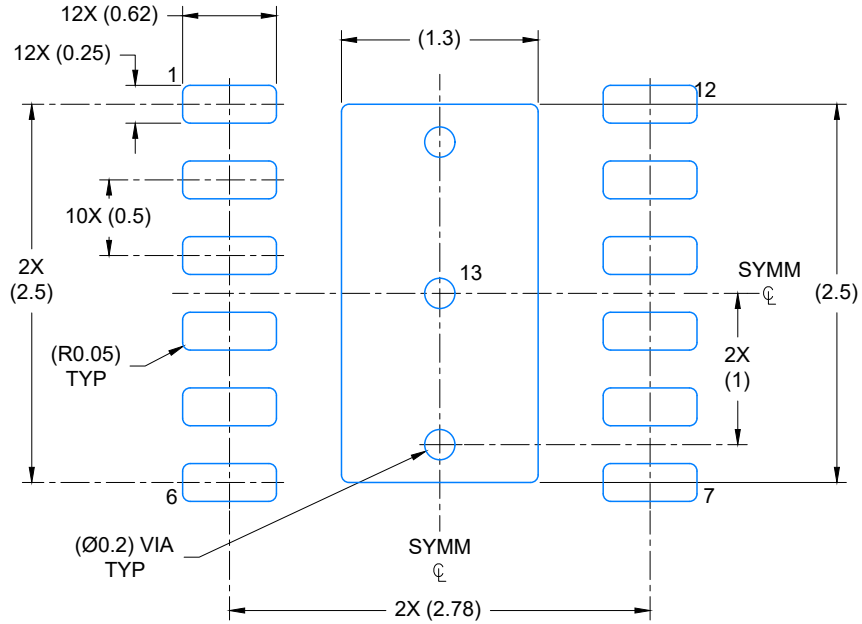

LAND PATTERN EXAMPLE  
EXPOSED METAL SHOWN  
SCALE: 20X

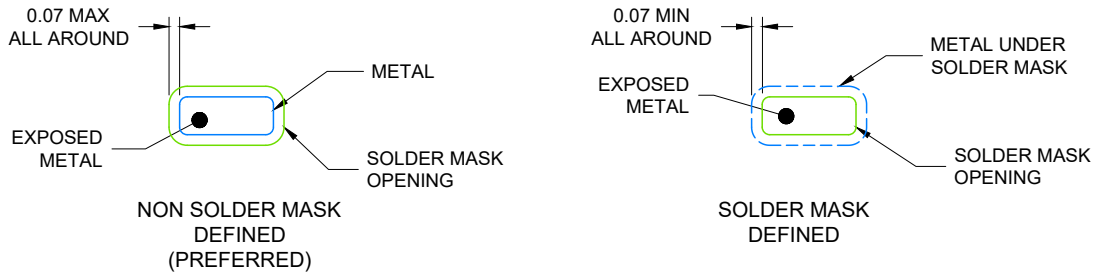

SOLDER MASK DETAILS

4224874/C 11/2023

NOTES: (continued)

4. This package is designed to be soldered to a thermal pad on the board. For more information, see Texas Instruments literature number SLUA271 ([www.ti.com/lit/slua271](http://www.ti.com/lit/slua271)).
5. Vias are optional depending on application, refer to device data sheet. If any vias are implemented, refer to their locations shown on this view. It is recommended that vias under paste be filled, plugged or tented.



# EXAMPLE STENCIL DESIGN

DRR0012E

WSON - 0.8 mm max height

PLASTIC QUAD FLAT PACK- NO LEAD

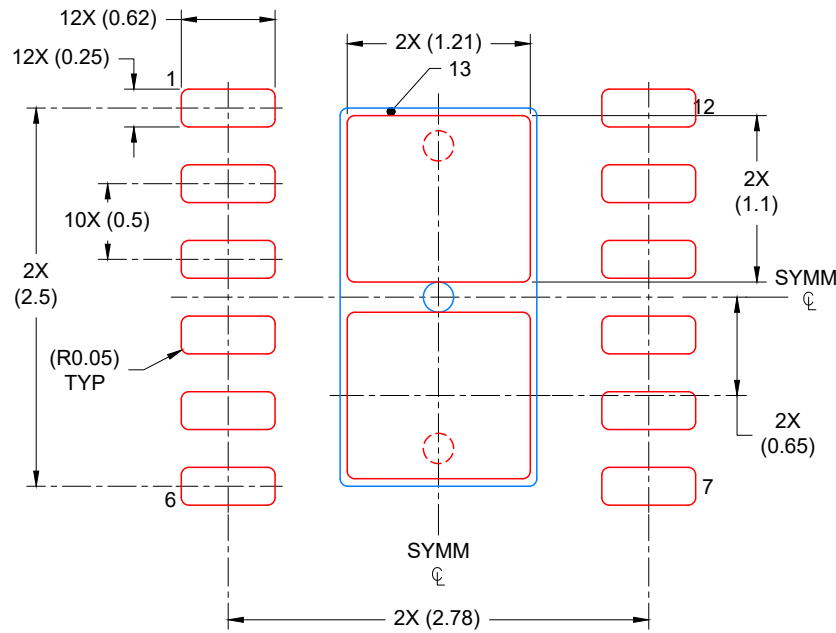

SOLDER PASTE EXAMPLE  
BASED ON 0.125 mm THICK STENCIL

EXPOSED PAD  
82% PRINTED COVERAGE BY AREA  
SCALE: 20X

4224874/C 11/2023

NOTES: (continued)

6. Laser cutting apertures with trapezoidal walls and rounded corners may offer better paste release. IPC-7525 may have alternate design recommendations.

## 重要なお知らせと免責事項

TI は、技術データと信頼性データ(データシートを含みます)、設計リソース(リファレンス・デザインを含みます)、アプリケーションや設計に関する各種アドバイス、Web ツール、安全性情報、その他のリソースを、欠陥が存在する可能性のある「現状のまま」提供しており、商品性および特定目的に対する適合性の黙示保証、第三者の知的財産権の非侵害保証を含むいかなる保証も、明示的または黙示的にかかわらず拒否します。

これらのリソースは、TI 製品を使用する設計の経験を積んだ開発者への提供を意図したものです。(1) お客様のアプリケーションに適した TI 製品の選定、(2) お客様のアプリケーションの設計、検証、試験、(3) お客様のアプリケーションに該当する各種規格や、その他のあらゆる安全性、セキュリティ、規制、または他の要件への確実な適合に関する責任を、お客様のみが単独で負うものとし、

上記の各種リソースは、予告なく変更される可能性があります。これらのリソースは、リソースで説明されている TI 製品を使用するアプリケーションの開発の目的でのみ、TI はその使用をお客様に許諾します。これらのリソースに関して、他の目的で複製することや掲載することは禁止されています。TI や第三者の知的財産権のライセンスが付与されている訳ではありません。お客様は、これらのリソースを自身で使用した結果発生するあらゆる申し立て、損害、費用、損失、責任について、TI およびその代理人を完全に補償するものとし、TI は一切の責任を拒否します。

TI の製品は、[TI の販売条件](#)、または [ti.com](#) やかかる TI 製品の関連資料などのいずれかを通じて提供する適用可能な条項の下で提供されています。TI がこれらのリソースを提供することは、適用される TI の保証または他の保証の放棄の拡大や変更を意味するものではありません。

お客様がいかなる追加条項または代替条項を提案した場合でも、TI はそれらに異議を唱え、拒否します。

郵送先住所 : Texas Instruments, Post Office Box 655303, Dallas, Texas 75265  
Copyright © 2024, Texas Instruments Incorporated