

LP295x シャットダウン機能付きの 100mA、30V の可変電圧レギュレータ

1 特長

- 広い入力電圧範囲
 - V_{IN} 範囲: 2V~30V
- 広い出力電圧範囲 V_{OUT}
 - 固定オプション: 3V (従来チップ)、3.3V、5.0V
 - 可変オプション: 1.2V~29V
- 出力電流: 100mA
- V_{OUT} 精度:
 - ライン、負荷、温度の全範囲にわたって $\pm 2\%$ の精度 (従来チップ)
 - ライン、負荷、温度の全範囲にわたって $\pm 1\%$ の精度 (新しいチップ)
- 静止電流 I_Q (新しいチップ): 50 μ A (標準値)
- 低ドロップアウト (新しいチップ): 340mV (標準値)
- 出力電流制限とサーマル シャットダウン
- セラミック出力コンデンサの値の広い範囲で安定
 - C_{OUT} 範囲: 1 μ F~100 μ F (新しいチップ)
 - ESR 範囲: 0 Ω ~2 Ω (新しいチップ)
- 動作時接合部温度: -40 $^{\circ}$ C~125 $^{\circ}$ C
- パッケージオプション:
 - LP (3ピン TO-92)
 - D (8ピン SOIC)
 - DRG (8ピン WSON)

2 アプリケーション

- グリッド インフラ
- ファクトリオートメーション
- モータードライブ
- ビルオートメーション



図 3-1. ドロップアウト電圧と温度との関係 (新チップ)

3 概要

LP2951 は入力範囲の広い低ドロップアウトレギュレータ (LDO) で、2V~30V の入力電圧範囲に対応し、最大 100mA の負荷電流を供給できます。LP2951 は、同じデバイスから固定出力と可変出力のどちらでも出力できます。OUTPUT ピンと SENSE ピン、FEEDBACK ピンと V_{TAP} ピンをそれぞれ相互に接続すると、LP2951 の出力電圧は 3.3V または 5V に固定されます。または、SENSE ピンと V_{TAP} ピンをオープンのままにして、FEEDBACK を外部の分圧抵抗に接続します。この構成では、出力を 1.2V~29V の範囲内で任意の値に設定できます。

LP2951-Q1 には、フィードバック ピンの電圧を監視して出力電圧のステータスを示す ERROR 出力があります。SHUTDOWN 入力と ERROR 出力を使用して、システムの複数の電源をシーケンシングできます。

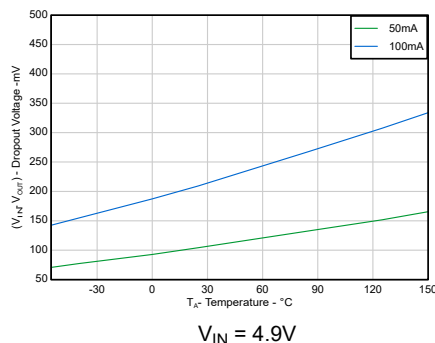
パッケージ情報

部品番号	パッケージ (1)	パッケージ サイズ (2)
LP2950	LP (TO-92, 3)	4.83mm × 4.83mm
LP2951	D (SOIC, 8)	4.90 mm × 6.00mm
	DRG (SON, 8)	3.00mm × 3.00mm

- 利用可能なすべてのパッケージについては、データシートの末尾にある注文情報を参照してください。
- パッケージ サイズ (長さ × 幅) は公称値で、該当する場合はピンも含まれます。

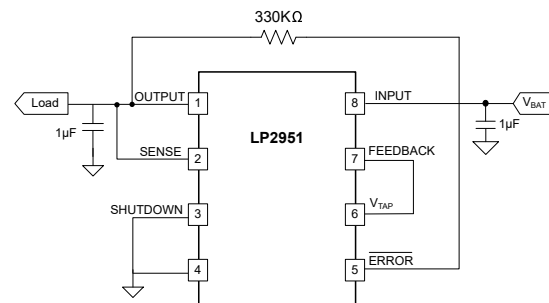

代表的なアプリケーション回路



Table of Contents

1 特長	1	7 Application and Implementation	23
2 アプリケーション	1	7.1 Application Information.....	23
3 概要	1	7.2 Typical Application.....	25
4 Pin Configuration and Functions	3	7.3 Power Supply Recommendations.....	29
5 Specifications	4	7.4 Layout.....	29
5.1 Absolute Maximum Ratings.....	4	8 Device and Documentation Support	29
5.2 ESD Ratings.....	4	8.1 Device Support.....	29
5.3 Recommended Operating Conditions.....	5	8.2 ドキュメントの更新通知を受け取る方法.....	29
5.4 Thermal Information.....	5	8.3 Device Nomenclature.....	29
5.5 Electrical Characteristics (Both Legacy and New Chip).....	5	8.4 Documentation Support.....	30
5.6 Timing Requirements (New Chip only).....	9	8.5 サポート・リソース.....	30
5.7 Typical Characteristics.....	10	8.6 Trademarks.....	30
6 Detailed Description	21	8.7 静電気放電に関する注意事項.....	30
6.1 Overview.....	21	8.8 用語集.....	30
6.2 Functional Block Diagrams.....	21	9 Revision History	30
6.3 Feature Description.....	22	10 Mechanical, Packaging, and Orderable Information	31
6.4 Device Functional Modes.....	23		

4 Pin Configuration and Functions



表 4-1. Pin Functions

NAME	PIN		TYPE ⁽¹⁾	DESCRIPTION
	LP2950	LP2951		
ERROR	—	5	O	Active-low open-drain error output. Goes low when V_{OUT} drops by 6% of the nominal value.
FEEDBACK	—	7	I	Determines the output voltage. Connect to V_{TAP} (with OUTPUT tied to SENSE) for fixed output option, or connect to a resistor divider for adjustable output option.
GND	2	4	—	Ground
INPUT	3	8	I	Input supply pin. Use a capacitor with a value of 1 μ F or larger from this pin to ground is recommended. See the セクション 7.1.2 section for more information.
OUTPUT	1	1	O	A capacitor is required from OUTPUT to GND for stability. For best transient response, use the nominal recommended value or larger ceramic capacitor from OUTPUT to GND ⁽²⁾ . Place the output capacitor as close to output of the device as possible. See the セクション 7.1.2 for more details.
SENSE	—	2	I	Senses the output voltage. Connect to OUTPUT (with FEEDBACK tied to V_{TAP}) for fixed output option only. If using the device as adjustable output, this pin must be left floating.
SHUTDOWN	—	3	I	Active-high input. High signal disables the device; low signal enables the device.
V_{TAP}	—	6	I	Connect to FEEDBACK for fixed output option. If using the device as adjustable output, this pin must be left floating.

(1) I = Input; O = Output

(2) The nominal output capacitance must be greater than 1 μ F. Throughout this document, the nominal derating on these capacitors is 50%. Verify that the effective capacitance at the pin is greater than 1 μ F.

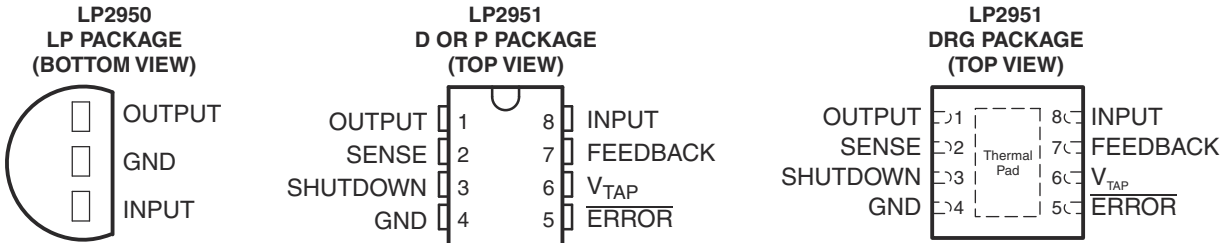
5 Specifications

5.1 Absolute Maximum Ratings

over operating free-air temperature range (unless otherwise noted)⁽¹⁾

		MIN	MAX	UNIT
V _{IN}	Continuous input voltage (Legacy chip)	-0.3	30	V
	Continuous input voltage (New chip)	-0.3	42	
V _{OUT}	Output voltage	-0.3	V _{IN} +0.3 ⁽⁴⁾	
V _{SHDN}	SHUTDOWN input voltage (Legacy chip)	-1.5	30	
	SHUTDOWN input voltage (New chip)	-0.3	42	
V _{ERROR}	ERROR comparator output voltage (Legacy chip) ⁽²⁾	-1.5	30	
	ERROR comparator output voltage (New chip) ⁽²⁾	-0.3	39	
V _{FDBK}	FEEDBACK input voltage (Legacy chip) ^{(2) (3)}	-1.5	30	
	FEEDBACK input voltage (New chip) ^{(2) (3)}	-0.3	5	
V _{TAP}	Internal resistor divider (fixed voltage option only) (New Chip)	-0.3	5	
V _{SENSE}	Output voltage sense (fixed voltage option only) (New Chip)	-0.3	5	
T _{stg}	Storage temperature	-65	150	°C

- (1) Operation outside the Absolute Maximum Ratings may cause permanent device damage. Absolute Maximum Ratings do not imply functional operation of the device at these or any other conditions beyond those listed under Recommended Operating Conditions. If used outside the Recommended Operating Conditions but within the Absolute Maximum Ratings, the device may not be fully functional, and this may affect device reliability, functionality, performance, and shorten the device lifetime.
- (2) Can exceed input supply voltage.
- (3) If load is returned to a negative power supply, the output must be diode clamped to GND.
- (4) The absolute maximum rating is V_{IN} + 0.3V or 39V, whichever is smaller.

5.2 ESD Ratings

			VALUE (Legacy Chip)	VALUE (New Chip)	UNIT
V _(ESD)	Electrostatic discharge	Human body model (HBM), per ANSI/ESDA/JEDEC JS-001, all pins ⁽¹⁾	±2500	±3000	V
		Charged device model (CDM), per JEDEC specification JESD22-C101, all pins ⁽²⁾	±1000	±1000	V

- (1) JEDEC document JEP155 states that 500V HBM allows safe manufacturing with a standard ESD control process.
- (2) JEDEC document JEP157 states that 250V CDM allows safe manufacturing with a standard ESD control process.

5.3 Recommended Operating Conditions

over operating free-air temperature range (unless otherwise noted)

		MIN	NOM	MAX	UNIT
V _{IN}	Input voltage	2.0		30	V
V _{EN}	Enable voltage	0		30	
V _{OUT}	Output voltage	1.2		30	
I _L	Output current	0		100	mA
C _{OUT}	Output capacitor ⁽¹⁾	1	2.2	100	μF
C _{OUT} ESR	Output capacitor ESR (Legacy chip)	30m		5	Ω
	Output capacitor ESR (New chip) ⁽³⁾	0		2	
C _{IN}	Input capacitor		1		μF
C _{FF}	Feed-forward capacitor (optional ⁽²⁾ , for adjustable device only)		10		pF
I _{FB_DIVIDER}	Feedback divider current ⁽²⁾ (adjustable device only)	12			μA
T _J	Junction temperature	-40		125	°C

- (1) Effective output capacitance of 0.5μF minimum required for stability.
- (2) C_{FF} required for stability if the feedback divider current < 12μA. Feedback divider current = V_{OUT} / (R₁ + R₂). See the *Feed-Forward Capacitor (C_{FF})* section for details.
- (3) Maximum supported ESR range for new chip is 2Ω. For output capacitor with higher ESR values, place a low ESR MLCC capacitor.

5.4 Thermal Information

THERMAL METRIC ^{(1) (2)}		Legacy Chip			New Chip			UNIT
		D	DRG	LP	D	DRG	LP	
		8 PINS	8 PINS	3 PINS	8 PINS	8 PINS	3 PINS	
R _{θJA}	Junction-to-ambient thermal resistance	97	52.44	140	123	48.5	132.6	°C/W
R _{θJC(top)}	Junction-to-case (top) thermal resistance	-	-	-	67.8	60.4	114.4	°C/W
R _{θJB}	Junction-to-board thermal resistance	-	-	-	70.7	22.4	94.9	°C/W
Ψ _{JT}	Junction-to-top characterization parameter	-	-	-	18.0	1.7	26.9	°C/W
Ψ _{JB}	Junction-to-board characterization parameter	-	-	-	69.8	22.4	94.9	°C/W
R _{θJC(bot)}	Junction-to-case (bottom) thermal resistance	-	-	-	n/a	3.3	n/a	°C/W

- (1) The thermal data is based on the JEDEC standard high K profile, JESD 51-7. Two-signal, two-plane, four-layer board with 2-oz. copper. The copper pad is soldered to the thermal land pattern. Also, correct attachment procedure must be incorporated.
- (2) For more information about traditional and new thermal metrics, see the *Semiconductor and IC Package Thermal Metrics* application note.

5.5 Electrical Characteristics (Both Legacy and New Chip)

V_{IN} = V_{OUT} (nominal) + 1V, I_L = 100μA, C_L = 1μF (for new chip) and C_L = 2.2μF (for legacy chip),
8-pin version: FEEDBACK tied to V_{TAP}, OUTPUT tied to SENSE, V_{SHUTDOWN} ≤ 0.7V

PARAMETER	TEST CONDITIONS	T _J	MIN	TYP	MAX	UNIT	
3.3-V VERSION (LP295x-33)							
Output voltage	I _L = 100μA	Legacy chip	25°C	3.267	3.3	3.333	V
			-40°C to 125°C	3.234	3.3	3.366	
		New chip	25°C	3.2868	3.3	3.3132	
			-40°C to 125°C	3.2736	3.3	3.3264	
5-V VERSION (LP295x-50)							

5.5 Electrical Characteristics (Both Legacy and New Chip) (続き)

$V_{IN} = V_{OUT} \text{ (nominal)} + 1V$, $I_L = 100\mu A$, $C_L = 1\mu F$ (for new chip) and $C_L = 2.2\mu F$ (for legacy chip),
8-pin version: FEEDBACK tied to V_{TAP} , OUTPUT tied to SENSE, $V_{SHUTDOWN} \leq 0.7V$

PARAMETER	TEST CONDITIONS	T_J	MIN	TYP	MAX	UNIT	
Output voltage	$I_L = 100\mu A$	Legacy chip	25°C	4.95	5	5.05	V
			-40°C to 125°C	4.900	5	5.100	
		New chip	25°C	4.98	5	5.02	
			-40°C to 125°C	4.96	5	5.04	
ALL VOLTAGE OPTIONS							
Output voltage accuracy	$V_{IN} = [V_{OUT(NOM)} + 1V]$ to 30V, $I_L = 100\mu A$ to 100mA	New chip	-40°C to 125°C	-1		1	%
	$V_{IN} = [V_{OUT(NOM)} + 1V]$ to 30V, $I_L = 100\mu A$ to 100mA, LP (TO-92) package			-1.2		1.2	
Output voltage temperature coefficient ⁽¹⁾	$I_L = 100\mu A$	Legacy chip	-40°C to 125°C		20	100	ppm/°C
		New chip			20	60	
Line regulation ⁽²⁾	$V_{IN} = [V_{OUT(NOM)} + 1V]$ to 30V	Legacy chip	25°C		0.03	0.2	%V
			-40°C to 125°C			0.4	
		New chip	25°C		0.0006	0.01	
			-40°C to 125°C			0.015	
Load regulation ⁽²⁾	$I_L = 100\mu A$ to 100mA	Legacy chip	25°C		0.04	0.2	%
			-40°C to 125°C			0.3	
		New chip	25°C		0.04	0.1	
			-40°C to 125°C			0.2	
Dropout voltage	$V_{IN} = 2V$, $I_L = 100\mu A$	Legacy chip	25°C		50	80	mV
			-40°C to 125°C			150	
		New chip	25°C		1	4	
			-40°C to 125°C			5	
	$V_{IN} = 2V$, $I_L = 100mA$	Legacy chip	25°C		380	450	
			-40°C to 125°C			600	
		New chip	25°C		340	420	
			-40°C to 125°C			570	

5.5 Electrical Characteristics (Both Legacy and New Chip) (続き)

$V_{IN} = V_{OUT} \text{ (nominal)} + 1V$, $I_L = 100\mu A$, $C_L = 1\mu F$ (for new chip) and $C_L = 2.2\mu F$ (for legacy chip),
8-pin version: FEEDBACK tied to V_{TAP} , OUTPUT tied to SENSE, $V_{SHUTDOWN} \leq 0.7V$

PARAMETER	TEST CONDITIONS	T_J	MIN	TYP	MAX	UNIT	
GND current	$I_L = 100\mu A$	Legacy chip	25°C	75	120	μA	
			-40°C to 125°C		140		
		New chip	25°C	50	65		
			-40°C to 125°C		80		
	$I_L = 100mA$	Legacy chip	25°C	8	12	mA	
			-40°C to 125°C		14		
New chip		25°C		0.8			
		-40°C to 125°C		0.9			
Dropout ground current	$V_{IN} = V_{OUT(NOM)} - 0.5V$, $I_L = 100\mu A$	Legacy chip	25°C	110	170	μA	
			-40°C to 125°C		200		
		New chip	25°C	78	120		
			-40°C to 125°C		150		
UVLO V_{IN} rising	$I_L = 100\mu A$	New chip	-40°C to 125°C	1.8	1.9	2.0	V
UVLO V_{IN} falling				1.7	1.8	1.9	
Hysteresis					100		
Current limit	$V_{OUT} = 0V$	Legacy chip	25°C	160	200	mA	
			-40°C to 125°C		220		
		New chip	25°C	180	200		
			-40°C to 125°C		230		
Thermal regulation ⁽³⁾	$I_L = 100\mu A$	Legacy chip	25°C	0.05	0.2	%/ W	
		New chip		0.05	0.2		
Output noise (RMS), 10Hz to 100KHz	$C_L = 1\mu F$ (5V only)	Legacy chip	25°C	430		μV	
		New chip		265			
	$C_L = 200\mu F$	Legacy chip	25°C	160			
		New chip		250			
	$C_L = 3.3\mu F$, $C_{Bypass} = 0.01\mu F$ between pins 1 and 7	Legacy chip	25°C	100			
		New chip		100			
Power supply ripple rejection	$V_{IN} - V_{OUT} = 1V$, frequency = 100Hz, $I_{OUT} \geq 5mA$	New chip	25°C	80		dB	
(LP2951-xx) 8-PIN VERSION ONLY ADJ							
Reference voltage		Legacy chip	25°C	1.218	1.235	1.252	V
			-40°C to 125°C	1.212		1.257	
		New chip	25°C	1.192	1.2	1.208	
			-40°C to 125°C	1.189		1.211	
Reference voltage	$V_{IN} = 2.3V$ to 30V, $I_L = 100\mu A$ to 100mA	Legacy chip	-40°C to 125°C	1.2		1.272	
		New chip		1.188		1.212	

5.5 Electrical Characteristics (Both Legacy and New Chip) (続き)

$V_{IN} = V_{OUT} \text{ (nominal)} + 1V$, $I_L = 100\mu A$, $C_L = 1\mu F$ (for new chip) and $C_L = 2.2\mu F$ (for legacy chip),
8-pin version: FEEDBACK tied to V_{TAP} , OUTPUT tied to SENSE, $V_{SHUTDOWN} \leq 0.7V$

PARAMETER	TEST CONDITIONS	T_J	MIN	TYP	MAX	UNIT
Reference voltage temperature coefficient ⁽¹⁾		Legacy chip	25°C	20		ppm/°C
		New chip		5		
FEEDBACK bias current		Legacy chip	25°C	20	40	nA
			-40°C to 125°C	60		
		New chip	25°C	10	50	
			-40°C to 125°C	60		
FEEDBACK bias current temperature coefficient		Legacy chip	25°C	0.1		nA/°C
		New chip		0.1		
ERROR COMPARATOR						
Output leakage current	$V_{OUT} = 30V$	Legacy chip	25°C	0.01	1	μA
			-40°C to 125°C	2		
		New chip	25°C	0.2	0.5	
			-40°C to 125°C	1		
Output low voltage	$V_{IN} \geq 2V$ $I_{OL} = 400\mu A$	Legacy chip	25°C	150	250	mV
			-40°C to 125°C	400		
		New chip	25°C	180	250	
			-40°C to 125°C	350		
Upper threshold voltage (ERROR output high) ⁽⁴⁾		Legacy chip	25°C	40	60	mV
			-40°C to 125°C	25		
		New chip	25°C	40	60	
			-40°C to 125°C	25		
Lower threshold voltage (ERROR output low) ⁽⁴⁾		Legacy chip	25°C	75	95	mV
			-40°C to 125°C	140		
		New chip	25°C	75	95	
			-40°C to 125°C	140		
Hysteresis ⁽⁴⁾		Legacy chip	25°C	15		mV
		New chip		15		
SHUTDOWN INPUT						
Input logic voltage	Low (regulator ON)	Legacy chip	-40°C to 125°C	0.7		V
		New chip		0.7		
	High (regulator OFF)	Legacy chip	-40°C to 125°C	2		
		New chip		2		

5.5 Electrical Characteristics (Both Legacy and New Chip) (続き)

$V_{IN} = V_{OUT} \text{ (nominal)} + 1V$, $I_L = 100\mu A$, $C_L = 1\mu F$ (for new chip) and $C_L = 2.2\mu F$ (for legacy chip),
8-pin version: FEEDBACK tied to V_{TAP} , OUTPUT tied to SENSE, $V_{SHUTDOWN} \leq 0.7V$

PARAMETER	TEST CONDITIONS	T_J	MIN	TYP	MAX	UNIT
SHUTDOWN input current	SHUTDOWN = 2.4V	Legacy chip	25°C	30	50	μA
			-40°C to 125°C		100	
		New chip	25°C	0.2	0.5	
			-40°C to 125°C		1	
	SHUTDOWN = 30V	Legacy chip	25°C	450	600	
			-40°C to 125°C		750	
New chip	25°C	0.3	0.5			
	-40°C to 125°C		1			
Regulator output current in shutdown	$V_{SHUTDOWN} \geq 2V$, $V_{IN} \geq 30V$, $V_{OUT} = 0$, FEEDBACK tied to V_{TAP}	Legacy chip	25°C	3	10	μA
			-40°C to 125°C		20	
		New chip	25°C	4	6	
			-40°C to 125°C		7.5	

- Output or reference voltage temperature coefficient is defined as the worst-case voltage change divided by the total temperature range.
- Regulation is measured at constant junction temperature, using pulse testing with a low duty cycle. Changes in output voltage due to heating effects are covered under the specification for thermal regulation.
- Thermal regulation is defined as the change in output voltage at a time (T) after a change in power dissipation is applied, excluding load or line regulation effects. Specifications are for a 50-mA load pulse at $V_{IN} = 30V$, $V_{OUT} = 5V$ (1.25W pulse) for $t = 10ms$.
- Comparator thresholds are expressed in terms of a voltage differential equal to the nominal reference voltage (measured at $V_{IN} - V_{OUT} = 1V$) minus FEEDBACK terminal voltage. To express these thresholds in terms of output voltage change, multiply by the error amplifier gain = $V_{OUT}/V_{REF} = (R1 + R2)/R2$. For example, at a programmed output voltage of 5V, the ERROR output is specified to go low when the output drops by $95mV \times 5V/1.2V = 395mV$. Thresholds remain constant as a percentage of V_{OUT} (as V_{OUT} is varied), with the low-output warning occurring at 6% below nominal (typ) and 7.7%(max).

5.6 Timing Requirements (New Chip only)

PARAMETER	TEST CONDITIONS	MIN	TYP	MAX	UNIT
t_{PGDH}	PG delay time rising, time from 92% V_{OUT} to 20% of PG ⁽¹⁾		40		μs
t_{PGDL}	PG delay time falling, time from 90% V_{OUT} to 80% of PG ⁽¹⁾		10		μs

- Output Overdrive = 10%.

5.7 Typical Characteristics

at $V_{IN} = V_{OUT} \text{ (nominal)} + 1V$, $I_L = 100\mu A$, $C_L = 1\mu F$ (for new chip) and $C_L = 2.2\mu F$ (for legacy chip) (unless otherwise noted)

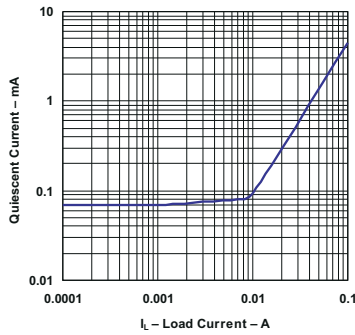

5-1. Quiescent Current vs Load Current (Legacy Chip)

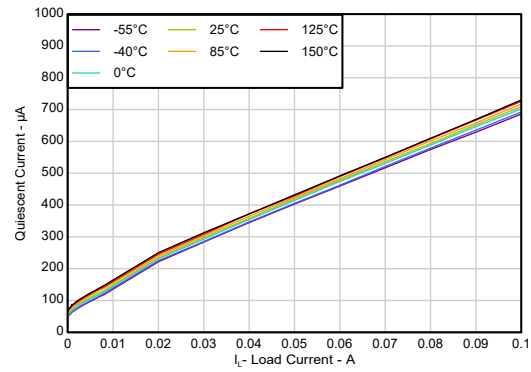

$V_{IN} = 6V, V_{OUT} = 5V$

5-2. Quiescent Current vs Load Current (New Chip)

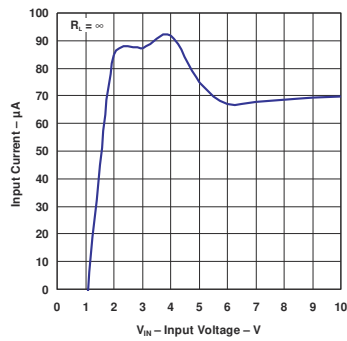

5-3. Input Current vs Input Voltage ($R_L = \text{OPEN}$) (Legacy Chip)

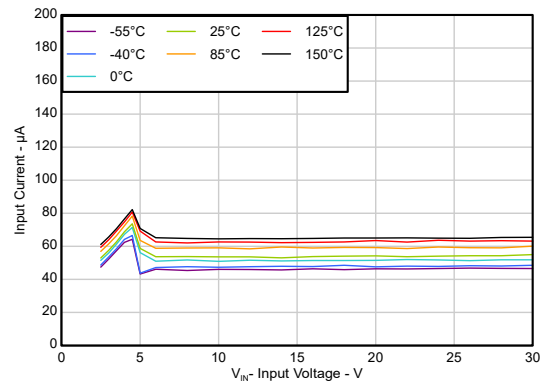

$V_{OUT} = 5V, I_L = 0mA$

5-4. Input Current vs Input Voltage ($R_L = \text{OPEN}$) (New Chip)

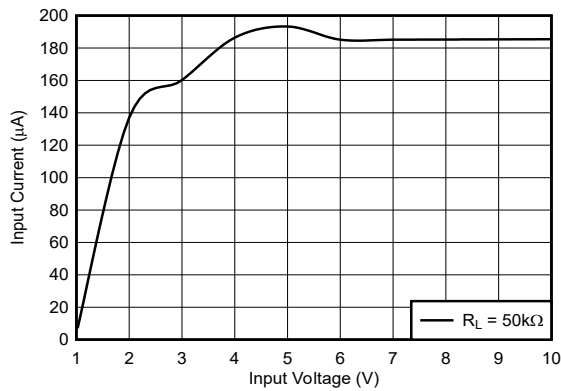

5-5. Input Current vs Input Voltage ($R_L = 50k\Omega$)

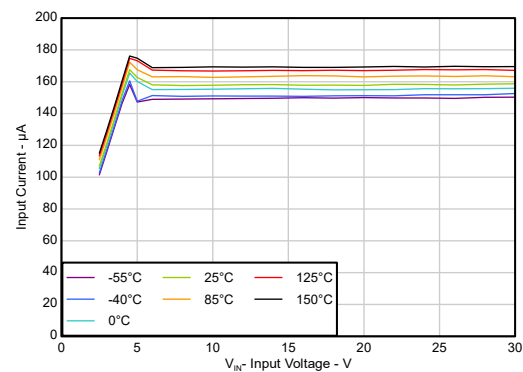

$V_{OUT} = 5V, I_L = 100\mu A$

5-6. Input Current vs Input Voltage ($R_L = 50k\Omega$) (New Chip)

5.7 Typical Characteristics (continued)

at $V_{IN} = V_{OUT} (\text{nominal}) + 1V$, $I_L = 100\mu A$, $C_L = 1\mu F$ (for new chip) and $C_L = 2.2\mu F$ (for legacy chip) (unless otherwise noted)

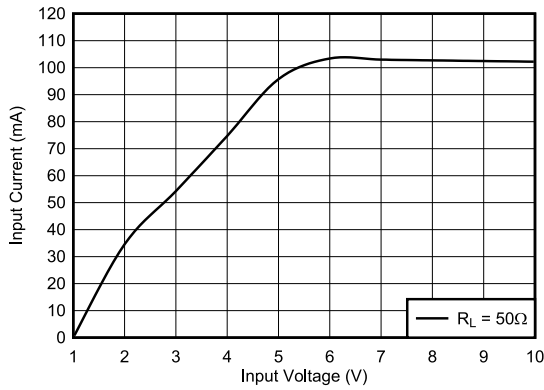

5-7. Input Current vs Input Voltage ($R_L = 50\Omega$) (Legacy Chip)

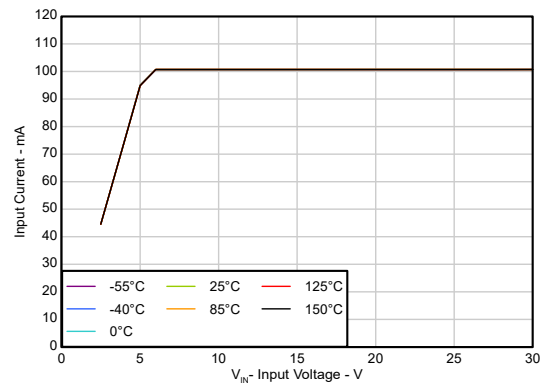

$V_{OUT} = 5V$, $I_L = 100mA$

5-8. Input Current vs Input Voltage ($R_L = 50\Omega$) (New Chip)

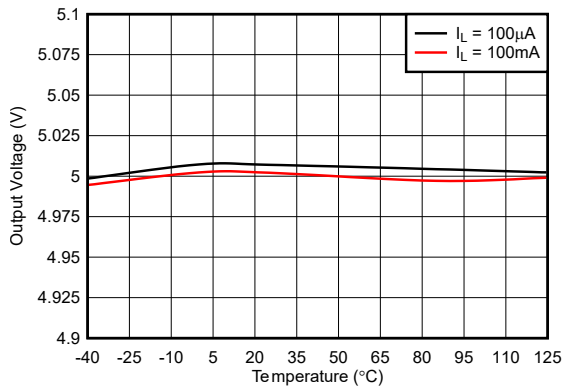

5-9. Output Voltage vs Temperature (Legacy Chip)

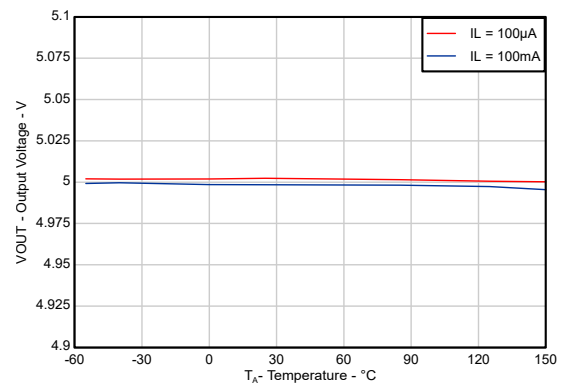

$V_{IN} = 6V$, $V_{OUT} = 5V$

5-10. Output Voltage vs Temperature (New Chip)

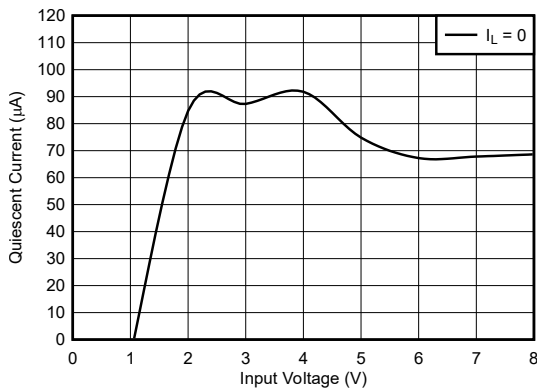

5-11. Quiescent Current vs Input Voltage ($I_L = 0$) (Legacy Chip)

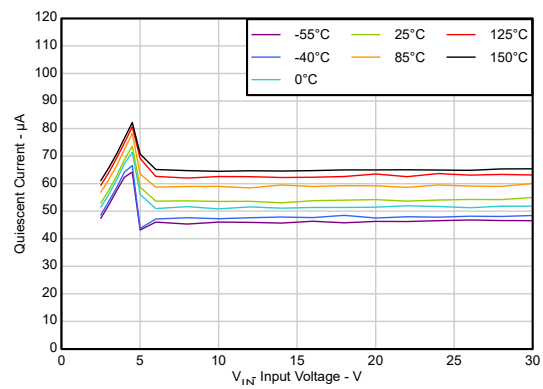

$V_{OUT} = 5V$

5-12. Quiescent Current vs Input Voltage ($I_L = 0$) (New Chip)

5.7 Typical Characteristics (continued)

at $V_{IN} = V_{OUT} (\text{nominal}) + 1V$, $I_L = 100\mu A$, $C_L = 1\mu F$ (for new chip) and $C_L = 2.2\mu F$ (for legacy chip) (unless otherwise noted)



图 5-13. Quiescent Current vs Input Voltage ($I_L = 1mA$)(Legacy Chip)



$V_{OUT} = 5V$

图 5-14. Quiescent Current vs Input Voltage ($I_L = 1mA$)(New Chip)

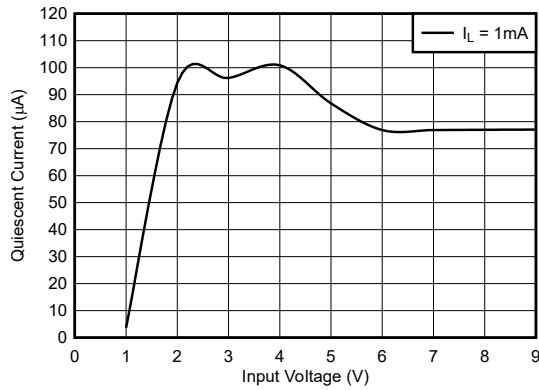
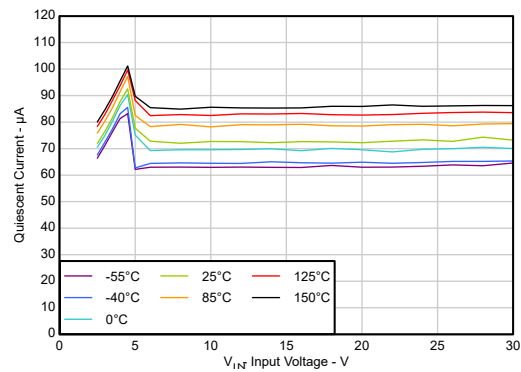

图 5-15. Quiescent Current vs Input Voltage ($I_L = 100mA$)(Legacy Chip)



$V_{OUT} = 5V$

图 5-16. Quiescent Current vs Input Voltage ($I_L = 100mA$)(New Chip)

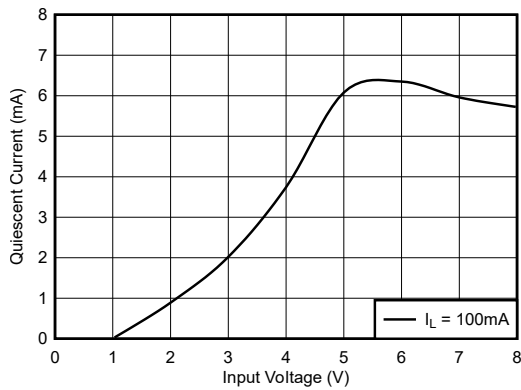
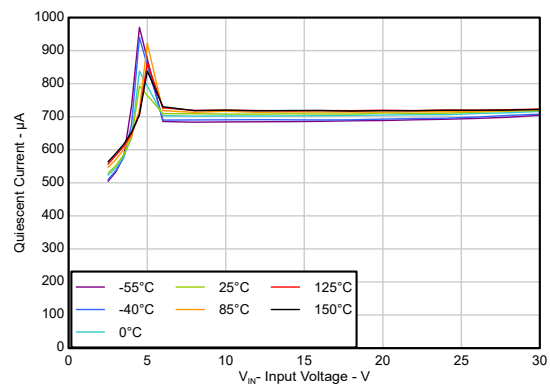

图 5-17. Quiescent Current vs Temperature ($I_L = 100mA$)(Legacy Chip)



$V_{IN} = 6V, V_{OUT} = 5V$

图 5-18. Quiescent Current vs Temperature ($I_L = 100mA$)(New Chip)

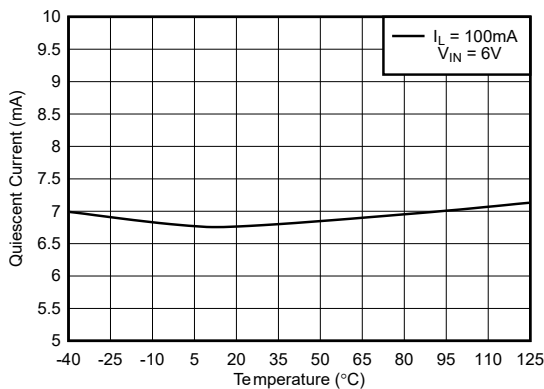
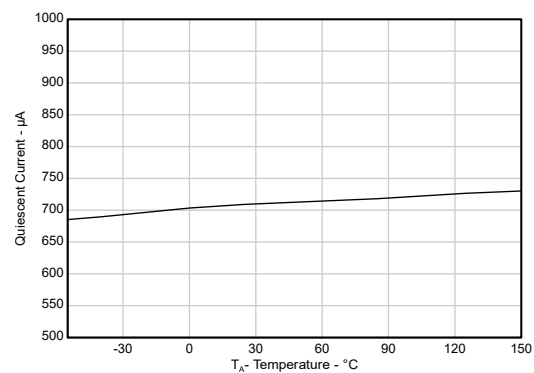
5.7 Typical Characteristics (continued)

at $V_{IN} = V_{OUT} \text{ (nominal)} + 1V$, $I_L = 100\mu A$, $C_L = 1\mu F$ (for new chip) and $C_L = 2.2\mu F$ (for legacy chip) (unless otherwise noted)

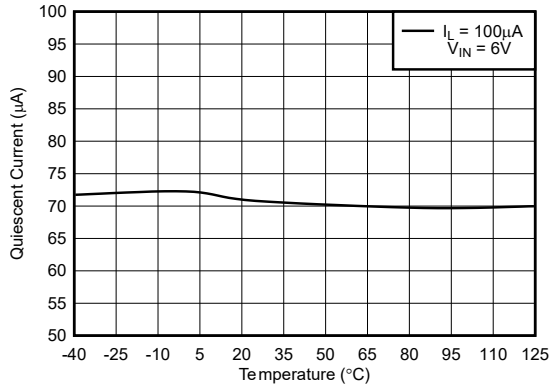

5-19. Quiescent Current vs Temperature ($I_L = 100\mu A$)(Legacy Chip)

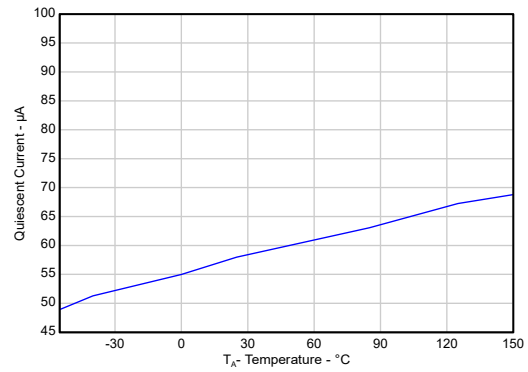

$V_{IN} = 6V, V_{OUT} = 5V$

5-20. Quiescent Current vs Temperature ($I_L = 100\mu A$)(New Chip)

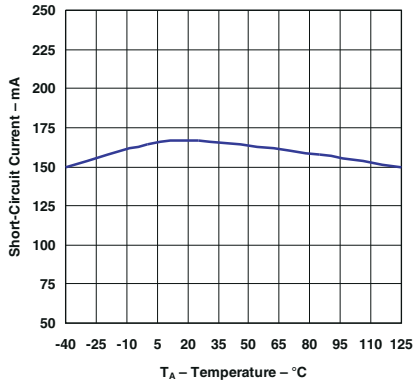

5-21. Short-Circuit Current vs Temperature (Legacy Chip)

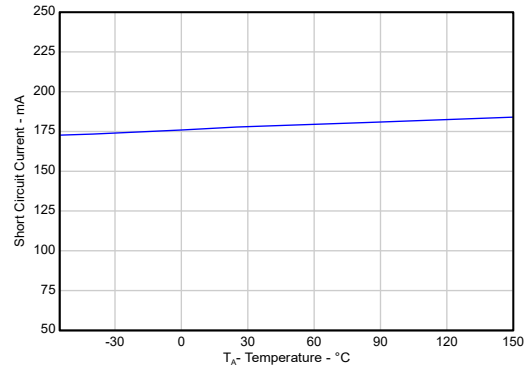

$V_{IN} = 6V, V_{OUT} = 0V$

5-22. Short-Circuit Current vs Temperature (New Chip)

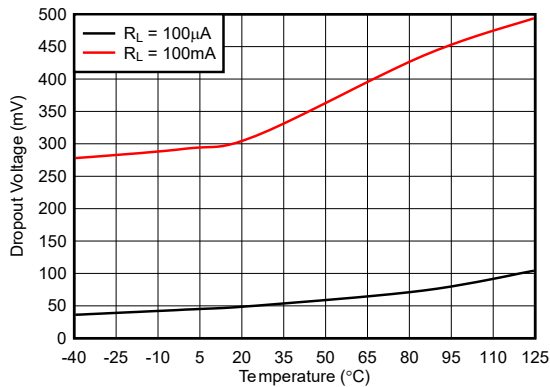

5-23. Dropout Voltage vs Temperature (Legacy Chip)

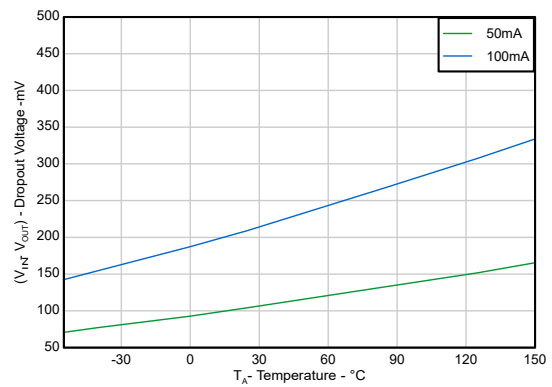

$V_{IN} = 4.9V$

5-24. Dropout Voltage vs Temperature (New Chip)

5.7 Typical Characteristics (continued)

at $V_{IN} = V_{OUT} \text{ (nominal)} + 1V$, $I_L = 100\mu A$, $C_L = 1\mu F$ (for new chip) and $C_L = 2.2\mu F$ (for legacy chip) (unless otherwise noted)

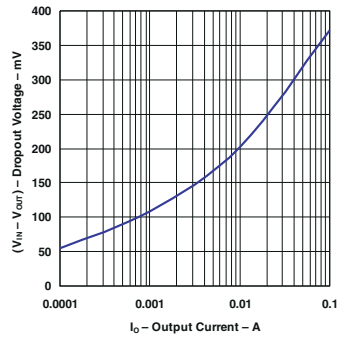

5-25. Dropout Voltage vs Dropout Current (Legacy Chip)

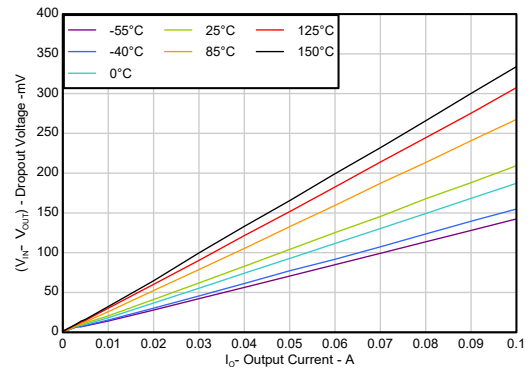

$V_{IN} = 4.9V$

5-26. Dropout Voltage vs Dropout Current (New Chip)

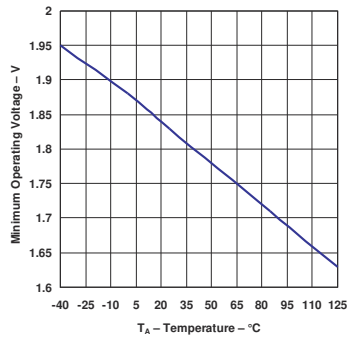

5-27. Minimum Operating Voltage vs Temperature (Legacy Chip)

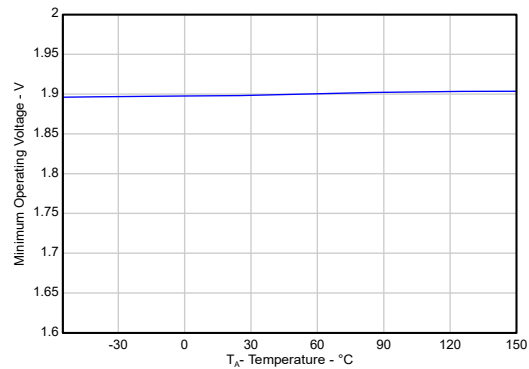

5-28. Minimum Operating Voltage vs Temperature (New Chip)

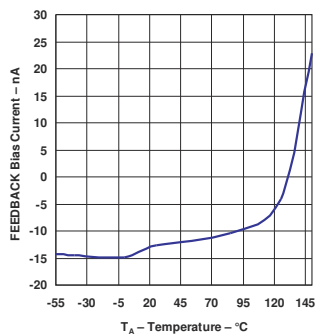

5-29. LP2951 FEEDBACK Bias Current vs Temperature (Legacy Chip)

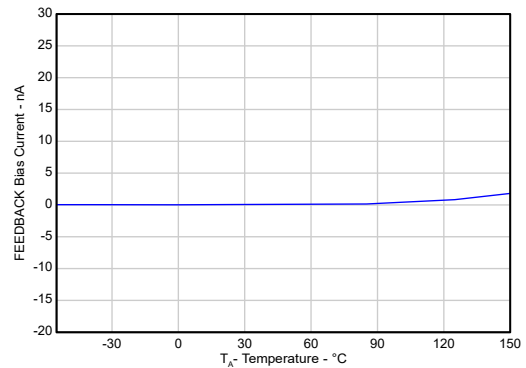

5-30. FEEDBACK Bias Current vs Temperature (New Chip)

5.7 Typical Characteristics (continued)

at $V_{IN} = V_{OUT} (\text{nominal}) + 1V$, $I_L = 100\mu A$, $C_L = 1\mu F$ (for new chip) and $C_L = 2.2\mu F$ (for legacy chip) (unless otherwise noted)

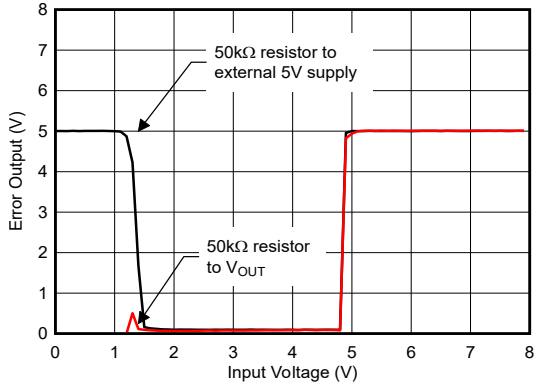

5-31. LP2951 ERROR Comparator Output vs Input Voltage (Legacy Chip)

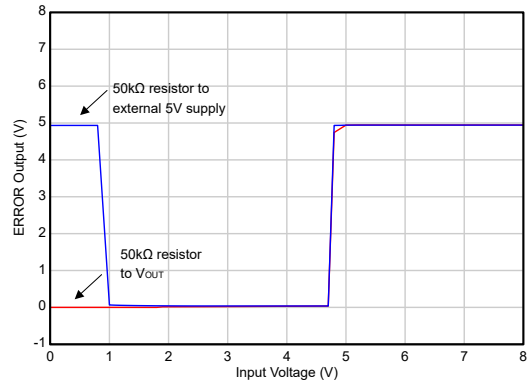

5-32. ERROR Comparator Output vs Input Voltage (New Chip)

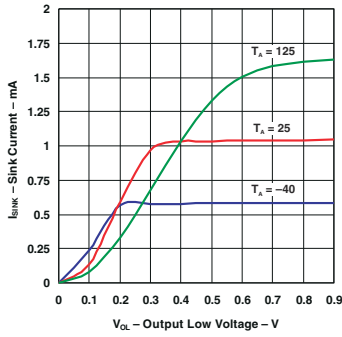

5-33. LP2951 ERROR Comparator Sink Current vs Output Low Voltage (Legacy Chip)

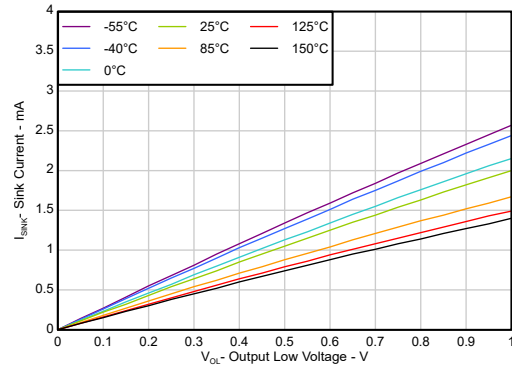

5-34. ERROR Comparator Sink Current vs Output Low Voltage (New Chip)

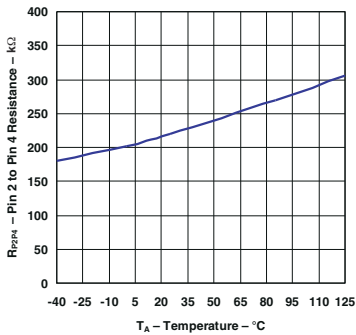

5-35. LP2951 Divider Resistance vs Temperature (Legacy Chip)

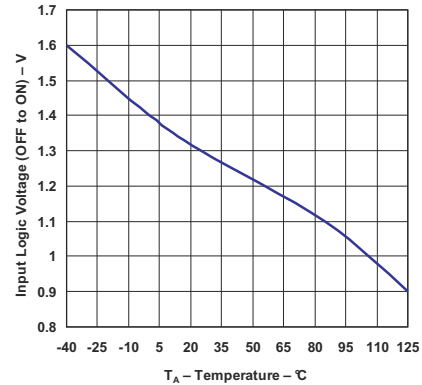

5-36. Shutdown Threshold Voltage (Off to On) vs Temperature (Legacy Chip)

5.7 Typical Characteristics (continued)

at $V_{IN} = V_{OUT} (\text{nominal}) + 1V$, $I_L = 100\mu A$, $C_L = 1\mu F$ (for new chip) and $C_L = 2.2\mu F$ (for legacy chip) (unless otherwise noted)

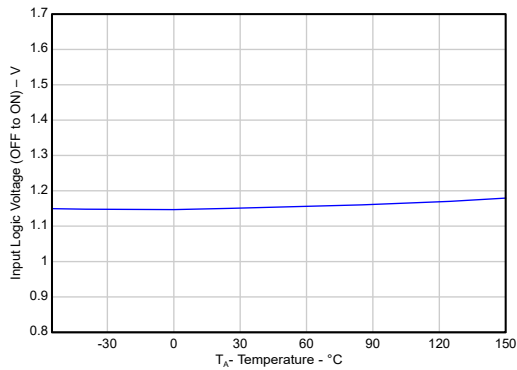

5-37. Shutdown Threshold Voltage (Off to On) vs Temperature (New Chip)

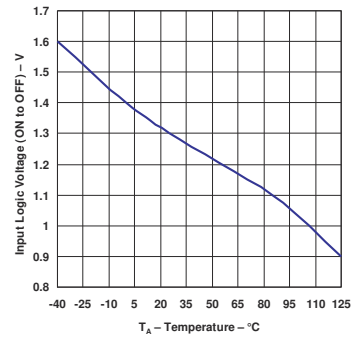

5-38. Shutdown Threshold Voltage (On to Off) vs Temperature (Legacy Chip)

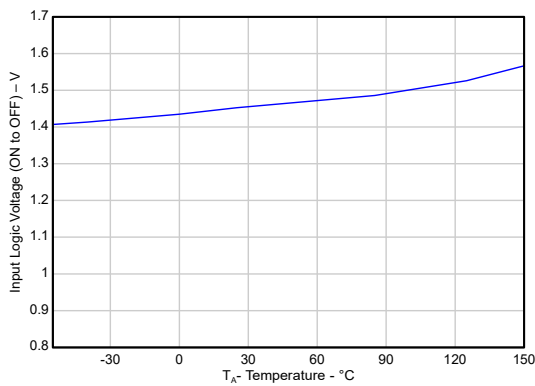

5-39. Shutdown Threshold Voltage (On to Off) vs Temperature (New Chip)

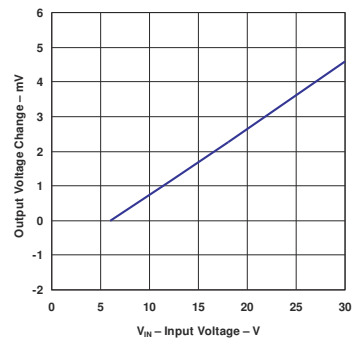

5-40. Line Regulation vs Input Voltage (Legacy Chip)

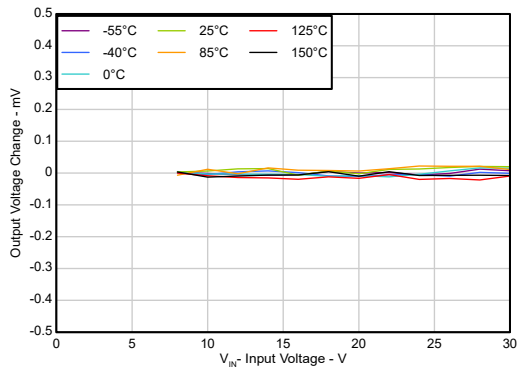

$V_{OUT} = 5V$, $I_{OUT} = 100\mu A$

5-41. Line Regulation vs Input Voltage (New Chip)

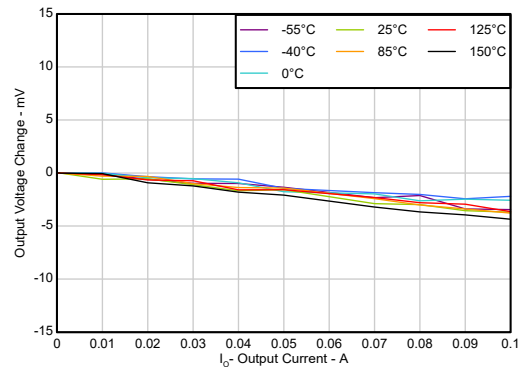

$V_{IN} = 6V$, $V_{OUT} = 5V$

5-42. Load Regulation vs Load Current (New Chip)

5.7 Typical Characteristics (continued)

at $V_{IN} = V_{OUT} \text{ (nominal)} + 1V$, $I_L = 100\mu A$, $C_L = 1\mu F$ (for new chip) and $C_L = 2.2\mu F$ (for legacy chip) (unless otherwise noted)

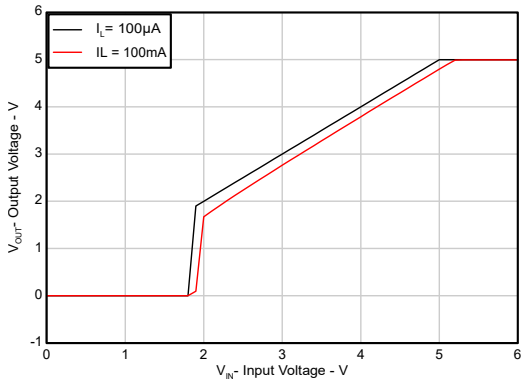

5-43. Output Voltage vs Input Voltage (New Chip)

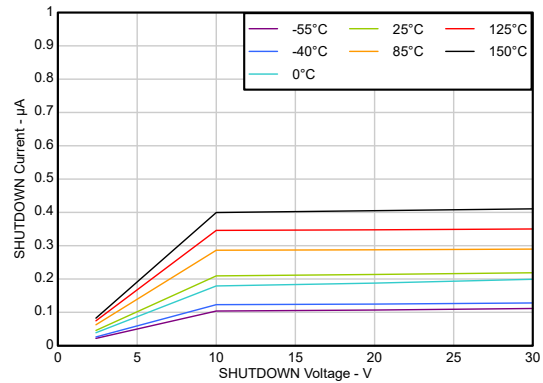

5-44. SHUTDOWN Input Current vs SHUTDOWN Voltage (New Chip)

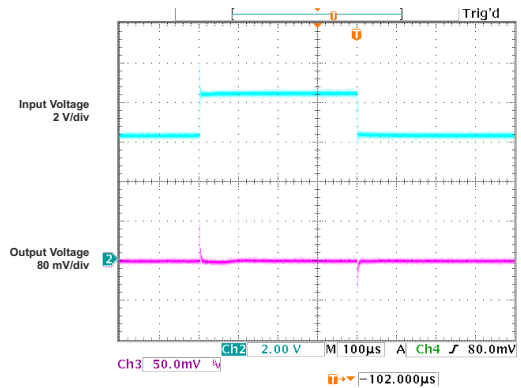

5-45. Line Transient Response vs Time (Legacy Chip)

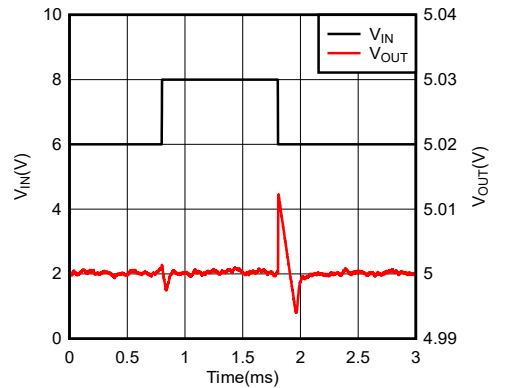

$V_{IN} = 6V \text{ to } 8V$, $V_{OUT} = 5V$, $C_{OUT} = 1\mu F$, $I_{OUT} = 100\mu A$

5-46. Line Transient Response vs Time (New Chip)

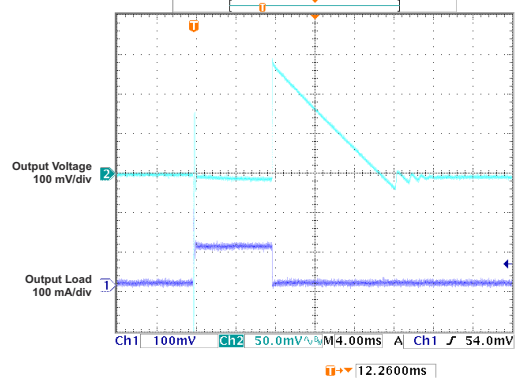

5-47. Load Transient Response vs Time ($V_{OUT} = 5V$, $C_L = 10\mu F$) (Legacy Chip)

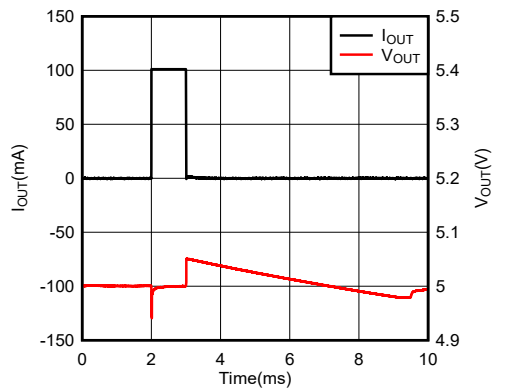

$V_{IN} = 6V$, $V_{OUT} = 5V$, $I_{OUT} = 0 \text{ to } 100mA$, $C_{OUT} = 10\mu F$

5-48. Load Transient Response vs Time (New Chip)

5.7 Typical Characteristics (continued)

at $V_{IN} = V_{OUT} (\text{nominal}) + 1V$, $I_L = 100\mu A$, $C_L = 1\mu F$ (for new chip) and $C_L = 2.2\mu F$ (for legacy chip) (unless otherwise noted)

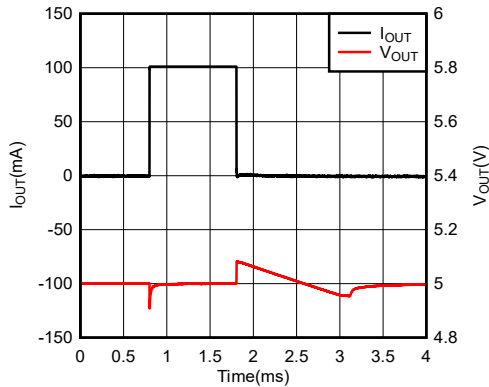

$V_{IN} = 6V$, $V_{OUT} = 5V$, $I_{OUT} = 0$ to $100mA$, $C_{OUT} = 1\mu F$

5-49. Load Transient Response vs Time (New Chip)

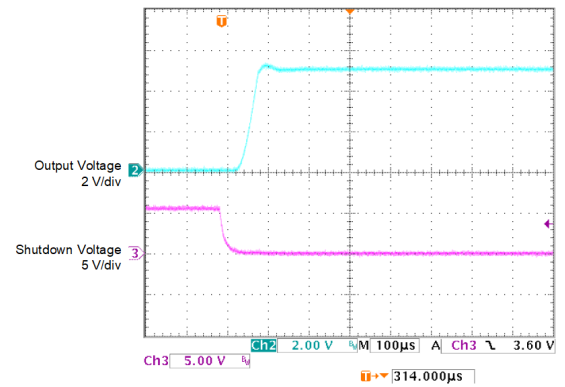

5-50. Enable Transient Response vs Time ($I_L = 1mA$, $C_L = 1\mu F$) (Legacy Chip)

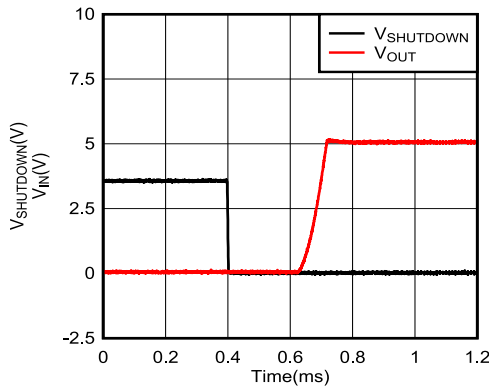

$V_{IN} = 6V$, $V_{OUT} = 5V$, $C_{OUT} = 1\mu F$, $I_{OUT} = 1mA$

5-51. Enable Transient Response vs Time (New Chip)

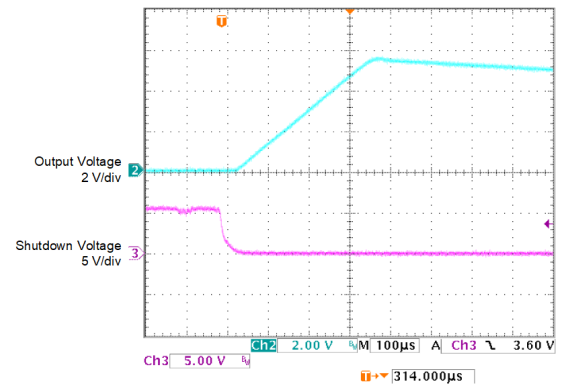

5-52. Enable Transient Response vs Time ($I_L = 1mA$, $C_L = 10\mu F$)

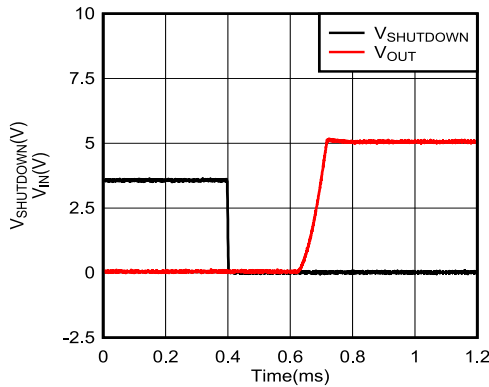

$V_{IN} = 6V$, $V_{OUT} = 5V$, $C_{OUT} = 10\mu F$, $I_{OUT} = 1mA$

5-53. Enable Transient Response vs Time (New Chip)

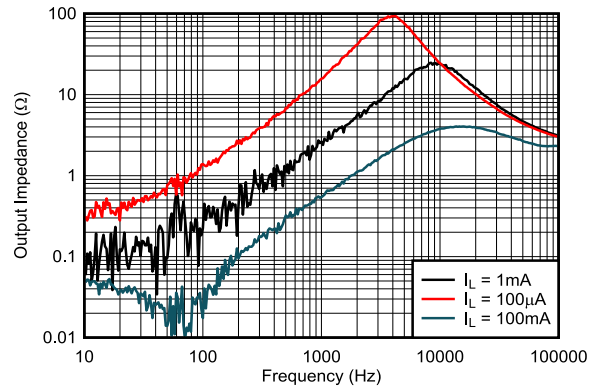

5-54. Output Impedance vs Frequency (Legacy Chip)

5.7 Typical Characteristics (continued)

at $V_{IN} = V_{OUT} (\text{nominal}) + 1V$, $I_L = 100\mu A$, $C_L = 1\mu F$ (for new chip) and $C_L = 2.2\mu F$ (for legacy chip) (unless otherwise noted)

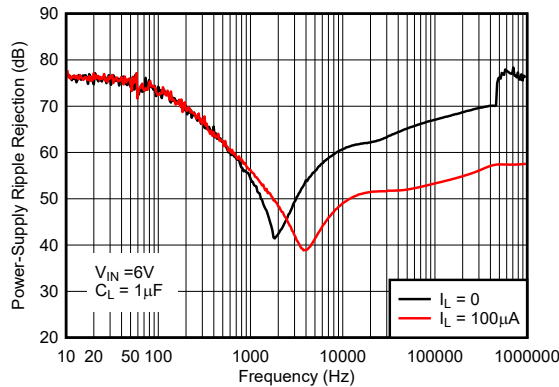

5-55. Ripple Rejection vs Frequency (Legacy Chip)

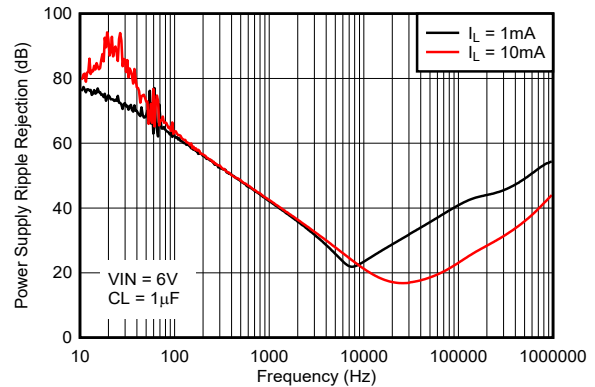

5-56. Ripple Rejection vs Frequency (Legacy Chip)

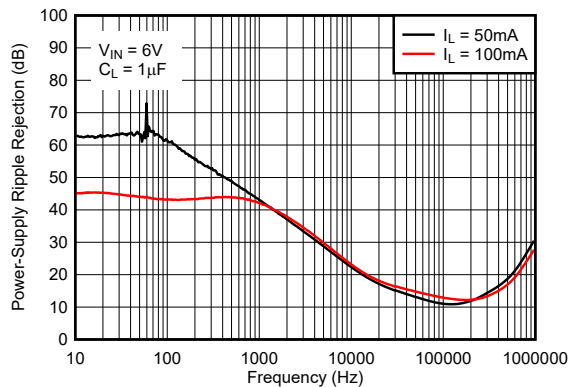

5-57. Ripple Rejection vs Frequency (Legacy Chip)

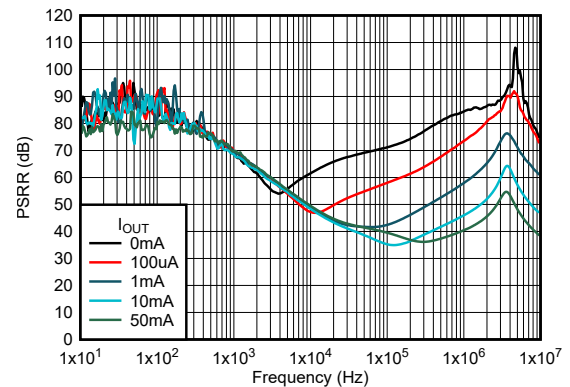

5-58. Ripple Rejection vs Frequency (New Chip)

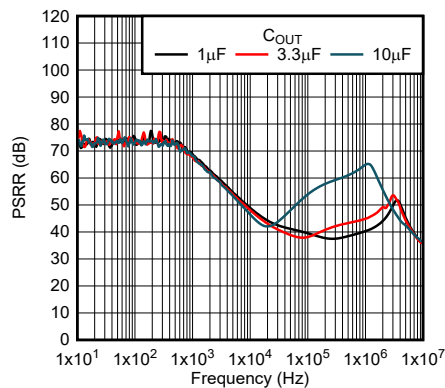

5-59. Ripple Rejection vs Frequency (New Chip)

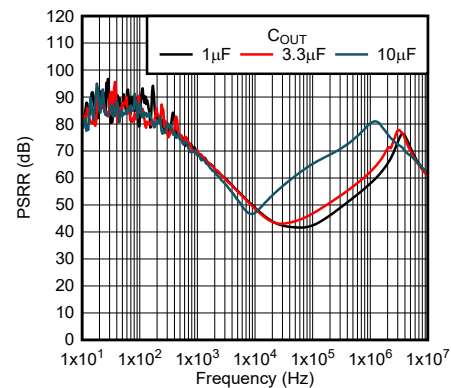

5-60. Ripple Rejection vs Frequency (New Chip)

5.7 Typical Characteristics (continued)

at $V_{IN} = V_{OUT} (\text{nominal}) + 1V$, $I_L = 100\mu A$, $C_L = 1\mu F$ (for new chip) and $C_L = 2.2\mu F$ (for legacy chip) (unless otherwise noted)

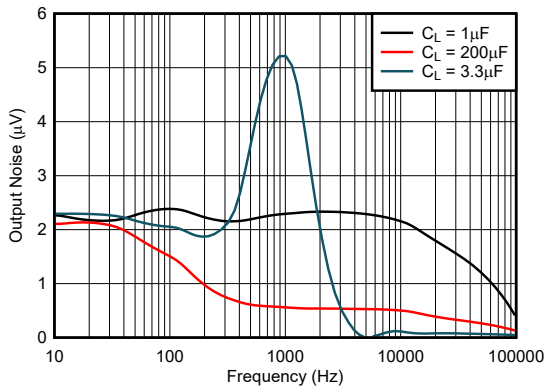

5-61. Output Noise vs Frequency (Legacy Chip)

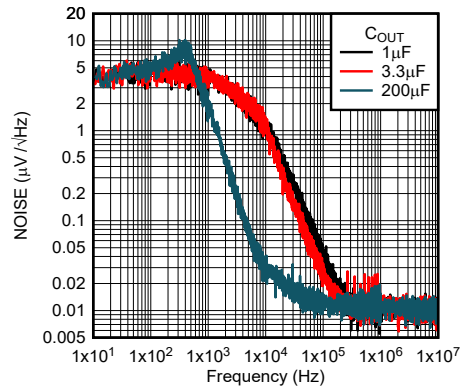

$V_{IN} = 6V$, $V_{OUT} = 5V$, $I_{OUT} = 100\mu A$

5-62. Output Noise vs Frequency (New Chip)

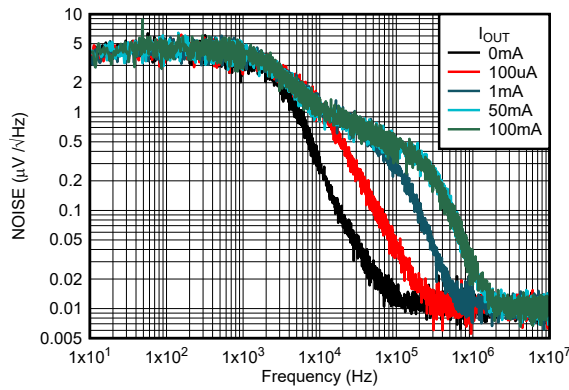

$V_{IN} = 6V$, $V_{OUT} = 5V$, $C_{OUT} = 1\mu F$

5-63. Output Noise vs Frequency (New Chip)

6 Detailed Description

6.1 Overview

The LP2950 and LP2951 devices are low-dropout voltage regulators that accommodate a wide input supply-voltage range of up to 30V. The easy-to-use, 3-pin LP2950 is available in fixed-output voltages of 5V and 3.3V. However, the 8-pin LP2951 device outputs either a fixed or adjustable output from the same device. By tying the OUTPUT and SENSE pins together, and the FEEDBACK and V_{TAP} pins together, the LP2951 device outputs a fixed 5V or 3.3V (depending on the version). Alternatively, by leaving the SENSE and V_{TAP} pins unconnected and connecting FEEDBACK to an external resistor divider, the output can be set to any value between 1.2V to 30V.

The LP2951 has a error flag output ($\overline{\text{ERROR}}$) that monitors the voltage at the feedback pin to indicate the status of the output voltage. The SHUTDOWN input and $\overline{\text{ERROR}}$ output can be used for sequencing multiple power supplies in the system.

The LP295x devices are stable with small ceramic output capacitors, allowing for a small overall solution size. The LP295x devices has an output tolerance of 1% across line, load, and temperature variation (for the new chip) and is capable of delivering 100mA of continuous load current. This device includes integrated thermal shutdown, current limit, and undervoltage lockout (UVLO) features. These devices deliver excellent line and load transient performance. The operating ambient temperature range of the device is -40°C to 125°C .

6.2 Functional Block Diagrams



図 6-1. LP2951 Functional Block Diagram

6.3 Feature Description

6.3.1 Output Enable

The SHUTDOWN pin for the device is an active-high pin. The output voltage is enabled when the SHUTDOWN pin voltage is less than the low-level input voltage of the SHUTDOWN pin. The output voltage is disabled when the SHUTDOWN pin voltage is greater than the high-level input voltage of the SHUTDOWN pin. If independent control of the output voltage is not needed, connect the SHUTDOWN pin to the GND of the device.

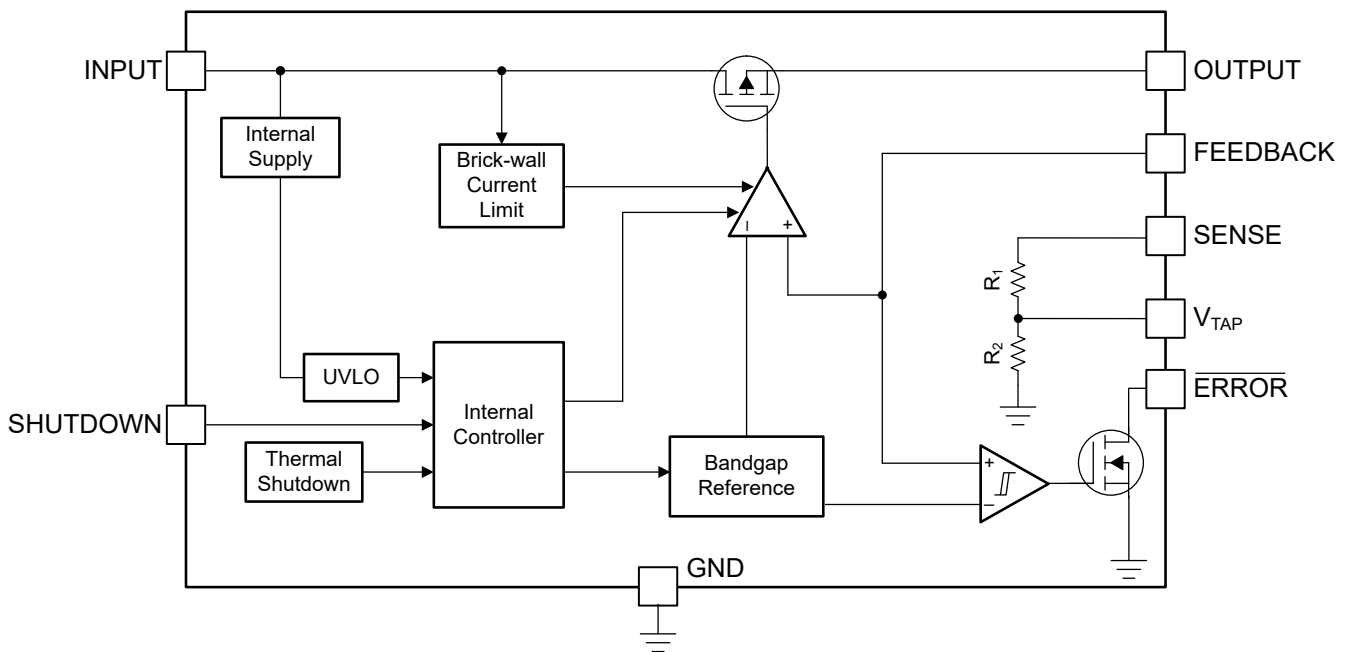
6.3.2 Dropout Voltage

Dropout voltage (V_{DO}) is defined as $V_{IN} - V_{OUT}$ at the rated output current (I_{RATED}), where the pass transistor is fully on. V_{IN} is the input voltage, V_{OUT} is the output voltage and I_{RATED} is the maximum I_{OUT} listed in the [セクション 5.3](#) table. At this operating point, the pass transistor is driven fully on. Dropout voltage indirectly specifies a minimum input voltage greater than the nominal programmed output voltage where the output voltage is expected to stay in regulation. If the input voltage falls to less than the nominal output regulation, then the output voltage falls as well.

For a CMOS regulator, the dropout voltage is determined by the drain-source on-state resistance ($R_{DS(ON)}$) of the pass transistor. Therefore, if the linear regulator operates at less than the rated current, the dropout voltage for that current scales accordingly. The following equation calculates the $R_{DS(ON)}$ of the device.

$$R_{DS(ON)} = \frac{V_{DO}}{I_{RATED}} \quad (1)$$

6.3.3 Current Limit

The device has an internal current limit circuit that protects the regulator during transient high-load current faults or shorting events. The current limit is a brick-wall scheme. In a high-load current fault, the brick-wall scheme limits the output current to the current limit (I_{CL}). I_{CL} is listed in the [セクション 5.5](#) table.

The output voltage is not regulated when the device is in current limit. When a current limit event occurs, the device begins to heat up because of the increase in power dissipation. When the device is in brick-wall current limit, the pass transistor dissipates power $[(V_{IN} - V_{OUT}) \times I_{CL}]$. If thermal shutdown is triggered, the device turns off. After the device cools down, the internal thermal shutdown circuit turns the device back on. If the output current fault condition continues, the device cycles between current limit and thermal shutdown. For more information on current limits, see the [Know Your Limits application note](#).

☒ 6-2 shows a diagram of the current limit.

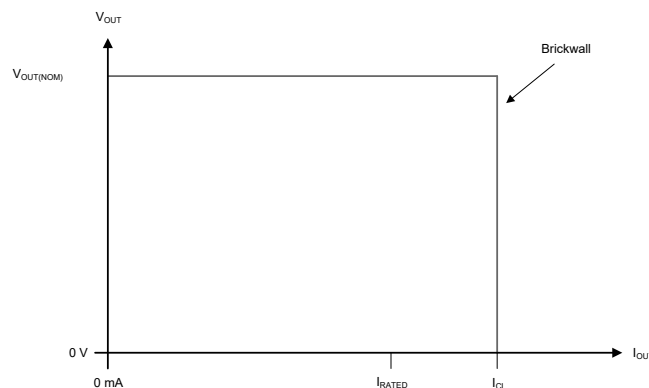

☒ 6-2. Current Limit

6.3.4 Undervoltage Lockout (UVLO)

The device has an independent undervoltage lockout (UVLO) circuit that monitors the input voltage, allowing a controlled and consistent turn on and off of the output voltage. To prevent the device from turning off if the input drops during turn on, the UVLO has hysteresis as specified in the [セクション 5.5](#) table.

6.3.5 Thermal Shutdown

The device contains a thermal shutdown protection circuit to disable the device when the junction temperature (T_J) of the pass transistor rises to $T_{SD(\text{shutdown})}$ (typical). Thermal shutdown hysteresis verifies that the device resets (turns on) when the temperature falls to $T_{SD(\text{reset})}$ (typical).

The thermal time-constant of the semiconductor die is fairly short, thus the device cycles on and off when thermal shutdown is reached until power dissipation is reduced. Power dissipation during start up is potentially high from large $V_{IN} - V_{OUT}$ voltage drops across the device or from high inrush currents charging large output capacitors. Under some conditions, the thermal shutdown protection disables the device before start-up completes.

For reliable operation, limit the junction temperature to the maximum listed in the [セクション 5.3](#) table. Operation above this maximum temperature causes the device to exceed operational specifications. Although the internal protection circuitry of the device is designed to protect against thermal overall conditions, this circuitry is not intended to replace proper heat sinking. Continuously running the device into thermal shutdown or above the maximum recommended junction temperature reduces long-term reliability.

6.4 Device Functional Modes

6.4.1 Shutdown Mode

These devices can be placed in shutdown mode with a logic high at the SHUTDOWN pin. Return the logic level low to restore operation or tie SHUTDOWN to ground if the feature is not being used.

7 Application and Implementation

注

以下のアプリケーション情報は、TI の製品仕様に含まれるものではなく、TI ではその正確性または完全性を保証いたしません。個々の目的に対する製品の適合性については、お客様の責任で判断していただくこととなります。お客様は自身の設計実装を検証しテストすることで、システムの機能を確認する必要があります。

7.1 Application Information

The LP295x devices are used as low-dropout regulators with a wide range of input voltages.

7.1.1 Reverse Current

Excessive reverse current potentially damages this device. Reverse current flows through the intrinsic body diode of the pass transistor instead of the normal conducting channel. At high magnitudes, this current flow degrades the long-term reliability of the device.

Conditions where reverse current occurs are outlined in this section, all of which potentially exceed the absolute maximum rating of $V_{OUT} \leq V_{IN} + 0.3V$.

- If the device has a large C_{OUT} and the input supply collapses with little or no load current
- The output is biased when the input supply is not established
- The output is biased above the input supply

If reverse current flow is expected in the application, use external protection to protect the device. Reverse current is not limited in the device, so external limiting is required if extended reverse voltage operation is anticipated.

 [7-1](#) shows one approach for protecting the device.



图 7-1. Example Circuit for Reverse Current Protection Using a Schottky Diode

7.1.2 Input and Output Capacitor Requirements

Although an input capacitor is not required for stability, good analog design practice is to connect a capacitor from IN to GND. This capacitor counteracts reactive input sources and improves transient response, input ripple, and PSRR. Use an input capacitor if the source impedance is more than 0.5Ω. A higher value capacitor can be necessary if large, fast rise-time load or line transients are anticipated or if the device is located several inches from the input power source.

Dynamic performance of the device is improved with the use of an output capacitor. Use an output capacitor within the range specified in the [セクション 5.3](#) table for stability.

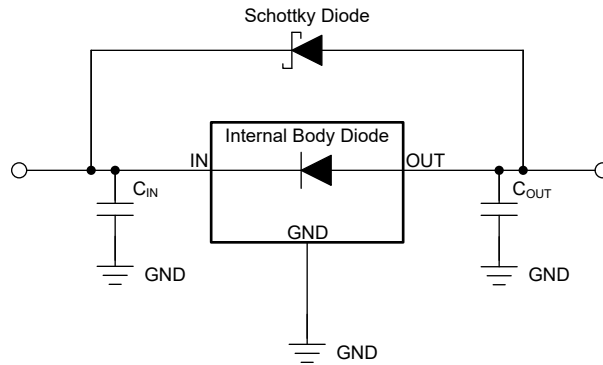
7.1.3 Estimating Junction Temperature

The JEDEC standard now recommends the use of psi (Ψ) thermal metrics to estimate the junction temperatures of the linear regulator when in-circuit on a typical PCB board application. These metrics are not thermal resistance parameters and instead offer a practical and relative way to estimate junction temperature. These psi metrics are determined to be significantly independent of the copper area available for heat-spreading. The [セクション 5.4](#) table lists the primary thermal metrics, which are the junction-to-top characterization parameter (ψ_{JT}) and junction-to-board characterization parameter (ψ_{JB}). These parameters provide two methods for calculating the junction temperature (T_J), as described in the following equations. Use the junction-to-top characterization parameter (ψ_{JT}) with the temperature at the center-top of device package (T_T) to calculate the junction temperature. Use the junction-to-board characterization parameter (ψ_{JB}) with the PCB surface temperature 1mm from the device package (T_B) to calculate the junction temperature.

$$T_J = T_T + \psi_{JT} \times P_D \quad (2)$$

where:

- P_D is the dissipated power
- T_T is the temperature at the center-top of the device package

$$T_J = T_B + \psi_{JB} \times P_D \quad (3)$$

where:

- T_B is the PCB surface temperature measured 1mm from the device package and centered on the package edge

For detailed information on the thermal metrics and how to use the metrics, see the [Semiconductor and IC Package Thermal Metrics](#) application note.

7.1.4 Power Dissipation (P_D)

Circuit reliability requires consideration of the device power dissipation, location of the circuit on the printed circuit board (PCB), and correct sizing of the thermal plane. The PCB area around the regulator must have few or no other heat-generating devices that cause added thermal stress.

To first-order approximation, power dissipation in the regulator depends on the input-to-output voltage difference and load conditions. The following equation calculates power dissipation (P_D).

$$P_D = (V_{IN} - V_{OUT}) \times I_{OUT} \quad (4)$$

注

Power dissipation is minimized, and therefore greater efficiency is achieved, by correct selection of the system voltage rails. For the lowest power dissipation use the minimum input voltage required for correct output regulation.

For devices with a thermal pad, the primary heat conduction path for the device package is through the thermal pad to the PCB. Solder the thermal pad to a copper pad area under the device. Make sure this pad area contains an array of plated vias that conduct heat to additional copper planes for increased heat dissipation.

The maximum power dissipation determines the maximum allowable ambient temperature (T_A) for the device. According to the following equation, power dissipation and junction temperature are most often related by the junction-to-ambient thermal resistance ($R_{\theta JA}$) of the combined PCB and device package and the temperature of the ambient air (T_A).

$$T_J = T_A + (R_{\theta JA} \times P_D) \quad (5)$$

Thermal resistance ($R_{\theta JA}$) is highly dependent on the heat-spreading capability built into the particular PCB design, and therefore varies according to the total copper area, copper weight, and location of the planes. The junction-to-ambient thermal resistance listed in the [セクション 5.4](#) table is determined by the JEDEC standard PCB and copper-spreading area. This thermal resistance is used as a relative measure of package thermal performance.

7.2 Typical Application



図 7-2. 12V to 5V Converter

7.2.1 Design Requirements

Minimum C_{OUT} value for stability (can be increased to 100µF for improved stability and transient response)

SHUTDOWN must be actively terminated. Connect to GND if shutdown feature is not used.

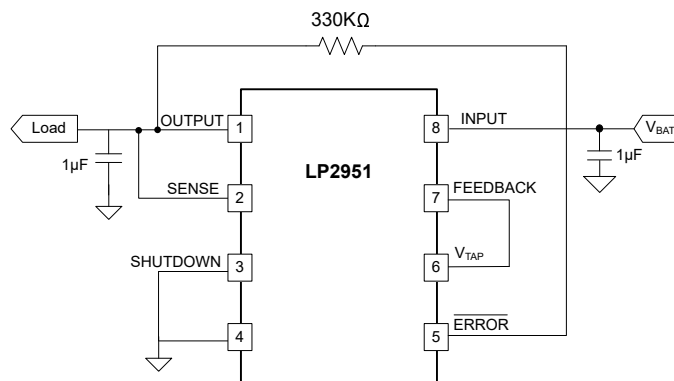
7.2.1.1 Recommended Capacitor Types

7.2.1.1.1 Recommended Capacitors for the Legacy Chip

Most tantalum or aluminum electrolytics are used at the input. Film-type capacitors also work but at higher cost. Ceramic capacitors are available for use at the output, but the low ESR (as low as 5mΩ to 10mΩ) potentially causes the output to not meet the minimum ESR requirement. If a ceramic capacitor is used, add a series resistor between 0.1Ω to 2Ω to meet the minimum ESR requirement.

Ceramic capacitors can be used, but because of the low ESR (as low as 5mΩ to 10mΩ), these capacitors can possibly not meet the minimum ESR requirement previously discussed. If a ceramic capacitor is used, a series resistor between 0.1Ω to 2Ω must be added to meet the minimum ESR requirement. In addition, ceramic capacitors have one glaring disadvantage that must be taken into account — a poor temperature coefficient, where the capacitance can vary significantly with temperature. For instance, a large-value ceramic capacitor ($\geq 2.2\mu\text{F}$) can lose more than half of the capacitance as temperature rises from 25°C to 85°C. Thus, a 2.2μF capacitor at 25°C drops well below the minimum C_L required for stability as ambient temperature rises. For this reason, select an output capacitor that maintains the minimum 2.2μF required for stability for the entire operating temperature range.

7.2.1.1.1.1 ESR Range (Legacy Chip)

The regulator control loop relies on the ESR of the output capacitor to provide a zero to add sufficient phase margin to provide unconditional regulator stability. This condition requires the closed-loop gain to intersect the open-loop response in a region where the open-loop gain rolls off at 20dB/decade. This roll off makes sure that the phase is always less than 180° (phase margin greater than 0°) at unity gain. Thus, a minimum-maximum range for the ESR must be observed.

The upper limit of this ESR range is established by the fact that an ESR that is too high can result in the zero occurring too soon, causing the gain to roll off too slowly. This effect, in turn, allows a third pole to appear before unity gain and introduces enough phase shift to cause instability. This phase shift typically limits the maximum ESR to approximately 5Ω.

Conversely, the lower limit of the ESR range is tied to the fact that an ESR that is too low shifts the zero too far out, past unity gain, which allows the gain to roll off at 40dB/decade at unity gain, resulting in a phase shift of greater than 180°. Typically, this limits the minimum ESR to approximately 20mΩ to 30mΩ.

For specific ESR requirements, see the [セクション 5.7](#) section.

7.2.1.1.2 Recommended Capacitors for the New Chip

The new chip requires an output capacitor of at least 1μF for stability and an equivalent series resistance (ESR) between 0Ω and 2Ω. Without the output capacitor, the regulator oscillates. For best transient performance, use X5R- and X7R-type ceramic capacitors because these capacitors have minimal variation in value and ESR over temperature. When choosing a capacitor for a specific application, be mindful of the DC bias characteristics for the capacitor. Higher output voltages cause a significant derating of the capacitor. For best performance, the maximum recommended output capacitor is 100μF. An input capacitor is not required for stability, however, good analog practice is to connect a capacitor (500nF or higher) between the GND and IN pin. Some input supplies have a high impedance, thus placing the input capacitor on the input supply helps reduce input impedance. This capacitor counteracts reactive input sources and improves transient response, input ripple, and PSRR. If the input supply has a high impedance over a large range of frequencies, use several input capacitors in parallel to lower the impedance over frequency. Use a higher-value capacitor if large, fast rise-time load transients are anticipated, or if the device is located several inches from the input power source.

7.2.2 Detailed Design Procedure

7.2.2.1 Feedback Resistor Selection

V_{OUT} is set by the external feedback resistors R_1 and R_2 according to the following equation:

$$V_{\text{OUT}} = V_{\text{FB}} \times \left(1 + \frac{R_1}{R_2}\right) \quad (6)$$

To ignore the FB pin current error term in the V_{OUT} equation, set the feedback divider current to 100 times the FB pin current listed in the [セクション 5.5](#) table. This setting provides the maximum feedback divider series resistance, as shown in the following equation:

$$R_1 + R_2 \leq \frac{V_{OUT}}{(I_{FB} \times 100)} \quad (7)$$

7.2.2.2 Feedforward Capacitor

Connect a feedforward capacitor (C_{FF}) between the OUT pin and the FB pin. C_{FF} improves transient, noise, and PSRR performance. A higher capacitance C_{FF} is possible, however, the start-up time increases. For a detailed description of C_{FF} tradeoffs, see the [Pros and Cons of Using a Feedforward Capacitor with a Low-Dropout Regulator application note](#).

As shown in [図 7-3](#), poor layout practices and using long traces at the FB pin results in the formation of a parasitic capacitor (C_{FB}).



図 7-3. Formation of Parasitic Capacitor at the FB Pin

C_{FB} , along with the feedback resistors R_1 and R_2 potentially result in the formation of an uncompensated pole in the transfer function of the loop gain. A C_{FB} value as small as 6pF potentially causes the parasitic pole frequency, given by [式 8](#), to fall within the bandwidth of the LDO and result in instability.

$$f_P = \frac{1}{(2 \times \pi \times C_{FB} \times (R_1 \parallel R_2))} \quad (8)$$

Adding a feedforward capacitor (C_{FF}), as shown in [図 7-4](#), creates a zero in the loop gain transfer function that can compensate for the parasitic pole created by C_{FB} . [式 9](#) and [式 10](#) calculate the pole and zero frequencies.

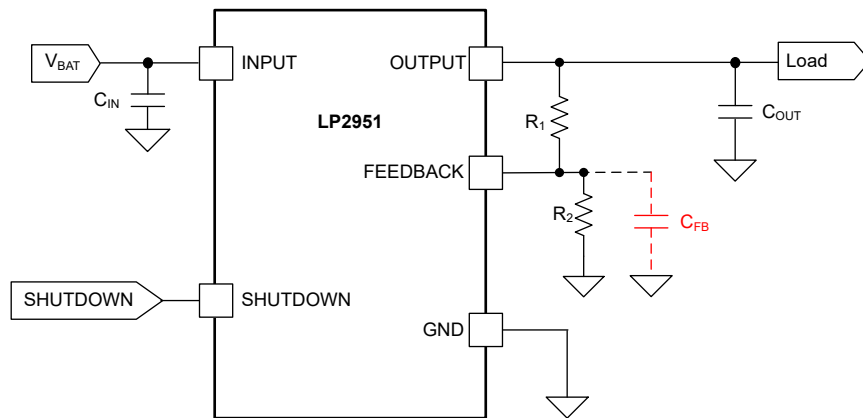

図 7-4. Feedforward Capacitor Can Compensate the Effects of the Parasitic Capacitor

$$f_p = \frac{1}{(2 \times \pi \times (R_1 \parallel R_2) \times (C_{FF} + C_{FB}))} \quad (9)$$

$$f_z = \frac{1}{(2 \times \pi \times C_{FF} \times R_1)} \quad (10)$$

The C_{FF} value that makes f_p equal to f_z , and result in a pole-zero cancellation, depends on the values of C_{FB} and the feedback resistors used in the application. Alternatively, if the feedforward capacitor is selected so that $C_{FF} \gg C_{FB}$, then the pole and zero frequencies given by 式 9 and 式 10 are related as:

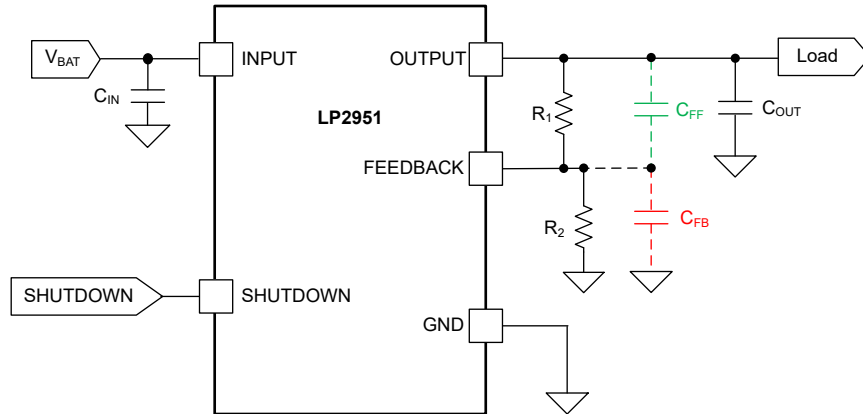
$$\frac{f_p}{f_z} \cong \left(1 + \frac{R_1}{R_2}\right) = \frac{V_{OUT}}{V_{FB}} \quad (11)$$

In most applications, particularly where a 3.3V or 5V V_{OUT} is generated, this ratio is not very large, implying that the frequencies are located close to each other and therefore the parasitic pole is compensated. Even for large V_{OUT} values, where this ratio can be as large as 20, a C_{FF} value in the range $100\text{pF} \leq C_{FF} \leq 10\text{nF}$ typically helps prevent instability caused by the parasitic capacitance on the feedback node.

7.2.3 Application Curve



図 7-5. Load Transient Response vs Time (Legacy Chip)



図 7-6. Load Transient Response vs Time (New Chip)

7.3 Power Supply Recommendations

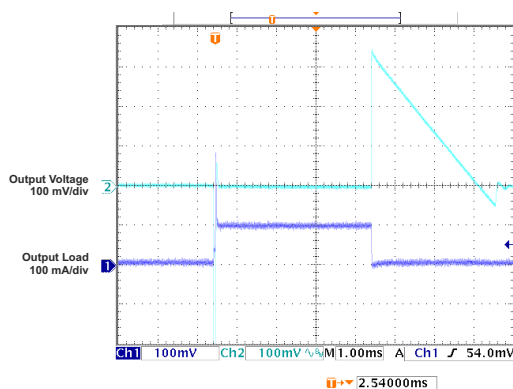
Maximum input voltage must be limited to 30V for proper operation. Place input and output capacitors as close to the device as possible to take advantage of the high frequency noise filtering properties.

7.4 Layout

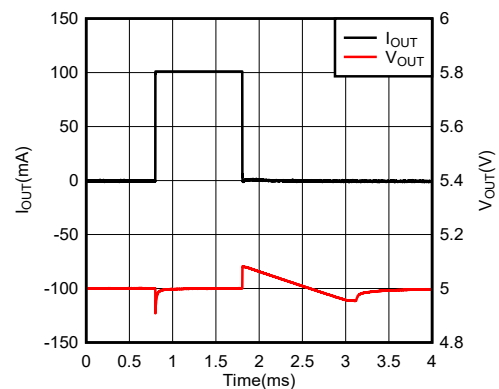
7.4.1 Layout Guidelines

Make sure that traces on the input and outputs of the device are wide enough to handle the desired currents. For this device, the output trace must be larger to accommodate the larger available current.

Place input and output capacitors as close to the device as possible to take advantage of the high-frequency, noise-filtering properties.

7.4.2 Layout Example



図 7-7. LP2951 Layout Example (D or P Package)

8 Device and Documentation Support

8.1 Device Support

8.1.1 Development Support

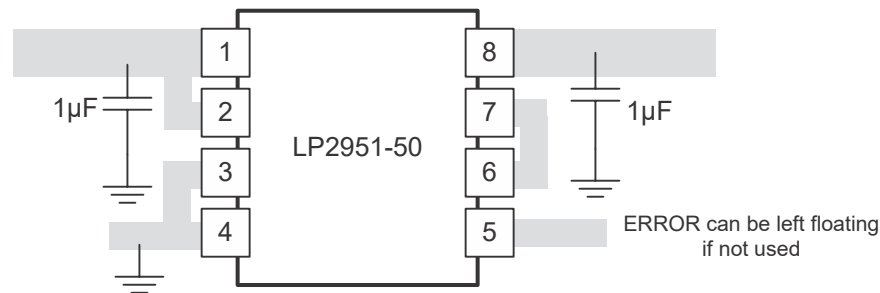
An evaluation module (EVM) is available to assist in the initial circuit performance evaluation. The [LP2951EVM](#) (and [related user guide](#)) can be requested at the Texas Instruments website through the product folders or purchased directly from the [TI eStore](#).

8.2 ドキュメントの更新通知を受け取る方法

ドキュメントの更新についての通知を受け取るには、www.tij.co.jp のデバイス製品フォルダを開いてください。[通知] をクリックして登録すると、変更されたすべての製品情報に関するダイジェストを毎週受け取ることができます。変更の詳細については、改訂されたドキュメントに含まれている改訂履歴をご覧ください。

8.3 Device Nomenclature

表 8-1. Device Nomenclature

PRODUCT ⁽¹⁾	V _{OUT}
LP2951- xx yyy z	<p>xx is the nominal output voltage (for example, 50 = 5.0V, 33 = 3.3V).</p> <p>yyy is the package designator.</p> <p>z is the package quantity.</p> <p>This device is able to output either a fixed or adjustable output from the same device. Devices can ship with the legacy chip (CSO: SHE) or the new chip (CSO: RFB). The reel packaging label provides CSO information to distinguish which chip is being used. Device performance for new and legacy chips is denoted throughout the data sheet.</p>
LP2951DR	<p>Adjustable option.</p> <p>Devices can ship with the legacy chip (CSO: SHE) or the new chip (CSO: RFB). The reel packaging label provides CSO information to distinguish which chip is being used. Device performance for new and legacy chips is denoted throughout the data sheet.</p>

表 8-1. Device Nomenclature (続き)

PRODUCT ⁽¹⁾	V _{OUT}
LP2950-xxyyyz	<p>xx is the nominal output voltage (for example, 50 = 5.0V, 33 = 3.3V). yyy is the package designator. z is the package quantity. Devices can ship with the legacy chip (CSO: SHE) or the new chip (CSO: RFB). The reel packaging label provides CSO information to distinguish which chip is being used. Device performance for new and legacy chips is denoted throughout the data sheet.</p>

(1) For the most current package and ordering information see the Package Option Addendum at the end of this document, or see the TI website at www.ti.com.

8.4 Documentation Support

8.4.1 Related Documentation

- Texas Instruments, [LP2951EVM](#), EVM user's guide

8.5 サポート・リソース

テキサス・インスツルメンツ E2E™ サポート・フォーラムは、エンジニアが検証済みの回答と設計に関するヒントをエキスパートから迅速かつ直接得ることができる場所です。既存の回答を検索したり、独自の質問をしたりすることで、設計に必要な支援を迅速に得ることができます。

リンクされているコンテンツは、各寄稿者により「現状のまま」提供されるものです。これらはテキサス・インスツルメンツの仕様を構成するものではなく、必ずしもテキサス・インスツルメンツの見解を反映したものではありません。テキサス・インスツルメンツの [使用条件](#) を参照してください。

8.6 Trademarks

テキサス・インスツルメンツ E2E™ is a trademark of Texas Instruments.
 すべての商標は、それぞれの所有者に帰属します。

8.7 静電気放電に関する注意事項



この IC は、ESD によって破損する可能性があります。テキサス・インスツルメンツは、IC を取り扱う際には常に適切な注意を払うことを推奨します。正しい取り扱いおよび設置手順に従わない場合、デバイスを破損するおそれがあります。

ESD による破損は、わずかな性能低下からデバイスの完全な故障まで多岐にわたります。精密な IC の場合、パラメータがわずかに変化するだけで公表されている仕様から外れる可能性があるため、破損が発生しやすくなっています。

8.8 用語集

[テキサス・インスツルメンツ用語集](#) この用語集には、用語や略語の一覧および定義が記載されています。

9 Revision History

資料番号末尾の英字は改訂を表しています。その改訂履歴は英語版に準じています。

Changes from Revision J (August 2024) to Revision K (December 2024)	Page
• ドキュメント全体にわたって表、図、相互参照の採番方法を更新.....	1
• LP パッケージの精度およびドロップアウトの仕様を更新.....	1
• LP パッケージの熱情報を追加.....	1
• Updated and added corrections to the operating temperature range in Recommended Operating Conditions section.....	4

Changes from Revision I (November 2014) to Revision J (August 2024)	Page
• ドキュメント全体にわたって表、図、相互参照の採番方法を更新.....	1
• 現在のファミリのフォーマットに合わせてドキュメント全体を変更.....	1

• ドキュメントに M3 デバイスを追加.....	1
• Added the <i>Device Support</i> section.....	29
• Changed the <i>Evaluation Module</i> section to the <i>Development Support</i> section.....	29
• Added the <i>Documentation Support</i> and <i>Related Documentation</i> sections.....	30

Changes from Revision H (March 2012) to Revision I (November 2014)
Page

• 「アプリケーション」、「製品情報」表、「取り扱い定格」表、「機能説明」セクション、「デバイスの機能モード」セクション、「アプリケーションと実装」セクション、「電源に関する推奨事項」セクション、「レイアウト」セクション、「デバイスおよびドキュメントのサポート」セクション、「メカニカル、パッケージ、および注文情報」セクションを追加	1
• 「注文情報」表を削除.....	1

10 Mechanical, Packaging, and Orderable Information

The following pages include mechanical, packaging, and orderable information. This information is the most current data available for the designated devices. This data is subject to change without notice and revision of this document. For browser-based versions of this data sheet, refer to the left-hand navigation.

PACKAGING INFORMATION

Orderable Device	Status (1)	Package Type	Package Drawing	Pins	Package Qty	Eco Plan (2)	Lead finish/ Ball material (6)	MSL Peak Temp (3)	Op Temp (°C)	Device Marking (4/5)	Samples
LP2950-30LP	ACTIVE	TO-92	LP	3	1000	RoHS & Green	SN	N / A for Pkg Type	-40 to 125	KY5030	Samples
LP2950-30LPR	ACTIVE	TO-92	LP	3	2000	RoHS & Green	SN	N / A for Pkg Type	-40 to 125	KY5030	Samples
LP2950-30LPRE3	ACTIVE	TO-92	LP	3	2000	RoHS & Green	SN	N / A for Pkg Type	-40 to 125	KY5030	Samples
LP2950-33LPE3	ACTIVE	TO-92	LP	3	1000	RoHS & Green	SN	N / A for Pkg Type	-40 to 125	KY5033	Samples
LP2950-33LPRE3	ACTIVE	TO-92	LP	3	2000	RoHS & Green	SN	N / A for Pkg Type	-40 to 125	KY5033	Samples
LP2950-50LPRE3	ACTIVE	TO-92	LP	3	2000	RoHS & Green	SN	N / A for Pkg Type	-40 to 125	KY5050	Samples
LP2951-30D	ACTIVE	SOIC	D	8	75	RoHS & Green	NIPDAU	Level-1-260C-UNLIM	-40 to 125	KY5130	Samples
LP2951-30DR	ACTIVE	SOIC	D	8	2500	RoHS & Green	NIPDAU	Level-1-260C-UNLIM	-40 to 125	KY5130	Samples
LP2951-30DRGR	ACTIVE	SON	DRG	8	3000	RoHS & Green	NIPDAU	Level-2-260C-1 YEAR	-40 to 125	ZUD	Samples
LP2951-33D	ACTIVE	SOIC	D	8	75	RoHS & Green	NIPDAU	Level-1-260C-UNLIM	-40 to 125	KY5133	Samples
LP2951-33DR	ACTIVE	SOIC	D	8	2500	RoHS & Green	NIPDAU	Level-1-260C-UNLIM	-40 to 125	KY5133	Samples
LP2951-33DRG4	ACTIVE	SOIC	D	8	2500	RoHS & Green	NIPDAU	Level-1-260C-UNLIM	-40 to 125	KY5133	Samples
LP2951-33DRGR	ACTIVE	SON	DRG	8	3000	RoHS & Green	NIPDAU	Level-2-260C-1 YEAR	-40 to 125	ZUE	Samples
LP2951-50D	ACTIVE	SOIC	D	8	75	RoHS & Green	NIPDAU	Level-1-260C-UNLIM	-40 to 125	KY5150	Samples
LP2951-50DR	ACTIVE	SOIC	D	8	2500	RoHS & Green	NIPDAU	Level-1-260C-UNLIM	-40 to 125	KY5150	Samples
LP2951-50DRG4	ACTIVE	SOIC	D	8	2500	RoHS & Green	NIPDAU	Level-1-260C-UNLIM	-40 to 125	KY5150	Samples
LP2951-50DRGR	ACTIVE	SON	DRG	8	3000	RoHS & Green	NIPDAU	Level-2-260C-1 YEAR	-40 to 125	ZUF	Samples
LP2951D	ACTIVE	SOIC	D	8	75	RoHS & Green	NIPDAU	Level-1-260C-UNLIM	-40 to 125	LP2951	Samples
LP2951DR	ACTIVE	SOIC	D	8	2500	RoHS & Green	NIPDAU	Level-1-260C-UNLIM	-40 to 125	LP2951	Samples
LP2951DRG4	ACTIVE	SOIC	D	8	2500	RoHS & Green	NIPDAU	Level-1-260C-UNLIM	-40 to 125	LP2951	Samples

(1) The marketing status values are defined as follows:

ACTIVE: Product device recommended for new designs.

LIFEBUY: TI has announced that the device will be discontinued, and a lifetime-buy period is in effect.

NRND: Not recommended for new designs. Device is in production to support existing customers, but TI does not recommend using this part in a new design.

PREVIEW: Device has been announced but is not in production. Samples may or may not be available.

OBSOLETE: TI has discontinued the production of the device.

(2) **RoHS:** TI defines "RoHS" to mean semiconductor products that are compliant with the current EU RoHS requirements for all 10 RoHS substances, including the requirement that RoHS substance do not exceed 0.1% by weight in homogeneous materials. Where designed to be soldered at high temperatures, "RoHS" products are suitable for use in specified lead-free processes. TI may reference these types of products as "Pb-Free".

RoHS Exempt: TI defines "RoHS Exempt" to mean products that contain lead but are compliant with EU RoHS pursuant to a specific EU RoHS exemption.

Green: TI defines "Green" to mean the content of Chlorine (Cl) and Bromine (Br) based flame retardants meet JS709B low halogen requirements of ≤ 1000 ppm threshold. Antimony trioxide based flame retardants must also meet the ≤ 1000 ppm threshold requirement.

(3) MSL, Peak Temp. - The Moisture Sensitivity Level rating according to the JEDEC industry standard classifications, and peak solder temperature.

(4) There may be additional marking, which relates to the logo, the lot trace code information, or the environmental category on the device.

(5) Multiple Device Markings will be inside parentheses. Only one Device Marking contained in parentheses and separated by a "~" will appear on a device. If a line is indented then it is a continuation of the previous line and the two combined represent the entire Device Marking for that device.

(6) Lead finish/Ball material - Orderable Devices may have multiple material finish options. Finish options are separated by a vertical ruled line. Lead finish/Ball material values may wrap to two lines if the finish value exceeds the maximum column width.

Important Information and Disclaimer: The information provided on this page represents TI's knowledge and belief as of the date that it is provided. TI bases its knowledge and belief on information provided by third parties, and makes no representation or warranty as to the accuracy of such information. Efforts are underway to better integrate information from third parties. TI has taken and continues to take reasonable steps to provide representative and accurate information but may not have conducted destructive testing or chemical analysis on incoming materials and chemicals. TI and TI suppliers consider certain information to be proprietary, and thus CAS numbers and other limited information may not be available for release.

In no event shall TI's liability arising out of such information exceed the total purchase price of the TI part(s) at issue in this document sold by TI to Customer on an annual basis.

OTHER QUALIFIED VERSIONS OF LP2951 :

- Automotive : [LP2951-Q1](#)

NOTE: Qualified Version Definitions:

- Automotive - Q100 devices qualified for high-reliability automotive applications targeting zero defects

TAPE AND REEL INFORMATION

QUADRANT ASSIGNMENTS FOR PIN 1 ORIENTATION IN TAPE

*All dimensions are nominal

Device	Package Type	Package Drawing	Pins	SPQ	Reel Diameter (mm)	Reel Width W1 (mm)	A0 (mm)	B0 (mm)	K0 (mm)	P1 (mm)	W (mm)	Pin1 Quadrant
LP2951-30DR	SOIC	D	8	2500	330.0	12.4	6.4	5.2	2.1	8.0	12.0	Q1
LP2951-30DRGR	SON	DRG	8	3000	330.0	12.4	3.3	3.3	1.1	8.0	12.0	Q2
LP2951-33DR	SOIC	D	8	2500	330.0	12.4	6.4	5.2	2.1	8.0	12.0	Q1
LP2951-33DRGR	SON	DRG	8	3000	330.0	12.4	3.3	3.3	1.1	8.0	12.0	Q2
LP2951-50DR	SOIC	D	8	2500	330.0	12.4	6.4	5.2	2.1	8.0	12.0	Q1
LP2951-50DR	SOIC	D	8	2500	330.0	12.4	6.4	5.2	2.1	8.0	12.0	Q1
LP2951-50DRGR	SON	DRG	8	3000	330.0	12.4	3.3	3.3	1.1	8.0	12.0	Q2
LP2951DR	SOIC	D	8	2500	330.0	12.4	6.4	5.2	2.1	8.0	12.0	Q1
LP2951DR	SOIC	D	8	2500	330.0	12.4	6.4	5.2	2.1	8.0	12.0	Q1

TAPE AND REEL BOX DIMENSIONS

*All dimensions are nominal

Device	Package Type	Package Drawing	Pins	SPQ	Length (mm)	Width (mm)	Height (mm)
LP2951-30DR	SOIC	D	8	2500	353.0	353.0	32.0
LP2951-30DRGR	SON	DRG	8	3000	367.0	367.0	35.0
LP2951-33DR	SOIC	D	8	2500	340.5	338.1	20.6
LP2951-33DRGR	SON	DRG	8	3000	367.0	367.0	35.0
LP2951-50DR	SOIC	D	8	2500	353.0	353.0	32.0
LP2951-50DR	SOIC	D	8	2500	340.5	338.1	20.6
LP2951-50DRGR	SON	DRG	8	3000	367.0	367.0	35.0
LP2951DR	SOIC	D	8	2500	353.0	353.0	32.0
LP2951DR	SOIC	D	8	2500	340.5	338.1	20.6

TUBE

*All dimensions are nominal

Device	Package Name	Package Type	Pins	SPQ	L (mm)	W (mm)	T (μm)	B (mm)
LP2951-30D	D	SOIC	8	75	507	8	3940	4.32
LP2951-33D	D	SOIC	8	75	507	8	3940	4.32
LP2951-50D	D	SOIC	8	75	507	8	3940	4.32
LP2951D	D	SOIC	8	75	507	8	3940	4.32



D0008A

PACKAGE OUTLINE

SOIC - 1.75 mm max height

SMALL OUTLINE INTEGRATED CIRCUIT



4214825/C 02/2019

NOTES:

- Linear dimensions are in inches [millimeters]. Dimensions in parenthesis are for reference only. Controlling dimensions are in inches. Dimensioning and tolerancing per ASME Y14.5M.
- This drawing is subject to change without notice.
- This dimension does not include mold flash, protrusions, or gate burrs. Mold flash, protrusions, or gate burrs shall not exceed $.006$ [0.15] per side.
- This dimension does not include interlead flash.
- Reference JEDEC registration MS-012, variation AA.

EXAMPLE BOARD LAYOUT

D0008A

SOIC - 1.75 mm max height

SMALL OUTLINE INTEGRATED CIRCUIT



LAND PATTERN EXAMPLE
 EXPOSED METAL SHOWN
 SCALE:8X



SOLDER MASK DETAILS

4214825/C 02/2019

NOTES: (continued)

- 6. Publication IPC-7351 may have alternate designs.
- 7. Solder mask tolerances between and around signal pads can vary based on board fabrication site.

EXAMPLE STENCIL DESIGN

D0008A

SOIC - 1.75 mm max height

SMALL OUTLINE INTEGRATED CIRCUIT



SOLDER PASTE EXAMPLE
BASED ON .005 INCH [0.125 MM] THICK STENCIL
SCALE:8X

4214825/C 02/2019

NOTES: (continued)

8. Laser cutting apertures with trapezoidal walls and rounded corners may offer better paste release. IPC-7525 may have alternate design recommendations.
9. Board assembly site may have different recommendations for stencil design.

DRG (S-PWSON-N8)

PLASTIC SMALL OUTLINE NO-LEAD

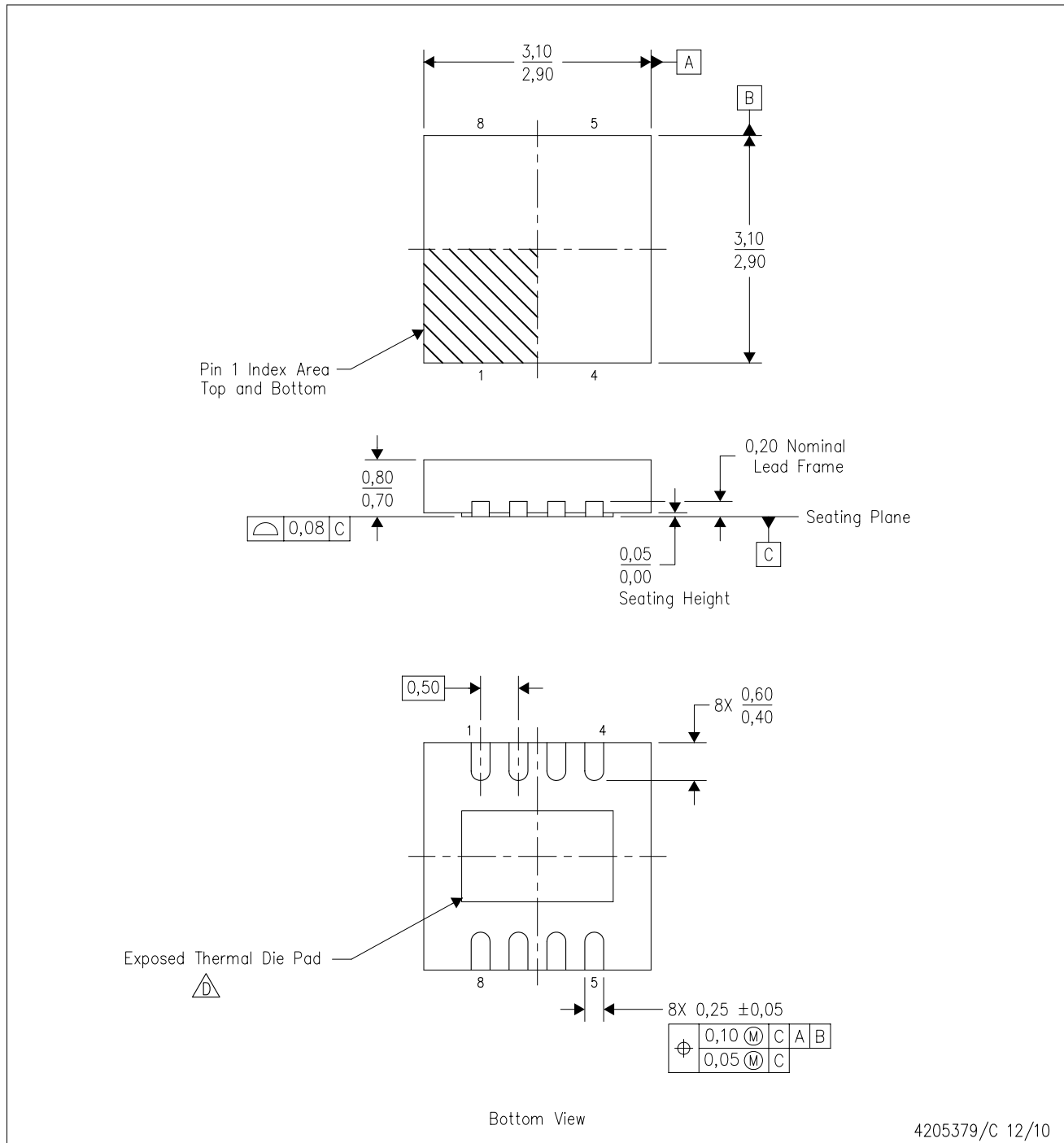

4205379/C 12/10

- NOTES:
- A. All linear dimensions are in millimeters. Dimensioning and tolerancing per ASME Y14.5M-1994.
 - B. This drawing is subject to change without notice.
 - C. SON (Small Outline No-Lead) package configuration.
 - D. The package thermal pad must be soldered to the board for thermal and mechanical performance. See the Product Data Sheet for details regarding the exposed thermal pad dimensions.
 - E. JEDEC MO-229 package registration pending.

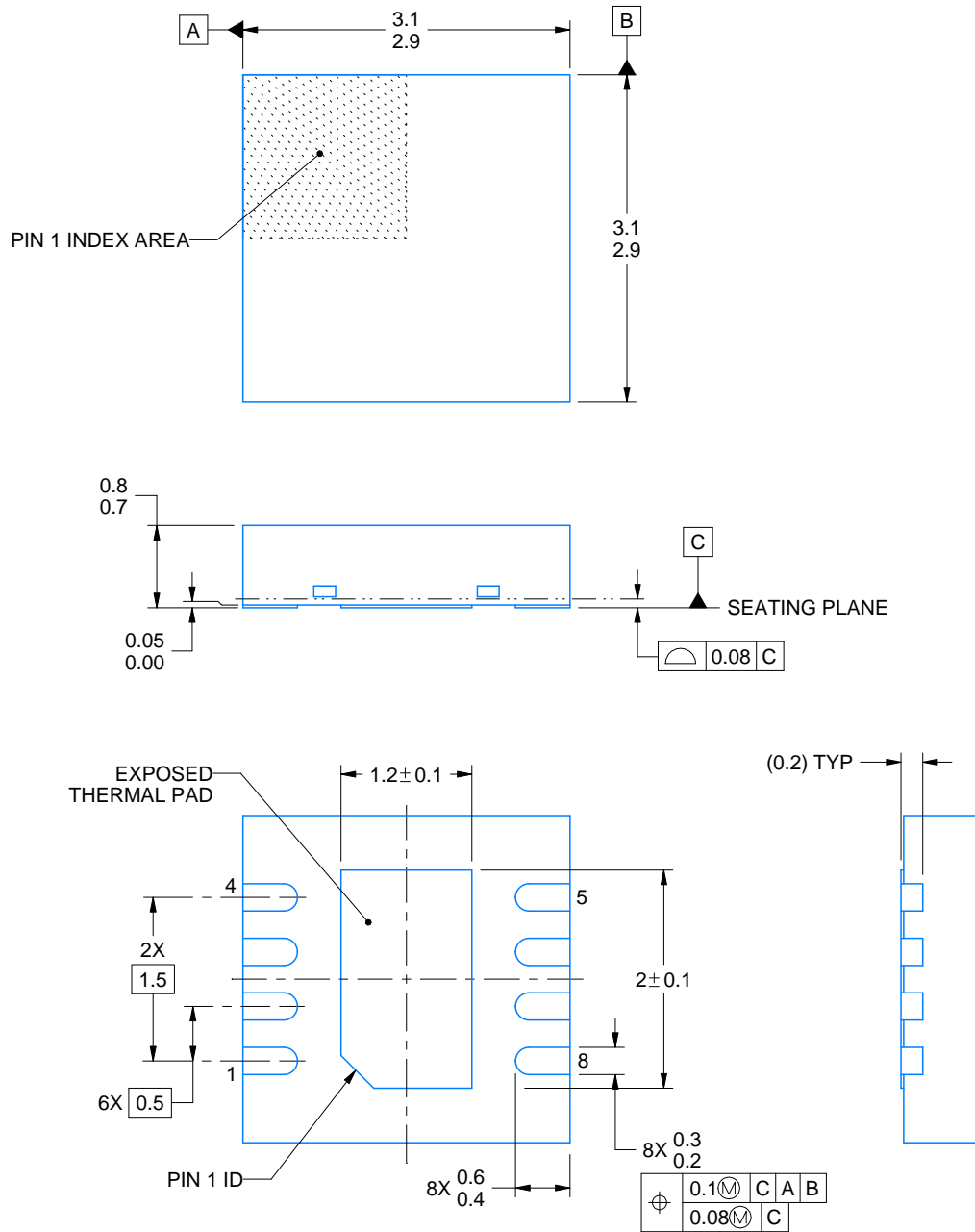
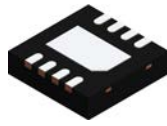

4218885/A 03/2020

NOTES:

1. All linear dimensions are in millimeters. Any dimensions in parenthesis are for reference only. Dimensioning and tolerancing per ASME Y14.5M.
2. This drawing is subject to change without notice.
3. The package thermal pad must be soldered to the printed circuit board for thermal and mechanical performance.

EXAMPLE BOARD LAYOUT

DRG0008A

WSON - 0.8 mm max height

PLASTIC SMALL OUTLINE - NO LEAD

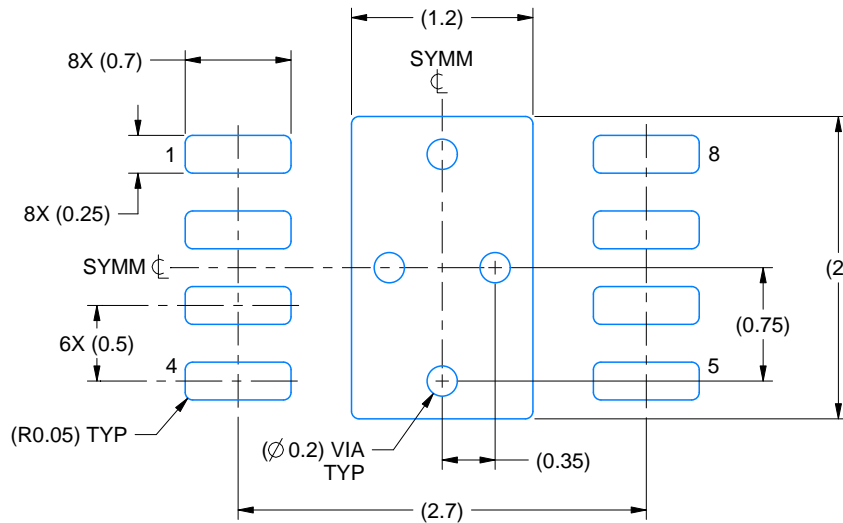

LAND PATTERN EXAMPLE
EXPOSED METAL SHOWN
SCALE:20X

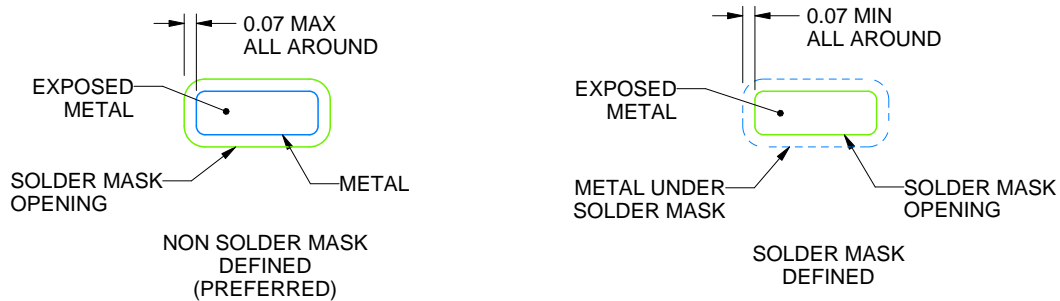

SOLDER MASK DETAILS

4218885/A 03/2020

NOTES: (continued)

4. This package is designed to be soldered to a thermal pad on the board. For more information, see Texas Instruments literature number SLUA271 (www.ti.com/lit/slua271).
5. Vias are optional depending on application, refer to device data sheet. If any vias are implemented, refer to their locations shown on this view. It is recommended that vias under paste be filled, plugged or tented.

EXAMPLE STENCIL DESIGN

DRG0008A

WSON - 0.8 mm max height

PLASTIC SMALL OUTLINE - NO LEAD

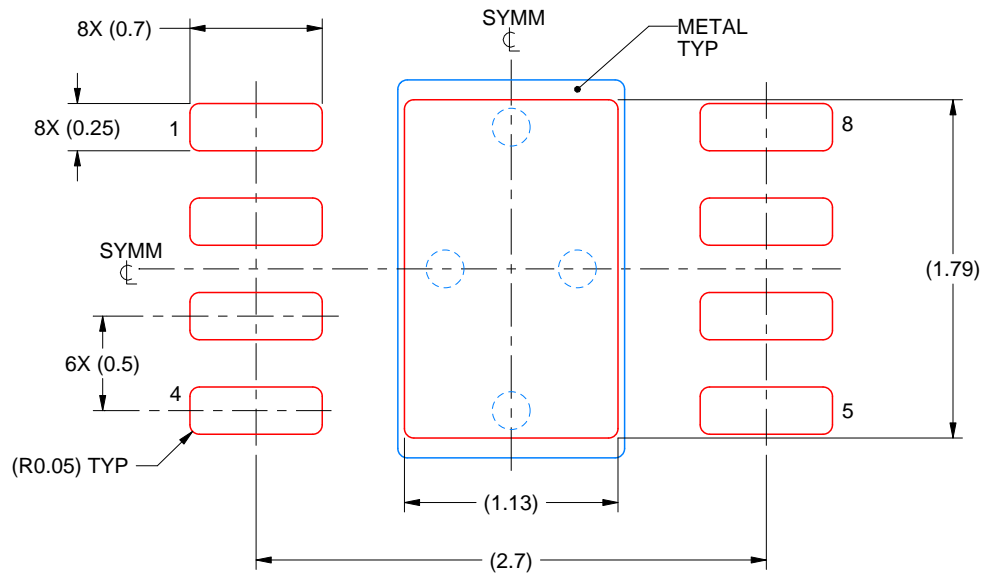

SOLDER PASTE EXAMPLE
BASED ON 0.125 mm THICK STENCIL

EXPOSED PAD
84% PRINTED SOLDER COVERAGE BY AREA
SCALE:25X

4218885/A 03/2020

NOTES: (continued)

6. Laser cutting apertures with trapezoidal walls and rounded corners may offer better paste release. IPC-7525 may have alternate design recommendations.

GENERIC PACKAGE VIEW

LP 3

TO-92 - 5.34 mm max height

TRANSISTOR OUTLINE



Images above are just a representation of the package family, actual package may vary.
Refer to the product data sheet for package details.

4040001-2/F

LP0003A



PACKAGE OUTLINE

TO-92 - 5.34 mm max height

TO-92



4215214/B 04/2017

NOTES:

1. All linear dimensions are in millimeters. Any dimensions in parenthesis are for reference only. Dimensioning and tolerancing per ASME Y14.5M.
2. This drawing is subject to change without notice.
3. Lead dimensions are not controlled within this area.
4. Reference JEDEC TO-226, variation AA.
5. Shipping method:
 - a. Straight lead option available in bulk pack only.
 - b. Formed lead option available in tape and reel or ammo pack.
 - c. Specific products can be offered in limited combinations of shipping medium and lead options.
 - d. Consult product folder for more information on available options.

EXAMPLE BOARD LAYOUT

LP0003A

TO-92 - 5.34 mm max height

TO-92



LAND PATTERN EXAMPLE
STRAIGHT LEAD OPTION
NON-SOLDER MASK DEFINED
SCALE:15X



LAND PATTERN EXAMPLE
FORMED LEAD OPTION
NON-SOLDER MASK DEFINED
SCALE:15X

4215214/B 04/2017

TAPE SPECIFICATIONS

LP0003A

TO-92 - 5.34 mm max height

TO-92



FOR FORMED LEAD OPTION PACKAGE

4215214/B 04/2017

重要なお知らせと免責事項

テキサス・インスツルメンツは、技術データと信頼性データ(データシートを含みます)、設計リソース(リファレンス デザインを含みます)、アプリケーションや設計に関する各種アドバイス、Web ツール、安全性情報、その他のリソースを、欠陥が存在する可能性のある「現状のまま」提供しており、商品性および特定目的に対する適合性の黙示保証、第三者の知的財産権の非侵害保証を含むいかなる保証も、明示的または黙示的にかかわらず拒否します。

これらのリソースは、テキサス・インスツルメンツ製品を使用する設計の経験を積んだ開発者への提供を意図したものです。(1) お客様のアプリケーションに適したテキサス・インスツルメンツ製品の選定、(2) お客様のアプリケーションの設計、検証、試験、(3) お客様のアプリケーションに該当する各種規格や、その他のあらゆる安全性、セキュリティ、規制、または他の要件への確実な適合に関する責任を、お客様のみが単独で負うものとし、ます。

上記の各種リソースは、予告なく変更される可能性があります。これらのリソースは、リソースで説明されているテキサス・インスツルメンツ製品を使用するアプリケーションの開発の目的でのみ、テキサス・インスツルメンツはその使用をお客様に許諾します。これらのリソースに関して、他の目的で複製することや掲載することは禁止されています。テキサス・インスツルメンツや第三者の知的財産権のライセンスが付与されている訳ではありません。お客様は、これらのリソースを自身で使用した結果発生するあらゆる申し立て、損害、費用、損失、責任について、テキサス・インスツルメンツおよびその代理人を完全に補償するものとし、テキサス・インスツルメンツは一切の責任を拒否します。

テキサス・インスツルメンツの製品は、[テキサス・インスツルメンツの販売条件](#)、または [ti.com](https://www.ti.com) やかかるテキサス・インスツルメンツ製品の関連資料などのいずれかを通じて提供する適用可能な条項の下で提供されています。テキサス・インスツルメンツがこれらのリソースを提供することは、適用されるテキサス・インスツルメンツの保証または他の保証の放棄の拡大や変更を意味するものではありません。

お客様がいかなる追加条項または代替条項を提案した場合でも、テキサス・インスツルメンツはそれらに異議を唱え、拒否します。

郵送先住所：Texas Instruments, Post Office Box 655303, Dallas, Texas 75265
Copyright © 2025, Texas Instruments Incorporated