

## SNx4AHCT86 クワッド、2 入力排他 OR (EXOR) ゲート

### 1 特長

- 入力は TTL 電圧互換
- JESD 17 準拠で 250mA 超のラッチアップ性能
- MIL-PRF-38535 準拠の製品については、特に記述のない限り、すべてのパラメータはテスト済みです。その他のすべての製品については、量産プロセスにすべてのパラメータのテストが含まれているとは限りません。
- JESD 22 を超える ESD 保護
  - 2000V、人体モデル (A114-A)
  - 200V、マシン・モデル (A115-A)

### 2 アプリケーション

- サーバー
- PC およびノートパソコン
- ネットワーク・スイッチ
- ウェアラブルなヘルスケア/フィットネス機器
- テレコム・インフラストラクチャ
- レジ用電子機器

### 3 概要

SNx4AHCT86 デバイスは、クワッド 2 入力排他 OR ゲートです。これらのデバイスは、ブール関数  $Y = A \times B$  または  $Y = \bar{A}B + A\bar{B}$  を正論理で実行します。

#### パッケージ情報 (1)

部品番号	パッケージ	本体サイズ (公称)
SN54AHCT86	J (CDIP, 14)	19.56mm × 6.67mm
	W (CFP, 14)	13.09mm × 6.92mm
	FK (LCCC, 20)	8.89mm × 8.89mm
SN74AHCT86	N (PDIP, 14)	19.3mm × 6.35mm
	D (SOIC, 14)	8.65mm × 3.91mm
	NS (SOP, 14)	10.30mm × 5.30mm
	DB (SSOP, 14)	6.20mm × 5.30mm
	PW (TSSOP, 14)	5.00mm × 4.40mm
	DGV (TVSOP, 14)	3.60mm × 4.40mm
	RGY (VQFN, 14)	3.50mm × 3.50mm
BQA (WQFN, 14)	3.00mm × 2.50mm	

(1) 利用可能なパッケージについては、このデータシートの末尾にある注文情報を参照してください。

An exclusive-OR gate has many applications, some of which can be represented better by alternative logic symbols.



These are five equivalent exclusive-OR symbols valid for an SN74AHCT86 gate in positive logic; negation may be shown at any two ports.

#### LOGIC-IDENTITY ELEMENT

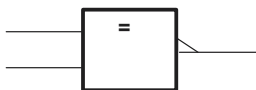

The output is active (low) if all inputs stand at the same logic level (that is,  $A = B$ ).

#### EVEN-PARITY ELEMENT

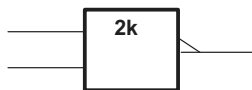

The output is active (low) if an even number of inputs (that is, 0 or 2) are active.

#### ODD-PARITY ELEMENT

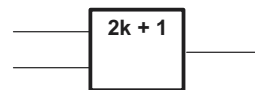

The output is active (high) if an odd number of inputs (that is, only 1 of the 2) are active.

### 概略回路図



## Table of Contents

<b>1 特長</b> .....	1	8.1 Overview.....	9
<b>2 アプリケーション</b> .....	1	8.2 Functional Block Diagram.....	9
<b>3 概要</b> .....	1	8.3 Feature Description.....	9
<b>4 Revision History</b> .....	2	8.4 Device Functional Modes.....	9
<b>5 Pin Configuration and Functions</b> .....	3	<b>9 Application and Implementation</b> .....	10
<b>6 Specifications</b> .....	5	9.1 Application Information.....	10
6.1 Absolute Maximum Ratings.....	5	9.2 Typical Application.....	10
6.2 ESD Ratings.....	5	9.3 Power Supply Recommendations.....	11
6.3 Recommended Operating Conditions.....	5	9.4 Layout.....	11
6.4 Thermal Information.....	6	<b>10 Device and Documentation Support</b> .....	12
6.5 Electrical Characteristics.....	6	10.1 ドキュメントの更新通知を受け取る方法.....	12
6.6 Switching Characteristics.....	6	10.2 サポート・リソース.....	12
6.7 Noise Characteristics.....	7	10.3 Trademarks.....	12
6.8 Operating Characteristics.....	7	10.4 静電気放電に関する注意事項.....	12
6.9 Typical Characteristics.....	7	10.5 用語集.....	12
<b>7 Parameter Measurement Information</b> .....	8	<b>11 Mechanical, Packaging, and Orderable Information</b> .....	12
<b>8 Detailed Description</b> .....	9		

## 4 Revision History

資料番号末尾の英字は改訂を表しています。その改訂履歴は英語版に準じています。

Changes from Revision O (May 2023) to Revision P (October 2023)	Page
<ul style="list-style-type: none"> <li>Updated R<math>\theta</math>JA values: D = 97.5 to 124.5, PW = 125.1 to 147.7; Updated D and PW packages for R<math>\theta</math>JC(top), R<math>\theta</math>JB, <math>\Psi</math>JT, <math>\Psi</math>JB, and R<math>\theta</math>JC(bot), all values in °C/W .....</li> </ul>	6
Changes from Revision N (August 2014) to Revision O (May 2023)	Page
<ul style="list-style-type: none"> <li>ドキュメント全体にわたって表、図、相互参照の採番方法を更新.....</li> <li>「パッケージ情報」表を更新 .....</li> <li>データシートに BQA パッケージを追加 .....</li> </ul>	1

## 5 Pin Configuration and Functions



**図 5-1. SN54AHCT86 J or W Package, 14-Pin (Top View)**  
**SN74AHCT86 D, DB, DGV, N, NS, or PW Package, 14-Pin (Top View)**

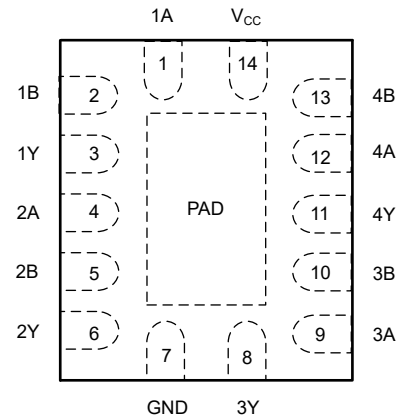

**図 5-2. SN74AHCT86 RGY or BQA Package, 14-Pin (Top View)**

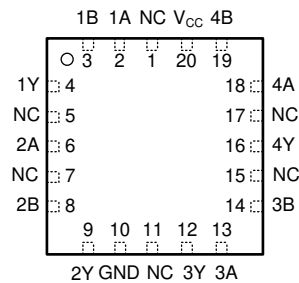

**図 5-3. SN54AHCT86 FK Package, 20-Pin (Top View)**

**表 5-1. Pin Functions**

NAME	PIN				TYPE <sup>(1)</sup>	DESCRIPTION
	SN74AHCT86		SN54AHCT86			
	D, DB, DGV, N, NS, PW	RGY, BQA	J, W	FK		
1A	1	1	1	2	I	1A Input
1B	2	2	2	3	I	1B Input
1Y	3	3	3	4	O	1Y Output
2A	4	4	4	6	I	2A Input
2B	5	5	5	8	I	2B Input
2Y	6	6	6	9	O	2Y Output
3Y	8	8	8	12	O	3Y Output
3A	9	9	9	13	I	3A Input
3B	10	10	10	14	I	3B Input
4Y	11	11	11	16	O	4Y Output
4A	12	12	12	18	I	4A Input
4B	13	13	13	19	I	4B Input
GND	7	7	7	10	—	Ground Pin
NC	—	—	—	1, 5, 7, 11, 15, 17	—	No Connection
V <sub>CC</sub>	14	14	14	20	—	Power Pin

表 5-1. Pin Functions (続き)

NAME	PIN				TYPE <sup>(1)</sup>	DESCRIPTION
	SN74AHCT86		SN54AHCT86			
	D, DB, DGV, N, NS, PW	RGY, BQA	J, W	FK		
Thermal Pad	—	PAD	—	—	—	Thermal Pad

(1) I = input, O = output

## 6 Specifications

### 6.1 Absolute Maximum Ratings

over operating free-air temperature range (unless otherwise noted)<sup>(1)</sup>

		MIN	MAX	UNIT
V <sub>CC</sub>	Supply voltage range	-0.5	7	V
V <sub>I</sub>	Input voltage range <sup>(2)</sup>	-0.5	7	V
V <sub>O</sub>	Output voltage range <sup>(2)</sup>	-0.5	V <sub>CC</sub> + 0.5	V
I <sub>IK</sub>	Input clamp current	V <sub>I</sub> < 0	-20	mA
I <sub>OK</sub>	Output clamp current	V <sub>O</sub> < 0 or V <sub>O</sub> > V <sub>CC</sub>	±20	mA
I <sub>O</sub>	Continuous output current	V <sub>O</sub> = 0 to V <sub>CC</sub>	±25	mA
Continuous current through V <sub>CC</sub> or GND			±50	mA

- (1) Stresses beyond those listed under *Absolute Maximum Ratings* may cause permanent damage to the device. These are stress ratings only, and functional operation of the device at these or any other conditions beyond those indicated under *Recommended Operating Conditions* is not implied. Exposure to absolute-maximum-rated conditions for extended periods may affect device reliability.
- (2) The input and output voltage ratings may be exceeded if the input and output current ratings are observed.

### 6.2 ESD Ratings

		MIN	MAX	UNIT	
T <sub>stg</sub>	Storage temperature range	-65	150	°C	
V <sub>(ESD)</sub>	Electrostatic discharge	Human body model (HBM), per ANSI/ESDA/JEDEC JS-001, all pins <sup>(1)</sup>	0	2000	V
		Charged device model (CDM), per ANSI/ESDA/JEDEC JS-002, all pins <sup>(2)</sup>	0	1000	

- (1) JEDEC document JEP155 states that 500-V HBM allows safe manufacturing with a standard ESD control process.
- (2) JEDEC document JEP157 states that 250-V CDM allows safe manufacturing with a standard ESD control process.

### 6.3 Recommended Operating Conditions

over operating free-air temperature range (unless otherwise noted)<sup>(1)</sup>

		SN54AHCT86		SN74AHCT86		UNIT
		MIN	MAX	MIN	MAX	
V <sub>CC</sub>	Supply voltage	4.5	5.5	4.5	5.5	V
V <sub>IH</sub>	High-level input voltage	2		2		V
V <sub>IL</sub>	Low-level input voltage		0.8		0.8	V
V <sub>I</sub>	Input voltage	0	5.5	0	5.5	V
V <sub>O</sub>	Output voltage	0	V <sub>CC</sub>	0	V <sub>CC</sub>	V
I <sub>OH</sub>	High-level output current		-8		-8	mA
I <sub>OL</sub>	Low-level output current		8		8	mA
Δt/Δv	Input transition rise or fall rate		20		20	ns/V
T <sub>A</sub>	Operating free-air temperature	-55	125	-40	125	°C

- (1) All unused inputs of the device must be held at V<sub>CC</sub> or GND to ensure proper device operation. Refer to the TI application report, *Implications of Slow or Floating CMOS Inputs (SCBA004)*.

## 6.4 Thermal Information

THERMAL METRIC <sup>(1)</sup>		SNx4AHCT86								UNIT
		D	DB	DGV	N	NS	PW	RGY	BQA	
		14 PINS								
R <sub>θJA</sub>	Junction-to-ambient thermal resistance	124.5	109.5	133.3	59.7	92.2	147.7	59.0	88.3	°C/W
R <sub>θJC(top)</sub>	Junction-to-case (top) thermal resistance	78.8	62.1	55.6	47.3	49.8	77.4	72.5	90.9	
R <sub>θJB</sub>	Junction-to-board thermal resistance	81	56.9	66.3	39.5	51.0	90.9	35.0	56.8	
Ψ <sub>JT</sub>	Junction-to-top characterization parameter	37	22.6	7.8	32.4	15.7	27.2	3.9	9.9	
Ψ <sub>JB</sub>	Junction-to-board characterization parameter	80.6	56.3	56.6	39.4	50.6	90.2	35.1	56.7	
R <sub>θJC(bot)</sub>	Junction-to-case (bottom) thermal resistance	N/A	N/A	N/A	N/A	N/A	N/A	15.4	33.4	

(1) For more information about traditional and new thermal metrics, see the *IC Package Thermal Metrics* application report (SPRA953).

## 6.5 Electrical Characteristics

over recommended operating free-air temperature range (unless otherwise noted)

PARAMETER	TEST CONDITIONS	V <sub>CC</sub>	T <sub>A</sub> = 25°C			SN54AHCT86		-40°C to 85°C SN74AHCT86		-40°C to 125°C SN74AHCT86		UNIT
			MIN	TYP	MAX	MIN	MAX	MIN	MAX	MIN	MAX	
V <sub>OH</sub>	I <sub>OH</sub> = -50 μA	4.5 V	4.4	4.5		4.4		4.4		4.4		V
	I <sub>OH</sub> = -8 mA		3.94			3.8		3.8		3.8		
V <sub>OL</sub>	I <sub>OL</sub> = 50 μA	4.5 V			0.1		0.1		0.1		0.1	V
	I <sub>OL</sub> = 8 mA				0.36		0.44		0.44		0.44	
I <sub>I</sub>	V <sub>I</sub> = 5.5 V or GND	0 V to 5.5 V			±0.1		±1 <sup>(1)</sup>		±1		±1	μA
I <sub>CC</sub>	V <sub>I</sub> = V <sub>CC</sub> or GND, I <sub>O</sub> = 0	5.5 V			2		20		20		20	μA
ΔI <sub>CC</sub> <sup>(2)</sup>	One input at 3.4 V, Other inputs at V <sub>CC</sub> or GND	5.5 V			1.35		1.5		1.5		1.5	mA
C <sub>I</sub>	V <sub>I</sub> = V <sub>CC</sub> or GND	5 V		4	10				10			pF

(1) On products compliant to MIL-PRF-38535, this parameter is not production tested at V<sub>CC</sub> = 0 V.

(2) This is the increase in supply current for each input at one of the specified TTL voltage levels, rather than 0 V or V<sub>CC</sub>.

## 6.6 Switching Characteristics

over recommended operating free-air temperature range, V<sub>CC</sub> = 5 V ± 0.5 V (unless otherwise noted) (see [Figure 7-1](#))

PARAMETER	FROM (INPUT)	TO (OUTPUT)	LOAD CAPACITANCE	T <sub>A</sub> = 25°C			-55°C to 125°C SN54AHCT86		-40°C to 85°C SN74AHCT86		-40°C to 125°C SN74AHCT86		UNIT
				MIN	TYP	MAX	MIN	MAX	MIN	MAX	MIN	MAX	
t <sub>PLH</sub>	A or B	Y	C <sub>L</sub> = 15 pF	5 <sup>(1)</sup>	6.9 <sup>(1)</sup>		1 <sup>(1)</sup>	8 <sup>(1)</sup>	1	8	1	9	ns
t <sub>PHL</sub>				5 <sup>(1)</sup>	6.9 <sup>(1)</sup>		1 <sup>(1)</sup>	8 <sup>(1)</sup>	1	8	1	9	
t <sub>PLH</sub>	A or B	Y	C <sub>L</sub> = 50 pF	5.5	8.8		1	10	1	9	1	11	ns
t <sub>PHL</sub>				5.5	8.8		1	10	1	9	1	11	

(1) On products compliant to MIL-PRF-38535, this parameter is not production tested.

### 6.7 Noise Characteristics

$V_{CC} = 5\text{ V}$ ,  $C_L = 50\text{ pF}$ ,  $T_A = 25^\circ\text{C}$ <sup>(1)</sup>

PARAMETER		SN74AHCT86			UNIT
		MIN	TYP	MAX	
$V_{OL(P)}$	Quiet output, maximum dynamic $V_{OL}$		0.4	0.8	V
$V_{OL(V)}$	Quiet output, minimum dynamic $V_{OL}$		-0.4	-0.8	V
$V_{OH(V)}$	Quiet output, minimum dynamic $V_{OH}$	4.4			V
$V_{IH(D)}$	High-level dynamic input voltage	2			V
$V_{IL(D)}$	Low-level dynamic input voltage			0.8	V

(1) Characteristics are for surface-mount packages only.

### 6.8 Operating Characteristics

$V_{CC} = 5\text{ V}$ ,  $T_A = 25^\circ\text{C}$

PARAMETER	TEST CONDITIONS	TYP	UNIT
$C_{pd}$	No load, $f = 1\text{ MHz}$	18	pF

### 6.9 Typical Characteristics



图 6-1. TPD vs Temperature

## 7 Parameter Measurement Information

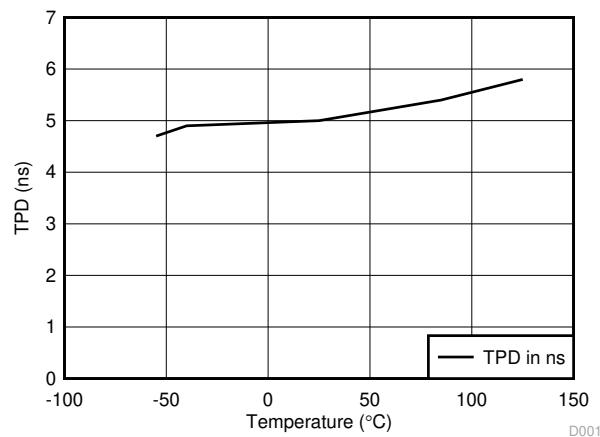
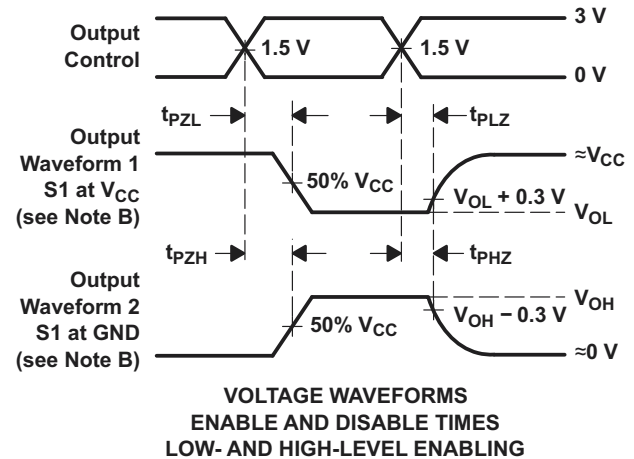
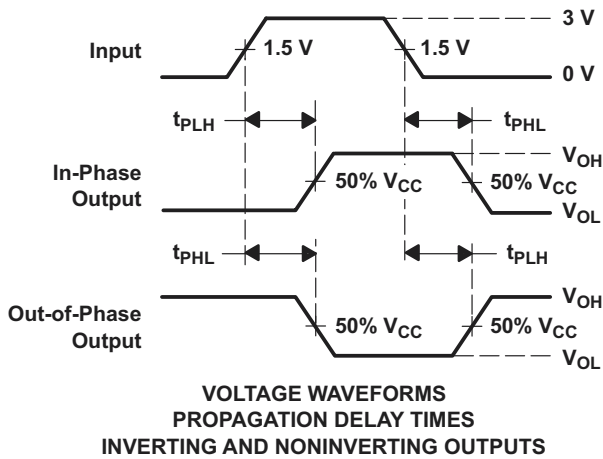
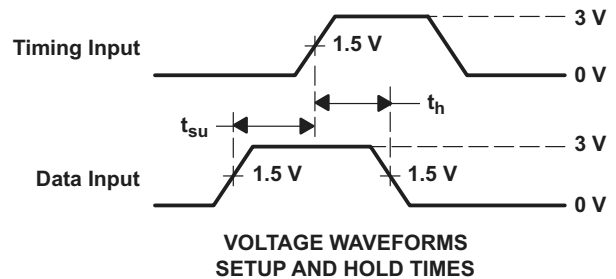
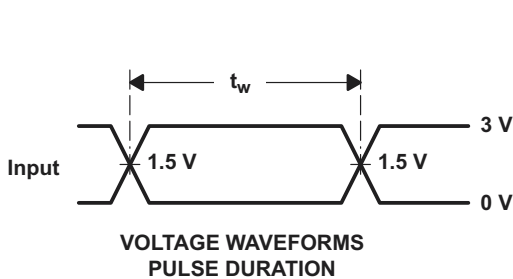
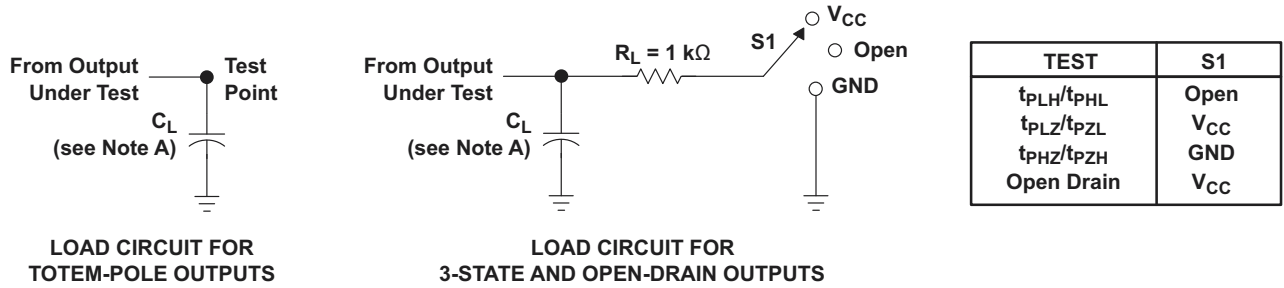

- NOTES: A.  $C_L$  includes probe and jig capacitance.  
 B. Waveform 1 is for an output with internal conditions such that the output is low except when disabled by the output control. Waveform 2 is for an output with internal conditions such that the output is high except when disabled by the output control.  
 C. All input pulses are supplied by generators having the following characteristics:  $PRR \leq 1$  MHz,  $Z_O = 50 \Omega$ ,  $t_r \leq 3$  ns,  $t_f \leq 3$  ns.  
 D. The outputs are measured one at a time with one input transition per measurement.  
 E. All parameters and waveforms are not applicable to all devices.

**图 7-1. Load Circuit and Voltage Waveforms**



## 8 Detailed Description

### 8.1 Overview

The SNx4AHCT86 devices are quadruple 2-input exclusive-OR gates. These devices perform the Boolean function  $Y = A \times B$  or  $Y = \overline{A}B + A\overline{B}$  in positive logic.

The inputs are TTL compatible allowing 3.3 V to 5 V translation.

### 8.2 Functional Block Diagram

An exclusive-OR gate has many applications, some of which can be represented better by alternative logic symbols.

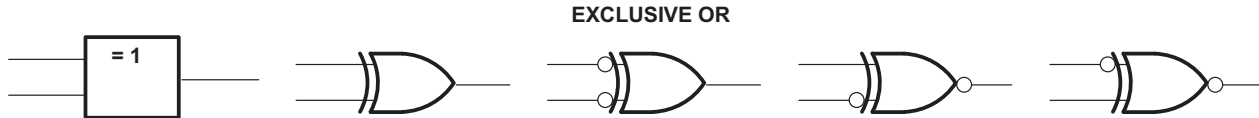

These are five equivalent exclusive-OR symbols valid for an SN74AHCT86 gate in positive logic; negation may be shown at any two ports.

#### LOGIC-IDENTITY ELEMENT

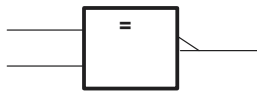

The output is active (low) if all inputs stand at the same logic level (that is,  $A = B$ ).

#### EVEN-PARITY ELEMENT

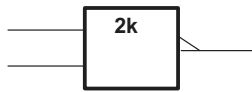

The output is active (low) if an even number of inputs (that is, 0 or 2) are active.

#### ODD-PARITY ELEMENT

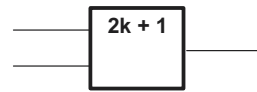

The output is active (high) if an odd number of inputs (that is, only 1 of the 2) are active.

### 8-1. Exclusive-OR Logic

### 8.3 Feature Description

- TTL inputs
  - Lowered switching threshold allows up translation 3.3 V to 5 V
- Slow edges reduce output ringing

### 8.4 Device Functional Modes

表 8-1. Function Table  
(Each Gate)

INPUTS		OUTPUT Y
A	B	
L	L	L
L	H	H
H	L	H
H	H	L

## 9 Application and Implementation

### 注

以下のアプリケーション情報は、TI の製品仕様に含まれるものではなく、TI ではその正確性または完全性を保証いたしません。個々の目的に対する製品の適合性については、お客様の責任で判断していただくことになります。お客様は自身の設計実装を検証しテストすることで、システムの機能を確認する必要があります。

### 9.1 Application Information

The SNx4AHCT86 is a low-drive CMOS device that can be used for a multitude of bus interface type applications where output ringing is a concern. The low drive and slow edge rates will minimize overshoot and undershoot on the outputs. The input switching levels have been lowered to accommodate TTL inputs of 0.8-V  $V_{IL}$  and 2-V  $V_{IH}$ . This feature makes the device ideal for translating up from 3.3 V to 5 V. [図 9-2](#) shows this type of translation.

### 9.2 Typical Application



図 9-1. Typical Application Schematic

#### 9.2.1 Design Requirements

This device uses CMOS technology and has balanced output drive. Care should be taken to avoid bus contention because it can drive currents that would exceed maximum limits. The high drive will also create fast edges into light loads; therefore, routing and load conditions should be considered to prevent ringing.

#### 9.2.2 Detailed Design Procedure

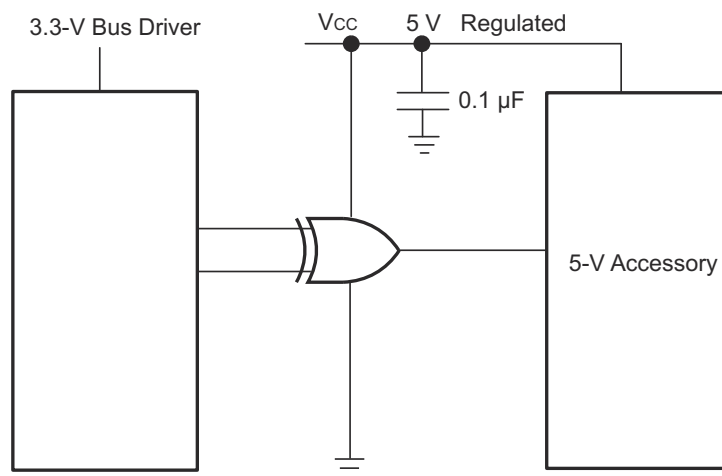
- Recommended input conditions:
  - Rise time and fall time specs: see  $(\Delta t/\Delta V)$  in the [Recommended Operating Conditions](#) table.
  - Specified High and low levels: see  $(V_{IH}$  and  $V_{IL})$  in the [Recommended Operating Conditions](#) table.
  - Inputs are overvoltage tolerant allowing them to go as high as 5.5 V at any valid  $V_{CC}$
- Recommend output conditions:
  - Load currents should not exceed 25 mA per output and 75 mA total for the part
  - Outputs should not be pulled above  $V_{CC}$

### 9.2.3 Application Curves

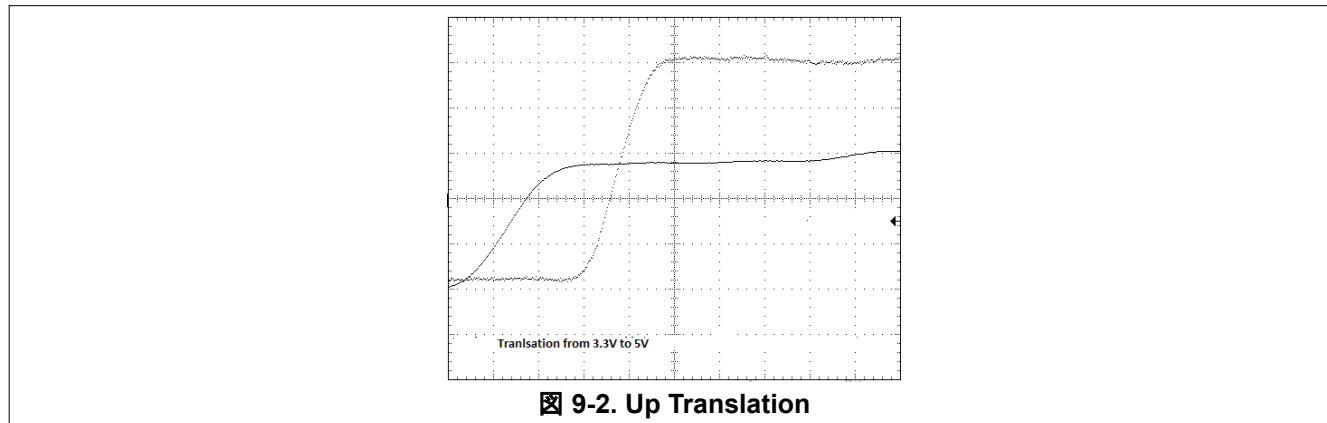

### 9.3 Power Supply Recommendations

The power supply can be any voltage between the MIN and MAX supply voltage rating located in the [Recommended Operating Conditions](#) table.

Each  $V_{CC}$  pin should have a good bypass capacitor to prevent power disturbance. For devices with a single supply, 0.1  $\mu\text{F}$  is recommended. If there are multiple  $V_{CC}$  pins, 0.01  $\mu\text{F}$  or 0.022  $\mu\text{F}$  is recommended for each power pin. It is acceptable to parallel multiple bypass caps to reject different frequencies of noise. A 0.1  $\mu\text{F}$  and 1  $\mu\text{F}$  are commonly used in parallel. The bypass capacitor should be installed as close to the power pin as possible for best results.

### 9.4 Layout

#### 9.4.1 Layout Guidelines

When using multiple bit logic devices inputs should not ever float.

In many cases, functions or parts of functions of digital logic devices are unused, for example, when only two inputs of a triple-input AND gate are used or only 3 of the 4 buffer gates are used. Such input pins should not be left unconnected because the undefined voltages at the outside connections result in undefined operational states. Specified in [Figure 9-3](#) are the rules that must be observed under all circumstances. All unused inputs of digital logic devices must be connected to a high or low bias to prevent them from floating. The logic level that should be applied to any particular unused input depends on the function of the device. Generally they will be tied to GND or  $V_{CC}$ ; whichever makes more sense or is more convenient. It is generally acceptable to float outputs unless the part is a transceiver. If the transceiver has an output enable pin, it will disable the outputs section of the part when asserted. This will not disable the input section of the IOs so they cannot float when disabled.

#### 9.4.2 Layout Example

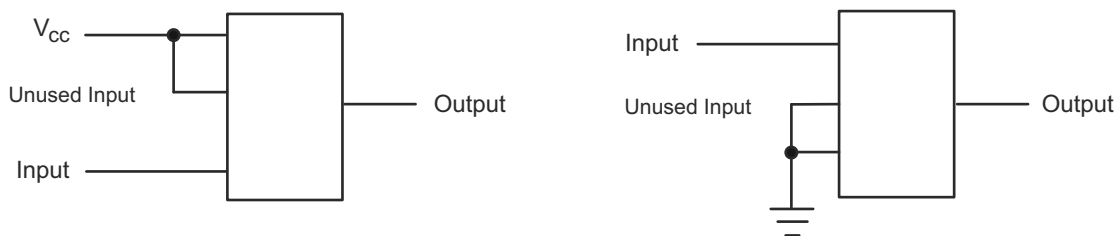

**図 9-3. Layout Diagram**

## 10 Device and Documentation Support

### 10.1 ドキュメントの更新通知を受け取る方法

ドキュメントの更新についての通知を受け取るには、[ti.com](http://ti.com) のデバイス製品フォルダを開いてください。「更新の通知を受け取る」をクリックして登録すると、変更されたすべての製品情報に関するダイジェストを毎週受け取れます。変更の詳細については、修正されたドキュメントに含まれている改訂履歴をご覧ください。

### 10.2 サポート・リソース

TI E2E™ サポート・フォーラムは、エンジニアが検証済みの回答と設計に関するヒントをエキスパートから迅速かつ直接得ることができる場所です。既存の回答を検索したり、独自の質問をしたりすることで、設計に必要な支援を迅速に得ることができます。

リンクされているコンテンツは、該当する貢献者により、現状のまま提供されるものです。これらは TI の仕様を構成するものではなく、必ずしも TI の見解を反映したものではありません。TI の[使用条件](#)を参照してください。

### 10.3 Trademarks

TI E2E™ is a trademark of Texas Instruments.  
すべての商標は、それぞれの所有者に帰属します。

### 10.4 静電気放電に関する注意事項



この IC は、ESD によって破損する可能性があります。テキサス・インスツルメンツは、IC を取り扱う際には常に適切な注意を払うことを推奨します。正しい取り扱いおよび設置手順に従わない場合、デバイスを破損するおそれがあります。

ESD による破損は、わずかな性能低下からデバイスの完全な故障まで多岐にわたります。精密な IC の場合、パラメータがわずかに変化するだけで公表されている仕様から外れる可能性があるため、破損が発生しやすくなっています。

### 10.5 用語集

[テキサス・インスツルメンツ用語集](#) この用語集には、用語や略語の一覧および定義が記載されています。

## 11 Mechanical, Packaging, and Orderable Information

The following pages include mechanical, packaging, and orderable information. This information is the most current data available for the designated devices. This data is subject to change without notice and revision of this document. For browser-based versions of this data sheet, refer to the left-hand navigation.

**PACKAGING INFORMATION**

Orderable Device	Status (1)	Package Type	Package Drawing	Pins	Package Qty	Eco Plan (2)	Lead finish/ Ball material (6)	MSL Peak Temp (3)	Op Temp (°C)	Device Marking (4/5)	Samples
5962-9681701Q2A	ACTIVE	LCCC	FK	20	55	Non-RoHS & Green	SNPB	N / A for Pkg Type	-55 to 125	5962-9681701Q2A SNJ54AHCT 86FK	<a href="#">Samples</a>
5962-9681701QCA	ACTIVE	CDIP	J	14	25	Non-RoHS & Green	SNPB	N / A for Pkg Type	-55 to 125	5962-9681701QC A SNJ54AHCT86J	<a href="#">Samples</a>
SN74AHCT86BQAR	ACTIVE	WQFN	BQA	14	3000	RoHS & Green	NIPDAU	Level-1-260C-UNLIM	-40 to 125	AHCT86	<a href="#">Samples</a>
SN74AHCT86D	OBSOLETE	SOIC	D	14		TBD	Call TI	Call TI	-40 to 85	AHCT86	
SN74AHCT86DBR	ACTIVE	SSOP	DB	14	2000	RoHS & Green	NIPDAU	Level-1-260C-UNLIM	-40 to 125	HB86	<a href="#">Samples</a>
SN74AHCT86DGVR	ACTIVE	TVSOP	DGV	14	2000	RoHS & Green	NIPDAU	Level-1-260C-UNLIM	-40 to 125	HB86	<a href="#">Samples</a>
SN74AHCT86DR	ACTIVE	SOIC	D	14	2500	RoHS & Green	NIPDAU	Level-1-260C-UNLIM	-40 to 125	AHCT86	<a href="#">Samples</a>
SN74AHCT86N	ACTIVE	PDIP	N	14	25	RoHS & Green	NIPDAU	N / A for Pkg Type	-40 to 125	SN74AHCT86N	<a href="#">Samples</a>
SN74AHCT86NSR	ACTIVE	SOP	NS	14	2000	RoHS & Green	NIPDAU	Level-1-260C-UNLIM	-40 to 125	AHCT86	<a href="#">Samples</a>
SN74AHCT86PW	OBSOLETE	TSSOP	PW	14		TBD	Call TI	Call TI	-40 to 125	HB86	
SN74AHCT86PWR	ACTIVE	TSSOP	PW	14	2000	RoHS & Green	NIPDAU   SN	Level-1-260C-UNLIM	-40 to 125	HB86	<a href="#">Samples</a>
SN74AHCT86RGYR	ACTIVE	VQFN	RGY	14	3000	RoHS & Green	NIPDAU	Level-2-260C-1 YEAR	-40 to 125	HB86	<a href="#">Samples</a>
SN74AHCT86RGYRG4	ACTIVE	VQFN	RGY	14	3000	RoHS & Green	NIPDAU	Level-2-260C-1 YEAR	-40 to 125	HB86	<a href="#">Samples</a>
SNJ54AHCT86FK	ACTIVE	LCCC	FK	20	55	Non-RoHS & Green	SNPB	N / A for Pkg Type	-55 to 125	5962-9681701Q2A SNJ54AHCT 86FK	<a href="#">Samples</a>
SNJ54AHCT86J	ACTIVE	CDIP	J	14	25	Non-RoHS & Green	SNPB	N / A for Pkg Type	-55 to 125	5962-9681701QC A SNJ54AHCT86J	<a href="#">Samples</a>

(1) The marketing status values are defined as follows:

**ACTIVE:** Product device recommended for new designs.

**LIFEBUY:** TI has announced that the device will be discontinued, and a lifetime-buy period is in effect.

**NRND:** Not recommended for new designs. Device is in production to support existing customers, but TI does not recommend using this part in a new design.

**PREVIEW:** Device has been announced but is not in production. Samples may or may not be available.

**OBSOLETE:** TI has discontinued the production of the device.

<sup>(2)</sup> **RoHS:** TI defines "RoHS" to mean semiconductor products that are compliant with the current EU RoHS requirements for all 10 RoHS substances, including the requirement that RoHS substance do not exceed 0.1% by weight in homogeneous materials. Where designed to be soldered at high temperatures, "RoHS" products are suitable for use in specified lead-free processes. TI may reference these types of products as "Pb-Free".

**RoHS Exempt:** TI defines "RoHS Exempt" to mean products that contain lead but are compliant with EU RoHS pursuant to a specific EU RoHS exemption.

**Green:** TI defines "Green" to mean the content of Chlorine (Cl) and Bromine (Br) based flame retardants meet JS709B low halogen requirements of  $\leq 1000$ ppm threshold. Antimony trioxide based flame retardants must also meet the  $\leq 1000$ ppm threshold requirement.

<sup>(3)</sup> **MSL, Peak Temp.** - The Moisture Sensitivity Level rating according to the JEDEC industry standard classifications, and peak solder temperature.

<sup>(4)</sup> There may be additional marking, which relates to the logo, the lot trace code information, or the environmental category on the device.

<sup>(5)</sup> Multiple Device Markings will be inside parentheses. Only one Device Marking contained in parentheses and separated by a "~" will appear on a device. If a line is indented then it is a continuation of the previous line and the two combined represent the entire Device Marking for that device.

<sup>(6)</sup> **Lead finish/Ball material** - Orderable Devices may have multiple material finish options. Finish options are separated by a vertical ruled line. Lead finish/Ball material values may wrap to two lines if the finish value exceeds the maximum column width.

**Important Information and Disclaimer:** The information provided on this page represents TI's knowledge and belief as of the date that it is provided. TI bases its knowledge and belief on information provided by third parties, and makes no representation or warranty as to the accuracy of such information. Efforts are underway to better integrate information from third parties. TI has taken and continues to take reasonable steps to provide representative and accurate information but may not have conducted destructive testing or chemical analysis on incoming materials and chemicals. TI and TI suppliers consider certain information to be proprietary, and thus CAS numbers and other limited information may not be available for release.

In no event shall TI's liability arising out of such information exceed the total purchase price of the TI part(s) at issue in this document sold by TI to Customer on an annual basis.

**OTHER QUALIFIED VERSIONS OF SN54AHCT86, SN74AHCT86 :**

● Catalog : [SN74AHCT86](#)

● Military : [SN54AHCT86](#)

NOTE: Qualified Version Definitions:

● Catalog - TI's standard catalog product

- Military - QML certified for Military and Defense Applications

**TAPE AND REEL INFORMATION**

**QUADRANT ASSIGNMENTS FOR PIN 1 ORIENTATION IN TAPE**

\*All dimensions are nominal

Device	Package Type	Package Drawing	Pins	SPQ	Reel Diameter (mm)	Reel Width W1 (mm)	A0 (mm)	B0 (mm)	K0 (mm)	P1 (mm)	W (mm)	Pin1 Quadrant
SN74AHCT86BQAR	WQFN	BQA	14	3000	180.0	12.4	2.8	3.3	1.1	4.0	12.0	Q1
SN74AHCT86DBR	SSOP	DB	14	2000	330.0	16.4	8.35	6.6	2.4	12.0	16.0	Q1
SN74AHCT86DGVR	TVSOP	DGV	14	2000	330.0	12.4	6.8	4.0	1.6	8.0	12.0	Q1
SN74AHCT86DR	SOIC	D	14	2500	330.0	16.4	6.5	9.0	2.1	8.0	16.0	Q1
SN74AHCT86DR	SOIC	D	14	2500	330.0	16.4	6.5	9.0	2.1	8.0	16.0	Q1
SN74AHCT86NSR	SOP	NS	14	2000	330.0	16.4	8.2	10.5	2.5	12.0	16.0	Q1
SN74AHCT86PWR	TSSOP	PW	14	2000	330.0	12.4	6.9	5.6	1.6	8.0	12.0	Q1
SN74AHCT86PWR	TSSOP	PW	14	2000	330.0	12.4	6.9	5.6	1.6	8.0	12.0	Q1
SN74AHCT86RGYR	VQFN	RGY	14	3000	330.0	12.4	3.75	3.75	1.15	8.0	12.0	Q1



**TAPE AND REEL BOX DIMENSIONS**

\*All dimensions are nominal

Device	Package Type	Package Drawing	Pins	SPQ	Length (mm)	Width (mm)	Height (mm)
SN74AHCT86BQAR	WQFN	BQA	14	3000	210.0	185.0	35.0
SN74AHCT86DBR	SSOP	DB	14	2000	356.0	356.0	35.0
SN74AHCT86DGVR	TVSOP	DGV	14	2000	356.0	356.0	35.0
SN74AHCT86DR	SOIC	D	14	2500	356.0	356.0	35.0
SN74AHCT86DR	SOIC	D	14	2500	353.0	353.0	32.0
SN74AHCT86NSR	SOP	NS	14	2000	356.0	356.0	35.0
SN74AHCT86PWR	TSSOP	PW	14	2000	356.0	356.0	35.0
SN74AHCT86PWR	TSSOP	PW	14	2000	353.0	353.0	32.0
SN74AHCT86RGYR	VQFN	RGY	14	3000	356.0	356.0	35.0

**TUBE**

\*All dimensions are nominal

Device	Package Name	Package Type	Pins	SPQ	L (mm)	W (mm)	T (μm)	B (mm)
5962-9681701Q2A	FK	LCCC	20	55	506.98	12.06	2030	NA
SN74AHCT86N	N	PDIP	14	25	506	13.97	11230	4.32
SN74AHCT86N	N	PDIP	14	25	506	13.97	11230	4.32
SNJ54AHCT86FK	FK	LCCC	20	55	506.98	12.06	2030	NA

# DB0014A



# PACKAGE OUTLINE

## SSOP - 2 mm max height

SMALL OUTLINE PACKAGE



### NOTES:

1. All linear dimensions are in millimeters. Any dimensions in parenthesis are for reference only. Dimensioning and tolerancing per ASME Y14.5M.
2. This drawing is subject to change without notice.
3. This dimension does not include mold flash, protrusions, or gate burrs. Mold flash, protrusions, or gate burrs shall not exceed 0.15 mm per side.
4. Reference JEDEC registration MO-150.

# EXAMPLE BOARD LAYOUT

DB0014A

SSOP - 2 mm max height

SMALL OUTLINE PACKAGE



LAND PATTERN EXAMPLE  
EXPOSED METAL SHOWN  
SCALE: 10X



4220762/A 05/2024

NOTES: (continued)

5. Publication IPC-7351 may have alternate designs.
6. Solder mask tolerances between and around signal pads can vary based on board fabrication site.

# EXAMPLE STENCIL DESIGN

DB0014A

SSOP - 2 mm max height

SMALL OUTLINE PACKAGE



SOLDER PASTE EXAMPLE  
BASED ON 0.125 mm THICK STENCIL  
SCALE: 10X

4220762/A 05/2024

NOTES: (continued)

7. Laser cutting apertures with trapezoidal walls and rounded corners may offer better paste release. IPC-7525 may have alternate design recommendations.
8. Board assembly site may have different recommendations for stencil design.

## GENERIC PACKAGE VIEW

**FK 20**

**LCCC - 2.03 mm max height**

8.89 x 8.89, 1.27 mm pitch

LEADLESS CERAMIC CHIP CARRIER

This image is a representation of the package family, actual package may vary.  
Refer to the product data sheet for package details.



4229370VA\

J 14

**GENERIC PACKAGE VIEW**  
**CDIP - 5.08 mm max height**  
CERAMIC DUAL IN LINE PACKAGE



Images above are just a representation of the package family, actual package may vary.  
Refer to the product data sheet for package details.

4040083-5/G

# J0014A



## PACKAGE OUTLINE

CDIP - 5.08 mm max height

CERAMIC DUAL IN LINE PACKAGE



4214771/A 05/2017

### NOTES:

1. All controlling linear dimensions are in inches. Dimensions in brackets are in millimeters. Any dimension in brackets or parenthesis are for reference only. Dimensioning and tolerancing per ASME Y14.5M.
2. This drawing is subject to change without notice.
3. This package is hermetically sealed with a ceramic lid using glass frit.
4. Index point is provided on cap for terminal identification only and on press ceramic glass frit seal only.
5. Falls within MIL-STD-1835 and GDIP1-T14.



# EXAMPLE BOARD LAYOUT

J0014A

CDIP - 5.08 mm max height

CERAMIC DUAL IN LINE PACKAGE



LAND PATTERN EXAMPLE  
NON-SOLDER MASK DEFINED  
SCALE: 5X



4214771/A 05/2017

N (R-PDIP-T\*\*)

PLASTIC DUAL-IN-LINE PACKAGE

16 PINS SHOWN



- NOTES:
- A. All linear dimensions are in inches (millimeters).
  - B. This drawing is subject to change without notice.
  - C Falls within JEDEC MS-001, except 18 and 20 pin minimum body length (Dim A).
  - D The 20 pin end lead shoulder width is a vendor option, either half or full width.

4040049/E 12/2002

PW0014A



**PACKAGE OUTLINE**  
**TSSOP - 1.2 mm max height**

SMALL OUTLINE PACKAGE

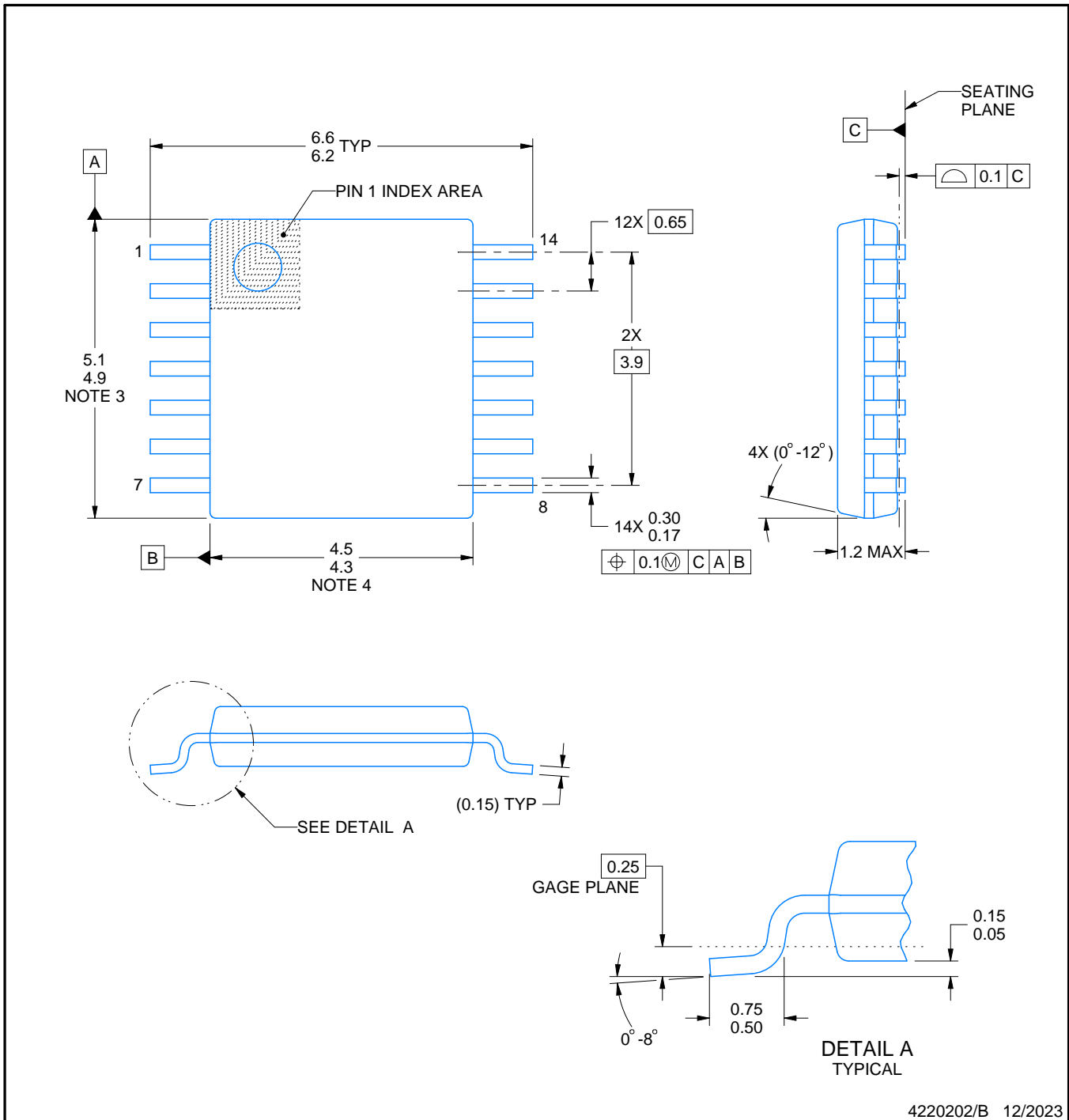

NOTES:

1. All linear dimensions are in millimeters. Any dimensions in parenthesis are for reference only. Dimensioning and tolerancing per ASME Y14.5M.
2. This drawing is subject to change without notice.
3. This dimension does not include mold flash, protrusions, or gate burrs. Mold flash, protrusions, or gate burrs shall not exceed 0.15 mm per side.
4. This dimension does not include interlead flash. Interlead flash shall not exceed 0.25 mm per side.
5. Reference JEDEC registration MO-153.

# EXAMPLE BOARD LAYOUT

PW0014A

TSSOP - 1.2 mm max height

SMALL OUTLINE PACKAGE



LAND PATTERN EXAMPLE  
EXPOSED METAL SHOWN  
SCALE: 10X

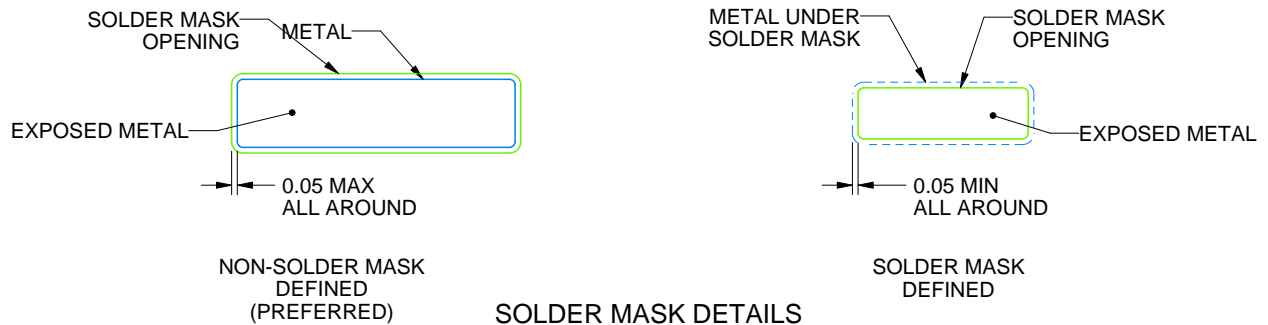

4220202/B 12/2023

NOTES: (continued)

6. Publication IPC-7351 may have alternate designs.
7. Solder mask tolerances between and around signal pads can vary based on board fabrication site.

# EXAMPLE STENCIL DESIGN

PW0014A

TSSOP - 1.2 mm max height

SMALL OUTLINE PACKAGE



SOLDER PASTE EXAMPLE  
BASED ON 0.125 mm THICK STENCIL  
SCALE: 10X

4220202/B 12/2023

NOTES: (continued)

8. Laser cutting apertures with trapezoidal walls and rounded corners may offer better paste release. IPC-7525 may have alternate design recommendations.
9. Board assembly site may have different recommendations for stencil design.

D0014A



# PACKAGE OUTLINE

## SOIC - 1.75 mm max height

SMALL OUTLINE INTEGRATED CIRCUIT



4220718/A 09/2016

# EXAMPLE BOARD LAYOUT

D0014A

SOIC - 1.75 mm max height

SMALL OUTLINE INTEGRATED CIRCUIT



LAND PATTERN EXAMPLE  
SCALE:8X



SOLDER MASK DETAILS

4220718/A 09/2016

NOTES: (continued)

- 6. Publication IPC-7351 may have alternate designs.
- 7. Solder mask tolerances between and around signal pads can vary based on board fabrication site.

# EXAMPLE STENCIL DESIGN

D0014A

SOIC - 1.75 mm max height

SMALL OUTLINE INTEGRATED CIRCUIT



SOLDER PASTE EXAMPLE  
BASED ON 0.125 mm THICK STENCIL  
SCALE:8X

4220718/A 09/2016

NOTES: (continued)

8. Laser cutting apertures with trapezoidal walls and rounded corners may offer better paste release. IPC-7525 may have alternate design recommendations.
9. Board assembly site may have different recommendations for stencil design.



## GENERIC PACKAGE VIEW

**BQA 14**

**WQFN - 0.8 mm max height**

2.5 x 3, 0.5 mm pitch

PLASTIC QUAD FLATPACK - NO LEAD

This image is a representation of the package family, actual package may vary.  
Refer to the product data sheet for package details.





# EXAMPLE BOARD LAYOUT

WQFN - 0.8 mm max height

BQA0014A

PLASTIC QUAD FLAT PACK-NO LEAD



LAND PATTERN EXAMPLE  
EXPOSED METAL SHOWN  
SCALE: 20X

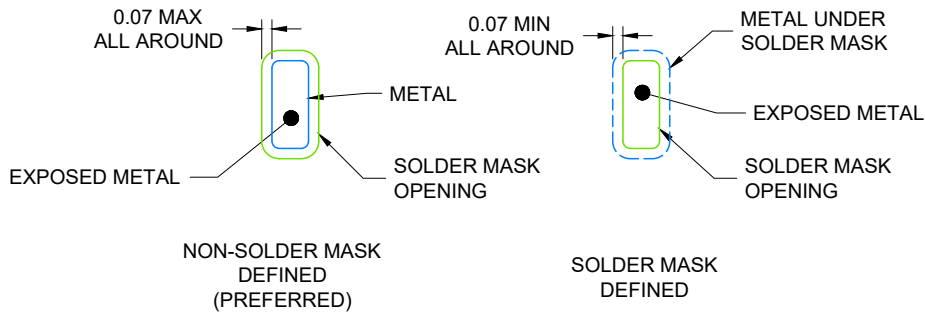

4224636/A 11/2018

NOTES: (continued)

4. This package is designed to be soldered to a thermal pad on the board. For more information, see Texas Instruments literature number SLUA271 ([www.ti.com/lit/slua271](http://www.ti.com/lit/slua271)).
5. Vias are optional depending on application, refer to device data sheet. If any vias are implemented, refer to their locations shown on this view. It is recommended that vias under paste be filled, plugged or tented.

# EXAMPLE STENCIL DESIGN

BQA0014A

WQFN - 0.8 mm max height

PLASTIC QUAD FLAT PACK-NO LEAD

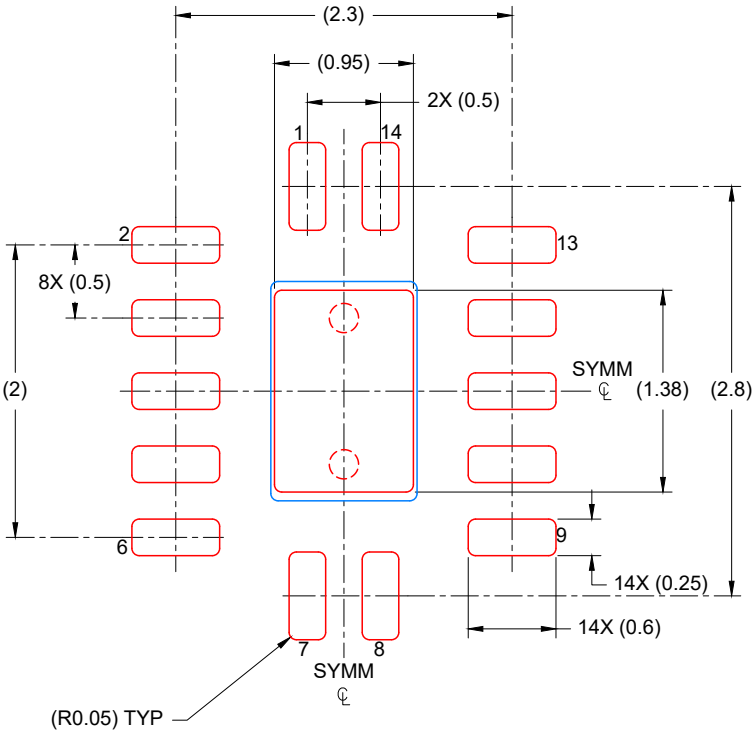

SOLDER PASTE EXAMPLE  
 BASED ON 0.125 mm THICK STENCIL

EXPOSED PAD  
 88% PRINTED COVERAGE BY AREA  
 SCALE: 20X

4224636/A 11/2018

NOTES: (continued)

- 6. Laser cutting apertures with trapezoidal walls and rounded corners may offer better paste release. IPC-7525 may have alternate design recommendations.

## MECHANICAL DATA

**NS (R-PDSO-G\*\*)**

**PLASTIC SMALL-OUTLINE PACKAGE**

**14-PINS SHOWN**



- NOTES:
- A. All linear dimensions are in millimeters.
  - B. This drawing is subject to change without notice.
  - C. Body dimensions do not include mold flash or protrusion, not to exceed 0,15.

## GENERIC PACKAGE VIEW

**RGY 14**

**VQFN - 1 mm max height**

3.5 x 3.5, 0.5 mm pitch

PLASTIC QUAD FLATPACK - NO LEAD

This image is a representation of the package family, actual package may vary.  
Refer to the product data sheet for package details.

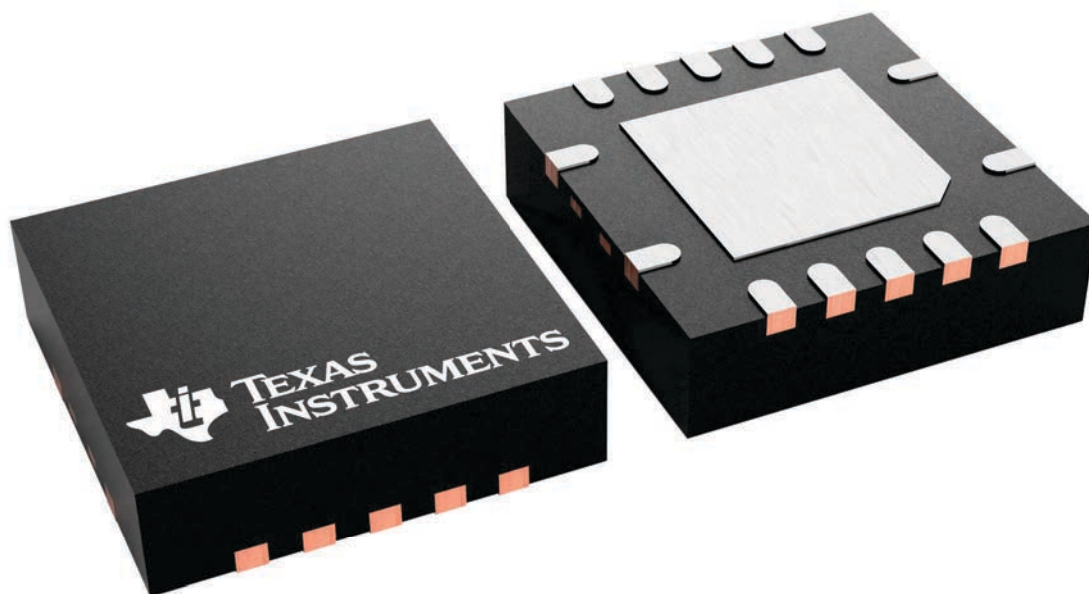

4231541/A

RGY0014A

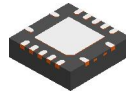

PACKAGE OUTLINE

VQFN - 1 mm max height

PLASTIC QUAD FLATPACK - NO LEAD

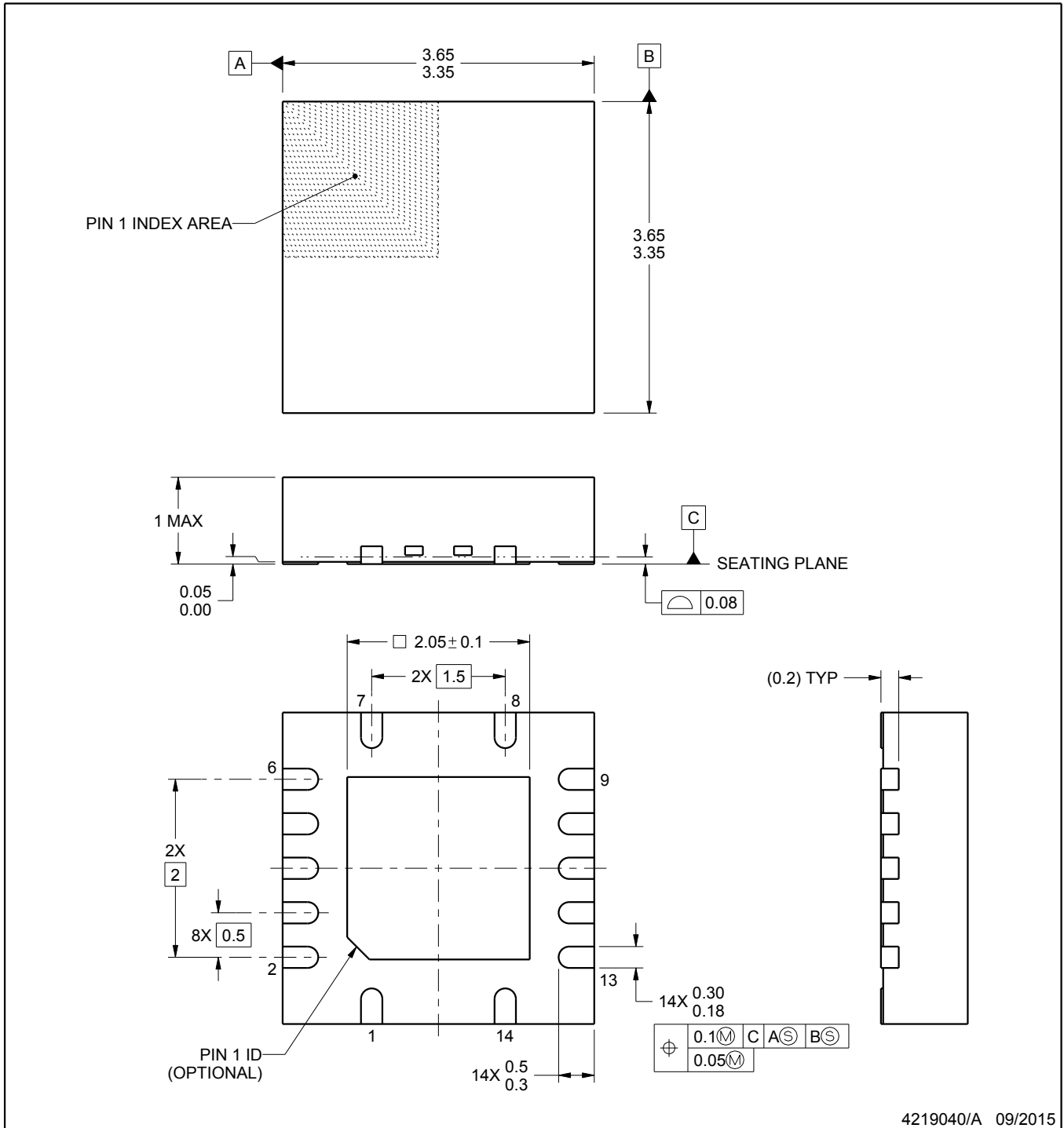

NOTES:

1. All linear dimensions are in millimeters. Any dimensions in parenthesis are for reference only. Dimensioning and tolerancing per ASME Y14.5M.
2. This drawing is subject to change without notice.
3. The package thermal pad must be soldered to the printed circuit board for thermal and mechanical performance.

# EXAMPLE BOARD LAYOUT

RGY0014A

VQFN - 1 mm max height

PLASTIC QUAD FLATPACK - NO LEAD

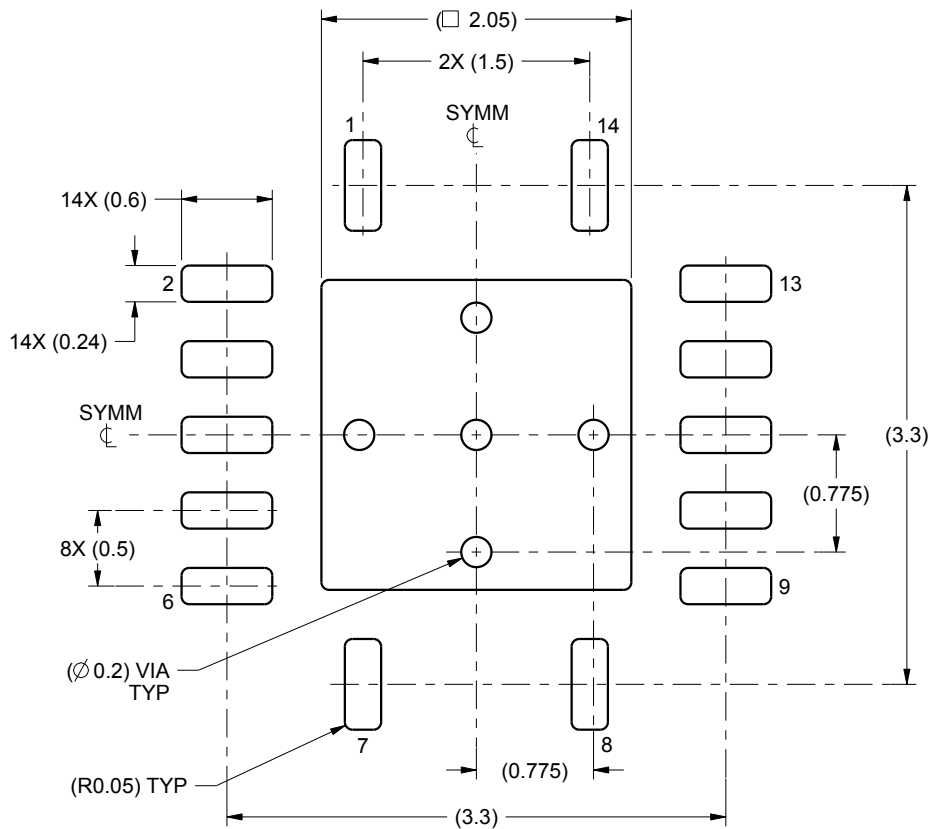

LAND PATTERN EXAMPLE  
SCALE:20X

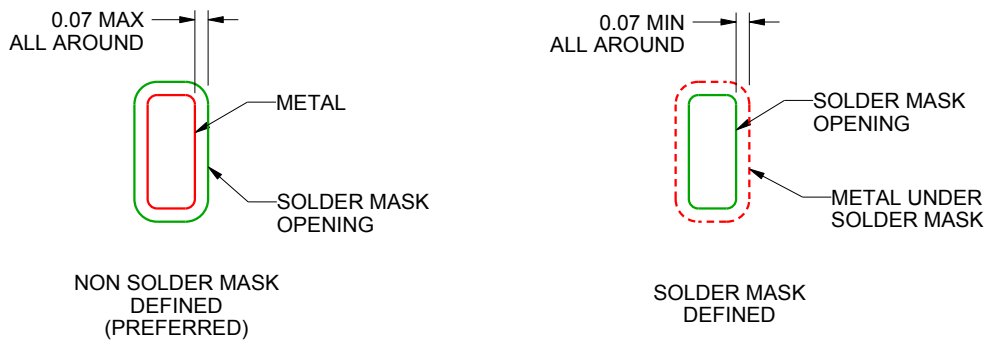

SOLDER MASK DETAILS

4219040/A 09/2015

NOTES: (continued)

4. This package is designed to be soldered to a thermal pad on the board. For more information, see Texas Instruments literature number SLUA271 ([www.ti.com/lit/slua271](http://www.ti.com/lit/slua271)).



# EXAMPLE STENCIL DESIGN

RGY0014A

VQFN - 1 mm max height

PLASTIC QUAD FLATPACK - NO LEAD

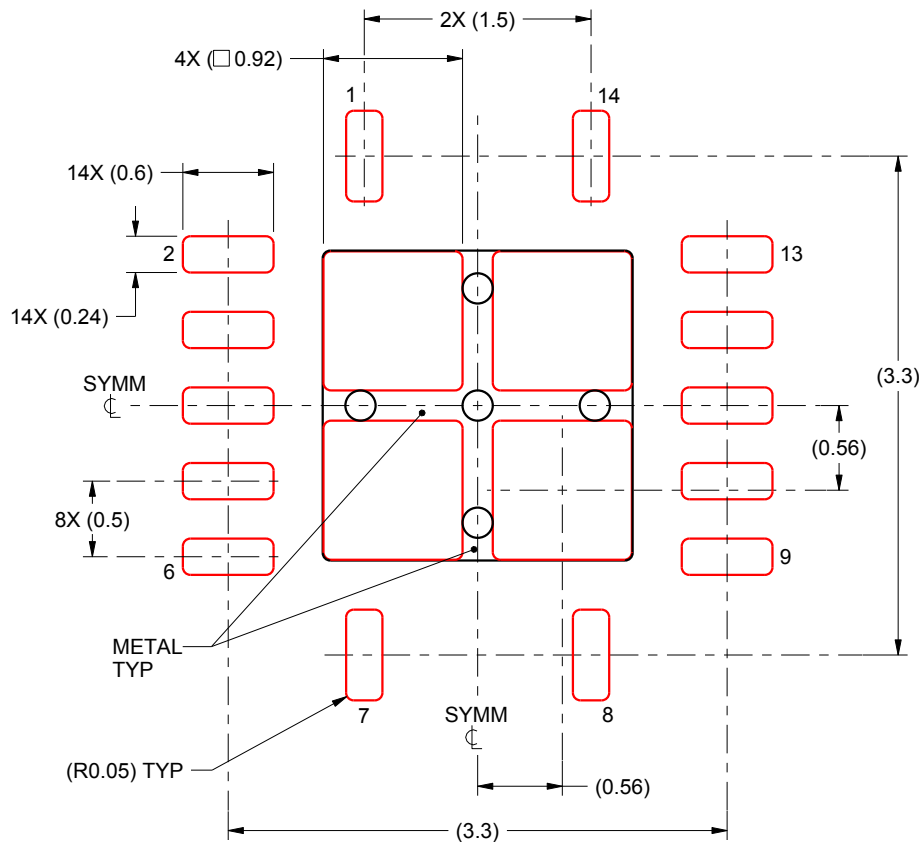

**SOLDER PASTE EXAMPLE**  
BASED ON 0.125 mm THICK STENCIL

EXPOSED PAD  
80% PRINTED SOLDER COVERAGE BY AREA  
SCALE:20X

4219040/A 09/2015

NOTES: (continued)

5. Laser cutting apertures with trapezoidal walls and rounded corners may offer better paste release. IPC-7525 may have alternate design recommendations.

## 重要なお知らせと免責事項

テキサス・インスツルメンツは、技術データと信頼性データ(データシートを含みます)、設計リソース(リファレンス デザインを含みます)、アプリケーションや設計に関する各種アドバイス、Web ツール、安全性情報、その他のリソースを、欠陥が存在する可能性のある「現状のまま」提供しており、商品性および特定目的に対する適合性の黙示保証、第三者の知的財産権の非侵害保証を含むいかなる保証も、明示的または黙示的にかかわらず拒否します。

これらのリソースは、テキサス・インスツルメンツ製品を使用する設計の経験を積んだ開発者への提供を意図したものです。(1) お客様のアプリケーションに適したテキサス・インスツルメンツ製品の選定、(2) お客様のアプリケーションの設計、検証、試験、(3) お客様のアプリケーションに該当する各種規格や、その他のあらゆる安全性、セキュリティ、規制、または他の要件への確実な適合に関する責任を、お客様のみが単独で負うものとし、ます。

上記の各種リソースは、予告なく変更される可能性があります。これらのリソースは、リソースで説明されているテキサス・インスツルメンツ製品を使用するアプリケーションの開発の目的でのみ、テキサス・インスツルメンツはその使用をお客様に許諾します。これらのリソースに関して、他の目的で複製することや掲載することは禁止されています。テキサス・インスツルメンツや第三者の知的財産権のライセンスが付与されている訳ではありません。お客様は、これらのリソースを自身で使用した結果発生するあらゆる申し立て、損害、費用、損失、責任について、テキサス・インスツルメンツおよびその代理人を完全に補償するものとし、テキサス・インスツルメンツは一切の責任を拒否します。

テキサス・インスツルメンツの製品は、[テキサス・インスツルメンツの販売条件](#)、または [ti.com](https://www.ti.com) やかかるテキサス・インスツルメンツ製品の関連資料などのいずれかを通じて提供する適用可能な条項の下で提供されています。テキサス・インスツルメンツがこれらのリソースを提供することは、適用されるテキサス・インスツルメンツの保証または他の保証の放棄の拡大や変更を意味するものではありません。

お客様がいかなる追加条項または代替条項を提案した場合でも、テキサス・インスツルメンツはそれらに異議を唱え、拒否します。

郵送先住所：Texas Instruments, Post Office Box 655303, Dallas, Texas 75265  
Copyright © 2025, Texas Instruments Incorporated