

TLV758P 小型パッケージの 500mA、高精度、可変 LDO

1 特長

- 入力電圧範囲: 1.5V~6.0V
- 可変出力電圧:
 - 0.55V~5.5V
- 低ドロップアウト:
 - 500mA で 130mV (最大値) (3.3V_{OUT})
- 高い出力精度: 0.7% (標準値) および 1% (全温度範囲で最大値)
- I_Q: 25μA (標準値)
- V_{OUT} が単調増加するソフトスタートを内蔵
- パッケージ:
 - 2mm × 2mm WSON-6 (DRV)
 - SOT23-5 (DBV)
- アクティブ出力放電

2 アプリケーション

- ゲーム機
- ホーム・シアターおよびエンターテインメント
- PC とノート PC
- ネットワーク接続の周辺機器とプリンタ
- ラックとサーバー向けの電源
- サーモスタット
- 小売オートメーションおよび小売決済

3 概要

TLV758P は可変 500mA 低ドロップアウト (LDO) レギュレータです。このデバイスは、小型の 6 ピン、2mm × 2mm の WSON パッケージおよび 5 ピンの SOT23 パッケージで供給され、静止電流が非常に小さく、ラインおよび負荷の過渡性能が高速化しています。TLV758P はドロップアウトが 500mA で 130mV と非常に低く、システムの電力効率向上に役立ちます。

TLV758P は 1.5V~6.0V の入力電圧範囲および 0.55V~5.5V の外部可変出力範囲に対応することで、幅広いアプリケーション向けに最適化されています。出力電圧が低いいため、この LDO はコア電圧が低い現代のマイクロコントローラに電源を供給できます。

TLV758P は小型のセラミック出力コンデンサで安定している、ソリューション全体のサイズを小型化できます。高精度のバンドギャップおよびエラー・アンプにより、25°C で 0.7% (最大値) および全温度範囲 (85°C) で 1% (最大値) の高精度を実現しています。このデバイスにはサーマル・シャットダウン、電流制限、低電圧誤動作防止 (UVLO) 機能が内蔵されています。TLV758P には内部フォールドバック電流制限があり、短絡発生時の熱発散を低減するのに役立ちます。

パッケージ情報

部品番号	パッケージ (1)	パッケージ・サイズ (2)
TLV758P	DRV (WSON, 6)	2mm × 2mm
	DBV (SOT-23, 5)	2.9mm × 2.8mm

- (1) 利用可能なパッケージについては、このデータシートの末尾にある注文情報を参照してください。
- (2) パッケージ・サイズ (長さ × 幅) は公称値であり、該当する場合はピンも含まれます。

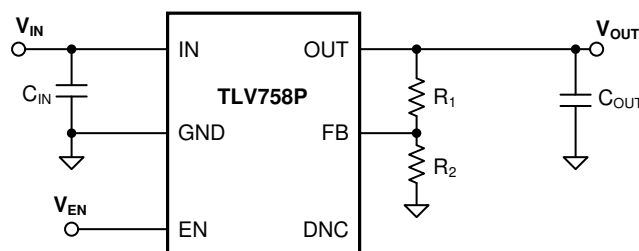

代表的なアプリケーション



Table of Contents

1 特長	1	7 Application and Implementation	16
2 アプリケーション	1	7.1 Application Information.....	16
3 概要	1	7.2 Typical Application.....	21
4 Pin Configuration and Functions	3	7.3 Power Supply Recommendations.....	22
5 Specifications	4	7.4 Layout.....	22
5.1 Absolute Maximum Ratings.....	4	8 Device and Documentation Support	24
5.2 ESD Ratings.....	4	8.1 Documentation Support.....	24
5.3 Recommended Operating Conditions.....	5	8.2 ドキュメントの更新通知を受け取る方法.....	24
5.4 Thermal Information.....	5	8.3 サポート・リソース.....	24
5.5 Electrical Characteristics.....	6	8.4 Trademarks.....	24
5.6 Typical Characteristics.....	7	8.5 静電気放電に関する注意事項.....	24
6 Detailed Description	13	8.6 用語集.....	24
6.1 Overview.....	13	9 Revision History	25
6.2 Functional Block Diagram.....	13	10 Mechanical, Packaging, and Orderable Information	25
6.3 Feature Description.....	13		
6.4 Device Functional Modes.....	15		

4 Pin Configuration and Functions



図 4-1. DRV Package, 6-Pin Adjustable WSON (Top View) 図 4-2. DBV Package, 5-Pin Adjustable SOT-23 (Top View)

表 4-1. Pin Functions

PIN		I/O	DESCRIPTION
NAME	NO.		
DNC	5	—	Do not connect
EN	4	Input	Enable pin. Drive EN greater than $V_{EN(HI)}$ to turn on the regulator. Drive EN less than $V_{EN(LO)}$ to put the LDO into shutdown mode.
FB	2	—	This pin is used as an input to the control loop error amplifier and is used to set the output voltage of the LDO.
GND	3	—	Ground pin
IN	6	Input	Input pin. For best transient response and to minimize input impedance, use the recommended value or larger ceramic capacitor from IN to ground as listed in the <i>Recommended Operating Conditions</i> table and the <i>Input and Output Capacitor Selection</i> section. Place the input capacitor as close to the output of the device as possible.
OUT	1	Output	Regulated output voltage pin. A capacitor is required from OUT to ground for stability. For best transient response, use the nominal recommended value or larger ceramic capacitor from OUT to ground; see the <i>Recommended Operating Conditions</i> table and the <i>Input and Output Capacitor Selection</i> section. Place the output capacitor as close to output of the device as possible.
Thermal pad	Pad	—	Connect the thermal pad to a large area GND plane for improved thermal performance.

5 Specifications

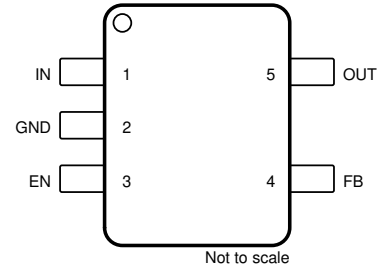
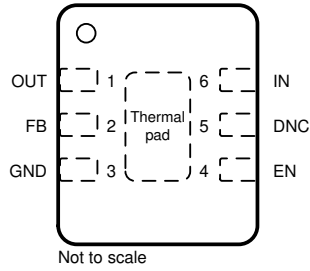
5.1 Absolute Maximum Ratings

over operating free-air temperature range (unless otherwise noted)⁽¹⁾

		MIN	MAX	UNIT
Voltage	Supply, V_{IN}	-0.3	6.5	V
	Enable, V_{EN}	-0.3	6.5	
	Feedback, V_{FB}	-0.3	2	
	Output, V_{OUT}	-0.3	$V_{IN} + 0.3$ ⁽²⁾	
Temperature	Operating junction, T_J	-40	150	°C
	Storage, T_{stg}	-65	150	

- (1) Stresses beyond those listed under *Absolute Maximum Ratings* may cause permanent damage to the device. These are stress ratings only, which do not imply functional operation of the device at these or any other conditions beyond those indicated under *Recommended Operating Conditions*. Exposure to absolute-maximum-rated conditions for extended periods may affect device reliability.
- (2) The absolute maximum rating is $V_{IN} + 0.3V$ or 6.5 V, whichever is smaller.

5.2 ESD Ratings

			VALUE	UNIT
$V_{(ESD)}$	Electrostatic discharge	Human-body model (HBM), per ANSI/ESDA/JEDEC JS-001 ⁽¹⁾	±2000	V
		Charged-device model (CDM), per JEDEC specification JESD22-C101 ⁽²⁾	±500	

- (1) JEDEC document JEP155 states that 500-V HBM allows safe manufacturing with a standard ESD control process. Manufacturing with less than 500-V HBM is possible with the necessary precautions.
- (2) JEDEC document JEP157 states that 250-V CDM allows safe manufacturing with a standard ESD control process. Manufacturing with less than 250-V CDM is possible with the necessary precautions.

5.3 Recommended Operating Conditions

over operating free-air temperature range (unless otherwise noted)

		MIN	NOM	MAX	UNIT
V _{IN}	Input voltage	1.5		6.0	V
V _{OUT}	Output voltage	0.55		5.5	V
I _{OUT}	Output current	0		500	mA
C _{IN}	Input capacitor	1			μF
C _{OUT}	Output capacitor ⁽¹⁾	1		220	μF
V _{EN}	Enable voltage ⁽²⁾	0		6.0	V
f _{EN}	Enable toggle frequency			10	kHz
T _J	Junction temperature	-40		125	°C

- (1) Minimum derated capacitance of 0.47 μF is required for stability.
 (2) If V_{EN} > V_{IN}, when V_{EN} > V_{UVLO} rising (min), the input pin (IN) must sink 1 mA of current to avoid the device being turn on with floating input pin.

5.4 Thermal Information

THERMAL METRIC ⁽¹⁾		TLV758P		UNIT
		DBV (SOT-23)	DRV (WSON)	
		5 PINS	6 PINS	
R _{θJA}	Junction-to-ambient thermal resistance	176.9	80.3	°C/W
R _{θJC(top)}	Junction-to-case (top) thermal resistance	95.3	98.7	°C/W
R _{θJB}	Junction-to-board thermal resistance	45.0	44.8	°C/W
ψ _{JT}	Junction-to-top characterization parameter	21.0	6.1	°C/W
ψ _{JB}	Junction-to-board characterization parameter	44.8	45.0	°C/W
R _{θJC(bot)}	Junction-to-case (bottom) thermal resistance	N/A	20.8	°C/W

- (1) For more information about traditional and new thermal metrics, see the [Semiconductor and IC Package Thermal Metrics application note](#).

5.5 Electrical Characteristics

at operating temperature range ($T_J = -40^\circ\text{C}$ to $+125^\circ\text{C}$), $V_{IN} = V_{OUT(NOM)} + 0.5\text{ V}$ or 1.5 V (whichever is greater), $I_{OUT} = 1\text{ mA}$, $V_{EN} = V_{IN}$, and $C_{IN} = C_{OUT} = 1\text{ }\mu\text{F}$ (unless otherwise noted); all typical values are at $T_J = 25^\circ\text{C}$

PARAMETER		TEST CONDITIONS	MIN	TYP	MAX	UNIT	
V_{FB}	Feedback voltage	$T_J = 25^\circ\text{C}$		0.55		V	
	Output accuracy ⁽¹⁾	$T_J = 25^\circ\text{C}$	-0.7%		0.7%		
		$-40^\circ\text{C} \leq T_J \leq +85^\circ\text{C}$	-1%		1%		
		$-40^\circ\text{C} \leq T_J \leq +125^\circ\text{C}$	-1.5%		1.5%		
	Line regulation	$V_{OUT(NOM)} + 0.5\text{ V}^{(2)} \leq V_{IN} \leq 6.0\text{ V}$		2	7.5	mV	
	Load regulation	$0.1\text{ mA} \leq I_{OUT} \leq 500\text{ mA}$, $V_{IN} \geq 2.0\text{ V}$		0.030		V/A	
I_{GND}	Ground current	$I_{OUT} = 0\text{ mA}$	$T_J = 25^\circ\text{C}$	10	25	31	μA
I_{GND}	Ground current					35	μA
I_{SHDN}	Shutdown current	$V_{EN} \leq 0.3\text{ V}$, $1.5\text{ V} \leq V_{IN} \leq 6.0\text{ V}$		0.1	1	μA	
I_{FB}	Feedback pin current			0.01	0.1	μA	
I_{CL}	Output current limit	$V_{IN} = V_{OUT(NOM)} + 1.0\text{ V}$	$V_{OUT} = V_{OUT(NOM)} - 0.2\text{ V}$, $V_{OUT} < 1.5\text{ V}$	530	720	865	mA
			$V_{OUT} = 0.9\text{ V} \times V_{OUT(NOM)}$, $V_{OUT} \geq 1.5\text{ V}$	530	720	865	
I_{SC}	Short-circuit current limit	$V_{IN} = V_{OUT(NOM)} + 1.0\text{ V}$		$V_{OUT} = 0\text{ V}$	350		mA
V_{DO}	Dropout voltage	$I_{OUT} = 500\text{ mA}$, $-40^\circ\text{C} \leq T_J \leq +125^\circ\text{C}$, $V_{OUT} = 0.95 \times V_{OUT(NOM)}$	$0.65\text{ V} \leq V_{OUT} < 0.8\text{ V}$		720	880	mV
			$0.8\text{ V} \leq V_{OUT} < 1.0\text{ V}$		585	750	
			$1.0\text{ V} \leq V_{OUT} < 1.2\text{ V}$		420	570	
			$1.2\text{ V} \leq V_{OUT} < 1.5\text{ V}$		285	400	
			$1.5\text{ V} \leq V_{OUT} < 1.8\text{ V}$		180	235	
			$1.8\text{ V} \leq V_{OUT} < 2.5\text{ V}$		140	185	
			$2.5\text{ V} \leq V_{OUT} < 3.3\text{ V}$		102	140	
PSRR	Power-supply rejection ratio	$V_{IN} = V_{OUT(NOM)} + 1.0\text{ V}$, $I_{OUT} = 50\text{ mA}$	$f = 1\text{ kHz}$		50		dB
			$f = 100\text{ kHz}$		45		
			$f = 1\text{ MHz}$		30		
V_n	Output noise voltage	$BW = 10\text{ Hz to }100\text{ kHz}$, $V_{OUT} = 0.9\text{ V}$		53		μV_{RMS}	
V_{UVLO}	Undervoltage lockout	V_{IN} rising	1.21	1.33	1.47	V	
		V_{IN} falling	1.17	1.29	1.42	V	
$V_{UVLO, HYST}$	Undervoltage lockout hysteresis	V_{IN} Hysteresis		40		mV	
t_{STR}	Start-up time	From EN low-to-high transition to $V_{OUT} = V_{OUT(NOM)} \times 95\%$		500		μs	
$V_{EN(HI)}$	EN pin high voltage		1.0			V	
$V_{EN(LO)}$	EN pin low voltage				0.3	V	
I_{EN}	Enable pin current	$V_{IN} = EN = 6.0\text{ V}$		10		nA	
$R_{PULL DOWN}$	Pulldown resistance	$V_{IN} = 6.0\text{ V}$		95		Ω	
T_{SD}	Thermal shutdown	Shutdown, temperature increasing		170		$^\circ\text{C}$	
		Reset, temperature decreasing		155			

(1) When the device is connected to external feedback resistors at the FB pin, external resistor tolerances are not included

(2) $V_{IN} = 1.5\text{ V}$ for $V_{OUT} < 1.0\text{ V}$.

5.6 Typical Characteristics

at operating temperature range $T_J = 25^\circ\text{C}$, $V_{IN} = V_{OUT(NOM)} + 0.5\text{ V}$ or 1.5 V (whichever is greater), $I_{OUT} = 1\text{ mA}$, $V_{EN} = V_{IN}$, and $C_{IN} = C_{OUT} = 1\text{ }\mu\text{F}$ (unless otherwise noted)



$V_{OUT} = 3.3\text{ V}$, $I_{OUT} = 1\text{ mA}$

5-1. 3.3-V Line Regulation vs V_{IN}

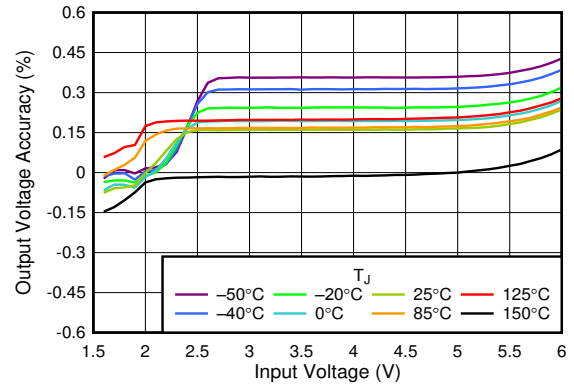

$V_{OUT} = 0.55\text{ V}$, $I_{OUT} = 1\text{ mA}$

5-2. 0.55-V Line Regulation vs V_{IN}

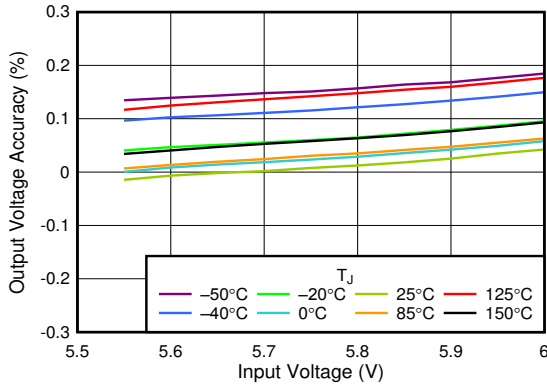

$V_{OUT} = 5.5\text{ V}$, $I_{OUT} = 1\text{ mA}$

5-3. 5.5-V Line Regulation vs V_{IN}

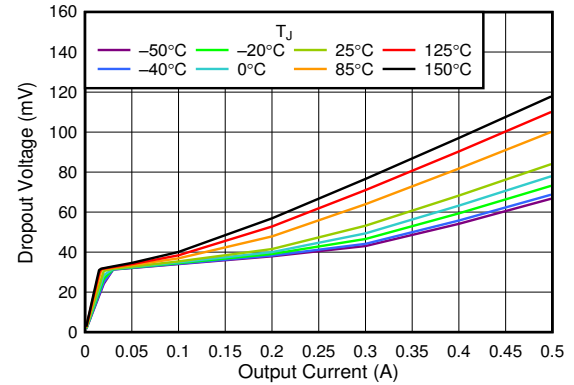

5-4. 3.3-V Dropout Voltage vs I_{OUT}

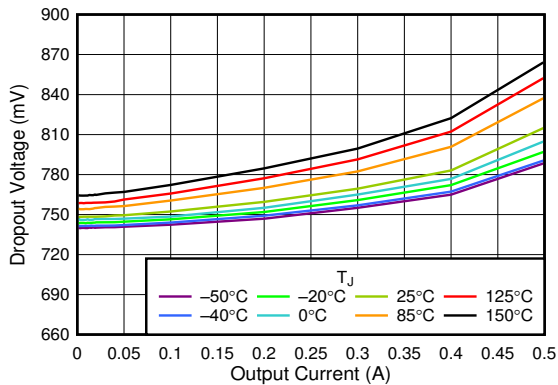

5-5. 0.55-V Dropout Voltage vs I_{OUT}

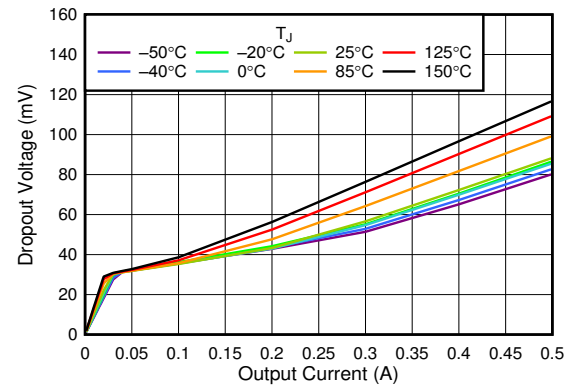

5-6. 5.5-V Dropout Voltage vs I_{OUT}

5.6 Typical Characteristics (continued)

at operating temperature range $T_J = 25^\circ\text{C}$, $V_{IN} = V_{OUT(NOM)} + 0.5\text{ V}$ or 1.5 V (whichever is greater), $I_{OUT} = 1\text{ mA}$, $V_{EN} = V_{IN}$, and $C_{IN} = C_{OUT} = 1\ \mu\text{F}$ (unless otherwise noted)



5-7. V_{DO} vs V_{OUT}

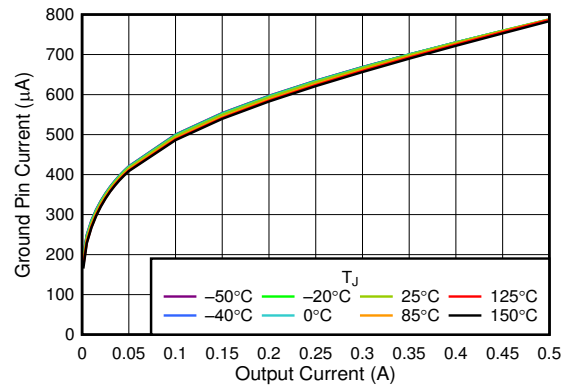

5-8. I_{GND} vs I_{OUT}

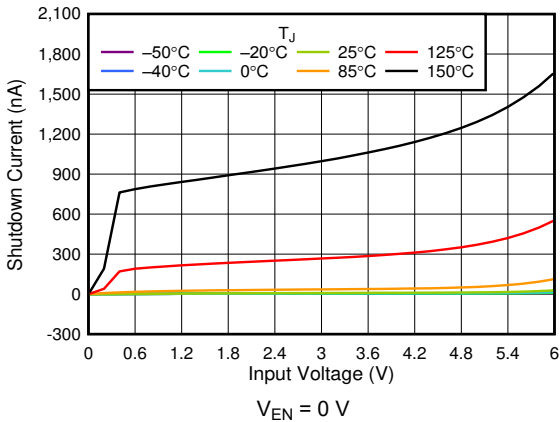

5-9. I_{SHDN} vs V_{IN}

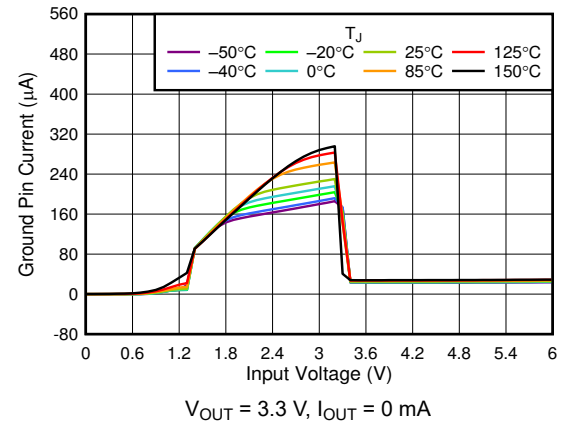

5-10. I_Q vs V_{IN}

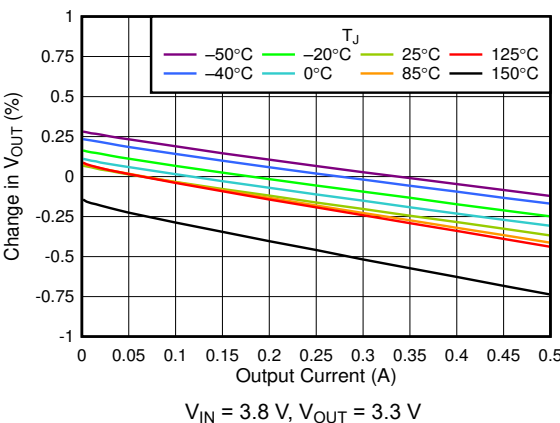

5-11. 3.3-V Load Regulation vs I_{OUT}

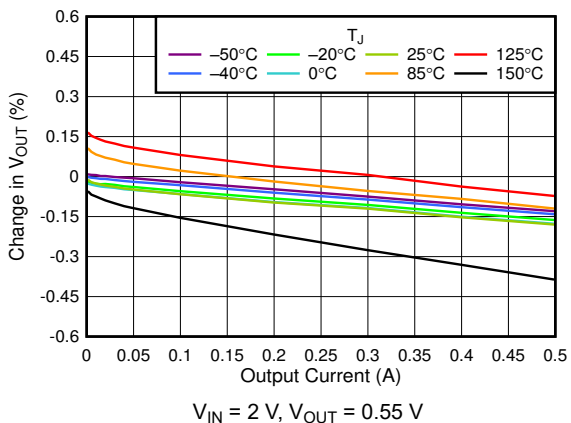

5-12. 0.55-V Load Regulation vs I_{OUT}

5.6 Typical Characteristics (continued)

at operating temperature range $T_J = 25^\circ\text{C}$, $V_{IN} = V_{OUT(NOM)} + 0.5\text{ V}$ or 1.5 V (whichever is greater), $I_{OUT} = 1\text{ mA}$, $V_{EN} = V_{IN}$, and $C_{IN} = C_{OUT} = 1\text{ }\mu\text{F}$ (unless otherwise noted)

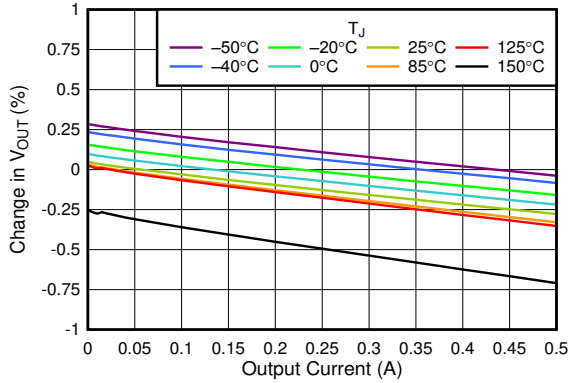

$V_{IN} = 6\text{ V}$, $V_{OUT} = 5.5\text{ V}$

5-13. 5.5-V Load Regulation vs I_{OUT}

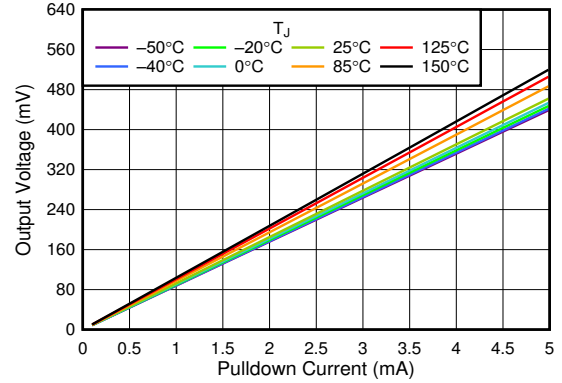

5-14. V_{OUT} vs I_{OUT} Pulldown Resistor

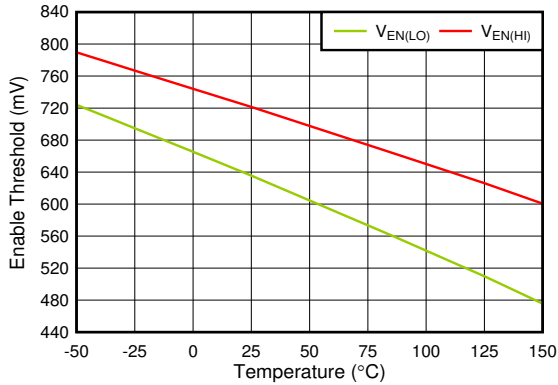

5-15. $V_{EN(HI)}$ and $V_{EN(LO)}$ vs Temperature

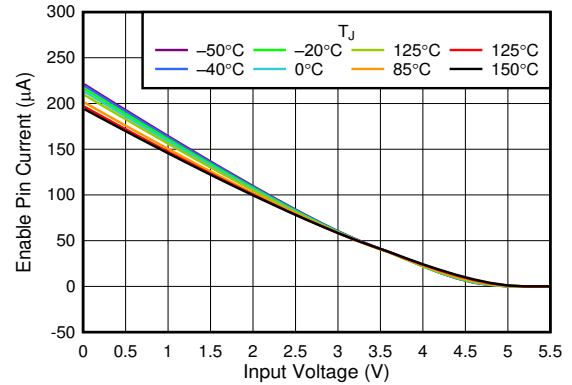

$V_{EN} = 5.5\text{ V}$

5-16. I_{EN} vs V_{IN}

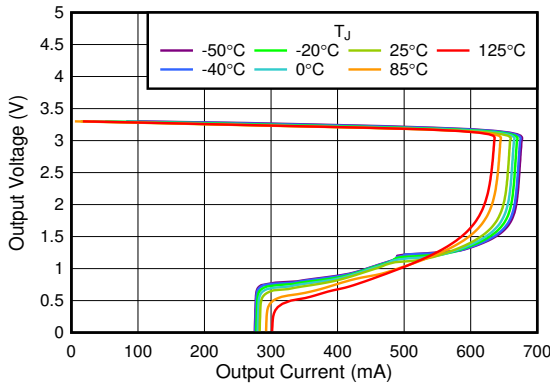

5-17. 3.3-V Foldback Current Limit vs I_{OUT}

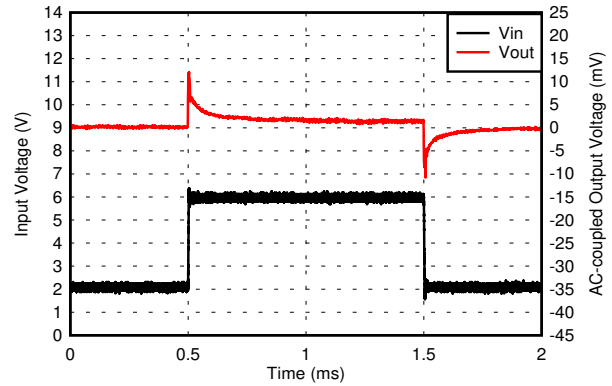

$V_{OUT} = 0.55\text{ V}$, $I_{OUT} = 1\text{ mA}$, V_{IN} slew rate = $1\text{ V}/\mu\text{s}$

5-18. 0.55-V Line Transient

5.6 Typical Characteristics (continued)

at operating temperature range $T_J = 25^\circ\text{C}$, $V_{IN} = V_{OUT(NOM)} + 0.5\text{ V}$ or 1.5 V (whichever is greater), $I_{OUT} = 1\text{ mA}$, $V_{EN} = V_{IN}$, and $C_{IN} = C_{OUT} = 1\text{ }\mu\text{F}$ (unless otherwise noted)

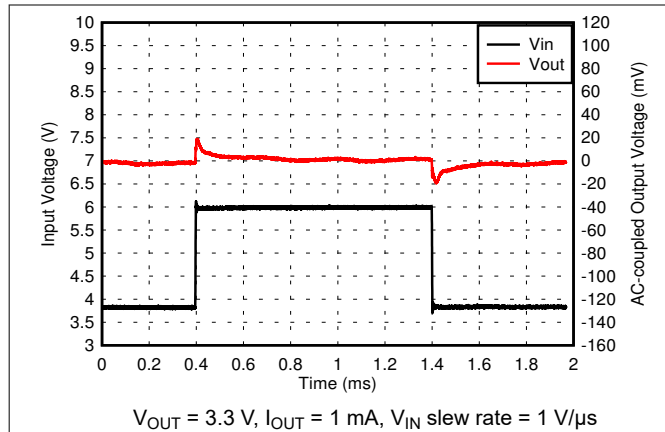

5-19. 3.3-V Line Transient

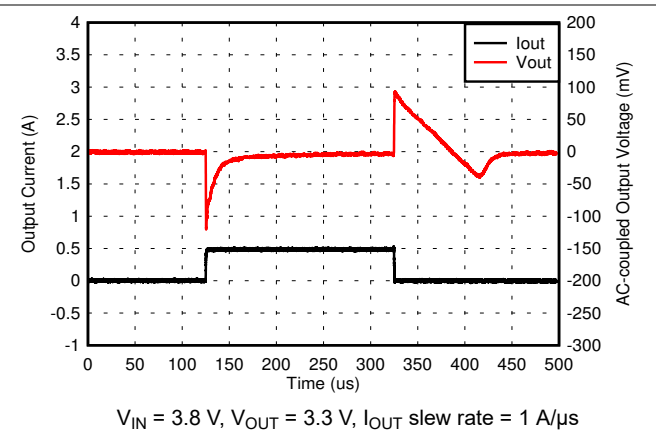

5-20. 3.3-V, 1-mA to 500-mA Load Transient

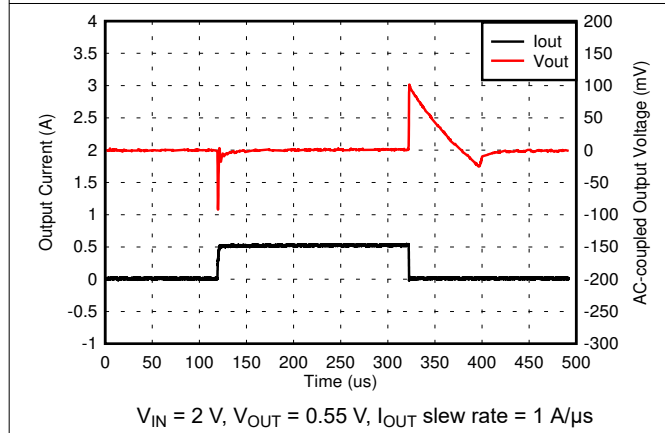

5-21. 0.55-V, 1-mA to 500-mA Load Transient

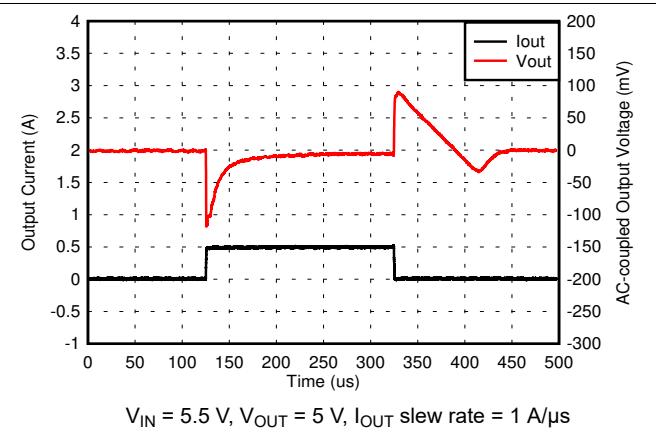

5-22. 5-V, 1-mA to 500-mA Load Transient

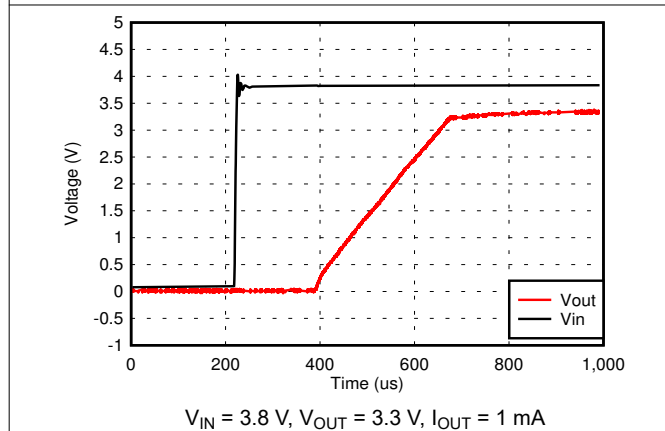

5-23. V_{IN} Power-Up

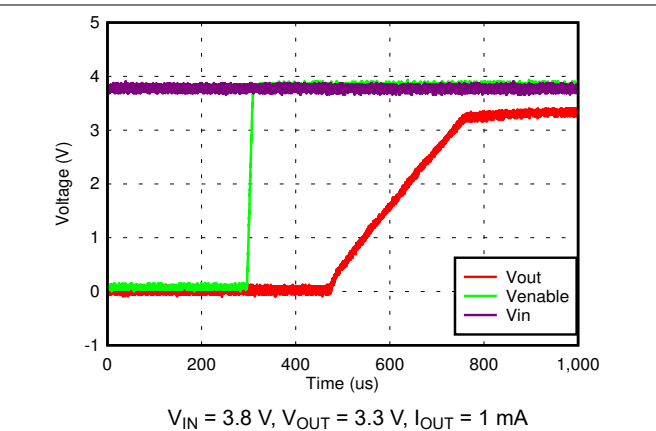

5-24. Start-Up With EN

5.6 Typical Characteristics (continued)

at operating temperature range $T_J = 25^\circ\text{C}$, $V_{IN} = V_{OUT(NOM)} + 0.5\text{ V}$ or 1.5 V (whichever is greater), $I_{OUT} = 1\text{ mA}$, $V_{EN} = V_{IN}$, and $C_{IN} = C_{OUT} = 1\text{ }\mu\text{F}$ (unless otherwise noted)

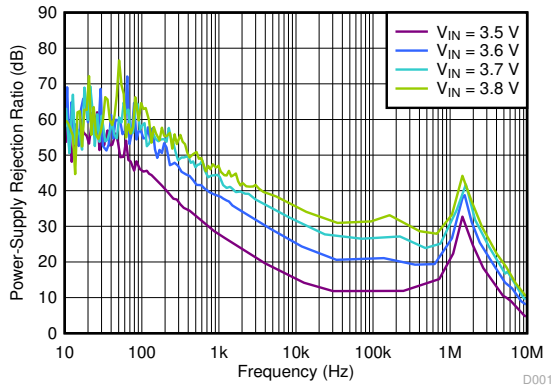

$V_{OUT} = 3.3\text{ V}$, $I_{OUT} = 500\text{ mA}$, $C_{OUT} = 2.2\text{ }\mu\text{F}$

5-25. PSRR vs Frequency and V_{IN}

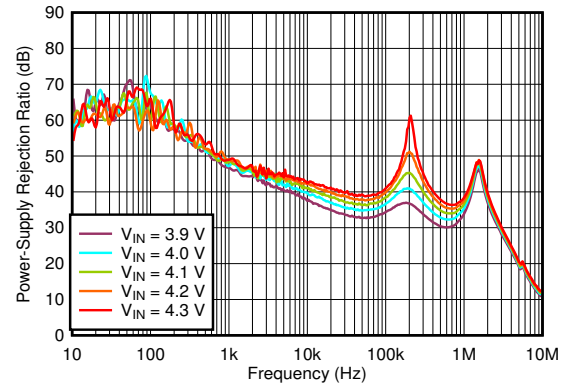

$V_{OUT} = 3.3\text{ V}$, $I_{OUT} = 500\text{ mA}$, $C_{OUT} = 2.2\text{ }\mu\text{F}$

5-26. PSRR vs Frequency and V_{IN}

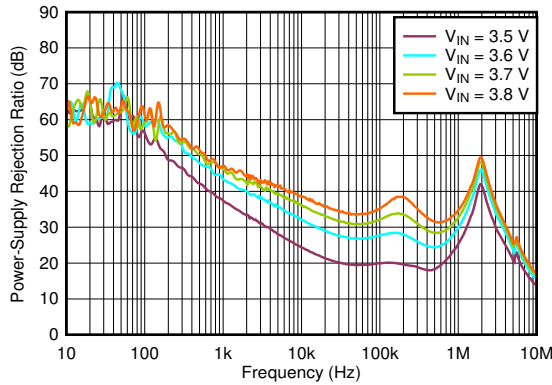

$V_{OUT} = 3.3\text{ V}$, $I_{OUT} = 250\text{ mA}$, $C_{OUT} = 2.2\text{ }\mu\text{F}$

5-27. PSRR vs Frequency and V_{IN}

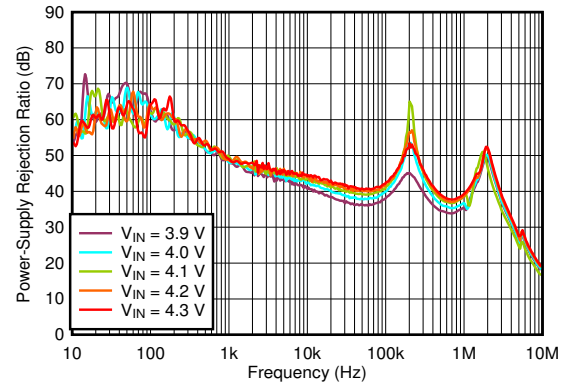

$V_{OUT} = 3.3\text{ V}$, $I_{OUT} = 250\text{ mA}$, $C_{OUT} = 2.2\text{ }\mu\text{F}$

5-28. PSRR vs Frequency and V_{IN}

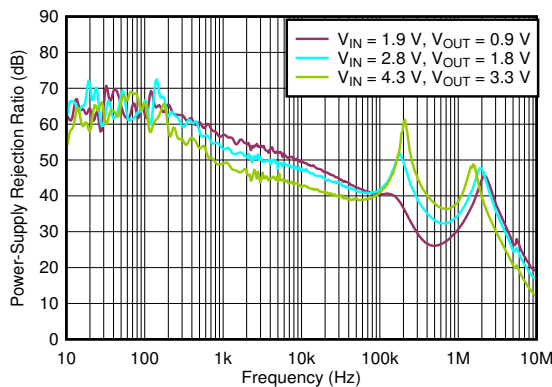

$I_{OUT} = 500\text{ mA}$, $C_{OUT} = 2.2\text{ }\mu\text{F}$

5-29. PSRR vs Frequency

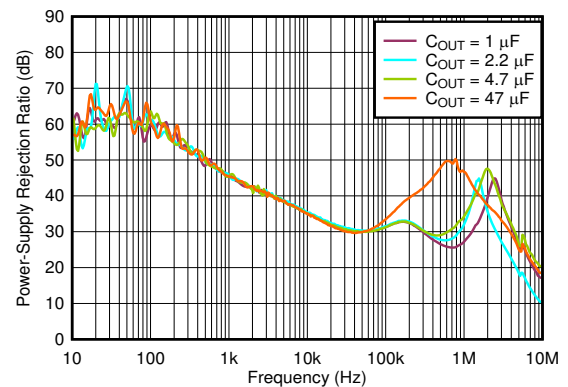

$V_{IN} = 3.8\text{ V}$, $V_{OUT} = 3.3\text{ V}$, $I_{OUT} = 500\text{ mA}$

5-30. PSRR vs Frequency and C_{OUT}

5.6 Typical Characteristics (continued)

at operating temperature range $T_J = 25^\circ\text{C}$, $V_{IN} = V_{OUT(NOM)} + 0.5\text{ V}$ or 1.5 V (whichever is greater), $I_{OUT} = 1\text{ mA}$, $V_{EN} = V_{IN}$, and $C_{IN} = C_{OUT} = 1\text{ }\mu\text{F}$ (unless otherwise noted)

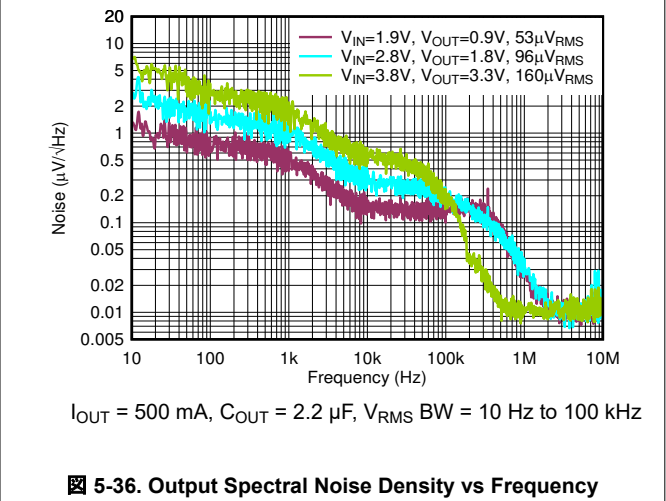
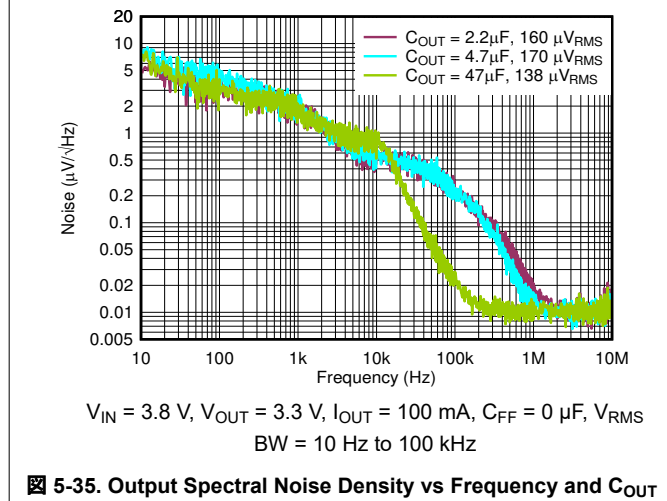
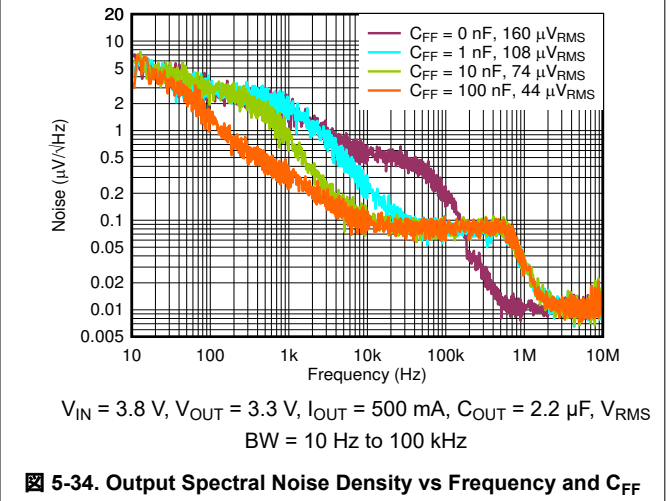
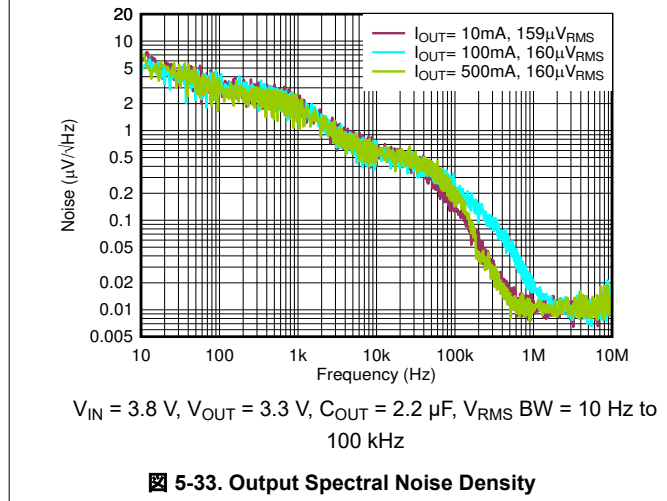
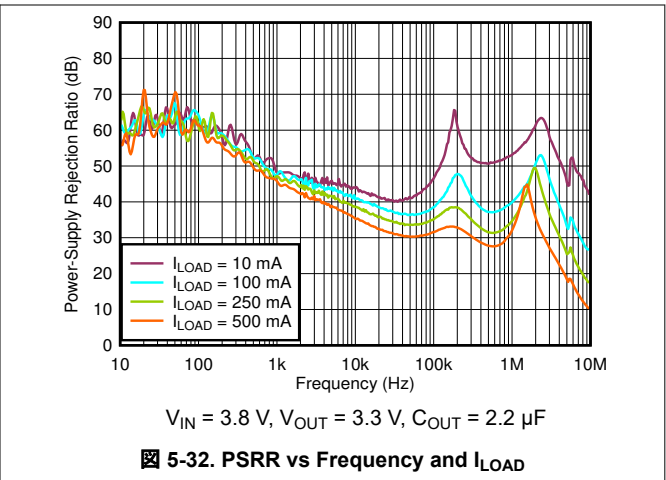
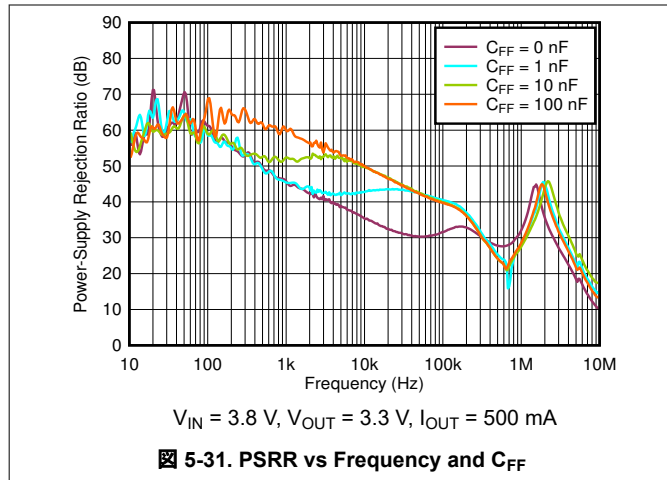

6 Detailed Description

6.1 Overview

The TLV758P low-dropout regulators (LDO) consumes low quiescent current and delivers excellent line and load transient performance. These characteristics, combined with low noise and good PSRR with low dropout voltage, make this device designed for portable consumer applications.

This regulator offers foldback current limit, shutdown, and thermal protection. The operating junction temperature for this device is -40°C to $+125^{\circ}\text{C}$.

6.2 Functional Block Diagram

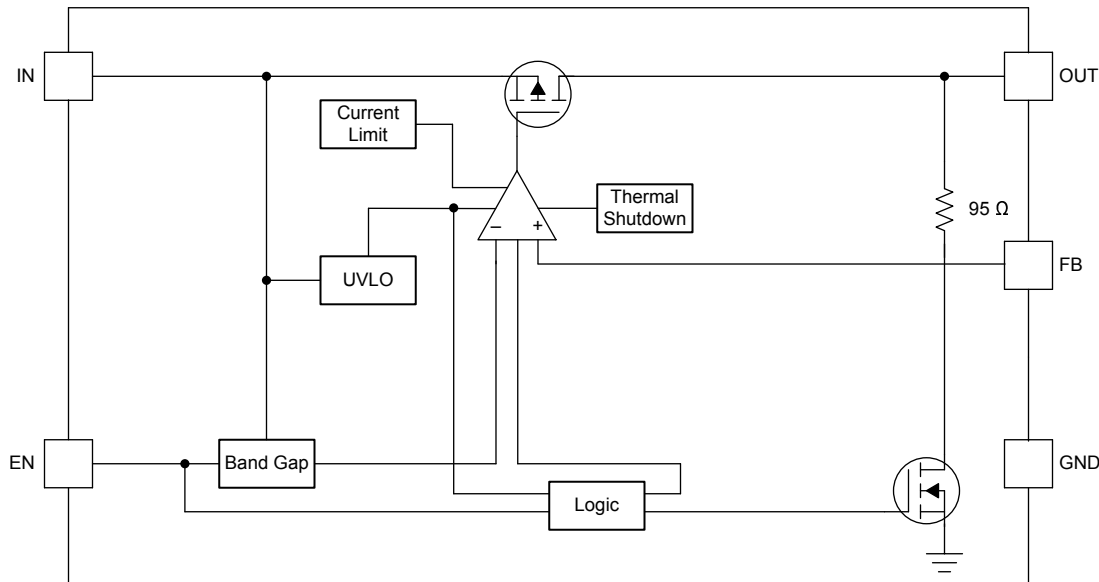

6.3 Feature Description

6.3.1 Undervoltage Lockout (UVLO)

The TLV758P uses an undervoltage lockout (UVLO) circuit that disables the output until the input voltage is greater than the rising UVLO voltage (V_{UVLO}). This circuit ensures that the device does not exhibit any unpredictable behavior when the supply voltage is lower than the operational range of the internal circuitry. When V_{IN} is less than V_{UVLO} , the output is connected to ground with a pull-down resistor ($R_{PULLDOWN}$).

6.3.2 Shutdown

The enable pin (EN) is active high. Enable the device by forcing the EN pin to exceed $V_{EN(HI)}$. Turn off the device by forcing the EN pin to drop below $V_{EN(LO)}$. If shutdown capability is not required, connect EN to IN.

The TLV758P has an internal pull-down MOSFET that connects an $R_{PULLDOWN}$ resistor to ground when the device is disabled. The discharge time after disabling depends on the output capacitance (C_{OUT}) and the load resistance (R_L) in parallel with the pull-down resistor ($R_{PULLDOWN}$). 式 1 calculates the time constant:

$$\tau = (R_{PULLDOWN} \times R_L) / (R_{PULLDOWN} + R_L) \quad (1)$$

6.3.3 Foldback Current Limit

The device has an internal current limit circuit that protects the regulator during transient high-load current faults or shorting events. The current limit is a hybrid brick-wall-foldback scheme. The current limit transitions from a brick-wall scheme to a foldback scheme at the foldback voltage ($V_{FOLDBACK}$). In a high-load current fault with the output voltage above $V_{FOLDBACK}$, the brick-wall scheme limits the output current to the current limit (I_{CL}). When the voltage drops below $V_{FOLDBACK}$, a foldback current limit activates that scales back the current as the output

voltage approaches GND. When the output is shorted, the device supplies a typical current called the short-circuit current limit (I_{SC}). I_{CL} and I_{SC} are listed in the *Electrical Characteristics* table.

For this device, $V_{FOLDBACK} = 0.4 V \times V_{OUT(NOM)}$.

The output voltage is not regulated when the device is in current limit. When a current limit event occurs, the device begins to heat up because of the increase in power dissipation. When the device is in brick-wall current limit, the pass transistor dissipates power $[(V_{IN} - V_{OUT}) \times I_{CL}]$. When the device output is shorted and the output is below $V_{FOLDBACK}$, the pass transistor dissipates power $[(V_{IN} - V_{OUT}) \times I_{SC}]$. If thermal shutdown is triggered, the device turns off. After the device cools down, the internal thermal shutdown circuit turns the device back on. If the output current fault condition continues, the device cycles between current limit and thermal shutdown. For more information on current limits, see the [Know Your Limits application note](#).

Figure 6-1 shows a diagram of the foldback current limit.

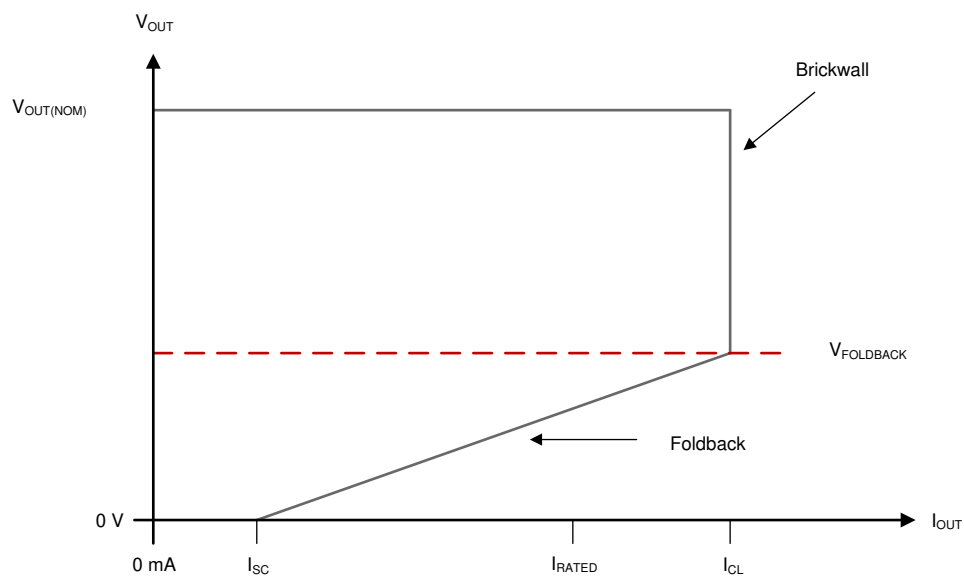

Figure 6-1. Foldback Current Limit

6.3.4 Thermal Shutdown

Thermal shutdown protection disables the output when the junction temperature rises to approximately $170^{\circ}C$. Disabling the device eliminates the power dissipated by the device, allowing the device to cool. When the junction temperature cools to approximately $155^{\circ}C$, the output circuitry is again enabled. Depending on power dissipation, thermal resistance, and ambient temperature, the thermal protection circuit can cycle on and off. This cycling limits regulator dissipation, protecting the LDO from damage as a result of overheating.

Activating the thermal shutdown feature usually indicates excessive power dissipation as a result of the product of the $(V_{IN} - V_{OUT})$ voltage and the load current. For reliable operation, limit junction temperature to $125^{\circ}C$ maximum. To estimate the margin of safety in a complete design, increase the ambient temperature until the thermal protection is triggered; use worst-case loads and signal conditions.

The TLV758P internal protection circuitry protects against overload conditions but is not intended to be activated in normal operation. Continuously running the TLV758P into thermal shutdown degrades device reliability.

6.4 Device Functional Modes

6.4.1 Device Functional Mode Comparison

表 6-1 shows the conditions that lead to the different modes of operation. See the *Electrical Characteristics* table for parameter values.

表 6-1. Device Functional Mode Comparison

OPERATING MODE	PARAMETER			
	V_{IN}	V_{EN}	I_{OUT}	T_J
Normal operation	$V_{IN} > V_{OUT(nom)} + V_{DO}$ and $V_{IN} > V_{IN(min)}$	$V_{EN} > V_{EN(HI)}$	$I_{OUT} < I_{OUT(max)}$	$T_J < T_{SD(shutdown)}$
Dropout operation	$V_{IN(min)} < V_{IN} < V_{OUT(nom)} + V_{DO}$	$V_{EN} > V_{EN(HI)}$	$I_{OUT} < I_{OUT(max)}$	$T_J < T_{SD(shutdown)}$
Disabled (any true condition disables the device)	$V_{IN} < V_{UVLO}$	$V_{EN} < V_{EN(LOW)}$	Not applicable	$T_J > T_{SD(shutdown)}$

6.4.2 Normal Operation

The device regulates to the nominal output voltage when the following conditions are met:

- The input voltage is greater than the nominal output voltage plus the dropout voltage ($V_{OUT(nom)} + V_{DO}$)
- The output current is less than the current limit ($I_{OUT} < I_{CL}$)
- The device junction temperature is less than the thermal shutdown temperature ($T_J < T_{SD}$)
- The enable voltage has previously exceeded the enable rising threshold voltage and has not yet decreased to less than the enable falling threshold

6.4.3 Dropout Operation

If the input voltage is lower than the nominal output voltage plus the specified dropout voltage, but all other conditions are met for normal operation, the device operates in dropout mode. In this mode, the output voltage tracks the input voltage. During this mode, the transient performance of the device becomes significantly degraded because the pass transistor is in the ohmic or triode region, and acts as a switch. Line or load transients in dropout can result in large output-voltage deviations.

When the device is in a steady dropout state (defined as when the device is in dropout, $V_{IN} < V_{OUT(NOM)} + V_{DO}$, directly after being in a normal regulation state, but *not* during start-up), the pass transistor is driven into the ohmic or triode region. When the input voltage returns to a value greater than or equal to the nominal output voltage plus the dropout voltage ($V_{OUT(NOM)} + V_{DO}$), the output voltage can overshoot for a short period of time while the device pulls the pass transistor back into the linear region.

6.4.4 Disabled

The output of the device can be shutdown by forcing the voltage of the enable pin to less than the maximum EN pin low-level input voltage (see the *Electrical Characteristics* table). When disabled, the pass transistor is turned off, internal circuits are shutdown, and the output voltage is actively discharged to ground by an internal discharge circuit from the output to ground.

7 Application and Implementation

注

以下のアプリケーション情報は、TI の製品仕様に含まれるものではなく、TI ではその正確性または完全性を保証いたしません。個々の目的に対する製品の適合性については、お客様の責任で判断していただくこととなります。お客様は自身の設計実装を検証しテストすることで、システムの機能を確認する必要があります。

7.1 Application Information

7.1.1 Adjustable Device Feedback Resistors

図 7-1 shows that the output voltage of the TLV758P can be adjusted from 0.55 V to 5.5 V by using a resistor divider network.



図 7-1. Adjustable Operation

The adjustable-version device requires external feedback divider resistors to set the output voltage. V_{OUT} is set using the feedback divider resistors, R_1 and R_2 , according to the following equation:

$$V_{OUT} = V_{FB} \times (1 + R_1 / R_2) \quad (2)$$

For this device, $V_{FB} = 0.55$ V.

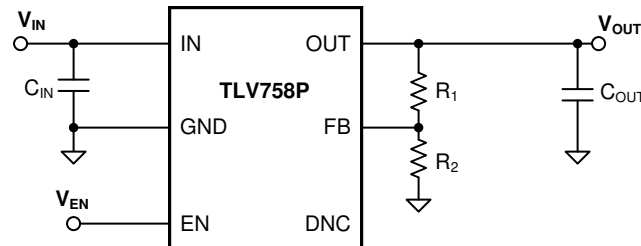
To ignore the FB pin current error term in the V_{OUT} equation, set the feedback divider current to 100 times the FB pin current listed in the *Electrical Characteristics* table. This setting provides the maximum feedback divider series resistance, as shown in the following equation:

$$R_1 + R_2 \leq V_{OUT} / (I_{FB} \times 100) \quad (3)$$

For this device, $I_{FB} = 10$ nA.

7.1.2 Input and Output Capacitor Selection

The TLV758P requires an output capacitance of 0.47 μ F or larger for stability. Use X5R- and X7R-type ceramic capacitors because these capacitors have minimal variation in value and equivalent series resistance (ESR) over temperature. When choosing a capacitor for a specific application, pay attention to the dc bias characteristics for the capacitor. Higher output voltages cause a significant derating of the capacitor. For best performance, the maximum recommended output capacitance is 220 μ F.

Although an input capacitor is not required for stability, good analog design practice is to connect a capacitor from IN to GND. Some input supplies have a high impedance, thus placing the input capacitor on the input supply helps reduce the input impedance. This capacitor counteracts reactive input sources and improves transient response, input ripple, and PSRR. If the input supply has a high impedance over a large range of frequencies, several input capacitors can be used in parallel to lower the impedance over frequency. Use a higher-value capacitor if large, fast, rise-time load transients are anticipated, or if the device is located several inches from the input power source.

7.1.3 Dropout Voltage

The TLV758P uses a PMOS pass transistor to achieve low dropout. When $(V_{IN} - V_{OUT})$ is less than the dropout voltage (V_{DO}), the PMOS pass transistor is in the linear region of operation and the input-to-output resistance is the $R_{DS(ON)}$ of the PMOS pass transistor. V_{DO} scales approximately with output current because the PMOS pass transistor behaves like a resistor in dropout mode. As with any linear regulator, PSRR and transient response degrade as $(V_{IN} - V_{OUT})$ approaches dropout operation.

7.1.4 Exiting Dropout

Some applications have transients that place the LDO into dropout, such as slower ramps on V_{IN} during start-up. As with other LDOs, the output may overshoot on recovery from these conditions. A ramping input supply causes an LDO to overshoot on start-up, as shown in [Figure 7-2](#), when the slew rate and voltage levels are in the correct range. Use an enable signal to avoid this condition.

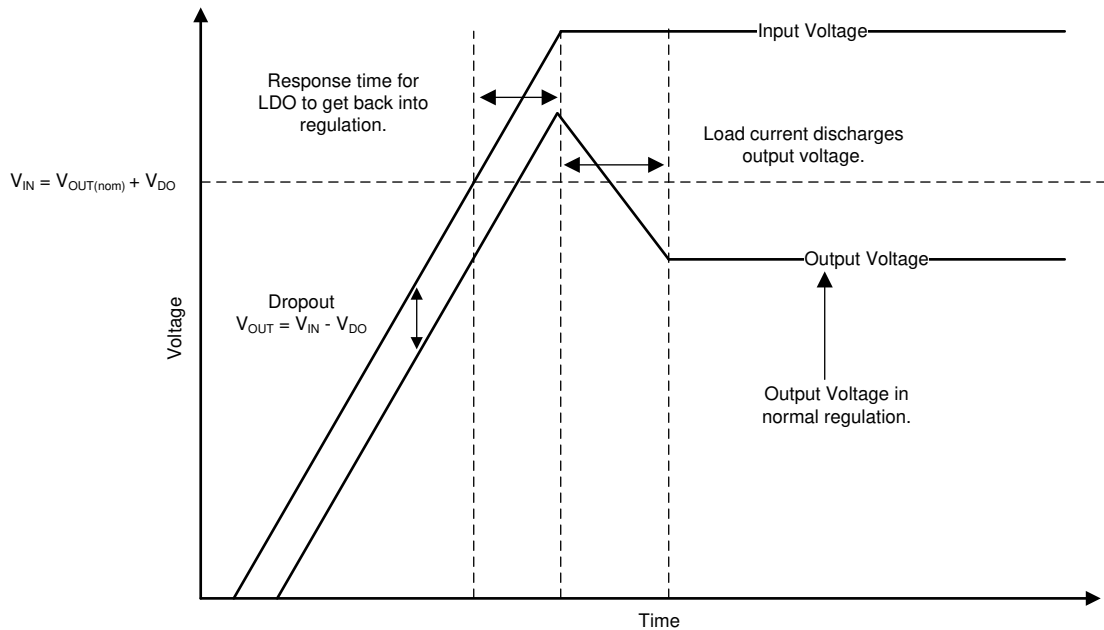

Figure 7-2. Start-Up Into Dropout

Line transients out of dropout can also cause overshoot on the output of the regulator. These overshoots are caused by the error amplifier having to drive the gate capacitance of the pass transistor and bring the gate back to the correct voltage for proper regulation. [Figure 7-3](#) illustrates what is happening internally with the gate voltage and how overshoot can be caused during operation. When the LDO is placed in dropout, the gate voltage (VGS) is pulled all the way down to ground to give the pass transistor the lowest on-resistance as possible. However, if a line transient occurs when the device is in dropout, the loop is not in regulation and can cause the output to overshoot until the loop responds and the output current pulls the output voltage back down into regulation. If these transients are not acceptable, then continue to add input capacitance in the system until the transient is slow enough to reduce the overshoot.



☒ 7-3. Line Transients From Dropout

7.1.5 Reverse Current

As with most LDOs, excessive reverse current can damage this device.

Reverse current flows through the body diode on the pass transistor instead of the normal conducting channel. At high magnitudes, this current flow degrades the long-term reliability of the device, as a result of one of the following conditions:

- Degradation caused by electromigration
- Excessive heat dissipation
- Potential for a latch-up condition

Conditions where reverse current can occur are outlined in this section, all of which can exceed the absolute maximum rating of $V_{OUT} > V_{IN} + 0.3\text{ V}$:

- If the device has a large C_{OUT} and the input supply collapses with little or no load current
- The output is biased when the input supply is not established
- The output is biased above the input supply

If reverse current flow is expected in the application, external protection must be used to protect the device. [Figure 7-4](#) shows one approach of protecting the device.

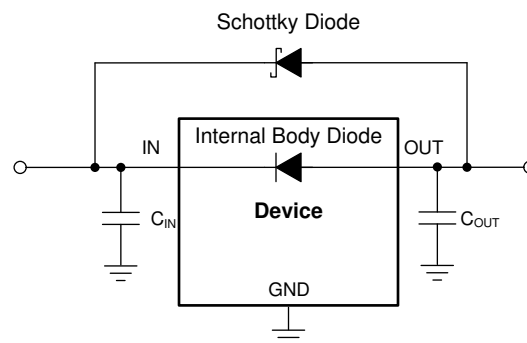

Figure 7-4. Example Circuit for Reverse Current Protection Using a Schottky Diode

7.1.6 Power Dissipation (P_D)

Circuit reliability requires consideration of the device power dissipation, location of the circuit on the printed circuit board (PCB), and correct sizing of the thermal plane. The PCB area around the regulator must have few or no other heat-generating devices that cause added thermal stress.

To first-order approximation, power dissipation in the regulator depends on the input-to-output voltage difference and load conditions. [Equation 4](#) calculates power dissipation (P_D).

$$P_D = (V_{IN} - V_{OUT}) \times I_{OUT} \quad (4)$$

注

Power dissipation can be minimized, and therefore greater efficiency can be achieved, by correct selection of the system voltage rails. For the lowest power dissipation use the minimum input voltage required for correct output regulation.

For devices with a thermal pad, the primary heat conduction path for the device package is through the thermal pad to the PCB. Solder the thermal pad to a copper pad area under the device. This pad area must contain an array of plated vias that conduct heat to additional copper planes for increased heat dissipation.

The maximum power dissipation determines the maximum allowable ambient temperature (T_A) for the device. According to [Equation 5](#), power dissipation and junction temperature are most often related by the junction-to-ambient thermal resistance ($R_{\theta JA}$) of the combined PCB and device package and the temperature of the ambient air (T_A).

$$T_J = T_A + (R_{\theta JA} \times P_D) \quad (5)$$

Thermal resistance ($R_{\theta JA}$) is highly dependent on the heat-spreading capability built into the particular PCB design, and therefore varies according to the total copper area, copper weight, and location of the planes. The junction-to-ambient thermal resistance listed in the *Thermal Information* table is determined by the JEDEC standard PCB and copper-spreading area, and is used as a relative measure of package thermal performance.

7.1.7 Feed-Forward Capacitor (C_{FF})

For the adjustable-voltage version device, a feed-forward capacitor (C_{FF}) can be connected from the OUT pin to the FB pin. C_{FF} improves transient, noise, and PSRR performance, but is not required for regulator stability. Recommended C_{FF} values are listed in the *Recommended Operating Conditions* table. A higher capacitance C_{FF} can be used; however, the start-up time increases. For a detailed description of C_{FF} tradeoffs, see the [Pros and Cons of Using a Feedforward Capacitor with a Low-Dropout Regulator application note](#).

7.1.8 Start-Up Sequencing

If V_{EN} is greater than V_{UVLO} rising (min), then the input pin (IN) must sink 1 mA of current to avoid the device being turn on with a floating input pin.

7.2 Typical Application

Figure 7-5 shows the typical application circuit for the TLV758P. Input and output capacitances must be at least 1 μF .

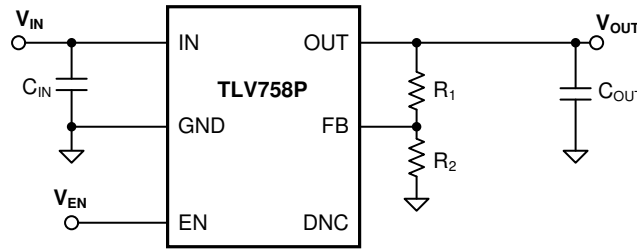

Figure 7-5. TLV758P Typical Application

7.2.1 Design Requirements

Use the parameters listed in Table 7-1 for typical linear regulator applications.

Table 7-1. Design Parameters

PARAMETER	DESIGN REQUIREMENT
Input voltage	3.8 V
Output voltage	3.3 V, $\pm 1\%$
Input current	500 mA (maximum)
Output load	500-mA DC
Maximum ambient temperature	70°C

7.2.2 Detailed Design Procedure

Input and output capacitors are required to achieve the output voltage transient requirements. Capacitance values of 2.2 μF are selected to give the maximum output capacitance in a small, low-cost package; see the [Input and Output Capacitor Selection](#) section for details.

Figure 7-1 illustrates the output voltage of the TLV758P; set the output voltage using the resistor divider.

7.2.2.1 Input Current

During normal operation, the input current to the LDO is approximately equal to the output current of the LDO. During start-up, the input current is higher as a result of the inrush current charging the output capacitor. Use Equation 6 to calculate the current through the input.

$$I_{\text{OUT}(t)} = \left[\frac{C_{\text{OUT}} \times dV_{\text{OUT}(t)}}{dt} \right] + \left[\frac{V_{\text{OUT}(t)}}{R_{\text{LOAD}}} \right] \quad (6)$$

where:

- $V_{\text{OUT}(t)}$ is the instantaneous output voltage of the turn-on ramp
- $dV_{\text{OUT}(t)} / dt$ is the slope of the V_{OUT} ramp
- R_{LOAD} is the resistive load impedance

7.2.2.2 Thermal Dissipation

The junction temperature can be determined using the junction-to-ambient thermal resistance ($R_{\theta JA}$) and the total power dissipation (P_D). Use 式 7 to calculate the power dissipation. Multiply P_D by $R_{\theta JA}$ as 式 8 shows and add the ambient temperature (T_A) to calculate the junction temperature (T_J).

$$P_D = (I_{GND} + I_{OUT}) \times (V_{IN} - V_{OUT}) \quad (7)$$

$$T_J = R_{\theta JA} \times P_D + T_A \quad (8)$$

Calculate the maximum ambient temperature as 式 9 shows if the ($T_{J(MAX)}$) value does not exceed 125°C. 式 10 calculates the maximum ambient temperature with a value of 104.93°C.

$$T_{A(MAX)} = T_{J(MAX)} - R_{\theta JA} \times P_D \quad (9)$$

$$T_{A(MAX)} = 125^\circ\text{C} - 80.3^\circ\text{C/W} \times (3.8\text{ V} - 3.3\text{ V}) \times (0.5\text{ A}) = 104.93^\circ\text{C} \quad (10)$$

7.2.3 Application Curve



图 7-6. PSRR vs Frequency and I_{LOAD}

7.3 Power Supply Recommendations

Connect a low output impedance power supply directly to the IN pin of the TLV758P.

7.4 Layout

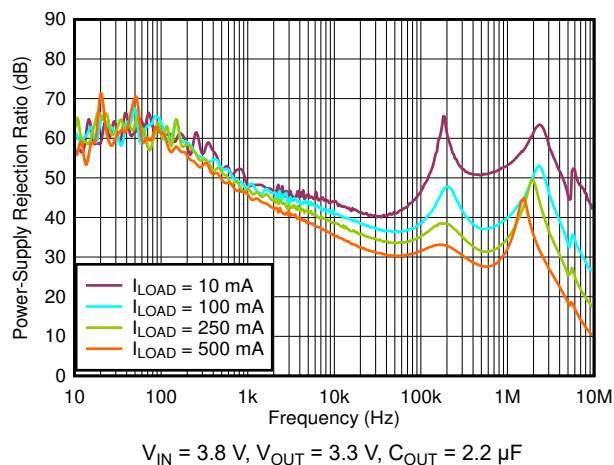
7.4.1 Layout Guidelines

- Place input and output capacitors as close to the device as possible.
- Use copper planes for device connections, in order to optimize thermal performance.
- Place thermal vias around the device to distribute the heat.
- Do not place a thermal via directly beneath the thermal pad of the DRV package. A via can wick solder or solder paste away from the thermal pad joint during the soldering process, leading to a compromised solder joint on the thermal pad.

7.4.2 Layout Examples



☒ 7-7. DBV Package Layout Example

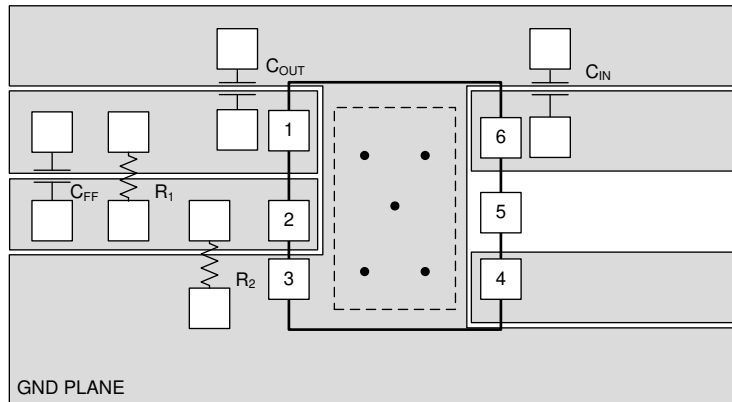

☒ 7-8. DRV Package Layout Example

8 Device and Documentation Support

8.1 Documentation Support

8.1.1 Device Nomenclature

表 8-1. Device Nomenclature⁽¹⁾

PRODUCT	V _{OUT}
TLV758 xx(x)Pyyyz	<p>xx(x) is the nominal output voltage. For output voltages with a resolution of 100 mV, two digits are used in the ordering number; otherwise, three digits are used (for example, 28 = 2.8 V; 125 = 1.25 V). 01 is for adjustable version.</p> <p>P indicates an active output discharge feature. All members of the TLV758P family actively discharge the output when the device is disabled.</p> <p>yyy is the package designator.</p> <p>z is the package quantity. R is for reel (3000 pieces), T is for tape (250 pieces).</p>

(1) For the most current package and ordering information see the Package Option Addendum at the end of this document, or visit the device product folder on www.ti.com.

8.1.2 Related Documentation

For related documentation see the following:

Texas Instruments, [Pros and cons of using a feedforward capacitor with a low-dropout regulator application note](#)

8.2 ドキュメントの更新通知を受け取る方法

ドキュメントの更新についての通知を受け取るには、ti.com のデバイス製品フォルダを開いてください。「更新の通知を受け取る」をクリックして登録すると、変更されたすべての製品情報に関するダイジェストを毎週受け取れます。変更の詳細については、修正されたドキュメントに含まれている改訂履歴をご覧ください。

8.3 サポート・リソース

テキサス・インスツルメンツ E2E™ サポート・フォーラムは、エンジニアが検証済みの回答と設計に関するヒントをエキスパートから迅速かつ直接得ることができる場所です。既存の回答を検索したり、独自の質問をしたりすることで、設計に必要な支援を迅速に得ることができます。

リンクされているコンテンツは、各寄稿者により「現状のまま」提供されるものです。これらはテキサス・インスツルメンツの仕様を構成するものではなく、必ずしもテキサス・インスツルメンツの見解を反映したものではありません。テキサス・インスツルメンツの[使用条件](#)を参照してください。

8.4 Trademarks

テキサス・インスツルメンツ E2E™ is a trademark of Texas Instruments.

すべての商標は、それぞれの所有者に帰属します。

8.5 静電気放電に関する注意事項



この IC は、ESD によって破損する可能性があります。テキサス・インスツルメンツは、IC を取り扱う際には常に適切な注意を払うことを推奨します。正しい取り扱いおよび設置手順に従わない場合、デバイスを破損するおそれがあります。

ESD による破損は、わずかな性能低下からデバイスの完全な故障まで多岐にわたります。精密な IC の場合、パラメータがわずかに変化するだけで公表されている仕様から外れる可能性があるため、破損が発生しやすくなっています。

8.6 用語集

[テキサス・インスツルメンツ用語集](#)

この用語集には、用語や略語の一覧および定義が記載されています。

9 Revision History

資料番号末尾の英字は改訂を表しています。その改訂履歴は英語版に準じています。

Changes from Revision C (March 2019) to Revision D (October 2023)	Page
• DRV パッケージを「事前情報」から「量産データ」に変更	1
• 「アプリケーション」セクションにリンクを追加	1
• Changed 5-V to 5.5-V in title of <i>5.5-V Load Regulation vs I_{OUT}</i> figure.....	7
• Added <i>Startup Sequencing</i> section.....	20
• Added <i>Device Nomenclature</i> section	24

Changes from Revision B (March 2019) to Revision C (March 2019)	Page
• Deleted thermal pad from DBV pin out drawing	3

10 Mechanical, Packaging, and Orderable Information

The following pages include mechanical, packaging, and orderable information. This information is the most current data available for the designated devices. This data is subject to change without notice and revision of this document. For browser-based versions of this data sheet, refer to the left-hand navigation.

PACKAGING INFORMATION

Orderable part number	Status (1)	Material type (2)	Package Pins	Package qty Carrier	RoHS (3)	Lead finish/ Ball material (4)	MSL rating/ Peak reflow (5)	Op temp (°C)	Part marking (6)
TLV75801PDBVJ	Active	Production	SOT-23 (DBV) 5	8000 JUMBO T&R	Yes	SN	Level-1-260C-UNLIM	-40 to 125	1UDF
TLV75801PDBVJ.A	Active	Production	SOT-23 (DBV) 5	8000 JUMBO T&R	Yes	SN	Level-1-260C-UNLIM	-40 to 125	1UDF
TLV75801PDBVR	Active	Production	SOT-23 (DBV) 5	3000 LARGE T&R	Yes	Call TI Sn Nipdau	Level-1-260C-UNLIM	-40 to 125	1UDF
TLV75801PDBVR.A	Active	Production	SOT-23 (DBV) 5	3000 LARGE T&R	Yes	Call TI	Level-1-260C-UNLIM	-40 to 125	1UDF
TLV75801PDBVT	Active	Production	SOT-23 (DBV) 5	250 SMALL T&R	Yes	Call TI Sn Nipdau	Level-1-260C-UNLIM	-40 to 125	1UDF
TLV75801PDBVT.A	Active	Production	SOT-23 (DBV) 5	250 SMALL T&R	Yes	NIPDAU	Level-1-260C-UNLIM	-40 to 125	1UDF
TLV75801PDRVR	Active	Production	WSON (DRV) 6	3000 LARGE T&R	Yes	NIPDAU	Level-1-260C-UNLIM	-40 to 125	1MHH
TLV75801PDRVR.A	Active	Production	WSON (DRV) 6	3000 LARGE T&R	Yes	NIPDAU	Level-1-260C-UNLIM	-40 to 125	1MHH
TLV75801PDRVRG4	Active	Production	WSON (DRV) 6	3000 LARGE T&R	Yes	NIPDAU	Level-1-260C-UNLIM	-40 to 125	1MHH
TLV75801PDRVRG4.A	Active	Production	WSON (DRV) 6	3000 LARGE T&R	Yes	NIPDAU	Level-1-260C-UNLIM	-40 to 125	1MHH
TLV75801PDRVT	Active	Production	WSON (DRV) 6	250 SMALL T&R	Yes	NIPDAU	Level-1-260C-UNLIM	-40 to 125	1MHH
TLV75801PDRVT.A	Active	Production	WSON (DRV) 6	250 SMALL T&R	Yes	NIPDAU	Level-1-260C-UNLIM	-40 to 125	1MHH

(1) **Status:** For more details on status, see our [product life cycle](#).

(2) **Material type:** When designated, preproduction parts are prototypes/experimental devices, and are not yet approved or released for full production. Testing and final process, including without limitation quality assurance, reliability performance testing, and/or process qualification, may not yet be complete, and this item is subject to further changes or possible discontinuation. If available for ordering, purchases will be subject to an additional waiver at checkout, and are intended for early internal evaluation purposes only. These items are sold without warranties of any kind.

(3) **RoHS values:** Yes, No, RoHS Exempt. See the [TI RoHS Statement](#) for additional information and value definition.

(4) **Lead finish/Ball material:** Parts may have multiple material finish options. Finish options are separated by a vertical ruled line. Lead finish/Ball material values may wrap to two lines if the finish value exceeds the maximum column width.

(5) **MSL rating/Peak reflow:** The moisture sensitivity level ratings and peak solder (reflow) temperatures. In the event that a part has multiple moisture sensitivity ratings, only the lowest level per JEDEC standards is shown. Refer to the shipping label for the actual reflow temperature that will be used to mount the part to the printed circuit board.

(6) **Part marking:** There may be an additional marking, which relates to the logo, the lot trace code information, or the environmental category of the part.

Multiple part markings will be inside parentheses. Only one part marking contained in parentheses and separated by a "-" will appear on a part. If a line is indented then it is a continuation of the previous line and the two combined represent the entire part marking for that device.

Important Information and Disclaimer: The information provided on this page represents TI's knowledge and belief as of the date that it is provided. TI bases its knowledge and belief on information provided by third parties, and makes no representation or warranty as to the accuracy of such information. Efforts are underway to better integrate information from third parties. TI has taken and continues to take reasonable steps to provide representative and accurate information but may not have conducted destructive testing or chemical analysis on incoming materials and chemicals. TI and TI suppliers consider certain information to be proprietary, and thus CAS numbers and other limited information may not be available for release.

In no event shall TI's liability arising out of such information exceed the total purchase price of the TI part(s) at issue in this document sold by TI to Customer on an annual basis.

TAPE AND REEL INFORMATION



QUADRANT ASSIGNMENTS FOR PIN 1 ORIENTATION IN TAPE



*All dimensions are nominal

Device	Package Type	Package Drawing	Pins	SPQ	Reel Diameter (mm)	Reel Width W1 (mm)	A0 (mm)	B0 (mm)	K0 (mm)	P1 (mm)	W (mm)	Pin1 Quadrant
TLV75801PDBVJ	SOT-23	DBV	5	8000	330.0	8.4	3.2	3.2	1.4	4.0	8.0	Q3
TLV75801PDBVR	SOT-23	DBV	5	3000	178.0	8.4	3.2	3.2	1.4	4.0	8.0	Q3
TLV75801PDBVR	SOT-23	DBV	5	3000	180.0	8.4	3.2	3.2	1.4	4.0	8.0	Q3
TLV75801PDBVT	SOT-23	DBV	5	250	180.0	8.4	3.2	3.2	1.4	4.0	8.0	Q3
TLV75801PDBVT	SOT-23	DBV	5	250	178.0	9.0	3.3	3.2	1.4	4.0	8.0	Q3
TLV75801PDRVR	WSON	DRV	6	3000	180.0	8.4	2.3	2.3	1.15	4.0	8.0	Q2
TLV75801PDRVR	WSON	DRV	6	3000	178.0	8.4	2.25	2.25	1.0	4.0	8.0	Q2
TLV75801PDRVRG4	WSON	DRV	6	3000	180.0	8.4	2.3	2.3	1.15	4.0	8.0	Q2
TLV75801PDRVT	WSON	DRV	6	250	180.0	8.4	2.3	2.3	1.15	4.0	8.0	Q2

TAPE AND REEL BOX DIMENSIONS

*All dimensions are nominal

Device	Package Type	Package Drawing	Pins	SPQ	Length (mm)	Width (mm)	Height (mm)
TLV75801PDBVJ	SOT-23	DBV	5	8000	360.0	360.0	36.0
TLV75801PDBVR	SOT-23	DBV	5	3000	208.0	191.0	35.0
TLV75801PDBVR	SOT-23	DBV	5	3000	210.0	185.0	35.0
TLV75801PDBVT	SOT-23	DBV	5	250	210.0	185.0	35.0
TLV75801PDBVT	SOT-23	DBV	5	250	180.0	180.0	18.0
TLV75801PDRVR	WSON	DRV	6	3000	210.0	185.0	35.0
TLV75801PDRVR	WSON	DRV	6	3000	205.0	200.0	33.0
TLV75801PDRVRG4	WSON	DRV	6	3000	210.0	185.0	35.0
TLV75801PDRVT	WSON	DRV	6	250	210.0	185.0	35.0

EXAMPLE BOARD LAYOUT

DBV0005A

SOT-23 - 1.45 mm max height

SMALL OUTLINE TRANSISTOR



LAND PATTERN EXAMPLE
EXPOSED METAL SHOWN
SCALE:15X



SOLDER MASK DETAILS

4214839/K 08/2024

NOTES: (continued)

- 6. Publication IPC-7351 may have alternate designs.
- 7. Solder mask tolerances between and around signal pads can vary based on board fabrication site.

EXAMPLE STENCIL DESIGN

DBV0005A

SOT-23 - 1.45 mm max height

SMALL OUTLINE TRANSISTOR



SOLDER PASTE EXAMPLE
BASED ON 0.125 mm THICK STENCIL
SCALE:15X

4214839/K 08/2024

NOTES: (continued)

8. Laser cutting apertures with trapezoidal walls and rounded corners may offer better paste release. IPC-7525 may have alternate design recommendations.
9. Board assembly site may have different recommendations for stencil design.

GENERIC PACKAGE VIEW

DRV 6

WSON - 0.8 mm max height

PLASTIC SMALL OUTLINE - NO LEAD



Images above are just a representation of the package family, actual package may vary.
Refer to the product data sheet for package details.

4206925/F



4222173/C 11/2025

NOTES:

1. All linear dimensions are in millimeters. Any dimensions in parenthesis are for reference only. Dimensioning and tolerancing per ASME Y14.5M.
2. This drawing is subject to change without notice.
3. The package thermal pad must be soldered to the printed circuit board for thermal and mechanical performance.
4. Minimum 0.1 mm solder wetting on pin side wall. Available for wettable flank version only.

EXAMPLE STENCIL DESIGN

DRV0006A

WSON - 0.8 mm max height

PLASTIC SMALL OUTLINE - NO LEAD



SOLDER PASTE EXAMPLE
BASED ON 0.125 mm THICK STENCIL

EXPOSED PAD #7
88% PRINTED SOLDER COVERAGE BY AREA UNDER PACKAGE
SCALE:30X

4222173/C 11/2025

NOTES: (continued)

7. Laser cutting apertures with trapezoidal walls and rounded corners may offer better paste release. IPC-7525 may have alternate design recommendations.

重要なお知らせと免責事項

TI は、技術データと信頼性データ (データシートを含みます)、設計リソース (リファレンス デザインを含みます)、アプリケーションや設計に関する各種アドバイス、Web ツール、安全性情報、その他のリソースを、欠陥が存在する可能性のある「現状のまま」提供しており、商品性および特定目的に対する適合性の黙示保証、第三者の知的財産権の非侵害保証を含むいかなる保証も、明示的または黙示的にかかわらず拒否します。

これらのリソースは、TI 製品を使用する設計の経験を積んだ開発者への提供を意図したものです。(1) お客様のアプリケーションに適した TI 製品の選定、(2) お客様のアプリケーションの設計、検証、試験、(3) お客様のアプリケーションに該当する各種規格や、その他のあらゆる安全性、セキュリティ、規制、または他の要件への確実な適合に関する責任を、お客様のみが単独で負うものとし、

上記の各種リソースは、予告なく変更される可能性があります。これらのリソースは、リソースで説明されている TI 製品を使用するアプリケーションの開発の目的でのみ、TI はその使用をお客様に許諾します。これらのリソースに関して、他の目的で複製することや掲載することは禁止されています。TI や第三者の知的財産権のライセンスが付与されている訳ではありません。お客様は、これらのリソースを自身で使用した結果発生するあらゆる申し立て、損害、費用、損失、責任について、TI およびその代理人を完全に補償するものとし、TI は一切の責任を拒否します。

TI の製品は、[TI の販売条件](#)、[TI の総合的な品質ガイドライン](#)、[ti.com](#) または TI 製品などに関連して提供される他の適用条件に従い提供されます。TI がこれらのリソースを提供することは、適用される TI の保証または他の保証の放棄の拡大や変更を意味するものではありません。TI がカスタム、またはカスタマー仕様として明示的に指定していない限り、TI の製品は標準的なカタログに掲載される汎用機器です。

お客様がいかなる追加条項または代替条項を提案する場合も、TI はそれらに異議を唱え、拒否します。

Copyright © 2026, Texas Instruments Incorporated

最終更新日 : 2025 年 10 月