

TPS566235 4.5V~18V 入力、6A、同期整流降圧型コンバータ

1 特長

- 入力電圧範囲: 4.5V~18V
- 出力電圧範囲: 0.6V~7V
- 室温で $\pm 1\%$ 精度の基準電圧
- 6A の連続出力電流をサポート
- D-CAP3™アーキテクチャ制御による高速過渡応答
- $R_{DS(on)}$ が 25m Ω および 12m Ω の内蔵パワー FET
- 108 μ A の低い静止電流
- MODE ピンで Eco-Mode™、Out-Of-Audio™、FCCM を選択可能
- Out-Of-Audio™軽負荷動作、25kHz を超えるスイッチング周波数
- プリバイアス付きスタートアップ機能をサポート
- 600kHz のスイッチング周波数
- 1ms のソフト・スタート機能を内蔵
- セラミック出力コンデンサに対応
- パワー・グッド・インジケータ
- サイクル単位のバレー過電流保護
- 非ラッチ型 OC、OV、UV、OT、UVLO 保護
- 3.00mm x 2.0mm の HotRod™ VQFN パッケージ
- WEBENCH® Power Designer により、TPS566235 を使用するカスタム設計を作成

2 アプリケーション

- DTV および STB
- スイッチャおよびルータ
- サーバーおよびエンタープライズ SSD
- 監視用およびシングル・ボード・コンピュータ
- 分散電源システム

3 概要

TPS566235 は FET を内蔵し、コスト効率が高く、高い入力電圧に対応した、高効率の同期整流降圧型コンバータです。このデバイスを採用することで、各種機器の電源バス・レギュレータに対して、コスト効果が高く、部品数の少ない、低スタンバイ電流のソリューションを実現できます。

TPS566235 は、高速な過渡応答と優れたライン/負荷レギュレーションを外付け補償部品なしで実現する D-CAP3™モード制御を採用しています。また本デバイスは、特殊ポリマーなどの低 ESR (等価直列抵抗) 出力コンデンサと超低 ESR セラミック・コンデンサの両方をサポートできる独自の回路も備えています。この制御トポロジにより、重負荷条件での CCM モードと軽負荷条件での DCM モードの間をシームレスに移行できます。軽負荷時の動作は、MODE ピンにより Eco-Mode™、Out-Of-Audio™ (OOA)、強制連続導通モード (FCCM) の 3 モードに構成できます。OOA モードは、効率の低下を最小限に抑えながら、スイッチング周波数を可聴周波数より高く維持する独自の制御機能です。

TPS566235 は、プリバイアス付きのスタートアップと、パワー・グッド・インジケータをサポートしています。OVP、UVP、OCP、OTP、UVLO を含む完全な保護機能を備えています。このデバイスは 3.0mm x 2.0mm の HotRod™ パッケージで供給され、-40°C~125°C の接合部温度で動作が規定されています。

製品情報⁽¹⁾

型番	パッケージ	本体サイズ(公称)
TPS566235	VQFN (13)	3.00mmx2.00mm

(1) 利用可能なすべてのパッケージについては、このデータシートの末尾にある注文情報を参照してください。

代表的なアプリケーション

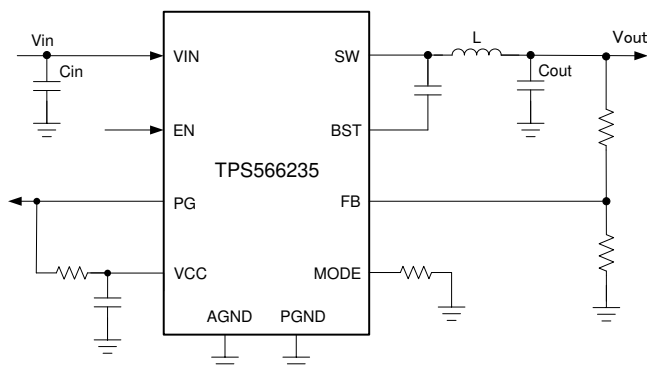

効率と出力電流との関係、Eco-mode

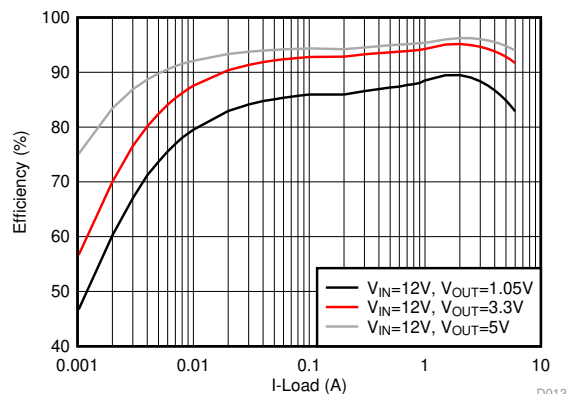

D013



目次

1	特長	1	12.4	Device Functional Modes	12
2	アプリケーション	1	13	Application and Implementation	15
3	概要	1	13.1	Application Information	15
4	改訂履歴	2	13.2	Typical Application	15
5	Pin Configuration and Functions	3	14	Power Supply Recommendations	19
6	Specifications	4	15	Layout	20
7	Absolute Maximum Ratings	4	15.1	Layout Guidelines	20
8	ESD Ratings	4	15.2	Layout Example	20
9	Recommended Operating Conditions	4	16	デバイスおよびドキュメントのサポート	21
10	Thermal Information	5	16.1	デバイス・サポート	21
11	Electrical Characteristics	5	16.2	ドキュメントの更新通知を受け取る方法	21
11.1	Typical Characteristics	7	16.3	コミュニティ・リソース	21
12	Detailed Description	10	16.4	商標	21
12.1	Overview	10	16.5	静電気放電に関する注意事項	21
12.2	Functional Block Diagram	10	16.6	Glossary	22
12.3	Feature Description	11	17	メカニカル、パッケージ、および注文情報	22

4 改訂履歴

資料番号末尾の英字は改訂を表しています。その改訂履歴は英語版に準じています。

Revision A (April 2019) から Revision B に変更

Page

•	マーケティング・ステータスを「事前情報」から「初版」に変更	1
---	-------------------------------------	---

5 Pin Configuration and Functions

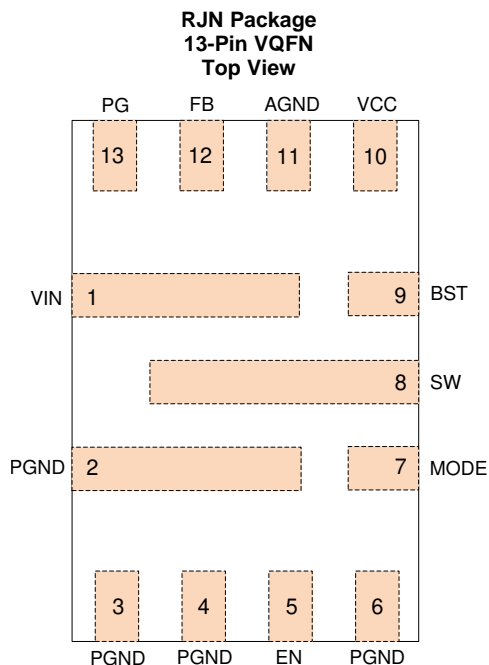

Pin Functions

PIN		I/O	DESCRIPTION
NAME	NO.		
VIN	1	P	Input voltage supply pin for the control circuitry. Connect the input decoupling capacitors between VIN and PGND.
PGND	2,3,4,6	G	Power GND terminal for the controller circuit and the internal circuitry.
EN	5	I	Enable pin of Buck converter. EN pin is a digital input pin, decides turn on/off Buck converter. Internal pull down current to disable converter if leave this pin open.
MODE	7	I	Eco-Mode™/OOA/FCCM Mode selection pin with external 1% resistor or connecting to VCC.
SW	8	O	Switching node connection to the output inductor and bootstrap capacitor.
BST	9	I	Supply input for the gate drive voltage of the high-side MOSFET. Connect the bootstrap capacitor between BST and SW, 0.1 uF is recommended.
VCC	10	P	Internal LDO output for control and driver. Decouple with a minimum 1 μF ceramic capacitor as close to VCC as possible.
AGND	11	G	Ground of internal analog circuitry. Connect AGND to GND plane with a short trace.
FB	12	I	Feedback sensing pin for Buck output voltage. Connect this pin to the resistor divider between output voltage and AGND.
PG	13	O	Open drain power good indicator. It is asserted low if output voltage is out of PG threshold, over voltage or if the device is under thermal shutdown, EN shutdown or during soft start.

6 Specifications

7 Absolute Maximum Ratings

over operating free-air temperature range (unless otherwise noted) ⁽¹⁾

		MIN	MAX	UNIT
Input voltage	VIN	-0.3	20	V
	BST – SW	-0.3	6	V
	BST	-0.3	25	V
	FB, EN, MODE	-0.3	6	V
	PGND, AGND	-0.3	0.3	V
Output voltage	SW	-0.3	20	V
	SW (10-ns transient)	-3.0	22	V
	PG	-0.3	6	V
T _J	Operating junction temperature	-40	150	°C
T _{stg}	Storage temperature	-55	150	°C

(1) Stresses beyond those listed under *Absolute Maximum Ratings* may cause permanent damage to the device. These are stress ratings only, which do not imply functional operation of the device at these or any other conditions beyond those indicated under *Recommended Operating Conditions*. Exposure to absolute-maximum-rated conditions for extended periods may affect device reliability.

8 ESD Ratings

		VALUE	UNIT
V _(ESD)	Electrostatic discharge		
	Human-body model (HBM), per ANSI/ESDA/JEDEC JS-001 ⁽¹⁾	±2000	V
Charged-device model (CDM), per JEDEC specification JESD22-C101 ⁽²⁾	±500		

(1) JEDEC document JEP155 states that 500-V HBM allows safe manufacturing with a standard ESD control process.

(2) JEDEC document JEP157 states that 250-V CDM allows safe manufacturing with a standard ESD control process.

9 Recommended Operating Conditions

over operating free-air temperature range (unless otherwise noted)

		MIN	MAX	UNIT
Input voltage	VIN	4.5	18	V
	BST – SW	-0.3	5.5	V
	BST	-0.3	23	V
	FB, EN, MODE	-0.3	5.5	V
	PGND, AGND	-0.3	0.3	V
Output voltage	SW	-0.3	18	V
	SW(10 ns transient)	-3.0	20	V
	PG, VCC	-0.3	5.5	V
I _{OUT}	Output current ⁽¹⁾		6	A
T _J	Operating junction temperature	-40	125	°C
T _{stg}	Storage temperature	-40	150	°C

(1) In order to be consistent with the TI reliability requirement of 100k Power-On-Hours at 105°C junction temperature, the output current should not exceed 6A continuously under 100% duty operation as to prevent electromigration failure in the solder. Higher junction temperature or longer power-on hours are achievable at lower than 6A continuous output current.

10 Thermal Information

THERMAL METRIC ⁽¹⁾		TPS566235	UNIT
		RJN (VQFN)	
		13 PINS	
$R_{\theta JA}$	Junction-to-ambient thermal resistance	70	°C/W
$R_{\theta JA_effective}$	Junction-to-ambient thermal resistance with TI EVM	34.8	°C/W
$R_{\theta JC(top)}$	Junction-to-case (top) thermal resistance	46.4	°C/W
$R_{\theta JB}$	Junction-to-board thermal resistance	22.1	°C/W
Ψ_{JT}	Junction-to-top characterization parameter	1.4	°C/W
Ψ_{JB}	Junction-to-board characterization parameter	22.4	°C/W
$R_{\theta JC(bot)}$	Junction-to-case (bottom) thermal resistance	N/A	°C/W

(1) For more information about traditional and new thermal metrics, see the *IC Package Thermal Metrics* application report, [SPRA953](#).

11 Electrical Characteristics

$T_j = -40^{\circ}\text{C}$ to 125°C , $V_{IN} = 12\text{ V}$, typical values are at $T_j = 25^{\circ}\text{C}$ (unless otherwise noted)

PARAMETER		TEST CONDITIONS	MIN	TYP	MAX	UNIT
INPUT SUPPLY VOLTAGE						
V_{IN}	Input Voltage Range		4.5		18	V
I_{VIN}	VIN Supply Current	$V_{EN} = 3.3\text{V}$, Non Switching		108		μA
I_{VINDN}	VIN Shutdown Current	$V_{EN} = 0\text{V}$		3		μA
VCC OUTPUT						
V_{CC}	VCC Output Voltage	$V_{IN} > 5.0\text{V}$	4.75	4.83	4.92	V
		$V_{IN} = 4.5$, no Load	4.3	4.5		V
I_{VCC}	VCC Current Limit		20			mA
FEEDBACK VOLTAGE						
V_{FB}	V_{FB} Voltage	$T_j = 25^{\circ}\text{C}$	594	600	606	mV
		$T_j = -40$ to 125°C	591	600	609	mV
UVLO						
UVLO	VIN Under-Voltage Lockout	Wake up VIN voltage		4.2	4.4	V
		Shut down VIN voltage	3.6	3.7		V
		Hysteresis VIN voltage		500		mV
LOGIC THRESHOLD						
$V_{EN(ON)}$	EN Threshold High-level		1.22	1.32	1.42	V
$V_{EN(OFF)}$	EN Threshold Low-level		1.04	1.12	1.20	V
I_{EN}	EN Pull Down Current	$V_{EN} = 0.8\text{V}$		2		μA
I_{MODE}	MODE Sourcing Current			5		μA

Electrical Characteristics (continued)
 $T_j = -40^{\circ}\text{C}$ to 125°C , $V_{IN} = 12\text{ V}$, typical values are at $T_j = 25^{\circ}\text{C}$ (unless otherwise noted)

PARAMETER		TEST CONDITIONS	MIN	TYP	MAX	UNIT
MOSFET						
$R_{DS(ON)H}$	High Side MOSFET $R_{ds(on)}$			25		$\text{m}\Omega$
$R_{DS(ON)L}$	Low Side MOSFET $R_{ds(on)}$			12		$\text{m}\Omega$
DUTY CYCLE and FREQUENCY CONTROL						
F_{SW}	Switching Frequency			600		kHz
T_{MIN_ON}	Minimum On-time			50		ns
T_{MIN_OFF}	Minimum Off-time				200	ns
OOA Function						
T_{OOA}	Mode Operation Period			32		μs
SOFT START						
T_{SS}	Soft Start Time			1		ms
POWER GOOD						
$T_{PGDLYLH}$	PG Low to High Delay	PG from low to high		160		μs
$T_{PGDLYHL}$	PG High to Low Delay	PG from high to low		32		μs
V_{PGTH}	PG Threshold	V_{FB} falling (fault)		85		%
		V_{FB} rising (good)		90		%
		V_{FB} rising (fault)		115		%
		V_{FB} falling (good)		110		%
I_{PGSK}	PG Sink Current	$V_{PG} = 0.5\text{V}$		52		mA
I_{PGLK}	PG Leak Current	$V_{PG} = 5.5\text{V}$			1	μA
CURRENT LIMIT						
I_{OCL}	Over Current Threshold	Valley current set point	6.6	7.6	8.6	A
I_{NOCL}	Negative Over Current Threshold			3.4		A
OUTPUT UNDERVOLTAGE AND OVERVOLTAGE PROTECTION						
V_{OVP}	OVP Trip Threshold	V_{FB} rising (fault)		125		%
		V_{FB} falling (good)		120		%
t_{OVDPDY}	OVP Prop Deglitch			32		μs
V_{UVP}	UVP Trip Threshold	V_{FB} falling (fault)		60		%
		V_{FB} rising (good)		65		%
t_{UVPDLY}	UVP Prop Deglitch			256		μs
THERMAL PROTECTION						
T_{OTP}	OTP Trip Threshold ⁽¹⁾			150		$^{\circ}\text{C}$
T_{OTPHYS}	OTP Hysteresis ⁽¹⁾			20		$^{\circ}\text{C}$

(1) Not production tested

11.1 Typical Characteristics

$T_J = -40^\circ\text{C}$ to 125°C , $V_{IN} = 12\text{V}$ (unless otherwise noted)

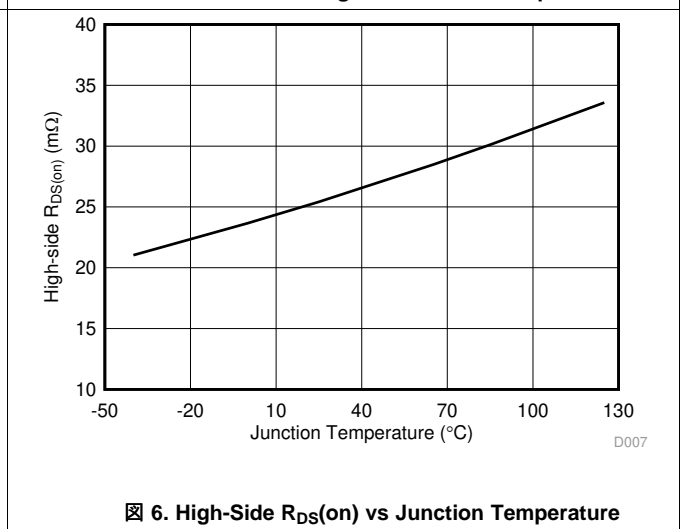
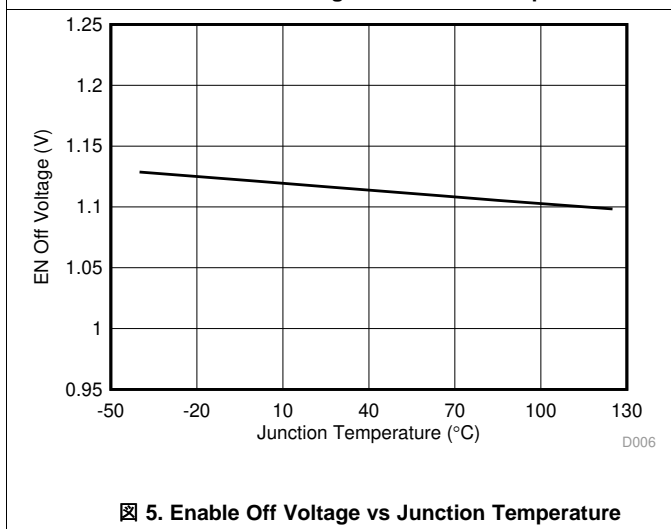
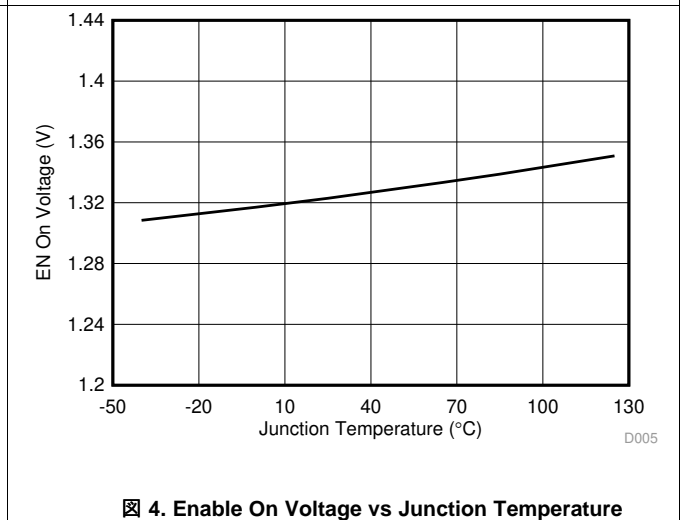
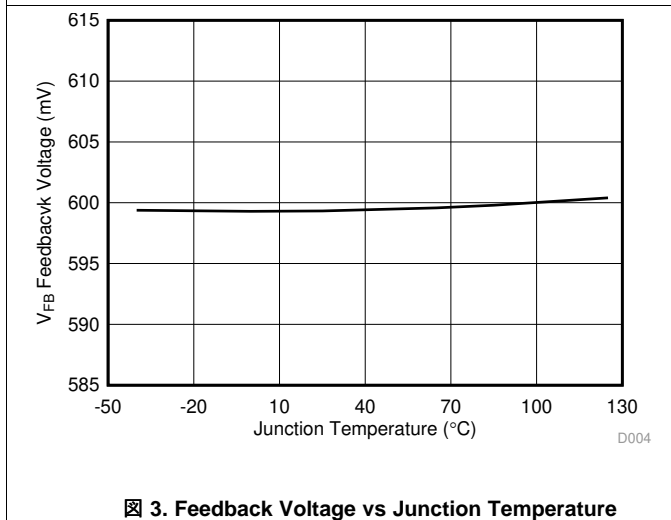
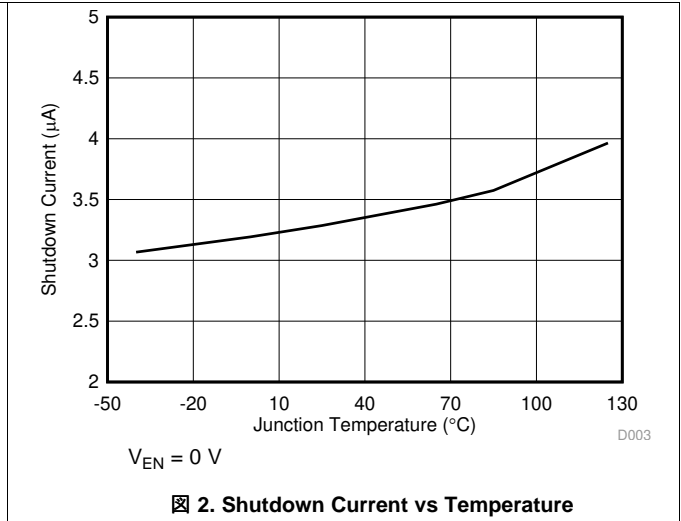
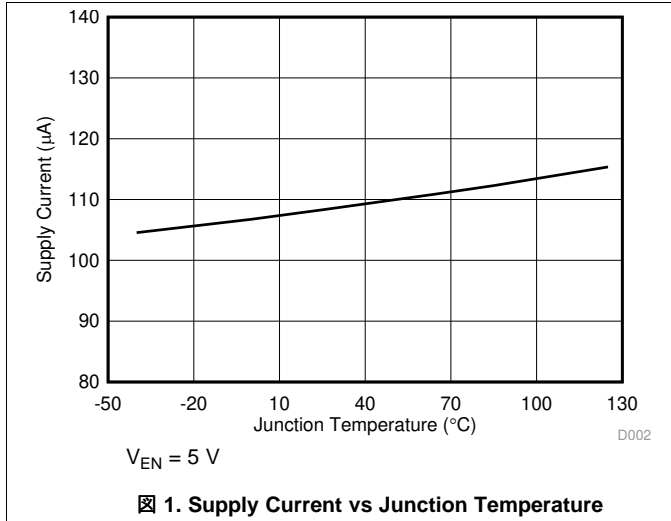

Typical Characteristics (continued)

$T_J = -40^{\circ}\text{C}$ to 125°C , $V_{IN} = 12\text{V}$ (unless otherwise noted)

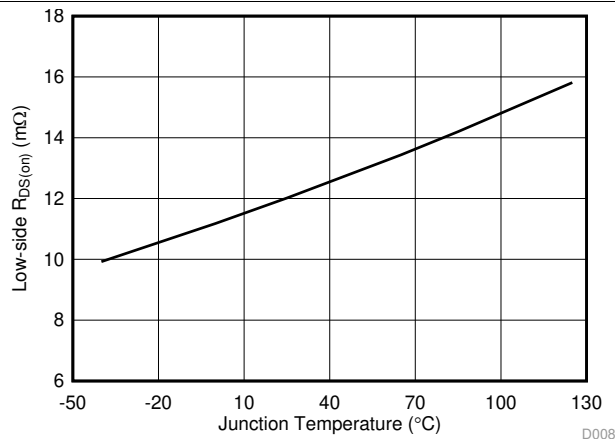

Figure 7. Low-Side $R_{DS(on)}$ vs Junction Temperature

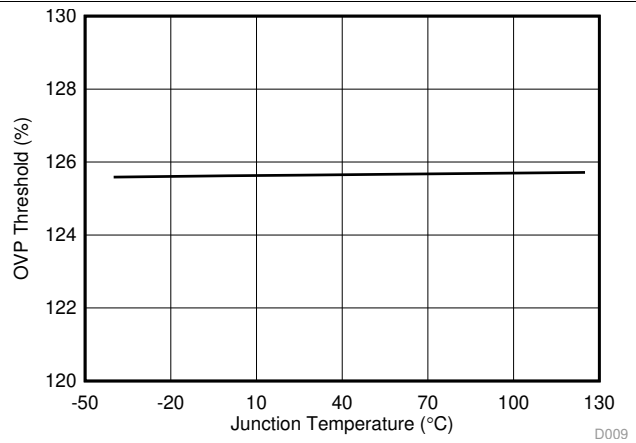

Figure 8. OVP Threshold vs Junction Temperature

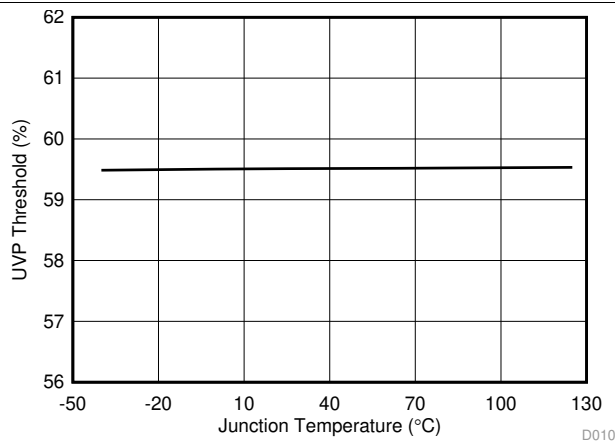

Figure 9. UVP Threshold vs Junction Temperature

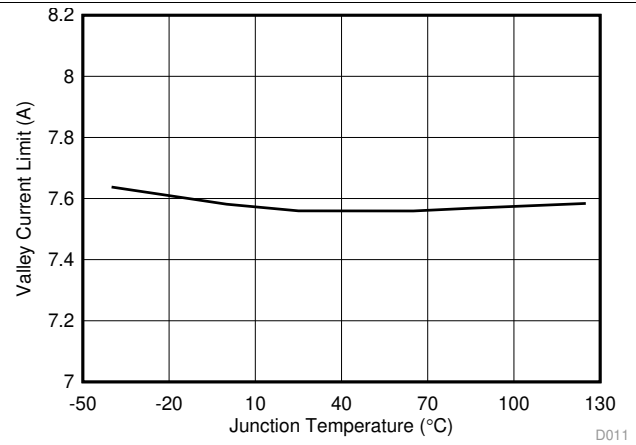

Figure 10. Valley Current Limit vs Junction Temperature

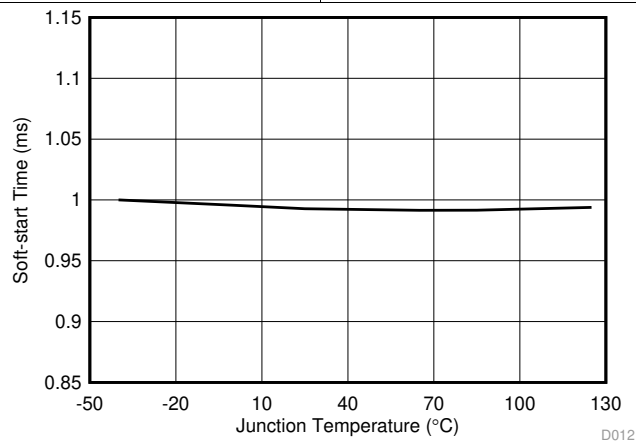
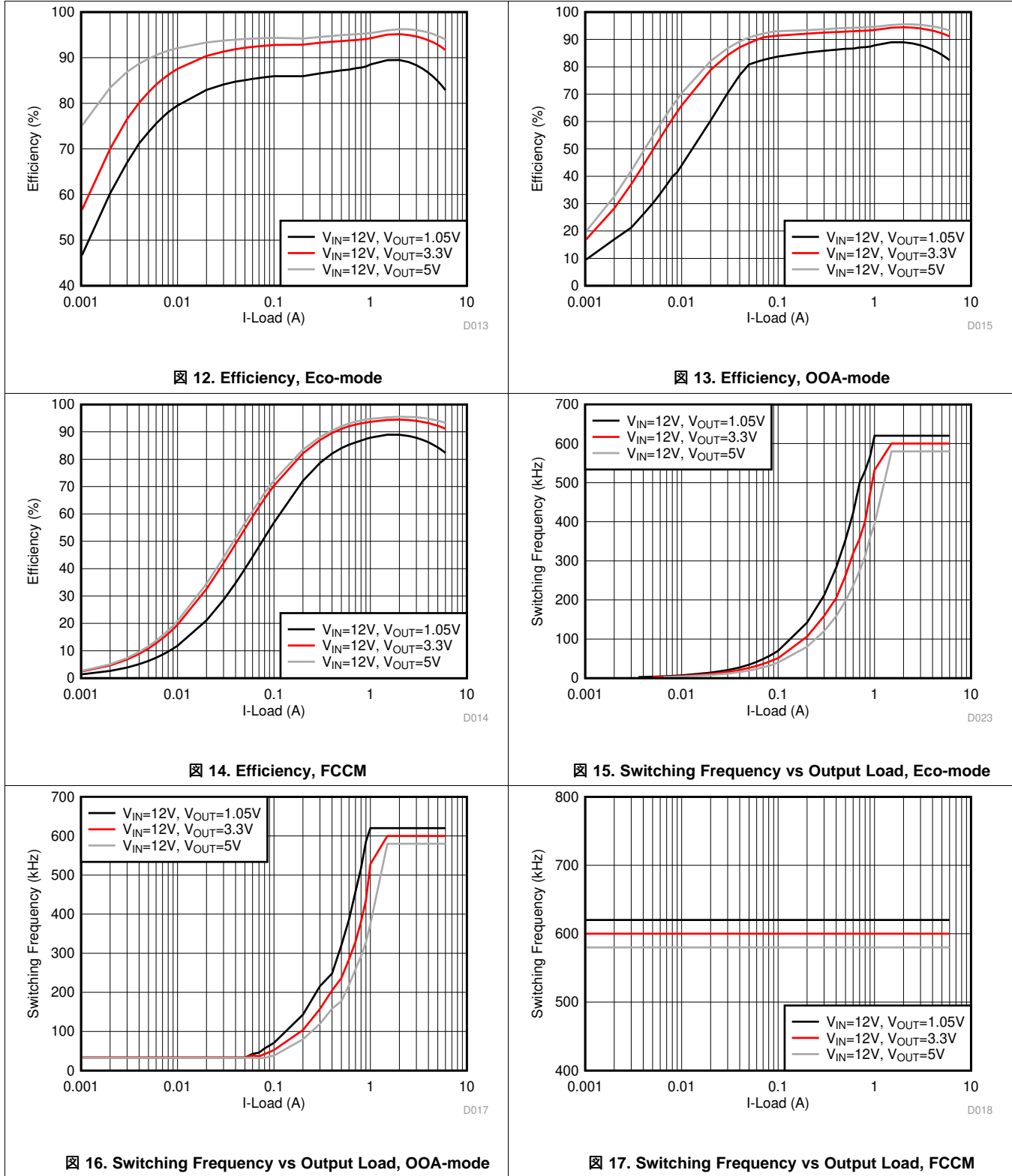

Figure 11. Soft-Start Time vs Junction Temperature

Typical Characteristics (continued)

$T_J = -40^{\circ}\text{C}$ to 125°C , $V_{IN} = 12\text{V}$ (unless otherwise noted)



12 Detailed Description

12.1 Overview

The TPS566235 is high density synchronous Buck converter which operates from 4.5 V to 18 V input voltage (V_{IN}), and the output range is from 0.6 V to 7 V. It has 25-m Ω and 12-m Ω integrated MOSFETs that enable high efficiency up to 6 A. The proprietary D-CAP3™ mode enables low external component count, ease of design, optimization of the power design for cost, size and efficiency. The TPS566235 has ultra-low quiescent current (ULQ™) mode. This feature is beneficial for long battery life in system standby mode. The device employs D-CAP3™ mode control that provides fast transient response with no external compensation components. The control topology supports seamless transition between CCM mode at heavy load conditions and DCM operation at light load conditions. There are three operation modes can be configured by MODE pin at light load: Eco-Mode™, OOA and FCCM. Eco-Mode™ allows the TPS566235 to maintain high efficiency at light load. OOA mode makes switching frequency above audible frequency (25kHz), even there is no loading at output side. FCCM mode has the constant switching frequency at both light and heavy load. TPS566235 are able to adapt to both low equivalent series resistance (ESR) output capacitors such as POSCAP or SP-CAP, and ultra-low ESR ceramic capacitors.

12.2 Functional Block Diagram

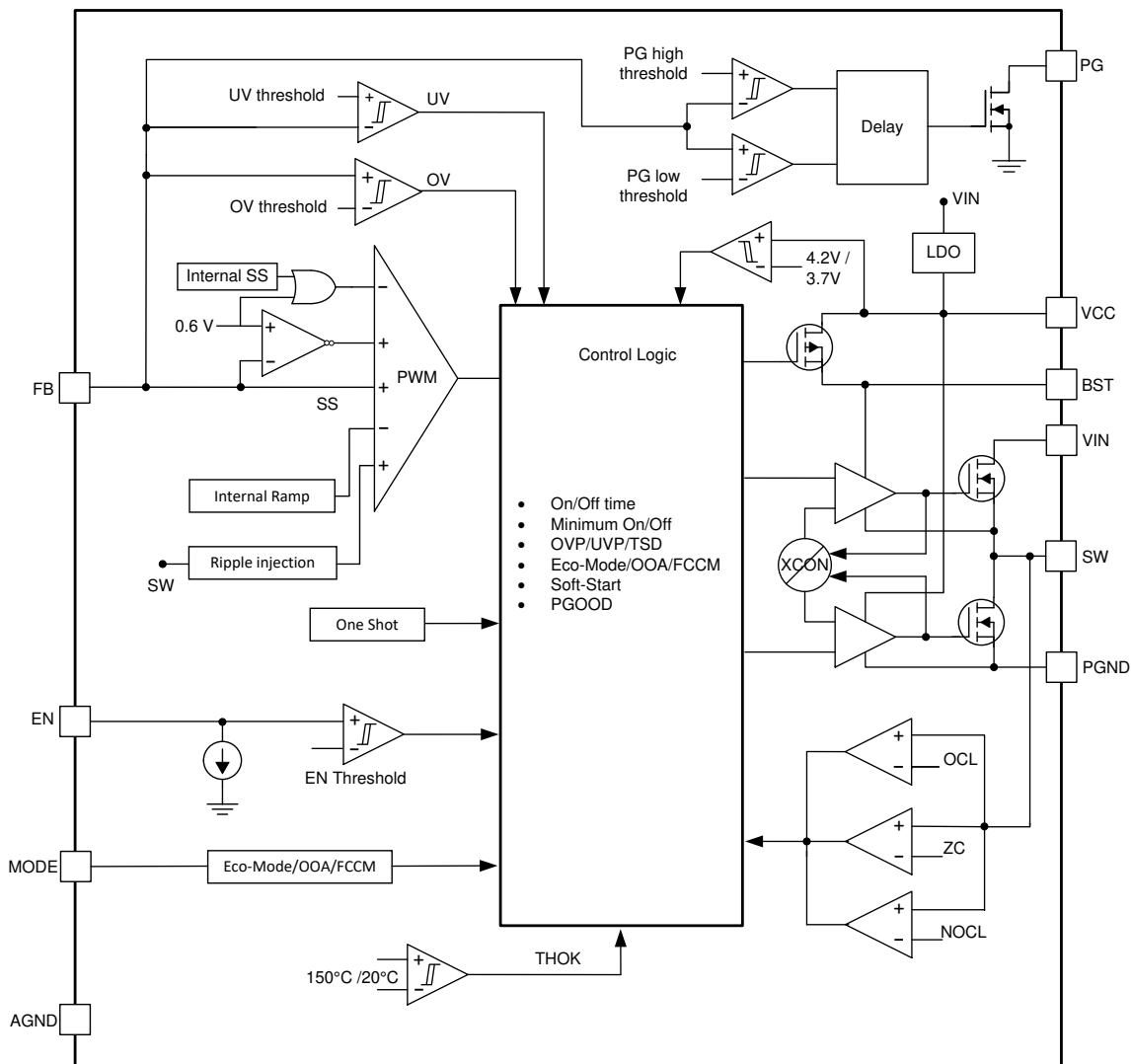

12.3 Feature Description

12.3.1 PWM Operation and D-CAP3™ Control

The main control loop of the Buck is adaptive on-time pulse width modulation (PWM) controller that supports a proprietary D-CAP3™ mode control. The D-CAP3™ mode control combines adaptive on-time control with an internal compensation circuit for pseudo-fixed frequency and low external component count configuration with both low-ESR and ceramic output capacitors. It is stable even with virtually no ripple at the output. The TPS566235 also includes an error amplifier that makes the output voltage very accurate.

At the beginning of each cycle, the high-side MOSFET is turned on. This MOSFET is turned off after internal one-shot timer expires. This one-shot duration is set proportional to the output voltage, V_{OUT} , and it is inversely proportional to the converter input voltage, V_{IN} , to maintain a pseudo-fixed frequency over the input voltage range, hence it is called adaptive on-time control. The one-shot timer is reset and the high-side MOSFET is turned on again when the feedback voltage falls below the reference voltage. An internal ripple generation circuit is added to reference voltage for emulating the output ripple, this enables the use of very low-ESR output capacitors such as multi-layered ceramic caps (MLCC). No external current sense network or loop compensation is required for D-CAP3™ control topology.

For any control topology that is compensated internally, there is a range of the output filter it can support. The output filter used with the TPS566235 is a low-pass L-C circuit. This L-C filter has a double-pole frequency described in 式 1.

$$f_p = \frac{1}{2 \times \pi \times \sqrt{L_{OUT} \times C_{OUT}}} \quad (1)$$

At low frequency, the overall loop gain is set by the output set-point resistor divider network and the internal gain of the TPS566235. The low-frequency L-C double pole has a 180 degree drop in phase. At the output filter frequency, the gain rolls off at a -40 dB per decade rate and the phase drops rapidly. The internal ripple generation network introduces a high-frequency zero that reduces the gain roll off from -40 dB to -20 dB per decade and leads the 90 degree phase boost. The internal ripple injection high-frequency zero is related to the switching frequency. The crossover frequency of the overall system should usually be targeted to be less than one-third of the switching frequency (F_{SW}).

12.3.2 Power Good

The Power Good (PG) pin is an open drain output. Once the FB pin voltage is between 90% and 110% of the internal reference voltage ($V_{REF}=0.6V$), the PG is de-asserted and floats after a 160 μs de-glitch time. A pull-up resistor of 100 k Ω is recommended to pull it up to VCC. The PG pin is pulled low when the FB pin voltage is lower than 85% or greater than 115% threshold or in an event of thermal shutdown or during the soft-start period. PG de-glitch time (from high to low) is 32 μs .

12.3.3 Soft Start and Pre-Biased Soft Start

The TPS566235 has an internal 1.0 ms soft-start time. Soft start can prevent the overshoot of output voltage during start up. When the EN pin becomes high, internal soft-start function begins ramping up the reference voltage to the PWM comparator.

The TPS566235 can prevent current from being pulled from the output during startup if the output is pre-biased. The device disables the switching of both the high-side and low-side FETs until the soft-start commands a voltage higher than the pre-bias level (internal soft start becomes greater than feedback voltage V_{FB}). Then, the controller start the first high side FET gate driver pulses. This scheme prevents the initial sinking of the pre-bias output, and ensure that the output voltage starts and ramps up into regulation and the control loop is given time to transition from pre-biased start-up to normal mode operation.

12.3.4 Over current Protection and Undervoltage Protection

The TPS566235 has the over current protection and undervoltage protection. The output over current limit (OCL) is implemented using a cycle-by-cycle valley detect circuit. The switch current is monitored during the OFF state by measuring the low-side FET drain to source voltage. This voltage is proportional to the switch current. To improve accuracy, the voltage sensing is temperature compensated.

Feature Description (continued)

During the on-time of the high-side FET switch, the switch current increases at a linear rate determined by V_{IN} , V_{OUT} , the on-time and the output inductor value. During the on-time of the low-side FET switch, this current decreases linearly. The average value of the switch current is the load current I_{OUT} . If the monitored current is above the OCL level, the converter maintains low-side FET on and delays the creation of a new set pulse, even the voltage feedback loop requires one, until the current level becomes OCL level or lower. In subsequent switching cycles, the on-time is set to a fixed value and the current is monitored in the same manner.

There are some important considerations for this type of over current protection. When the load current is higher than the over current threshold by one half of the peak-to-peak inductor ripple current, the OCL is triggered and the current is being limited, the output voltage tends to drop because the load demand is higher than what the converter can support. When the output voltage falls below 60% of the target voltage, the UVP comparator detects it, the device will shut off after a wait time of 256 μ s and then re-start after the hiccup time (typically $7 \times T_{SS}$). When the over current condition is removed, the output will be recovered.

12.3.5 Over Voltage Protection

TPS566235 has the over voltage protection function by monitoring the feedback voltage (V_{FB}). When the feedback voltage becomes higher than 125% of V_{REF} , the OVP comparator output goes high and turns off both high-side and low-side MOSFETs after a wait time of 32 μ s. This protection is a non-latching operation. The device re-starts switching when the feedback voltage falls below 120% of V_{REF} .

12.3.6 UVLO Protection

The undervoltage lockout (UVLO) protection monitors the VCC pin voltage to protect the internal circuitry from low input voltages. When the voltage is lower than UVLO threshold voltage, the under-voltage lockout circuit prevents mis-operation of the device by turning off both high-side and low-side MOSFETs. The converter begins operation again when the input voltage exceeds the threshold by a hysteresis of 500 mV (typical). This is a non-latch protection.

12.3.7 Thermal Shutdown

The device monitors the internal die temperature. If it exceeds the thermal shutdown threshold value (typically 150°C), the device shuts off. This is a non-latch protection.

12.4 Device Functional Modes

12.4.1 Light Load Operation

TPS566235 has a MODE pin which can setup three different modes of operation for light load running. The light load operation mode includes Eco-Mode™, Out-Of-Audio™ mode and FCCM mode.

12.4.2 MODE Pin Configuration

TPS566235 detect the voltage on the MODE pin during start-up and latches onto one of the MODE options listed below in 表 1. TPS566235 internally has a comparator to compare this voltage with reference voltage and decide which mode to choose. The voltage on the MODE pin can be set by connecting to VCC pin or connecting a resistor R_M between this pin and AGND. There is a source current of 5 μ A at the mode pin and generate voltage for mode selection to avoid noise and spurious trigger. The V_{MODE} voltage range and recommended resistor value is shown in 表 1. The MODE pin setting can be reset only by VIN power cycling or EN toggle.

表 1. Mode Pin Settings

V_{MODE}	0-0.3 V	0.3 V-1.2 V	>1.2 V
Recommended Resistor	0 Ω	100 k Ω -150 k Ω	To VCC (recommend) or $R_M > 400k\Omega$
Operating Mode	Eco-Mode™	OOA	FCCM

Figure 18 shows the typical start-up sequence of the device once the enable signal crosses the EN turn on threshold (V_{IN} is higher than UVLO threshold). After the voltage on VCC crosses the rising UVLO threshold, it takes about 60 μ s to read the mode setting. The output voltage starts ramping after 10 μ s from the mode reading is done.

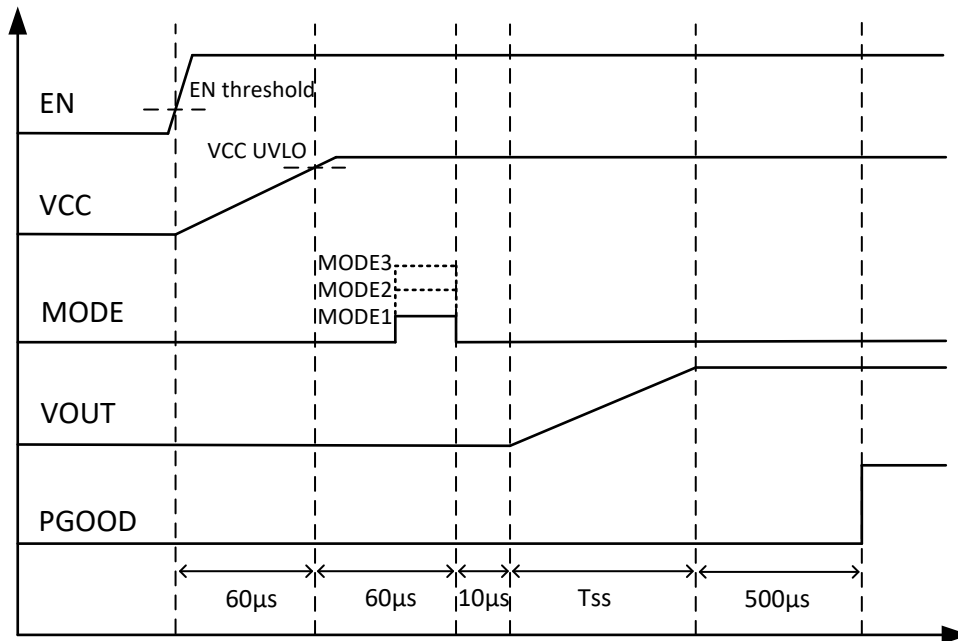

Figure 18. Start-Up Sequence

12.4.3 Advanced Eco-Mode™ Control

The advanced Eco-Mode™ control scheme to maintain high efficiency at light loads. As the output current decreases from heavy load conditions, the inductor current is also reduced and eventually comes to a point where the rippled valley touches zero level, which is the boundary between continuous conduction and discontinuous conduction modes. The low-side MOSFET is turned off when a zero inductor current is detected. As the load current further decreases, the converter runs into discontinuous conduction mode so that it takes more time to discharge the output to the level of reference voltage with a smaller load current. The light load current where the transition to Eco-Mode™ operation happens ($I_{OUT(LL)}$) can be calculated from Equation 2.

$$I_{OUT(LL)} = \frac{1}{2 \times L_{OUT} \times F_{SW}} \times \frac{(V_{IN} - V_{OUT}) \times V_{OUT}}{V_{IN}} \quad (2)$$

After identifying the application requirements, design the output inductance (L_{OUT}) so that the inductor peak-to-peak ripple current is approximately between 20% and 30% of the $I_{OUT(max)}$ (peak current in the application).

12.4.4 Out-Of-Audio™ Mode

Out-Of-Audio™ (OOA) light-load mode is a unique control feature that keeps the switching frequency above audible frequency with minimum reduction in efficiency. It prevents audio noise generation from the output capacitors and inductor. During Out-of-Audio operation, the OOA control circuit monitors the states of both high-side and low-side MOSFETs and forces them switching if both MOSFETs are off for more than 32 μ s. When both high-side and low-side MOSFETs are off for more than 32 μ s during a light-load condition, the low side FET will discharge until reverse OC happens or output voltage drops to trigger the high-side FET on.

If the MODE pin is selected to operate in OOA mode, when the device works at light load, the minimum switching frequency is above 25 kHz which avoids the audible noise in the system.

12.4.5 Force CCM Mode

Force CCM (FCCM) mode keeps the converter to operate in continuous conduction mode during light-load conditions and allows the inductor current to become negative. During FCCM mode, the switching frequency (F_{SW}) is maintained at an almost constant level over the entire load range, which is suitable for applications requiring tight control of the switching frequency and output voltage ripple at the cost of lower efficiency under light load.

12.4.6 Standby Operation

The TPS566235 can be placed in standby mode by pulling the EN pin low. The device operates with a shutdown current of 3 μ A when in standby condition. EN pin is pulled low internally when it is floating and the device is disabled by default.

13 Application and Implementation

注

Information in the following application sections is not part of the TI component specification, and TI does not warrant its accuracy or completeness. TI's customers are responsible for determining suitability of components for their purposes. Customers should validate and test their design implementation to confirm system functionality.

13.1 Application Information

The schematic of [Figure 19](#) shows a typical application for TPS566235. This design converts an input voltage range of 4.5 V to 18 V down to 1.05 V with a maximum output current of 6 A.

13.2 Typical Application

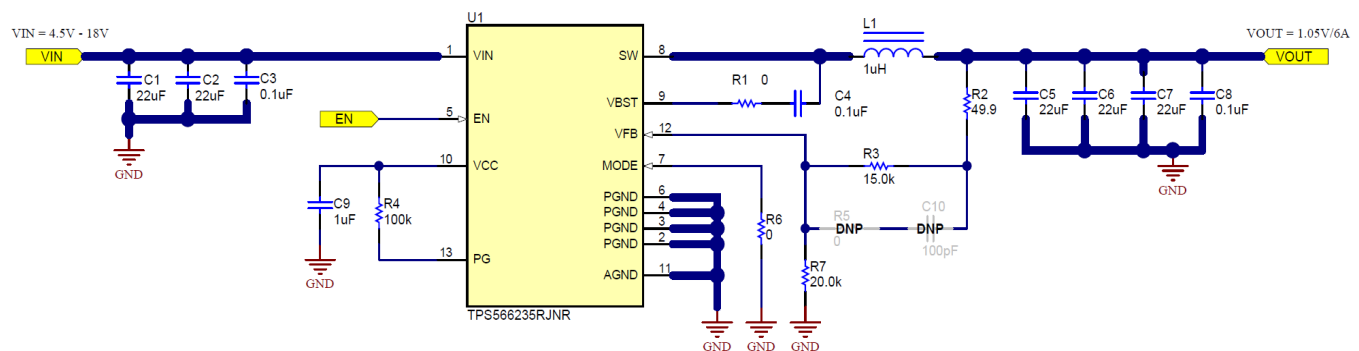

Figure 19. Application Schematic

13.2.1 Design Requirements

Table 2. Design Parameters

PARAMETER	CONDITIONS	MIN	TYP	MAX	UNIT
V_{OUT}	Output voltage		1.05		V
I_{OUT}	Output current		6		A
ΔV_{OUT}	Transient response	I_{OUT} : 10%-90%, 2.5A/ μ s		$\pm 5\% \times V_{OUT}$	
V_{IN}	Input voltage	4.5	12	18	V
$V_{OUT(ripple)}$	Output voltage ripple			$2\% \times V_{OUT}$	
F_{SW}	Switching frequency			600	kHz
	Light load operation mode			Eco-Mode™	
T_A	Ambient temperature			25	°C

13.2.2 Detailed Design Procedure

13.2.2.1 Custom Design With WEBENCH® Tools

[Click here](#) to create a custom design using the TPS566235 device with the WEBENCH® Power Designer.

1. Start by entering the input voltage (V_{IN}), output voltage (V_{OUT}), and output current (I_{OUT}) requirements.
2. Optimize the design for key parameters such as efficiency, footprint, and cost using the optimizer dial.
3. Compare the generated design with other possible solutions from Texas Instruments.

The WEBENCH Power Designer provides a customized schematic along with a list of materials with real-time pricing and component availability.

In most cases, these actions are available:

- Run electrical simulations to see important waveforms and circuit performance

- Run thermal simulations to understand board thermal performance
- Export customized schematic and layout into popular CAD formats
- Print PDF reports for the design, and share the design with colleagues

Get more information about WEBENCH tools at www.ti.com/WEBENCH.

13.2.2.2 Inductor Selection

The inductor ripple current is filtered by the output capacitor. A higher inductor ripple current means the output capacitor should have a ripple current rating higher than the inductor ripple current. See 表 3 for recommended inductor values.

The RMS and peak currents through the inductor can be calculated using 式 3 and 式 4. It is important that the inductor is rated to handle these currents.

$$I_{L(\text{rms})} = \sqrt{I_{\text{OUT}}^2 + \frac{1}{12} \times \left(\frac{V_{\text{OUT}} \times (V_{\text{IN}(\text{max})} - V_{\text{OUT}})}{V_{\text{IN}(\text{max})} \times L_{\text{OUT}} \times F_{\text{SW}}} \right)^2} \quad (3)$$

$$I_{L(\text{peak})} = I_{\text{OUT}} + \frac{I_{\text{OUT}(\text{ripple})}}{2} \quad (4)$$

During transient/short circuit conditions the inductor current can increase up to the current limit of the device so it is safe to choose an inductor with a saturation current higher than the peak current under current limit condition.

13.2.2.3 Output Capacitor Selection

After selecting the inductor the output capacitor needs to be optimized. In D-CAP3™, the regulator reacts within one cycle to the change in the duty cycle so the good transient performance can be achieved without needing large amounts of output capacitance. The recommended output capacitance range is given in 表 3

Ceramic capacitors have very low ESR, otherwise the maximum ESR of the capacitor should be less than $V_{\text{OUT}(\text{ripple})}/I_{\text{OUT}(\text{ripple})}$

表 3. Recommended Component Values

V _{OUT} (V)	R _{LOWER} (kΩ)	R _{UPPER} (kΩ)	L _{OUT} (μH)			C _{OUT} (μF)		C _{FF} (pF)	
			MIN	TYP	MAX	MIN	MAX	MIN	MAX
1	20	13.3	0.68	1	4.7	44	110	-	-
1.05	20	15	0.68	1	4.7	44	110	-	-
1.2	20	20	1	1.2	4.7	44	110	-	-
1.5	20	30	1	1.2	4.7	44	110	-	-
1.8	20	40	1.2	1.5	4.7	44	110	-	-
2.5	20	63.3	1.5	2.2	4.7	44	110	-	-
3.3	20	90	1.5	2.2	4.7	44	110	10	220
5	20	146.6	1.5	2.2	4.7	44	110	10	220

13.2.2.4 Input Capacitor Selection

The minimum input capacitance required is given in 式 5.

$$C_{\text{IN}(\text{min})} = \frac{I_{\text{OUT}} \times V_{\text{OUT}}}{V_{\text{IN}(\text{ripple})} \times V_{\text{IN}} \times F_{\text{SW}}} \quad (5)$$

TI recommends using a high quality X5R or X7R input decoupling capacitors of 44 μF on the input voltage pin. The voltage rating on the input capacitor must be greater than the maximum input voltage. The capacitor must also have a ripple current rating greater than the maximum input current ripple of the application. The input ripple current is calculated by 式 6 below:

$$I_{\text{CIN}(\text{rms})} = I_{\text{OUT}} \times \sqrt{\frac{V_{\text{OUT}}}{V_{\text{IN}(\text{min})}} \times \frac{(V_{\text{IN}(\text{min})} - V_{\text{OUT}})}{V_{\text{IN}(\text{min})}}} \quad (6)$$

13.2.3 Application Curves

Figure 20 through Figure 35 applies to the circuit of Figure 19. $V_{IN} = 12\text{ V}$, $T_J = 25^\circ\text{C}$ (unless otherwise specified)

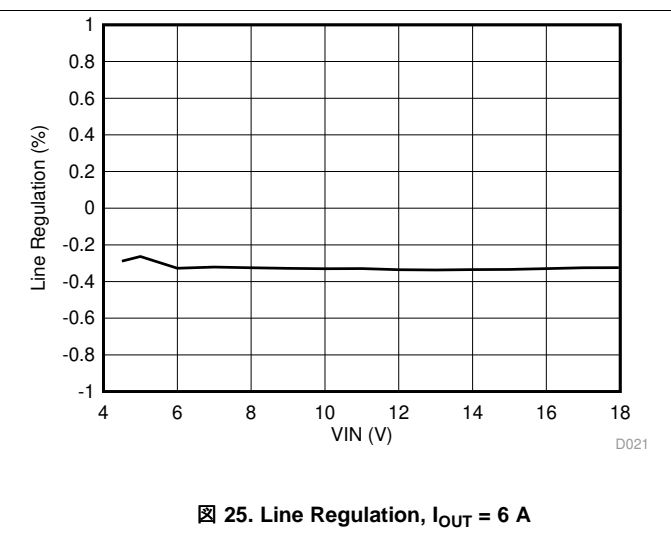
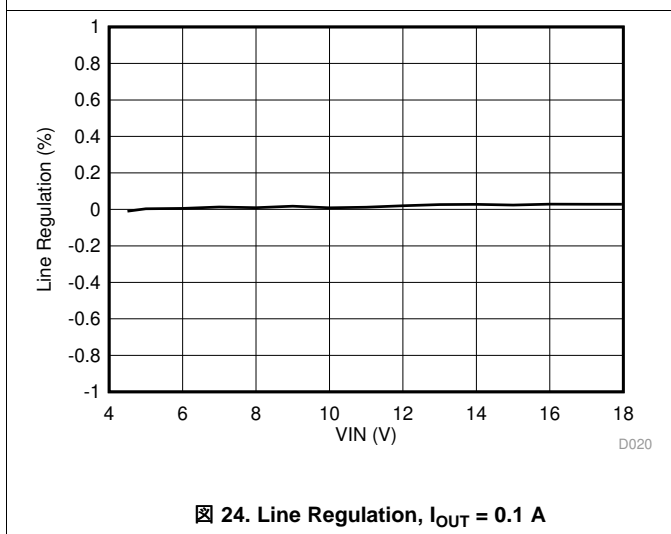
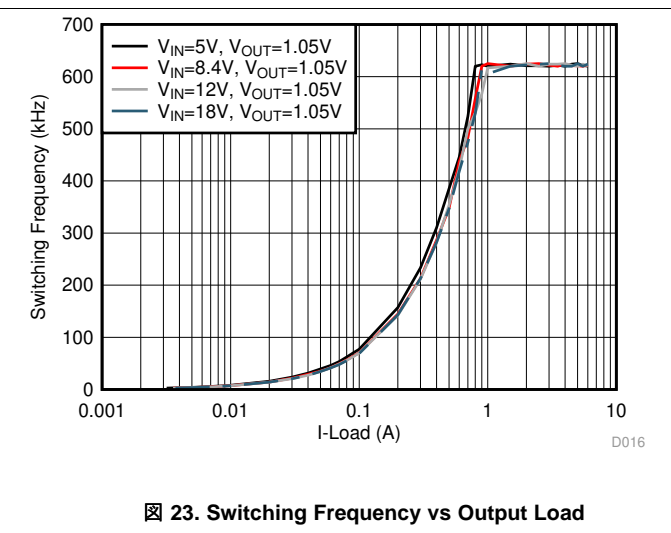
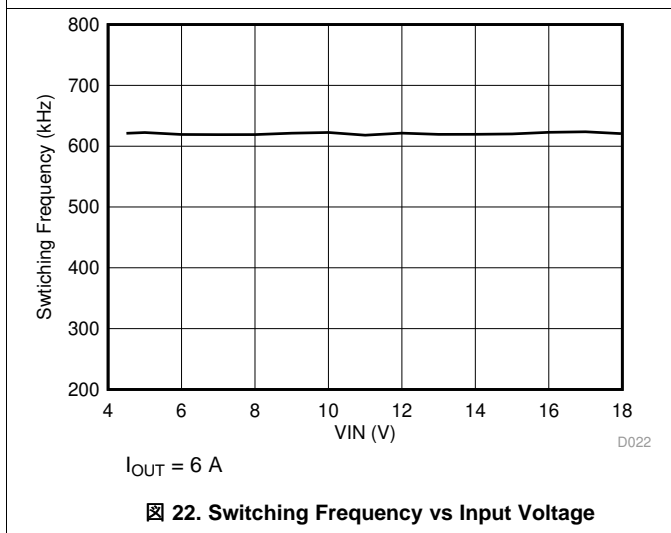
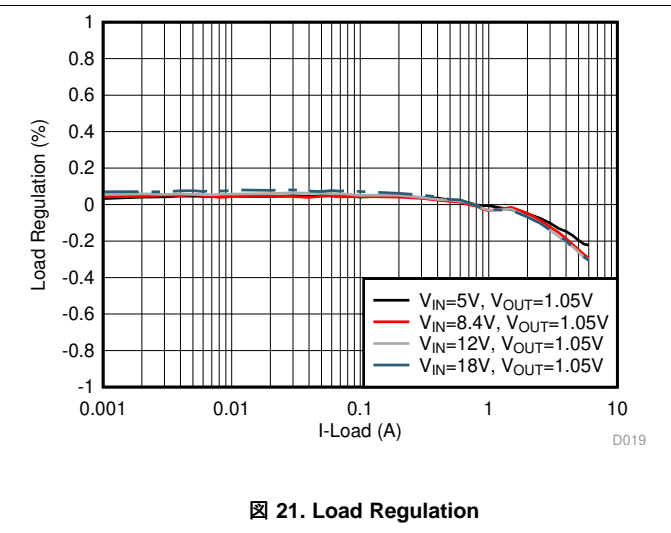
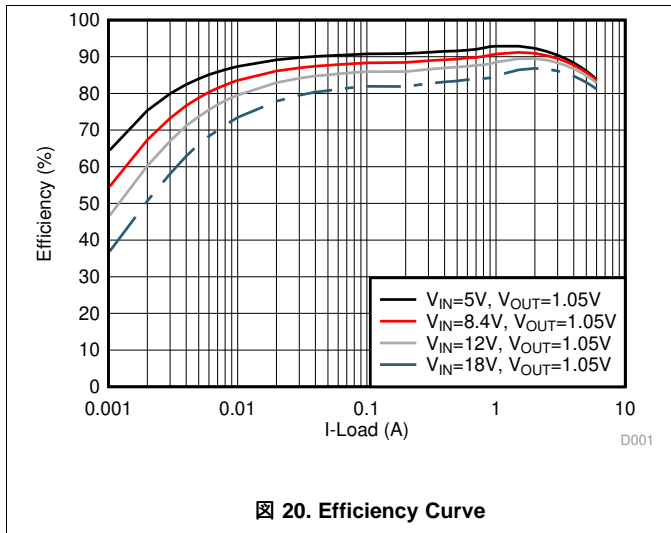

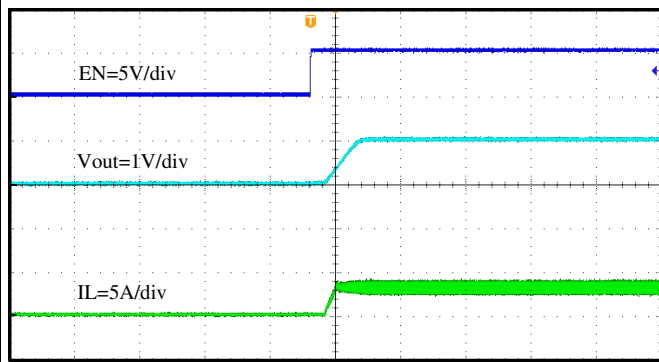

2ms/div

图 26. Start-Up Through EN, $I_{OUT} = 3\text{ A}$

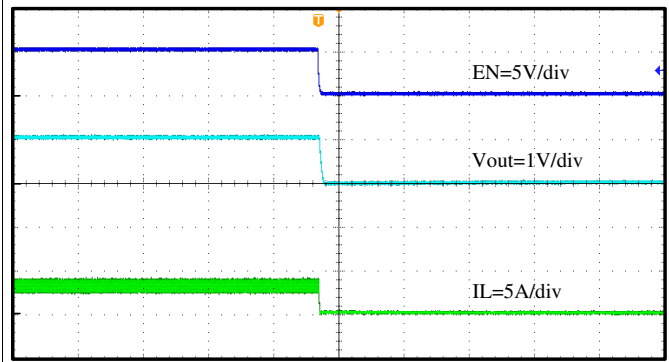

400µs/div

图 27. Shut-down Through EN, $I_{OUT} = 3\text{ A}$

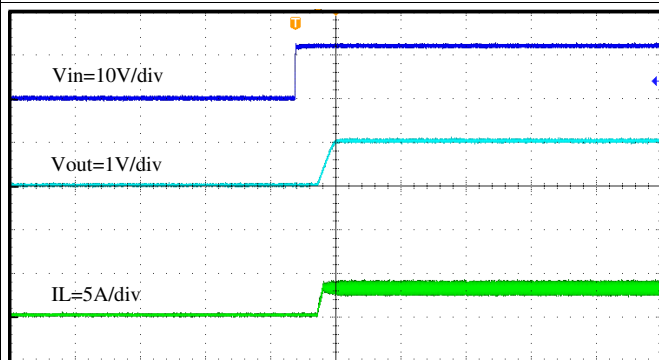

4ms/div

图 28. Start Up Relative to V_{IN} Rising, $I_{OUT} = 3\text{ A}$

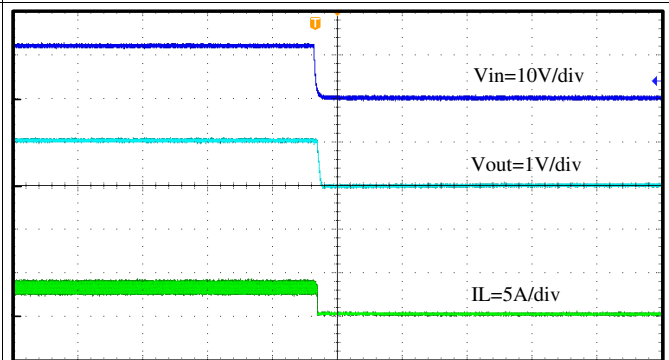

400µs/div

图 29. Start Up Relative to V_{IN} Falling, $I_{OUT} = 3\text{ A}$

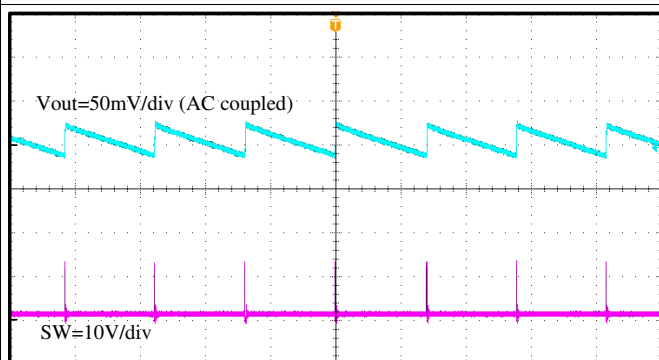

100µs/div

图 30. Output Voltage Ripple, $I_{OUT} = 0.01\text{ A}$

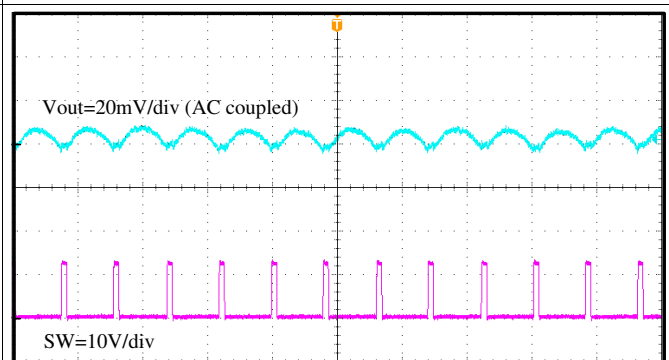

2µs/div

图 31. Output Voltage Ripple, $I_{OUT} = 6\text{ A}$

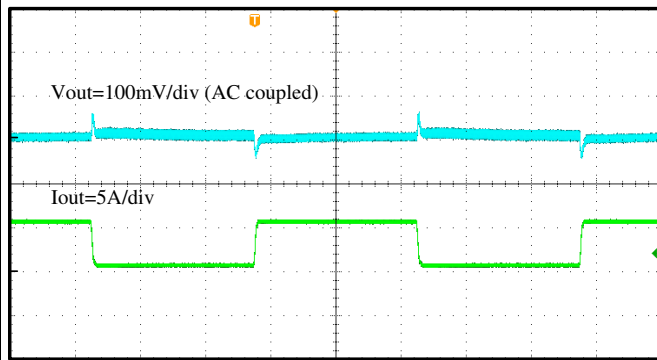

Slew Rate=2.5A/ μ s
200 μ s/div

⊗ 32. Transient Response, 0.6 A to 5.4 A

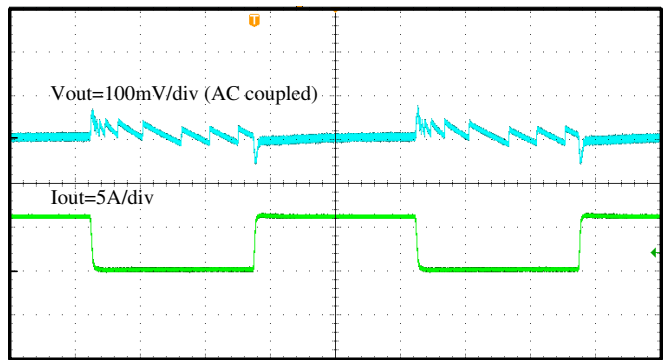

Slew Rate=2.5A/ μ s
200 μ s/div

⊗ 33. Transient Response, 0 A to 6 A

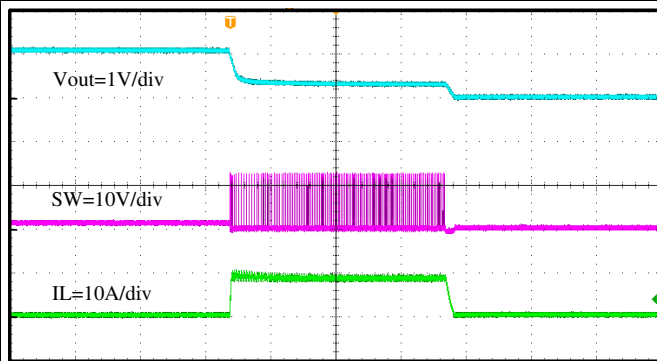

80 μ s/div

⊗ 34. Normal Operation to Output Hard Short

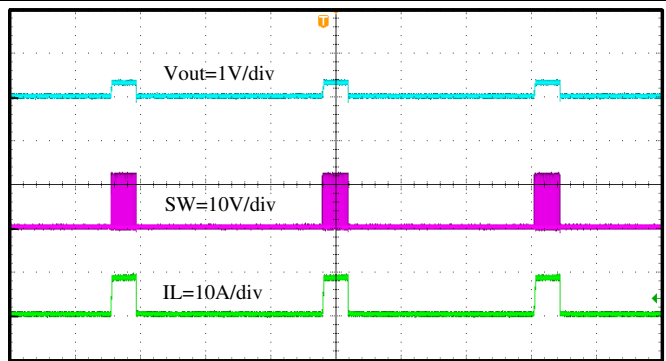

4ms/div

⊗ 35. Output Hard Short Hiccup

14 Power Supply Recommendations

The TPS566235 is intended to be powered by a well regulated dc voltage. The input voltage range is 4.5 V to 18 V. TPS566235 is Buck converter, the input supply voltage must be bigger than the desired output voltage for proper operation. Input supply current must be appropriate for the desired output current. If the input voltage supply is located far from the TPS566235 circuit, some additional input bulk capacitance is recommended. Typical values are 100 μ F to 470 μ F.

15 Layout

15.1 Layout Guidelines

When laying out the printed circuit board, the following guideline should be used to ensure proper operation of the IC. These items are also illustrated graphically in the layout diagram of [Figure 36](#)

- Recommend a four-layer PCB for good thermal performance and with maximum ground plane. 3" x 3", four-layer PCB with 2-oz. copper used as example.
- Place the decoupling capacitors right across VIN as close as possible.
- Place output inductors and capacitors with IC at the same layer, SW routing should be as short as possible to minimize EMI, and should be a wide plane to carry big current, enough vias should be added to the PGND connection of output capacitor and also as close to the output pin as possible.
- Place BST resistor and capacitor with IC at the same layer, close to BST and SW plane, >15 mil width trace is recommended to reduce line parasitic inductance.
- FB could be wide and must be routed away from the switching node, BST node or other high efficiency signal.
- VIN trace must be wide to reduce the trace impedance and provide enough current capability.
- Place multiple vias near GND and near input capacitors to reduce parasitic inductance and improve thermal performance.

15.2 Layout Example

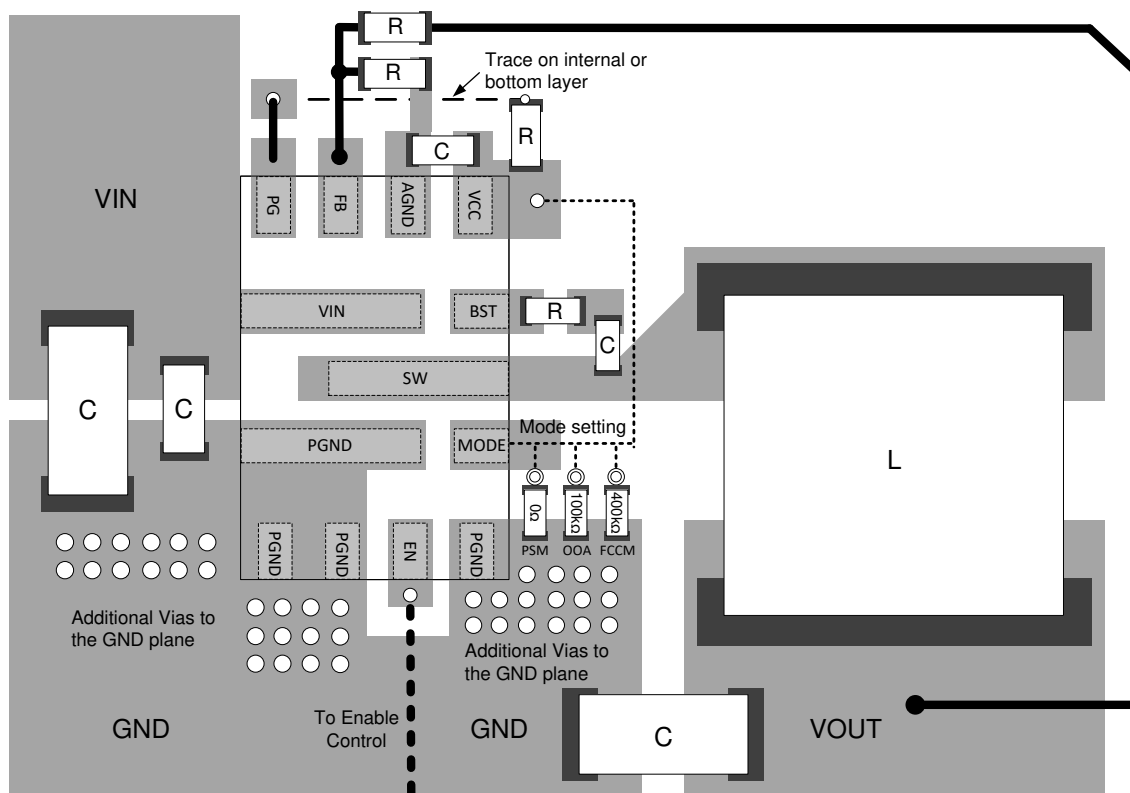

Figure 36. PCB Layout Recommendation Diagram

16 デバイスおよびドキュメントのサポート

16.1 デバイス・サポート

16.1.1 デベロッパー・ネットワークの製品に関する免責事項

デベロッパー・ネットワークの製品またはサービスに関するTIの出版物は、単独またはTIの製品、サービスと一緒に提供される場合に関係なく、デベロッパー・ネットワークの製品またはサービスの適合性に関する是認、デベロッパー・ネットワークの製品またはサービスの是認の表明を意味するものではありません。

16.1.2 開発サポート

16.1.2.1 WEBENCH®ツールによるカスタム設計

[ここをクリック](#)すると、WEBENCH® Power Designer により、TPS566235 デバイスを使用するカスタム設計を作成できます。

1. 最初に、入力電圧(V_{IN})、出力電圧(V_{OUT})、出力電流(I_{OUT})の要件を入力します。
2. オプティマイザのダイヤルを使用して、効率、占有面積、コストなどの主要なパラメータについて設計を最適化します。
3. 生成された設計を、テキサス・インスツルメンツが提供する他の方式と比較します。

WEBENCH Power Designerでは、カスタマイズされた回路図と部品リストを、リアルタイムの価格と部品の在庫情報と併せて参照できます。

通常、次の操作を実行可能です。

- 電氣的なシミュレーションを実行し、重要な波形と回路の性能を確認する。
- 熱シミュレーションを実行し、基板の熱特性を把握する。
- カスタマイズされた回路図やレイアウトを、一般的なCADフォーマットで出力する。
- 設計のレポートをPDFで印刷し、設計を共有する。

WEBENCHツールの詳細は、www.ti.com/WEBENCHでご覧になれます。

16.2 ドキュメントの更新通知を受け取る方法

ドキュメントの更新についての通知を受け取るには、ti.comのデバイス製品フォルダを開いてください。右上の「アラートを受け取る」をクリックして登録すると、変更されたすべての製品情報に関するダイジェストを毎週受け取れます。変更の詳細については、修正されたドキュメントに含まれている改訂履歴をご覧ください。

16.3 コミュニティ・リソース

The following links connect to TI community resources. Linked contents are provided "AS IS" by the respective contributors. They do not constitute TI specifications and do not necessarily reflect TI's views; see TI's [Terms of Use](#).

TI E2E™ Online Community *TI's Engineer-to-Engineer (E2E) Community*. Created to foster collaboration among engineers. At e2e.ti.com, you can ask questions, share knowledge, explore ideas and help solve problems with fellow engineers.

Design Support *TI's Design Support* Quickly find helpful E2E forums along with design support tools and contact information for technical support.

16.4 商標

D-CAP3, Eco-Mode, Out-Of-Audio, HotRod, Advanced Eco-Mode, E2E are trademarks of Texas Instruments. WEBENCH is a registered trademark of Texas Instruments.

16.5 静電気放電に関する注意事項



これらのデバイスは、限定的なESD(静電破壊)保護機能を内蔵しています。保存時または取り扱い時は、MOSゲートに対する静電破壊を防止するために、リード線同士をショートさせておくか、デバイスを導電フォームに入れる必要があります。

16.6 Glossary

[SLYZ022](#) — *TI Glossary*.

This glossary lists and explains terms, acronyms, and definitions.

17 メカニカル、パッケージ、および注文情報

以降のページには、メカニカル、パッケージ、および注文に関する情報が記載されています。この情報は、そのデバイスについて利用可能な最新のデータです。このデータは予告なく変更されることがあり、ドキュメントが改訂される場合もあります。本データシートのブラウザ版を使用されている場合は、画面左側の説明をご覧ください。

PACKAGING INFORMATION

Orderable Device	Status (1)	Package Type	Package Drawing	Pins	Package Qty	Eco Plan (2)	Lead finish/ Ball material (6)	MSL Peak Temp (3)	Op Temp (°C)	Device Marking (4/5)	Samples
TPS566235RJNR	ACTIVE	VQFN-HR	RJN	13	3000	RoHS & Green	Call TI SN NIPDAU	Level-2-260C-1 YEAR	-40 to 125	566235	Samples
TPS566235RJNT	ACTIVE	VQFN-HR	RJN	13	250	RoHS & Green	Call TI NIPDAU	Level-2-260C-1 YEAR	-40 to 125	566235	Samples

(1) The marketing status values are defined as follows:

ACTIVE: Product device recommended for new designs.

LIFEBUY: TI has announced that the device will be discontinued, and a lifetime-buy period is in effect.

NRND: Not recommended for new designs. Device is in production to support existing customers, but TI does not recommend using this part in a new design.

PREVIEW: Device has been announced but is not in production. Samples may or may not be available.

OBSOLETE: TI has discontinued the production of the device.

(2) **RoHS:** TI defines "RoHS" to mean semiconductor products that are compliant with the current EU RoHS requirements for all 10 RoHS substances, including the requirement that RoHS substance do not exceed 0.1% by weight in homogeneous materials. Where designed to be soldered at high temperatures, "RoHS" products are suitable for use in specified lead-free processes. TI may reference these types of products as "Pb-Free".

RoHS Exempt: TI defines "RoHS Exempt" to mean products that contain lead but are compliant with EU RoHS pursuant to a specific EU RoHS exemption.

Green: TI defines "Green" to mean the content of Chlorine (Cl) and Bromine (Br) based flame retardants meet JS709B low halogen requirements of <=1000ppm threshold. Antimony trioxide based flame retardants must also meet the <=1000ppm threshold requirement.

(3) MSL, Peak Temp. - The Moisture Sensitivity Level rating according to the JEDEC industry standard classifications, and peak solder temperature.

(4) There may be additional marking, which relates to the logo, the lot trace code information, or the environmental category on the device.

(5) Multiple Device Markings will be inside parentheses. Only one Device Marking contained in parentheses and separated by a "~" will appear on a device. If a line is indented then it is a continuation of the previous line and the two combined represent the entire Device Marking for that device.

(6) Lead finish/Ball material - Orderable Devices may have multiple material finish options. Finish options are separated by a vertical ruled line. Lead finish/Ball material values may wrap to two lines if the finish value exceeds the maximum column width.

Important Information and Disclaimer:The information provided on this page represents TI's knowledge and belief as of the date that it is provided. TI bases its knowledge and belief on information provided by third parties, and makes no representation or warranty as to the accuracy of such information. Efforts are underway to better integrate information from third parties. TI has taken and continues to take reasonable steps to provide representative and accurate information but may not have conducted destructive testing or chemical analysis on incoming materials and chemicals. TI and TI suppliers consider certain information to be proprietary, and thus CAS numbers and other limited information may not be available for release.

In no event shall TI's liability arising out of such information exceed the total purchase price of the TI part(s) at issue in this document sold by TI to Customer on an annual basis.

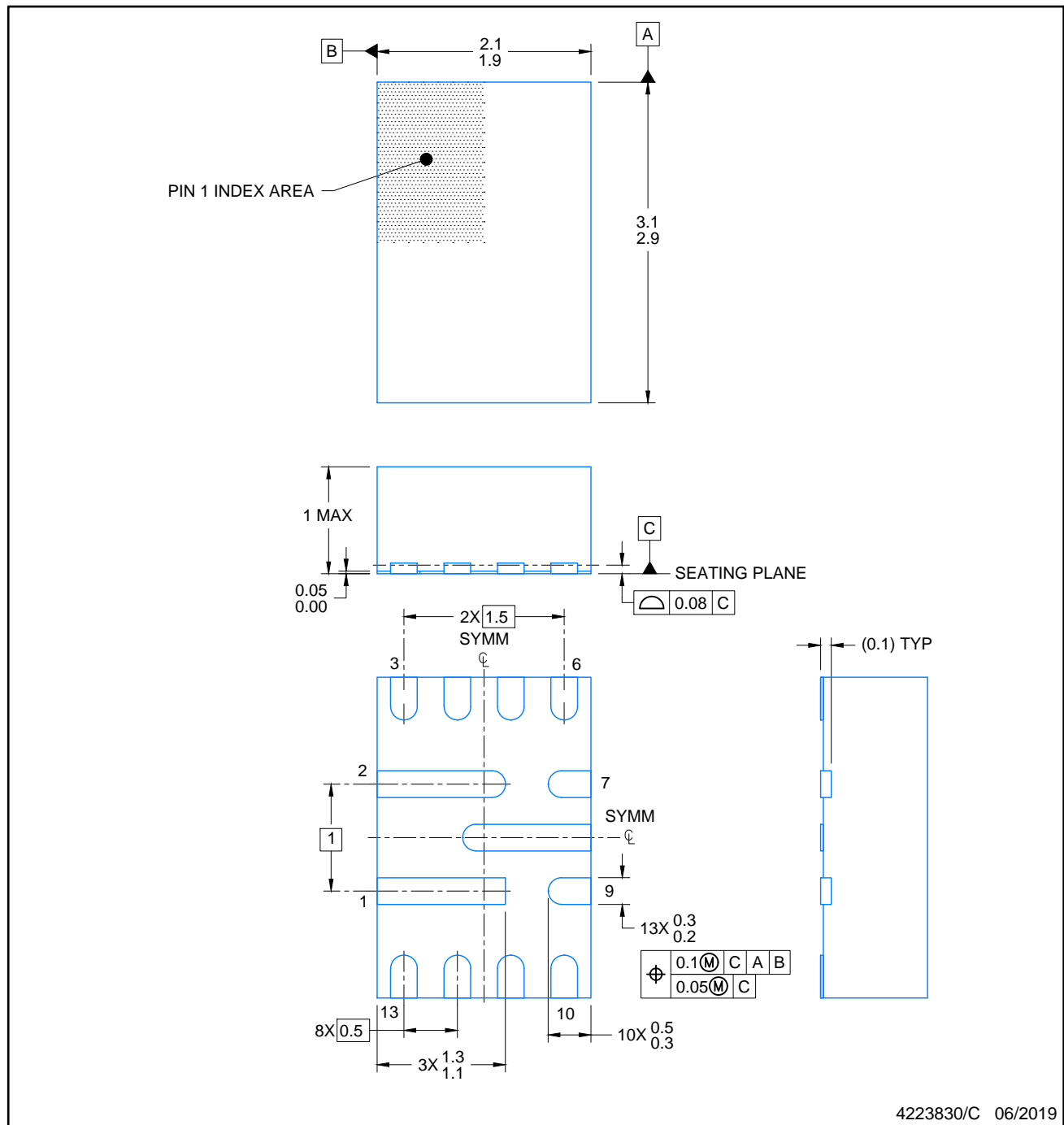

NOTES:

1. All linear dimensions are in millimeters. Any dimensions in parenthesis are for reference only. Dimensioning and tolerancing per ASME Y14.5M.
2. This drawing is subject to change without notice.

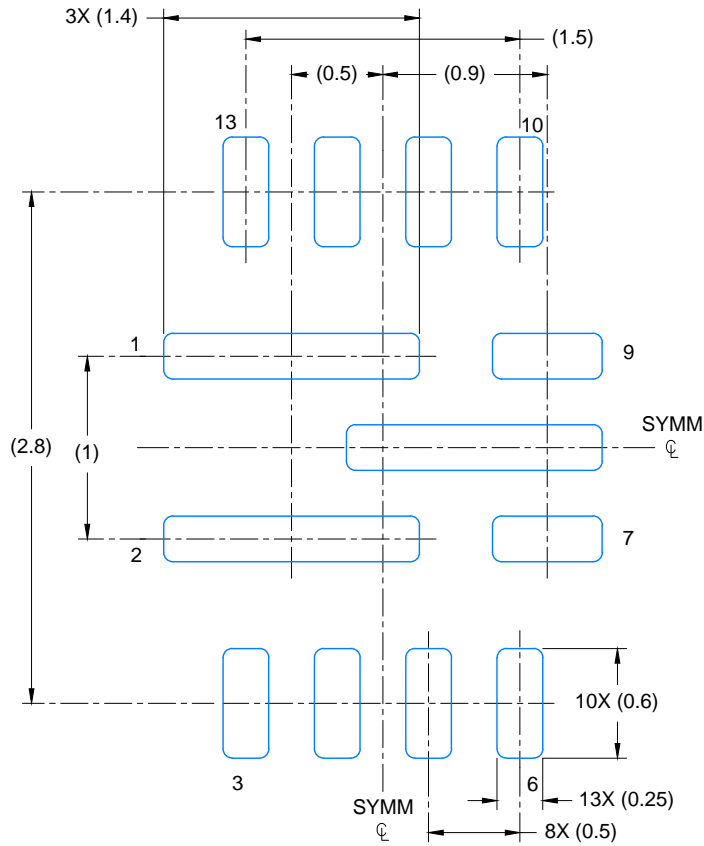

LAND PATTERN EXAMPLE
EXPOSED METAL SHOWN
SCALE: 25X

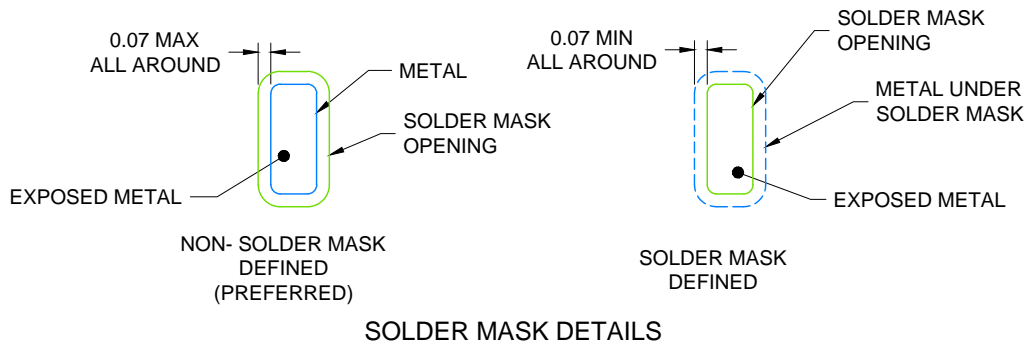

4223830/C 06/2019

NOTES: (continued)

- For more information, see Texas Instruments literature number SLUA271 (www.ti.com/lit/sluea271).

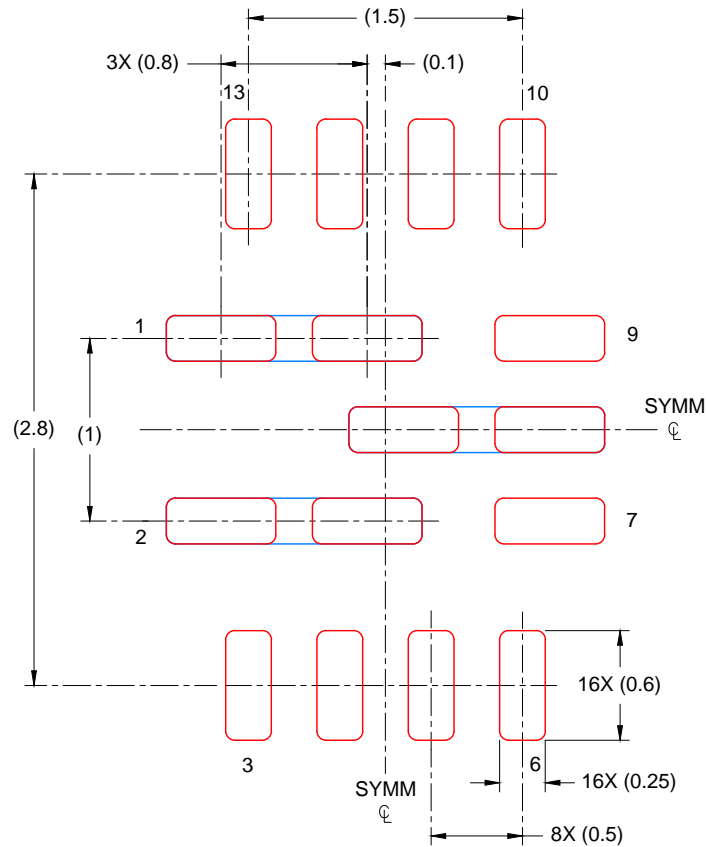

SOLDER PASTE EXAMPLE
 BASED ON 0.1mm THICK STENCIL

EXPOSED PAD
 86% PRINTED COVERAGE BY AREA
 SCALE: 25X

NOTES: (continued)

4. Laser cutting apertures with trapezoidal walls and rounded corners may offer better paste release. IPC-7525 may have alternate design recommendations.

重要なお知らせと免責事項

テキサス・インスツルメンツは、技術データと信頼性データ(データシートを含みます)、設計リソース(リファレンス デザインを含みます)、アプリケーションや設計に関する各種アドバイス、Web ツール、安全性情報、その他のリソースを、欠陥が存在する可能性のある「現状のまま」提供しており、商品性および特定目的に対する適合性の黙示保証、第三者の知的財産権の非侵害保証を含むいかなる保証も、明示的または黙示的にかかわらず拒否します。

これらのリソースは、テキサス・インスツルメンツ製品を使用する設計の経験を積んだ開発者への提供を意図したものです。(1) お客様のアプリケーションに適したテキサス・インスツルメンツ製品の選定、(2) お客様のアプリケーションの設計、検証、試験、(3) お客様のアプリケーションに該当する各種規格や、その他のあらゆる安全性、セキュリティ、規制、または他の要件への確実な適合に関する責任を、お客様のみが単独で負うものとし、ます。

上記の各種リソースは、予告なく変更される可能性があります。これらのリソースは、リソースで説明されているテキサス・インスツルメンツ製品を使用するアプリケーションの開発の目的でのみ、テキサス・インスツルメンツはその使用をお客様に許諾します。これらのリソースに関して、他の目的で複製することや掲載することは禁止されています。テキサス・インスツルメンツや第三者の知的財産権のライセンスが付与されている訳ではありません。お客様は、これらのリソースを自身で使用した結果発生するあらゆる申し立て、損害、費用、損失、責任について、テキサス・インスツルメンツおよびその代理人を完全に補償するものとし、テキサス・インスツルメンツは一切の責任を拒否します。

テキサス・インスツルメンツの製品は、[テキサス・インスツルメンツの販売条件](#)、または [ti.com](https://www.ti.com) やかかるテキサス・インスツルメンツ製品の関連資料などのいずれかを通じて提供する適用可能な条項の下で提供されています。テキサス・インスツルメンツがこれらのリソースを提供することは、適用されるテキサス・インスツルメンツの保証または他の保証の放棄の拡大や変更を意味するものではありません。

お客様がいかなる追加条項または代替条項を提案した場合でも、テキサス・インスツルメンツはそれらに異議を唱え、拒否します。

郵送先住所：Texas Instruments, Post Office Box 655303, Dallas, Texas 75265
Copyright © 2025, Texas Instruments Incorporated