

## TPS61291 Low Iq Boost Converter with Bypass Operation

### 1 Features

- Input Voltage Range 0.9V to 5V
- Startup Voltage 1.5V at 20mA Load
- Pin Selectable Output Voltages: 3.3V, 3V, 2.5V
- 15nA typical Quiescent Current in Bypass Mode
- 5.7µA typical Quiescent Current in Boost Mode
- Bypass Switch from VIN to VOUT
- $I_{OUT} > 200\text{mA}$  at 3.3V  $V_{OUT}$ ,  $V_{IN} = 1.8\text{V}$
- Internal Feedback Divider Disconnect (Bypass Mode)
- Controlled Bypass Transition Prevents Reverse Current into Battery
- Power-Save Mode at Light Loads
- Overtemperature Protection
- Redundant Overvoltage Protection
- Small 2mm x 2mm SON 6-pin package

### 2 Applications

- Metering (Gas, Water, Smart Meters)
- Remote Controls
- Home Security / Home Automation
- Single 3V Li-MnO<sub>2</sub> or 2 x 1.5V Alkaline Cell Powered Applications

### 3 Description

The TPS61291 is a boost converter with pin selectable output voltages and an integrated bypass mode. In bypass operation, the device provides a direct path from the input to the system and allows a low power micro controller (MCU) such as the MSP430 to operate directly from a single 3V Li-MnO<sub>2</sub> battery or dual alkaline battery cells.

In bypass mode the integrated feedback divider network for boost mode operation is disconnected from the output and the quiescent current consumption drops down to only 15nA (typical).

In boost mode the device provides a minimum output current of 200mA at 3.3V  $V_{OUT}$  from 1.8V  $V_{IN}$ . The boost mode is used for system components which require a regulated supply voltage and cannot directly operate from the input source. The boost converter is based on a current-mode controller using synchronous rectification to obtain maximum efficiency and consumes typically 5.7µA from the output. During startup of the boost converter, the VSEL pin is read out and the integrated feedback network sets the output voltage to 2.5V, 3V or 3.3V.

Bypass mode or boost mode operation is controlled by the system via the EN/BYP pin.

The device integrates an enhanced bypass mode control to prevent charge, stored in the output capacitor during boost mode operation, from flowing back to the input and charging the battery.

The device is packaged in a small 6-pin SON package (DRV) measuring 2.0mm x 2.0mm x 0.75mm.

#### Device Information<sup>(1)</sup>

PART NUMBER	PACKAGE	BODY SIZE (NOM)
TPS61291	SON (6)	2.00 mm x 2.00 mm

(1) For all available packages, see the orderable addendum at the end of the datasheet.

#### Simplified Schematic and Efficiency Curves

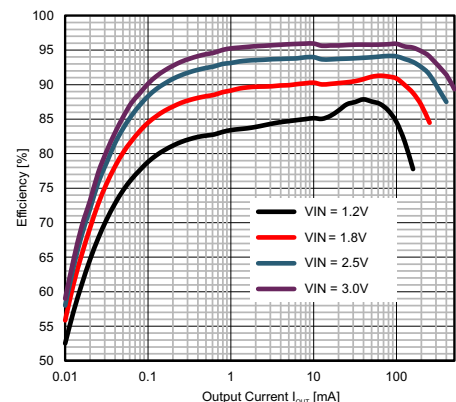
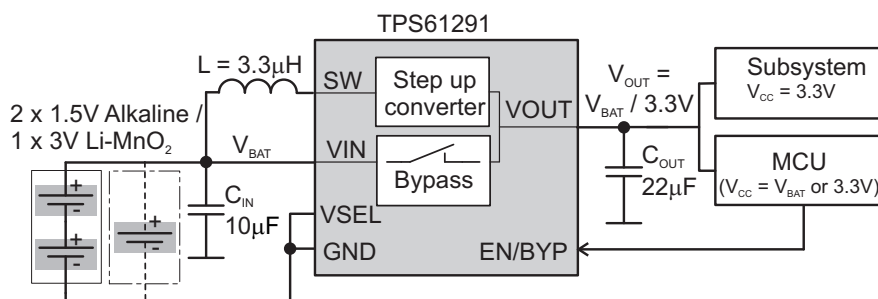

## Table of Contents

<b>1 Features</b> .....	<b>1</b>	7.4 Device Functional Modes.....	<b>8</b>
<b>2 Applications</b> .....	<b>1</b>	<b>8 Applications and Implementation</b> .....	<b>10</b>
<b>3 Description</b> .....	<b>1</b>	8.1 Application Information.....	<b>10</b>
<b>4 Revision History</b> .....	<b>2</b>	8.2 Typical Application .....	<b>10</b>
<b>5 Pin Configuration and Functions</b> .....	<b>3</b>	<b>9 Power Supply Recommendations</b> .....	<b>16</b>
<b>6 Specifications</b> .....	<b>4</b>	<b>10 Layout</b> .....	<b>16</b>
6.1 Absolute Maximum Ratings .....	4	10.1 Layout Guidelines .....	16
6.2 Handling Ratings.....	4	10.2 Layout Example .....	16
6.3 Recommended Operating Conditions.....	4	<b>11 Device and Documentation Support</b> .....	<b>17</b>
6.4 Thermal Information .....	4	11.1 Device Support .....	17
6.5 Electrical Characteristics.....	5	11.2 Documentation Support .....	17
6.6 Typical Characteristics.....	6	11.3 Trademarks .....	17
<b>7 Detailed Description</b> .....	<b>7</b>	11.4 Electrostatic Discharge Caution.....	17
7.1 Overview .....	7	11.5 Glossary .....	17
7.2 Functional Block Diagram .....	7	<b>12 Mechanical, Packaging, and Orderable</b>	
7.3 Feature Description.....	7	<b>Information</b> .....	<b>17</b>

## 4 Revision History

NOTE: Page numbers for previous revisions may differ from page numbers in the current version.

<b>Changes from Original (September 2014) to Revision A</b>	<b>Page</b>
• Changed "Bypass Mode Operation" description .....	9
• Added sub-section "Controlled Transition into Bypass Mode" .....	9
• Added NOTE to the "Application and Implementation" section. ....	10
• Changed "List of Inductors" table .....	11

## 5 Pin Configuration and Functions

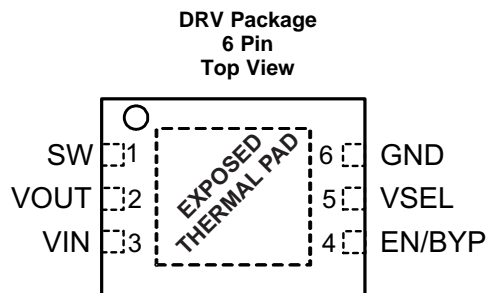

### Pin Functions

PIN		I/O	DESCRIPTION
NAME	NO.		
SW	1	I	Switch node of the converter. Connect the inductor between this pin and the input capacitor $C_{IN}$ .
VOUT	2	O	Boost converter output. Connect the output capacitor $C_{OUT}$ between this pin and GND close to the device.
VIN	3	PWR	Input voltage supply pin for the boost converter. Connect the input capacitor $C_{IN}$ between this pin and GND as close as possible to the device.
EN/BYP	4	I	Control pin of the device. A high level enables the boost mode operation. A low level disables the boost converter and enables bypass mode operation. EN/BYP must be actively terminated high or low. Usually, this pin is controlled by the MCU in the system.
VSEL	5	I	Output voltage selection pin. The logic level of this pin is read out during startup and internally latched. Connect this pin only to GND, VOUT, or leave it floating.
GND	6	PWR	Ground pin of the device.
EXPOSED THERMAL PAD		NC	Not electrically connected to the IC, but must be soldered to achieve specified thermal performance. Connect this pad to the GND pin and use it as a central GND plane.

### Output Voltage Setting

EN/BYP Pin	VSEL Pin at Startup	$V_{OUT}$	Mode
high	GND	3.3V	Boost Mode Operation
high	VOUT	3.0V	
high	floating	2.5V	
low	GND / VOUT / floating	$V_{OUT} = V_{IN}$ (Bypass Mode)	Bypass Mode Operation

## 6 Specifications

### 6.1 Absolute Maximum Ratings

over operating free-air temperature range (unless otherwise noted) <sup>(1)</sup>

		MIN	MAX	UNIT
Pin Voltage Range <sup>(2)</sup>	V <sub>IN</sub>	-0.3	5.5	V
	SW	-0.3	7	
	EN/BYP, V <sub>OUT</sub>	-0.3	5.5	
	V <sub>SEL</sub>	-0.3	V <sub>OUT</sub> + 0.3V	
Output Current	In Bypass Operation (EN/BYP = GND)		250	mA
T <sub>J</sub>	Maximum Junction Temperature	-40	150	°C

- (1) Stresses beyond those listed under *Absolute Maximum Ratings* may cause permanent damage to the device. These are stress ratings only, which do not imply functional operation of the device at these or any other conditions beyond those indicated under *Recommended Operating Conditions*. Exposure to absolute-maximum-rated conditions for extended periods may affect device reliability.
- (2) All voltage values are with respect to network ground terminal GND.

### 6.2 Handling Ratings

		MIN	MAX	UNIT	
T <sub>stg</sub>	Storage temperature range	-65	150	°C	
V <sub>(ESD)</sub>	Electrostatic discharge	Human body model (HBM) per ANSI/ESDA/JEDEC JS-001, all pins <sup>(1)</sup>	-2	2	kV
		Charged device model (CDM), per JEDEC specification JESD22-C101, all pins <sup>(2)</sup>	-0.5	0.5	

- (1) JEDEC document JEP155 states that 500-V HBM allows safe manufacturing with a standard ESD control process.
- (2) JEDEC document JEP157 states that 250-V CDM allows safe manufacturing with a standard ESD control process.

### 6.3 Recommended Operating Conditions

over operating free-air temperature range (unless otherwise noted)

		MIN	NOM	MAX	UNIT
V <sub>IN</sub>	Supply voltage for startup	1.5			V
	Supply voltage range (once device has started)	0.9		5	
	Supply voltage range for step up conversion (once device has started)	0.9		V <sub>OUT</sub>	
T <sub>A</sub>	Operating ambient temperature	-40		85	°C
T <sub>J</sub>	Operating junction temperature	-40		125	

### 6.4 Thermal Information

THERMAL METRIC <sup>(1)</sup>		TPS61291	UNIT
		DRV (2x2 SON)	
		6 PINS	
R <sub>θJA</sub>	Junction-to-ambient thermal resistance	71.2	°C/W
R <sub>θJctop</sub>	Junction-to-case (top) thermal resistance	93.5	
R <sub>θJB</sub>	Junction-to-board thermal resistance	46.7	
Ψ <sub>JT</sub>	Junction-to-top characterization parameter	2.5	
Ψ <sub>JB</sub>	Junction-to-board characterization parameter	41.1	
R <sub>θJcbot</sub>	Junction-to-case (bottom) thermal resistance	11.1	

- (1) For more information about traditional and new thermal metrics, see the *IC Package Thermal Metrics* application report, [SPRA953](http://www.ti.com/lit/zip/SprA953).

## 6.5 Electrical Characteristics

 $T_A = -40^{\circ}\text{C}$  to  $85^{\circ}\text{C}$ . Typical values are at  $T_A = 25^{\circ}\text{C}$  (unless otherwise noted)

PARAMETER		TEST CONDITIONS		MIN	TYP	MAX	UNIT
<b>SUPPLY</b>							
$V_{IN}$	Startup voltage		$V_{OUT} = 3.3\text{V}$ , $I_{OUT} = 20\text{mA}$			1.5	V
	Input voltage range		Operating voltage range	0.9		5	
$I_Q$	Quiescent current in boost mode	$V_{IN}$	$I_{OUT} = 0\text{ mA}$ , $V_{EN/BYP} = V_{IN} = 1.8\text{ V}$ , $V_{OUT} = 3.3\text{V}$ , device not switching		0.4	1.5	$\mu\text{A}$
		$V_{OUT}$			5.7	9	
	Quiescent current in bypass mode	$V_{IN}$	$V_{EN/BYP} = \text{low}$ , $V_{IN} = 3\text{ V}$ , $I_{OUT} = 0\text{ mA}$		0.015	0.5	
$I_{LKS\text{W}}$	Leakage current into SW		$V_{EN/BYP} = \text{low}$ , $V_{IN} = 1.2\text{ V}$ , $V_{\text{SW}} = 1.2\text{ V}$		0.01	0.5	$\mu\text{A}$
$V_{UVLO}$	Undervoltage lockout threshold		$V_{IN}$ decreasing		0.65	0.9	V
	Overtemperature protection		$T_J$ rising		140		$^{\circ}\text{C}$
	Overtemperature hysteresis				20		$^{\circ}\text{C}$
<b>INPUTS</b>							
$I_{IN}$	EN/BYP, input current		EN/BYP = low or EN/BYP = $V_{IN}$		0.01	0.1	$\mu\text{A}$
$V_{IL}$	EN/BYP, input low voltage		$V_{IN} \leq 1.5\text{ V}$			$0.2 \times V_{IN}$	V
			$5\text{ V} > V_{IN} > 1.5\text{ V}$			0.3	
$V_{IH}$	EN/BYP, input high voltage		$V_{IN} \leq 1.5\text{ V}$		$0.8 \times V_{IN}$		V
			$5\text{ V} > V_{IN} > 1.5\text{ V}$		1.2		
$V_{IL}$	VSEL, input low voltage		$V_{EN/BYP} = \text{high}$			0.3	V
$V_{IH}$	VSEL, input high voltage		$V_{EN/BYP} = \text{high}$		$V_{OUT} - 0.3$		V
$I_{IN}$	VSEL, input current		$V_{EN/BYP} = \text{high}$ , VSEL = $V_{OUT} = 3\text{V}$		0.01	0.1	$\mu\text{A}$
<b>POWER SWITCHES</b>							
$R_{DS(\text{ON})}$	Rectifying switch on resistance		$V_{OUT} = 3.3\text{ V}$		0.6		$\Omega$
	Main switch on resistance		$V_{OUT} = 3.3\text{ V}$		0.4		$\Omega$
	Bypass switch on resistance		$V_{IN} = 1.8\text{V}$ , $I_{OUT} = 50\text{ mA}$ , EN/BYP = low		1.2		$\Omega$
$I_{\text{SW}}$	Switch current limit		$V_{OUT} = 3.3\text{V}$	700	1000	1300	mA
<b>OUTPUT</b>							
$V_{OUT}$	Output voltage accuracy		$V_{IN} = 1.8\text{V}$ , $I_{OUT} = 10\text{ mA}$ , $V_{OUT} = 3.3\text{V}$ , $3.0\text{V}$ , $2.5\text{V}$ , EN/BYP = high	-2	+1	+4	%
	Line regulation		$V_{OUT} = 3.3\text{V}$ , $V_{IN} = 2\text{V}$ to $3.0\text{V}$ , $I_{OUT} = 50\text{ mA}$ , EN/BYP = high		+0.15		%/V
	Load regulation		$V_{IN} = 2\text{V}$ , $V_{OUT} = 3.3\text{V}$ , $I_{OUT} = 1\text{ mA}$ to $200\text{ mA}$ , EN/BYP = high		-0.007		%/mA
$V_{\text{OVP}}$	Output overvoltage protection		$V_{OUT}$ rising, EN/BYP = high		5.4		V

## 6.6 Typical Characteristics

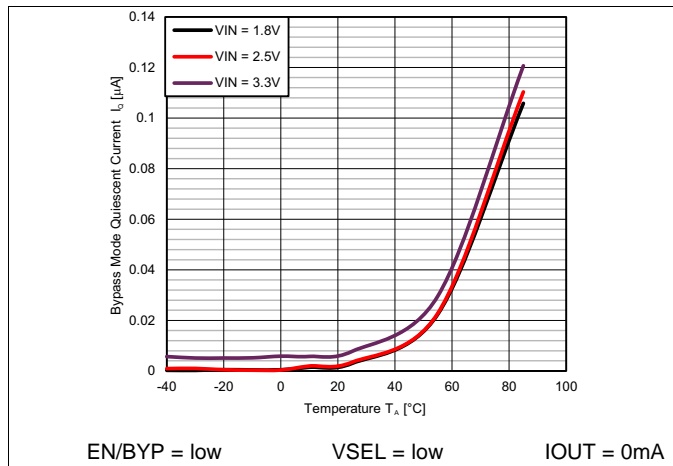

Figure 1. Quiescent Current  $I_Q$  into VIN Pin in Bypass Mode

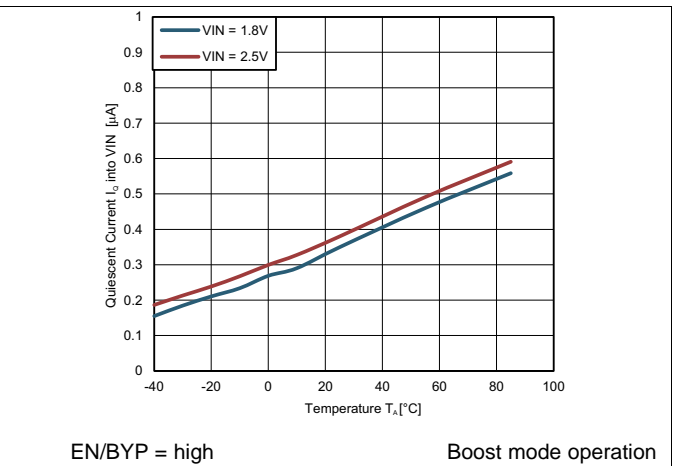

Figure 2. Quiescent Current  $I_Q$  into VIN Pin in Boost Mode

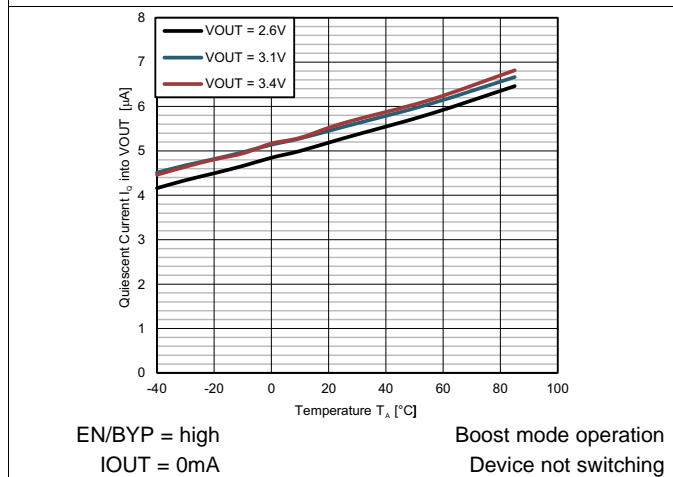

Figure 3. Quiescent Current  $I_Q$  into VOUT Pin in Boost Mode

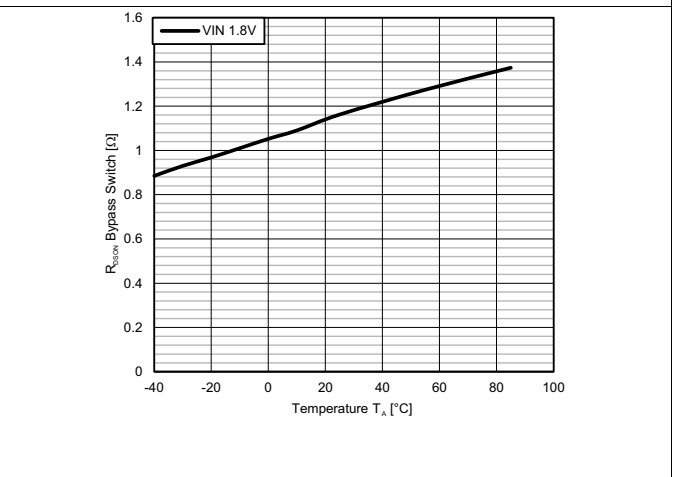

Figure 4.  $R_{DS(on)}$  Bypass Switch

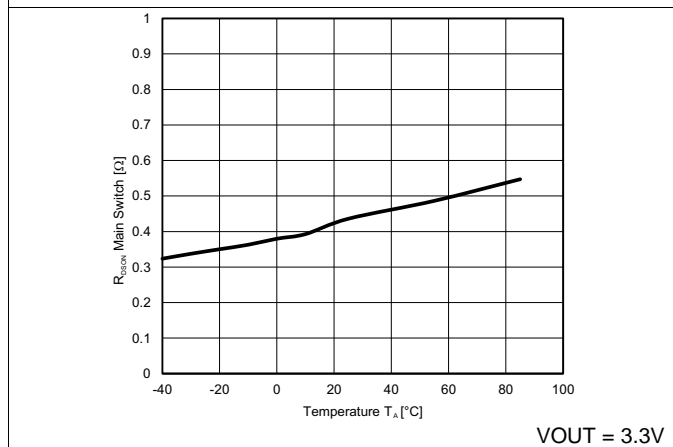

Figure 5.  $R_{DS(on)}$  Main Switch

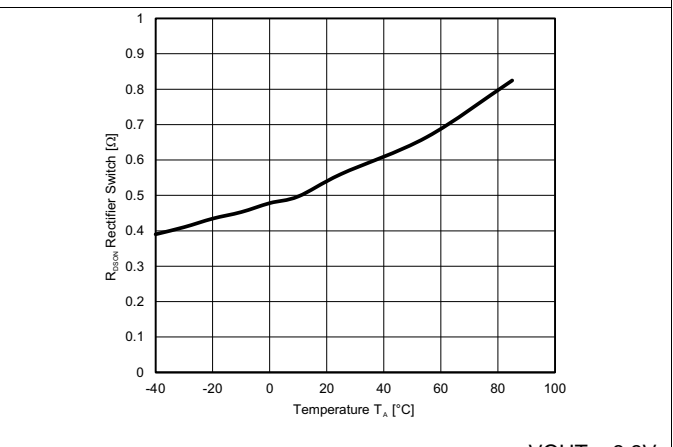

Figure 6.  $R_{DS(on)}$  Rectifier Switch

## 7 Detailed Description

### 7.1 Overview

The TPS61291 provides two operating modes: high efficiency boost mode to generate an output voltage higher than the input voltage and bypass mode, which connects the output of the device directly to the input.

### 7.2 Functional Block Diagram

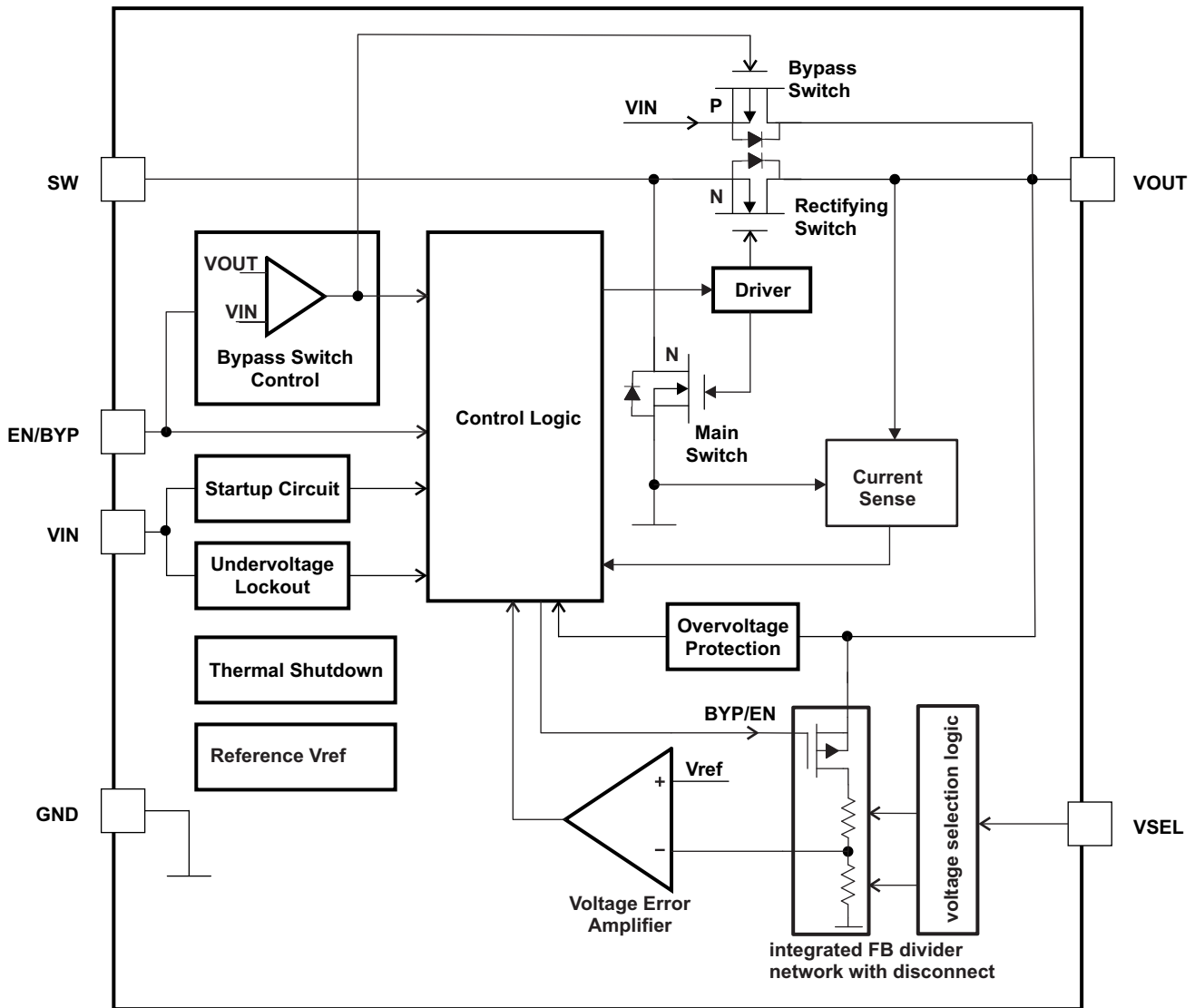

### 7.3 Feature Description

#### 7.3.1 Bypass / Boost Mode Operation EN/BYP

The EN/BYP pin selects the operating mode of the device. With the EN/BYP pin pulled low, the device operates in bypass mode. With a high level on the EN/BYP pin, the device operates as a boost converter. The EN/BYP pin is usually controlled by an I/O pin of a MCU, powered from the output of the TPS61291 and should not be left floating. See [Figure 8](#). See also sections [Boost Mode Operation](#) and [Bypass Mode Operation](#) for more detailed descriptions.

## Feature Description (continued)

### 7.3.2 Output Voltage Selection VSEL

In boost mode operation, the device supports three internally set output voltages: 2.5V, 3V and 3.3V. Leaving the VSEL pin open sets the output voltage to 2.5V, VSEL = VOUT to 3.0V and VSEL = GND to 3.3V. The VSEL pin condition is detected during the startup of the boost converter and internally latched. For proper operation, it must be connected to either GND, VOUT or left floating. Depending on the VSEL condition, an integrated feedback divider network is selected. Changing the VSEL pin condition during operation does not change the output voltage.

### 7.3.3 Feedback Divider Disconnect

In boost mode operation, the integrated feedback divider network, which is required for regulation, is connected to the VOUT pin. To achieve the low quiescent current in bypass mode, the integrated feedback divider network is disconnected from the output pin VOUT.

### 7.3.4 Undervoltage Lockout

An undervoltage lockout function stops the operation of the boost converter if the input voltage drops below the undervoltage lockout threshold. This function is implemented in order to prevent malfunction of the boost converter. The undervoltage lockout function has no control of the bypass switch.

### 7.3.5 Overtemperature Protection

The device has a built-in temperature sensor which monitors the internal junction temperature in boost mode operation. If the junction temperature exceeds the threshold (140 °C typical), the device stops operating. As soon as the junction temperature has decreased below the programmed threshold, it starts operating again. There is a built-in hysteresis to avoid unstable operation at IC temperatures at the overtemperature threshold. The overtemperature protection is not active in bypass mode operation.

### 7.3.6 Overvoltage Protection

In boost mode operation (EB/BYP = high), the device features a redundant over voltage protection circuit (OVP), which is independent from the reference, the regulation loop and feedback divider network. The redundant over voltage protection circuit limits the output voltage to typically 5.4V. The over voltage protection can only limit the output voltage in boost mode operation, when the input voltage  $V_{IN}$  is smaller than the output voltage  $V_{OUT}$ .

## 7.4 Device Functional Modes

### 7.4.1 Boost Mode Operation

The device is enabled and operates in boost mode operation when the EN/BYP pin is set high. The bypass switch is turned off once the boost converter has started switching.

In boost mode operation, the device is controlled by a hysteretic current mode controller. This controller regulates the output voltage by keeping the inductor ripple current constant in the range of 300 mA and adjusting the offset of this inductor current depending on the output load. If the required average input current is lower than the average inductor current defined by this constant ripple, the inductor current goes discontinuous to keep the efficiency high at low load conditions. To achieve high efficiency, the power stage is realized as a synchronous boost topology.

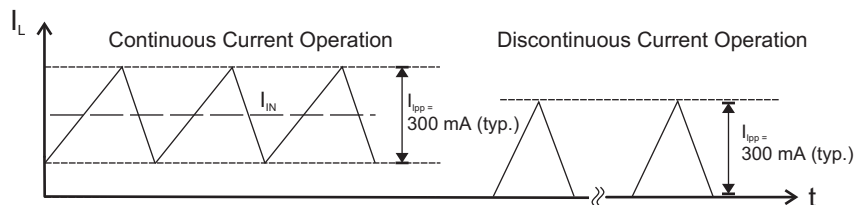

**Figure 7. Hysteretic Current Operation**



## Device Functional Modes (continued)

The output voltage  $V_{OUT}$  is monitored via the integrated feedback network which is connected to the voltage error amplifier. To regulate the output voltage, the voltage error amplifier compares this feedback voltage to the internal voltage reference and adjusts the required offset of the inductor current accordingly.

The hysteretic current mode architecture allows fast response to load variations.

### 7.4.2 Bypass Mode Operation

The TPS61291 includes a P-channel MOSFET (Bypass Switch) between the VIN and VOUT pins. When the IC is disabled (EN/BYP = low), bypass mode is activated to provide a direct, low impedance connection from the input voltage (at the VIN pin) to the load ( $V_{OUT}$ ). The bypass switch is not impacted by undervoltage lockout, or thermal shutdown. The bypass switch is not current-limit controlled. In bypass operation, the OVP circuit is disabled.

### 7.4.3 Controlled Transition into Bypass Mode

When changing from boost mode into bypass mode, the output capacitor is usually charged up to a higher voltage than the battery voltage  $V_{BAT}$ . In order to prevent current flowing from the output capacitor  $C_{OUT}$  via the bypass switch into the battery (reverse battery current), the internal bypass control circuit delays the bypass switch activation until the output voltage  $V_{OUT}$  has decreased to the input voltage level.

### 7.4.4 Operation at Output Overload

If the peak inductor current reaches the internal switch current limit threshold in boost mode operation, the main switch is turned off to stop a further increase of the input current. In this case the output voltage will decrease since the device cannot provide sufficient power to maintain the set output voltage. If the output voltage drops below the input voltage, the backgate diode of the rectifying switch gets forward biased and current starts to flow through it. Because this diode cannot be turned off, the load current is only limited by the remaining DC resistance. As soon as the overload condition is removed, the converter automatically resumes normal operation and enters the appropriate soft start mode depending on the operating conditions.

### 7.4.5 Startup

After the EN/BYP pin is tied high, the device starts to operate. If the input voltage is not high enough to supply the control circuit properly, a startup oscillator starts to operate the switches. During this phase, the switching frequency is controlled by the oscillator and the switch current is limited. As soon as the device has built up the output voltage to about 1.8 V, high enough for supplying the control circuit, the device switches to its normal hysteretic current mode operation.

## 8 Applications and Implementation

### NOTE

Information in the following applications sections is not part of the TI component specification, and TI does not warrant its accuracy or completeness. TI's customers are responsible for determining suitability of components for their purposes. Customers should validate and test their design implementation to confirm system functionality.

### 8.1 Application Information

The TPS61291 is a boost converter with pin selectable output voltages and an integrated bypass mode. In bypass operation, the device provides a direct path from the input to the system and allows a low power micro controller (MCU) to operate directly from a single 3V Li-MnO<sub>2</sub> battery or dual alkaline battery cells. In bypass mode, the quiescent current consumption is typically only 15nA and supports low power modes of MCUs such as the MSP430. In boost mode operation, the device provides a regulated output voltage (e.g. 3.3V) to supply circuits which require a higher voltage than provided by the battery. See [Figure 8](#).

The device also extends battery life in applications which can run partially directly from the battery, but need a boost conversion to maintain sufficient system voltage when the battery voltage drops due to discharge. In this case, the system runs off the battery in bypass mode operation until the battery voltage trips the minimum system operating voltage. Then the system turns on the boost converter, providing a sufficient output voltage down to the cut off voltage of the battery. See [Figure 9](#) and [Figure 26](#).

### 8.2 Typical Application

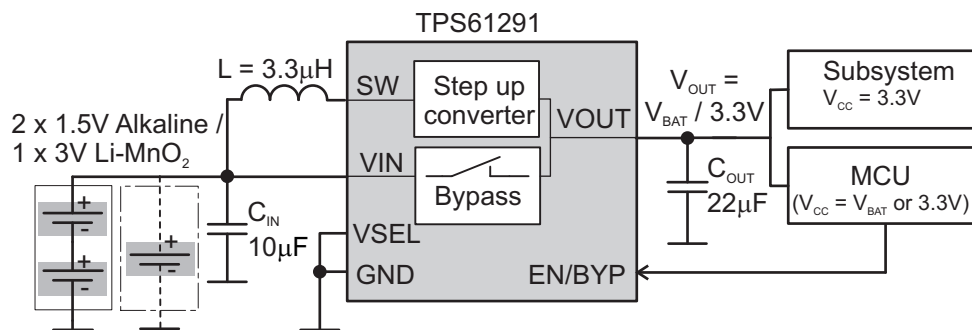

Figure 8. Typical Application Circuit with Regulated 3.3V VOUT / VBAT

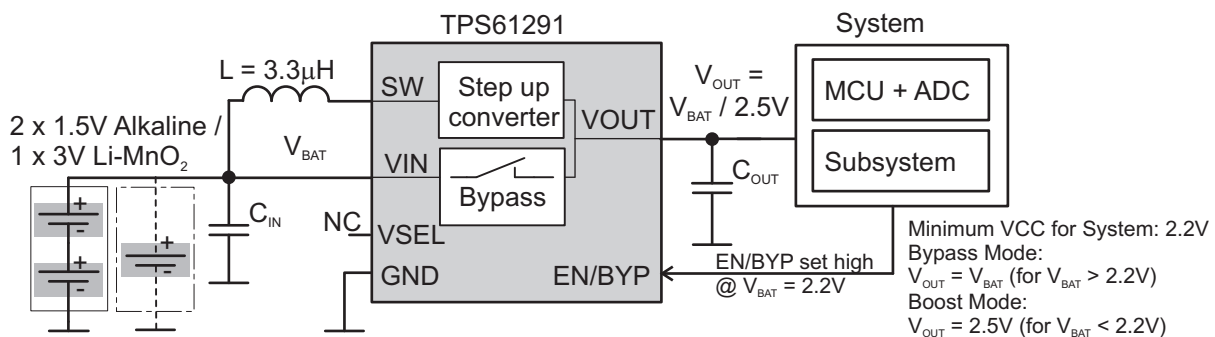

Figure 9. Bypass Mode / Boost Mode Operation to Maintain Sufficient System Voltage

#### 8.2.1 Design Requirements

The TPS61291 is a highly integrated boost converter. The output voltage is set internally via a VSEL pin without any additional components. For operation, only an input capacitor, output capacitor, and an inductor are required. [Table 1](#) shows the components used for the application characteristic curves.

## Typical Application (continued)

**Table 1. Components for Application Characteristic Curves<sup>(1)</sup>**

Reference	Description	Value	Manufacturer	
TPS61291	Low Iq Boost Converter with Bypass Operation		Texas Instruments	
C <sub>IN</sub>	Input capacitor	10μF	Murata	GRM219R61A106KE44D
C <sub>OUT</sub>	Output capacitor	22μF	Murata	GRM21BR60J226ME39L
L	Inductor	3.3μH	Coilcraft	LPS3314 3R3

(1) See the Third-Party Products Disclaimer in the [Device Support](#) section.

### 8.2.2 Detailed Design Procedure

The external components have to fulfill the needs of the application but also the stability criteria of the device's control loop. The TPS61291 is optimized to work within a range of L and C combinations. The LC output filter inductance and capacitance must be considered together. The output capacitor sets the corner frequency of the converter while the inductor creates a Right-Half-Plane-Zero degrading the stability of the converter. Consequently with a larger inductor a bigger capacitor has to be used to guarantee a stable loop. [Table 2](#) shows the output filter component selection.

**Table 2. Recommended LC Output Filter Combinations**

Output voltage [V]	Inductor value [μH] <sup>(1)</sup>	Output capacitor value [μF] <sup>(2)</sup>		
		22	22 + 10	2 x 22
3.3 / 3.0	3.3	√ <sup>(3)</sup>	√	√
	4.7			√
2.5	2.2	√	√	√
	3.3		√ <sup>(3)</sup>	√

(1) Inductor tolerance and current de-rating is anticipated. The effective inductance can vary by 20% and -30%.

(2) Capacitance tolerance and bias voltage de-rating is anticipated. The effective capacitance can vary by 20% and -50%.

(3) This LC combination is the standard value and recommended for most applications.

#### 8.2.2.1 Inductor Selection

The device is optimized to operate with a 3.3μH inductor value. Other inductor values can be used, per [Table 2](#). The maximum inductor current can be approximated by the I<sub>LMAX</sub>, from [Equation 1](#). For proper operation, the inductor needs to be rated for a saturation current which is higher than the switch current limit of typically 1A. [Table 3](#) lists inductors that have been tested with the TPS61291.

$$I_{Lmax} : = \frac{V_{OUT} \times I_{OUT}}{0.8 \times V_{IN}} + 150 \text{ mA} \quad \text{continuous current operation}$$

$$I_{Lmax} : = 300 \text{ mA} \quad \text{discontinuous current operation} \quad (1)$$

**Table 3. List of Inductors<sup>(1)</sup>**

INDUCTANCE	DIMENSIONS [mm <sup>3</sup> ]	TYPE	SUPPLIER
3.3	3.3 x 3.3 x 1.3	LPS3314	Coilcraft
3.3	2.95 x 2.95 x 1.4	LPS3015	
3.3	3 x 2.5 x 1.5	VLF302515	TDK
3.3	2 x 2 x 1.2	MDMK2020T3R3M	Taiyo Yuden
3.3	2.5 x 2.0 x 1.2	DFE252012	Toko
3.3	3.0 x 3.0 x 1.5	74438335033	Würth

(1) See the Third-Party Products Disclaimer in the [Device Support](#) section.

### 8.2.2.2 *Input and Output Capacitor Selection*

For best output and input voltage filtering, low ESR X5R or X7R ceramic capacitors are recommended. The input capacitor minimizes input voltage ripple, suppresses input voltage spikes and provides a stable system rail for the device. At least a 10 $\mu$ F or larger input capacitor is recommended for operation. In applications in which the power source (e.g. certain battery chemistries) shows an internal resistance characteristic, a larger input capacitor might be used to buffer the supply voltage for the TPS61291. The recommended typical output capacitor value is 22  $\mu$ F and can vary as outlined in the output filter selection [Table 2](#).

### 8.2.3 Application Curves

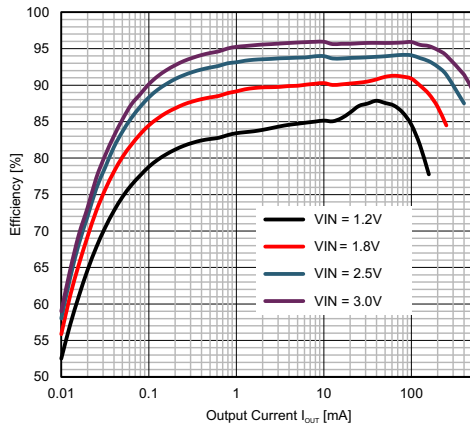

EN/BYP = high      L = 3.3μH      VSEL = GND

Figure 10. Efficiency vs IOUT, VOUT = 3.3V

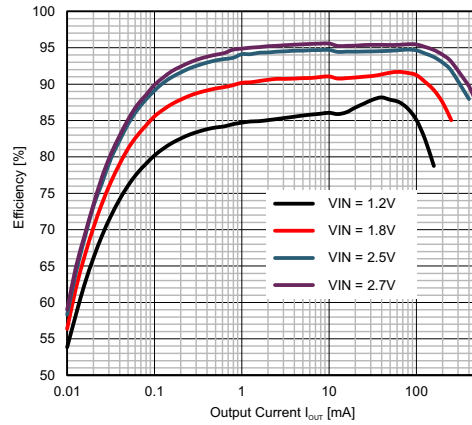

EN/BYP = high      L = 3.3μH      VSEL = VOUT

Figure 11. Efficiency vs IOUT, VOUT = 3.0V

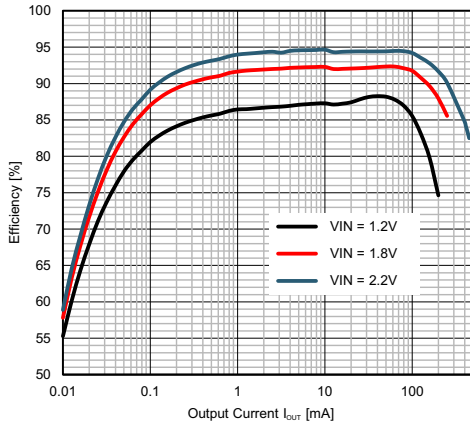

EN/BYP = high      L = 3.3μH      VSEL = open

Figure 12. Efficiency vs IOUT, VOUT = 2.5V

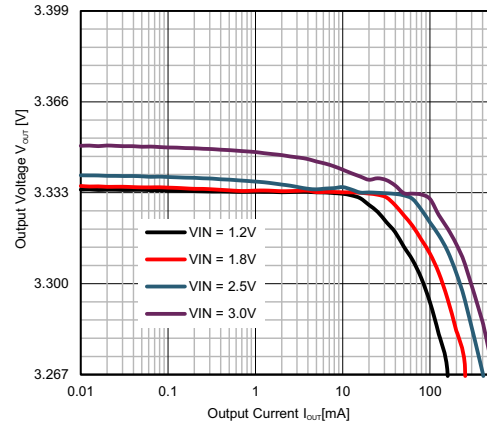

EN/BYP = high      L = 3.3μH      VSEL = GND

Figure 13. Output Voltage vs Output Current VOUT = 3.3V

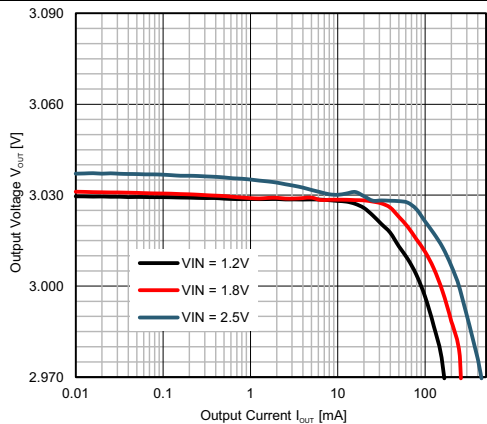

EN/BYP = high      L = 3.3μH      VSEL = VOUT

Figure 14. Output Voltage vs Output Current VOUT = 3.0V

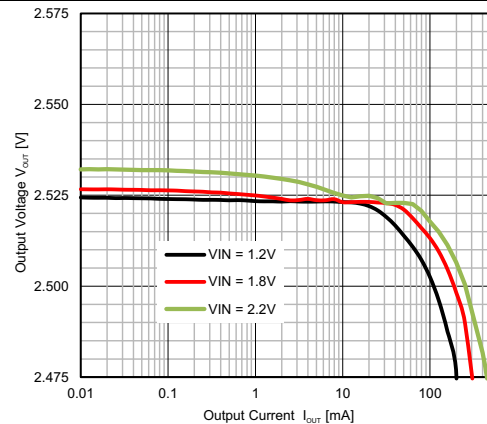

EN/BYP = high      L = 3.3μH      VSEL = open

Figure 15. Output Voltage vs Output Current VOUT = 2.5V

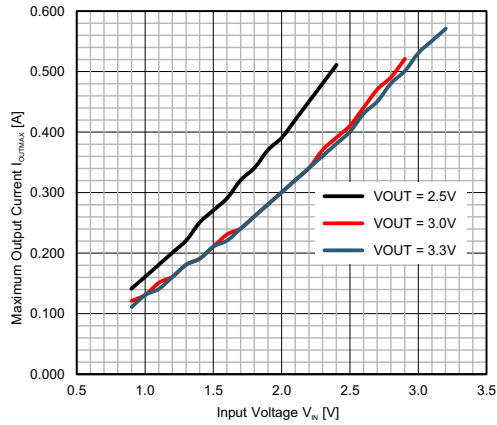

EN/BYP = high  
L = 3.3µH  
 $I_{SW} = 1000\text{mA}$  (typical)  
Boost mode operation

Figure 16. Maximum Output Current

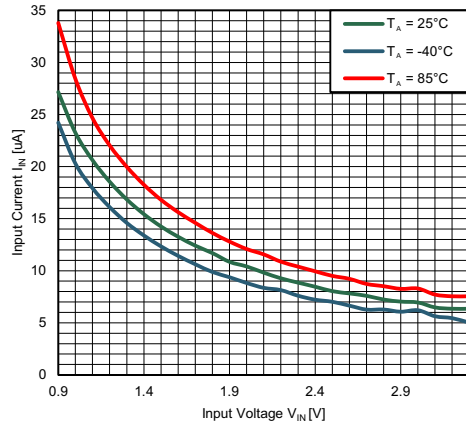

$V_{OUT} = 3.3\text{ V}$   
 $I_{OUT} = 0\text{ mA}$   
L = 3.3 µH  
 $C_{OUT} = 22\text{ µF}$   
Device switching

Figure 17. Supply Current vs.  $V_{IN}$ ,  $V_{OUT} = 3.3\text{V}$ ,  $I_{OUT} = 0\text{mA}$

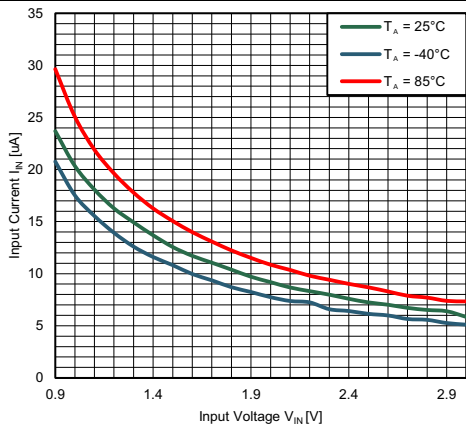

$V_{OUT} = 3.0\text{ V}$   
 $I_{OUT} = 0\text{ mA}$   
L = 3.3 µH  
 $C_{OUT} = 22\text{ µF}$   
Device switching

Figure 18. Supply Current vs.  $V_{IN}$ ,  $V_{OUT} = 3.0\text{V}$ ,  $I_{OUT} = 0\text{mA}$

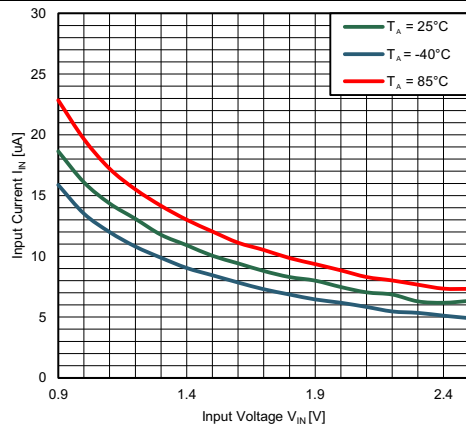

$V_{OUT} = 2.5\text{ V}$   
 $I_{OUT} = 0\text{ mA}$   
L = 3.3 µH  
 $C_{OUT} = 22\text{ µF}$   
Device switching

Figure 19. Supply Current vs.  $V_{IN}$ ,  $V_{OUT} = 2.5\text{V}$ ,  $I_{OUT} = 0\text{mA}$

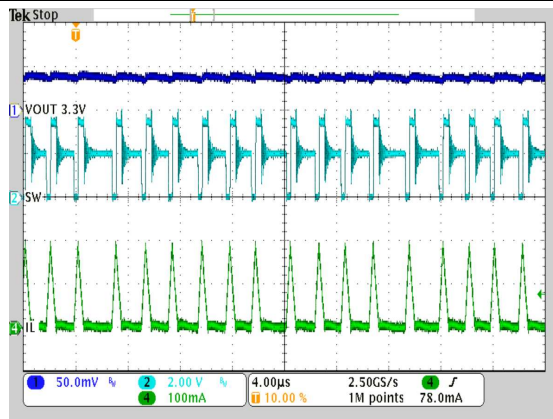

$V_{IN} = 2.0\text{ V}$   
 $V_{OUT} = 3.3\text{ V}$   
L = 3.3 µH  
 $I_{OUT} = 15\text{mA}$   
 $C_{OUT} = 22\text{ µF}$   
VSEL = GND  
EN/BYP = high

Figure 20. Discontinuous Conduction Mode Operation,  $V_{OUT} = 3.3\text{V}$

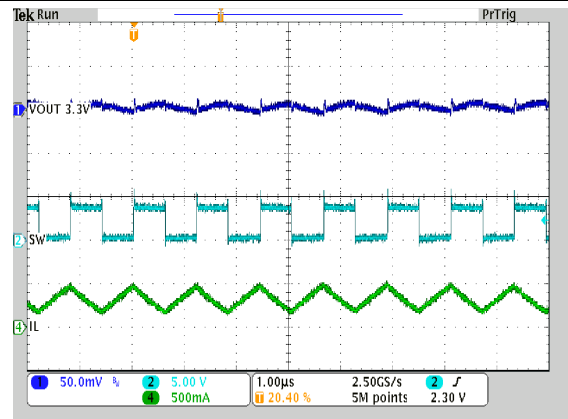

$V_{IN} = 1.8\text{ V}$   
 $V_{OUT} = 3.3\text{ V}$   
L = 3.3 µH  
 $I_{OUT} = 150\text{ mA}$   
 $C_{OUT} = 22\text{ µF}$   
VSEL = GND  
EN/BYP = high

Figure 21. Continuous Conduction Mode Operation,  $V_{OUT} = 3.3\text{V}$

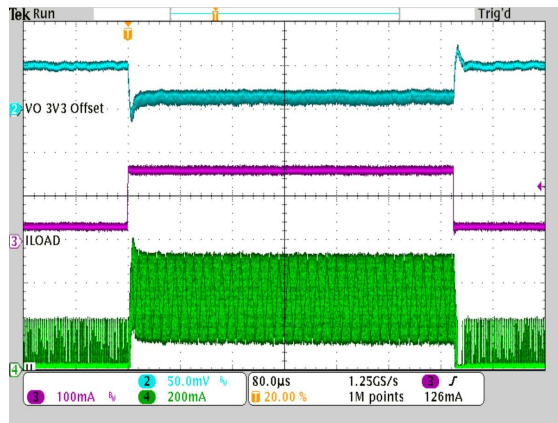

$V_{IN} = 1.8V$        $L = 3.3\mu H$        $C_{OUT} = 22 \mu F$   
 $V_{OUT} = 3.3V$        $V_{SEL} = GND$   
 $I_{LOAD} 20mA / 150mA$

Figure 22. Load Transient Response

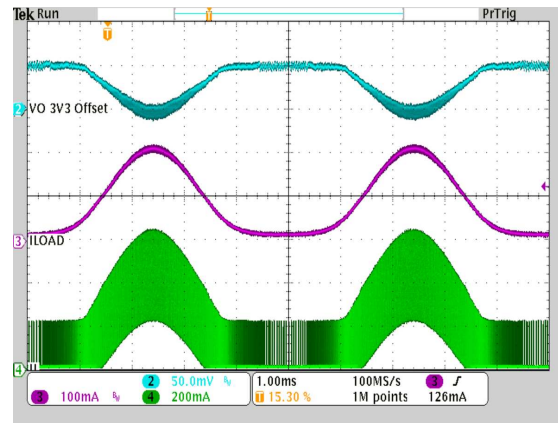

$V_{IN} = 1.8V$        $L = 3.3\mu H$        $C_{OUT} = 22 \mu F$   
 $V_{OUT} = 3.3V$        $V_{SEL} = GND$   
 $I_{LOAD} 1mA/200mA$

Figure 23. AC Load Sweep

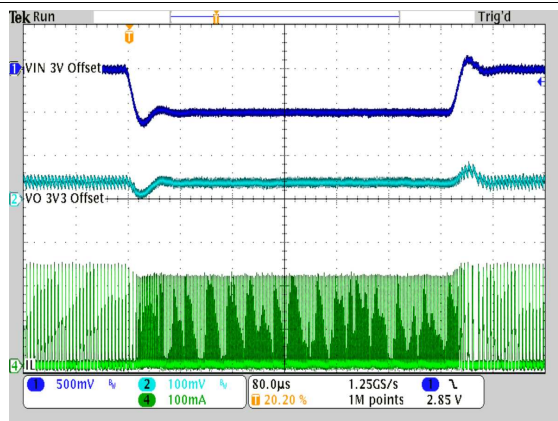

$V_{IN} = 2.5V/3V$        $L = 3.3\mu H$        $C_{OUT} = 22 \mu F$   
 $V_{OUT} = 3.3V$        $V_{SEL} = GND$        $Load = 100\Omega$

Figure 24. Line Transient Response

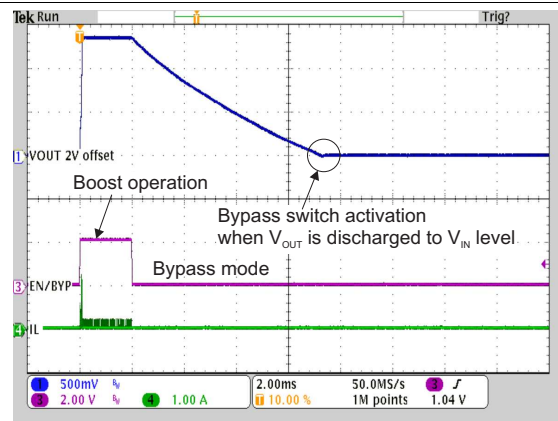

$V_{IN} = 2.0V$        $L = 3.3\mu H$        $C_{OUT} = 22 \mu F$   
 $V_{OUT} = 3.3V$        $V_{SEL} = GND$        $R_{LOAD} = 1k\Omega$

Figure 25. Boost Mode / Bypass Mode Transition

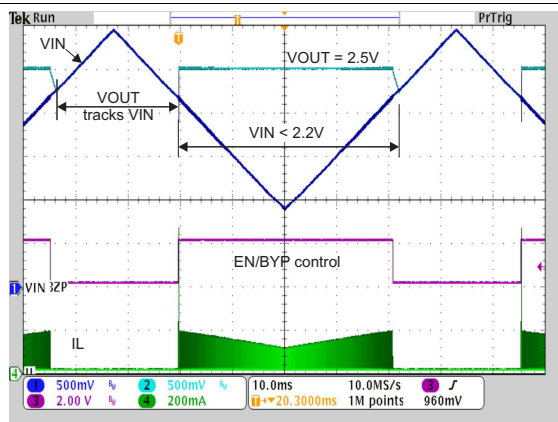

$V_{IN} = 0.9V \text{ to } 3V$        $V_{SEL} = Open$        $I_{LOAD} = 5mA$   
 $V_{OUT} = 2.5V$        $EN/BYP \text{ externally controlled}$   
 Bypass / Boost mode operation

Figure 26. Bypass / Boost Mode Operation

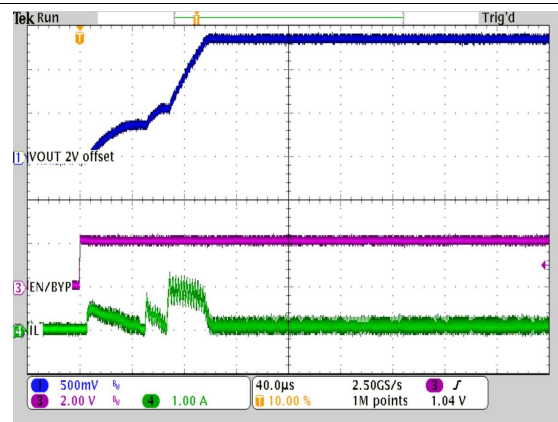

$V_{IN} = 2.0V$        $L = 3.3\mu H$        $C_{OUT} = 22 \mu F$   
 $V_{OUT} = 3.3V$        $V_{SEL} = GND$        $R_{LOAD} = 100\Omega$

Figure 27. Startup in Boost Mode

## 9 Power Supply Recommendations

The input power supply needs to have a current rating according to the supply voltage, output voltage and output current of the TPS61291.

## 10 Layout

### 10.1 Layout Guidelines

As for all switching power supplies, the layout is an important step in the design. Care must be taken in board layout to get the specified performance. If the layout is not carefully done, the regulator could show poor line and/or load regulation, stability issues as well as EMI problems. It is critical to provide a low inductance, low impedance ground path. Therefore, use wide and short traces for the main current paths. In a boost converter, the ripple current on the output is larger than the ripple current on the input. The output capacitor needs to be placed as close as possible between the VOUT and the GND pins. The input capacitor should be placed as close as possible to the VIN and GND pins. Place the inductor close by the IC and connect it with short and thick traces to the IC. Avoid current loops to minimize radiated noise and stray fields. The exposed thermal pad of the package and the GND pin must be connected. See [Figure 28](#) for the recommended PCB layout.

### 10.2 Layout Example

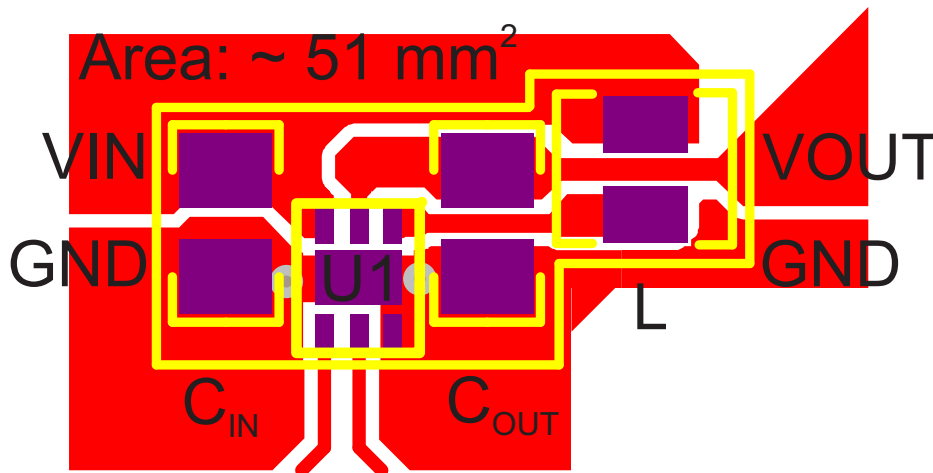

Figure 28. Recommended PCB Layout



## 11 Device and Documentation Support

### 11.1 Device Support

#### 11.1.1 Third-Party Products Disclaimer

TI'S PUBLICATION OF INFORMATION REGARDING THIRD-PARTY PRODUCTS OR SERVICES DOES NOT CONSTITUTE AN ENDORSEMENT REGARDING THE SUITABILITY OF SUCH PRODUCTS OR SERVICES OR A WARRANTY, REPRESENTATION OR ENDORSEMENT OF SUCH PRODUCTS OR SERVICES, EITHER ALONE OR IN COMBINATION WITH ANY TI PRODUCT OR SERVICE.

### 11.2 Documentation Support

#### 11.2.1 Related Documentation

*TPS61291EVM-569 User's Guide*, [SLVUA29](#)

### 11.3 Trademarks

### 11.4 Electrostatic Discharge Caution



These devices have limited built-in ESD protection. The leads should be shorted together or the device placed in conductive foam during storage or handling to prevent electrostatic damage to the MOS gates.

### 11.5 Glossary

[SLYZ022](#) — *TI Glossary*.

This glossary lists and explains terms, acronyms, and definitions.

## 12 Mechanical, Packaging, and Orderable Information

The following pages include mechanical packaging and orderable information. This information is the most current data available for the designated devices. This data is subject to change without notice and revision of this document. For browser-based versions of this data sheet, refer to the left-hand navigation.

**PACKAGING INFORMATION**

Orderable Device	Status (1)	Package Type	Package Drawing	Pins	Package Qty	Eco Plan (2)	Lead finish/ Ball material (6)	MSL Peak Temp (3)	Op Temp (°C)	Device Marking (4/5)	Samples
TPS61291DRVR	ACTIVE	WSON	DRV	6	3000	RoHS & Green	Call TI   NIPDAU	Level-1-260C-UNLIM	-40 to 125	PC4I	<a href="#">Samples</a>
TPS61291DRV/T	ACTIVE	WSON	DRV	6	250	RoHS & Green	NIPDAU	Level-1-260C-UNLIM	-40 to 125	PC4I	<a href="#">Samples</a>

(1) The marketing status values are defined as follows:

**ACTIVE:** Product device recommended for new designs.

**LIFEBUY:** TI has announced that the device will be discontinued, and a lifetime-buy period is in effect.

**NRND:** Not recommended for new designs. Device is in production to support existing customers, but TI does not recommend using this part in a new design.

**PREVIEW:** Device has been announced but is not in production. Samples may or may not be available.

**OBSOLETE:** TI has discontinued the production of the device.

(2) **RoHS:** TI defines "RoHS" to mean semiconductor products that are compliant with the current EU RoHS requirements for all 10 RoHS substances, including the requirement that RoHS substance do not exceed 0.1% by weight in homogeneous materials. Where designed to be soldered at high temperatures, "RoHS" products are suitable for use in specified lead-free processes. TI may reference these types of products as "Pb-Free".

**RoHS Exempt:** TI defines "RoHS Exempt" to mean products that contain lead but are compliant with EU RoHS pursuant to a specific EU RoHS exemption.

**Green:** TI defines "Green" to mean the content of Chlorine (Cl) and Bromine (Br) based flame retardants meet JS709B low halogen requirements of <=1000ppm threshold. Antimony trioxide based flame retardants must also meet the <=1000ppm threshold requirement.

(3) MSL, Peak Temp. - The Moisture Sensitivity Level rating according to the JEDEC industry standard classifications, and peak solder temperature.

(4) There may be additional marking, which relates to the logo, the lot trace code information, or the environmental category on the device.

(5) Multiple Device Markings will be inside parentheses. Only one Device Marking contained in parentheses and separated by a "~" will appear on a device. If a line is indented then it is a continuation of the previous line and the two combined represent the entire Device Marking for that device.

(6) Lead finish/Ball material - Orderable Devices may have multiple material finish options. Finish options are separated by a vertical ruled line. Lead finish/Ball material values may wrap to two lines if the finish value exceeds the maximum column width.

**Important Information and Disclaimer:**The information provided on this page represents TI's knowledge and belief as of the date that it is provided. TI bases its knowledge and belief on information provided by third parties, and makes no representation or warranty as to the accuracy of such information. Efforts are underway to better integrate information from third parties. TI has taken and continues to take reasonable steps to provide representative and accurate information but may not have conducted destructive testing or chemical analysis on incoming materials and chemicals. TI and TI suppliers consider certain information to be proprietary, and thus CAS numbers and other limited information may not be available for release.

In no event shall TI's liability arising out of such information exceed the total purchase price of the TI part(s) at issue in this document sold by TI to Customer on an annual basis.



**TAPE AND REEL INFORMATION**

**QUADRANT ASSIGNMENTS FOR PIN 1 ORIENTATION IN TAPE**

\*All dimensions are nominal

Device	Package Type	Package Drawing	Pins	SPQ	Reel Diameter (mm)	Reel Width W1 (mm)	A0 (mm)	B0 (mm)	K0 (mm)	P1 (mm)	W (mm)	Pin1 Quadrant
TPS61291DRVR	WSON	DRV	6	3000	180.0	8.4	2.3	2.3	1.15	4.0	8.0	Q2
TPS61291DRVT	WSON	DRV	6	250	180.0	8.4	2.3	2.3	1.15	4.0	8.0	Q2

**TAPE AND REEL BOX DIMENSIONS**

\*All dimensions are nominal

Device	Package Type	Package Drawing	Pins	SPQ	Length (mm)	Width (mm)	Height (mm)
TPS61291DRVR	WSON	DRV	6	3000	182.0	182.0	20.0
TPS61291DRVT	WSON	DRV	6	250	210.0	185.0	35.0

## GENERIC PACKAGE VIEW

DRV 6

WSO - 0.8 mm max height

PLASTIC SMALL OUTLINE - NO LEAD



Images above are just a representation of the package family, actual package may vary.  
Refer to the product data sheet for package details.

4206925/F

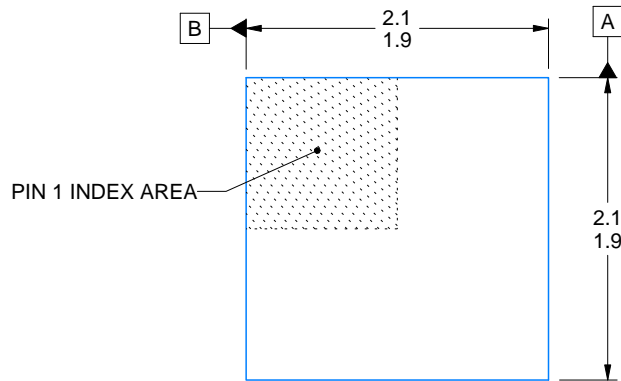

4222173/B 04/2018

NOTES:

1. All linear dimensions are in millimeters. Any dimensions in parenthesis are for reference only. Dimensioning and tolerancing per ASME Y14.5M.
2. This drawing is subject to change without notice.
3. The package thermal pad must be soldered to the printed circuit board for thermal and mechanical performance.

# EXAMPLE BOARD LAYOUT

DRV0006A

WSON - 0.8 mm max height

PLASTIC SMALL OUTLINE - NO LEAD

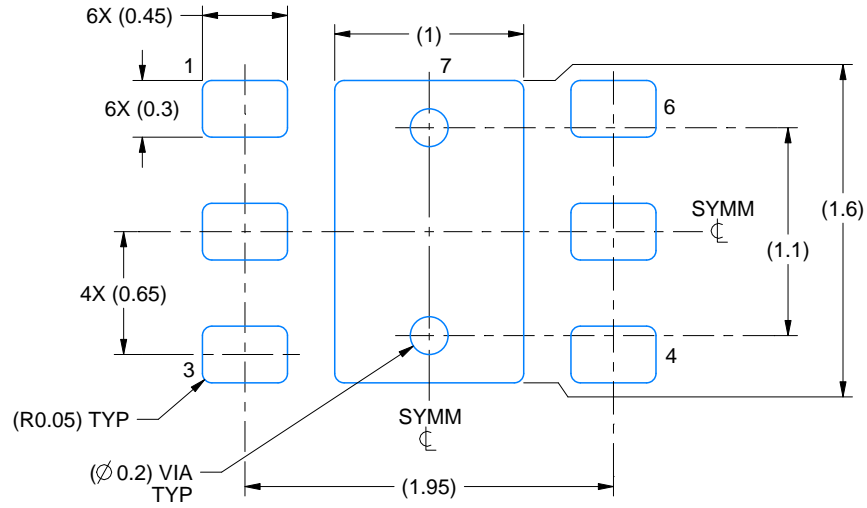

LAND PATTERN EXAMPLE  
SCALE:25X

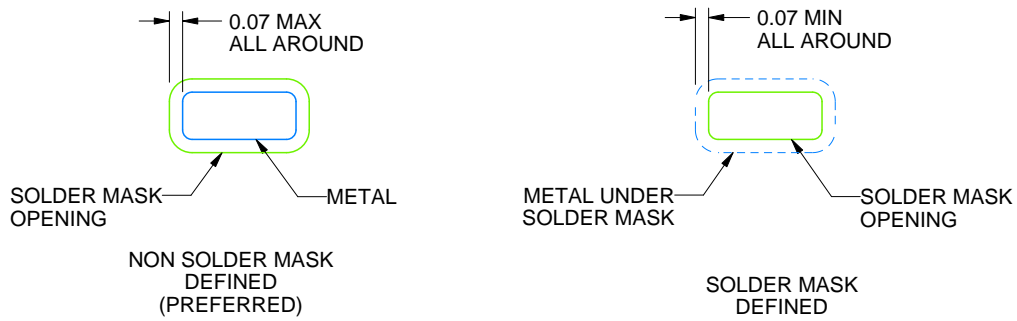

SOLDER MASK DETAILS

4222173/B 04/2018

NOTES: (continued)

4. This package is designed to be soldered to a thermal pad on the board. For more information, see Texas Instruments literature number SLUA271 ([www.ti.com/lit/sluea271](http://www.ti.com/lit/sluea271)).
5. Vias are optional depending on application, refer to device data sheet. If some or all are implemented, recommended via locations are shown.



# EXAMPLE STENCIL DESIGN

DRV0006A

WSON - 0.8 mm max height

PLASTIC SMALL OUTLINE - NO LEAD



SOLDER PASTE EXAMPLE  
BASED ON 0.125 mm THICK STENCIL

EXPOSED PAD #7  
88% PRINTED SOLDER COVERAGE BY AREA UNDER PACKAGE  
SCALE:30X

4222173/B 04/2018

NOTES: (continued)

6. Laser cutting apertures with trapezoidal walls and rounded corners may offer better paste release. IPC-7525 may have alternate design recommendations.

## IMPORTANT NOTICE AND DISCLAIMER

TI PROVIDES TECHNICAL AND RELIABILITY DATA (INCLUDING DATA SHEETS), DESIGN RESOURCES (INCLUDING REFERENCE DESIGNS), APPLICATION OR OTHER DESIGN ADVICE, WEB TOOLS, SAFETY INFORMATION, AND OTHER RESOURCES "AS IS" AND WITH ALL FAULTS, AND DISCLAIMS ALL WARRANTIES, EXPRESS AND IMPLIED, INCLUDING WITHOUT LIMITATION ANY IMPLIED WARRANTIES OF MERCHANTABILITY, FITNESS FOR A PARTICULAR PURPOSE OR NON-INFRINGEMENT OF THIRD PARTY INTELLECTUAL PROPERTY RIGHTS.

These resources are intended for skilled developers designing with TI products. You are solely responsible for (1) selecting the appropriate TI products for your application, (2) designing, validating and testing your application, and (3) ensuring your application meets applicable standards, and any other safety, security, regulatory or other requirements.

These resources are subject to change without notice. TI grants you permission to use these resources only for development of an application that uses the TI products described in the resource. Other reproduction and display of these resources is prohibited. No license is granted to any other TI intellectual property right or to any third party intellectual property right. TI disclaims responsibility for, and you will fully indemnify TI and its representatives against, any claims, damages, costs, losses, and liabilities arising out of your use of these resources.

TI's products are provided subject to [TI's Terms of Sale](#) or other applicable terms available either on [ti.com](https://www.ti.com) or provided in conjunction with such TI products. TI's provision of these resources does not expand or otherwise alter TI's applicable warranties or warranty disclaimers for TI products.

TI objects to and rejects any additional or different terms you may have proposed.

Mailing Address: Texas Instruments, Post Office Box 655303, Dallas, Texas 75265

Copyright © 2025, Texas Instruments Incorporated