

2.25-MHz 600-mA STEP-DOWN CONVERTERS

Check for Samples: [TPS62260-Q1](#), [TPS62261-Q1](#), [TPS62262-Q1](#), [TPS62263-Q1](#)

FEATURES

- Qualified for Automotive Applications
- High-Efficiency Step-Down Converter
- Output Current up to 600 mA
- Wide V_{IN} Range from 2-V to 6-V for Li-Ion Batteries with Extended Voltage Range
- 2.25-MHz Fixed Frequency Operation
- Power Save Mode at Light Load Currents
- Output Voltage Accuracy in PWM Mode $\pm 1.5\%$
- 15- μ A (Typ) Quiescent Current
- 100% Duty Cycle for Lowest Dropout

- Soft Start
- Voltage Positioning at Light Loads
- Available in a Small 2x2x0,8-mm SON Package
- Allows <1-mm Solution Height

APPLICATIONS

- PDAs, Pocket PCs
- Low Power DSP Supply
- Portable Media Players
- POL applications

DESCRIPTION

The TPS6226x devices are high-efficiency synchronous step-down dc-dc converters optimized for battery powered applications. It provides up to 600-mA output current from a single Li-Ion cell and is ideal to power mobile phones and other portable applications.

With an wide input voltage range of 2 V to 6 V, the device supports applications powered by Li-Ion batteries with extended voltage range, two and three cell alkaline batteries, 3.3-V and 5-V input voltage rails.

The TPS6226x operates at 2.25-MHz fixed switching frequency and enters Power Save Mode operation at light load currents to maintain high efficiency over the entire load current range.

The Power Save Mode is optimized for low output voltage ripple. For low noise applications, the device can be forced into fixed frequency PWM mode by pulling the MODE pin high. In the shutdown mode, the current consumption is reduced to less than 1 μ A. TPS6226x allows the use of small inductors and capacitors to achieve a small solution size.

The TPS6226x is available in a very small 2x2mm 6-pin SON package.

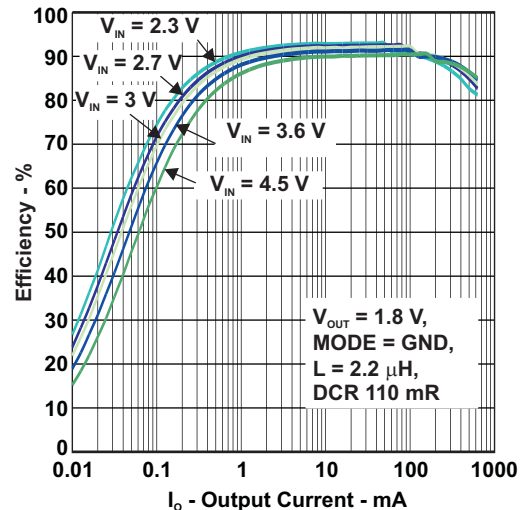
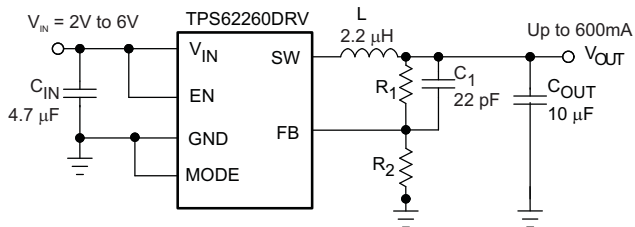

Please be aware that an important notice concerning availability, standard warranty, and use in critical applications of Texas Instruments semiconductor products and disclaimers thereto appears at the end of this data sheet.

PowerPAD is a trademark of Texas Instruments.



This integrated circuit can be damaged by ESD. Texas Instruments recommends that all integrated circuits be handled with appropriate precautions. Failure to observe proper handling and installation procedures can cause damage.

ESD damage can range from subtle performance degradation to complete device failure. Precision integrated circuits may be more susceptible to damage because very small parametric changes could cause the device not to meet its published specifications.

ORDERING INFORMATION⁽¹⁾

T _A	OUTPUT VOLTAGE	PACKAGE ⁽²⁾		ORDERABLE PART NUMBER	TOP-SIDE MARKING
-40°C to 85°C	Adjustable	SON – DRV	Reel of 3000	TPS62260IDRVRQ1	OEO
-40°C to 105°C	1.8 V			TPS62261TDRVRQ1	OFE
	1.2 V			TPS62262TDRVRQ1	OFF
	2.5 V			TPS62263TDRVRQ1	OFG
-40°C to 105°C	Adjustable			TPS62260TDRVRQ1	OEO

(1) For the most current package and ordering information, see the Package Option Addendum at the end of this document, or see the TI web site at www.ti.com.

(2) Package drawings, thermal data, and symbolization are available at www.ti.com/packaging.

ABSOLUTE MAXIMUM RATINGS⁽¹⁾

over operating free-air temperature range (unless otherwise noted)

Input voltage range ⁽²⁾	-0.3 V to 7 V	
Voltage range at EN, MODE	-0.3 V to V _{IN} +0.3 V, ≤ 7 V	
Voltage on SW	-0.3 V to 7 V	
Peak output current	Internally limited	
ESD rating ⁽³⁾	HBM, Human-body model	2000 V
	CDM, Charged-device model	1000 V
	MM, Machine model	200 V
T _J Operating junction temperature	-40°C to 125°C	
T _{stg} Storage temperature range	-65°C to 150°C	

(1) Stresses beyond those listed under *absolute maximum ratings* may cause permanent damage to the device. These are stress ratings only and functional operation of the device at these or any other conditions beyond those indicated under *recommended operating conditions* is not implied. Exposure to absolute-maximum-rated conditions for extended periods may affect device reliability.

(2) All voltage values are with respect to network ground terminal.

(3) The human body model is a 100-pF capacitor discharged through a 1.5-kΩ resistor into each pin. The machine model is a 200-pF capacitor discharged directly into each pin.

DISSIPATION RATINGS

PACKAGE	R _{θJA}	POWER RATING FOR T _A ≤ 25°C	DERATING FACTOR ABOVE T _A = 25°C
DRV	76°C/W	1300 mW	13 mW/°C

RECOMMENDED OPERATING CONDITIONS

		MIN	NOM	MAX	UNIT
V _{IN}	Supply voltage	2		6	V
	Output voltage range for adjustable voltage	0.6		V _{IN}	V
T _A	Operating ambient temperature	TPS62260IDRVRQ1	-40	85	°C
		TPS6226XTDRVRQ1	-40	105	
T _J	Operating junction temperature	-40		125	°C

ELECTRICAL CHARACTERISTICS

Over full operating ambient temperature range, typical values are at $T_A = 25^\circ\text{C}$. Unless otherwise noted, specifications apply for condition $V_{IN} = EN = 3.6\text{V}$. External components $C_{IN} = 4.7\mu\text{F}$ 0603, $C_{OUT} = 10\mu\text{F}$ 0603, $L = 2.2\mu\text{H}$, see the parameter measurement information.

PARAMETER		TEST CONDITIONS	MIN	TYP	MAX	UNIT
Supply						
V_{IN}	Input voltage range		2.3		6	V
I_{OUT}	Output current ⁽¹⁾	$V_{IN} 2.5\text{ V to }6\text{ V}$			600	mA
		$V_{IN} 2.3\text{ V to }2.5\text{ V}$			300	
		$V_{IN} 2\text{ V to }2.3\text{ V}$			150	
I_Q	Operating quiescent current	$I_{OUT} = 0\text{ mA}$, PFM mode enabled (MODE = GND), device not switching		15		μA
		$I_{OUT} = 0\text{ mA}$, PFM mode ⁽²⁾ enabled (MODE = GND), device switching, $V_{OUT} = 1.8\text{ V}$		18.5		
		$I_{OUT} = 0\text{ mA}$, switching with no load (MODE = V_{IN}), PWM operation, $V_{OUT} = 1.8\text{ V}$, $V_{IN} = 3\text{ V}$		3.8		mA
I_{SD}	Shutdown current	EN = GND	$T_A = 25^\circ\text{C}$	0.1	1	μA
			$T_A = 105^\circ\text{C}$			
UVLO	Undervoltage lockout threshold	Falling		1.85		V
		Rising		1.95		
Enable, Mode						
V_{IH}	High level input voltage, EN, MODE	$2\text{ V} \leq V_{IN} \leq 6\text{ V}$	1		V_{IN}	V
V_{IL}	Low level input voltage, EN, MODE	$2\text{ V} \leq V_{IN} \leq 6\text{ V}$	0		0.4	V
I_{IN}	Input bias current, EN, MODE	EN, MODE = GND or V_{IN}		0.01	1	μA
Power Switch						
$R_{DS(on)}$	High-side MOSFET on-resistance	$V_{IN} = V_{GS} = 3.6\text{ V}$, $T_A = 25^\circ\text{C}$		240	480	$\text{m}\Omega$
	Low-side MOSFET on-resistance			185	380	
I_{LIMF}	Forward current limit MOSFET, high side and low side	$V_{IN} = V_{GS} = 3.6\text{ V}$, $T_A = 25^\circ\text{C}$	0.8	1	1.3	A
T_{SD}	Thermal shutdown	Increasing junction temperature		140		$^\circ\text{C}$
	Thermal shutdown hysteresis	Decreasing junction temperature		20		
Oscillator						
f_{SW}	Oscillator frequency	$2\text{ V} \leq V_{IN} \leq 6\text{ V}$	2	2.25	2.5	MHz
Output						
V_{OUT}	Adjustable output voltage range		0.6		V_{IN}	V
V_{ref}	Reference voltage			600		mV
V_{FB}	Feedback voltage PWM mode	MODE = V_{IN} , PWM operation, for fixed output voltage versions $V_{FB} = V_{OUT}$, ⁽³⁾ $2.5\text{ V} \leq V_{IN} \leq 6\text{ V}$, $0\text{ mA} \leq I_{OUT} \leq 600\text{ mA}$	-1.5%	0%	1.5%	
	Feedback voltage PFM mode	MODE = GND, device in PFM mode, voltage positioning active ⁽²⁾		1%		
	Load regulation	PWM Mode		-0.5		
$t_{Start Up}$	Start-up time	Time from active EN to reach 95% of V_{OUT} nominal		500		μs
t_{Ramp}	V_{OUT} ramp-up time	Time to ramp from 5% to 95% of V_{OUT}		250		μs
I_{lkg}	Leakage current into SW pin	$V_{IN} = 3.6\text{ V}$, $V_{IN} = V_{OUT} = V_{SW}$, EN = GND ⁽⁴⁾		0.1	1	μA

(1) Not production tested

(2) In PFM mode, the internal reference voltage is set to typ. $1.01 \times V_{ref}$. See the parameter measurement information.

(3) For $V_{IN} = V_O + 0.6\text{ V}$

(4) In fixed output voltage versions, the internal resistor divider network is disconnected from FB pin.

PIN ASSIGNMENTS

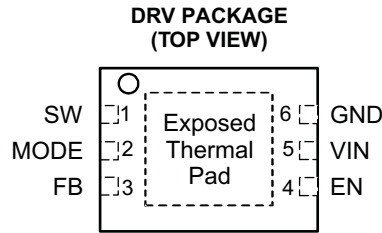

TERMINAL FUNCTIONS

TERMINAL		I/O	DESCRIPTION
NAME	NO.		
SW	1	OUT	This is the switch pin and is connected to the internal MOSFET switches. Connect the external inductor between this terminal and the output capacitor.
MODE	2	I	This pin is only available at SON package option. MODE pin = high forces the device to operate in fixed frequency PWM mode. MODE pin = low enables the Power Save Mode with automatic transition from PFM mode to fixed frequency PWM mode.
FB	3	I	Feedback for the internal regulation loop. Connect the external resistor divider to this pin. In case of fixed output voltage option, connect this pin directly to the output capacitor.
EN	4	I	This is the enable pin of the device. Pulling this pin to low forces the device into shutdown mode. Pulling this pin to high enables the device. This pin must be terminated.
V _{IN}	5	PWR	Power supply
GND	6	PWR	Ground

FUNCTIONAL BLOCK DIAGRAM

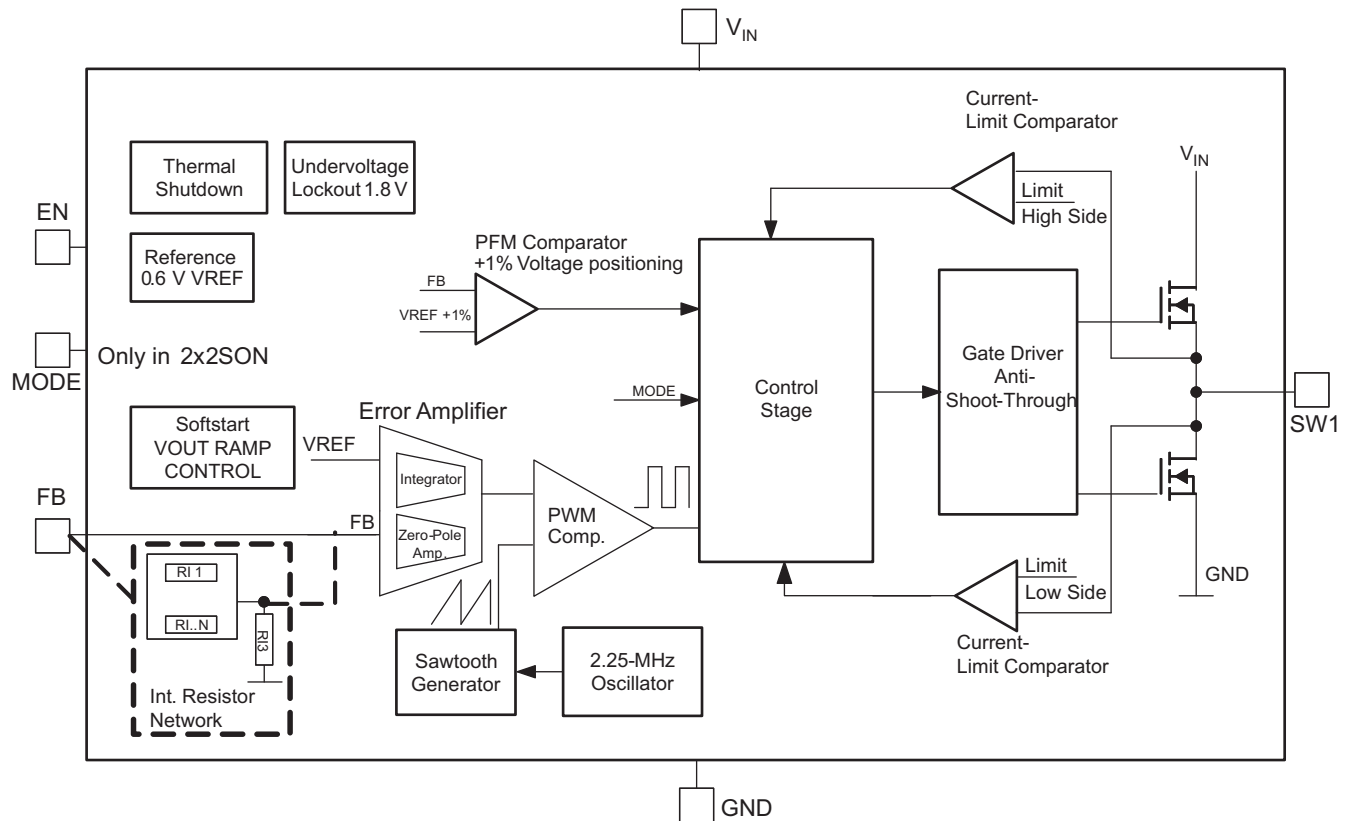

PARAMETER MEASUREMENT INFORMATION

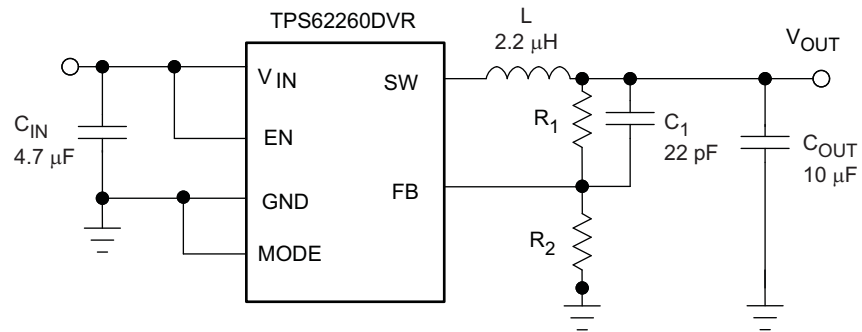

L: LPS3015 2.2 μH, 110 mΩ
 CIN GRM188R60J475K 4.7 μF Murata 0603 size
 COUT GRM188R60J106M 10 μF Murata 0603 size

TYPICAL CHARACTERISTICS

Table 1. Table of Graphs

η Efficiency	Output Current $V_{OUT} = 1.8$ V, Power Save Mode, MODE = GND	Figure 1
	Output Current $V_{OUT} = 1.8$ V, PWM Mode, MODE = V_{IN}	Figure 2
Output Voltage Accuracy	Output Current $V_{OUT} = 1.8$ V, Power Save Mode, MODE = GND	Figure 3
	Output Current $V_{OUT} = 3.3$ V, Power Save Mode, MODE = GND	Figure 4
Typical Operation	Output Current	Figure 5
	Output Current	Figure 6
Mode Transition	at 25°C, $V_{OUT} = 1.8$ V, Power Save Mode, MODE = GND	Figure 7
	at 25°C, $V_{OUT} = 1.8$ V, Power Save Mode, MODE = GND	Figure 8
Start-up Timing	at 25°C, $V_{OUT} = 1.8$ V, Power Save Mode, MODE = GND	Figure 9
	at 25°C, $V_{OUT} = 1.8$ V, Power Save Mode, MODE = GND	Figure 10
Load Transient	at -40°C, $V_{OUT} = 1.8$ V, PWM Mode, MODE = V_{IN}	Figure 11
	at -40°C, $V_{OUT} = 1.8$ V, PWM Mode, MODE = V_{IN}	Figure 12
Line Transient	at 25°C, $V_{OUT} = 1.8$ V, PWM Mode, MODE = V_{IN}	Figure 13
	PWM Mode, $V_{OUT} = 1.8$ V	Figure 14
Typical Operation	MODE Pin Transition From PFM to Forced PWM Mode at light load	Figure 15
	MODE Pin Transition From Forced PWM to PFM Mode at light load	Figure 16
Load Transient	Forced PWM Mode, $V_{OUT} = 1.5$ V, 50 mA to 200 mA	Figure 17
	Forced PWM Mode, $V_{OUT} = 1.5$ V, 200 mA to 400 mA	Figure 18
Line Transient	PFM Mode to PWM Mode, $V_{OUT} = 1.2$ V, 150 μ A to 400 mA	Figure 19
	PFM Mode to PFM Mode, $V_{OUT} = 1.2$ V, 400 mA to 150 μ A	Figure 20
Typical Operation	PWM Mode, $V_{OUT} = 1.5$ V, 10 mA to 50 mA	Figure 21
	PWM Mode, $V_{OUT} = 1.5$ V, 50 mA to 150 mA	Figure 22
Load Transient	PWM Mode to PWM Mode, $V_{OUT} = 1.8$ V, 50 mA to 250 mA	Figure 23
	PWM Mode to PWM Mode, $V_{OUT} = 1.8$ V, 10 mA to 400 mA	Figure 24
Line Transient	PWM Mode to PWM Mode, $V_{OUT} = 1.5$ V, 50 mA to 400 mA	Figure 25
	PWM Mode to PFM Mode, $V_{OUT} = 1.5$ V, 400 mA to 50 mA	Figure 26
Typical Operation	PWM Mode, $V_{OUT} = 1.8$ V, 50 mA	Figure 27
	PWM Mode, $V_{OUT} = 1.8$ V, 150 mA	Figure 28
Shutdown Current into V_{IN}	PWM Mode, Ripple, $V_{OUT} = 1.8$ V, 10 mA, L = 2.2 μ H, $C_{OUT} = 10$ μ F	Figure 29
	PWM Mode, Ripple, $V_{OUT} = 1.8$ V, 10 mA, L = 4.7 μ H, $C_{OUT} = 10$ μ F	Figure 30
Quiescent Current	vs Input Voltage, ($T_A = 85^\circ$ C, $T_A = 25^\circ$ C, $T_A = -40^\circ$ C)	Figure 31
	vs Input Voltage, ($T_A = 85^\circ$ C, $T_A = 25^\circ$ C, $T_A = -40^\circ$ C)	Figure 32
Static Drain Source On-State Resistance	vs Input Voltage, ($T_A = 85^\circ$ C, $T_A = 25^\circ$ C, $T_A = -40^\circ$ C)	Figure 33
	vs Input Voltage, ($T_A = 85^\circ$ C, $T_A = 25^\circ$ C, $T_A = -40^\circ$ C)	Figure 33

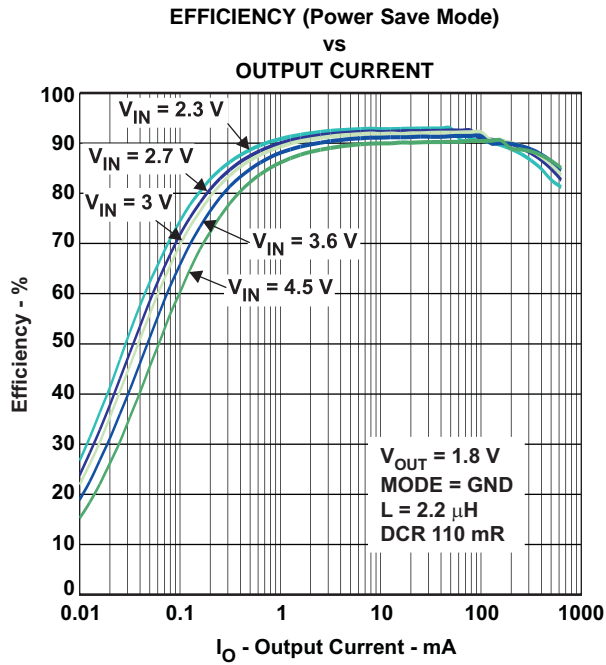

Figure 1.

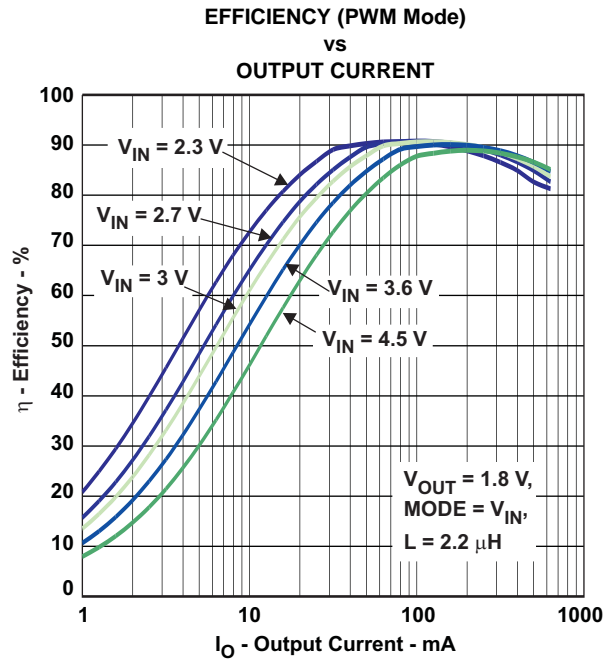
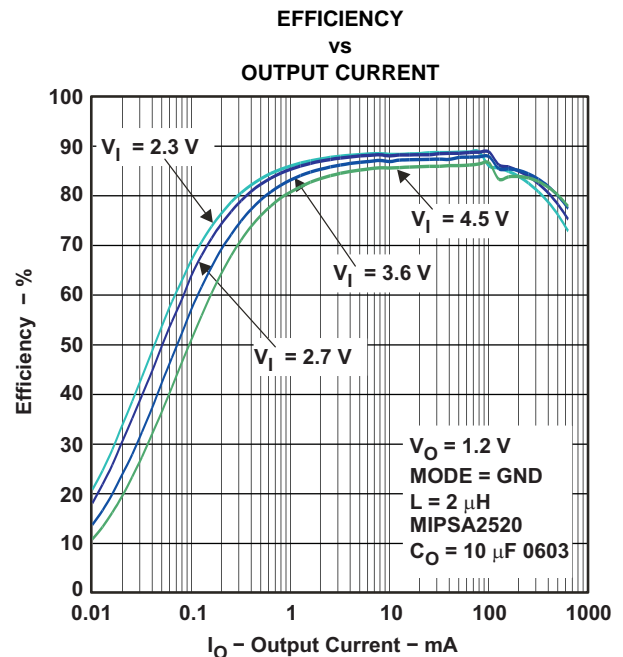
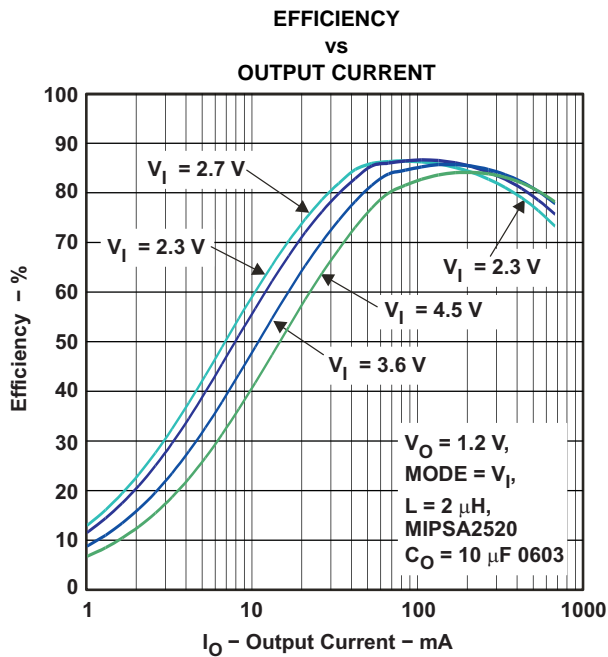
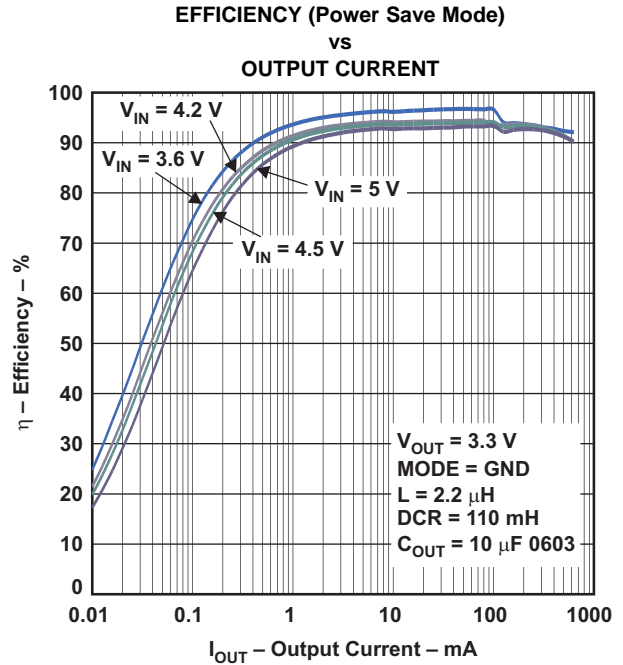
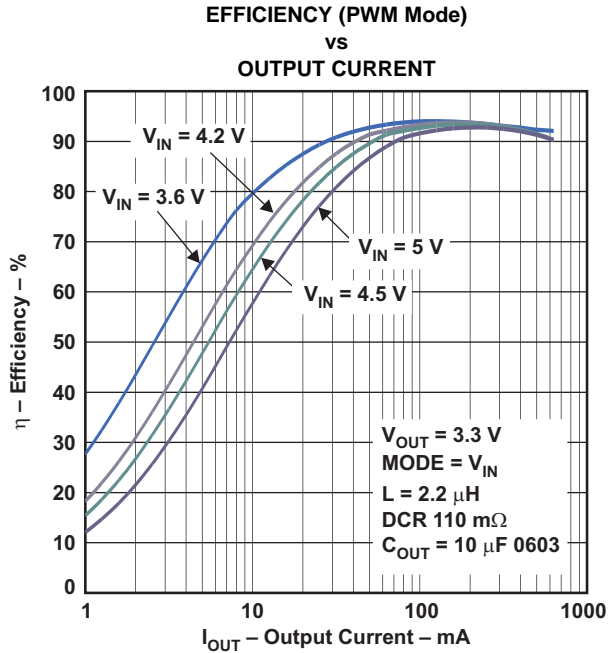
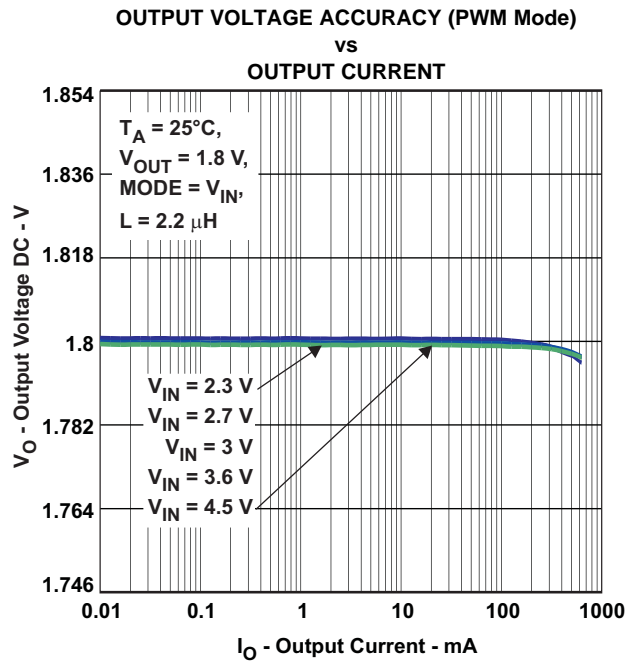
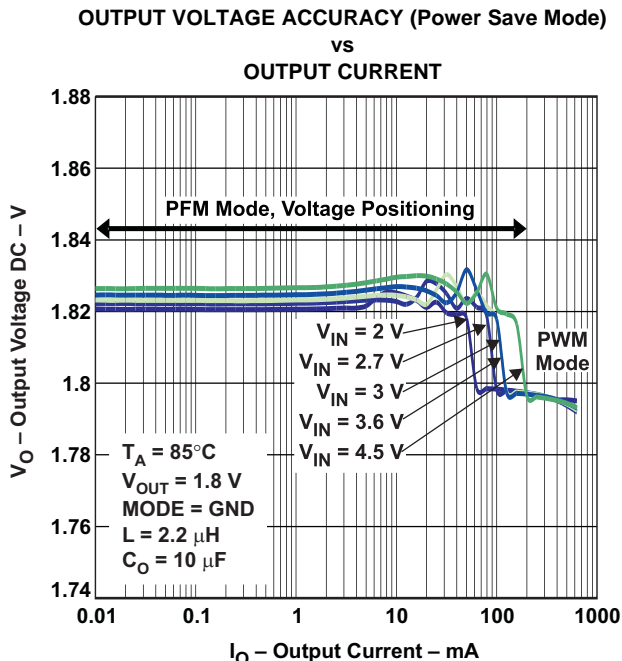
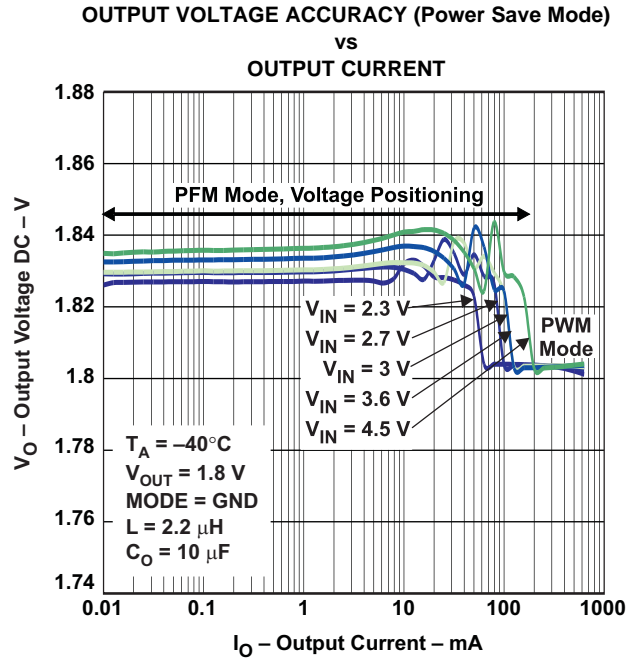
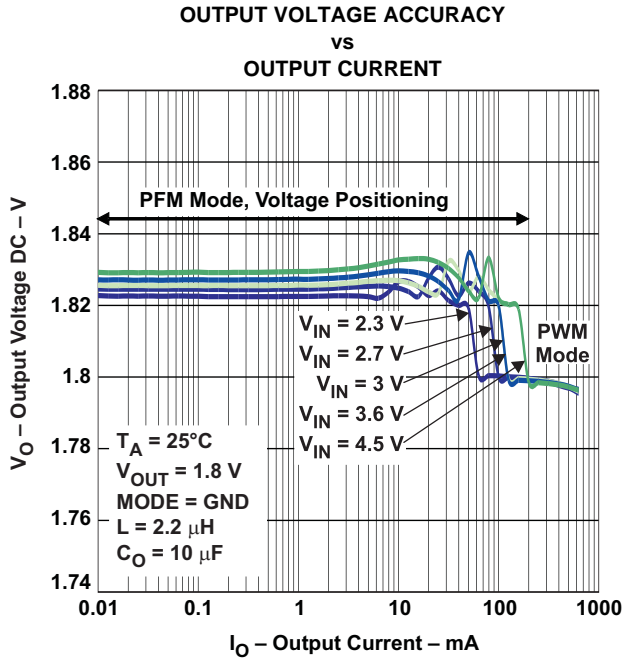
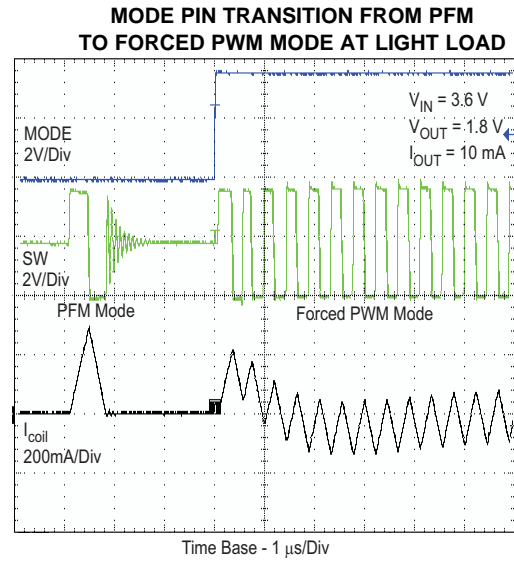
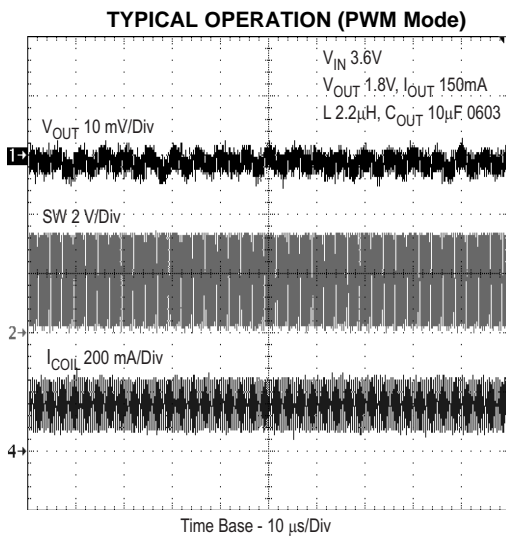
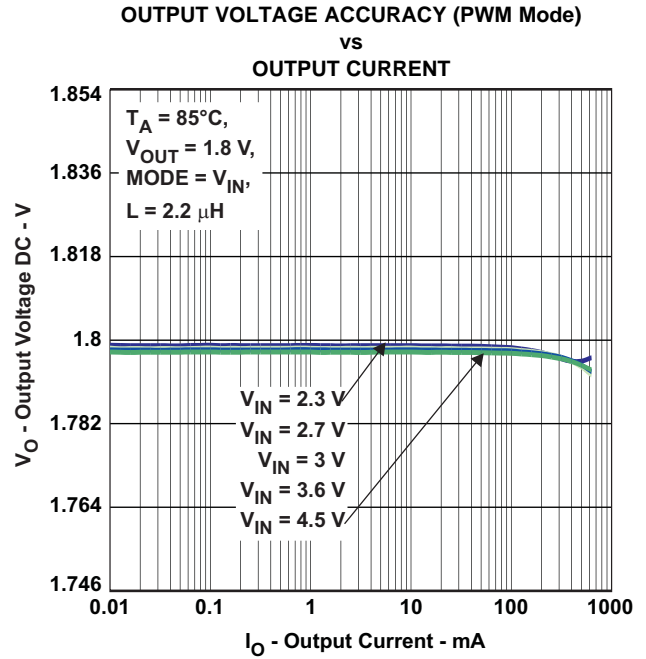
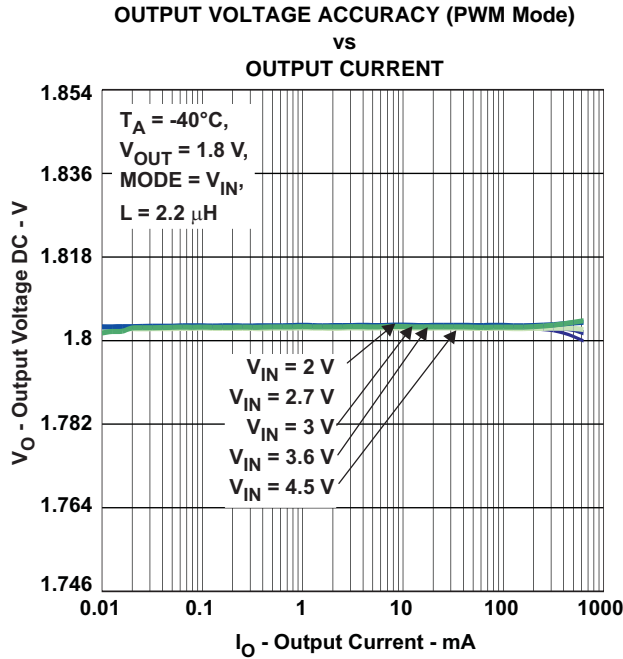

Figure 2.







**MODE PIN TRANSITION FROM PWM
TO PFM MODE AT LIGHT LOAD**

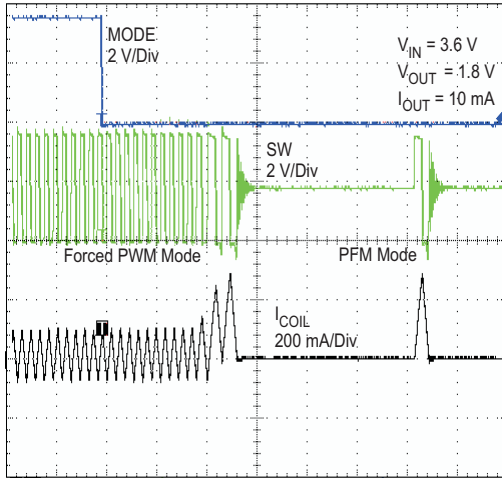

Figure 15.

START-UP TIMING

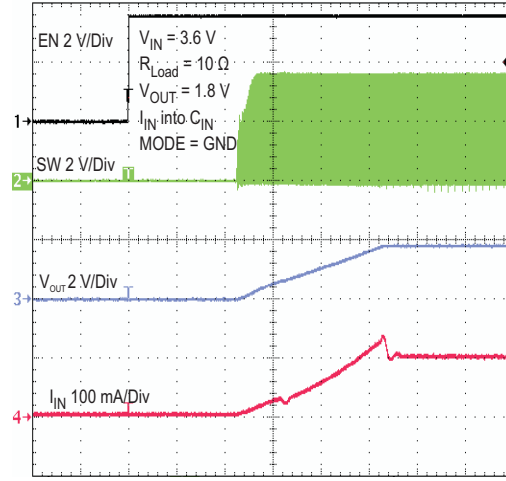

Figure 16.

**LOAD TRANSIENT
(Forced PWM Mode)**

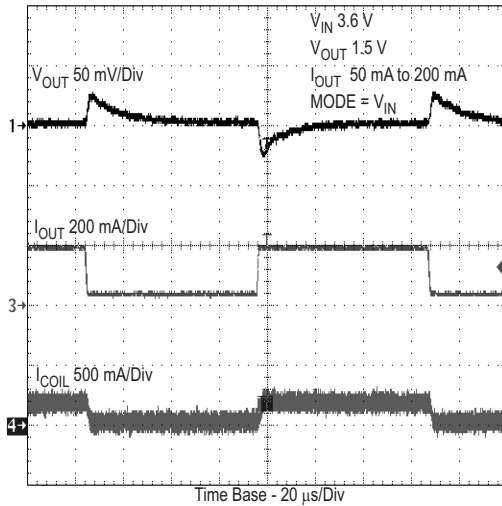

Figure 17.

**LOAD TRANSIENT
(Forced PWM Mode)**

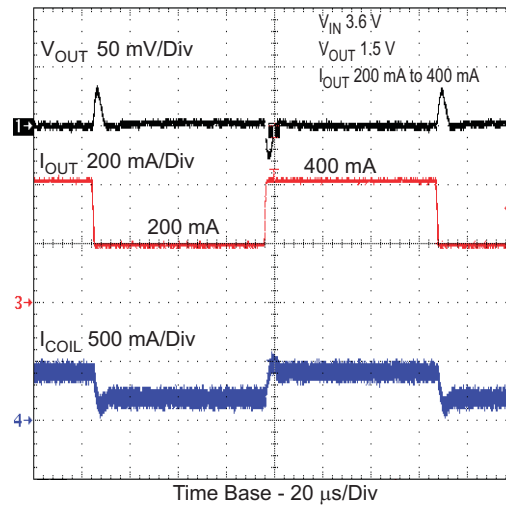

Figure 18.

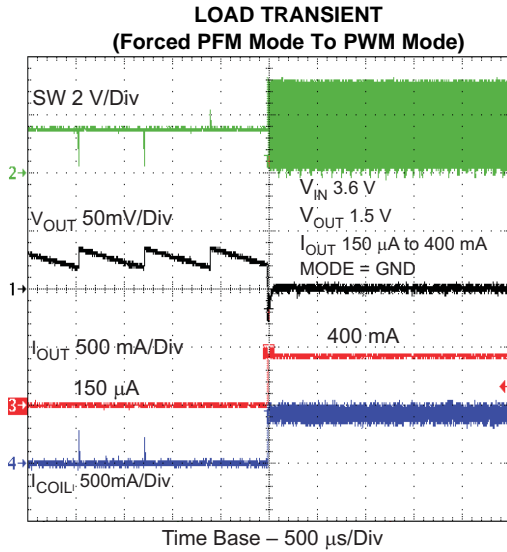

Figure 19.

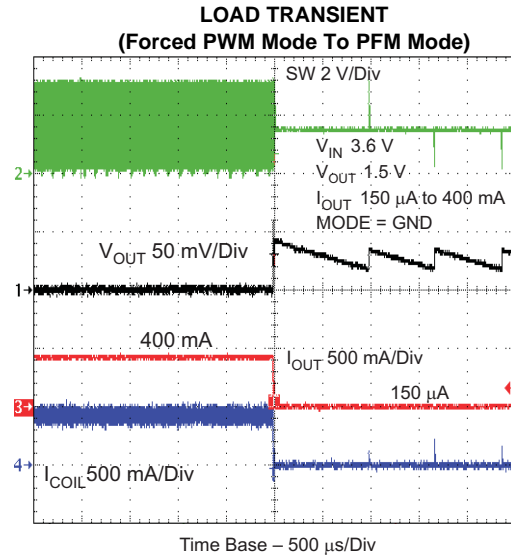

Figure 20.

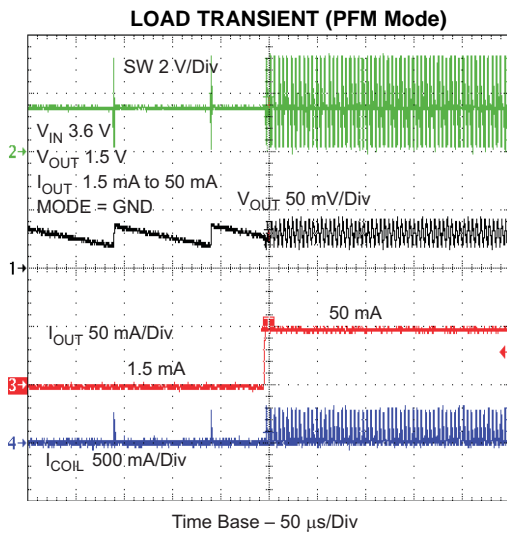

Figure 21.

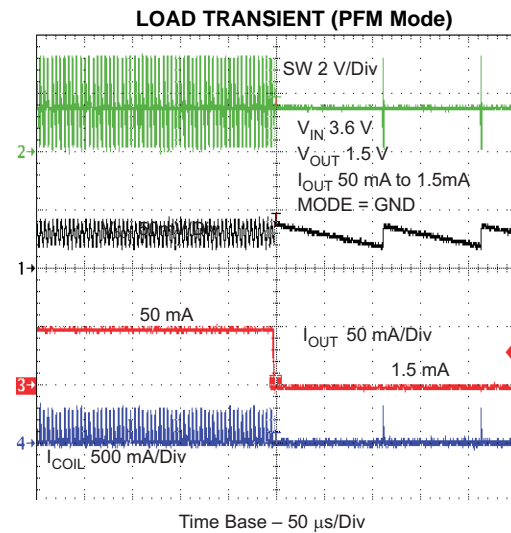

Figure 22.

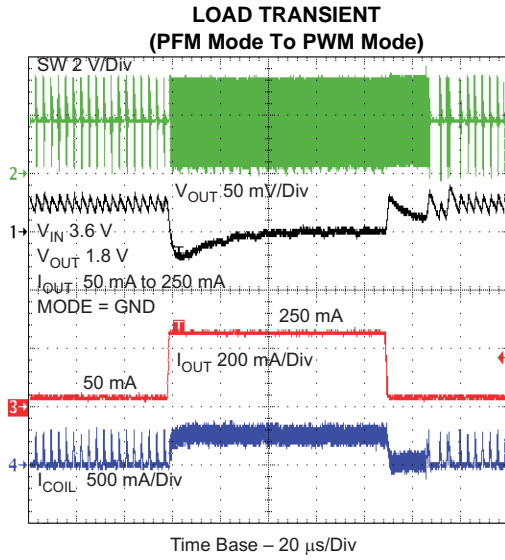

Figure 23.

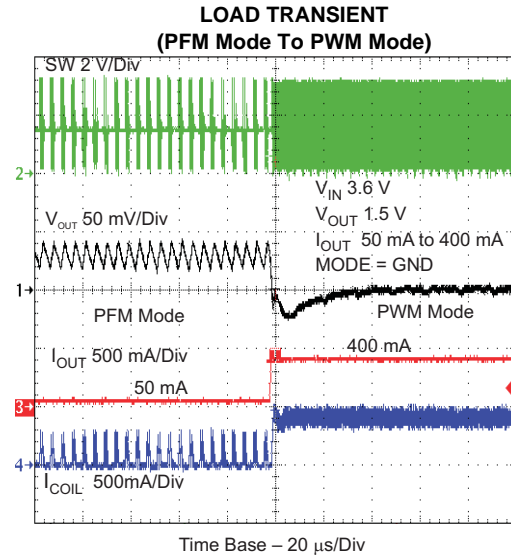

Figure 24.

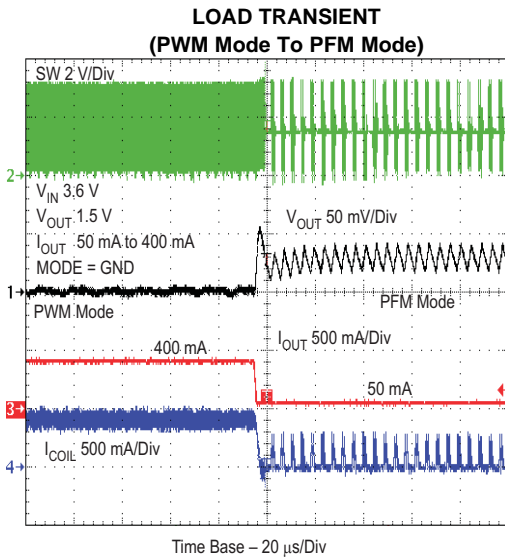

Figure 25.

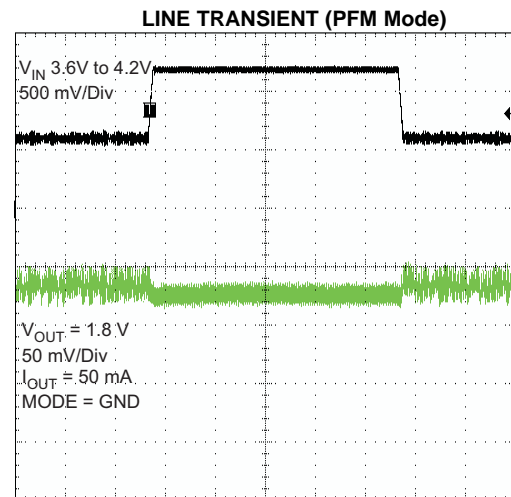

Figure 26.

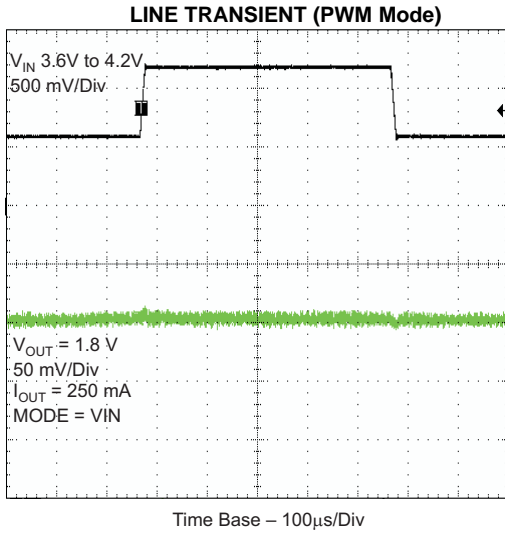

Figure 27.

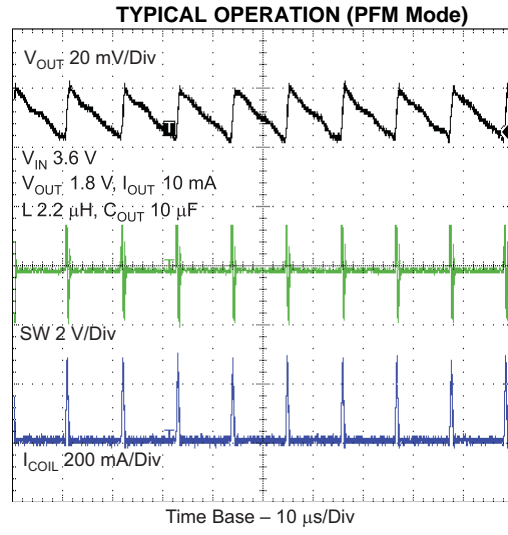

Figure 28.

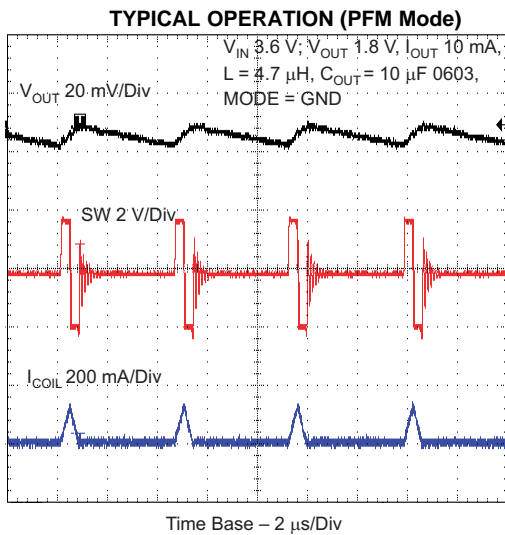

Figure 29.

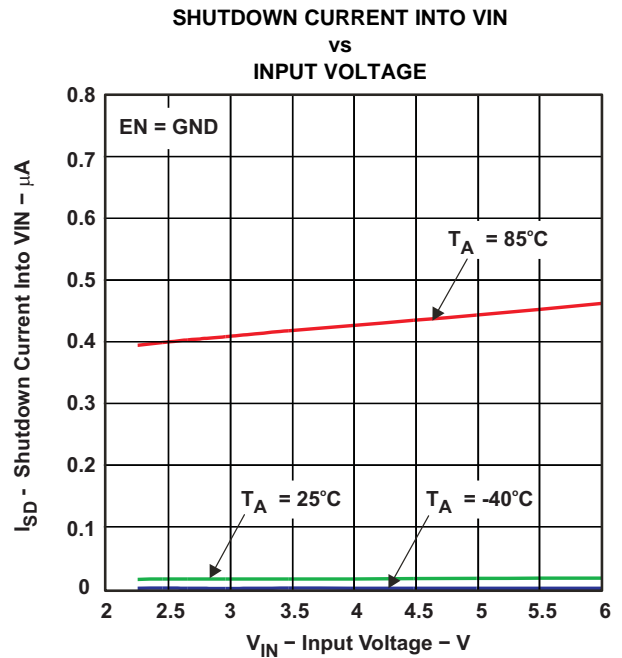

Figure 30.

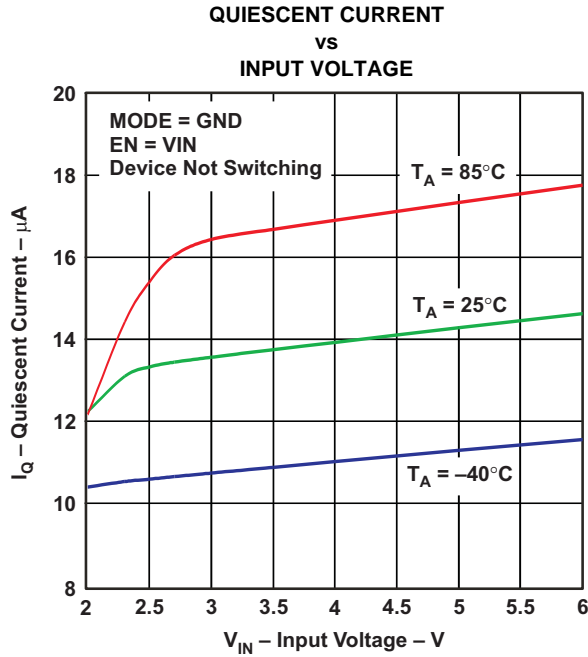

Figure 31.

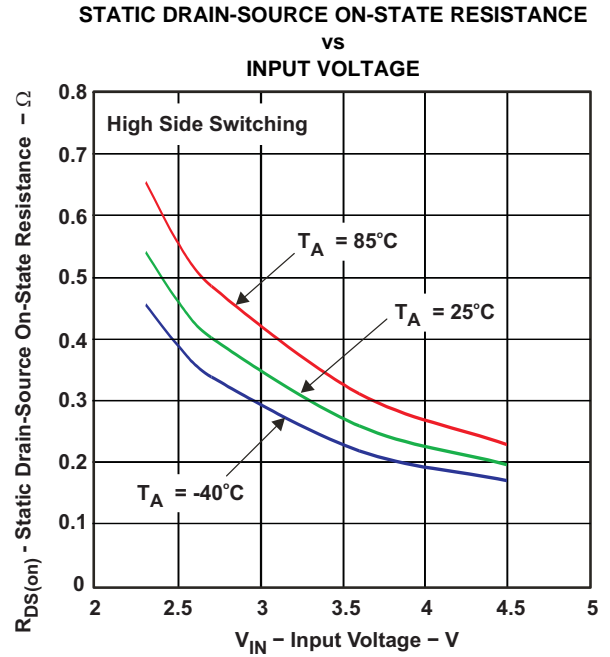

Figure 32.

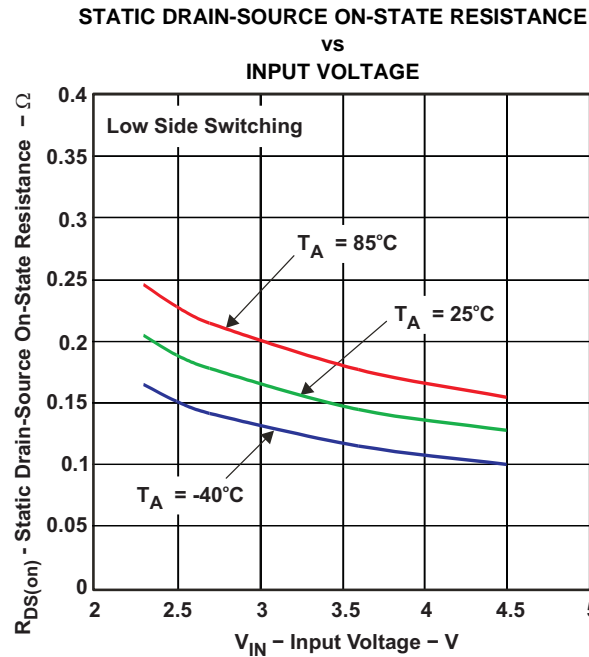

Figure 33.

DETAILED DESCRIPTION

OPERATION

The TPS6226x step down converter operates with typically 2.25 MHz fixed frequency pulse width modulation (PWM) at moderate to heavy load currents. At light load currents the converter can automatically enter Power Save Mode and operates then in PFM mode.

During PWM operation the converter use a unique fast response voltage mode control scheme with input voltage feed-forward to achieve good line and load regulation allowing the use of small ceramic input and output capacitors. At the beginning of each clock cycle initiated by the clock signal, the High Side MOSFET switch is turned on. The current flows now from the input capacitor via the High Side MOSFET switch through the inductor to the output capacitor and load. During this phase, the current ramps up until the PWM comparator trips and the control logic will turn off the switch. The current limit comparator will also turn off the switch in case the current limit of the High Side MOSFET switch is exceeded. After a dead time preventing shoot through current, the Low Side MOSFET rectifier is turned on and the inductor current will ramp down. The current flows now from the inductor to the output capacitor and to the load. It returns back to the inductor through the Low Side MOSFET rectifier.

The next cycle will be initiated by the clock signal again turning off the Low Side MOSFET rectifier and turning on the High Side MOSFET switch.

POWER SAVE MODE

The Power Save Mode is enabled with MODE Pin set to low level. If the load current decreases, the converter will enter Power Save Mode operation automatically. During Power Save Mode the converter skips switching and operates with reduced frequency in PFM mode with a minimum quiescent current to maintain high efficiency. The converter will position the output voltage typically +1% above the nominal output voltage. This voltage positioning feature minimizes voltage drops caused by a sudden load step.

The transition from PWM mode to PFM mode occurs once the inductor current in the Low Side MOSFET switch becomes zero, which indicates discontinuous conduction mode.

During the Power Save Mode the output voltage is monitored with a PFM comparator. As the output voltage falls below the PFM comparator threshold of V_{OUT} nominal +1%, the device starts a PFM current pulse. The High Side MOSFET switch will turn on, and the inductor current ramps up. After the On-time expires, the switch is turned off and the Low Side MOSFET switch is turned on until the inductor current becomes zero.

The converter effectively delivers a current to the output capacitor and the load. If the load is below the delivered current, the output voltage will rise. If the output voltage is equal or higher than the PFM comparator threshold, the device stops switching and enters a sleep mode with typical 15µA current consumption.

If the output voltage is still below the PFM comparator threshold, a sequence of further PFM current pulses are generated until the PFM comparator threshold is reached. The converter starts switching again once the output voltage drops below the PFM comparator threshold.

With a fast single threshold comparator, the output voltage ripple during PFM mode operation can be kept small. The PFM Pulse is time controlled, which allows to modify the charge transferred to the output capacitor by the value of the inductor. The resulting PFM output voltage ripple and PFM frequency depend in first order on the size of the output capacitor and the inductor value. Increasing output capacitor values and inductor values will minimize the output ripple. The PFM frequency decreases with smaller inductor values and increases with larger values.

The PFM mode is left and PWM mode entered in case the output current can not longer be supported in PFM mode. The Power Save Mode can be disabled through the MODE pin set to high. The converter will then operate in fixed frequency PWM mode.

Dynamic Voltage Positioning

This feature reduces the voltage under/overshoots at load steps from light to heavy load and vice versa. It is active in Power Save Mode and regulates the output voltage 1% higher than the nominal value. This provides more headroom for both the voltage drop at a load step, and the voltage increase at a load throw-off.

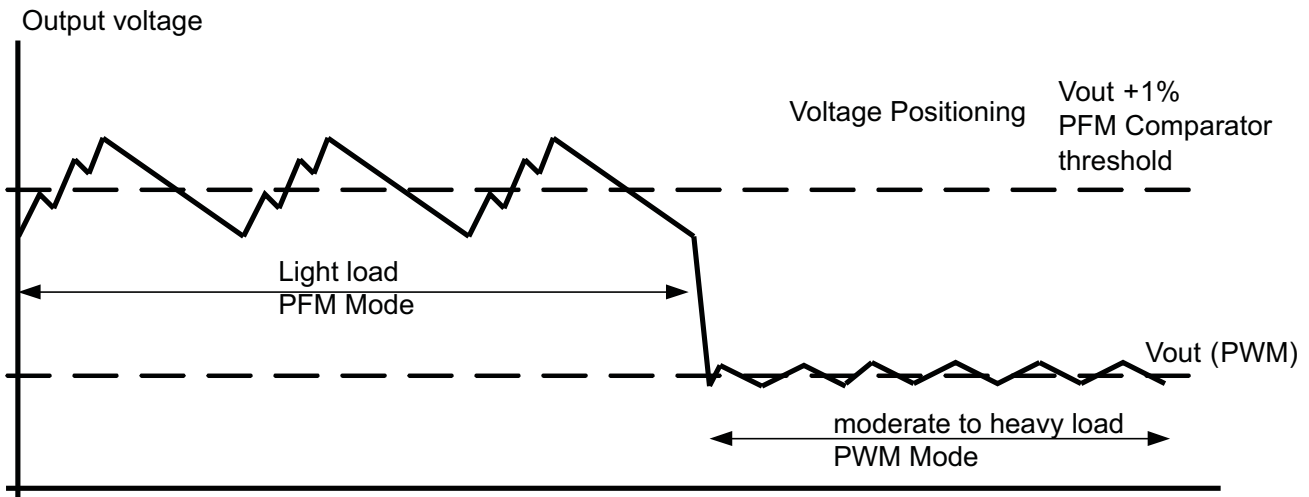

Figure 34. Power Save Mode Operation with automatic Mode transition

100% Duty Cycle Low Dropout Operation

The device starts to enter 100% duty cycle mode once the input voltage comes close to the nominal output voltage. In order to maintain the output voltage, the High Side MOSFET switch is turned on 100% for one or more cycles.

With further decreasing V_{IN} the High Side MOSFET switch is turned on completely. In this case the converter offers a low input-to-output voltage difference. This is particularly useful in battery-powered applications to achieve longest operation time by taking full advantage of the whole battery voltage range.

The minimum input voltage to maintain regulation depends on the load current and output voltage, and can be calculated as:

$$V_{INmin} = V_{Omax} + I_{Omax} \times (R_{DS(on)max} + R_L)$$

With:

I_{Omax} = maximum output current plus inductor ripple current

$R_{DS(on)max}$ = maximum P-channel switch $R_{DS(on)}$.

R_L = DC resistance of the inductor

V_{Omax} = nominal output voltage plus maximum output voltage tolerance

Undervoltage Lockout

The undervoltage lockout circuit prevents the device from malfunctioning at low input voltages and from excessive discharge of the battery and disables the output stage of the converter. The undervoltage lockout threshold is typically 1.85V with falling V_{IN} .

MODE SELECTION

The MODE pin allows mode selection between forced PWM mode and Power Save Mode.

Connecting this pin to GND enables the Power Save Mode with automatic transition between PWM and PFM mode. Pulling the MODE pin high forces the converter to operate in fixed frequency PWM mode even at light load currents. This allows simple filtering of the switching frequency for noise sensitive applications. In this mode, the efficiency is lower compared to the power save mode during light loads.

The condition of the MODE pin can be changed during operation and allows efficient power management by adjusting the operation mode of the converter to the specific system requirements.

ENABLE

The device is enabled setting EN pin to high. During the start up time $t_{\text{Start Up}}$ the internal circuits are settled and the soft start circuit is activated. The EN input can be used to control power sequencing in a system with various DC/DC converters. The EN pin can be connected to the output of another converter, to drive the EN pin high and getting a sequencing of supply rails. With EN = GND, the device enters shutdown mode in which all internal circuits are disabled. In fixed output voltage versions, the internal resistor divider network is then disconnected from FB pin.

SOFT START

The TPS6226x has an internal soft start circuit that controls the ramp up of the output voltage. The output voltage ramps up from 5% to 95% of its nominal value within typical 250 μ s. This limits the inrush current in the converter during ramp up and prevents possible input voltage drops when a battery or high impedance power source is used. The soft start circuit is enabled within the start up time $t_{\text{Start Up}}$.

SHORT-CIRCUIT PROTECTION

The High Side and Low Side MOSFET switches are short-circuit protected with maximum switch current = I_{LIMF} . The current in the switches is monitored by current limit comparators. Once the current in the High Side MOSFET switch exceeds the threshold of its current limit comparator, it turns off and the Low Side MOSFET switch is activated to ramp down the current in the inductor and High Side MOSFET switch. The High Side MOSFET switch can only turn on again, once the current in the Low Side MOSFET switch has decreased below the threshold of its current limit comparator.

THERMAL SHUTDOWN

As soon as the junction temperature, T_j , exceeds 140°C (typical) the device goes into thermal shutdown. In this mode, the High Side and Low Side MOSFETs are turned-off. The device continues its operation when the junction temperature falls below the thermal shutdown hysteresis.

APPLICATION INFORMATION

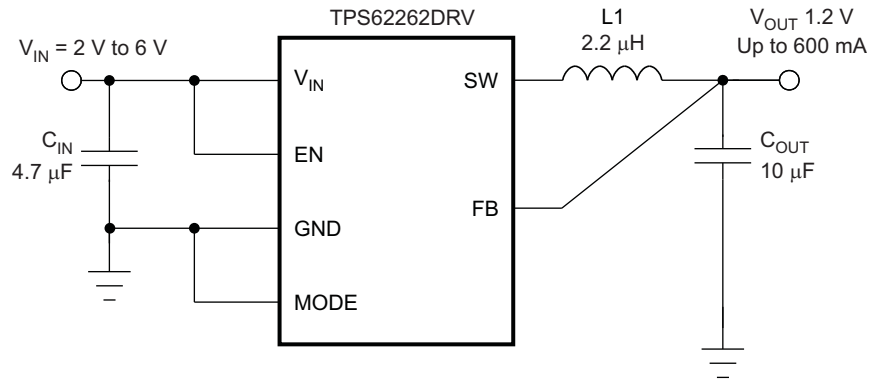

Figure 35. Fixed 1.2-V Output

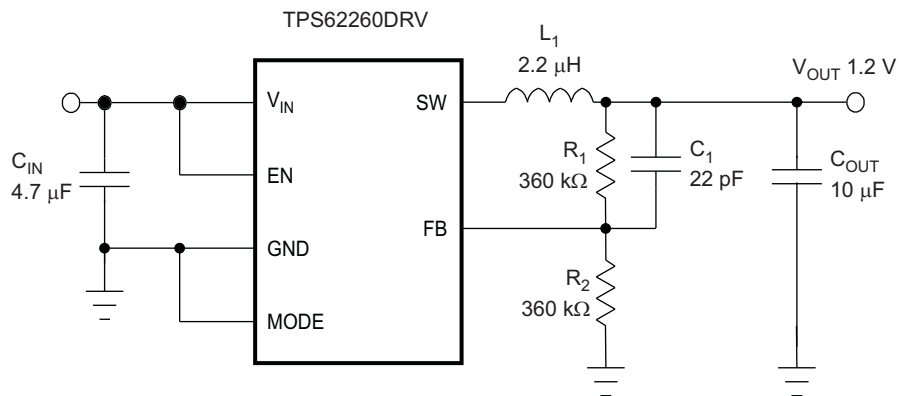

Figure 36. Adjustable 1.2-V Output

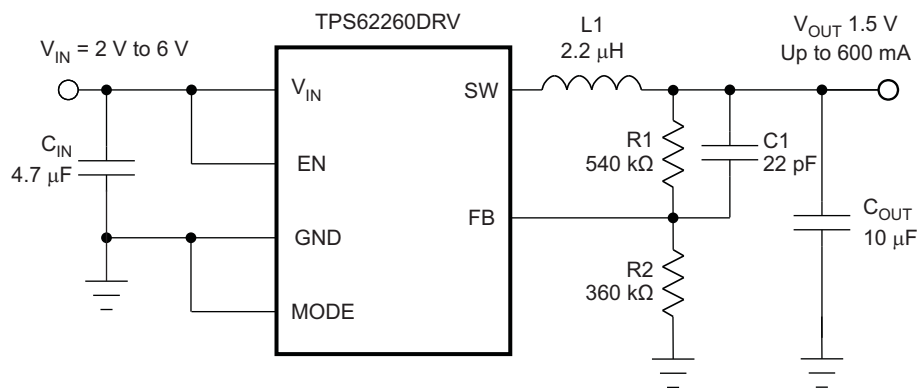

Figure 37. Adjustable 1.5-V Output

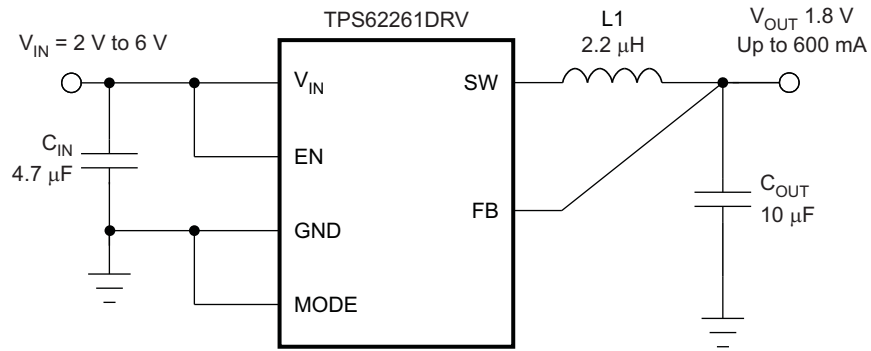

Figure 38. Fixed 1.8-V Output

OUTPUT VOLTAGE SETTING

The output voltage can be calculated to:

$$V_{\text{OUT}} = V_{\text{REF}} \times \left(1 + \frac{R_1}{R_2} \right) \text{ with an internal reference voltage } V_{\text{REF}} \text{ typical } 0.6\text{V}.$$

To minimize the current through the feedback divider network, R_2 should be 180 k Ω or 360 k Ω . The sum of R_1 and R_2 should not exceed ~1M Ω , to keep the network robust against noise. An external feed forward capacitor C_1 is required for optimum load transient response. The value of C_1 should be in the range between 22pF and 33pF.

Route the FB line away from noise sources, such as the inductor or the SW line.

OUTPUT FILTER DESIGN (INDUCTOR AND OUTPUT CAPACITOR)

The TPS6226x is designed to operate with inductors in the range of 1.5 μH to 4.7 μH and with output capacitors in the range of 4.7 μF to 22 μF . The part is optimized for operation with a 2.2 μH inductor and 10 μF output capacitor.

Larger or smaller inductor values can be used to optimize the performance of the device for specific operation conditions. For stable operation, the L and C values of the output filter may not fall below 1 μH effective inductance and 3.5 μF effective capacitance.

Inductor Selection

The inductor value has a direct effect on the ripple current. The selected inductor has to be rated for its dc resistance and saturation current. The inductor ripple current (ΔI_L) decreases with higher inductance and increases with higher V_I or V_O .

The inductor selection has also impact on the output voltage ripple in PFM mode. Higher inductor values will lead to lower output voltage ripple and higher PFM frequency, lower inductor values will lead to a higher output voltage ripple but lower PFM frequency.

[Equation 1](#) calculates the maximum inductor current in PWM mode under static load conditions. The saturation current of the inductor should be rated higher than the maximum inductor current as calculated with [Equation 2](#). This is recommended because during heavy load transient the inductor current will rise above the calculated value.

$$\Delta I_L = V_{\text{OUT}} \times \frac{1 - \frac{V_{\text{OUT}}}{V_{\text{IN}}}}{L \times f} \tag{1}$$

$$I_{L \text{ max}} = I_{\text{out max}} + \frac{\Delta I_L}{2} \tag{2}$$

With:

f = Switching Frequency (2.25MHz typical)

L = Inductor Value

ΔI_L = Peak to Peak inductor ripple current

$I_{L \text{ max}}$ = Maximum Inductor current

A more conservative approach is to select the inductor current rating just for the switch current limit $I_{L \text{ LIMF}}$ of the converter.

Accepting larger values of ripple current allows the use of lower inductance values, but results in higher output voltage ripple, greater core losses, and lower output current capability.

The total losses of the coil have a strong impact on the efficiency of the DC/DC conversion and consist of both the losses in the dc resistance (R_{DC}) and the following frequency-dependent components:

- The losses in the core material (magnetic hysteresis loss, especially at high switching frequencies)
- Additional losses in the conductor from the skin effect (current displacement at high frequencies)
- Magnetic field losses of the neighboring windings (proximity effect)
- Radiation losses

Table 2. List of Inductors

DIMENSIONS [mm ³]	Inductance μ H	INDUCTOR TYPE	SUPPLIER
2.5x2.0x1.0max	2.0	MIPS2520D2R2	FDK
2.5x2.0x1.2max	2.0	MIPSA2520D2R2	FDK
2.5x2.0x1.0max	2.2	KSLI-252010AG2R2	Htachi Metals
2.5x2.0x1.2max	2.2	LQM2HPN2R2MJ0L	Murata
3x3x1.5max	2.2	LPS3015 2R2	Coilcraft

Output Capacitor Selection

The advanced fast-response voltage mode control scheme of the TPS6226x allows the use of tiny ceramic capacitors. Ceramic capacitors with low ESR values have the lowest output voltage ripple and are recommended. The output capacitor requires either an X7R or X5R dielectric. Y5V and Z5U dielectric capacitors, aside from their wide variation in capacitance over temperature, become resistive at high frequencies.

At nominal load current, the device operates in PWM mode and the RMS ripple current is calculated as:

$$I_{\text{RMSC}_{\text{OUT}}} = V_{\text{OUT}} \times \frac{1 - \frac{V_{\text{OUT}}}{V_{\text{IN}}}}{L \times f} \times \frac{1}{2 \times \sqrt{3}} \quad (3)$$

At nominal load current, the device operates in PWM mode and the overall output voltage ripple is the sum of the voltage spike caused by the output capacitor ESR plus the voltage ripple caused by charging and discharging the output capacitor:

$$\Delta V_{\text{OUT}} = V_{\text{OUT}} \times \frac{1 - \frac{V_{\text{OUT}}}{V_{\text{IN}}}}{L \times f} \times \left(\frac{1}{8 \times C_{\text{out}} \times f} + \text{ESR} \right) \quad (4)$$

At light load currents, the converter operates in Power Save Mode and the output voltage ripple is dependent on the output capacitor and inductor value. Larger output capacitor and inductor values minimize the voltage ripple in PFM mode and tighten DC output accuracy in PFM mode.

Input Capacitor Selection

An input capacitor is required for best input voltage filtering, and minimizing the interference with other circuits caused by high input voltage spikes. For most applications, a 4.7 μ F to 10 μ F ceramic capacitor is recommended. Because ceramic capacitor loses up to 80% of its initial capacitance at 5 V, it is recommended that 10 μ F input capacitors be used for input voltages > 4.5V. The input capacitor can be increased without any limit for better input voltage filtering. Take care when using only small ceramic input capacitors. When a ceramic capacitor is used at the input and the power is being supplied through long wires, such as from a wall adapter, a load step at the output or VIN step on the input can induce ringing at the VIN pin. This ringing can couple to the output and be mistaken as loop instability or could even damage the part by exceeding the maximum ratings.

Table 3. List of Capacitors

CAPACITANCE	TYPE	SIZE	SUPPLIER
4.7 μ F	GRM188R60J475K	0603 1.6x0.8x0.8mm ³	Murata
10 μ F	GRM188R60J106M69D	0603 1.6x0.8x0.8mm ³	Murata

LAYOUT CONSIDERATIONS

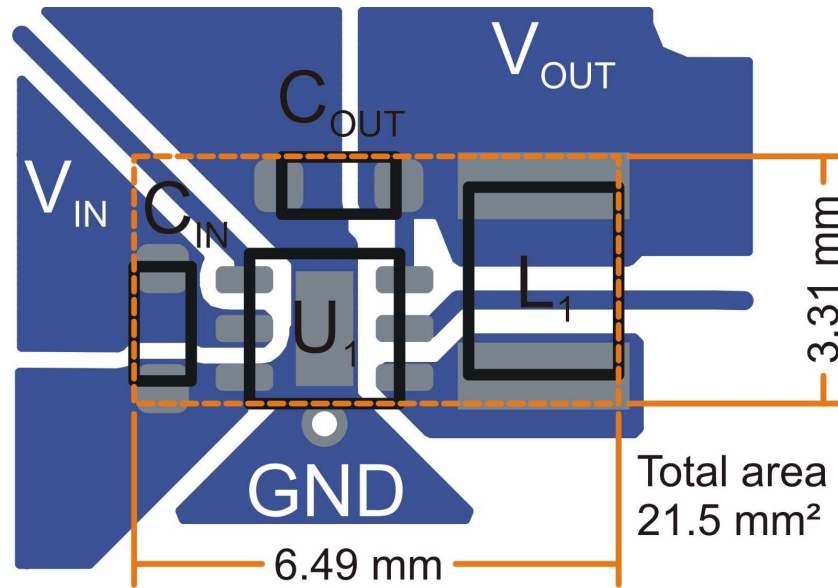

Figure 39. Suggested Layout for Fixed Output Voltage Options

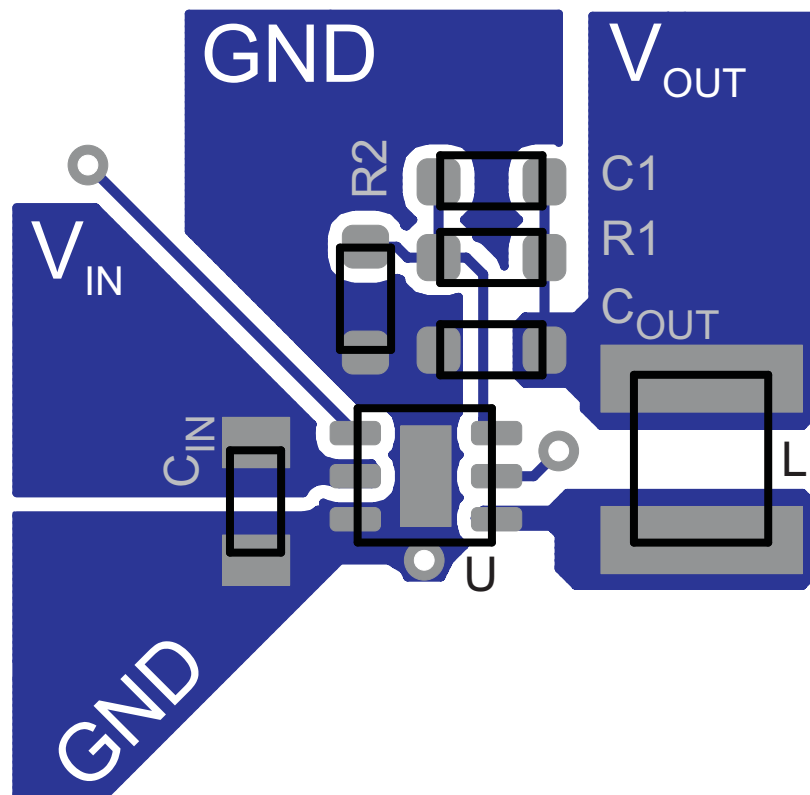

Figure 40. Suggested Layout for Adjustable Output Voltage Version

As for all switching power supplies, the layout is an important step in the design. Proper function of the device demands careful attention to PCB layout. Care must be taken in board layout to get the specified performance. If the layout is not carefully done, the regulator could show poor line and/or load regulation, stability issues as well as EMI problems. It is critical to provide a low inductance, impedance ground path. Therefore, use wide and short traces for the main current paths. The input capacitor should be placed as close as possible to the IC pins as well as the inductor and output capacitor.

Connect the GND Pin of the device to the PowerPAD™ land of the PCB and use this pad as a star point. Use a common Power GND node and a different node for the Signal GND to minimize the effects of ground noise. Connect these ground nodes together to the PowerPAD land (star point) underneath the IC. Keep the common path to the GND PIN, which returns the small signal components and the high current of the output capacitors as short as possible to avoid ground noise. The FB line should be connected right to the output capacitor and routed away from noisy components and traces (e.g., SW line).

REVISION HISTORY

Changes from Revision B (February, 2011) to Revision C	Page
• Added extra row in ordering information table.	2

PACKAGING INFORMATION

Orderable part number	Status (1)	Material type (2)	Package Pins	Package qty Carrier	RoHS (3)	Lead finish/ Ball material (4)	MSL rating/ Peak reflow (5)	Op temp (°C)	Part marking (6)
TPS62260IDRVRQ1	Active	Production	WSON (DRV) 6	3000 LARGE T&R	Yes	NIPDAU NIPDAU	Level-2-260C-1 YEAR	-40 to 85	OEO
TPS62260IDRVRQ1.Z	Active	Production	WSON (DRV) 6	3000 LARGE T&R	Yes	NIPDAU	Level-2-260C-1 YEAR	-40 to 105	OEO
TPS62260TDDCRQ1	Active	Production	SOT-23-THIN (DDC) 5	3000 LARGE T&R	Yes	NIPDAU	Level-2-260C-1 YEAR	-40 to 105	SJZ
TPS62260TDDCRQ1.Z	Active	Production	SOT-23-THIN (DDC) 5	3000 LARGE T&R	Yes	NIPDAU	Level-2-260C-1 YEAR	-40 to 105	SJZ
TPS62260TDRVRQ1	Active	Production	WSON (DRV) 6	3000 LARGE T&R	Yes	NIPDAU NIPDAU	Level-2-260C-1 YEAR	-40 to 105	OEO
TPS62260TDRVRQ1.Z	Active	Production	WSON (DRV) 6	3000 LARGE T&R	Yes	NIPDAU	Level-2-260C-1 YEAR	-40 to 105	OEO
TPS62261TDRVRQ1	Active	Production	WSON (DRV) 6	3000 LARGE T&R	Yes	NIPDAU NIPDAU	Level-2-260C-1 YEAR	-40 to 105	OFE
TPS62261TDRVRQ1.Z	Active	Production	WSON (DRV) 6	3000 LARGE T&R	Yes	NIPDAU	Level-2-260C-1 YEAR	-40 to 105	OFE
TPS62262TDRVRQ1	Active	Production	WSON (DRV) 6	3000 LARGE T&R	Yes	NIPDAU NIPDAU	Level-2-260C-1 YEAR	-40 to 105	OFF
TPS62262TDRVRQ1.Z	Active	Production	WSON (DRV) 6	3000 LARGE T&R	Yes	NIPDAU	Level-2-260C-1 YEAR	-40 to 105	OFF
TPS62263TDRVRQ1	Active	Production	WSON (DRV) 6	3000 LARGE T&R	Yes	NIPDAU NIPDAU	Level-2-260C-1 YEAR	-40 to 105	OFG
TPS62263TDRVRQ1.Z	Active	Production	WSON (DRV) 6	3000 LARGE T&R	Yes	NIPDAU	Level-2-260C-1 YEAR	-40 to 105	OFG

(1) **Status:** For more details on status, see our [product life cycle](#).

(2) **Material type:** When designated, preproduction parts are prototypes/experimental devices, and are not yet approved or released for full production. Testing and final process, including without limitation quality assurance, reliability performance testing, and/or process qualification, may not yet be complete, and this item is subject to further changes or possible discontinuation. If available for ordering, purchases will be subject to an additional waiver at checkout, and are intended for early internal evaluation purposes only. These items are sold without warranties of any kind.

(3) **RoHS values:** Yes, No, RoHS Exempt. See the [TI RoHS Statement](#) for additional information and value definition.

(4) **Lead finish/Ball material:** Parts may have multiple material finish options. Finish options are separated by a vertical ruled line. Lead finish/Ball material values may wrap to two lines if the finish value exceeds the maximum column width.

(5) **MSL rating/Peak reflow:** The moisture sensitivity level ratings and peak solder (reflow) temperatures. In the event that a part has multiple moisture sensitivity ratings, only the lowest level per JEDEC standards is shown. Refer to the shipping label for the actual reflow temperature that will be used to mount the part to the printed circuit board.

(6) **Part marking:** There may be an additional marking, which relates to the logo, the lot trace code information, or the environmental category of the part.

Multiple part markings will be inside parentheses. Only one part marking contained in parentheses and separated by a "~" will appear on a part. If a line is indented then it is a continuation of the previous line and the two combined represent the entire part marking for that device.

Important Information and Disclaimer: The information provided on this page represents TI's knowledge and belief as of the date that it is provided. TI bases its knowledge and belief on information provided by third parties, and makes no representation or warranty as to the accuracy of such information. Efforts are underway to better integrate information from third parties. TI has taken and continues to take reasonable steps to provide representative and accurate information but may not have conducted destructive testing or chemical analysis on incoming materials and chemicals. TI and TI suppliers consider certain information to be proprietary, and thus CAS numbers and other limited information may not be available for release.

In no event shall TI's liability arising out of such information exceed the total purchase price of the TI part(s) at issue in this document sold by TI to Customer on an annual basis.

OTHER QUALIFIED VERSIONS OF TPS62260-Q1, TPS62261-Q1, TPS62262-Q1, TPS62263-Q1 :

- Catalog : [TPS62260](#), [TPS62261](#), [TPS62262](#), [TPS62263](#)

NOTE: Qualified Version Definitions:

- Catalog - TI's standard catalog product

TAPE AND REEL INFORMATION

QUADRANT ASSIGNMENTS FOR PIN 1 ORIENTATION IN TAPE

*All dimensions are nominal

Device	Package Type	Package Drawing	Pins	SPQ	Reel Diameter (mm)	Reel Width W1 (mm)	A0 (mm)	B0 (mm)	K0 (mm)	P1 (mm)	W (mm)	Pin1 Quadrant
TPS62260IDRVRQ1	WSO	DRV	6	3000	180.0	8.4	2.3	2.3	1.15	4.0	8.0	Q2
TPS62260TDDCRQ1	SOT-23-THIN	DDC	5	3000	179.0	8.4	3.2	3.2	1.4	4.0	8.0	Q3
TPS62260TDRVRQ1	WSO	DRV	6	3000	180.0	8.4	2.3	2.3	1.15	4.0	8.0	Q2
TPS62261TDRVRQ1	WSO	DRV	6	3000	180.0	8.4	2.3	2.3	1.15	4.0	8.0	Q2
TPS62262TDRVRQ1	WSO	DRV	6	3000	180.0	8.4	2.3	2.3	1.15	4.0	8.0	Q2
TPS62263TDRVRQ1	WSO	DRV	6	3000	180.0	8.4	2.3	2.3	1.15	4.0	8.0	Q2

TAPE AND REEL BOX DIMENSIONS

*All dimensions are nominal

Device	Package Type	Package Drawing	Pins	SPQ	Length (mm)	Width (mm)	Height (mm)
TPS62260IDRVRQ1	WSON	DRV	6	3000	210.0	185.0	35.0
TPS62260TDDCRQ1	SOT-23-THIN	DDC	5	3000	213.0	191.0	35.0
TPS62260TDRVRQ1	WSON	DRV	6	3000	210.0	185.0	35.0
TPS62261TDRVRQ1	WSON	DRV	6	3000	210.0	185.0	35.0
TPS62262TDRVRQ1	WSON	DRV	6	3000	210.0	185.0	35.0
TPS62263TDRVRQ1	WSON	DRV	6	3000	210.0	185.0	35.0

DDC0005A



PACKAGE OUTLINE

SOT-23 - 1.1 max height

SMALL OUTLINE TRANSISTOR

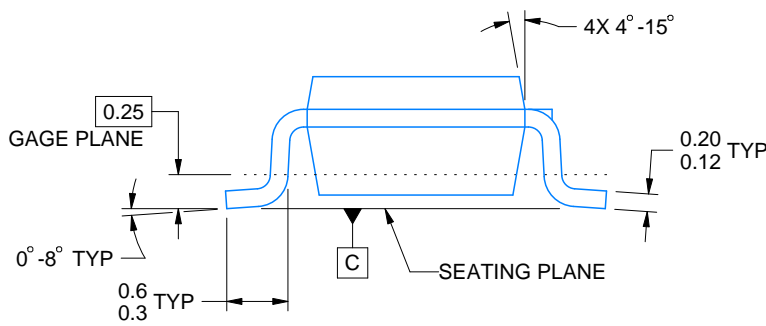
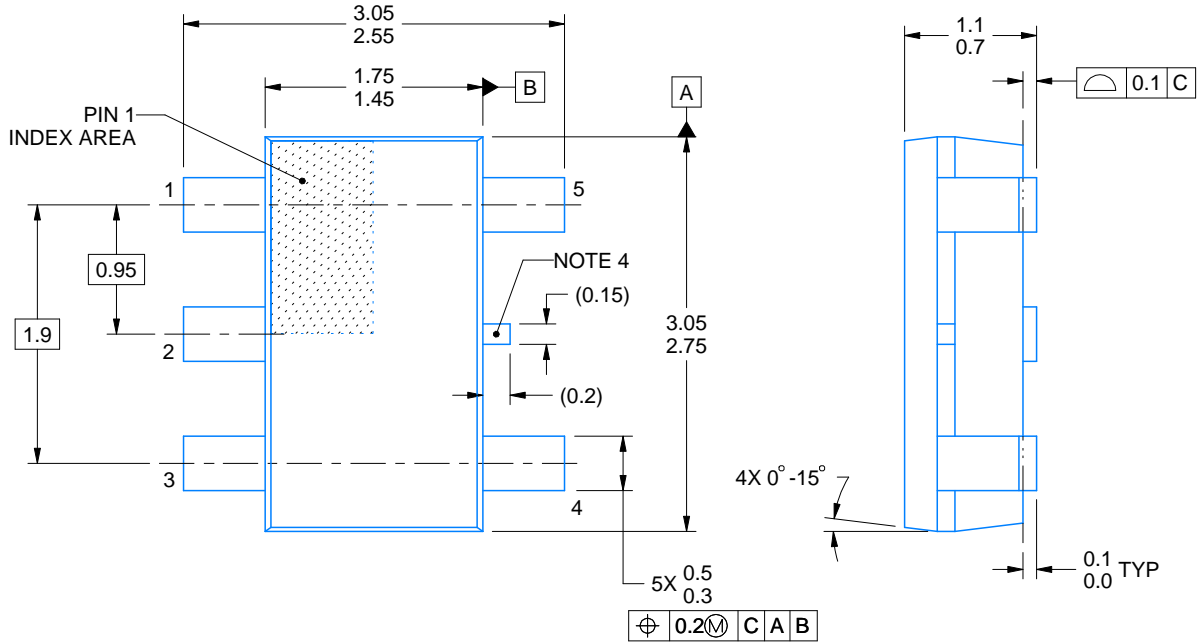

4220752/C 08/2024

NOTES:

1. All linear dimensions are in millimeters. Any dimensions in parenthesis are for reference only. Dimensioning and tolerancing per ASME Y14.5M.
2. This drawing is subject to change without notice.
3. Reference JEDEC MO-193.
4. Support pin may differ or may not be present.

EXAMPLE BOARD LAYOUT

DDC0005A

SOT-23 - 1.1 max height

SMALL OUTLINE TRANSISTOR

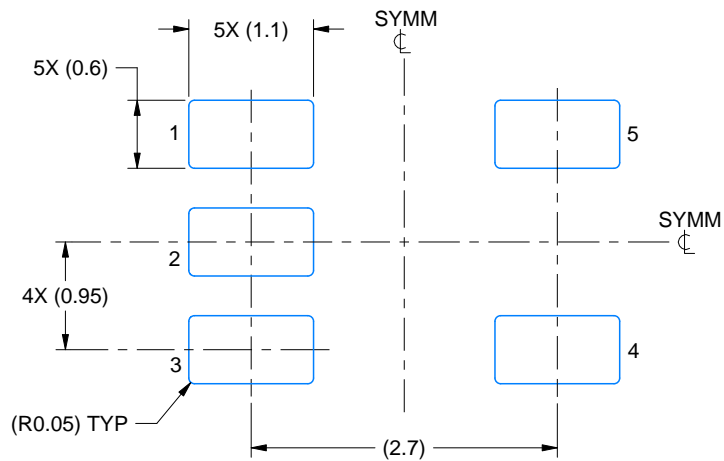

LAND PATTERN EXAMPLE
EXPLODED METAL SHOWN
SCALE:15X

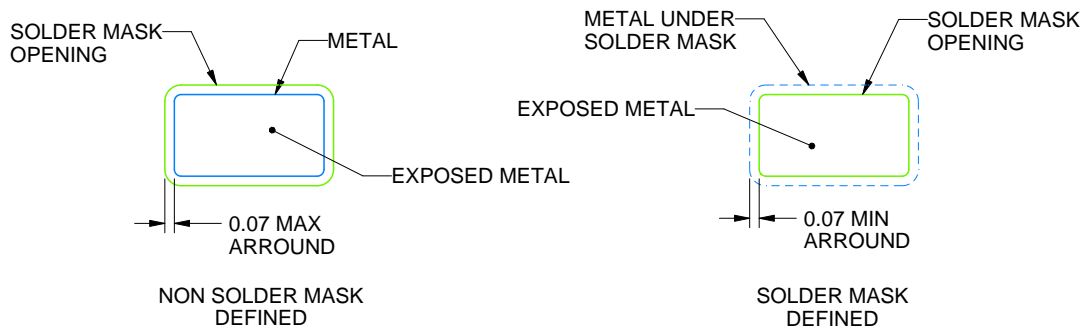

SOLDERMASK DETAILS

4220752/C 08/2024

NOTES: (continued)

- 4. Publication IPC-7351 may have alternate designs.
- 5. Solder mask tolerances between and around signal pads can vary based on board fabrication site.

EXAMPLE STENCIL DESIGN

DDC0005A

SOT-23 - 1.1 max height

SMALL OUTLINE TRANSISTOR

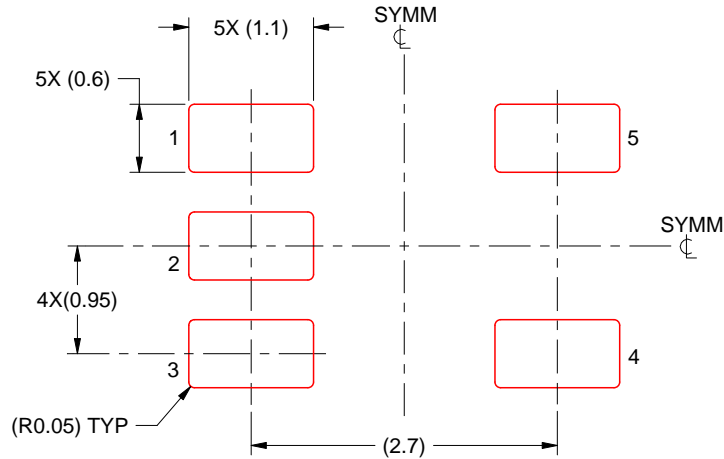

SOLDER PASTE EXAMPLE
BASED ON 0.125 THICK STENCIL
SCALE:15X

4220752/C 08/2024

NOTES: (continued)

6. Laser cutting apertures with trapezoidal walls and rounded corners may offer better paste release. IPC-7525 may have alternate design recommendations.
7. Board assembly site may have different recommendations for stencil design.

GENERIC PACKAGE VIEW

DRV 6

WSON - 0.8 mm max height

PLASTIC SMALL OUTLINE - NO LEAD



Images above are just a representation of the package family, actual package may vary.
Refer to the product data sheet for package details.

4206925/F

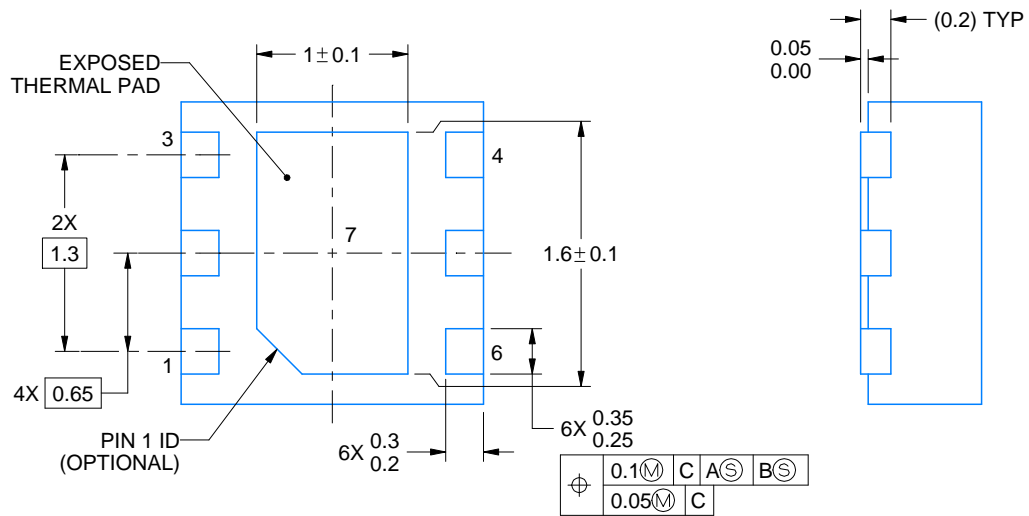
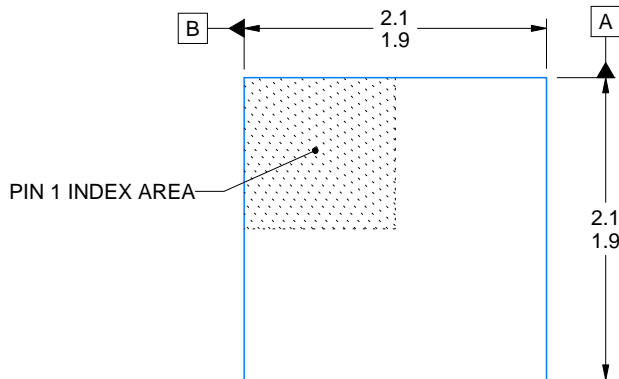
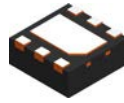

4222173/B 04/2018

NOTES:

1. All linear dimensions are in millimeters. Any dimensions in parenthesis are for reference only. Dimensioning and tolerancing per ASME Y14.5M.
2. This drawing is subject to change without notice.
3. The package thermal pad must be soldered to the printed circuit board for thermal and mechanical performance.

EXAMPLE BOARD LAYOUT

DRV0006A

WSON - 0.8 mm max height

PLASTIC SMALL OUTLINE - NO LEAD



LAND PATTERN EXAMPLE
SCALE:25X

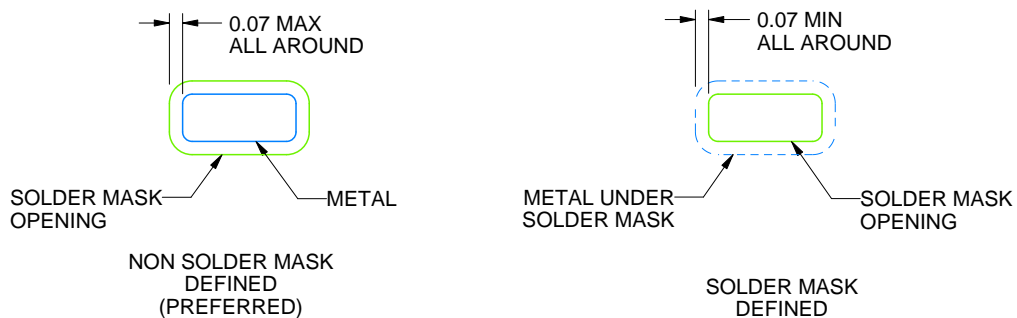

SOLDER MASK DETAILS

4222173/B 04/2018

NOTES: (continued)

4. This package is designed to be soldered to a thermal pad on the board. For more information, see Texas Instruments literature number SLUA271 (www.ti.com/lit/sluea271).
5. Vias are optional depending on application, refer to device data sheet. If some or all are implemented, recommended via locations are shown.

EXAMPLE STENCIL DESIGN

DRV0006A

WSON - 0.8 mm max height

PLASTIC SMALL OUTLINE - NO LEAD



SOLDER PASTE EXAMPLE
BASED ON 0.125 mm THICK STENCIL

EXPOSED PAD #7
88% PRINTED SOLDER COVERAGE BY AREA UNDER PACKAGE
SCALE:30X

4222173/B 04/2018

NOTES: (continued)

6. Laser cutting apertures with trapezoidal walls and rounded corners may offer better paste release. IPC-7525 may have alternate design recommendations.

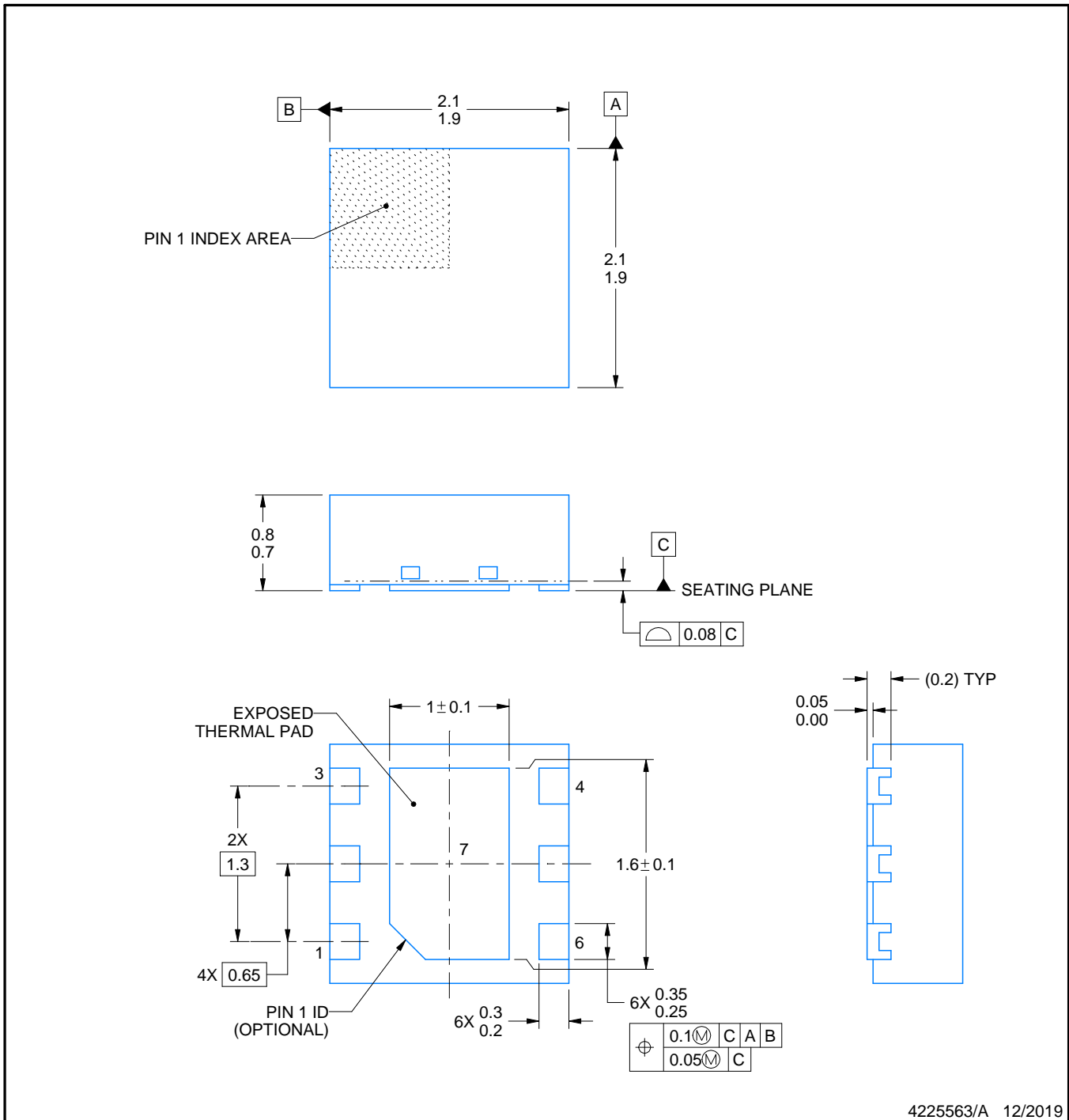
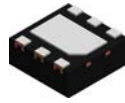

4225563/A 12/2019

NOTES:

1. All linear dimensions are in millimeters. Any dimensions in parenthesis are for reference only. Dimensioning and tolerancing per ASME Y14.5M.
2. This drawing is subject to change without notice.
3. The package thermal pad must be soldered to the printed circuit board for thermal and mechanical performance.

EXAMPLE BOARD LAYOUT

DRV0006D

WSON - 0.8 mm max height

PLASTIC SMALL OUTLINE - NO LEAD



LAND PATTERN EXAMPLE
EXPOSED METAL SHOWN
SCALE:25X

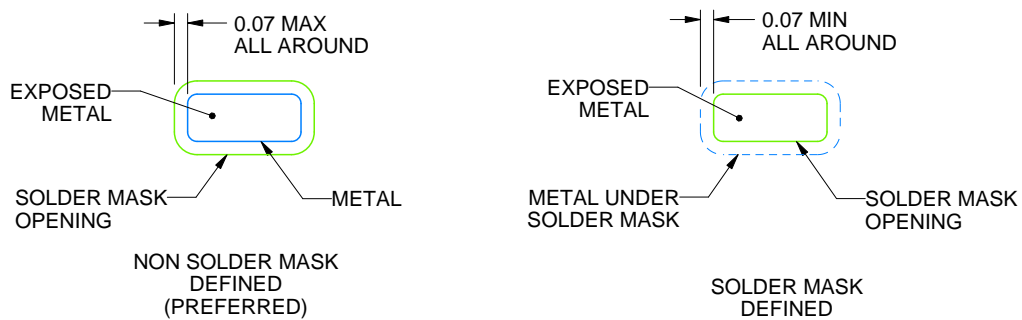

SOLDER MASK DETAILS

4225563/A 12/2019

NOTES: (continued)

4. This package is designed to be soldered to a thermal pad on the board. For more information, see Texas Instruments literature number SLUA271 (www.ti.com/lit/sluea271).
5. Vias are optional depending on application, refer to device data sheet. If some or all are implemented, recommended via locations are shown.

EXAMPLE STENCIL DESIGN

DRV0006D

WSON - 0.8 mm max height

PLASTIC SMALL OUTLINE - NO LEAD



SOLDER PASTE EXAMPLE
BASED ON 0.125 mm THICK STENCIL

EXPOSED PAD #7
88% PRINTED SOLDER COVERAGE BY AREA UNDER PACKAGE
SCALE:30X

4225563/A 12/2019

NOTES: (continued)

6. Laser cutting apertures with trapezoidal walls and rounded corners may offer better paste release. IPC-7525 may have alternate design recommendations.

IMPORTANT NOTICE AND DISCLAIMER

TI PROVIDES TECHNICAL AND RELIABILITY DATA (INCLUDING DATA SHEETS), DESIGN RESOURCES (INCLUDING REFERENCE DESIGNS), APPLICATION OR OTHER DESIGN ADVICE, WEB TOOLS, SAFETY INFORMATION, AND OTHER RESOURCES "AS IS" AND WITH ALL FAULTS, AND DISCLAIMS ALL WARRANTIES, EXPRESS AND IMPLIED, INCLUDING WITHOUT LIMITATION ANY IMPLIED WARRANTIES OF MERCHANTABILITY, FITNESS FOR A PARTICULAR PURPOSE OR NON-INFRINGEMENT OF THIRD PARTY INTELLECTUAL PROPERTY RIGHTS.

These resources are intended for skilled developers designing with TI products. You are solely responsible for (1) selecting the appropriate TI products for your application, (2) designing, validating and testing your application, and (3) ensuring your application meets applicable standards, and any other safety, security, regulatory or other requirements.

These resources are subject to change without notice. TI grants you permission to use these resources only for development of an application that uses the TI products described in the resource. Other reproduction and display of these resources is prohibited. No license is granted to any other TI intellectual property right or to any third party intellectual property right. TI disclaims responsibility for, and you will fully indemnify TI and its representatives against, any claims, damages, costs, losses, and liabilities arising out of your use of these resources.

TI's products are provided subject to [TI's Terms of Sale](#) or other applicable terms available either on [ti.com](https://www.ti.com) or provided in conjunction with such TI products. TI's provision of these resources does not expand or otherwise alter TI's applicable warranties or warranty disclaimers for TI products.

TI objects to and rejects any additional or different terms you may have proposed.

Mailing Address: Texas Instruments, Post Office Box 655303, Dallas, Texas 75265

Copyright © 2025, Texas Instruments Incorporated