

## TRF3765 Integer-N/Fractional-N PLL With Integrated VCO

### 1 Features

- Output Frequencies: 300 MHz to 4.8 GHz
- Low-Noise VCO:  $-133$  dBc/Hz (1-MHz Offset,  $f_{OUT} = 2.65$  GHz)
- 13-/16-Bit Reference/Feedback Divider
- 25-Bit Fractional-N and Integer-N PLL
- Low RMS Jitter: 0.35 ps
- Input Reference Frequency Range: 0.5 MHz to 350 MHz
- Programmable Output Divide-by-1/-2/-4/-8
- Four Differential LO Outputs
- External VCO Input with Programmable VCO On/Off Control

### 2 Applications

- Wireless Infrastructure
- Wireless Local Loop
- Point-to-Point Wireless Access
- Wireless MAN Wideband Transceivers

### 3 Description

The TRF3765 is a wideband Integer-N/Fractional-N frequency synthesizer with an integrated, wideband voltage-controlled oscillator (VCO). Programmable output dividers enable continuous frequency coverage from 300 MHz to 4.8 GHz. Four separate differential, open-collector RF outputs allow multiple devices to be driven in parallel without the need of external splitters.

The TRF3765 also accepts external VCO input signals and allows on/off control through a programmable control output. For maximum flexibility and wide reference frequency range, wide-range divide ratio settings are programmable and an off-chip loop filter can be used.

The TRF3765 is available in an RHB-32 VQFN package.

#### Device Information<sup>(1)</sup>

PART NUMBER	PACKAGE	BODY SIZE (NOM)
TRF3765	VQFN (32)	5.00 mm x 5.00 mm

(1) For all available packages, see the orderable addendum at the end of the datasheet.

#### Block Diagram

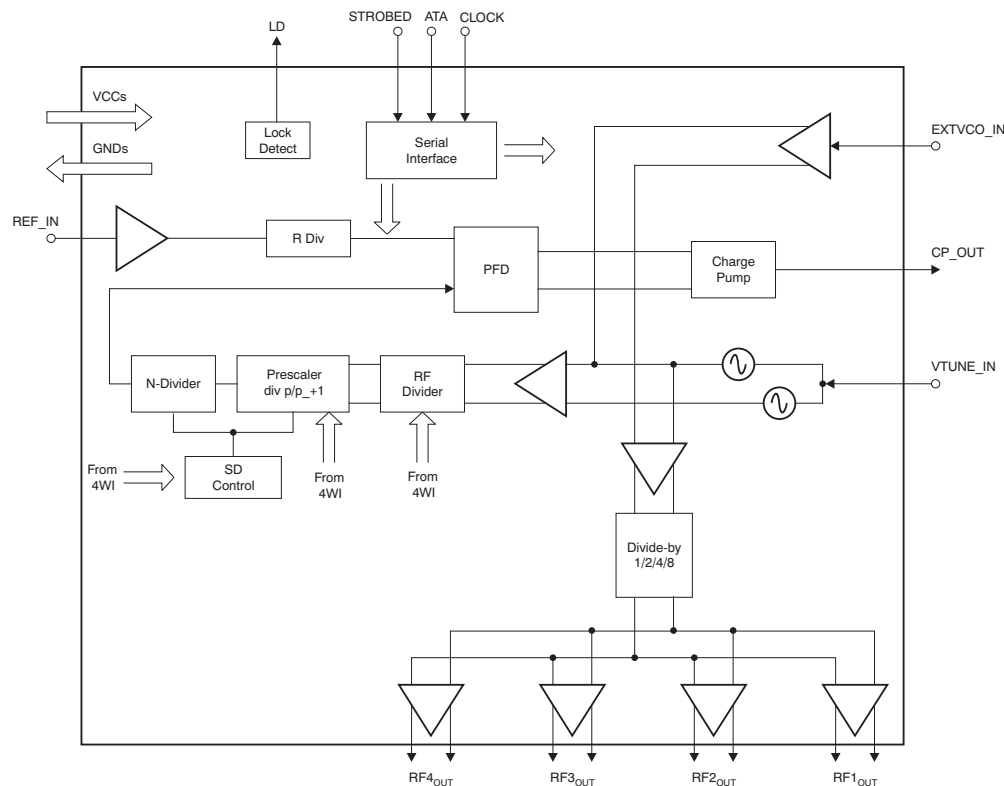

## Table of Contents

<b>1 Features</b> ..... 1 <b>2 Applications</b> ..... 1 <b>3 Description</b> ..... 1 <b>4 Revision History</b> ..... 2 <b>5 Pin Configuration and Functions</b> ..... 3 <b>6 Specifications</b> ..... 5 6.1 Absolute Maximum Ratings ..... 5 6.2 ESD Ratings ..... 5 6.3 Recommended Operating Conditions ..... 5 6.4 Thermal Information ..... 5 6.5 Electrical Characteristics ..... 6 6.6 4WI Timing: Write Operation ..... 7 6.7 Readback 4WI Timing ..... 7 6.8 Typical Characteristics ..... 9 <b>7 Detailed Description</b> ..... 21 7.1 Overview ..... 21 7.2 Functional Block Diagram ..... 21	7.3 Feature Description ..... 22 7.4 Device Functional Modes ..... 24 7.5 Register Maps ..... 29 <b>8 Application and Implementation</b> ..... 39 8.1 Application Information ..... 39 8.2 Typical Application ..... 39 <b>9 Power Supply Recommendations</b> ..... 42 <b>10 Layout</b> ..... 43 10.1 Layout Guidelines ..... 43 10.2 Layout Example ..... 43 <b>11 Device and Documentation Support</b> ..... 44 11.1 Community Resources ..... 44 11.2 Trademarks ..... 44 11.3 Electrostatic Discharge Caution ..... 44 11.4 Glossary ..... 44 <b>12 Mechanical, Packaging, and Orderable Information</b> ..... 44
---	--

## 4 Revision History

NOTE: Page numbers for previous revisions may differ from page numbers in the current version.

Changes from Revision D (January 2013) to Revision E	Page
<ul style="list-style-type: none"> <li>• Added <i>ESD Ratings</i> table, <i>Feature Description</i> section, <i>Device Functional Modes</i>, <i>Application and Implementation</i> section, <i>Power Supply Recommendations</i> section, <i>Layout</i> section, <i>Device and Documentation Support</i> section, and <i>Mechanical, Packaging, and Orderable Information</i> section ..... 1</li> <li>• Changed Bit27 through Bit30 of <a href="#">Table 7</a> From: B[25..21] To: B[30..27] ..... 29</li> </ul>	
Changes from Revision C (December 2011) to Revision D	Page
<ul style="list-style-type: none"> <li>• Changed the Description of Bit25 and Bit26 in Register 6 ..... 36</li> <li>• Changed the Description of Bit27 and Bit28 in Register 6 ..... 36</li> <li>• Changed the Bit Name of Bit31 From: DIV_MUX_BIAS_OVRT To: DIV_MUX_BIAS_OVRD in Register 6 ..... 36</li> <li>• Changed VCC_OSC From: +3.3V/5.0V To: +3.3V, and VCC_TK From: +3.3V To: +3.3V/5.0V in ..... 39</li> </ul>	
Changes from Revision B (November 2011) to Revision C	Page
<ul style="list-style-type: none"> <li>• Changed Reference Oscillator Parameters, <i>Reference input impedance</i> parameter rows in Electrical Characteristics table ..... 6</li> </ul>	

## 5 Pin Configuration and Functions

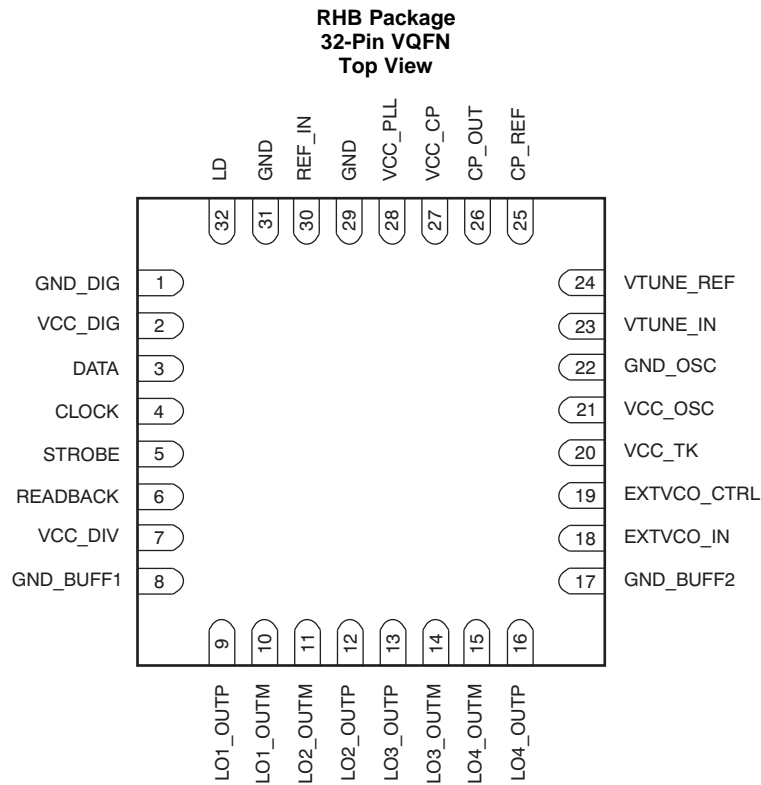

### Pin Functions

PIN		I/O	DESCRIPTION
NO.	NAME		
4	CLOCK	I	Serial programming interface, clock input
26	CP_OUT	O	Charge pump output
25	CP_REF	—	Charge pump reference ground
3	DATA	I	Serial programming interface, data input
19	EXTVCO_CTRL	O	Digital control to enable/disable external VCO
18	EXTVCO_IN	I	External VCO input
29	GND	—	Ground
31	GND	—	Ground
8	GND_BUFF1	—	Output buffer ground
17	GND_BUFF2	—	Output buffer ground
1	GND_DIG	—	Digital ground
22	GND_OSC	—	VCO core ground
32	LD	O	Lock detector output
10	LO1_OUTM	O	LO1 output: negative pin
9	LO1_OUTP	O	LO1 output: positive pin
11	LO2_OUTM	O	LO2 output: negative pin
12	LO2_OUTP	O	LO2 output: positive pin
14	LO3_OUTM	O	LO3 output: negative pin
13	LO3_OUTP	O	LO3 output: positive pin
15	LO4_OUTM	O	LO4 output: negative pin
16	LO4_OUTP	O	LO4 output: positive pin

**Pin Functions (continued)**

PIN		I/O	DESCRIPTION
NO.	NAME		
6	READBACK	O	Serial programming interface, readback
30	REF_IN	I	Reference signal input
5	STROBE	I	Serial programming interface, latch enable
27	VCC_CP	—	Charge pump power supply
2	VCC_DIG	—	Digital power supply
7	VCC_DIV	—	Divider power supply
21	VCC_OSC	—	VCO core power supply
28	VCC_PLL	—	PLL power supply
20	VCC_TK	—	VCO LC tank power supply
23	VTUNE_IN	—	VCO control voltage
24	VTUNE_REF	—	V <sub>TUNE</sub> reference ground

## 6 Specifications

### 6.1 Absolute Maximum Ratings

Over operating free-air temperature range (unless otherwise noted).<sup>(1)</sup>

		MIN	MAX	UNIT
Supply voltage <sup>(2)</sup>	All VCC pins except VCC_TK	-0.3	3.6	V
	VCC_TK	-0.3	5.5	
Digital I/O voltage		-0.3	V <sub>I</sub> + 0.5	V
Operating virtual junction temperature, T <sub>J</sub>		-40	150	°C
Operating ambient temperature, T <sub>A</sub>		-40	85	°C
Storage temperature, T <sub>stg</sub>		-40	150	°C

- (1) Stresses beyond those listed under *Absolute Maximum Ratings* may cause permanent damage to the device. These are stress ratings only, which do not imply functional operation of the device at these or any other conditions beyond those indicated under *Recommended Operating Conditions*. Exposure to absolute-maximum-rated conditions for extended periods may affect device reliability.
- (2) All voltage values are with respect to network ground pin.

### 6.2 ESD Ratings

		VALUE	UNIT
V <sub>(ESD)</sub> Electrostatic discharge	Human body model (HBM), per ANSI/ESDA/JEDEC JS-001 <sup>(1)</sup>	±1000	V
	Charged device model (CDM), per JEDEC specification JESD22-C101 <sup>(2)</sup>	±1500	

- (1) JEDEC document JEP155 states that 500-V HBM allows safe manufacturing with a standard ESD control process.
- (2) JEDEC document JEP157 states that 250-V CDM allows safe manufacturing with a standard ESD control process.

### 6.3 Recommended Operating Conditions

Over operating free-air temperature range (unless otherwise noted).

		MIN	NOM	MAX	UNIT
V <sub>CC</sub>	Power-supply voltage	3	3.3	3.6	V
VCC_TK	3.3-V to 5.5-V power-supply voltage	3	3.3	5.5	V
T <sub>A</sub>	Operating ambient temperature	-40		85	°C
T <sub>J</sub>	Operating virtual junction temperature	-40		150	°C

### 6.4 Thermal Information

THERMAL METRIC <sup>(1)</sup>		TRF3765	UNIT
		RHB (VQFN)	
		32 PINS	
R <sub>θJA</sub>	Junction-to-ambient thermal resistance	31.6	°C/W
R <sub>θJctop</sub>	Junction-to-case (top) thermal resistance	21.6	°C/W
R <sub>θJB</sub>	Junction-to-board thermal resistance	5.6	°C/W
ψ <sub>JT</sub>	Junction-to-top characterization parameter	0.3	°C/W
ψ <sub>JB</sub>	Junction-to-board characterization parameter	5.5	°C/W
R <sub>θJcbot</sub>	Junction-to-case (bottom) thermal resistance	1.1	°C/W

- (1) For more information about traditional and new thermal metrics, see the *Semiconductor and IC Package Thermal Metrics* application report, [SPRA953](#).

## 6.5 Electrical Characteristics

 At  $T_A = 25^\circ\text{C}$  and power supply = 3.3 V, unless otherwise noted.

PARAMETERS		TEST CONDITIONS	MIN	TYP	MAX	UNIT
<b>DC PARAMETERS</b>						
$I_{CC}$	Total supply current	Internal VCO, 1 output buffer on, divide-by-1		115		mA
		Internal VCO, 4 output buffers on, divide-by-1		190		
		Internal VCO, 1 output buffer on, divide-by-8		120		
		Internal VCO, 4 output buffers on, divide-by-8		182		
		External VCO mode, 1 output buffer on, divide-by-1		89		
<b>DIGITAL INTERFACE</b>						
$V_{IH}$	High-level input voltage		2	3.3		V
$V_{IL}$	Low-level input voltage		0		0.8	
$V_{OH}$	High-level output voltage	Referenced to VCC_DIG	$0.8 \times V_{CC}$			
$V_{OL}$	Low-level output voltage	Referenced to VCC_DIG			$0.2 \times V_{CC}$	
<b>REFERENCE OSCILLATOR PARAMETERS</b>						
$f_{REF}$	Reference frequency		0.5 <sup>(1)</sup>		350 <sup>(1)</sup>	MHz
	Reference input sensitivity		0.2		3.3	V <sub>PP</sub>
	Reference input impedance	Parallel capacitance, 10 MHz		2		pF
		Parallel resistance, 10 MHz		2500		$\Omega$
<b>PLL</b>						
$f_{PFD}$	PFD frequency		0.5		65 <sup>(2)</sup>	MHz
$I_{CP\_OUT}$	Charge pump current	4WI programmable; ICP[4..0] = 00000 <sup>(3)</sup>		1.94		mA
	In-band normalized phase noise floor	Integer mode		-221		dBc/Hz
<b>INTERNAL VCO</b>						
$f_{VCO}$	VCO frequency range	Divide-by-1	2400		4800	MHz
$K_V$	VCO gain	$V_{CP} = 1\text{ V}$		-65		MHz/V
VCO free-running phase noise, $f_{VCO} = 2650\text{ MHz}$	VCC_TK = 3.3 V	At 10 kHz		-82		dBc/Hz
		At 100 kHz		-110		
		At 1 MHz		-130		
		At 10 MHz		-149		
		At 40 MHz		-155		
	VCC_TK = 5 V	At 10 kHz		-89		dBc/Hz
		At 100 kHz		-113		
		At 1 MHz		-133		
		At 10 MHz		-151		
		At 40 MHz		-156		
<b>CLOSED-LOOP PLL/VCO</b>						
	Integrated RMS jitter <sup>(4)</sup>	Fractional mode, $f_{OUT} = 2.6\text{ GHz}$ , $f_{PFD} = 30.72\text{ MHz}$ <sup>(5)</sup>		0.36		ps
		Integer mode, $f_{OUT} = 2.6\text{ GHz}$ , $f_{PFD} = 1.6\text{ MHz}$		0.52		
<b>RF OUTPUT/INPUT</b>						
$f_{OUT}$	Output frequency range	Divide-by-1	2400		4800	MHz
		Divide-by-2	1200		2400	
		Divide-by-4	600		1200	
		Divide-by-8	300		600	
$P_{LO}$	Output power <sup>(6)</sup>	Differential, divide-by-1, one output buffer on, maximum BUFOUT_BIAS		6.5		dBm
	External VCO input maximum frequency	20-dB gain loss, VCO pass-through, no PLL		9000		MHz
	External VCO input minimum frequency	20-dB gain loss, VCO pass-through, no PLL, divide-by-1		15		MHz
	External VCO input level			0		dBm

 (1) See [Application Information](#) for discussion of VCO calibration clock limitations on reference clock frequency.

 (2) See [Application Information](#) for discussion on PFD frequency selection and calibration logic frequency limitations.

 (3) See [4WI Register Descriptions](#) for all possible programmable charge pump currents.

(4) Integrated from 1 kHz to 10 MHz.

 (5) See [Application Information](#) for information on loop filter characteristics.

 (6) See [Application Information](#) for external output buffers details.

### 6.6 4WI Timing: Write Operation

See Figure 1.

		MIN	MAX	UNIT
$t_h$	Hold time, data to clock	20		ns
$t_{su1}$	Setup time, data to clock	20		ns
$t_{(CH)}$	Clock low duration	20		ns
$t_{(CL)}$	Clock high duration	20		ns
$t_{su2}$	Setup time, clock to enable	20		ns
$t_{(CLK)}$	Clock period	50		ns
$t_w$	Enable time	50		ns
$t_{su3}$	Setup time, latch to data	70		ns

### 6.7 Readback 4WI Timing

See Figure 2.

		MIN	MAX	UNIT
$t_h$	Hold time, data to clock	20		ns
$t_{su1}$	Setup time, data to clock	20		ns
$t_{(CH)}$	Clock low duration	20		ns
$t_{(CL)}$	Clock high duration	20		ns
$t_{su2}$	Setup time, clock to enable	20		ns
$t_{su3}$	Setup time, enable to Readback clock	20		ns
$t_d$	Delay time, clock to Readback data output	10		ns
$t_w^{(1)}$	Enable time	50		ns
$t_{(CLK)}$	Clock period	50		ns

(1) Equals Clock period

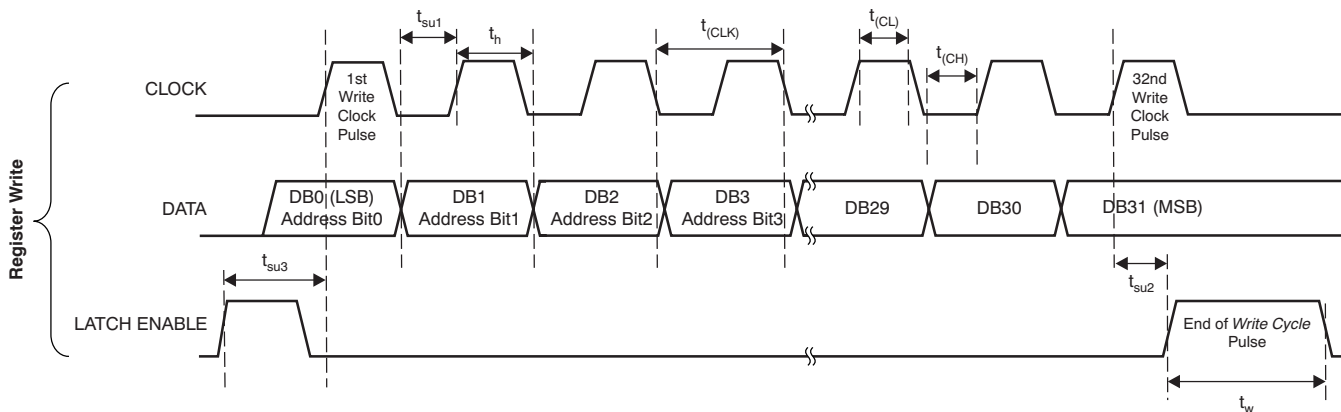

Figure 1. 4WI Timing Diagram

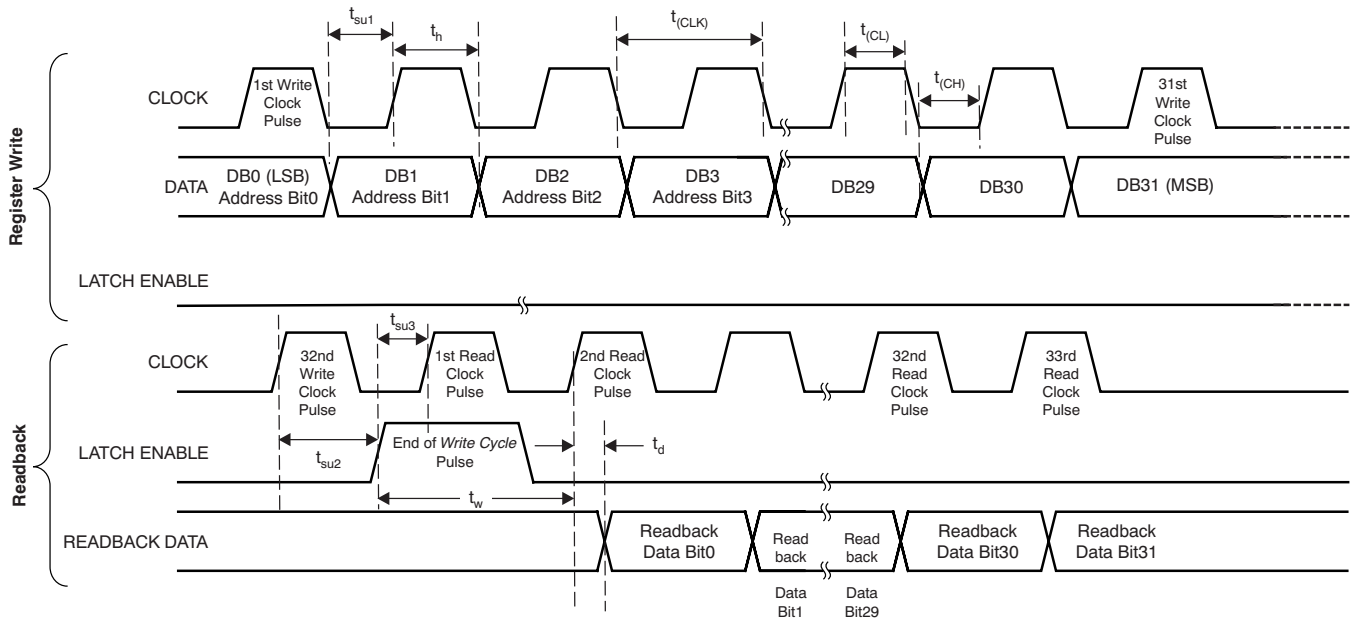

Figure 2. 4WI Readback Timing Diagram



## 6.8 Typical Characteristics

**Table 1. Table of Graphs**

GRAPH NAME		FIGURE NO.
Open-Loop Phase Noise	vs Temperature <sup>(1)</sup>	<a href="#">Figure 3</a> , <a href="#">Figure 4</a> , <a href="#">Figure 5</a> , <a href="#">Figure 6</a>
Open-Loop Phase Noise	vs Voltage <sup>(1)</sup>	<a href="#">Figure 7</a> , <a href="#">Figure 8</a> , <a href="#">Figure 9</a> , <a href="#">Figure 10</a>
Open-Loop Phase Noise	vs Temperature <sup>(1)(2)</sup>	<a href="#">Figure 11</a> , <a href="#">Figure 12</a> , <a href="#">Figure 13</a> , <a href="#">Figure 14</a>
Open-Loop Phase Noise	vs Voltage <sup>(1)(2)</sup>	<a href="#">Figure 15</a> , <a href="#">Figure 16</a> , <a href="#">Figure 17</a> , <a href="#">Figure 18</a>
Closed-Loop Phase Noise	vs Temperature <sup>(3)</sup>	<a href="#">Figure 19</a> , <a href="#">Figure 20</a> , <a href="#">Figure 21</a> , <a href="#">Figure 22</a> , <a href="#">Figure 23</a> , <a href="#">Figure 24</a> , <a href="#">Figure 25</a>
Closed-Loop Phase Noise	vs Temperature <sup>(2)(3)</sup>	<a href="#">Figure 26</a> , <a href="#">Figure 27</a> , <a href="#">Figure 28</a> , <a href="#">Figure 29</a> , <a href="#">Figure 30</a> , <a href="#">Figure 31</a> , <a href="#">Figure 32</a>
Closed-Loop Phase Noise	vs Divide Ratio <sup>(3)</sup>	<a href="#">Figure 33</a>
Closed-Loop Phase Noise	vs Divide Ratio <sup>(2)(3)</sup>	<a href="#">Figure 34</a>
Closed-Loop Phase Noise	vs Temperature <sup>(4)</sup>	<a href="#">Figure 35</a> , <a href="#">Figure 36</a> , <a href="#">Figure 37</a> , <a href="#">Figure 38</a> , <a href="#">Figure 39</a> , <a href="#">Figure 40</a> , <a href="#">Figure 41</a>
Closed-Loop Phase Noise	vs Temperature <sup>(2)(4)</sup>	<a href="#">Figure 42</a> , <a href="#">Figure 43</a> , <a href="#">Figure 44</a> , <a href="#">Figure 45</a> , <a href="#">Figure 46</a> , <a href="#">Figure 47</a> , <a href="#">Figure 48</a>
Closed-Loop Phase Noise	vs Divide Ratio <sup>(4)</sup>	<a href="#">Figure 49</a>
Closed-Loop Phase Noise	vs Divide Ratio <sup>(2)(4)</sup>	<a href="#">Figure 50</a>
PFD Spurs	vs Temperature <sup>(4)</sup>	<a href="#">Figure 51</a>
Multiples of PFD Spurs <sup>(4)</sup>		<a href="#">Figure 52</a> , <a href="#">Figure 53</a> , <a href="#">Figure 54</a>
Multiples of PFD Spurs <sup>(4)(5)</sup>		<a href="#">Figure 55</a>
Fractional Spurs	vs LO Divider <sup>(3)</sup>	<a href="#">Figure 56</a>
Fractional Spurs	vs RF Divider and Prescaler <sup>(3)</sup>	<a href="#">Figure 57</a>
Fractional Spurs	vs Temperature <sup>(3)</sup>	<a href="#">Figure 58</a>
Multiples of PFD Spurs <sup>(3)</sup>		<a href="#">Figure 59</a>
LO Harmonics <sup>(4)</sup>		<a href="#">Figure 60</a>
Output Power with Multiple Buffers <sup>(4)</sup>		<a href="#">Figure 61</a> , <a href="#">Figure 62</a>
Output Power	vs Output Port <sup>(4)</sup>	<a href="#">Figure 63</a>
Output Power	vs Buffer Bias <sup>(4)</sup>	<a href="#">Figure 64</a>
VCO Gain (Kv)	vs Frequency	<a href="#">Figure 65</a>

(1) VCO\_TRIM = 32, VTUNE\_IN = 1.1 V, CP\_TRISTATE = 3 (3-state), and CAL\_BYPASS = On.

(2) VCO\_BIAS = 600  $\mu$ A.

(3) Reference frequency = 61.44 MHz; PFD frequency = 30.72 MHz.

(4) Reference frequency = 40 MHz; PFD frequency = 1.6 MHz.

(5) Performance change at frequencies above 1500 MHz results from PLL\_DIV\_SEL changing from divide-by-1 to divide-by-2.

At  $T_A = 25^\circ\text{C}$ ,  $V_{CC} = 3.3\text{ V}$ ,  $V_{CC\_TK} = 3.3\text{ V}$ , LO1\_OUTP (single-ended), PWD\_BUFF2,3,4 = off, VCO\_BIAS = 400  $\mu\text{A}$ ; BUFOUT\_BIAS = 600  $\mu\text{A}$ , all other registers set per recommended programming in [Serial Programming Interface Register Definitions](#), and standard operating condition, unless otherwise noted.

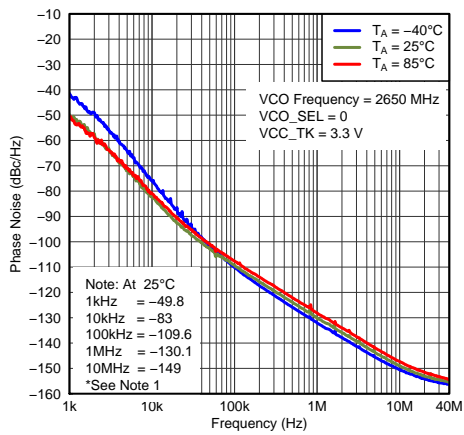

Figure 3. Open-Loop Phase Noise vs Temperature (VCO\_SEL = 0 and VCC\_TK = 3.3 V)

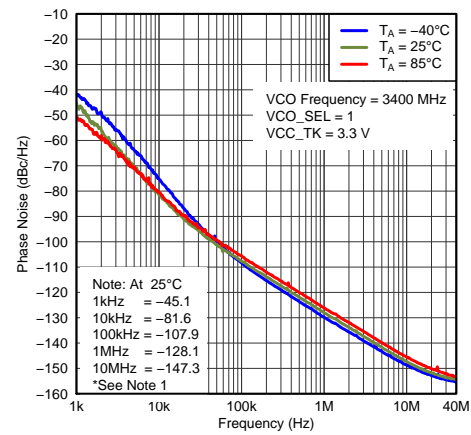

Figure 4. Open-Loop Phase Noise vs Temperature (VCO\_SEL = 1 and VCC\_TK = 3.3 V)

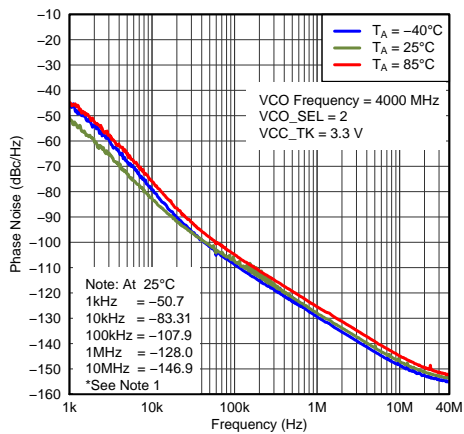

Figure 5. Open-Loop Phase Noise vs Temperature (VCO\_SEL = 2 and VCC\_TK = 3.3 V)

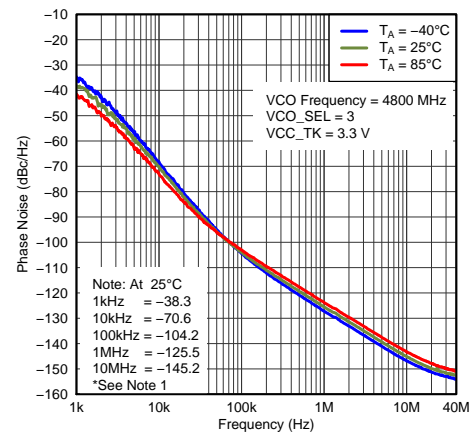

Figure 6. Open-Loop Phase Noise vs Temperature (VCO\_SEL = 3 and VCC\_TK = 3.3 V)

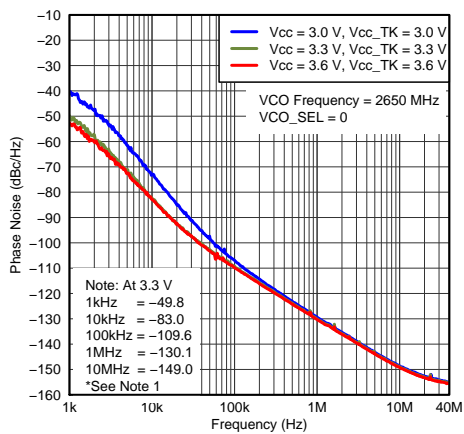

Figure 7. Open-Loop Phase Noise vs voltage (VCO\_SEL = 0)

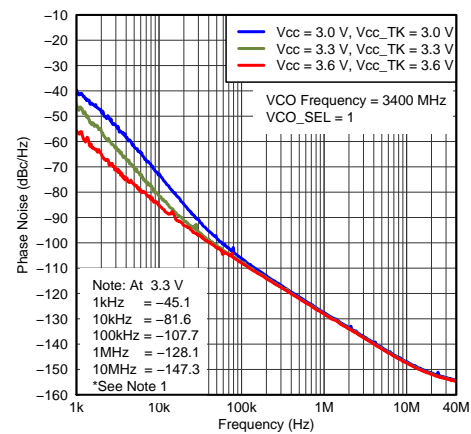

Figure 8. Open-Loop Phase Noise vs Voltage (VCO\_SEL = 1)

At  $T_A = 25^\circ\text{C}$ ,  $V_{CC} = 3.3\text{ V}$ ,  $V_{CC\_TK} = 3.3\text{ V}$ , LO1\_OUTP (single-ended), PWD\_BUFF2,3,4 = off, VCO\_BIAS = 400  $\mu\text{A}$ ; BUFOUT\_BIAS = 600  $\mu\text{A}$ , all other registers set per recommended programming in [Serial Programming Interface Register Definitions](#), and standard operating condition, unless otherwise noted.

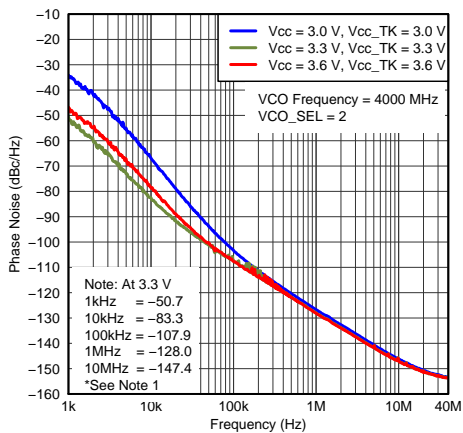

Figure 9. Open-Loop Phase Noise vs Voltage (VCO\_SEL = 2)

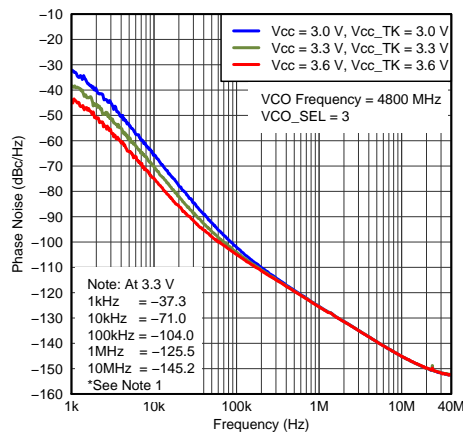

Figure 10. Open-Loop Phase Noise vs Voltage (VCO\_SEL = 3)

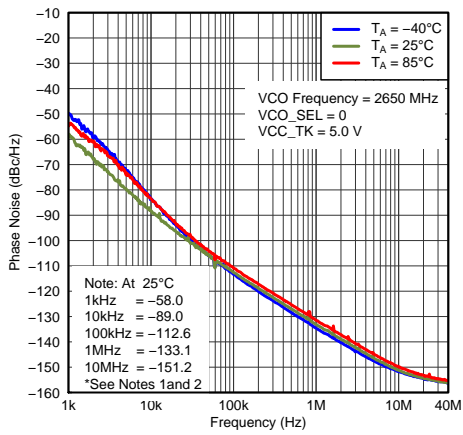

Figure 11. Open-Loop Phase Noise vs Temperature (VCO\_SEL = 0 and VCC\_TK = 5 V)

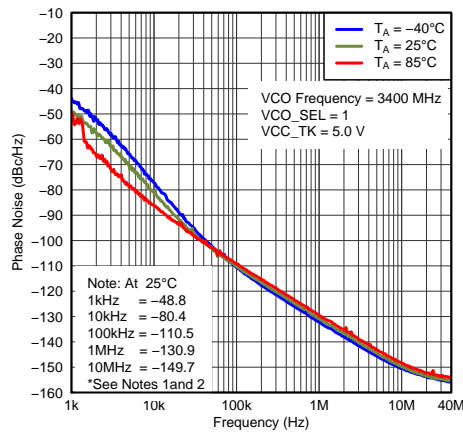

Figure 12. Open-Loop Phase Noise vs Temperature (VCO\_SEL = 1 and VCC\_TK = 5 V)

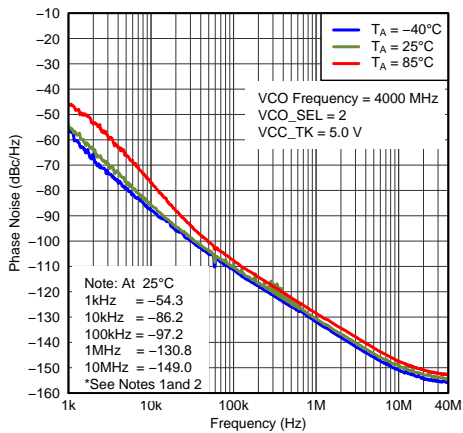

Figure 13. Open-Loop Phase Noise vs Temperature (VCO\_SEL = 2 and VCC\_TK = 5 V)

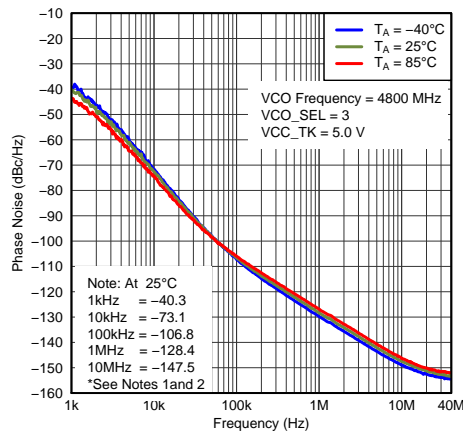

Figure 14. Open-Loop Phase Noise vs Temperature (VCO\_SEL = 3 and VCC\_TK = 5 V)

At  $T_A = 25^\circ\text{C}$ ,  $V_{CC} = 3.3\text{ V}$ ,  $V_{CC\_TK} = 3.3\text{ V}$ , LO1\_OUTP (single-ended), PWD\_BUFF2,3,4 = off, VCO\_BIAS = 400  $\mu\text{A}$ ; BUFOUT\_BIAS = 600  $\mu\text{A}$ , all other registers set per recommended programming in [Serial Programming Interface Register Definitions](#), and standard operating condition, unless otherwise noted.

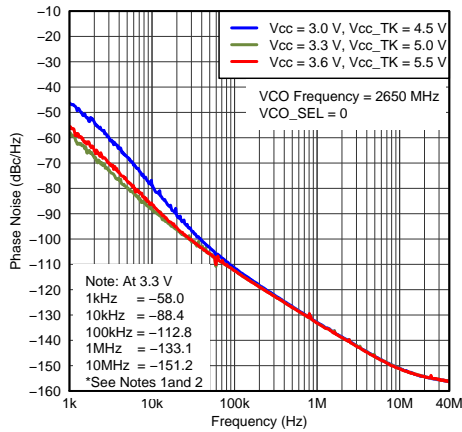

Figure 15. Open-Loop Phase Noise vs Voltage (VCO\_SEL = 0)

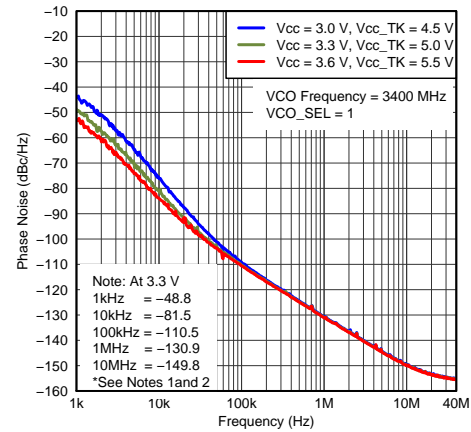

Figure 16. Open-Loop Phase Noise vs Voltage (VCO\_SEL = 1)

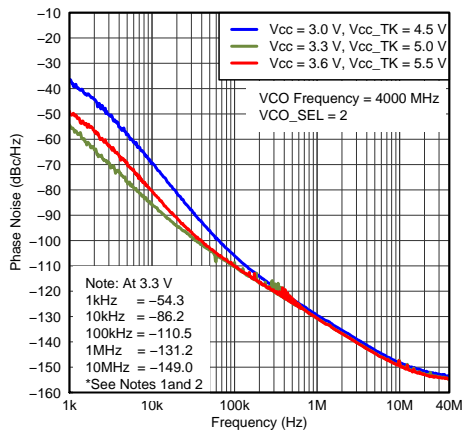

Figure 17. Open-Loop Phase Noise vs Voltage (VCO\_SEL = 2)

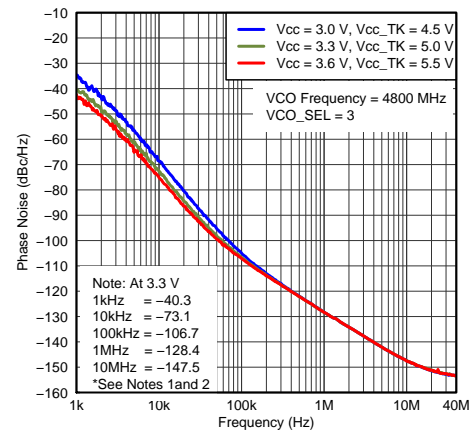

Figure 18. Open-Loop Phase Noise vs Voltage (VCO\_SEL = 3)

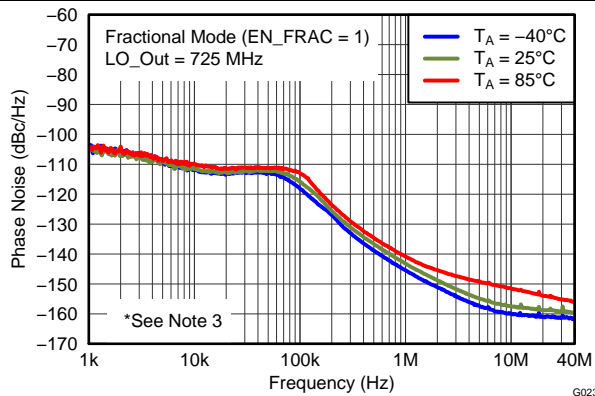

Figure 19. Closed-Loop Phase Noise vs Temperature (725 MHz, VCC\_TK = 3.3 V, Fractional Mode)

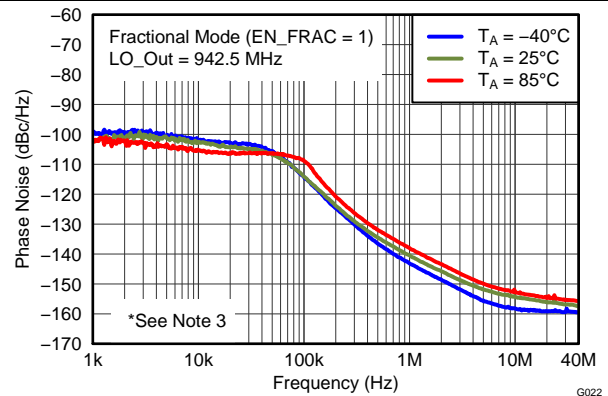

Figure 20. Closed-Loop Phase Noise vs Temperature (942.5 MHz, VCC\_TK = 3.3 V, Fractional Mode)

At  $T_A = 25^\circ\text{C}$ ,  $V_{CC} = 3.3\text{ V}$ ,  $V_{CC\_TK} = 3.3\text{ V}$ , LO1\_OUTP (single-ended), PWD\_BUFF2,3,4 = off, VCO\_BIAS = 400  $\mu\text{A}$ ; BUFOUT\_BIAS = 600  $\mu\text{A}$ , all other registers set per recommended programming in [Serial Programming Interface Register Definitions](#), and standard operating condition, unless otherwise noted.

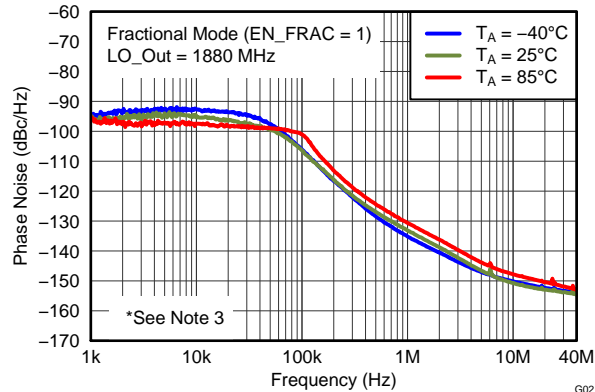

Figure 21. Closed-Loop Phase Noise vs Temperature (1880 MHz,  $V_{CC\_TK} = 3.3\text{ V}$ , Fractional Mode)

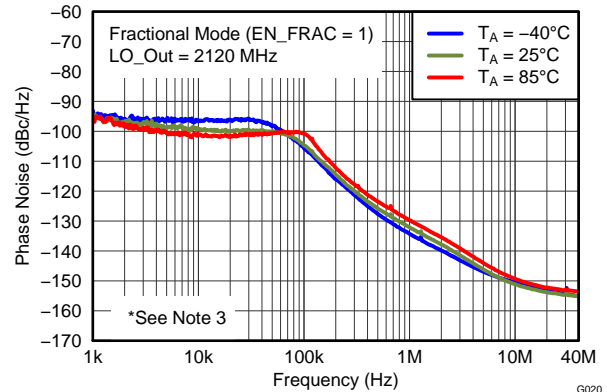

Figure 22. Closed-Loop Phase Noise vs Temperature (2120 MHz,  $V_{CC\_TK} = 3.3\text{ V}$ , Fractional Mode)

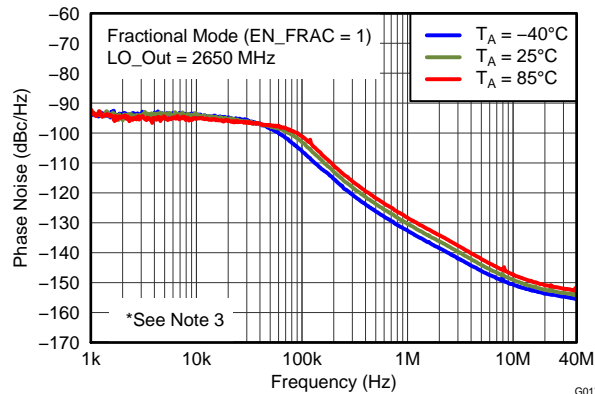

Figure 23. Closed-Loop Phase Noise vs Temperature (2650 MHz,  $V_{CC\_TK} = 3.3\text{ V}$ , Fractional Mode)

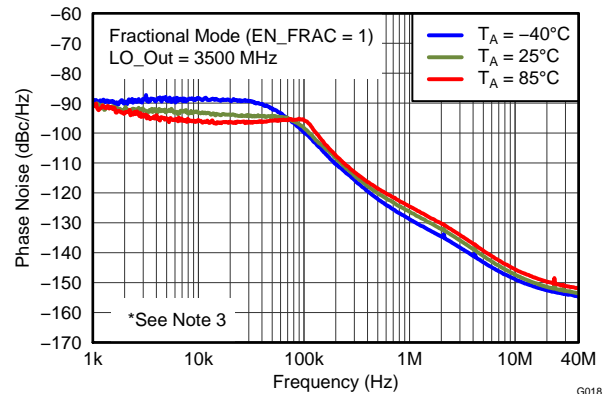

Figure 24. Closed-Loop Phase Noise vs Temperature (3500 MHz,  $V_{CC\_TK} = 3.3\text{ V}$ , Fractional Mode)

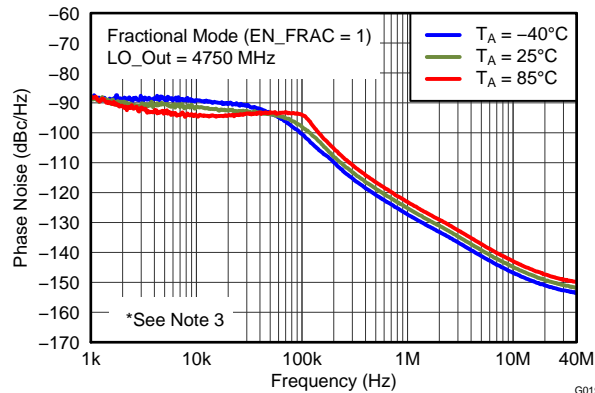

Figure 25. Closed-Loop Phase Noise vs Temperature (4750 MHz,  $V_{CC\_TK} = 3.3\text{ V}$ , Fractional Mode)

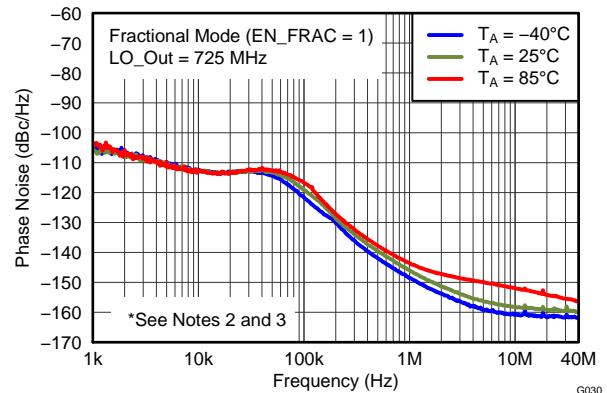

Figure 26. Closed-Loop Phase Noise vs Temperature (725 MHz,  $V_{CC\_TK} = 5\text{ V}$ , Fractional Mode)

At  $T_A = 25^\circ\text{C}$ ,  $V_{CC} = 3.3\text{ V}$ ,  $V_{CC\_TK} = 3.3\text{ V}$ , LO1\_OUTP (single-ended), PWD\_BUFF2,3,4 = off, VCO\_BIAS = 400  $\mu\text{A}$ ; BUFOUT\_BIAS = 600  $\mu\text{A}$ , all other registers set per recommended programming in [Serial Programming Interface Register Definitions](#), and standard operating condition, unless otherwise noted.

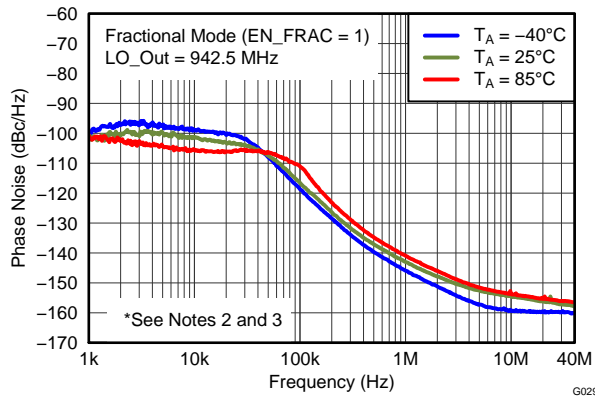

Figure 27. Closed-Loop Phase Noise vs Temperature (942.5 MHz, VCC\_TK = 5 V, Fractional Mode)

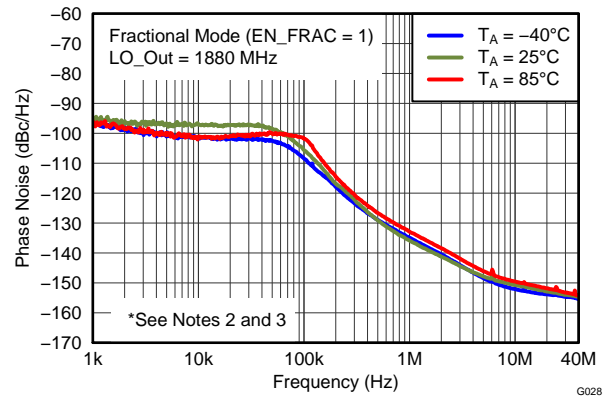

Figure 28. Closed-Loop Phase Noise vs Temperature (1880 MHz, VCC\_TK = 5 V, Fractional Mode)

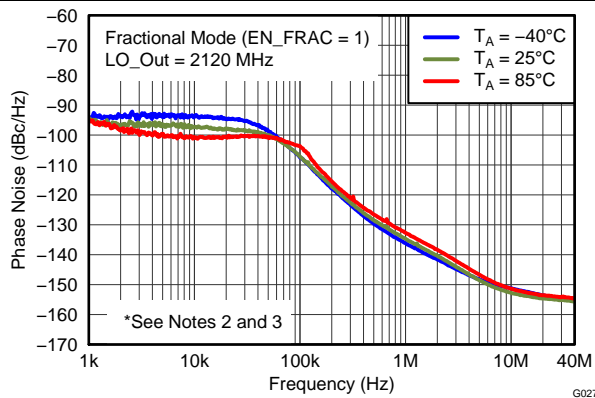

Figure 29. Closed-Loop Phase Noise vs Temperature (2120 MHz, VCC\_TK = 5 V, Fractional Mode)

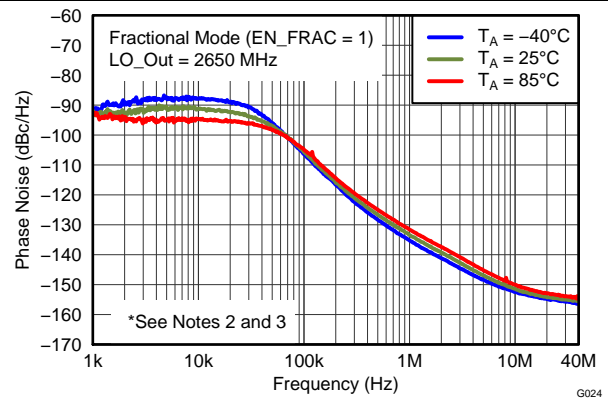

Figure 30. Closed-Loop Phase Noise vs Temperature (2650 MHz, VCC\_TK = 5 V, Fractional Mode)

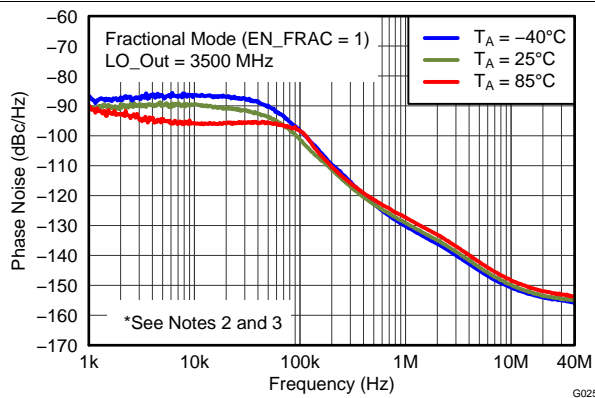

Figure 31. Closed-Loop Phase Noise vs Temperature (3500 MHz, VCC\_TK = 5 V, Fractional Mode)

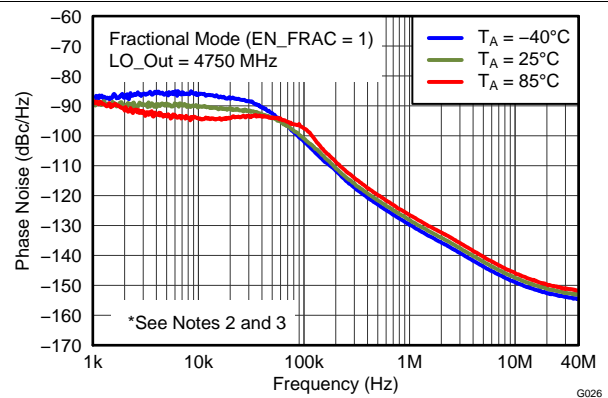

Figure 32. Closed-Loop Phase Noise vs Temperature (4750 MHz, VCC\_TK = 5 V, Fractional Mode)

At  $T_A = 25^\circ\text{C}$ ,  $V_{CC} = 3.3\text{ V}$ ,  $V_{CC\_TK} = 3.3\text{ V}$ , LO1\_OUTP (single-ended), PWD\_BUFF2,3,4 = off, VCO\_BIAS = 400  $\mu\text{A}$ ; BUFOUT\_BIAS = 600  $\mu\text{A}$ , all other registers set per recommended programming in [Serial Programming Interface Register Definitions](#), and standard operating condition, unless otherwise noted.

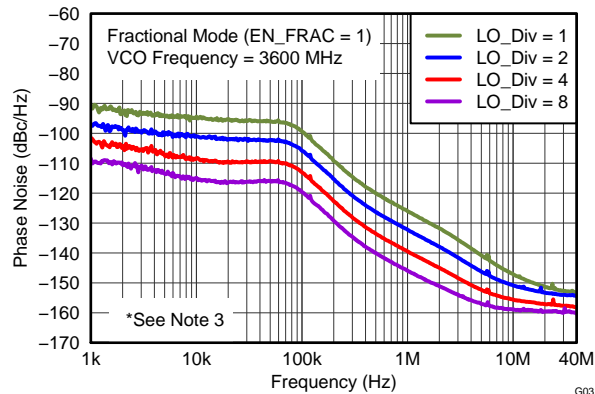

Figure 33. Closed-Loop Phase Noise vs Divide Ratio ( $V_{CC\_TK} = 3.3\text{ V}$ , Fractional Mode)

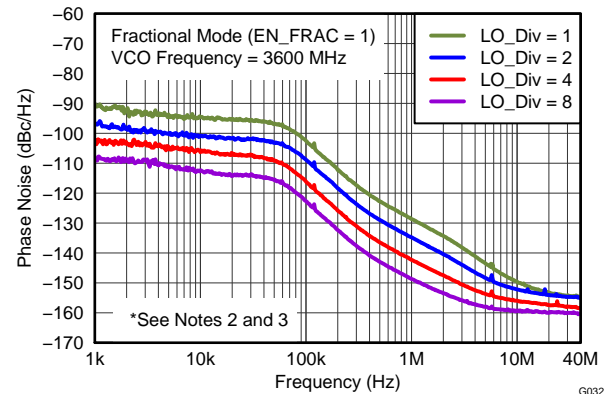

Figure 34. Closed-Loop Phase Noise vs Divide Ratio ( $V_{CC\_TK} = 5\text{ V}$ , Fractional Mode)

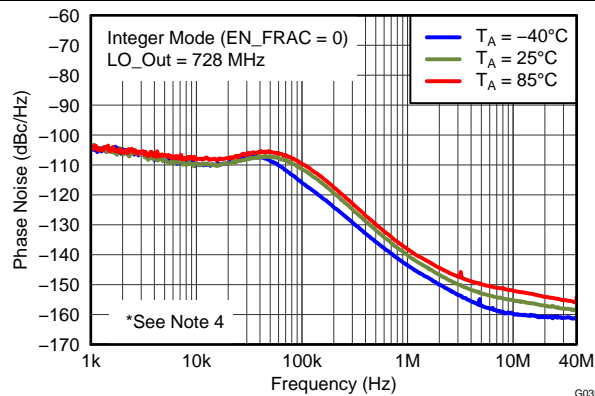

Figure 35. Closed-Loop Phase Noise vs Temperature (728 MHz,  $V_{CC\_TK} = 3.3\text{ V}$ , Integer Mode)

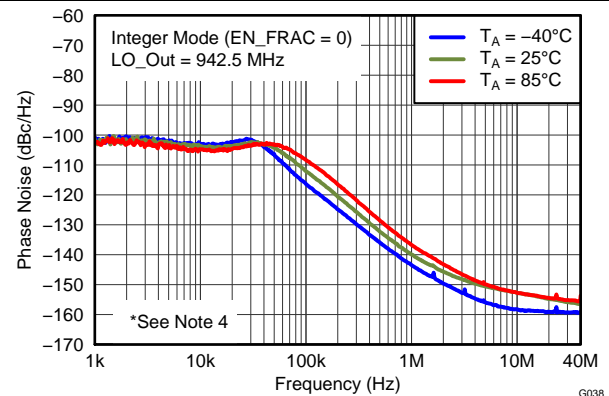

Figure 36. Closed-Loop Phase Noise vs Temperature (942.5 MHz,  $V_{CC\_TK} = 3.3\text{ V}$ , Integer Mode)

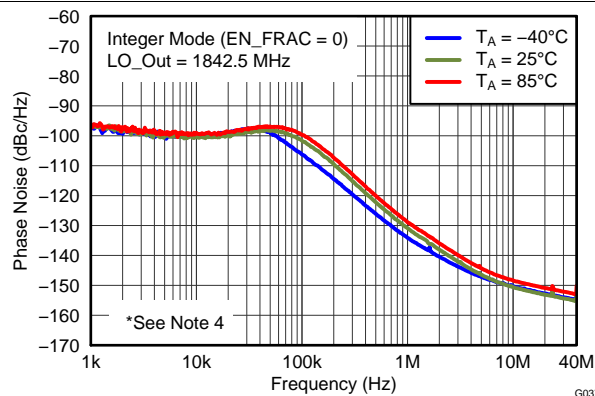

Figure 37. Closed-Loop Phase Noise vs Temperature (1842.5 MHz,  $V_{CC\_TK} = 3.3\text{ V}$ , Integer Mode)

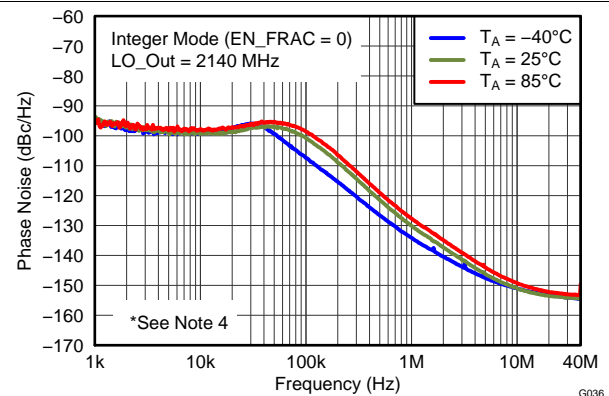
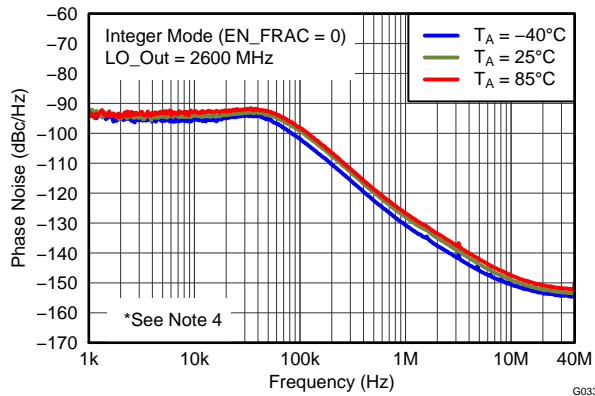
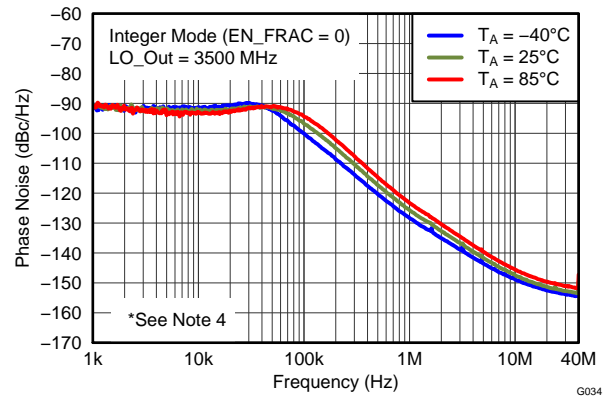

Figure 38. Closed-Loop Phase Noise vs Temperature (2140 MHz,  $V_{CC\_TK} = 3.3\text{ V}$ , Integer Mode)

At  $T_A = 25^\circ\text{C}$ ,  $V_{CC} = 3.3\text{ V}$ ,  $V_{CC\_TK} = 3.3\text{ V}$ , LO1\_OUTP (single-ended), PWD\_BUFF2,3,4 = off, VCO\_BIAS = 400  $\mu\text{A}$ ; BUFOUT\_BIAS = 600  $\mu\text{A}$ , all other registers set per recommended programming in [Serial Programming Interface Register Definitions](#), and standard operating condition, unless otherwise noted.



**Figure 39. Closed-Loop Phase Noise vs Temperature (2600 MHz, VCC\_TK = 3.3 V, Integer Mode)**



**Figure 40. Closed-Loop Phase Noise vs Temperature (3500 MHz, VCC\_TK = 3.3 V, Integer Mode)**

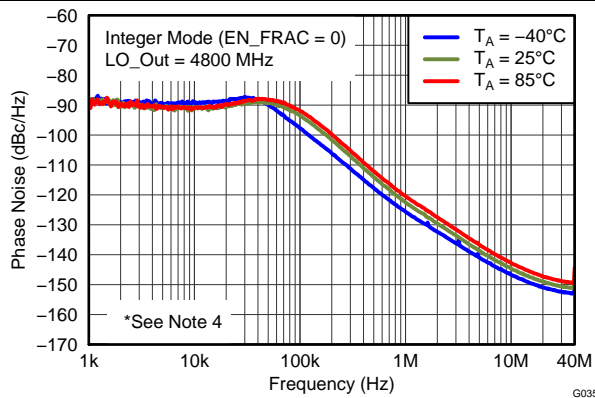

**Figure 41. Closed-Loop Phase Noise vs Temperature (4800 MHz, VCC\_TK = 3.3 V, Integer Mode)**

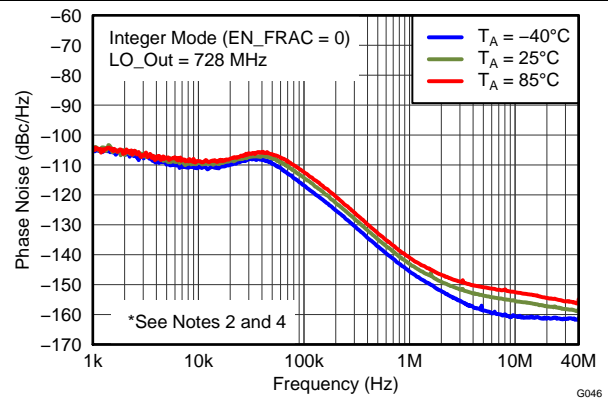

**Figure 42. Closed-Loop Phase Noise vs Temperature (728 MHz, VCC\_TK = 5 V, Integer Mode)**

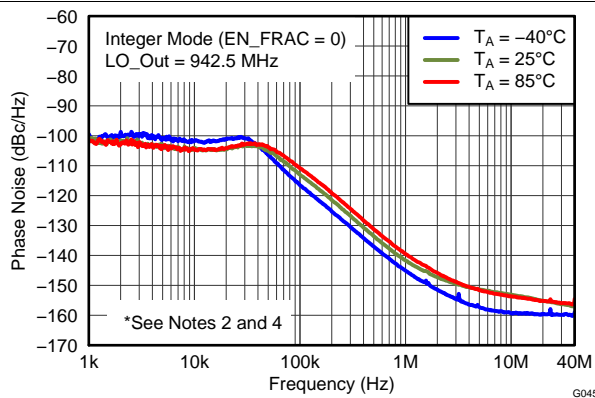

**Figure 43. Closed-Loop Phase Noise vs Temperature (942.5 MHz, VCC\_TK = 5 V, Integer Mode)**

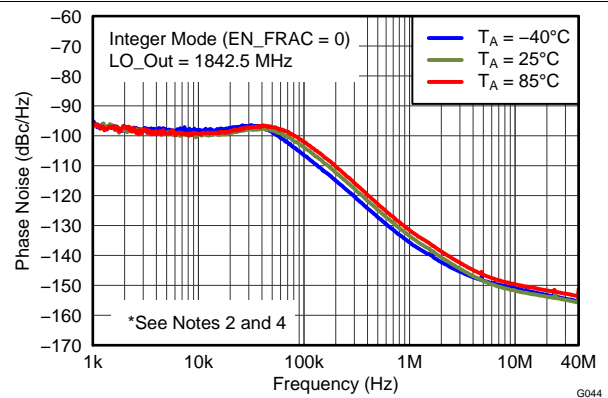

**Figure 44. Closed-Loop Phase Noise vs Temperature (1842.5 MHz, VCC\_TK = 5 V, Integer Mode)**



At  $T_A = 25^\circ\text{C}$ ,  $V_{CC} = 3.3\text{ V}$ ,  $V_{CC\_TK} = 3.3\text{ V}$ , LO1\_OUTP (single-ended), PWD\_BUFF2,3,4 = off, VCO\_BIAS = 400  $\mu\text{A}$ ; BUFOUT\_BIAS = 600  $\mu\text{A}$ , all other registers set per recommended programming in [Serial Programming Interface Register Definitions](#), and standard operating condition, unless otherwise noted.

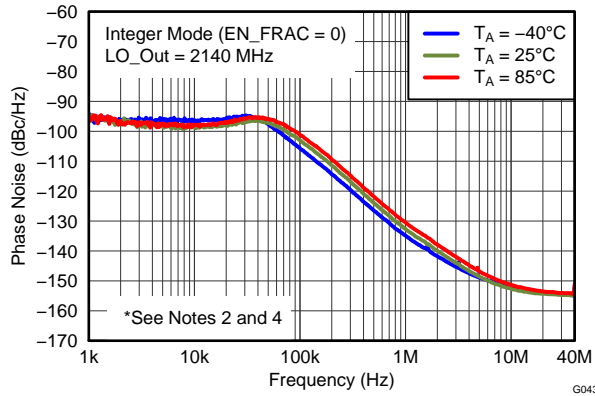

Figure 45. Closed-Loop Phase Noise vs Temperature (2140 MHz, VCC\_TK = 5 V, Integer Mode)

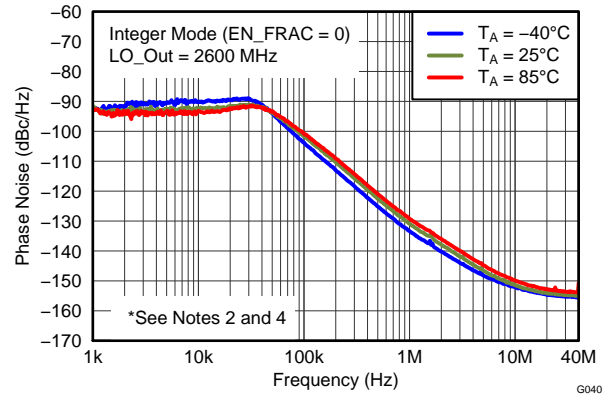

Figure 46. Closed-Loop Phase Noise vs Temperature (2600 MHz, VCC\_TK = 5 V, Integer Mode)

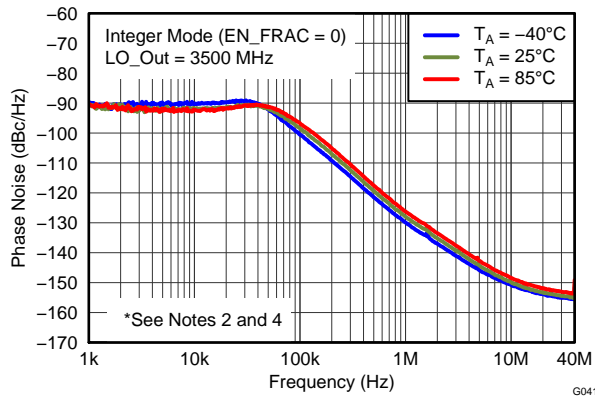

Figure 47. Closed-Loop Phase Noise vs Temperature (3500 MHz, VCC\_TK = 5 V, Integer Mode)

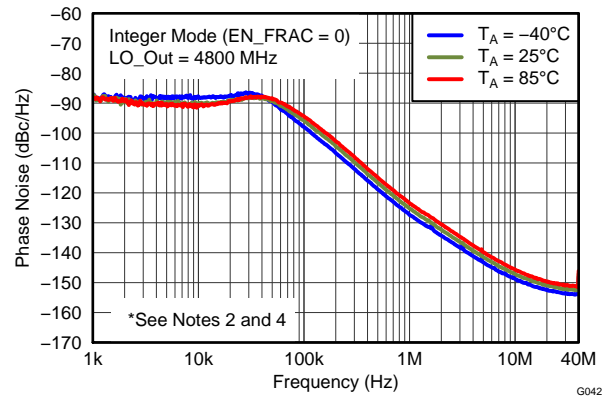

Figure 48. Closed-Loop Phase Noise vs Temperature (4800 MHz, VCC\_TK = 5 V, Integer Mode)

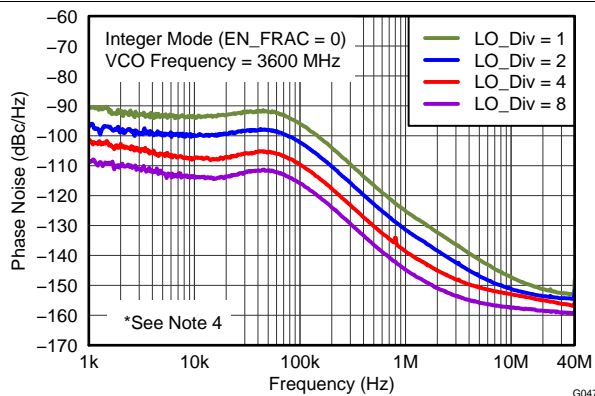

Figure 49. Closed-Loop Phase Noise vs Divide Ratio (VCC\_TK = 3.3 V, Integer Mode)

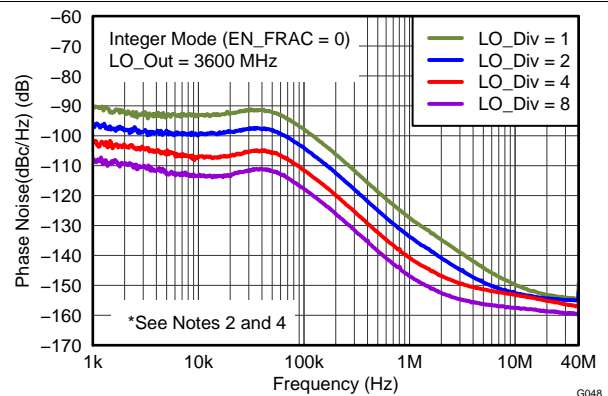

Figure 50. Closed-Loop Phase Noise vs Divide Ratio (VCC\_TK = 5 V, Integer Mode)

At  $T_A = 25^\circ\text{C}$ ,  $V_{CC} = 3.3\text{ V}$ ,  $V_{CC\_TK} = 3.3\text{ V}$ , LO1\_OUTP (single-ended), PWD\_BUFF2,3,4 = off, VCO\_BIAS = 400  $\mu\text{A}$ ; BUFOUT\_BIAS = 600  $\mu\text{A}$ , all other registers set per recommended programming in [Serial Programming Interface Register Definitions](#), and standard operating condition, unless otherwise noted.

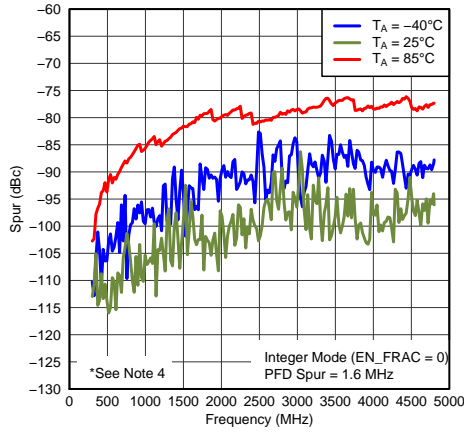

Figure 51. PFD Spurs vs Temperature (Integer Mode)

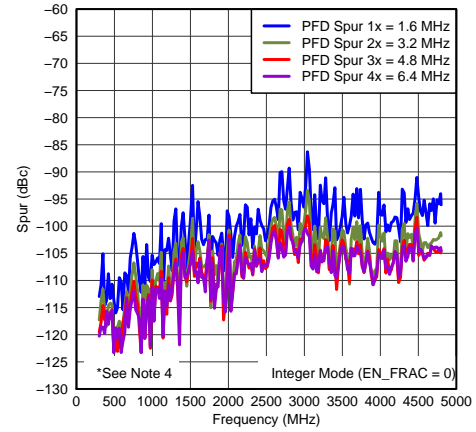

Figure 52. Multiples of PFD Spurs (Integer Mode)

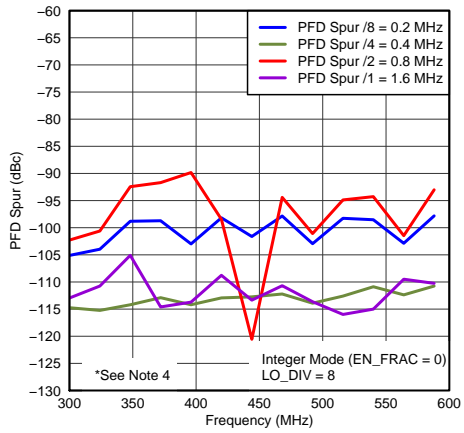

Figure 53. Multiples of PFD Spurs (LO\_DIV = 8, Integer Mode)

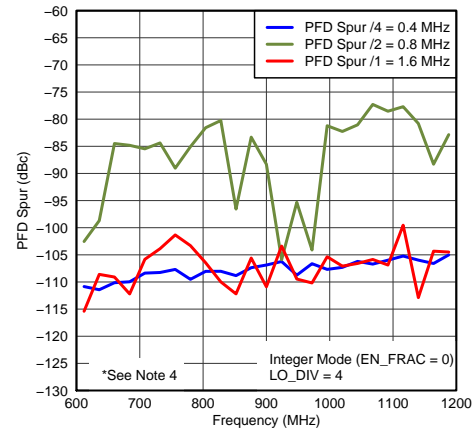

Figure 54. Multiples of PFD spurs (LO\_DIV = 4, Integer Mode)

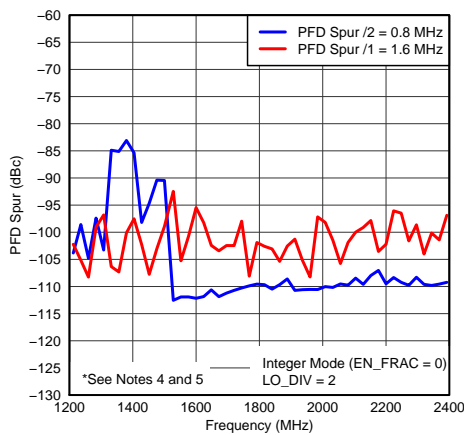

Figure 55. Multiples of PFD Spurs (LO\_DIV = 2, Integer Mode)

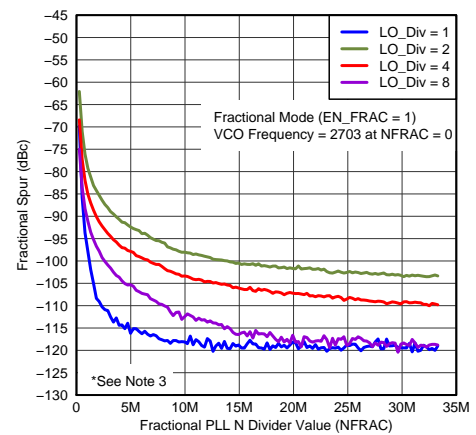

Figure 56. Fractional Spurs vs LO divider

At  $T_A = 25^\circ\text{C}$ ,  $V_{CC} = 3.3\text{ V}$ ,  $V_{CC\_TK} = 3.3\text{ V}$ , LO1\_OUTP (single-ended), PWD\_BUFF2,3,4 = off, VCO\_BIAS = 400  $\mu\text{A}$ ; BUFOUT\_BIAS = 600  $\mu\text{A}$ , all other registers set per recommended programming in [Serial Programming Interface Register Definitions](#), and standard operating condition, unless otherwise noted.

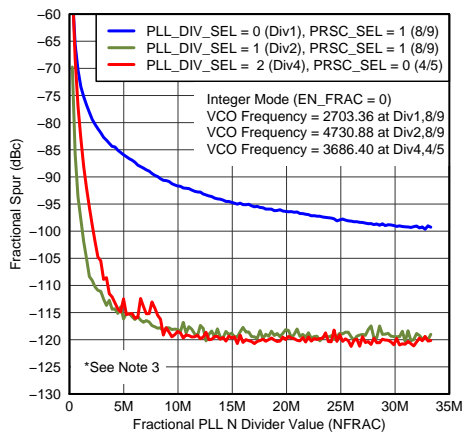

Figure 57. Fractional Spurs vs RF Divider and Prescaler

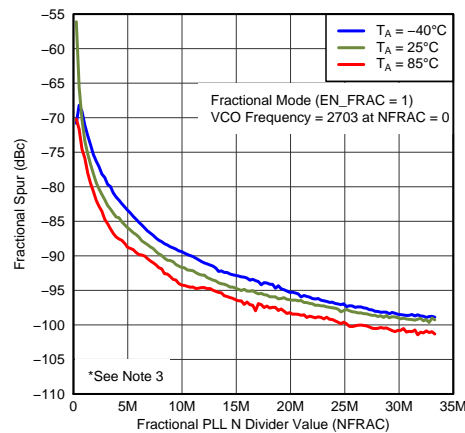

Figure 58. Fractional Spurs vs Temperature

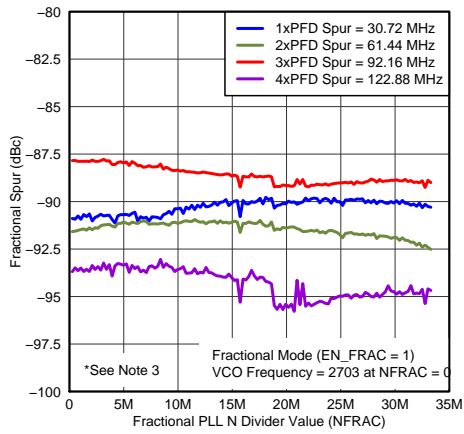

Figure 59. Multiples of PFD Spurs (Fractional Mode)

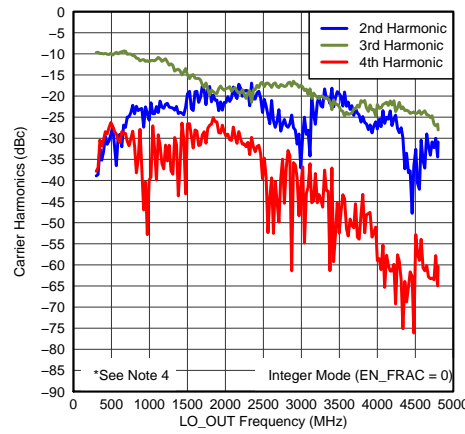

Figure 60. LO Harmonics

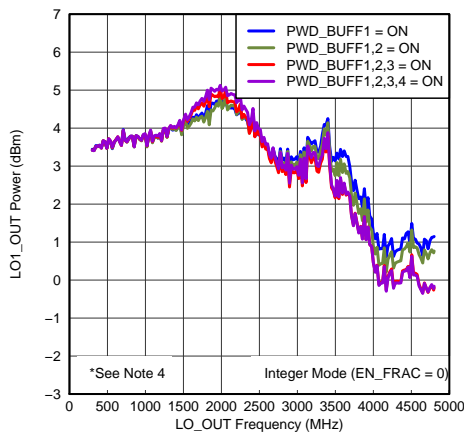

Figure 61. Output Power on LO1\_OUTP With Multiple Buffers

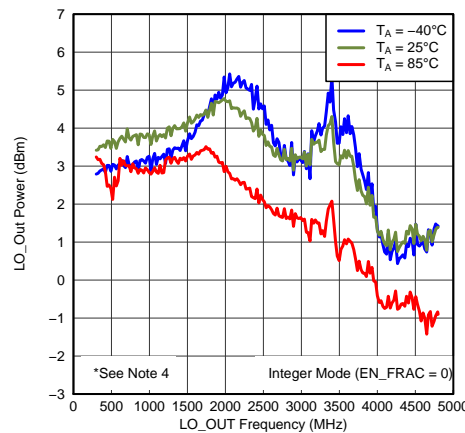

Figure 62. Output Power With Multiple Buffers

At  $T_A = 25^\circ\text{C}$ ,  $V_{CC} = 3.3\text{ V}$ ,  $V_{CC\_TK} = 3.3\text{ V}$ , LO1\_OUTP (single-ended), PWD\_BUFF2,3,4 = off, VCO\_BIAS =  $400\ \mu\text{A}$ ; BUFOUT\_BIAS =  $600\ \mu\text{A}$ , all other registers set per recommended programming in *Serial Programming Interface Register Definitions*, and standard operating condition, unless otherwise noted.

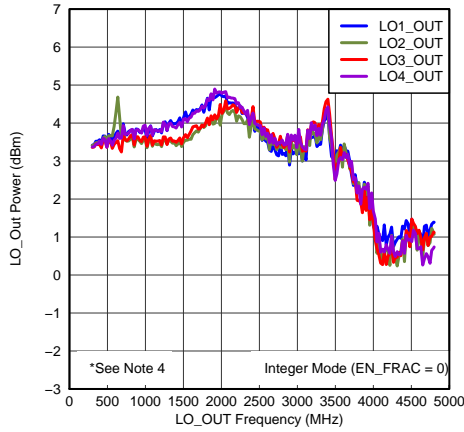

Figure 63. Output Power vs Output Port

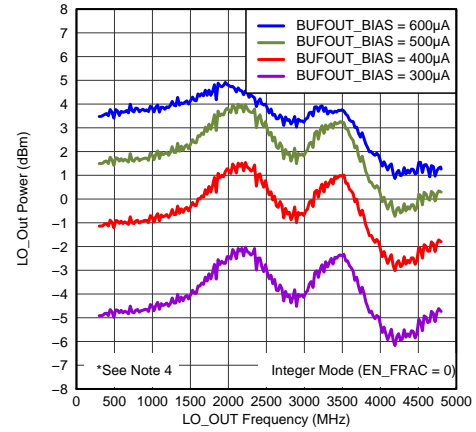

Figure 64. Output Power vs Buffer Bias

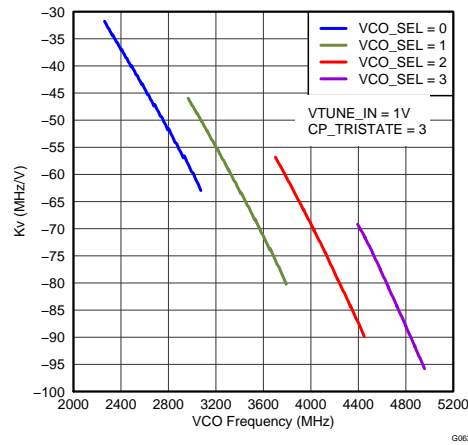

Figure 65. VCO Gain (Kv) vs Frequency

## 7 Detailed Description

### 7.1 Overview

The TRF3765 device features a four-wire serial programming interface (4WI) that controls an internal 32-bit shift register. There are a total of three signals that must be applied: the clock (CLOCK, pin 4), the serial data (DATA, pin 3); and the latch enable (STROBE, pin 5).

The serial data (DB0-DB31) are loaded least significant bit (LSB) first, and read on the rising edge of CLOCK. STROBE is asynchronous to the CLOCK signal, at its rising edge, the data in the shift register are loaded into the selected internal register. Figure 1 shows the timing for the 4WI. *4WI Timing: Write Operation* lists the 4WI timing for the write operation.

### 7.2 Functional Block Diagram

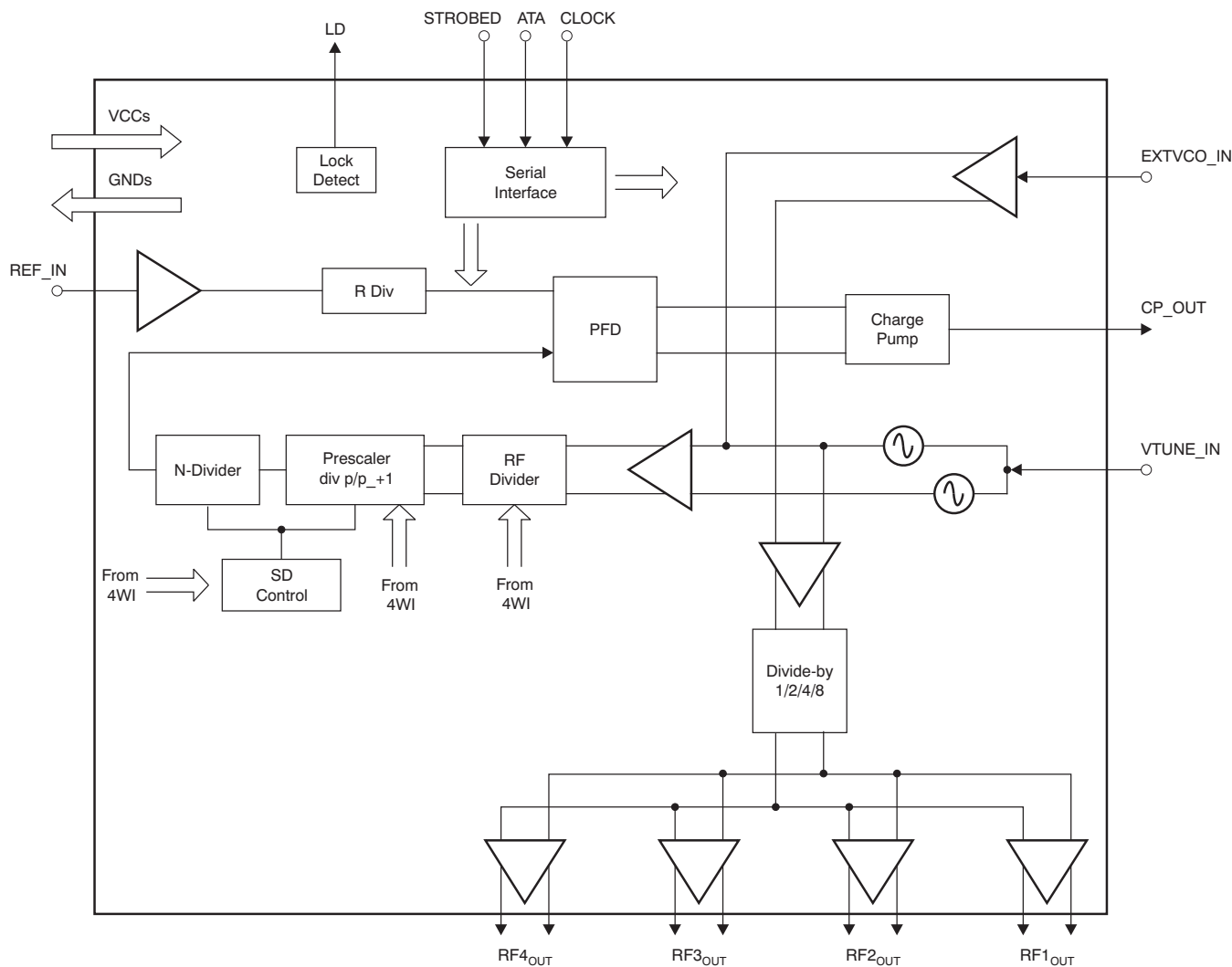

### 7.3 Feature Description

#### 7.3.1 Lock Detect

The lock detect signal is generated in the phase frequency detector by comparing the VCO target phase against the VCO actual phase. When the two compared phase signals remain aligned for several clock cycles, an internal signal goes high. The precision of this comparison is controlled through the LD\_ANA\_PREC bits. This internal signal is then averaged and compared against a reference voltage to generate the LD signal. The number of averages used is controlled through LD\_DIG\_PREC. Therefore, when the VCO is frequency locked, LD is high. When the VCO frequency is not locked, LD may pulse high or exhibit periodic behavior.

By default, the internal lock detect signal is made available on the LD pin. Register bits MUX\_CTRL\_n can be used to control a multiplexer to output other diagnostic signals on the LD output. The LD control signals are shown in [Table 2](#). [Table 3](#) shows the LD Control Signal Mode settings.

**Table 2. LD Control Signals**

ADJUSTMENT	REGISTER BITS	BIT ADDRESSING
Lock detect precision	LD_ANA_PREC_0	Reg4B19
Unlock detect precision	LD_ANA_PREC_1	Reg4B20
LD averaging count	LD_DIG_PREC	Reg4B24
Diagnostic output	MUX_CTRL_n	Reg6B[18..16]

**Table 3. LD Control Signal Mode Settings**

CONDITION	RECOMMENDED SETTINGS
Integer mode	LD_ANA_PREC_0 = 0 LD_ANA_PREC_1 = 0 LD_DIG_PREC = 0
Fractional mode	LD_ANA_PREC_0 = 1 LD_ANA_PREC_1 = 1 LD_DIG_PREC = 0

#### 7.3.2 LO Divider

The LO divider is shown in [Figure 66](#). It frequency divides the VCO output. Only one of the dividers operates at a time, and the appropriate output is selected by a mux. DIVn bits are controlled through LO\_DIV\_SEL\_n. The output is buffered and provided on output pins LOn\_OUT\_P and LOn\_OUT\_N. Outputs are phase-locked but not phase-matched. The output level is controlled through BUFOUT\_BIAS.

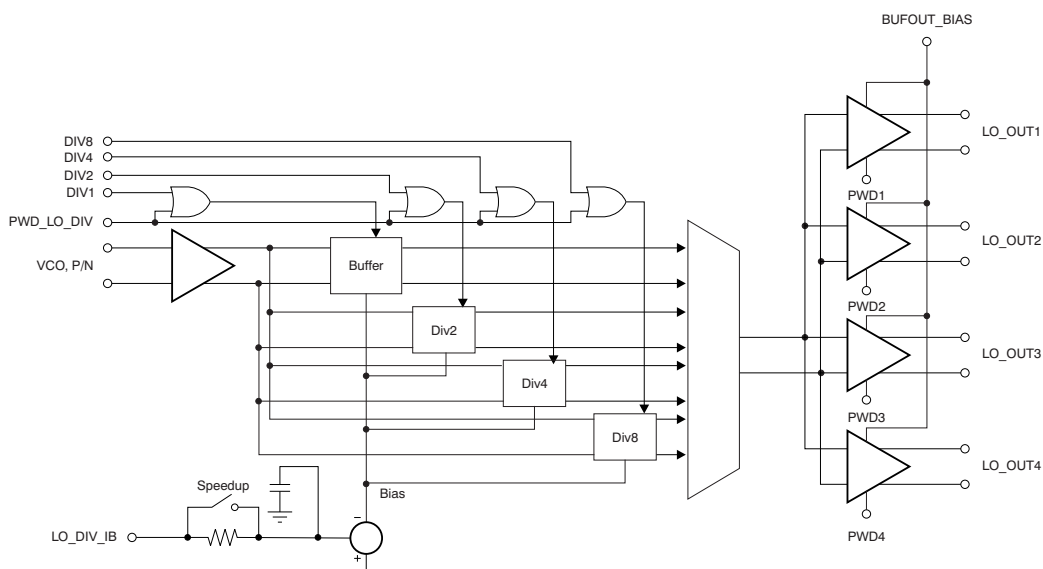

**Figure 66. LO Divider**

LO\_DIV\_IB determines the bias level for the divider blocks. The SPEEDUP control is used to bypass a stabilization resistor and reach the final bias level faster after a change in the divider selection. SPEEDUP should be disabled during normal operation.

### 7.3.3 Selecting the VCO and VCO Frequency Control

To achieve a broad frequency tuning range, the TRF3765 includes four VCOs. Each VCO is connected to a bank of coarse tuning capacitors that determine the valid operating frequency of each VCO. For any given frequency setting, the appropriate VCO and capacitor array must be selected.

The device contains logic that automatically selects the appropriate VCO and capacitor bank. Set bit EN\_CAL to initiate the calibration algorithm. During the calibration process, the device selects a VCO and a tuning capacitor state such that  $V_{TUNE}$  matches the reference voltage set by VCO\_CAL\_REF\_n. Accuracy of the resulting tuning word is increased through bits CAL\_ACC\_n at the expense of increased calibration time. A calibration begins immediately when EN\_CAL is set; as a result, all registers must contain valid values before a calibration is initiated.

The calibration logic is driven by a CAL\_CLK clock derived from the phase frequency detector frequency scaled according to the setting in CAL\_CLK\_SEL. Faster CAL\_CLK frequencies enable faster calibrations, but the logic is limited to clock frequencies up to 600 kHz. The flag R\_SAT\_ERR is evaluated during the calibration process to indicate calibration counter overflow errors, which occur if CAL\_CLK runs too quickly. If R\_SAT\_ERR is set during a calibration, the resulting calibration is not valid and CAL\_CLK\_SEL must be used to slow the CAL\_CLK. CAL\_CLK frequencies should not be set below 0.05 MHz. Reference clock frequency is usually limited by the calibration logic.  $f_{REF} \times \text{CAL\_CLK\_SEL scaling factor} > 0.01 \text{ MHz}$  and  $f_{REF}/(\text{CAL\_CLK\_SEL scaling factor} \times f_{PFD}) < 8000$  are required. For example, with  $f_{REF} = 61.44 \text{ MHz}$ ,  $f_{PFD} = 30.72 \text{ MHz}$  and CAL\_CLK\_SEL at 1/128,  $61.44/128 = 0.5 > 0.01$  and  $61.44/(30.72 \times 1/128) = 256 < 8000$ .

When VCOSEL\_MODE is 0, the device automatically selects both the VCO and capacitor bank within 46 CAL\_CLK cycles. When VCOSEL\_MODE is 1, the device uses the VCO selected in VCO\_SEL\_0 and VCO\_SEL\_1 and automatically selects the capacitor array within 34 CAL\_CLK cycles. The VCO and capacitor array settings that result from a calibration cannot be read from the VCO\_SEL\_n and VCO\_TRIM\_n bits in Registers 2 and 7. These settings can only be read from Register 0.

Automatic calibration can be disabled by setting CAL\_BYPASS to 1. In this manual calibration mode, the VCO is selected through register bits VCO\_SEL\_n, while the capacitor array is selected through register bits VCO\_TRIM\_n. Calibration modes are summarized in Table 4. After calibration is complete, the PLL is released from calibration mode and reaches phase lock.

**Table 4. VCO Calibration Modes**

CAL_BYPASS	VCOSEL_MODE	MAX CYCLES CAL_CLK	VCO	CAPACITOR ARRAY
0	0	46	Automatic	
0	1	34	VCO_SEL_n	Automatic
1	<i>don't care</i>	N/A	VCO_SEL_n	VCO_TRIM_n

During the calibration process, the TRF3765 scans through many frequencies. RF and LO outputs should be disabled until calibration is complete. At power-up, the RF and LO output are disabled by default. Once a calibration has been performed at a given frequency setting, the calibration remains valid over all operating temperature conditions.

### 7.3.4 External VCO

An external LO or VCO signal may be applied. EN\_EXTVCO powers the input buffer and selects the buffered external signal instead of an internal VCO. Dividers, phase-frequency detector, and charge pump remain enabled and may be used to control  $V_{TUNE}$  or an external VCO. NEG\_VCO must correspond to the sign of the external VCO tuning characteristic. EXT\_VCO\_CTRL = 1 asserts a logic 1 output level at the corresponding output pin. This configuration can be used to enable or disable the external VCO circuit or module.

## 7.4 Device Functional Modes

### 7.4.1 VCO\_TEST\_MODE

Setting VCO\_TEST\_MODE forces the currently selected VCO to the edge of its frequency range by disconnecting the charge pump input from the phase detector and loop filter, and forcing its output high or low. The upper or lower edge of the VCO range is selected through COUNT\_MODE\_MUX\_SEL.

VCO\_TEST\_MODE also reports the value of a frequency counter in COUNT, which can be read back in Register 0. COUNT reports the number of digital  $N$  divider cycles in the PLL, directly related to the period of  $f_N$ , that occur during each CAL\_CLK cycle. Counter operation is initiated through the bit EN\_CAL. [Table 5](#) summarizes the settings for VCO\_TEST\_MODE.

**Table 5. VCO\_TEST\_MODE Settings**

VCO_TEST_MODE	COUNT_MODE_MUX_SEL	VCO OPERATION	REGISTER 0 B[30..13]
0	<i>Don't care</i>	Normal	B[30..24] = undefined B[23..22] = VCO_SEL selected during autocal B21 = undefined B[20..15] = VCO_TRIM selected during autocal B[14..13] = undefined
1	0	Max frequency	B[30..13] = Max frequency counter
1	1	Min frequency	B[30..13] = Min frequency counter

### 7.4.2 Readback Mode

Register 0 functions as a readback register. The TRF3765 implements the capability to read back the content of any serial programming interface register by initializing Register 0.

Each read-back operation consists of two phases: a write followed by the actual reading of the internal data. This sequence is described in the timing diagram (see [Figure 2](#)). During the write phase, a command is sent to TRF3765 Register 0 to set it to readback mode and to specify which register is to be read. In the proper reading phase, at each rising clock edge, the internal data are transferred to the READBACK pin where it can be read at the following falling edge (LSB first). The first clock after the latch enable STROBE, pin 5, goes high (that is, the end of the write cycle) is idle and the following 32 clock pulses transfer the internal register contents to the READBACK pin (pin 6).

### 7.4.3 Integer and Fractional Mode Selection

The PLL is designed to operate in either Integer mode or Fractional mode. If the desired local oscillator (LO) frequency is an integer multiple of the phase frequency detector (PFD) frequency,  $f_{PFD}$ , then Integer mode can be selected. The normalized in-band phase noise floor in Integer mode is lower than in Fractional mode. In Integer mode, the feedback divider is an exact integer, and the fraction is zero. While operating in Integer mode, the register bits corresponding to the fractional control are *don't care*.

In Fractional mode, the feedback divider fractional portion is non-zero on average. With 25-bit fractional resolution, RF stepsize  $f_{PFD}/2^{25}$  is less than 1 Hz with a  $f_{PFD}$  up to 33 MHz. The appropriate fractional control bits in the serial register must be programmed.



### 7.4.4 PLL Architecture

Figure 67 shows a diagram of the PLL loop.

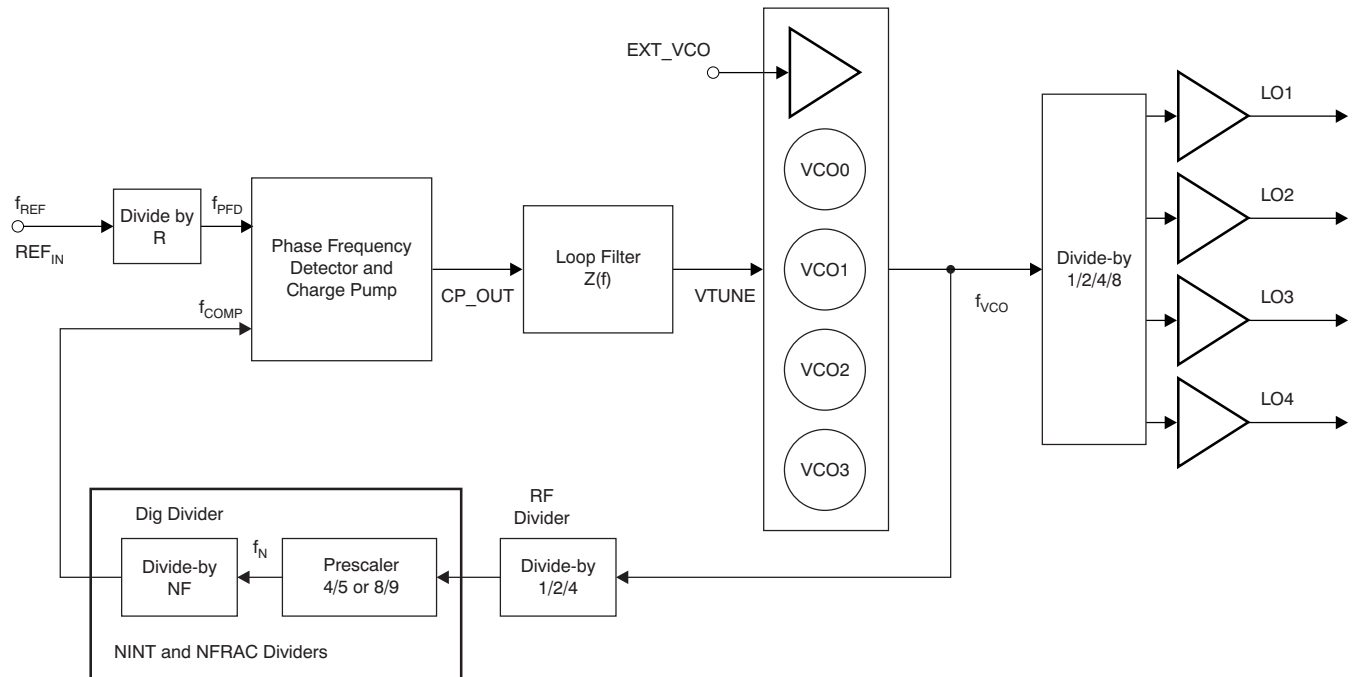

Figure 67. PLL Architecture

The output frequency is given by Equation 1:

$$f_{VCO} = \frac{f_{REF}}{RDIV} (PLL\_DIV\_SEL) \left[ NINT + \frac{NFRAC}{2^{25}} \right] \quad (1)$$

The rate at which phase comparison occurs is  $f_{REF}/RDIV$ . In Integer mode, the fractional setting is ignored and Equation 2 is applied.

$$\frac{f_{VCO}}{f_{PFD}} = NINT \times PLL\_DIV\_SEL \quad (2)$$

The feedback divider block consists of a programmable RF divider, a prescaler divider, and an NF divider. The prescaler can be programmed as either a 4/5 or an 8/9 prescaler. The NF divider includes an A counter and an M counter.

#### 7.4.4.1 Selecting PLL Divider Values

Operation of the PLL requires the LO\_DIV\_SEL, RDIV, PLL\_DIV\_SEL, NINT, and NFRAC bits to be calculated. The LO or mixer frequency is related to  $f_{VCO}$  according to divide-by-1/-2/-4/-8 blocks and the operating range of  $f_{VCO}$ .

##### a. LO\_DIV\_SEL

LO_DIV_SEL = 1	2400 MHz ≤ $f_{RF}$ ≤ 4800 MHz
LO_DIV_SEL = 2	1200 MHz ≤ $f_{RF}$ ≤ 2400 MHz
LO_DIV_SEL = 3	600 MHz ≤ $f_{RF}$ ≤ 1200 MHz
LO_DIV_SEL = 4	300 MHz ≤ $f_{RF}$ ≤ 600 MHz

Therefore:

$$f_{VCO} = LO\_DIV\_SEL \times f_{RF}$$

**b. PLL\_DIV\_SEL**

Given  $f_{VCO}$ , select the minimum value for PLL\_DIV\_SEL so that the programmable RF divider limits the input frequency into the prescaler block,  $f_{PM}$ , to a maximum of 3000 MHz.

$$\text{PLL\_DIV\_SEL} = \min(1, 2, 4) \text{ such that } f_{PM} \leq 3000 \text{ MHz}$$

This calculation can be restated as [Equation 3](#).

$$\text{PLL\_DIV\_SEL} = \text{Ceiling}\left(\frac{\text{LO\_DIV\_SEL} \times f_{RF}}{3000 \text{ MHz}}\right) \quad (3)$$

Higher values of  $f_{PFD}$  correspond to better phase noise performance in Integer mode or Fractional mode.  $f_{PFD}$ , along with PLL\_DIV\_SEL, determines the  $f_{VCO}$  stepsize in Integer mode. Therefore, in Integer mode, select the maximum  $f_{PFD}$  that allows for the required RF stepsize, as shown by [Equation 4](#).

$$f_{PFD} = \frac{f_{VCO, \text{Stepsize}}}{\text{PLL\_DIV\_SEL}} = \frac{f_{RF, \text{Stepsize}} \times \text{LO\_DIV\_SEL}}{\text{PLL\_DIV\_SEL}} \quad (4)$$

In Fractional mode, a small RF stepsize is accomplished through the Fractional mode divider. A large  $f_{PFD}$  should be used to minimize the effects of fractional controller noise in the output spectrum. In this case,  $f_{PFD}$  may vary according to the reference clock and fractional spur requirements; for example,  $f_{PFD} = 20$  MHz.

**c. RDIV, NINT, NFRAC, PRSC\_SEL**

$$\text{RDIV} = \frac{f_{REF}}{f_{PFD}}$$

$$\text{NINT} = \text{floor}\left(\frac{f_{VCO} \text{RDIV}}{f_{REF} \text{PLL\_DIV\_SEL}}\right)$$

$$\text{NFRAC} = \text{floor}\left(\left[\left(\frac{f_{VCO} \text{RDIV}}{f_{REF} \text{PLL\_DIV\_SEL}}\right) - \text{NINT}\right] 2^{25}\right)$$

The P/(P+1) programmable prescaler is set to 8/9 or 4/5 through the PRSC\_SEL bit. To allow proper fractional control, set PRSC\_SEL according to [Equation 5](#).

$$\text{PRSC\_SEL} = \begin{cases} \frac{8}{9} & \text{NINT} \geq 75 \text{ in Fractional Mode or } \text{NINT} \geq 72 \text{ in Integer mode} \\ \frac{4}{5} & 23 \leq \text{NINT} < 75 \text{ in Fractional mode or } 20 \leq \text{NINT} < 72 \text{ in Integer mode} \end{cases} \quad (5)$$

The PRSC\_SEL limit at  $\text{NINT} < 75$  applies to Fractional mode with third-order modulation. In Integer mode, the PRSC\_SEL = 8/9 should be used with NINT as low as 72. The divider block accounts for either value of PRSC\_SEL without requiring NINT or NFRAC to be adjusted. Then, calculate the maximum frequency to be input to the digital divider at  $f_N$ . Use the lower of the possible prescaler divide settings,  $P = (4, 8)$ , as shown by [Equation 6](#).

$$f_{N, \text{Max}} = \frac{f_{VCO}}{\text{PLL\_DIV\_SEL} \times P} \quad (6)$$

Verify that the frequency into the digital divider,  $f_N$ , is less than or equal to 375 MHz. If  $f_N$  exceeds 375 MHz, choose a larger value for PLL\_DIV\_SEL and recalculate  $f_{PFD}$ , RDIV, NINT, NFRAC, and PRSC\_SEL.

#### 7.4.4.2 Setup Example for Integer Mode

Suppose the following operating characteristics are desired for Integer mode operation:

- $f_{REF} = 40$  MHz (reference input frequency)
- Step at RF = 2 MHz (RF channel spacing)
- $f_{RF} = 1600$  MHz (RF frequency)

The VCO range is 2400 MHz to 4800 MHz. Therefore:

- LO\_DIV\_SEL = 2
- $f_{VCO} = LO\_DIV\_SEL \times 1600$  MHz = 3200 MHz

To keep the frequency of the prescaler below 3000 MHz:

- PLL\_DIV\_SEL = 2

The desired stepsize at RF is 2 MHz, so:

- $f_{PFD} = 2$  MHz
- $f_{VCO, stepsize} = PLL\_DIV\_SEL \times f_{PFD} = 4$  MHz

Using the reference frequency along with the required  $f_{PFD}$  gives:

- RDIV = 20
- NINT = 800

$NINT \geq 75$ ; therefore, select the 8/9 prescaler.

$$f_{N,Max} = 3200 \text{ MHz} / (2 \times 8) = 200 \text{ MHz} < 375 \text{ MHz}$$

This example shows that Integer mode operation gives sufficient resolution for the required stepsize.

#### 7.4.4.3 Setup Example for Fractional Mode

Suppose the following operating characteristics are desired for Fractional mode operation:

- $f_{REF} = 40$  MHz (reference input frequency)
- Step at RF = 5 MHz (RF channel spacing)
- $f_{RF} = 1,600,000,045$  Hz (RF frequency)

The VCO range is 2400 MHz to 4800 MHz. Therefore:

- LO\_DIV\_SEL = 2
- $f_{VCO} = LO\_DIV\_SEL \times 1,600,000,045$  Hz = 3,200,000,090 Hz

To keep the frequency of the prescaler below 3000 MHz:

- PLL\_DIV\_SEL = 2

Using a typical  $f_{PFD}$  of 20 MHz:

- RDIV = 20
- NINT = 80
- NFRAC = 75

$NINT \geq 75$ ; therefore, select the 8/9 prescaler.

$$f_{N,Max} = 3200 \text{ MHz} / (2 \times 8) = 200 \text{ MHz} < 375 \text{ MHz}$$

The actual frequency at RF is:

- $f_{RF} = 1600000044.9419$  Hz

For a frequency error of  $-0.058$  Hz.

### 7.4.5 Fractional Mode Setup

Optimal operation of the PLL in Fractional mode requires several additional register settings. Recommended values are listed in [Register Maps](#). Optimal performance may require tuning the MOD\_ORD, ISOURCE\_SINK, and ISOURCE\_TRIM values according to the chosen frequency band.

**Table 6. Fractional Mode Register Settings**

REGISTER BIT	REGISTER ADDRESSING	RECOMMENDED VALUE
EN_ISOURCE	Reg4B18	1
EN_DITH	Reg4B25	1
MOD_ORD	Reg4B[27..26]	B[27..26] = [10]
DITH_SEL	Reg4B28	0
DEL_SD_CLK	Reg4B[30..29]	B[30..29] = [10]
EN_FRAC	Reg4B31	1
EN_LD_ISOURCE	Reg5B31	0
ISOURCE_SINK	Reg6B19	0
ISOURCE_TRIM	Reg6B[22..20]	B[22..20] = [100] or [111]; see <a href="#">Typical Characteristics</a>
ICPDOUBLE	Reg1B26	0

## 7.5 Register Maps

### 7.5.1 PLL 4WI Registers

#### 7.5.1.1 Register 1

**Figure 68. PLL 4WI Register 1**

31	30	29	28	27	26	25	24	23	22	21	20	19	18	17	16
RSV	VCO CAL CLK DIV/MULT				CP DOUBLE	CHARGE PUMP CURRENT				VCO NEG	REF INV	RSV	REF CLOCK DIV		
15	14	13	12	11	10	9	8	7	6	5	4	3	2	1	0
REFERENCE CLOCK DIVIDER											REGISTER ADDRESS				

**Table 7. PLL 4WI Register 1**

Bit	Field	Reset Value	Description
Bit0	ADDR_0	1	Register address bits
Bit1	ADDR_1	0	
Bit2	ADDR_2	0	
Bit3	ADDR_3	1	
Bit4	ADDR_4	0	
Bit5	RDIV_0	1	13-bit Reference Divider value
Bit6	RDIV_1	0	
Bit7	RDIV_2	0	
Bit8	RDIV_3	0	
Bit9	RDIV_4	0	
Bit10	RDIV_5	0	
Bit11	RDIV_6	0	
Bit12	RDIV_7	0	
Bit13	RDIV_8	0	
Bit14	RDIV_9	0	
Bit15	RDIV_10	0	
Bit16	RDIV_11	0	
Bit17	RDIV_12	0	
Bit18	RSV	0	Reserved
Bit19	REF_INV	0	Invert Reference Clock polarity; 1 = use falling edge
Bit20	NEG_VCO	1	VCO polarity control; 1= negative slope (negative K <sub>v</sub> )
Bit21	ICP_0	0	Program Charge Pump dc current, ICP 1.94 mA, B[25..21] = [00 000] 0.65 mA, B[25..21] = [11 111] 0.97 mA, default value, B[25..21] = [01 010]
Bit22	ICP_1	1	
Bit23	ICP_2	0	
Bit24	ICP_3	1	
Bit25	ICP_4	0	
Bit26	ICPDOUBLE	0	1 = Set ICP to double the current
Bit27	CAL_CLK_SEL_0	0	Multiplication or division factor to create VCO calibration clock from PFD frequency Fastest clock, B[25..21] = [00 000] Slowest clock, B[25..21] = [11 111]
Bit28	CAL_CLK_SEL_1	0	
Bit29	CAL_CLK_SEL_2	0	
Bit30	CAL_CLK_SEL_3	1	
Bit31	RSV	0	Reserved

**7.5.1.1.1 CAL\_CLK\_SEL[3..0]**

Set the frequency divider value used to derive the VCO calibration clock from the phase detector frequency. [Table 8](#) shows the calibration clock scale factors.

**Table 8. Calibration Clock Scale Factors**

CAL_CLK_SEL	SCALING FACTOR
1111	1/128
1110	1/64
1101	1/32
1100	1/16
1011	1/8
1010	1/4
1001	1/2
1000	1
0110	2
0101	4
0100	8
0011	16
0010	32
0001	64
0000	128

**7.5.1.1.2 ICP[4..0]**

Set the charge pump current. [Table 9](#) lists the charge pump current settings.

**Table 9. Charge Pump Current Settings**

ICP[4..0]	CURRENT (mA)
00 000	1.94
00 001	1.76
00 010	1.62
00 011	1.49
00 100	1.38
00 101	1.29
00 110	1.21
00 111	1.14
01 000	1.08
01 001	1.02
01 010	0.97
01 011	0.92
01 100	0.88
01 101	0.84
01 110	0.81
01 111	0.78
10 000	0.75
10 001	0.72
10 010	0.69
10 011	0.67
10 100	0.65
10 101	0.63
10 110	0.61
10 111	0.59
11 000	0.57
11 001	0.55
11 010	0.54
11 011	0.52
11 100	0.51

**Table 9. Charge Pump Current Settings (continued)**

ICP[4..0]	CURRENT (mA)
11 101	0.5
11 110	0.48
11 111	0.47

**7.5.1.2 Register 2**
**Figure 69. PLL 4WI Register 2**

31	30	29	28	27	26	25	24	23	22	21	20	19	18	17	16
EN CAL	CAL ACCURACY		VCO SEL MODE	VCO SELECT		RSV	RSV	PRE-SCALER SELECT	PLL DIVIDER SETTING		N-DIVIDER VALUE				
15	14	13	12	11	10	9	8	7	6	5	4	3	2	1	0
N-DIVIDER VALUE											REGISTER ADDRESS				

**Table 10. PLL 4WI Register 2**

Bit	Field	Reset Value	Description
Bit0	ADDR_0	0	Register address bits
Bit1	ADDR_1	1	
Bit2	ADDR_2	0	
Bit3	ADDR_3	1	
Bit4	ADDR_4	0	
Bit5	NINT_0	0	PLL N-divider division setting
Bit6	NINT_1	0	
Bit7	NINT_2	0	
Bit8	NINT_3	0	
Bit9	NINT_4	0	
Bit10	NINT_5	0	
Bit11	NINT_6	0	
Bit12	NINT_7	1	
Bit13	NINT_8	0	
Bit14	NINT_9	0	
Bit15	NINT_10	0	
Bit16	NINT_11	0	
Bit17	NINT_12	0	
Bit18	NINT_13	0	
Bit19	NINT_14	0	
Bit20	NINT_15	0	
Bit21	PLL_DIV_SEL0	1	Select division ratio of divider in front of prescaler
Bit22	PLL_DIV_SEL1	0	
Bit23	PRSC_SEL	1	Set prescaler modulus (0 → 4/5; 1 → 8/9)
Bit24	RSV	0	Reserved
Bit25	RSV	0	Reserved
Bit26	VCO_SEL_0	0	Selects between the four integrated VCOs 00 = lowest frequency VCO; 11 = highest frequency VCO
Bit27	VCO_SEL_1	1	
Bit28	VCOSEL_MODE	0	Single VCO auto-calibration mode (1 = active)
Bit29	CAL_ACC_0	0	Error count during the cap array calibration Recommended programming [00].
Bit30	CAL_ACC_1	0	
Bit31	EN_CAL	0	Execute a VCO frequency auto-calibration. Set to 1 to initiate a calibration. Resets automatically.

**7.5.1.2.1 PLL\_DIV <1.0>**

Select division ratio of divider in front of prescaler, according to [Table 11](#).

**Table 11. PLL\_DIV Selection**

PLL_DIV	FREQUENCY DIVIDER
00	1
01	2
10	4

**7.5.1.2.2 VCOSEL\_MODE**

When VCOSEL\_MODE is set to 1, the cap array calibration is executed on the VCO selected through bits VCO\_SEL[1:0].

**7.5.1.3 Register 3**
**Figure 70. PLL 4WI Register 3**

31	30	29	28	27	26	25	24	23	22	21	20	19	18	17	16
RSV	RSV	FRACTIONAL N-DIVIDER VALUE													
15	14	13	12	11	10	9	8	7	6	5	4	3	2	1	0
FRACTIONAL N-DIVIDER VALUE											REGISTER ADDRESS				

**Table 12. PLL 4WI Register 3**

Bit	Field	Reset Value	Description
Bit0	ADDR_0	1	Register address bits
Bit1	ADDR_1	1	
Bit2	ADDR_2	0	
Bit3	ADDR_3	1	
Bit4	ADDR_4	0	
Bit5	NFRAC<0>	0	Fractional PLL N divider value 0 to 0.99999
Bit6	NFRAC<1>	0	
Bit7	NFRAC<2>	0	
Bit8	NFRAC<3>	0	
Bit9	NFRAC<4>	0	
Bit10	NFRAC<5>	0	
Bit11	NFRAC<6>	0	
Bit12	NFRAC<7>	0	
Bit13	NFRAC<8>	0	
Bit14	NFRAC<9>	0	
Bit15	NFRAC<10>	0	
Bit16	NFRAC<11>	0	
Bit17	NFRAC<12>	0	
Bit18	NFRAC<13>	0	
Bit19	NFRAC<14>	0	
Bit20	NFRAC<15>	0	
Bit21	NFRAC<16>	0	
Bit22	NFRAC<17>	0	
Bit23	NFRAC<18>	0	
Bit24	NFRAC<19>	0	
Bit25	NFRAC<20>	0	
Bit26	NFRAC<21>	0	
Bit27	NFRAC<22>	0	
Bit28	NFRAC<23>	0	
Bit29	NFRAC<24>	0	



**Table 12. PLL 4WI Register 3 (continued)**

Bit	Field	Reset Value	Description
Bit30	RSV	0	Reserved
Bit31	RSV	0	Reserved

**7.5.1.4 Register 4**
**Figure 71. PLL 4WI Register 4**

31	30	29	28	27	26	25	24	23	22	21	20	19	18	17	16	
EN FRAC T MODE	$\Delta\Sigma$ MOD CONTROLS			$\Delta\Sigma$ MOD ORDER			PLL TESTS CONTROL						EXT VCO			
15	14	13	12	11	10	9	8	7	6	5	4	3	2	1	0	
POWER-DOWN OUTPUT BUFFERS				POWER-DOWN PLL BLOCKS						PD PLL	REGISTER ADDRESS					

**Table 13. PLL 4WI Register 4**

Bit	Field	Reset Value	Description
Bit0	ADDR_0	0	Register address bits
Bit1	ADDR_1	0	
Bit2	ADDR_2	1	
Bit3	ADDR_3	1	
Bit4	ADDR_4	0	
Bit5	PWD_PLL	0	Power-down all PLL blocks (1 = off)
Bit6	PWD_CP	0	When 1, charge pump is off
Bit7	PWD_VCO	0	When 1, VCO is off
Bit8	PWD_VCOMUX	0	Power-down the four VCO mux blocks (1 = off)
Bit9	PWD_DIV124	0	Power-down programmable RF divider in PLL feedback path (1 = off)
Bit10	PWD_PRESC	0	Power-down programmable prescaler (1 = off)
Bit11	PWD_LO_DIV	1	Power-down LO divider block (1 = off)
Bit12	PWD_BUFF_1	1	Power-down LO output buffer 1 (1 = off)
Bit13	PWD_BUFF_2	1	Power-down LO output buffer 2 (1 = off)
Bit14	PWD_BUFF_3	1	Power-down LO output buffer 3 (1 = off)
Bit15	PWD_BUFF_4	1	Power-down LO output buffer 4 (1 = off)
Bit16	EN_EXTVCO	0	Enable external VCO input buffer (1 = enabled)
Bit17	EXT_VCO_CTRL	0	Can be used to enable/disable an external VCO through pin EXTVCO_CTRL (1 = high).
Bit18	EN_ISOURCE	0	Enable offset current at Charge Pump output (to be used in Fractional mode only; 1 = on).
Bit19	LD_ANA_PREC_0	0	Control precision of analog lock detector 1 = low; 0 = high
Bit20	LD_ANA_PREC_1	0	
Bit21	CP_TRISTATE_0	0	Set the charge pump output into 3-state mode. Normal, B[22..21] = [00] Down, B[22..21] = [01] Up, B[22..21] = [10] 3-state, B[22..21] = [11]
Bit22	CP_TRISTATE_1	0	
Bit23	SPEEDUP	0	Speed up PLL block by bypassing bias stabilizer capacitors.
Bit24	LD_DIG_PREC	0	Lock detector precision (increases sampling time if set to 1)
Bit25	EN_DITH	1	Enable $\Delta\Sigma$ modulator dither (1 = on)
Bit26	MOD_ORD_0	0	$\Delta\Sigma$ modulator order (1 through 4). Not used in Integer mode. First order, B[27..26] = [00] Second order, B[27..26] = [01] Third order, B[27..26] = [10] Fourth order, B[27..26] = [11]
Bit27	MOD_ORD_1	1	

**Table 13. PLL 4WI Register 4 (continued)**

Bit	Field	Reset Value	Description
Bit28	DITH_SEL	0	Select dither mode for $\Delta\Sigma$ modulator (0 = pseudo-random; 1 = constant)
Bit29	DEL_SD_CLK_0	0	$\Delta\Sigma$ modulator clock delay. Not used in Integer mode. Min delay = 00; Max delay = 11
Bit30	DEL_SD_CLK_1	1	
Bit31	EN_FRAC	0	Enable Fractional mode (1 = fractional enabled)

**7.5.1.5 Register 5**

**Figure 72. PLL 4WI Register 5**

31	30	29	28	27	26	25	24	23	22	21	20	19	18	17	16
EN_L D ISRC	RSV	VCO BIAS VOLTAGE	VCOMUX AMPL	VCO CAL REF			BIAS SEL	RSV	RSV	OUTBUF BIAS	VCOMUX BIAS				
15	14	13	12	11	10	9	8	7	6	5	4	3	2	1	0
VCOBUF BIAS		VCO CURRENT			PLL_R_TRIM	VCO_R_TRIM			REGISTER ADDRESS						

**Table 14. PLL 4WI Register 5**

Bit	Field	Reset Value	Description
Bit0	ADDR_0	1	Register address bits
Bit1	ADDR_1	0	
Bit2	ADDR_2	1	
Bit3	ADDR_3	1	
Bit4	ADDR_4	0	
Bit5	VCOBIAS_RTRIM_0	0	VCO bias resistor trimming. Recommended programming [100].
Bit6	VCOBIAS_RTRIM_1	0	
Bit7	VCOBIAS_RTRIM_2	1	
Bit8	PLLBIAS_RTRIM_0	0	PLL bias resistor trimming. Recommended programming [10].
Bit9	PLLBIAS_RTRIM_1	1	
Bit10	VCO_BIAS_0	0	VCO bias reference current. 300 $\mu$ A, B[13..10] = [00 00] 600 $\mu$ A, B[13..10] = [11 11] Bias current varies directly with reference current Recommended programming: 400 $\mu$ A, B[13..10] = [0101] with VCC_TK = 3.3 V 600 $\mu$ A, B[13..10] = [1111] with VCC_TK = 5.0V
Bit11	VCO_BIAS_1	0	
Bit12	VCO_BIAS_2	0	
Bit13	VCO_BIAS_3	1	
Bit14	VCOBUF_BIAS_0	0	VCO buffer bias reference current. 300 $\mu$ A, B[15..14] = [00] 600 $\mu$ A, B[15..14] = [11] Bias current varies directly with reference current Recommended programming [10]
Bit15	VCOBUF_BIAS_1	1	
Bit16	VCOMUX_BIAS_0	0	VCO muxing buffer bias reference current. 300 $\mu$ A, B[17..16] = [00] 600 $\mu$ A, B[17..16] = [11] Bias current varies directly with reference current Recommended programming [10]
Bit17	VCOMUX_BIAS_1	1	
Bit18	BUFOUT_BIAS_0	1	PLL output buffer bias reference current. 300 $\mu$ A, B[19..18] = [00] 600 $\mu$ A, B[19..18] = [11] Bias current varies directly with reference current
Bit19	BUFOUT_BIAS_1	0	
Bit20	RSV	0	Reserved
Bit21	RSV	1	Reserved
Bit22	VCO_CAL_IB	0	Select bias current type for VCO calibration circuitry 0 = PTAT; 1 = constant over temperature. Recommended programming [0].
Bit23	VCO_CAL_REF_0	0	VCO calibration reference voltage trimming. 0.9 V, B[25..23] = [000] 1.4 V, B[25..23] = [111] Recommended programming 1.11 V, B[25..23] = [011]
Bit24	VCO_CAL_REF_1	0	
Bit25	VCO_CAL_REF_2	1	

**Table 14. PLL 4WI Register 5 (continued)**

Bit	Field	Reset Value	Description
Bit26	VCO_AMPL_CTRL_0	0	Adjust the signal amplitude at the VCO mux input. [00] = maximum voltage swing [11] = minimum voltage swing Recommended programming [11]
Bit27	VCO_AMPL_CTRL_1	1	
Bit28	VCO_VB_CTRL_0	0	VCO core bias voltage control 1.2 V, B[29..28] = [00] 1.35 V, B[29..28] = [01] 1.5 V, B[29..28] = [10] 1.65 V, B[29..28] = [11] Recommended programming [01]
Bit29	VCO_VB_CTRL_1	1	
Bit30	RSV	0	Reserved
Bit31	EN_LD_ISOURCE	1	Enable monitoring of LD to turn on I <sub>SOURCE</sub> when in frac-n mode (EN_FRAC=1). 0 = I <sub>SOURCE</sub> set by EN_ISOURCE 1 = I <sub>SOURCE</sub> set by LD Recommended programming [0]

**7.5.1.6 Register 6**
**Figure 73. PLL 4WI Register 6**

31	30	29	28	27	26	25	24	23	22	21	20	19	18	17	16	
VCO BIAS SEL	DC OFF REF		VCO MUX BIAS		LO DIV BIAS		LO DIV		OFFSET CURRENT ADJUST		ISRC SINK		MUX CONTROL			
15	14	13	12	11	10	9	8	7	6	5	4	3	2	1	0	
CAL BYPASS	VCO TEST MODE	LD MODE	VCO CAP ARRAY CONTROL						RSV	RSV	REGISTER ADDRESS					

**Table 15. PLL 4WI Register 6**

Bit	Field	Reset Value	Description
Bit0	ADDR_0	0	Register address bits
Bit1	ADDR_1	1	
Bit2	ADDR_2	1	
Bit3	ADDR_3	1	
Bit4	ADDR_4	0	
Bit5	RSV	0	Reserved
Bit6	RSV	0	Reserved
Bit7	VCO_TRIM_0	0	VCO capacitor array control bits; used in manual cal mode
Bit8	VCO_TRIM_1	0	
Bit9	VCO_TRIM_2	0	
Bit10	VCO_TRIM_3	0	
Bit11	VCO_TRIM_4	0	
Bit12	VCO_TRIM_5	1	
Bit13	EN_LOCKDET	0	Initiate automatic calibration if LD indicates loss of lock. (1 = Initiate calibration if LD is low)
Bit14	VCO_TEST_MODE	0	Counter mode: measure maximum/minimum frequency of each VCO
Bit15	CAL_BYPASS	0	Bypass of VCO auto-calibration. When 1, VCO_TRIM and VCO_SEL bits are used to select the VCO and the capacitor array setting
Bit16	MUX_CTRL_0	1	Select signal for test output (pin 5, LD). [000] = Ground [001] = Lock detector [010] = NDIV counter output [011] = Ground [100] = RDIV counter output [101] = Ground [110] = A_counter output [111] = Logic high
Bit17	MUX_CTRL_1	0	
Bit18	MUX_CTRL_2	0	
Bit19	ISOURCE_SINK	0	Charge pump offset current polarity. 0 = source I <sub>SOURCE</sub> current enabled by EN_ISOURCE. Recommended programming [0].

**Table 15. PLL 4WI Register 6 (continued)**

Bit	Field	Reset Value	Description
Bit20	ISOURCE_TRIM_0	0	Adjust I <sub>SOURCE</sub> bias current. Minimum value, ISOURCE_TRIM = 0, B[22..20] = [000] Maximum value, ISOURCE_TRIM = 7, B[22..20] = [111] I <sub>SOURCE</sub> current enabled by EN_ISOURCE.
Bit21	ISOURCE_TRIM_1	0	
Bit22	ISOURCE_TRIM_2	1	
Bit23	LO_DIV_SEL_0	0	Adjust LO path divider Divide-by-1, [B24..23] = [00] Divide-by-2, [B24..23] = [01] Divide-by-4, [B24..23] = [10] Divide-by-8, [B24..23] = [11]
Bit24	LO_DIV_SEL_1	0	
Bit25	LO_DIV_IB_0	0	
Bit26	LO_DIV_IB_1	0	
Bit27	DIV_MUX_REF<0>	0	Sets reference bias current of DIV_MUX buffer when bit 31=1; [00] = 500 μA [01] = 400 μA [10] = 300 μA [11] = 200 μA Recommended programming [10]
Bit28	DIV_MUX_REF<1>	1	
Bit29	DIV_MUX_OUT<0>	0	Set multiply factor for DIV_MUX_REF current. x16, B[30..29] = 00 x24, B[30..29] = 01 x32, B[30..29] = 10 x40, B[30..29] = 11 Recommended programming [10]
Bit30	DIV_MUX_OUT<1>	1	
Bit31	DIV_MUX_BIAS_OVRD	0	Overrides DIV_MUX auto-bias current control. When set to 1, DIV_MUX bias current is set by [B30..27].

### 7.5.2 Readback from the Internal Register Banks

The TRF3765 integrates eight registers: Register 0 (000) to Register 7 (111). Registers 1 through 6 are used to set up and control the TRF3765 functions, Register 7 is used for factory functions, and Register 0 is used for the readback function, as shown in [Readback Mode](#).

Register 0 must be programmed with a specific command that sets the TRF3765 into readback mode and specifies the register to be read, according to the following parameters:

- Set B[31] to 1 to put TRF3765 into readback mode.
- Set B[30,28] equal to the address of the register to be read (000 to 111).
- Set B27 to control the VCO frequency counter in VCO test mode.

**7.5.2.1 Register 0 Write**
**Figure 74. Register 0 Write**

31	30	29	28	27	26	25	24	23	22	21	20	19	18	17	16
RB_ENABLE	RB_REG			COUNT_MODE MUX_SEL	N/C										
15	14	13	12	11	10	9	8	7	6	5	4	3	2	1	0
N/C											REGISTER ADDRESS				

**Table 16. Register 0 Write**

Type	Bit	Field	Reset Value	Description
Address	Bit0	ADDR<0>	0	Register 0 to be programmed to set the TRF3765 into readback mode.
	Bit1	ADDR<1>	0	
	Bit2	ADDR<2>	0	
	Bit3	ADDR<3>	1	
	Bit4	ADDR<4>	0	
Data Field	Bit5	N/C	0	
	Bit6	N/C	0	
	Bit7	N/C	0	
	Bit8	N/C	0	
	Bit9	N/C	0	
	Bit10	N/C	0	
	Bit11	N/C	0	
	Bit12	N/C	0	
	Bit13	N/C	0	
	Bit14	N/C	0	
	Bit15	N/C	0	
	Bit16	N/C	0	
	Bit17	N/C	0	
	Bit18	N/C	0	
	Bit19	N/C	0	
	Bit20	N/C	0	
	Bit21	N/C	0	
	Bit22	N/C	0	
	Bit23	N/C	0	
	Bit24	N/C	0	
	Bit25	N/C	0	
	Bit26	N/C	0	
	Bit27	COUNT_MODE_MUX_SEL	0	Select Readback for VCO maximum frequency or minimum frequency. 0 = Maximum 1 = Minimum
	Bit28	RB_REG<0>	X	Three LSBs of the address for the register that is being read Register 1, B[30..28] = [000] Register 7, B[30..28] = [111]
Bit29	RB_REG<1>	X		
Bit30	RB_REG<2>	X		
Bit31	RB_ENABLE	1	1 → Put the device into readback mode	

7.5.2.1.1 Register 0 Read

Figure 75. Register 0 Read

31	30	29	28	27	26	25	24	23	22	21	20	19	18	17	16	
COUNT MODE MUX_ SEL	COUNT11-17						COUNT9- 10/VCO_SEL	COUN T8/ NU	COUNT0-7/VCO_TRIM							
15	14	13	12	11	10	9	8	7	6	5	4	3	2	1	0	
COUNT0-7/VCO_TRIM			R_SA T_ER R	NOT USED						CHIP_ ID	REGISTER ADDRESS					

Figure 76. PLL 4WI Register 6

Table 17. Register 0 Read

Bit	Field	Reset Value	Description
Bit0	ADDR_0	0	Register address bits
Bit1	ADDR_1	0	
Bit2	ADDR_2	0	
Bit3	ADDR_3	1	
Bit4	ADDR_4	0	
Bit5	CHIP_ID	1	
Bit6	NU	x	
Bit7	NU	x	
Bit8	NU	x	
Bit9	NU	x	
Bit10	NU	x	
Bit11	NU	x	
Bit12	R_SAT_ERR	x	Error flag for calibration speed
Bit13	count_0/NU	x	B[30..13] = VCO frequency counter high when COUNT_MODE_MUX_SEL = 0 and VCO_TEST_MODE = 1 B[30..13] = VCO frequency counter low when COUNT_MODE_MUX_SEL = 1 and VCO_TEST_MODE = 1 B[20..15] = Autocal results for VCO_TRIM B[23..22] = Autocal results for VCO_SEL when VCO_TEST_MODE = 0
Bit14	count_1/NU	x	
Bit15	count_2/VCO_TRIM_0	x	
Bit16	count_3/VCO_TRIM_1	x	
Bit17	count_4/VCO_TRIM_2	x	
Bit18	count_5/VCO_TRIM_3	x	
Bit19	count_6/VCO_TRIM_4	x	
Bit20	count_7/VCO_TRIM_5	x	
Bit21	count_8/NU	x	
Bit22	count_9/VCO_sel_0	x	
Bit23	count_10/VCO_sel_1	x	
Bit24	count<11>	x	
Bit25	count<12>	x	
Bit26	count<13>	x	
Bit27	count<14>	x	
Bit28	count<15>	x	
Bit29	count<16>	x	
Bit30	count<17>	x	
Bit31	COUNT_MODE_MUX_SEL	x	0 = Minimum frequency 1 = Maximum frequency

## 8 Application and Implementation

---

### NOTE

Information in the following applications sections is not part of the TI component specification, and TI does not warrant its accuracy or completeness. TI's customers are responsible for determining suitability of components for their purposes. Customers should validate and test their design implementation to confirm system functionality.

---

### 8.1 Application Information

The TRF3765 is a wideband integer-N/Fractional-N frequency synthesizer with an integrated, wideband voltage-controlled oscillator (VCO). Programmable output dividers enable continuous frequency coverage from 300 MHz to 4.8GHz. Four separate differential, open-collector RF outputs allow multiple devices to be driven in parallel without the need of external splitters. TRF3765 is applicable to the wireless infrastructure standards such as CDMA, TDMA, WCDMA, LTE and Advanced-LTE. It can also be used in wireless point-to-point access and wireless local loop communication links.

### 8.2 Typical Application

[Figure 77](#) shows an example block diagram for multi-band and multi-mode for 2G, 3G, and 4G cellular transmitters. By adopting DAC38J84 and TRF3720, number of transmitter can be increased up to 8 antenna system as each of DAC38J84 can supports 2 transmitters of I/Q pair and each of TRF3765 can provide 4 high sampling clocks with 4 DAC38J84 devices. TRF3720 is an IQ modulator with fully integrated PLL/VCO and LO frequency ranges from 300 MHz to 4.8 GHz.

This is a good example of improved transmitter diversity to service multiple users simultaneously. The internal PLL of TRF3765 can be used to generate four high sampling clocks up to 4.8 GHz.

Typical Application (continued)

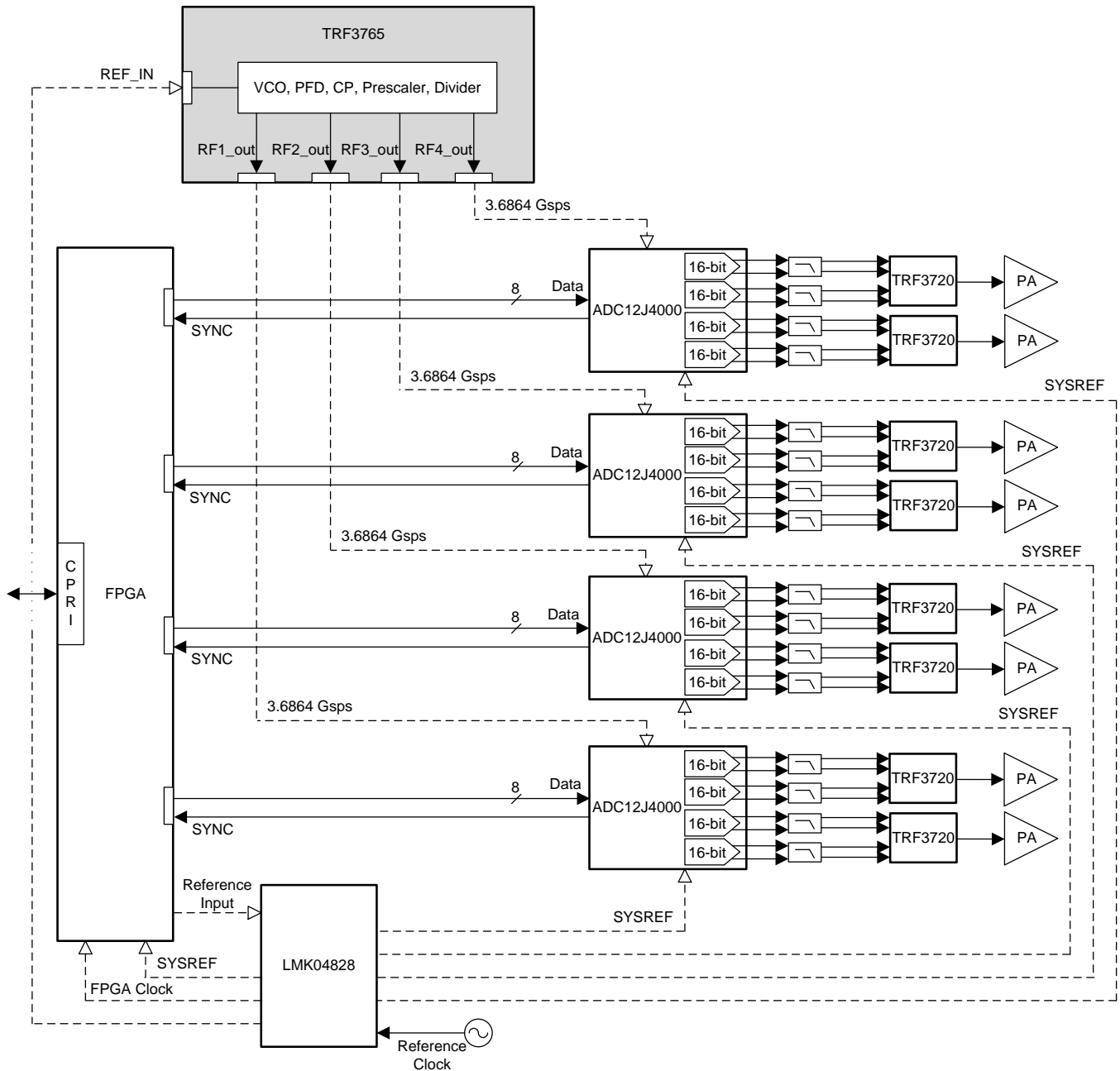

Figure 77. TRF3765 Application Block Diagram



## Typical Application (continued)

### 8.2.1 Design Requirements

For this design example, use the input parameters in [Table 18](#).

**Table 18. Design Parameters**

DESIGN PARAMETER	EXAMPLE VALUE
Input voltage	3.3 V
Current	121 mA
Input reference frequency	122.88 MHz
Output frequency	900 MHz

**Table 19. Termination Requirements and Interfacing**

PIN	NAME	DESCRIPTION
3	DATA	4WI data input: digital input, high impedance
4	CLOCK	4WI clock input: digital input, high impedance
5	STROBE	4WI latch enable: digital input, high impedance
6	READBACK	Readback output; digital output pins can source or sink up to 8 mA of current
9 through 16	LO_OUT	Local oscillator output: open-collector output. A pullup resistor is required, normally ac-coupled. Any unused output differential pairs may be left open.
18	EXTVCO_IN	External local oscillator input: high impedance, normally ac-coupled
19	EXTVCO_CTRL	Power-down control pin for optional external VCO; digital output pins can source or sink up to 8 mA of current
30	REF_IN	Reference clock input: high impedance, normally ac-coupled
32	LD	Lock detector digital output, as configured by MUX_CTRL; digital output pins can source or sink up to 8 mA of current

### 8.2.2 Detailed Design Procedures

#### 8.2.2.1 Power Supply

A clean power supply is critical to optimal phase noise performance of synthesizer. Linear power supplies are the best sources available. Switching power supplies degrade in-band phase noise by 10 dB compared to linear laboratory supplies. VCC3 can be used to drive VCC\_TK, a 3.3-V or 5-V tolerant supply on the TRF3765. VCC\_TK is normally driven by the 3.3 V VCC2 supply, but some applications perform better with 5 V supply on VCC\_TK. A power supply filter can be used for TRF3765 and this filter reduces in-band frequency noise from a switching power supply so that external supply can drive 5 V on VCC\_TK.

#### 8.2.2.2 Loop Filter

Loop-filter components are also critical to optimal phase noise performance. The loop filter must be matched to the selected phase noise frequency detector (PFD) frequency. To use different PFD frequency, the loop-filter components must be updated. Below is an example of loop filter design.

#### 8.2.2.3 Reference Clock

External oscillator or the output of PLL device can be installed for the reference clock input to TRF3765 device. The external reference clock is AC-coupled to the TRF3765 input pin. The range is reference frequency is from 0.5 MHz to 350 MHz. The minimum of reference input sensitivity is 0.2 Vpp and 3.3 Vpp for the maximum value.

### 8.2.3 Application Curves

The phase noise performance of 900-MHz output is shown in [Figure 78](#). [Figure 79](#) shows phase noise performances from different power supplies such as 3.3 V, 2.7 V, 2.5 V, 2.2 V, 2.1 V and 2 V at room temperature.

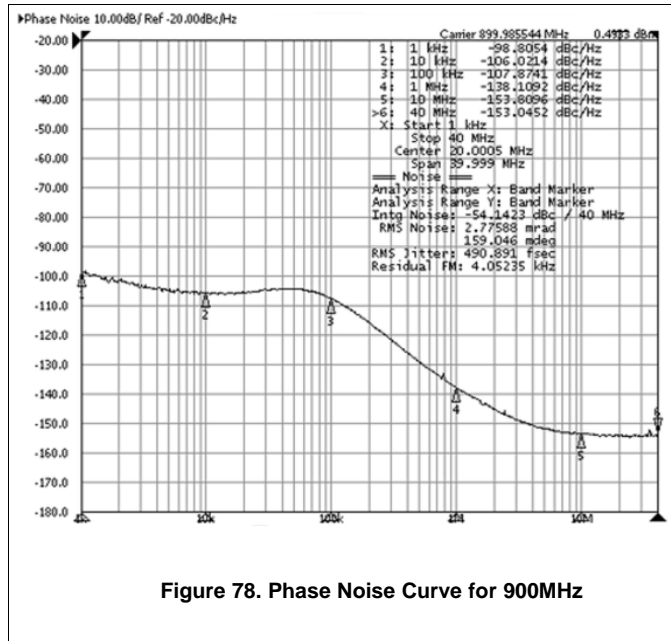

Figure 78. Phase Noise Curve for 900MHz

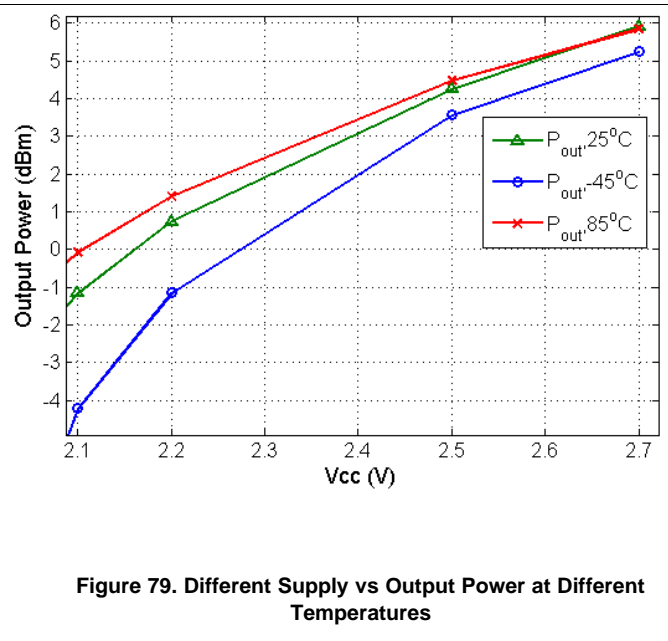

Figure 79. Different Supply vs Output Power at Different Temperatures

## 9 Power Supply Recommendations

Power-supply distribution for the TRF3765 is shown in Table 20. Proper isolation and filtering of the supplies are critical for low phase noise operation of the device. Each supply pin should be supplied with local decoupling capacitance and isolated with a ferrite bead.

Table 20. Power-Supply Distribution

PINS	SUPPLY	BLOCKS
2	VCC_DIG	Fractional divider
		N-Divider
7	VCC_DIV	LO_OUT buffers
		LO 1/2/4/8 divider
20	VCC_TK	VCO tank
21	VCC_OSC	VCO bias
27	VCC_CP	Charge pump
28	VCC_PLL	4WI
		LD
		Prescaler
		REF_IN buffer
		ISource
		RF-Divider
		R-Divider

## 10 Layout

### 10.1 Layout Guidelines

Layout of the application board significantly impacts the analog performance of the TRF3765 device. Noise and high-speed signals should be prevented from leaking onto power-supply pins or analog signals. Follow these recommendations:

- Place supply decoupling capacitors physically close to the device, on the same side of the board. Each supply pin should be isolated with a ferrite bead.
- Maintain a continuous ground plane in the vicinity of the device and as return paths for all high-speed signal lines. Place reference plane vias or decoupling capacitors near any signal line reference transition.
- The pad on the bottom of the device must be electrically grounded. Connect GND pins directly to the pad on the surface layer. Connect the GND pins and pad directly to surface ground where possible.
- Power planes should not overlap each other or high-speed signal lines.
- Isolate REF\_IN routing from loop filter lines, control lines, and other high-speed lines.

See [Figure 80](#) for an example of critical component layout (for the top PCB layer).

### 10.2 Layout Example

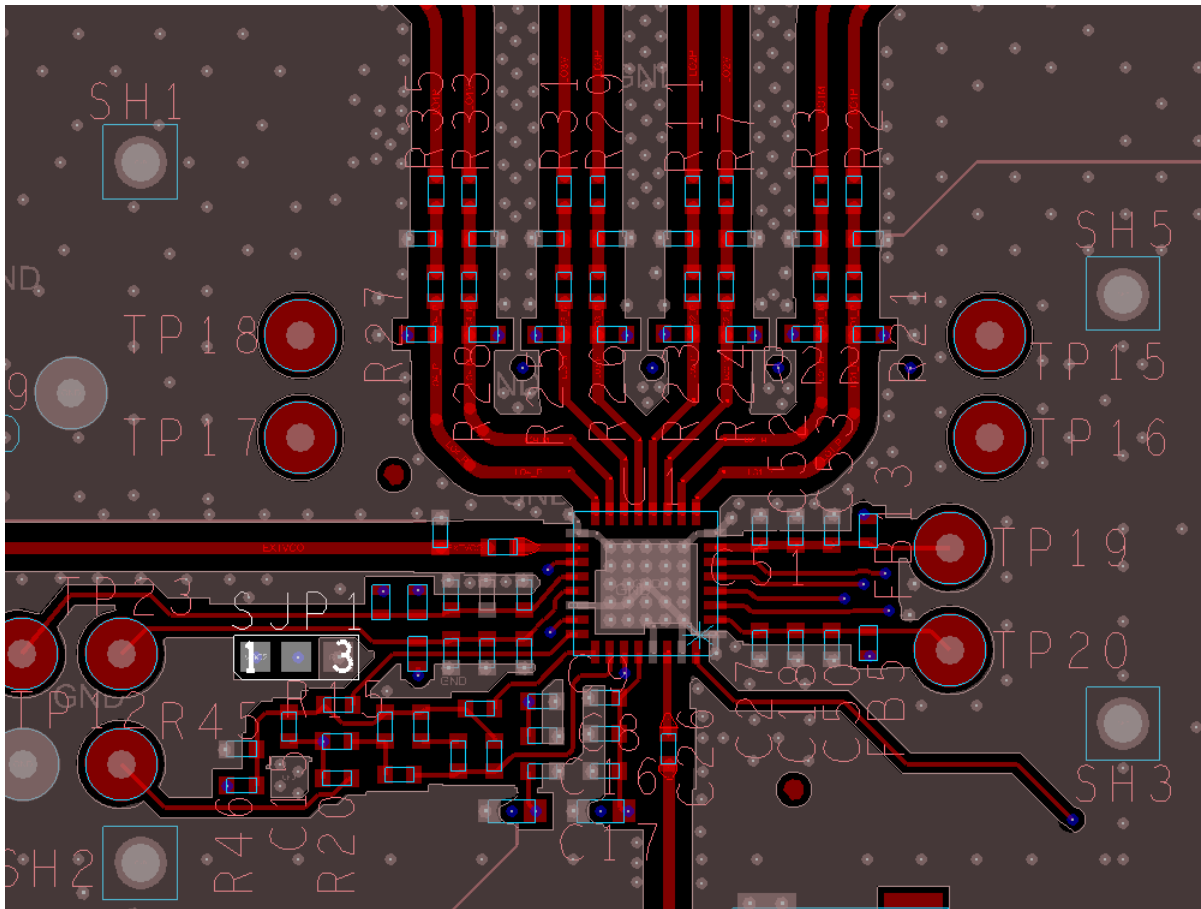

Figure 80. Layout of Critical TRF3765 Components

## 11 Device and Documentation Support

### 11.1 Community Resources

The following links connect to TI community resources. Linked contents are provided "AS IS" by the respective contributors. They do not constitute TI specifications and do not necessarily reflect TI's views; see TI's [Terms of Use](#).

**TI E2E™ Online Community** *TI's Engineer-to-Engineer (E2E) Community*. Created to foster collaboration among engineers. At [e2e.ti.com](http://e2e.ti.com), you can ask questions, share knowledge, explore ideas and help solve problems with fellow engineers.

**Design Support** *TI's Design Support* Quickly find helpful E2E forums along with design support tools and contact information for technical support.

### 11.2 Trademarks

E2E is a trademark of Texas Instruments.  
All other trademarks are the property of their respective owners.

### 11.3 Electrostatic Discharge Caution



These devices have limited built-in ESD protection. The leads should be shorted together or the device placed in conductive foam during storage or handling to prevent electrostatic damage to the MOS gates.

### 11.4 Glossary

[SLYZ022](#) — *TI Glossary*.

This glossary lists and explains terms, acronyms, and definitions.

## 12 Mechanical, Packaging, and Orderable Information

The following pages include mechanical, packaging, and orderable information. This information is the most current data available for the designated devices. This data is subject to change without notice and revision of this document. For browser-based versions of this data sheet, refer to the left-hand navigation.

**PACKAGING INFORMATION**

Orderable part number	Status (1)	Material type (2)	Package   Pins	Package qty   Carrier	RoHS (3)	Lead finish/ Ball material (4)	MSL rating/ Peak reflow (5)	Op temp (°C)	Part marking (6)
TRF3765IRHBR	Active	Production	VQFN (RHB)   32	3000   LARGE T&R	Yes	NIPDAU	Level-2-260C-1 YEAR	-40 to 85	TRF3765 IRHB
TRF3765IRHBT	Active	Production	VQFN (RHB)   32	250   SMALL T&R	Yes	NIPDAU	Level-2-260C-1 YEAR	-40 to 85	TRF3765 IRHB

(1) **Status:** For more details on status, see our [product life cycle](#).

(2) **Material type:** When designated, preproduction parts are prototypes/experimental devices, and are not yet approved or released for full production. Testing and final process, including without limitation quality assurance, reliability performance testing, and/or process qualification, may not yet be complete, and this item is subject to further changes or possible discontinuation. If available for ordering, purchases will be subject to an additional waiver at checkout, and are intended for early internal evaluation purposes only. These items are sold without warranties of any kind.

(3) **RoHS values:** Yes, No, RoHS Exempt. See the [TI RoHS Statement](#) for additional information and value definition.

(4) **Lead finish/Ball material:** Parts may have multiple material finish options. Finish options are separated by a vertical ruled line. Lead finish/Ball material values may wrap to two lines if the finish value exceeds the maximum column width.

(5) **MSL rating/Peak reflow:** The moisture sensitivity level ratings and peak solder (reflow) temperatures. In the event that a part has multiple moisture sensitivity ratings, only the lowest level per JEDEC standards is shown. Refer to the shipping label for the actual reflow temperature that will be used to mount the part to the printed circuit board.

(6) **Part marking:** There may be an additional marking, which relates to the logo, the lot trace code information, or the environmental category of the part.

Multiple part markings will be inside parentheses. Only one part marking contained in parentheses and separated by a "-" will appear on a part. If a line is indented then it is a continuation of the previous line and the two combined represent the entire part marking for that device.

**Important Information and Disclaimer:**The information provided on this page represents TI's knowledge and belief as of the date that it is provided. TI bases its knowledge and belief on information provided by third parties, and makes no representation or warranty as to the accuracy of such information. Efforts are underway to better integrate information from third parties. TI has taken and continues to take reasonable steps to provide representative and accurate information but may not have conducted destructive testing or chemical analysis on incoming materials and chemicals. TI and TI suppliers consider certain information to be proprietary, and thus CAS numbers and other limited information may not be available for release.

In no event shall TI's liability arising out of such information exceed the total purchase price of the TI part(s) at issue in this document sold by TI to Customer on an annual basis.

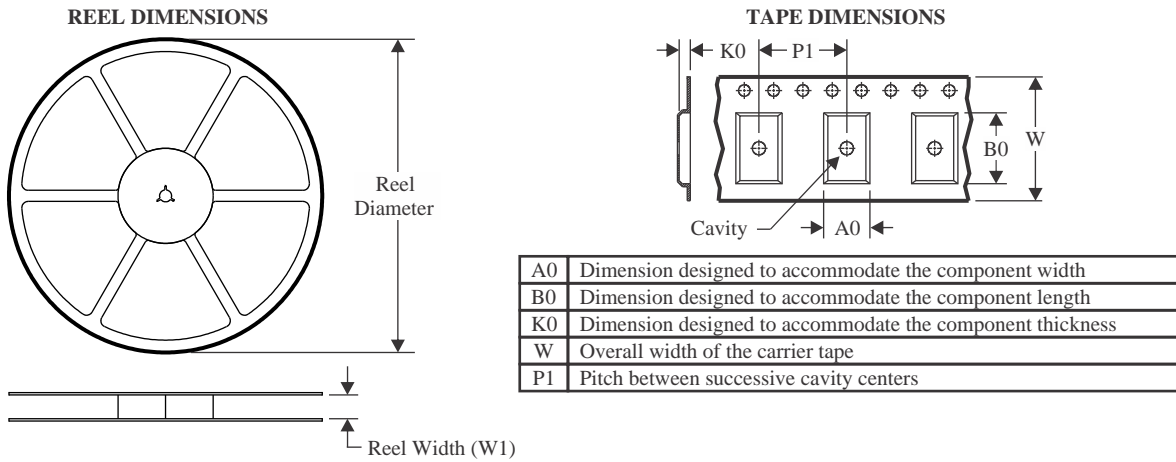
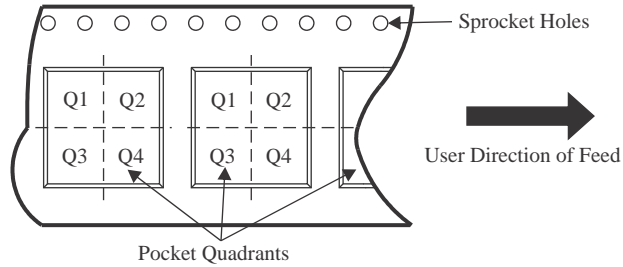
**TAPE AND REEL INFORMATION**

**QUADRANT ASSIGNMENTS FOR PIN 1 ORIENTATION IN TAPE**

\*All dimensions are nominal

Device	Package Type	Package Drawing	Pins	SPQ	Reel Diameter (mm)	Reel Width W1 (mm)	A0 (mm)	B0 (mm)	K0 (mm)	P1 (mm)	W (mm)	Pin1 Quadrant
TRF3765IRHBR	VQFN	RHB	32	3000	330.0	12.4	5.3	5.3	1.5	8.0	12.0	Q2

**TAPE AND REEL BOX DIMENSIONS**

\*All dimensions are nominal

Device	Package Type	Package Drawing	Pins	SPQ	Length (mm)	Width (mm)	Height (mm)
TRF3765IRHBR	VQFN	RHB	32	3000	350.0	350.0	43.0

## GENERIC PACKAGE VIEW

**RHB 32**

**VQFN - 1 mm max height**

5 x 5, 0.5 mm pitch

PLASTIC QUAD FLATPACK - NO LEAD

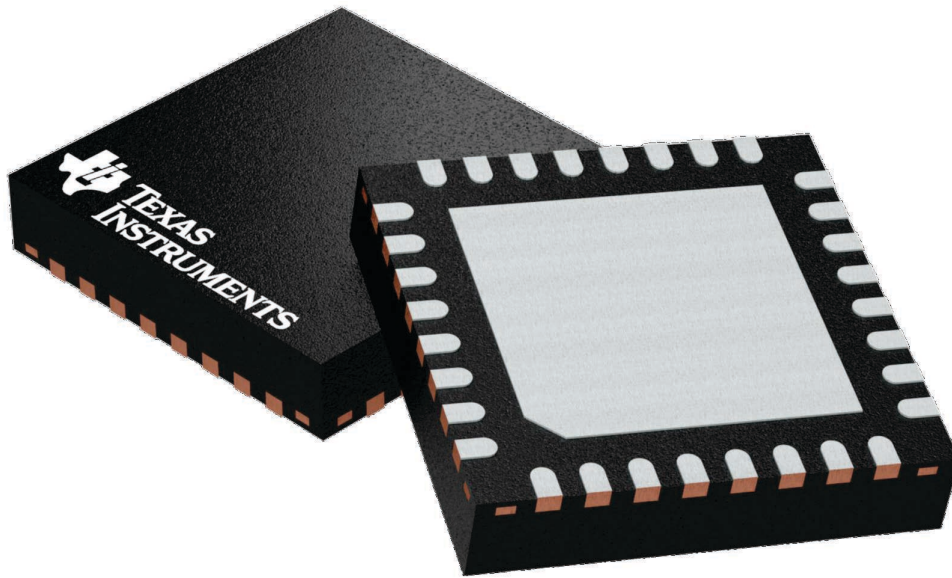

Images above are just a representation of the package family, actual package may vary.  
Refer to the product data sheet for package details.

4224745/A



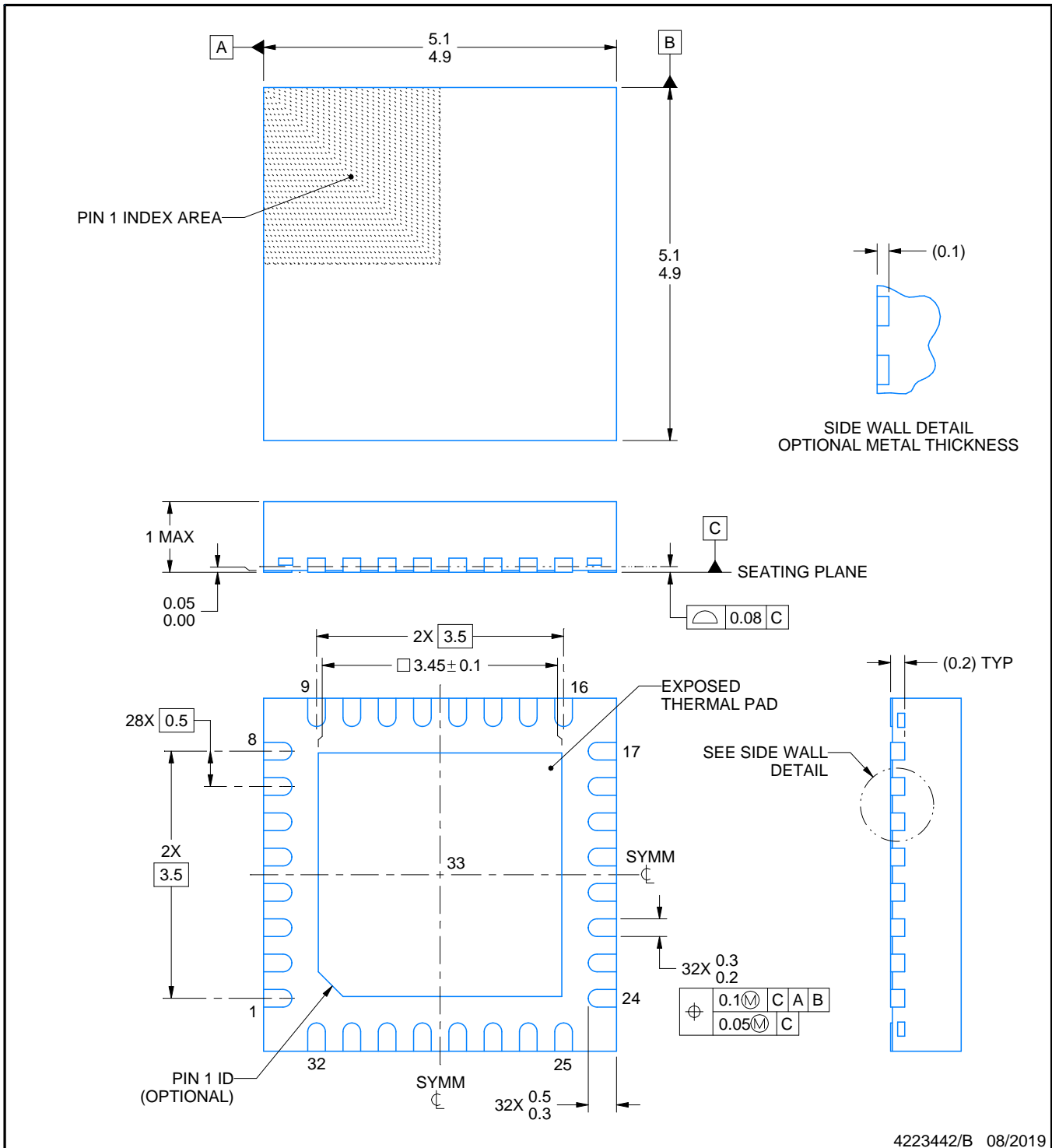
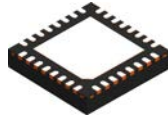

4223442/B 08/2019

NOTES:

1. All linear dimensions are in millimeters. Any dimensions in parenthesis are for reference only. Dimensioning and tolerancing per ASME Y14.5M.
2. This drawing is subject to change without notice.
3. The package thermal pad must be soldered to the printed circuit board for thermal and mechanical performance.

# EXAMPLE BOARD LAYOUT

RHB0032E

VQFN - 1 mm max height

PLASTIC QUAD FLATPACK - NO LEAD



LAND PATTERN EXAMPLE  
SCALE:18X



SOLDER MASK DETAILS

4223442/B 08/2019

NOTES: (continued)

- This package is designed to be soldered to a thermal pad on the board. For more information, see Texas Instruments literature number SLUA271 ([www.ti.com/lit/slua271](http://www.ti.com/lit/slua271)).
- Vias are optional depending on application, refer to device data sheet. If any vias are implemented, refer to their locations shown on this view. It is recommended that vias under paste be filled, plugged or tented.

# EXAMPLE STENCIL DESIGN

RHB0032E

VQFN - 1 mm max height

PLASTIC QUAD FLATPACK - NO LEAD

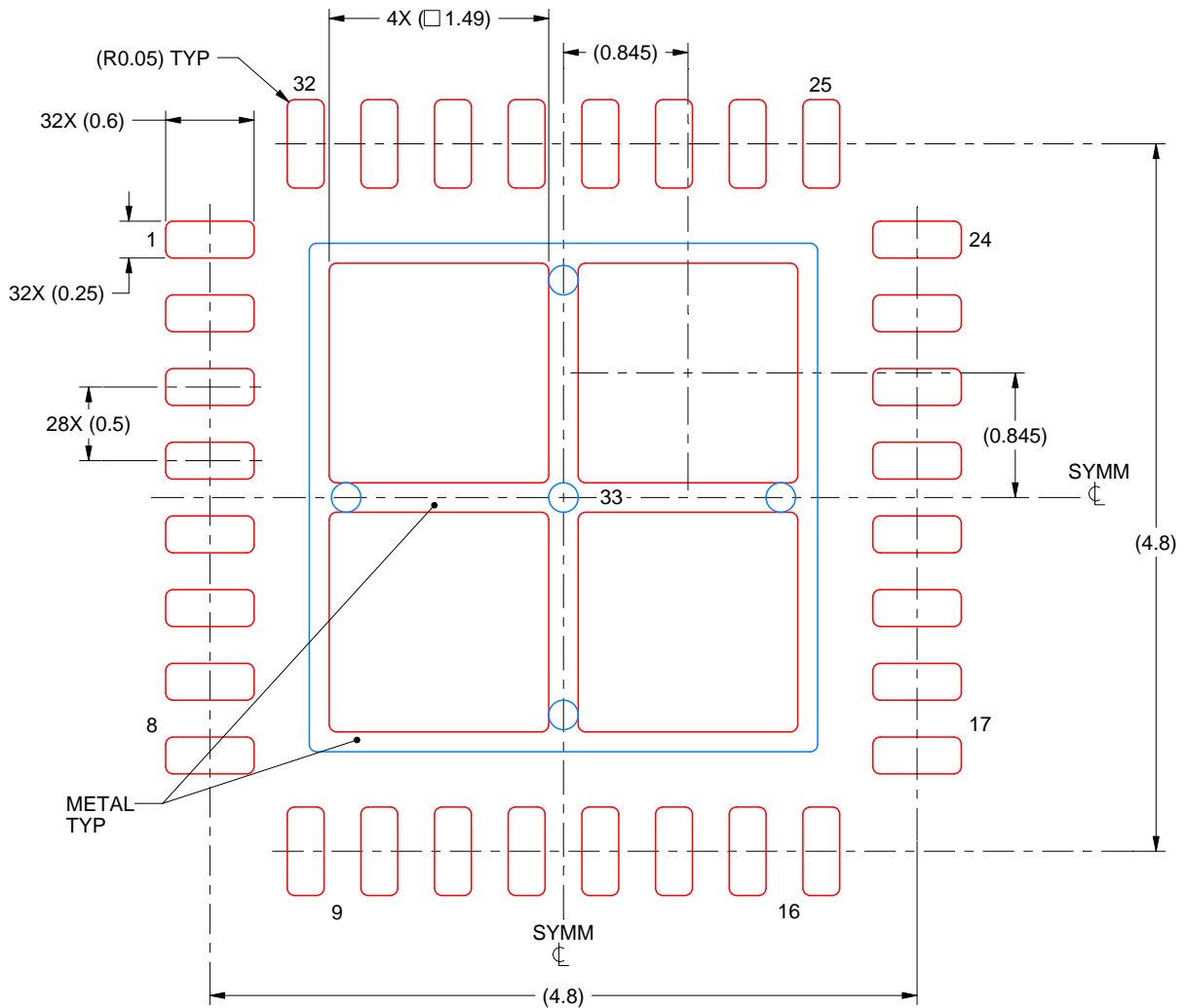

**SOLDER PASTE EXAMPLE**  
 BASED ON 0.125 mm THICK STENCIL

EXPOSED PAD 33:  
 75% PRINTED SOLDER COVERAGE BY AREA UNDER PACKAGE  
 SCALE:20X

4223442/B 08/2019

NOTES: (continued)

6. Laser cutting apertures with trapezoidal walls and rounded corners may offer better paste release. IPC-7525 may have alternate design recommendations.

## IMPORTANT NOTICE AND DISCLAIMER

TI PROVIDES TECHNICAL AND RELIABILITY DATA (INCLUDING DATA SHEETS), DESIGN RESOURCES (INCLUDING REFERENCE DESIGNS), APPLICATION OR OTHER DESIGN ADVICE, WEB TOOLS, SAFETY INFORMATION, AND OTHER RESOURCES "AS IS" AND WITH ALL FAULTS, AND DISCLAIMS ALL WARRANTIES, EXPRESS AND IMPLIED, INCLUDING WITHOUT LIMITATION ANY IMPLIED WARRANTIES OF MERCHANTABILITY, FITNESS FOR A PARTICULAR PURPOSE OR NON-INFRINGEMENT OF THIRD PARTY INTELLECTUAL PROPERTY RIGHTS.

These resources are intended for skilled developers designing with TI products. You are solely responsible for (1) selecting the appropriate TI products for your application, (2) designing, validating and testing your application, and (3) ensuring your application meets applicable standards, and any other safety, security, regulatory or other requirements.

These resources are subject to change without notice. TI grants you permission to use these resources only for development of an application that uses the TI products described in the resource. Other reproduction and display of these resources is prohibited. No license is granted to any other TI intellectual property right or to any third party intellectual property right. TI disclaims responsibility for, and you will fully indemnify TI and its representatives against, any claims, damages, costs, losses, and liabilities arising out of your use of these resources.

TI's products are provided subject to [TI's Terms of Sale](#) or other applicable terms available either on [ti.com](#) or provided in conjunction with such TI products. TI's provision of these resources does not expand or otherwise alter TI's applicable warranties or warranty disclaimers for TI products.

TI objects to and rejects any additional or different terms you may have proposed.

Mailing Address: Texas Instruments, Post Office Box 655303, Dallas, Texas 75265

Copyright © 2025, Texas Instruments Incorporated