

# BQ25883 2 セル、2A 昇圧モード・バッテリー充電器、電力パス、USB OTG (On-The-Go) 昇圧、USB 入力用

## 1 特長

- 高効率の 2A、1.5MHz スイッチ・モード昇圧型充電器
  - アダプタ 5V、バッテリー 7.6V、充電 1A で 93.4% の充電効率
  - USB 入力および 2 セルのリチウムイオン・バッテリー用に最適化
  - 軽負荷動作向けに、低消費電力の PFM モードを選択可能
- 単一入力で、USB 入力アダプタに対応
  - 3.9V~6.2V の入力電圧範囲に対応、入力電圧の絶対最大定格 20V
  - USB2.0、USB3.0 規格のアダプタに対応する入力電流制限 (100mA 分解能で 500mA~3.3A)
  - 最高 5.5V の入力電圧制限による最大電力トラッキング
  - 内蔵 USB D+/D- により USB SDP、CDP、DCP、非標準アダプタを自動検出
- 電力パス管理と I<sup>2</sup>C 制御機能を搭載
  - 17mΩ のバッテリー放電 MOSFET による最高水準のバッテリー放電効率
  - ナロー VDC (NVDC) 電力パス管理
    - バッテリー未接続または深放電状態でもシステムを即時オン
    - バッテリー補助モードで理想ダイオード動作
- USB OTG (On-The-Go) 対応、4.5V~5.5V の可変出力
  - 最大 2A を出力可能な降圧コンバータ
  - 5V、1A 出力で 94% の効率
  - 正確な定電流 (CC) レギュレーションと出力短絡保護
  - 軽負荷動作の低消費電力の PFM モードを選択可能、Out-of-Audio オプション搭載
- 入力電流オプティマイザ (ICO) により、アダプタの過負荷を引き起こさずに入力電力を最大化
- 内蔵の 16 ビット ADC によりシステムを監視 (BUS 電圧および電流、各セルの電圧、充電電流、SYS 電圧、NTC およびダイ温度)
- すべての MOSFET、電流センシング、ループ補償を含む高度な統合

## ● 高精度

- ±0.5% の充電電圧レギュレーション
- ±5% の充電電流レギュレーション
- ±7.5% の入力電流レギュレーション

## ● 安全性

- 充電および OTG 降圧モードでのバッテリー温度センシング
- サーマル・レギュレーションおよびサーマル・シャットダウン

## 2 アプリケーション

- Bluetooth スピーカ
- EPOS プリンタ
- ポータブル POS
- ワイヤレス・セキュリティ・カメラ

## 3 概要

BQ25883 は、2 セルのリチウムイオンおよびリチウムポリマ・バッテリー用の、高度に統合された 2A 昇圧スイッチ・モードのバッテリー充電管理およびシステム電力パス管理デバイスです。BQ25883 は I<sup>2</sup>C 制御、OTG、電力パスが搭載されています。

### 製品情報<sup>(1)</sup>

型番	パッケージ	本体サイズ(公称)
BQ25883	VQFN (24)	4.00mm×4.00mm

(1) 利用可能なすべてのパッケージについては、このデータシートの末尾にある注文情報を参照してください。

### 概略回路図

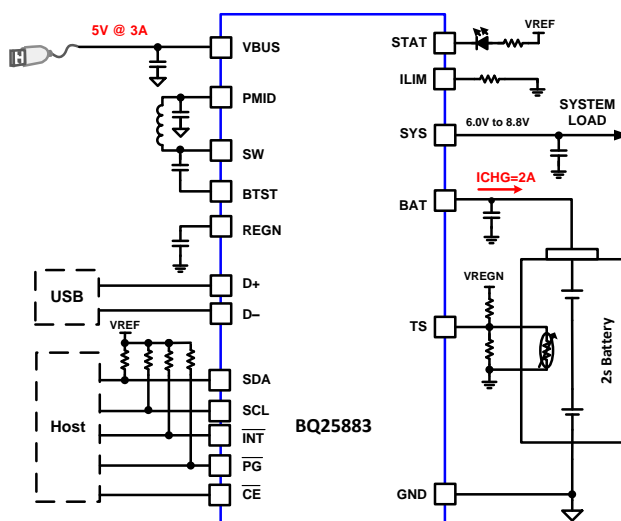

## 目次

<b>1</b>	<b>特長</b> .....	<b>1</b>	8.4	Device Functional Modes .....	<b>34</b>
<b>2</b>	<b>アプリケーション</b> .....	<b>1</b>	8.5	Register Maps .....	<b>35</b>
<b>3</b>	<b>概要</b> .....	<b>1</b>	<b>9</b>	<b>Application and Implementation</b> .....	<b>68</b>
<b>4</b>	<b>改訂履歴</b> .....	<b>2</b>	9.1	Application Information .....	<b>68</b>
<b>5</b>	<b>Device Comparison Table</b> .....	<b>3</b>	9.2	Typical Application .....	<b>68</b>
<b>6</b>	<b>Pin Configuration and Functions</b> .....	<b>4</b>	<b>10</b>	<b>Power Supply Recommendations</b> .....	<b>74</b>
<b>7</b>	<b>Specifications</b> .....	<b>6</b>	<b>11</b>	<b>Layout</b> .....	<b>74</b>
7.1	Absolute Maximum Ratings .....	<b>6</b>	11.1	Layout Guidelines .....	<b>74</b>
7.2	ESD Ratings .....	<b>6</b>	11.2	Layout Example .....	<b>75</b>
7.3	Recommended Operating Conditions .....	<b>6</b>	<b>12</b>	<b>デバイスおよびドキュメントのサポート</b> .....	<b>76</b>
7.4	Thermal Information .....	<b>6</b>	12.1	デバイス・サポート .....	<b>76</b>
7.5	Electrical Characteristics .....	<b>7</b>	12.2	ドキュメントのサポート .....	<b>76</b>
7.6	Timing Requirements .....	<b>11</b>	12.3	ドキュメントの更新通知を受け取る方法 .....	<b>76</b>
7.7	Typical Characteristics .....	<b>13</b>	12.4	コミュニティ・リソース .....	<b>76</b>
<b>8</b>	<b>Detailed Description</b> .....	<b>16</b>	12.5	商標 .....	<b>76</b>
8.1	Overview .....	<b>16</b>	12.6	静電気放電に関する注意事項 .....	<b>76</b>
8.2	Functional Block Diagram .....	<b>16</b>	12.7	Glossary .....	<b>76</b>
8.3	Feature Description .....	<b>17</b>	<b>13</b>	<b>メカニカル、パッケージ、および注文情報</b> .....	<b>77</b>

## 4 改訂履歴

2019年2月発行のものから更新

**Page**

• 「事前情報」から「量産データ」に変更 .....	<b>1</b>
----------------------------	----------

## 5 Device Comparison Table

**Table 1. Device Comparison**

<b>PART NUMBER</b>	<b>BQ25882</b>	<b>BQ25883</b>	<b>BQ25886</b>	<b>BQ25887</b>
VBUS Operating Range	3.9 to 6.2 V	3.9 to 6.2 V	4.3 to 6.2 V	3.9 to 6.2 V
USB Detection	D+/D-	D+/D-	D+/D-	PSEL
Power Path	Yes	Yes	Yes	No
Cell Balancing	No	No	No	Yes
OTG	Up to 2 A	Up to 2 A	Up to 2 A	No OTG
16 bit ADC	Yes	Yes	No	Yes
Control Interface	I2C	I2C	Standalone	I2C
Status Pin	/PG	STAT, /PG	STAT, /PG	STAT, /PG
Package	2.1x2.1 WCSP-25	4x4 QFN-24	4x4 QFN-24	4x4 QFN-24

## 6 Pin Configuration and Functions

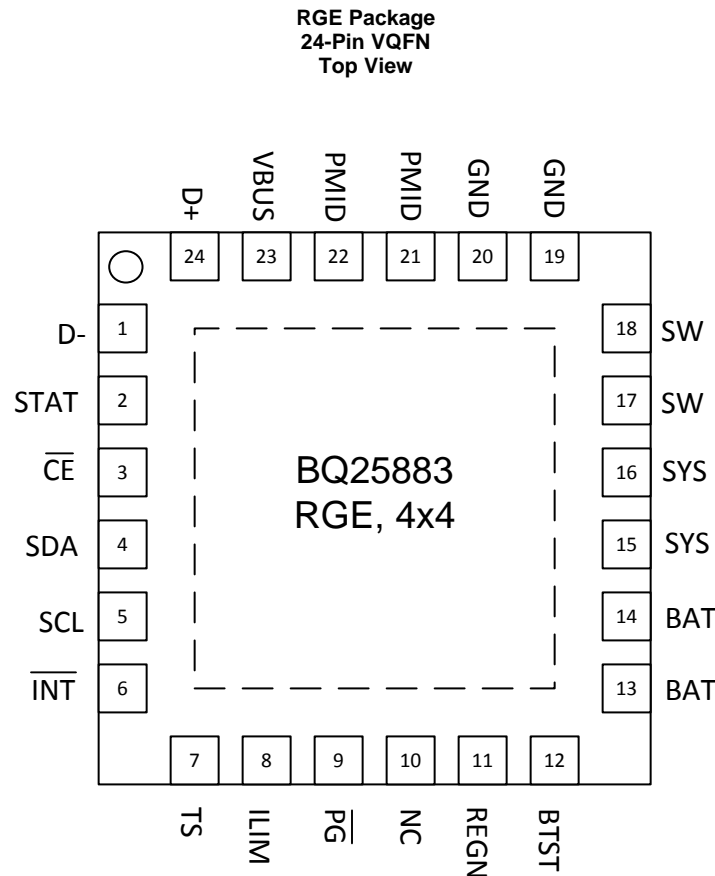

### Pin Functions

PIN		I/O	DESCRIPTION
NAME	NO.		
D+	24	AIO	<b>Positive USB data line</b> – D+/D– based USB host/charging port detection. The detection includes data contact detection (DCD) and secondary detection in BC1.2.
D–	1	AIO	<b>Negative USB data line</b> – D+/D– based USB host/charging port detection. The detection includes data contact detection (DCD) and secondary detection in BC1.2.
STAT	2	DO	<b>Open drain charge status indicator</b> – Connect to the pull-up rail via 10-kΩ resistor. LOW indicates charge in progress. HIGH indicates charge complete or charge disabled. When any fault occurs, the STAT pin blinks at 1Hz. The STAT function can be disabled when the STAT_DIS bit is set.
$\overline{\text{CE}}$	3	DI	<b>Active Low Charge Enable Pin</b> – Battery charging is enabled when EN_CHG bit is 1 and $\overline{\text{CE}}$ pin is LOW. $\overline{\text{CE}}$ pin is internally pulled low with 900k-Ω resistor.
SDA	4	DIO	<b>I2C Interface Data</b> – Connect SDA to the pull up rail through a 10-kΩ resistor.
SCL	5	DI	<b>I2C Interface Clock</b> – Connect SCL to the pull up rail through a 10-kΩ resistor.
$\overline{\text{INT}}$	6	DO	<b>Open drain active Interrupt Output</b> – Connect $\overline{\text{INT}}$ to the pull up rail via a 10-kΩ resistor. The $\overline{\text{INT}}$ pin sends active low, 256-μs pulse to the host to report charger device status and fault.
TS	7	AI	<b>Temperature Qualification Voltage</b> – Connect a negative temperature coefficient thermistor. Program temperature window with a resistor divider from REGN to TS to GND. Charge suspends when TS pin is out of range. Recommend 103AT-2 thermistor.

**Pin Functions (continued)**

PIN		I/O	DESCRIPTION
NAME	NO.		
ILIM	8	AI	<b>Input Current Limit (IINDPM)</b> – ILIM pin sets the maximum input current and can be used to monitor input current. IINDPM loop regulates ILIM pin voltage at 0.8V. When ILIM pin is less than 0.8V, the input current can be calculated by $IIN = KILIM \times VILIM / (RILIM \times 0.8V)$ . A resistor connected from ILIM pin to ground sets the input current limit as maximum ( $IINMAX = KILIM / RILIM$ ). When ILIM pin is short to GND, the input current limit is set to maximum by ILIM. The actual input current limit is the lower limit set by ILIM pin (when EN_ILIM bit is HIGH) or IINDPM register bits. Input current limit less than 500mA is not supported on ILIM pin. The ILIM pin function can be disabled when EN_ILIM bit is 0. If ILIM pin is not used, pull this pin to GND. Do not float this pin.
$\overline{PG}$	9	DO	<b>Open drain active low power good indicator</b> – Connect to the pull up rail via 10-k $\Omega$ resistor. LOW indicates a good input source if the input voltage is within VVBUS_OP (3.9 V), and can provide more than IPOORSRC (30 mA).
REGN	11	P	<b>Gate Drive Supply</b> – Bias supply for internal MOSFETs driver and IC. Bypass REGN to GND with a 4.7- $\mu$ F ceramic capacitor. REGN current limit is 50 mA.
BTST	12	P	<b>PWM High-side Driver Supply</b> – Internally, BTST is connected to the cathode of the boot-strap diode. Connect a 47nF bootstrap capacitor from SW to BTST.
BAT	13, 14	P	<b>Battery Power Connection</b> – Connect minimum recommended 10- $\mu$ F capacitance after derating closely to the BAT pin and GND.
SYS	15, 16	P	<b>System Connection</b> – The internal BATFET is connected between SYS and BAT. When the battery falls below the minimum system voltage, the switch-mode converter keeps SYS above the minimum system voltage. Connect a 2x22- $\mu$ F capacitance after derating closely to the SYS pin and PGND.
SW	17, 18	P	<b>Inductor Connection</b> – Connect to the switched side of the external inductor.
GND	19, 20,	–	<b>Ground Return</b>
PMID	21, 22	P	<b>Blocking MOSFET Connection</b> – The minimum recommended total input low-ESR capacitance on VBUS and PMID, after applied derating, is 10 uF. At least 1-uF is recommended at VBUS with the remainder at PMID. Typical value for PMID is 10 uF.
VBUS	23	P	<b>Input Supply</b> – VBUS is connected to the external DC supply. Bypass VBUS to GND with at least 1- $\mu$ F ceramic capacitor, placed as close to the IC as possible.
NC	10	–	<b>No Connect</b> – Leave these pins floating or tie to ground.

## 7 Specifications

### 7.1 Absolute Maximum Ratings

over operating free-air temperature range (unless otherwise noted)

		MIN	MAX	UNIT
Voltage Range (with respect to GND unless otherwise specified)	V <sub>BUS</sub> (converter not switching)	-0.3	20	V
	P <sub>MI</sub> D (converter not switching)	-0.3	8.5	V
	BAT, SYS (converter not switching)	-0.3	12	V
	SW	-0.3	13	V
	BTST	-0.3	19	V
	REGN, STAT, /PG, TS	-0.3	6	V
	ILIM	-0.3	5	V
	BTST to SW	-0.3	6	V
	D+, D-, /CE, SDA, SCL, /INT	-0.3	6	V
Output Sink Current	/INT, STAT, /PG		6	mA
Junction Temperature, T <sub>J</sub>		-40	150	°C
Storage temperature, T <sub>stg</sub>		-40	150	°C

### 7.2 ESD Ratings

		VALUE	UNIT
V <sub>(ESD)</sub>	Electrostatic discharge	Human body model (HBM), per ANSI/ESDA/JEDEC JS-001 <sup>(1)</sup>	±2000 V
		Charged device model (CDM), per JEDEC specification JESD22-C101 <sup>(2)</sup>	±250 V

(1) JEDEC document JEP155 states that 500-V HBM allows safe manufacturing with a standard ESD control process.

(2) JEDEC document JEP157 states that 250-V CDM allows safe manufacturing with a standard ESD control process.

### 7.3 Recommended Operating Conditions

over operating free-air temperature range (unless otherwise noted)

		MIN	NOM	MAX	UNIT
I <sub>V<sub>BUS</sub></sub>	Average input current (V <sub>BUS</sub> )			3.3	A
I <sub>BAT</sub>	Average charge current (IBAT)			2.2	A
I <sub>BAT_RMS</sub>	RMS discharging current with internal MOSFET		6	6.5	A
I <sub>BAT_PK</sub>	Peak discharging current with internal MOSFET			8 (TBD)	A
V <sub>BAT</sub>	Battery Voltage			9.2 <sup>(1)</sup>	V
T <sub>A</sub>	Operating free-air temperature range	-40		85	°C

(1) The inherent switching noise voltage spikes should not exceed the absolute maximum rating on SW pin. A tight layout minimizes switching noise.

### 7.4 Thermal Information

over operating free-air temperature range (unless otherwise noted)

THERMAL METRIC <sup>(1)</sup>		BQ25883	
		RGE (VQFN)	UNIT
		24-PIN	
R <sub>θJA</sub>	Junction-to-ambient thermal resistance	32.4	°C/W
R <sub>θJC(top)</sub>	Junction-to-case (top) thermal resistance	26.7	°C/W
R <sub>θJB</sub>	Junction-to-board thermal resistance	10.7	°C/W
Ψ <sub>JT</sub>	Junction-to-top characterization parameter	0.4	°C/W
Ψ <sub>JB</sub>	Junction-to-board characterization parameter	10.6	°C/W
R <sub>θJC(bot)</sub>	Junction-to-case (bottom) thermal resistance	3.7	°C/W

(1) For more information about traditional and new thermal metrics, see the Semiconductor and IC Package Thermal Metrics application report, [SPRA953](#).

## 7.5 Electrical Characteristics

 $V_{VBUS\_UVLO\_RISING} < V_{VBUS} < V_{VBUS\_OV}$ ,  $T_J = -40^{\circ}\text{C}$  to  $+125^{\circ}\text{C}$ , and  $T_J = 25^{\circ}\text{C}$  for typical values (unless otherwise noted)

PARAMETER		TEST CONDITIONS	MIN	TYP	MAX	UNIT
<b>QUIESCENT CURRENTS</b>						
$I_{BAT}$	Battery discharge current (BAT)	VBAT = 9 V, No VBUS, SCL, SDA = 0 V or 1.8 V, $T_J = 25^{\circ}\text{C}$ , ADC Disabled		12	14	$\mu\text{A}$
		VBAT = 9 V, No VBUS, SCL, SDA = 0 V or 1.8 V, $T_J < 85^{\circ}\text{C}$ , ADC Disabled		12	20	$\mu\text{A}$
$I_{VBUS\_HIZ}$	Input supply current (VBUS) in HIZ	VBUS = 5 V, High-Z Mode, no battery, ADC Disabled, $25^{\circ}\text{C}$		30	38	$\mu\text{A}$
		VBUS = 5 V, High-Z Mode, no battery, ADC Disabled, $< 85^{\circ}\text{C}$		30	48	$\mu\text{A}$
$I_{VBUS}$	Input supply current (VBUS)	VBUS = 5 V, $V_{BAT} = 7.6\text{ V}$ , converter not switching		1.5	3	mA
		VBUS = 5 V, $V_{BAT} = 7.6\text{ V}$ , converter switching, $I_{SYS} = 0\text{ A}$		3		mA
$I_{BAT\_OTG}$	Battery discharge current in OTG mode	VBAT = 8.4 V, OTG Buck Mode, $I_{VBUS} = 0\text{ A}$ , converter switching		3		mA
<b>VBUS/VBAT POWER UP</b>						
$V_{VBUS\_OP}$	VBUS operating range		3.9		6.2	V
$V_{VBUS\_UVLO\_RISING}$	VBUS rising for active I2C, no battery	VBUS rising		3.3	3.65	V
$V_{VBUS\_OV}$	VBUS over-voltage rising threshold	VBUS rising		6.2	6.6	V
	VBUS over-voltage falling threshold	VBUS falling		5.9	6.4	V
$V_{BAT\_UVLO\_RISING}$	Battery for active I2C	VBAT rising	3.7	4	4.42	V
$V_{POORSRC\_FALLING}$	Bad adapter detection threshold	VBUS falling below $V_{POORSRC\_FALLING}$		3.7		V
$I_{POORSRC}$	Bad adapter detection current source			15		mA
$V_{SYS}$	Typical System Regulation Voltage	$I_{SYS} = 0\text{ A}$ , VBAT = 8.80 V > $SYS\_MIN[3:0]$ , Charge Disabled (EN_CHG = 0)		$V_{BAT} + 0.1$		V
		$I_{SYS} = 0\text{ A}$ , VBAT < $SYS\_MIN[3:0]$ , Charge Disabled (EN_CHG = 0)		$V_{SYS\_MIN} + 0.2$		V
$V_{SYS\_MIN}$	System Regulation Voltage	VBAT < $SYS\_MIN[3:0] = 0010$ , Charge Disabled (EN_CHG = 0)	6.2	6.4		V
<b>BATTERY CHARGER</b>						
$V_{REG\_RANGE}$	Typical charge voltage regulation range		6.8		9.2	V
$V_{REG\_STEP}$	Typical charge voltage step			10		mV
$V_{REG\_ACC}$	Charge voltage	VREG = 8.40 V, $T_J = 0^{\circ}\text{C}$ to $85^{\circ}\text{C}$ ,	8.35	8.4	8.44	V
$I_{CHG\_RANGE}$	Charge current regulation range		100		2200	mA
$I_{CHG\_STEP}$	Charge current regulation step			50		mA
$I_{CHG\_ACC}$	Fast Charge current regulation accuracy	ICHG = 1000 mA, VBAT = 6.2 V or 7.6 V, $T_J = 0^{\circ}\text{C}$ to $85^{\circ}\text{C}$	-7.5		7.5	%
$I_{CHG\_ACC}$	Fast Charge current regulation accuracy	ICHG = 500mA, VBAT = 6.2 V or 7.6 V, $T_J = 0^{\circ}\text{C}$ to $85^{\circ}\text{C}$	-15		15	%
$I_{CHG\_ACC}$	Fast Charge current regulation accuracy	ICHG = 250 mA, VBAT = 6.2 V or 7.6 V, $T_J = 0^{\circ}\text{C}$ to $85^{\circ}\text{C}$	-25		25	%
$I_{PRECHG\_RANGE}$	Precharge current range		50		800	mA
$I_{PRECHG\_STEP}$	Typical precharge current step			50		mA
$I_{PRECHG\_ACC}$	Precharge current accuracy	VBAT = 5.2 V, IPRECHG = 200 mA, $T_J = 25^{\circ}\text{C}$		170	237	mA
		VBAT = 5.2 V, IPRECHG = 200 mA, $T_J = 0^{\circ}\text{C}$ to $85^{\circ}\text{C}$		150	245	mA
$I_{TERM\_RANGE}$	Termination current range		50		800	mA
$I_{TERM\_STEP}$	Typical termination current step			50		mA

## Electrical Characteristics (continued)

 $V_{VBUS\_UVLO\_RISING} < V_{VBUS} < V_{VBUS\_OV}$ ,  $T_J = -40^{\circ}\text{C}$  to  $+125^{\circ}\text{C}$ , and  $T_J = 25^{\circ}\text{C}$  for typical values (unless otherwise noted)

PARAMETER		TEST CONDITIONS	MIN	TYP	MAX	UNIT
I <sub>TERM_ACC</sub>	Termination current accuracy	ICHG = 1.5A, ITERM = 150 mA, T <sub>J</sub> = 25°C	143		157	mA
		ICHG = 1.5A, ITERM = 150 mA, T <sub>J</sub> = 0°C to 85°C	120		180	mA
		ICHG = 1.5A, ITERM = 100 mA, T <sub>J</sub> = 25°C	95		107	mA
		ICHG = 1.5A, ITERM = 100 mA, T <sub>J</sub> = 0°C to 85°C	65		125	mA
V <sub>BAT_SHORT_RISING</sub>	Short Battery Voltage rising threshold to start pre-charging	VBAT rising	4.1	4.4	4.7	V
V <sub>BAT_SHORT_FALLING</sub>	Short Battery Voltage falling threshold to stop pre-charging	VBAT falling	3.7	4	4.3	V
I <sub>BAT_SHORT</sub>	Low Battery Voltage trickle charging current	VBAT < 4.4 V		100		mA
V <sub>BAT_LOWV_RISING</sub>	VBAT LOWV Rising threshold to start fast-charging	VBAT rising, VBATLOW = 5.6 V	5.3	5.6	5.9	V
V <sub>BAT_LOWV_RISING</sub>	VBAT LOWV Rising threshold to start fast-charging	VBAT rising, VBATLOWV = 6.0 V	5.7	6	6.3	V
V <sub>BAT_LOWV_FALLING</sub>	VBAT LOWV Falling threshold to stop fast-charging	VBAT falling, VBATLOW = 5.6 V	4.9	5.2	5.5	V
V <sub>BAT_LOWV_FALLING</sub>	VBAT LOWV Falling threshold to stop fast-charging	VBAT falling, VBATLOWV = 6.0 V	5.3	5.6	5.9	V
V <sub>RECHG</sub>	Recharge threshold below V <sub>REG</sub>	VBAT falling, VRECHG[1:0] = 01		200		mV
		VBAT falling, VRECHG[1:0] = 10		300		mV
R <sub>ON_QHS</sub> (Q2)	High-side switching MOSFET on-resistance between SW and SYS (Q2)	T <sub>J</sub> = 25°C		32	34.2	mΩ
		T <sub>J</sub> = -40°C to 125°C		32	46.5	mΩ
R <sub>ON_QLS</sub> (Q3)	Low-side switching MOSFET on-resistance between SW and GND (Q3)	T <sub>J</sub> = 25°C		42	45.8	mΩ
		T <sub>J</sub> = -40°C to 125°C		42	62.5	mΩ
R <sub>ON_QBAT</sub> (Q4)	MOSFET on-resistance between SYS and BAT (Q4)	T <sub>J</sub> = 25°C		18	18.8	mΩ
		T <sub>J</sub> = -40°C - 85°C		18	22.5	mΩ
I <sub>BAT_DISCHG</sub>	BAT Discharge current source	VBAT = 8V, EN_BAT_DISCHG = 1	8	11.5	16	mA
<b>INPUT VOLTAGE / CURRENT REGULATION</b>						
V <sub>INDPM_RANGE</sub>	Input voltage regulation range		3.9		5.5	V
V <sub>INDPM_STEP</sub>	Input voltage regulation step			100		mV
V <sub>INDPM</sub>	Input voltage limit	VINDPM = 3.9 V	3.783	3.9	4.017	V
		VINDPM = 4.4 V	4.268	4.4	4.532	V
I <sub>INDPM_RANGE</sub>	Input current regulation range		500		3300	mA
I <sub>INDPM_STEP</sub>	Input current regulation step			100		mA
I <sub>INDPM_ACC</sub>	Input current regulation limit	IINDPM = 500 mA	438	469	500	mA
		IINDPM = 900 mA	765	832	900	mA
		IINDPM = 2500 mA	2125	2312	2500	mA
		IINDPM = 3000 mA	2550	2775	3000	mA
K <sub>LIM</sub>	I <sub>INMAX</sub> = K <sub>LIM</sub> /R <sub>LIM</sub>	Input Current regulation by ILIM pin = 1.5A	1012	1098	1185	A x Ω
R <sub>ON_QBLK</sub> (Q1)	Blocking MOSFET on-resistance between VBUS and PMID (QBLK)	T <sub>J</sub> = 25°C		33	36.8	mΩ
		T <sub>J</sub> = -40°C to 125°C		33	50	mΩ
V <sub>D+D-_600MVSRC</sub>	D+/D- Voltage Source (600 mV)		500	600	700	mV
I <sub>D+_10UASRC</sub>	D+ Current Source (10 μA)	VD + = 200 mV,	7	10	14	μA
I <sub>D+D-_100UASNK</sub>	D+/D- Current Sink (100 μA)	VD + = 500 mV,	50	100	150	μA
V <sub>D+D-_0P325</sub>	D+/D- Comparator Threshold for Secondary Detection	D + pin Rising	250		400	mV

## Electrical Characteristics (continued)

 $V_{VBUS\_UVLO\_RISING} < V_{VBUS} < V_{VBUS\_OV}$ ,  $T_J = -40^{\circ}\text{C}$  to  $+125^{\circ}\text{C}$ , and  $T_J = 25^{\circ}\text{C}$  for typical values (unless otherwise noted)

PARAMETER		TEST CONDITIONS	MIN	TYP	MAX	UNIT
$R_{D\_19K}$	D- Resistor to Ground (19 k $\Omega$ )	VD- = 500 mV,	14.25		24.8	k $\Omega$
$V_{D+_0P8}$	D+ Comparator Threshold for Data Contact Detection	D + pin Rising			800	mV
$V_{D+D\_1P2}$	D+/D- Threshold for Non-standard adapter		1.05		1.35	V
$V_{D+D\_2P0}$	D+/D- Comparator Threshold for Non-standard adapter		1.85		2.15	V
$V_{D+D\_2P8}$	D+/D- Threshold for Non-standard adapter		2.55		2.85	V
$I_{D+D\_LKG}$	D+/D- Leakage Current	HiZ	-1		1	$\mu\text{A}$
$V_{BAT\_OVP\_RISING}$	Battery over-voltage rising threshold	VBAT rising, as percentage of VREG	102.7	104	105	%
$V_{BAT\_OVP\_FALLING}$	Battery over-voltage falling threshold	VBAT falling, as percentage of VREG	101	102	103.3	%
<b>THERMAL REGULATION AND THERMAL SHUTDOWN</b>						
$T_{REG}$	Junction temperature regulation accuracy	TREG = 120 $^{\circ}\text{C}$		120		$^{\circ}\text{C}$
$T_{SHUT\_RISING}$	Thermal Shutdown Rising threshold	Temperature Increasing		150		$^{\circ}\text{C}$
	Thermal Shutdown Falling threshold	Temperature Decreasing		120		$^{\circ}\text{C}$
<b>JEITA THERMISTOR COMPARATOR (BOOST MODE)</b>						
$V_{T1}$	TS pin voltage rising. T1 (0 $^{\circ}\text{C}$ ) threshold, Charge suspended below this temperature.	As Percentage to REGN	72.75	73.25	73.75	%
$V_{T1\_HYS}$	TS pin voltage falling. Charge re-enabled to ICHG/2 and VREG above this temperature	As Percentage to REGN		1.3		%
$V_{T2}$	TS pin voltage rising. T2 (10 $^{\circ}\text{C}$ ) threshold, charge set to ICHG/2 and VREG below this temperature	As Percentage to REGN	67.75	68.25	68.75	%
$V_{T2\_HYS}$	TS pin voltage falling. Charge set to ICHG and VREG above this temperature	As Percentage to REGN		1.2		%
$V_{T3}$	TS pin voltage falling. T3 (45 $^{\circ}\text{C}$ ) threshold, charge set to ICHG and 8.1 V above this temperature.	As Percentage to REGN	44.25	44.75	45.25	%
$V_{T3\_HYS}$	TS pin voltage rising. Charge set to ICHG and VREG below this temperature	As Percentage to REGN		1		%
$V_{T5}$	TS pin voltage falling. T5 (60 $^{\circ}\text{C}$ ) threshold, charge suspended above this temperature.	As Percentage to REGN	33.875	34.375	34.875	%
$V_{T5\_HYS}$	TS pin voltage rising. Charge set to ICHG and 8.1 V below this temperature	As Percentage to REGN		1.35		%
$V_{BCOLD0}$	Cold Temperature Threshold 0, TS pin Voltage Rising Threshold	As Percentage to REGN, BCOLD = 0 (Approx. – 10 $^{\circ}\text{C}$ w/ 103AT)	76.5	77	77.5	%
$V_{BCOLD0\_HYS}$	Cold Temperature Threshold 0, TS pin Voltage Falling Threshold	As Percentage to REGN		1		%
$V_{BCOLD1}$	Cold Temperature Threshold 1, TS pin Voltage Rising Threshold	As Percentage to REGN, BCOLD = 1 (Approx. – 20 $^{\circ}\text{C}$ w/ 103AT)	79.5	80	80.5	%
$V_{BCOLD1\_HYS}$	Cold Temperature Threshold 1, TS pin Voltage Falling Threshold	As Percentage to REGN		1		%
$V_{BHOT0}$	Hot Temperature Threshold 0, TS pin Voltage Falling Threshold	As Percentage to REGN, BHOT[1:0] = 01 (Approx. 55 $^{\circ}\text{C}$ w/ 103AT)	37.25	37.75	38.25	%
$V_{BHOT0\_HYS}$	Hot Temperature Threshold 0, TS pin Voltage Rising Threshold	As Percentage to REGN		3		%

**Electrical Characteristics (continued)**
 $V_{VBUS\_UVLO\_RISING} < V_{VBUS} < V_{VBUS\_OV}$ ,  $T_J = -40^{\circ}\text{C}$  to  $+125^{\circ}\text{C}$ , and  $T_J = 25^{\circ}\text{C}$  for typical values (unless otherwise noted)

PARAMETER		TEST CONDITIONS	MIN	TYP	MAX	UNIT
$V_{BHOT1}$	Hot Temperature Threshold 1, TS pin Voltage falling Threshold	As Percentage to REGN, BHOT[1:0] = 00 (Approx. 60°C w/ 103AT)	33.875	34.375	34.875	%
$V_{BHOT1\_HYS}$	Hot Temperature Threshold 1, TS pin Voltage rising Threshold	As Percentage to REGN		3		%
$V_{BHOT2}$	Hot Temperature Threshold 2, TS pin Voltage falling Threshold	As Percentage to REGN, BHOT[1:0] = 10 (Approx. 65°C w/ 103AT)	30.75	31.25	31.75	%
$V_{BHOT2\_HYS}$	Hot Temperature Threshold 2, TS pin Voltage rising Threshold	As Percentage to REGN		3		%
<b>BOOST MODE CONVERTER</b>						
$F_{SW}$	PWM switching frequency	Oscillator frequency	1.35	1.5	1.65	MHz
$V_{OTG\_BAT}$	Battery voltage exiting OTG mode	VBAT falling	5.85	6	6.15	V
$V_{OTG\_RANGE}$	Typical OTG Buck mode voltage regulation range		4.5		5.5	V
$V_{OTG\_STEP}$	Typical OTG Buck mode voltage regulation step			100		mV
$V_{OTG\_ACC}$	OTG Buck mode voltage regulation accuracy	IVBUS = 0A, OTG_VLIM = 5.1 V	-3		3	%
$I_{OTG\_RANGE}$	Typical OTG Buck mode current regulation range				2	A
$I_{OTG\_STEP}$	Typical OTG Buck mode current regulation step			100		mA
$I_{OTG\_ACC}$	OTG Buck mode current regulation accuracy	OTG_ILIM = 2A	-15	-7.5	0	%
$I_{OTG\_ACC}$	OTG Buck mode current regulation accuracy	OTG_ILIM = 1A	-15	-7.5	0	%
$V_{OTG\_OVP}$	OTG Buck mode over-voltage threshold		5.8	6		V
<b>REGN LDO</b>						
$V_{REGN}$	REGN LDO output voltage	$V_{VBUS} = 5\text{ V}$ , $I_{REGN} = 20\text{ mA}$	4.7	4.8	5.15	V
$I_{REGN}$	REGN LDO current limit	$V_{VBUS} = 5\text{ V}$ , $V_{REGN} = 3.8\text{ V}$	50			mA
<b>Analog-to-Digital Converter (ADC)</b>						
$t_{ADC\_CONV}$	Conversion time, each measurement	ADC_SAMPLE[1:0] = 11		24		ms
		ADC_SAMPLE[1:0] = 10		12		ms
		ADC_SAMPLE[1:0] = 01		6		ms
		ADC_SAMPLE[1:0] = 00		3		ms
ADCRES	Effective resolution	ADC_SAMPLE[1:0] = 11	14	15		bits
		ADC_SAMPLE[1:0] = 10	13	14		bits
		ADC_SAMPLE[1:0] = 01	12	13		bits
		ADC_SAMPLE[1:0] = 00	10	12		bits
	Integral Nonlinearity	16-bit, Best Fit (Char only)			±6.6	LSB
	Differential Nonlinearity	16-bit, No Missing Codes (Char only)			±1	LSB
	Offset Error	16-bit, Post-Calibration		±1.8	±4.2	LSB
	Offset Error Drift	16-bit, Post-Calibration		0.02	0.01	LSB/ °C
	Gain Error	16-bit		±131	±492	LSB
	Gain Error Drift	16-bit		2	4.5	LSB/ °C
	Effective input resistance		8			MΩ
<b>ADC MEASUREMENT RANGES AND LSB</b>						
$I_{BUS\_ADC\_RANGE}$	ADC BUS current range		0		4	A

## Electrical Characteristics (continued)

 $V_{\text{VBUS\_UVLO\_RISING}} < V_{\text{VBUS}} < V_{\text{VBUS\_OV}}$ ,  $T_J = -40^{\circ}\text{C}$  to  $+125^{\circ}\text{C}$ , and  $T_J = 25^{\circ}\text{C}$  for typical values (unless otherwise noted)

PARAMETER		TEST CONDITIONS	MIN	TYP	MAX	UNIT
$I_{\text{BUS\_ADC\_LSB}}$	ADC BUS current LSB			1		mA
$I_{\text{BAT\_ADC\_RANGE}}$	ADC BAT current range		0		4	A
$I_{\text{BAT\_ADC\_LSB}}$	ADC BAT current LSB			1		mA
$V_{\text{BUS\_ADC\_RANGE}}$	ADC BUS voltage range		0		6.5	V
$V_{\text{BUS\_ADC\_LSB}}$	ADC BUS voltage LSB			1		mV
$V_{\text{SYS\_ADC\_RANGE}}$	ADC SYS voltage range		0		10	V
$V_{\text{SYS\_ADC\_LSB}}$	ADC SYS voltage LSB			1		mV
$V_{\text{BAT\_ADC\_RANGE}}$	ADC BAT voltage range		0		10	V
$V_{\text{BAT\_ADC\_LSB}}$	ADC BAT voltage LSB			1		mV
$V_{\text{CELLTOP\_ADC\_RANGE}}$	ADC MID voltage range		0		5	V
$V_{\text{CELLTOP\_ADC\_LSB}}$	ADC MID voltage LSB			1		mV
$V_{\text{CELLBOT\_ADC\_RANGE}}$	ADC MID voltage range		0		5	V
$V_{\text{CELLBOT\_ADC\_LSB}}$	ADC MID voltage LSB			1		mV
$V_{\text{TS\_ADC\_RANGE}}$	ADC TS voltage range		20		80	%
$V_{\text{TS\_ADC\_LSB}}$	ADC TS voltage LSB			0.098		%
$V_{\text{TDIE\_ADC\_RANGE}}$	ADC Die temperature range		0		150	$^{\circ}\text{C}$
$V_{\text{TDIE\_ADC\_LSB}}$	ADC Die temperature LSB			0.5		$^{\circ}\text{C}$
<b>I2C INTERFACE (SCL, SDA)</b>						
$V_{\text{IH}}$	Input high threshold level, SDA and SCL	Pull-up rail 1.8 V	1.3			V
$V_{\text{IL}}$	Input low threshold level	Pull-up rail 1.8 V			0.4	V
$V_{\text{OL}}$	Output low threshold level	Sink current = 5 mA			0.4	V
$I_{\text{BIAS}}$	High level leakage current	Pull-up rail 1.8 V			1	$\mu\text{A}$
$V_{\text{IH\_SDA}}$	Input high threshold level, SDA	Pull-up rail 1.8 V	1.3			V
$V_{\text{IL\_SDA}}$	Input low threshold level	Pull-up rail 1.8 V			0.4	V
$V_{\text{OL\_SDA}}$	Output low threshold level	Sink current = 5 mA			0.4	V
$I_{\text{BIAS\_SDA}}$	High level leakage current	Pull-up rail 1.8 V			1	$\mu\text{A}$
$V_{\text{IH\_SCL}}$	Input high threshold level, SDA	Pull-up rail 1.8 V	1.3			V
$V_{\text{IL\_SCL}}$	Input low threshold level	Pull-up rail 1.8 V			0.4	V
$V_{\text{OL\_SCL}}$	Output low threshold level	Sink current = 5 mA			0.4	V
$I_{\text{BIAS\_SCL}}$	High level leakage current	Pull-up rail 1.8 V			1	$\mu\text{A}$
<b>LOGIC I/O PIN (/CE, PSEL)</b>						
$V_{\text{IH}}$	Input high threshold level		1.3			V
$V_{\text{IL}}$	Input low threshold level				0.4	V
$I_{\text{IN\_BIAS}}$	High level leakage current	Pull-up rail 1.8 V			1	$\mu\text{A}$
<b>LOGIC O PIN (/INT, /PG, STAT)</b>						
$V_{\text{OL}}$	Output low threshold level	Sink current = 5 mA			0.4	V
$I_{\text{OUT\_BIAS}}$	High level leakage current	Pull-up rail 1.8 V			1	$\mu\text{A}$

## 7.6 Timing Requirements

PARAMETER		TEST CONDITIONS	MIN	NOM	MAX	UNIT
<b>VBUS/BAT POWER UP</b>						
$t_{\text{VBUS\_OV}}$	VBUS OVP reaction time	VBUS rising above $V_{\text{VBUS\_OV}}$ threshold to converter turn off		200		ns
$t_{\text{POORSRC}}$	Bad adapter detection duration			30		ms

**Timing Requirements (continued)**

PARAMETER		TEST CONDITIONS	MIN	NOM	MAX	UNIT
<b>BATTERY CHARGER</b>						
$t_{\text{TERM\_DGL}}$	Deglitch time for charge termination	Charge current falling below $I_{\text{TERM}}$		250		ms
$t_{\text{RECGH\_DGL}}$	Deglitch time for recharge threshold	BAT voltage falling below $V_{\text{RECHG}} = 100$ mV		250		ms
$t_{\text{BAT\_OVP\_DGL}}$	Deglitch time for battery over-voltage to disable charge			1		$\mu$ s
$t_{\text{TOP\_OFF}}$	Typical Top-Off Timer Accuracy	$\text{TOP\_OFF\_TIMER} = 30$ min	24	30	36	min
$t_{\text{SAFETY}}$	Charge Safety Timer Accuracy	$\text{CHG\_TIMER} = 12$ hours	10.8	12	13.2	hr
<b>I2C INTERFACE</b>						
$f_{\text{SCL}}$	SCL clock frequency				1000	KHZ
$t_{\text{SU\_STA}}$	Data set-up time		10			ns
$t_{\text{HD\_DAT}}$	Data hold time		0		70	ns
$t_{\text{rDA}}$	Rise time of SDA signal		10		80	ns
$t_{\text{fDA}}$	Fall time of SDA signal		10		80	ns
<b>DIGITAL CLOCK AND WATCHDOG TIMER</b>						
$f_{\text{LPDIG}}$	Digital low power clock	REGN LDO disabled	18	30	45	KHZ
$f_{\text{DIG}}$	Digital clock	REGN LDO enabled	1.35	1.5	1.65	MHz

## 7.7 Typical Characteristics

$C_{VBUS} = 1\mu\text{F}$ ,  $C_{PMID} = 10\mu\text{F}$ ,  $C_{SYS} = 44\mu\text{F}$ ,  $C_{BAT} = 10\mu\text{F}$ ,  $L = 1\mu\text{H}$  (DFE252012F-1R0) (unless otherwise specified)

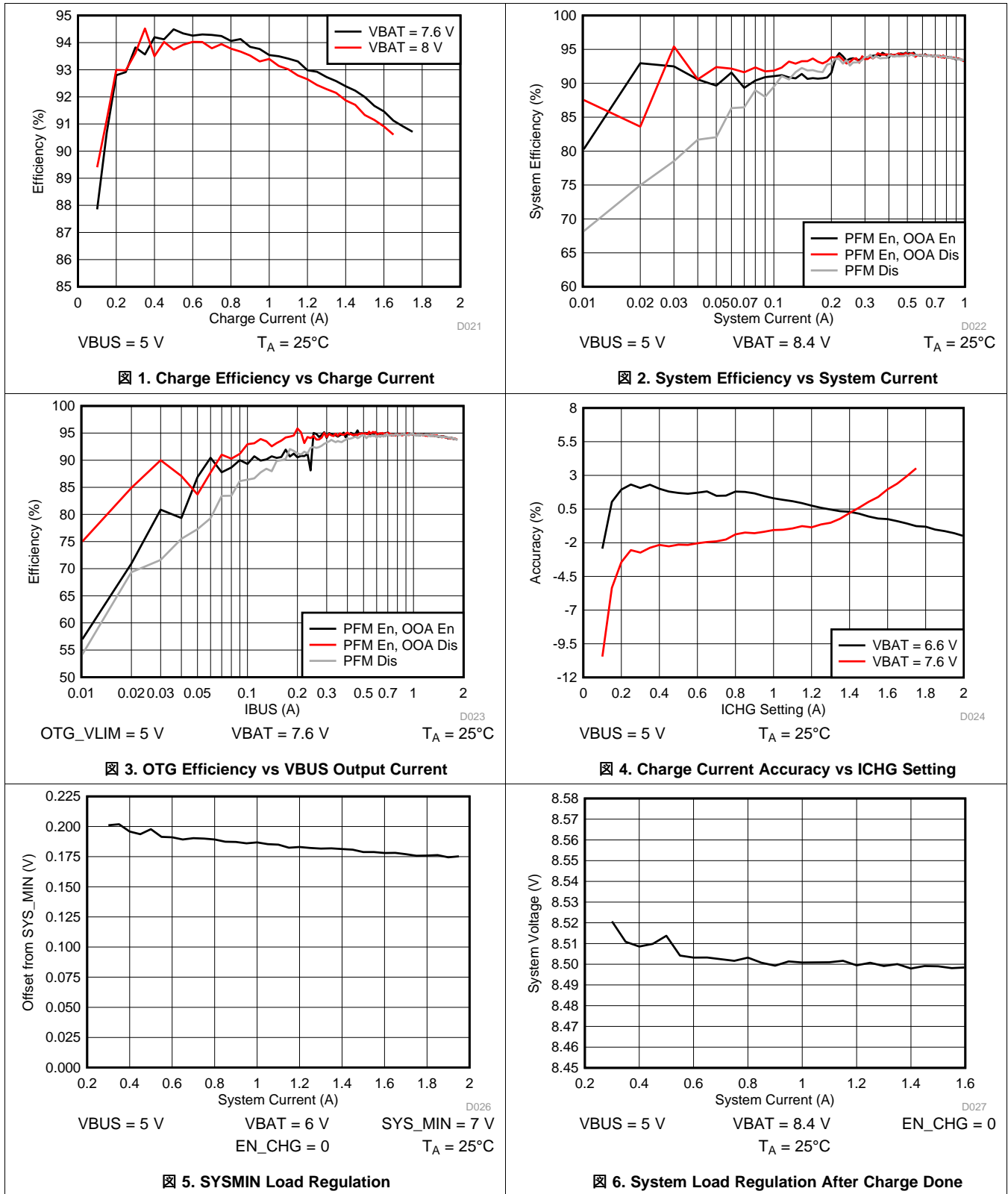

**Typical Characteristics (continued)**

$C_{VBUS} = 1\mu\text{F}$ ,  $C_{PMID} = 10\mu\text{F}$ ,  $C_{SYS} = 44\mu\text{F}$ ,  $C_{BAT} = 10\mu\text{F}$ ,  $L = 1\mu\text{H}$  (DFE252012F-1R0) (unless otherwise specified)

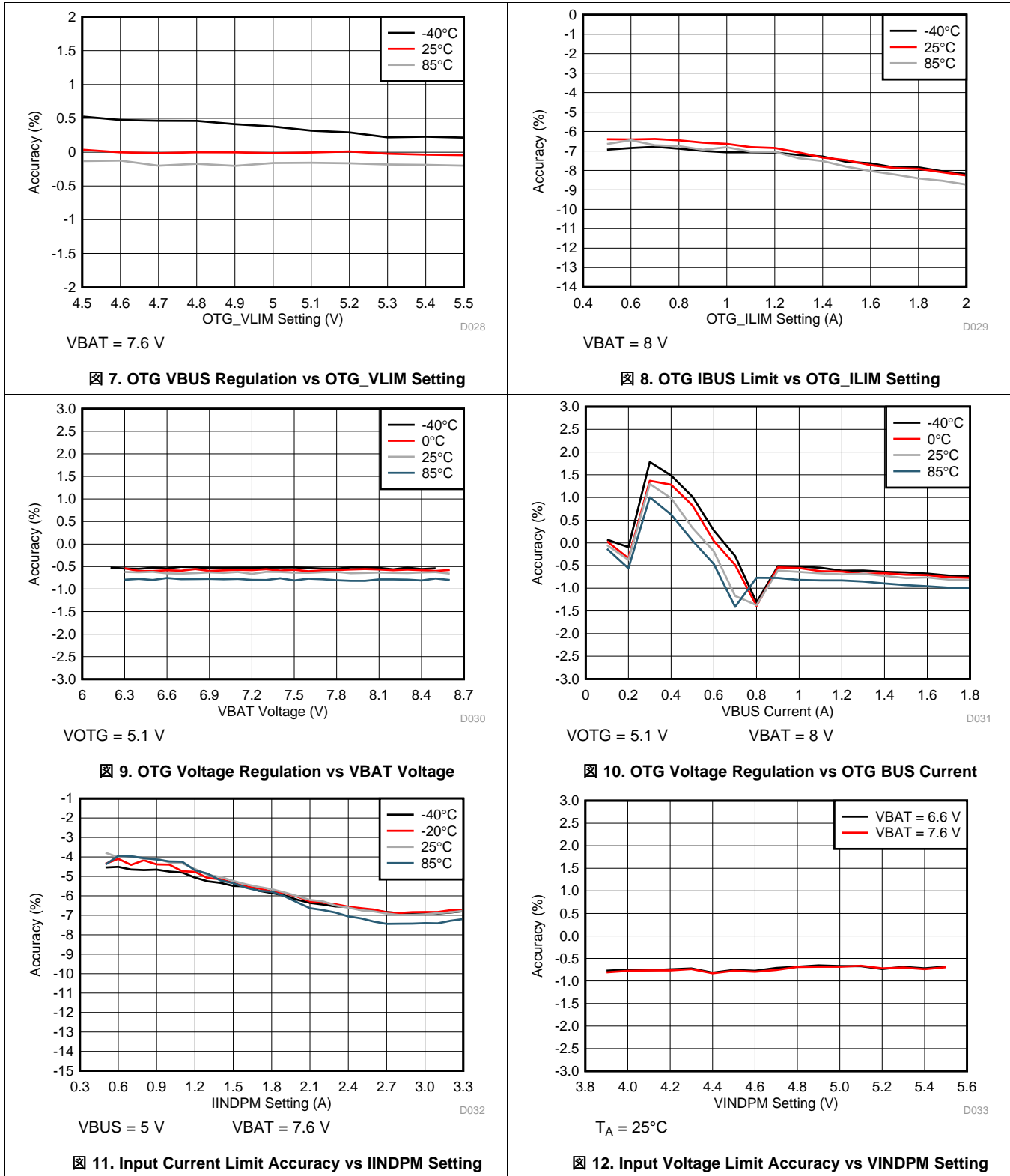

**Typical Characteristics (continued)**

$C_{VBUS} = 1\mu F$ ,  $C_{PMID} = 10\mu F$ ,  $C_{SYS} = 44\mu F$ ,  $C_{BAT} = 10\mu F$ ,  $L = 1\mu H$  (DFE252012F-1R0) (unless otherwise specified)

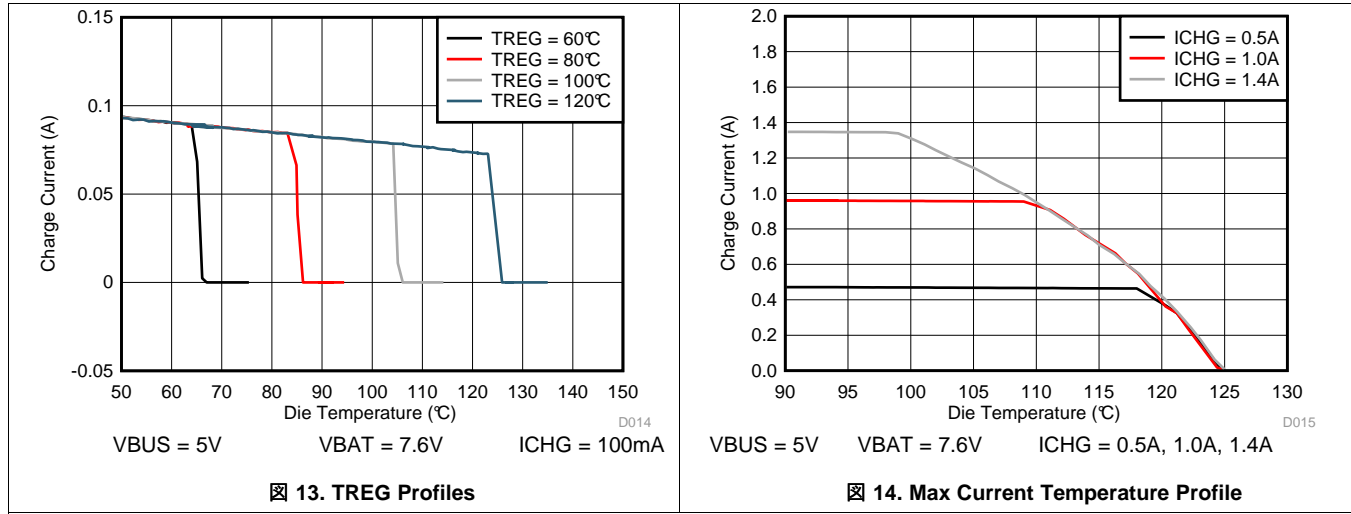

13. TREG Profiles

14. Max Current Temperature Profile

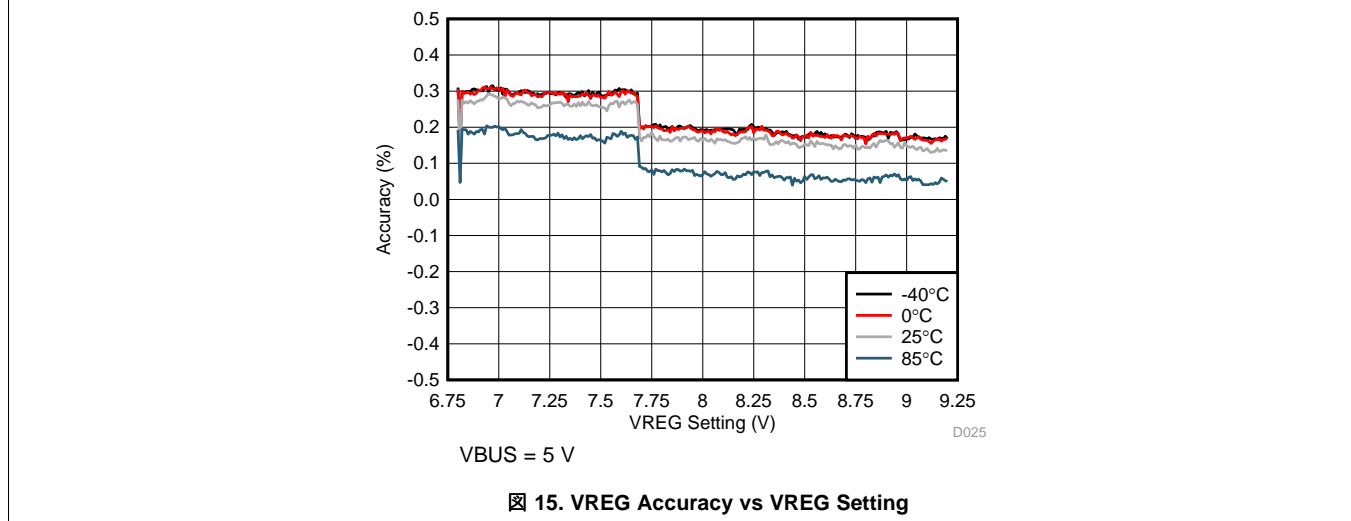

15. VREG Accuracy vs VREG Setting

## 8 Detailed Description

### 8.1 Overview

The BQ25883 device is a highly integrated 2-A switch-mode battery charger for 2s Li-Ion and Li-Polymer battery. It integrates the input blocking FET (Q1, QBLK), high-side switching FET (Q2, QHS), low-side switching FET (Q3, QLS), and battery FET (Q4, QBAT). The device also integrates the boot-strap diode for high-side gate drive.

### 8.2 Functional Block Diagram

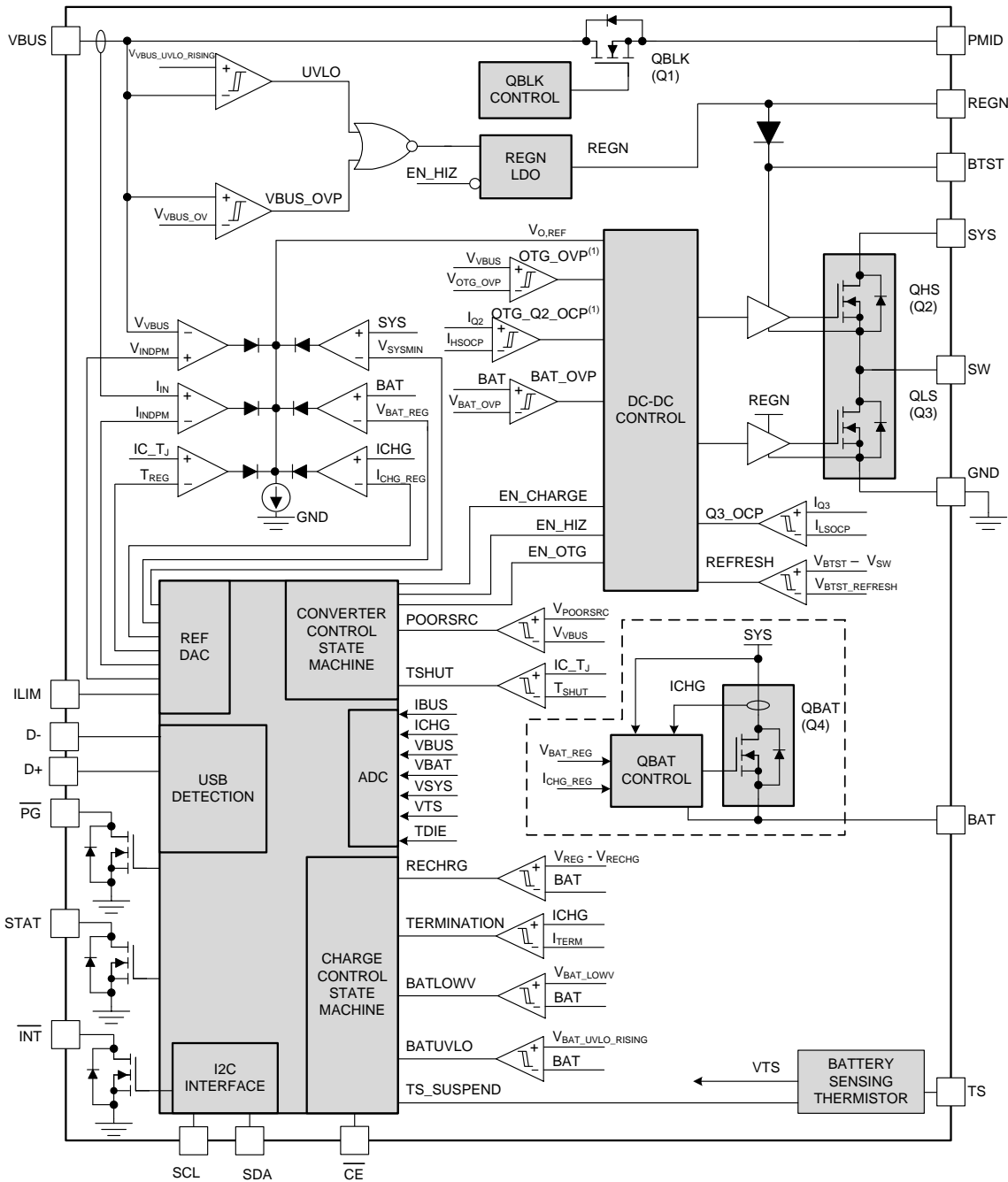

## 8.3 Feature Description

### 8.3.1 Device Power-On-Reset

The internal bias circuits are powered from either VBAT or VBUS when it rises above  $V_{VBUS\_UVLO\_RISING}$  or  $V_{BAT\_UVLO\_RISING}$ . When VBUS rises above  $V_{VBUS\_UVLO\_RISING}$  or BAT rises above  $V_{BAT\_UVLO\_RISING}$ , the BATFET driver is active. I2C interface is ready for communication and all the registers are reset to default value. The host can access all the registers after POR.

### 8.3.2 Device Power Up from Battery without Input Source

If only the battery is present and the voltage is above UVLO threshold ( $V_{BAT\_UVLO\_RISING}$ ), the BATFET turns on and connects battery to system. The REGN LDO stays off to minimize the quiescent current. The low  $R_{DS(ON)}$  of BATFET and the low quiescent current on BAT minimize the conduction loss and maximize the battery run time.

### 8.3.3 Device Power Up from Input Source

When an input source is plugged in, the device checks the input source voltage to turn on REGN LDO and all the bias circuits. It detects and sets the input current limit before the boost converter is started. The power up sequence from input source is as listed:

1. Poor Source Qualification
2. Input Source Type Detection based on D+/D– to set default Input Current Limit (IINDPM) register and input source type
3. Power Up REGN LDO
4. Converter Power-up

#### 8.3.3.1 Poor Source Qualification

After REGN LDO powers up, the device checks the current capability of the input source. The input source has to meet the following requirements in order to start the boost converter.

1. VBUS voltage below  $V_{VBUS\_OVP}$
2. VBUS voltage above  $V_{POORSRC}$  when pulling  $I_{POORSRC}$  (typical 30mA)

If  $V_{BUS\_OVP}$  is detected (condition 1 above), the device automatically retries detection once the over-voltage fault goes away. If a poor source is detected (condition 2 above), the device repeats poor source qualification routine every 2 seconds. After 7 consecutive failures, the device goes to HIZ mode. The battery powers up the system when the device is in HIZ. On BQ25883 adapter re-plug-in and/or EN\_HIZ bit toggle is required to restart device operation. The EN\_HIZ bit is cleared automatically when the adapter is plugged in. If the fault is not removed, the part will enter HIZ mode again after the 7 consecutive failures.

#### 8.3.3.2 Input Source Type Detection

After input source is qualified, the charger device runs input source type detection.

The BQ25883 follows the USB Battery Charging Specification 1.2 (BC1.2) to detect input source (SDP/CDP/DCP) and non-standard adapter through USB D+/D– lines. After input source type detection, the following registers and pins are changed:

1. Input Current Limit (IINDPM) register is changed to set current limit
2. Input Voltage Limit (VINDPM) register is changed to set default limit (if EN\_VINDPM\_RST = 1, otherwise VINDPM value remains unchanged)
3. VBUS\_STAT bits change to reflect the detected source
4.  $\overline{INT}$  pin pulses to notify the host
5.  $\overline{PG}$  pin is pulled LOW, and PG\_STAT bit is set to '1'

After detection is completed, the host can over-write IINDPM or VINDPM registers to change the input current, or input voltage limit if needed. The charger input current is always limited by the lower of IINDPM register, ILIM pin, or Input Current Optimizer (ICO) setting when ICO is enabled.

When AUTO\_INDET\_EN is disabled, the Input Source Type Detection is bypassed, and the Input Current Limit (IINDPM) register remains unchanged from previous value. When EN\_VINDPM\_RST is disabled, the Input Voltage Limit (VINDPM) register remains unchanged from previous value.

**Feature Description (continued)**

**8.3.3.2.1 D+/D- Detection Sets Input Current Limit**

The BQ25883 contains a D+/D- based input source detection to program the input current limit. The D+/D- detection has three major steps: Data Contact Detect (DCD), Primary Detection, and Secondary Detection.



图 16. D+/D- Detection Flow

表 2. Non-Standard Adapter Detection

NON-STANDARD ADAPTER	D+ THRESHOLD	D- THRESHOLD	INPUT CURRENT LIMIT
Divider 1	$V_{D+}$ within $V_{2P8\_VTH}$	$V_{D-}$ within $V_{2P0\_VTH}$	2.1A
Divider 3	$V_{D+}$ within $V_{2P0\_VTH}$	$V_{D-}$ within $V_{2P8\_VTH}$	1A
Divider 4	$V_{D+}$ within $V_{2P8\_VTH}$	$V_{D-}$ within $V_{2P8\_VTH}$	2.4A

After the Input Source Type Detection is done, an  $\overline{INT}$  pulse is asserted to the host. In addition, the following registers including Input Current Limit register (IINDPM), and VBUS\_STAT are updated as below:

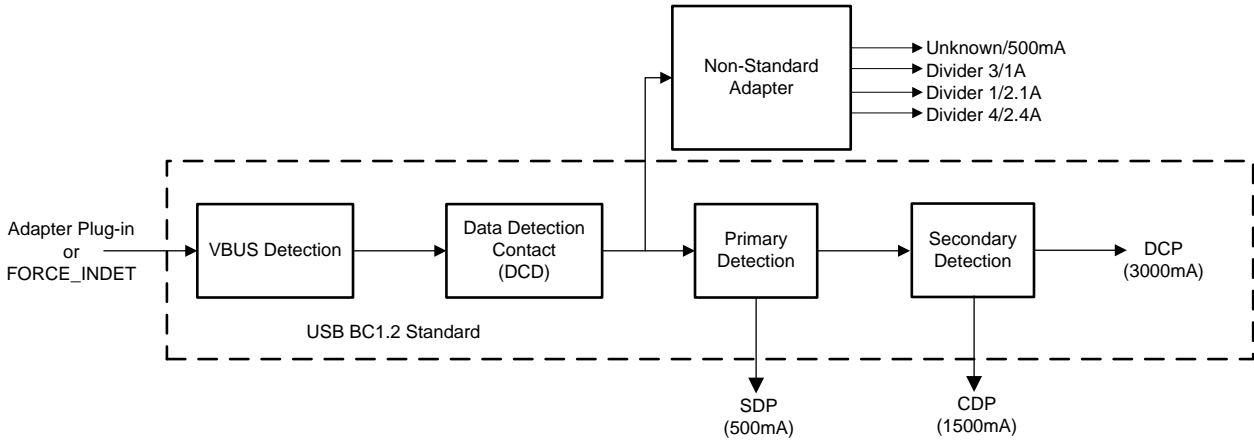
表 3. Input Current Limit Setting from D+/D- Detection

D+/D- DETECTION	INPUT CURRENT LIMIT (IINDPM)	VBUS_STAT
USB SDP (USB500)	500mA	001
USB CDP	1.5A	010
USB DCP	3.0A	011
Divider 3	1A	110
Divider 1	2.1A	110
Divider 4	2.4A	110
Unknown 5V Adapter	500mA	101

**8.3.3.2.2 Force Input Current Limit Detection**

In host mode, the host can force the device to run Input Current Limit Detection by setting FORCE\_INDET bit. After the detection is completed, FORCE\_INDET bit returns to 0 by itself and input result is updated.

**8.3.3.3 Power Up REGN Regulator (LDO)**

The REGN LDO supplies internal bias circuits as well as the QHS and QLS gate drive. The LDO also provides bias rail to TS external resistors. The pull-up rail of STAT and PG can be connected to REGN as well. The REGN is enabled when all the below conditions are valid.

1. VBUS above  $V_{VBUS\_UVLO\_RISING}$  in boost mode or VBUS below  $V_{VBUS\_UVLO\_RISING}$  in buck mode
2. Poor Source Qualification detects a valid input source
3. Input Source Type Detection completes and sets appropriate input current limit

4. After 220 ms delay is complete

If one of the above conditions is not valid, the device is in high impedance mode (HIZ) with REGN LDO off. The device draws less than  $I_{VBUS\_HIZ}$  from VBUS during HIZ state. The battery powers up the system when the device is in HIZ.

### 8.3.3.4 Converter Power Up

After the input current limit is set, the  $\overline{PG}$  pin is pulled LOW, the PG\_STAT and VBUS\_STAT bits are changed, and the converter is enabled, allowing the HSFET and LSFET to start switching. If battery charging is disabled, BATFET turns off. Otherwise, BATFET stays on to charge the battery. The device provides soft-start when is ramped up.

Before charging begins, the battery discharge source (IBAT\_DISCHG) is enabled automatically to detect the presence of battery. The host can enable IBAT\_DISCHG via the EN\_BAT\_DISCHG bit at any point during operation, including in Battery Only or HIZ modes.

As a battery charger, the device deploys a highly efficient 1.5 MHz boost switching regulator. The fixed frequency oscillator keeps tight control of the switching frequency under all conditions of input voltage, battery voltage, charge current and temperature, simplifying output filter design.

In order to improve light-load efficiency, the device switches to PFM (Pulse Frequency Modulation) control at light load when battery is below minimum system voltage setting or charging is disabled. During the PFM operation, the switching duty cycle is set by the ratio of SYS and VBUS.

### 8.3.4 Input Current Optimizer (ICO)

The device provides innovative Input Current Optimizer (ICO) to identify maximum power point without overloading the input source. The algorithm automatically identifies maximum input current limit of a power source without staying in VINDPM to avoid input source overload.

On BQ25883, this feature is enabled by default (EN\_ICO=1) and can be disabled by setting EN\_ICO bit to 0. After DCP type input source is detected based on the procedures describe above (Input Source Type Detection). The algorithm runs automatically when EN\_ICO bit is set. The algorithm can also be forced to execute by setting FORCE\_ICO bit regardless of input source type detected .

**表 4. Input Current Optimizer Automatic Operation**

DEVICE	INPUT SOURCE	INPUT CURRENT LIMIT (IINDPM)	AUTOMATIC START ICO ALGORITHM WHEN EN_ICO = 1
BQ25883 (D+/D-)	USB SDP (USB500)	500mA	Disable
	USB CDP	1.5A	Disable
	USB DCP	3.0A	Enable
	Divider 3	1A	Disable
	Divider 1	2.1A	Disable
	Divider 4	2.4A	Disable
	Unknown 5V Adapter	500mA	Disable

The actual input current limit used by the Dynamic Power Management is reported in ICO\_ILIM register while Input Current Optimizer is enabled (EN\_ICO = 1) or set by IINDPM register when the algorithm is disabled (EN\_ICO=0). In addition, the current limit is clamped by ILIM pin unless EN\_ILIM bit is 0 to disable ILIM pin function.

When the algorithm is enabled, it runs continuously to adjust input current limit of Dynamic Power Management (IINDPM) using ICO\_ILIM register until ICO\_STAT[1:0] and ICO\_FLAG bits are set (the ICO\_FLAG bit indicates any change in ICO\_STAT[1:0] bits). The algorithm operates depending on battery voltage:

1. When voltage at BAT pin is below SYS\_MIN, the algorithm starts ICO\_ILIM register with IINDPM which is the maximum input current limit allowed by system
2. When voltage at BAT is above SYS\_MIN, the algorithm starts ICO\_ILIM register with 500mA which is the minimum input current limit to minimize adapter overload

When optimal input current is identified, the ICO\_STAT[1:0] and ICO\_FLAG bits are set to indicate input current limit in ICO\_ILIM register would not be changed until the algorithm is forced to run by the following event (these events also reset the ICO\_STAT[1:0] bits to '01'):

1. A new input source is plugged-in, or EN\_HIZ bit is toggled
2. IINDPM register is changed
3. VINDPM register is changed
4. FORCE\_ICO bit is set to 1
5. VBUS\_OVP event

### 8.3.5 Buck Mode Operation from Battery (OTG)

The device supports buck converter operation to deliver power from the battery to other portable devices through USB port. The buck mode output current rating meets the USB On-The-Go 500 mA (OTG\_ILIM bits = 000) output requirement. The maximum output current is up to 2.0 A. The buck operation can be enabled if the following conditions are valid:

1. BAT above  $V_{OTG\_BAT}$
2. VBUS less than  $V_{VBUS\_PRESENT}$
3. ADC is enabled
4. Buck mode operation is enabled (EN\_OTG = 1 and EN\_CHG = 0)
5. Voltage at TS (thermistor) pin is within range configured by Buck Mode Temperature Monitor as configured by BHOT and BCOLD register bits
6. After 30 ms delay from buck mode enable

In buck mode, the device employs 1.5 MHz step-down switching regulator based on system requirements. During buck mode, the status register VBUS\_STAT bits are set to 111, the VBUS output is 5.1V by default (selectable via OTG\_VLIM register bits) and the output current can reach up to 2.0 A, selected via I2C (OTG\_ILIM bits). The buck output is maintained when BAT is above  $V_{OTG\_BAT}$  threshold, and VBUS is above  $V_{VBUS\_PRESENT}$  threshold. After OTG startup, the ADC maybe disabled.

### 8.3.6 Power Path Management

The device accommodates a wide range of input sources from USB, to wall adapter, to power bank. The device provides automatic power path selection to supply the system (SYS) from input source (VBUS), battery (BAT), or both.

#### 8.3.6.1 Narrow VDC Architecture

The device deploys Narrow VDC architecture (NVDC) with BATFET separating system from battery. The minimum system voltage is set by SYS\_MIN bits. Even with a fully depleted battery, the system is regulated above the minimum system voltage (default 6.2V).

When the battery is below minimum system voltage setting, the BATFET operates in linear mode (LDO mode), and the system is typically 200mV above the minimum system voltage setting. As the battery voltage rises above the minimum system voltage, BATFET is fully on and the voltage difference between the system and battery is the  $V_{DS}$  of BATFET.

When the battery charging is disabled and VBAT is above minimum system voltage setting or charging is terminated, the system is always regulated at typically 50mV above battery voltage. The status register VSYS\_STAT bit goes high when the system is in minimum system voltage regulation.

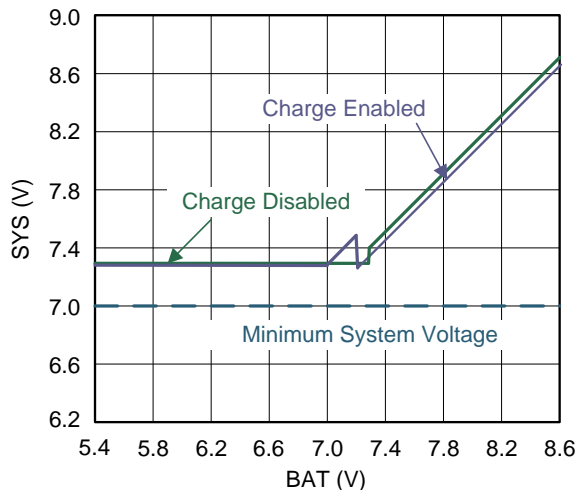

☒ 17. System Voltage vs. Battery Voltage

### 8.3.6.2 Dynamic Power Management

To meet the maximum current limit in the USB spec and avoid over loading the adapter, the device features Dynamic Power Management (DPM), which continuously monitors the input current and input voltage. When input source is over-loaded, either the current exceeds the input current limit (IINDPM or ICO\_ILIM or ILIM pin setting) or the voltage falls below the input voltage limit (VINDPM). The device then reduces the charge current until the input current falls below the input current limit and the input voltage rises above the input voltage limit.

When the charge current is reduced to zero, but the input source is still overloaded, the system voltage starts to drop. Once the system voltage falls below the battery voltage, the device automatically enters the Supplement Mode where the BATFET turns on and battery starts discharging so that the system is supported from both the input source and battery.

During DPM mode, the status register bits VINDPM\_STAT (VINDPM) and/or IINDPM\_STAT (IINDPM) go high. The figure shows the DPM response with 5V/3A adapter, 6.4V battery, 1.5A charge current and 6.8V minimum system voltage setting.

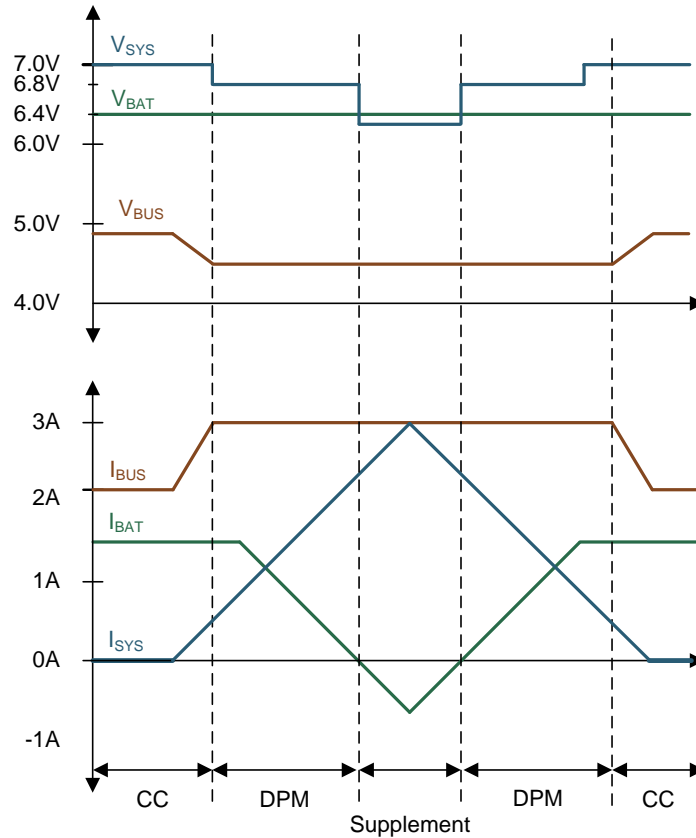
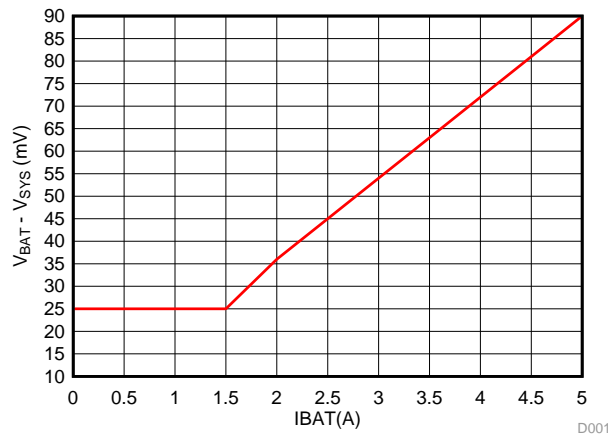

**Figure 18. DPM Response**

**8.3.6.3 Supplement Mode**

When the voltage falls below the battery voltage, the BATFET turns on.

As the discharge current increases, the BATFET gate is regulated with a higher voltage to reduce  $R_{DS(on)}$  until the BATFET is in full conduction. At this point onwards, the BATFET  $V_{DS}$  linearly increases with discharge current. The figure shows the V-I curve of the BATFET gate regulation operation. BATFET turns off to exit Supplement Mode when the battery is below battery depletion threshold ( $V_{BAT\_UVLO\_RISING}$ ).



**Figure 19. BATFET I-V Curve**

### 8.3.7 Battery Charging Management

The BQ25883 charges 2-cell Li-Ion battery with up to 2.2-A charge current for high capacity battery. The low  $R_{DS(ON)}$  BATFET improves charging efficiency and minimize the voltage drop during discharging.

#### 8.3.7.1 Autonomous Charging Cycle

When battery charging is enabled (EN\_CHG bit =1 and  $\overline{CE}$  pin is LOW; ), the device autonomously completes a charging cycle without host involvement. The device default charging parameters are listed in Table below. On BQ25883, the host can always control the charging operation and optimize the charging parameters by writing to the corresponding registers through I<sup>2</sup>C.

**表 5. Charging Parameter Default Settings**

DEFAULT MODE	BQ25883
Charging Voltage	8.40 V
Charging Current	1.50 A
Pre-Charge Current	150 mA
Termination Current	150 mA
Temperature Profile	JEITA
Safety Timer	12 hours
Topoff Timer	Disabled

A new charge cycle starts when the following conditions are valid:

1. Converter starts
2. Battery charging is enabled by I2C register bit (EN\_CHG = 1 and  $\overline{CE}$  pin is LOW and ICHG register is not 0 mA)
3. No thermistor fault on TS
4. No safety timer fault

The charger device automatically terminates the charging cycle when the charging current is below termination threshold, charge voltage is above recharge threshold, and device is not in DPM mode or thermal regulation. When a full battery voltage is discharged below recharge threshold (threshold selectable via VRECHG[1:0] bits on BQ25883), the device automatically starts a new charging cycle. After the charge is done, either toggle  $\overline{CE}$  pin or EN\_CHG bit can initiate a new charging cycle.

The STAT output indicates the charging status of: charging (LOW), charging complete or charge disable (HIGH) or charging fault (Blinking). If no battery is connected, the STAT pin blinks as capacitance connected at BAT charges, discharges, then recharges. The STAT output can be disabled by setting STAT\_DIS bit. In addition, the status register (CHRG\_STAT) indicates the different charging phases as:

- 000 – Not Charging
- 001 – Trickle Charge ( $V_{BAT} < V_{BAT\_SHORT}$ )
- 010 – Pre-charge ( $V_{BAT\_SHORT} < V_{BAT} < V_{BAT\_LOWV}$ )
- 011 – Fast-charge (CC mode)
- 100 – Taper Charge (CV mode)
- 101 – Top-off Timer Charging
- 110 – Charge Termination Done

#### 8.3.7.2 Battery Charging Profile

The device charges the battery in five phases: trickle charge, pre-charge, constant current, constant voltage, and top-off timer charging. At the beginning of a charging cycle, the device checks the battery voltage and regulates current/voltage accordingly.

**表 6. Default Charging Current Setting**

VBAT	CHARGING CURRENT	REGISTER DEFAULT SETTING	CHRG_STAT
$< V_{BAT\_SHORT}$	$I_{BAT\_SHORT}$	100 mA	001
$V_{BAT\_SHORT} - V_{BAT\_LOWV}$	$I_{PRECHG}$	150 mA	010

**表 6. Default Charging Current Setting (continued)**

VBAT	CHARGING CURRENT	REGISTER DEFAULT SETTING	CHRG_STAT
$> V_{BAT\_LOWV}$	$I_{CHG}$	1500 mA	011

If the charger device is in DPM regulation or thermal regulation during charging, the actual charging current will be less than the programmed value. In this case, termination is temporarily disabled and the charging safety timer is counted at half the clock rate, as explained in the [Charging Safety Timer](#) section.

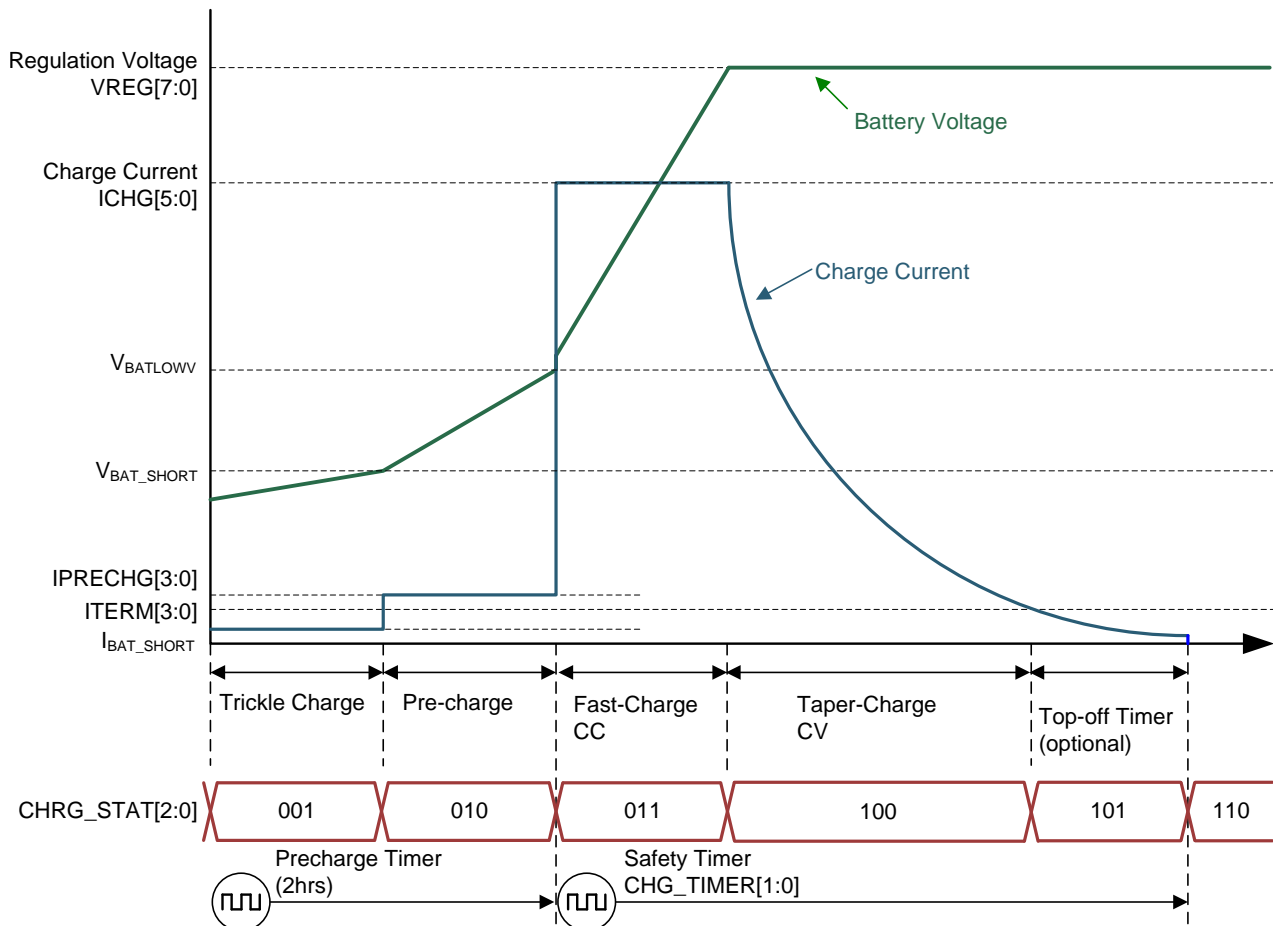
**图 20. Battery Charging Profile**

### 8.3.7.3 Charging Termination

The device terminates a charge cycle when the battery voltage is above recharge threshold, and the current is below termination current. After the charging cycle is completed, the BATFET turns off. The converter keeps running to power the system, and BATFET can turn on again to engage Supplement Mode.

When termination occurs, the STAT pin goes HIGH (charge current will continue to taper if top-off timer is enabled), status register CHRG\_STAT is set to 110, and an INT pulse is asserted to the host. Termination is temporarily disabled when the charger device is in input current, voltage or thermal regulation. Termination can be permanently disabled by writing 0 to EN\_TERM bit prior to charge termination.

At low termination currents (50mA-100mA), due to the comparator offset, the actual termination current may be up to 20% higher than the termination target. In order to compensate for comparator offset, a programmable top-off timer (default disabled) can be applied after termination is detected. The top-off timer will follow safety timer constraints, such that if safety timer is suspended, so will the top-off timer. Similarly, if safety timer is doubled, so will the top-off timer. CHRG\_STAT reports whether the top off timer is active via the 101 code. Once the Top-Off timer expires, the CHRG\_STAT register is set to 110 and an INT pulse is asserted to the host.

Top-off timer gets reset (set to 0 and counting resumes when appropriate) for any of the following conditions:

1. Charge disable to enable
2. Termination status low to high
3. REG\_RST register bit is set (disables top-off timer)

The top-off timer settings are read in once termination is detected by the charger. Programming a top-off timer value after termination will have no effect unless a recharge cycle is initiated. An INT is asserted to the host when entering top-off timer segment as well as when top-off timer expires. All charge cycle related INT pulses (including top-off timer INT pulses) can be masked by CHRГ\_MASK bit.

**8.3.7.4 Thermistor Qualification**

The charger device provides a single thermistor input for battery temperature monitor.

**8.3.7.4.1 JEITA Guideline Compliance in Charge Mode**

To improve the safety of charging Li-ion batteries, JEITA guideline was released on April 20, 2007. The guideline emphasized the importance of avoiding a high charge current and high charge voltage at certain low and high temperature ranges.

To initiate a charge cycle, the voltage on TS pin must be within the VT1 to VT5 thresholds. If TS voltage exceeds the T1-T5 range, the controller suspends charging and waits until the battery temperature is within the T1 to T5 range. At cool temperature (T1-T2), JEITA recommends the charge current to be reduced to half of the charge current or lower. At warm temperature (T3-T5), JEITA recommends charge voltage less than 4.1V / cell.

On BQ25883, the charger provides flexible voltage/current settings beyond the JEITA requirement. The voltage setting at warm temperature (T3-T5) can be VREG, 8.0V, 8.3V, or charge suspend (configured by JEITA\_VSET [1:0]). The fast charge current setting at warm temperature (T3-T5) can be 100%, or 40% of fast charge current, ICHG (configured by JEITA\_ISETH). The fast charge current setting at cool temperature (T1-T2) can be 100%, 40%, or 20% of fast charge current, ICHG, or charge suspend (configured by JEITA\_ISETC[1:0]). Whenever the charger detects "warm" or "cool" temperature, termination is automatically disabled regardless of JEITA\_VSET, JEITA\_ISETH and JEITA\_ISETC register bit settings.

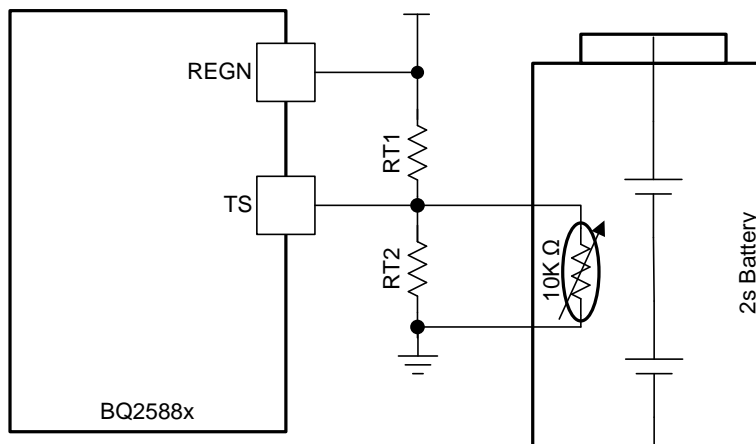

21. TS Resistor Network

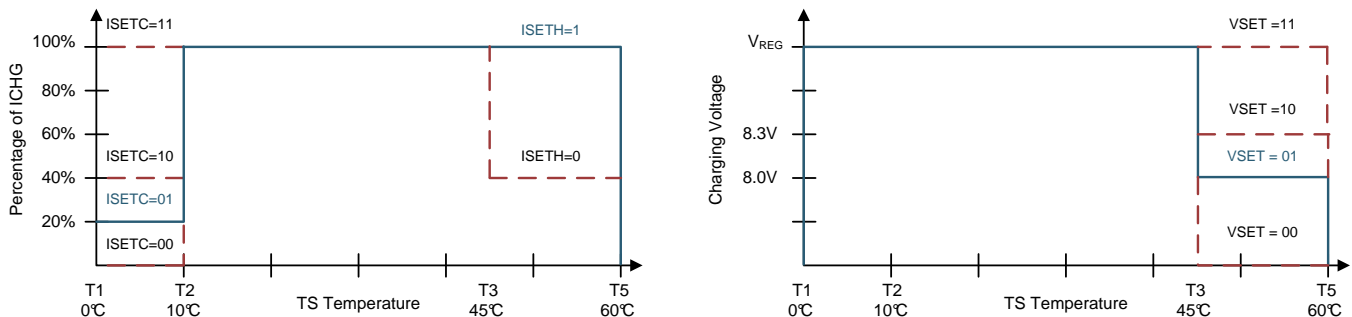

## ✎ 22. TS Charging Values

Assuming a 103AT NTC (Negative Temperature Coefficient) thermistor on the battery pack as shown above, the value of RT1 and RT2 can be determined by:

$$RT2 = \frac{R_{NTC,T1} \times R_{NTC,T5} \times \left( \frac{1}{V_{T5}} - \frac{1}{V_{T1}} \right)}{R_{NTC,T1} \times \left( \frac{1}{V_{T1}} - 1 \right) - R_{NTC,T5} \times \left( \frac{1}{V_{T5}} - 1 \right)} \quad (1)$$

$$RT1 = \frac{\frac{1}{V_{T1}} - 1}{\frac{1}{R_{T2}} + \frac{1}{R_{NTC,T1}}} \quad (2)$$

Select 0°C to 60°C range for Li-ion or Li-polymer battery:

$$R_{NTC,T1} = 27.28k\Omega$$

$$R_{NTC,T5} = 3.02k\Omega$$

$$RT1 = 5.24k\Omega$$

$$RT2 = 30.31k\Omega$$

### 8.3.7.4.2 Cold/Hot Temperature Window in OTG Buck Mode

For battery protection during OTG buck mode, the device monitors the battery temperature to be within the VBCOLD to VBHOT thresholds. When temperature is outside of the temperature thresholds, the OTG mode is suspended. In addition, VBUS\_STAT bits are set to 000 and corresponding TS\_STAT is reported. Once temperature returns within thresholds, the OTG mode is recovered and TS\_STAT is cleared.

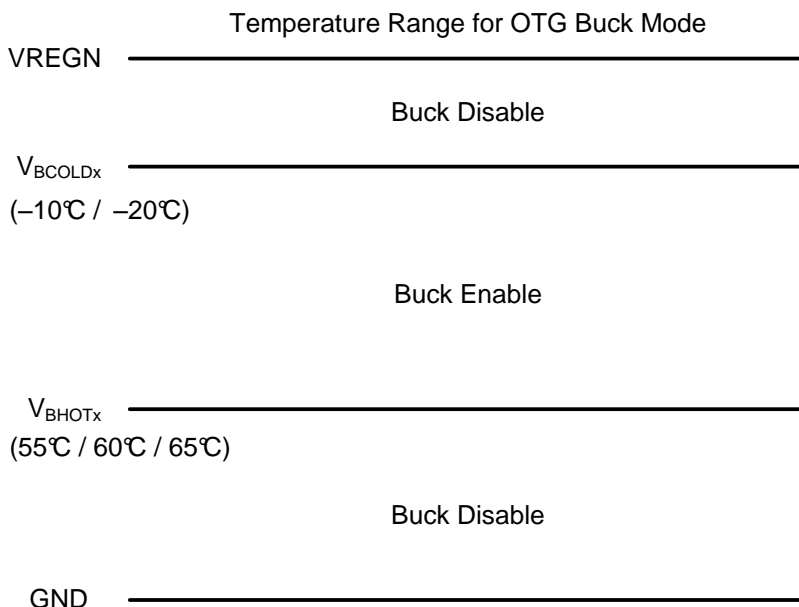

## ✎ 23. TS Pin Thermistor Sense Threshold in OTG Buck Mode

### 8.3.7.5 Charging Safety Timer

The device has built-in safety timer to prevent extended charging cycle due to abnormal battery conditions. The user can program fast charge safety timer through I<sup>2</sup>C (CHG\_TIMER bits). When safety timer expires, the fault register TMR\_STAT bit is set to 1, and an INT pulse is asserted to the host. The safety timer feature can be disabled by clearing EN\_TIMER bit.

During input voltage, current or thermal regulation, the safety timer counts at half clock rate as the actual charge current is likely to be below the register setting. For example, if the charger is in input current regulation (IINDPM\_STAT=1) throughout the whole charging cycle, and the safety timer is set to 12 hours, then the timer will expire in 24 hours. This half clock rate feature can be disabled by setting TMR2X\_EN = 0. Changing the TMR2X\_EN bit while the device is running has no effect on the safety timer count, other than forcing the timer to count at half the rate under the conditions dictated above.

During faults which disable charging, or supplement mode, timer is suspended. Since the timer is not counting in this state, the TMR2X\_EN bit has no effect. Once the fault goes away, safety timer resumes. If the charging cycle is stopped and started again, the timer gets reset (toggle CE pin or EN\_CHG bit restarts the timer).

The safety timer is reset for the following events:

1. Charging cycle stop and restart (toggle CE pin, EN\_CHG bit, or charged battery falls below recharge threshold).
2. BAT voltage changes from pre-charge to fast-charge or vice versa (in host-mode or default mode).

The precharge safety timer (fixed 2hr counter that runs when VBAT < V<sub>BAT\_LOWV</sub>), follows the same rules as the fast-charge safety timer in terms of getting suspended, reset, and counting at half-rate when TMR2X\_EN is set.

### 8.3.8 Integrated 16-Bit ADC for Monitoring

The device includes a 16-bit ADC to monitor critical system information based on the device's modes of operation. The control of the ADC is done through the [ADC Control Register \(Address = 15h\) \[reset = 30h\]](#). The ADC\_EN bit provides the ability to enable and disable the ADC to conserve power. The ADC\_RATE bit allows continuous conversion or one-shot behavior. After a one-shot conversion finishes, the ADC\_EN bit is cleared, and must be re-asserted to start a new conversion.

To enable the ADC, the ADC\_EN bit must be set to '1'. The ADC is allowed to operate if either the  $V_{VBUS} > V_{VBUS\_UVLO\_RISING}$  or  $V_{BAT} > V_{BAT\_UVLO\_RISING}$  is valid. If no adapter is present, and the VBAT is less than V<sub>BAT\_UVLO\_RISING</sub>, the device will not perform an ADC measurement, nor update the ADC read-back values in REG17 through REG24. Additionally, the device will immediately reset ADC\_EN bit without sending any interrupt. The same will happen if the ADC is enabled when all ADC channels are disabled. It is recommended to read back ADC\_EN after setting it to '1' to ensure ADC is running a conversion. If the charger changes mode (for example, if adapter is connected, EN\_HIZ goes to '1', or EN\_OTG goes to '1') while an ADC conversion is running, the conversion is interrupted. Once the mode change is complete, the ADC resumes conversion, starting with the channel where it was interrupted. When device is in HIZ mode, ADC conversion can still be enabled through I2C. In HIZ mode, device power up internally to start ADC conversion and turn back down when ADC conversion is completed.

When TS\_ADC conversion performs in battery only mode, the REGN is powered and extra battery current would be drawn. Battery current can be kept low by disabling the TS\_ADC conversion in battery only mode.

The integrated ADC has two rate conversion options: a one-shot mode and a continuous conversion mode set by the ADC\_RATE bit. By default, all ADC parameters will be converted in one-shot or continuous conversion mode unless disabled in the [ADC Function Disable Register \(Address = 16h\) \[reset = 00h\]](#). If an ADC parameter is disabled by setting the corresponding bit in REG16, then the read-back value in the corresponding register will be from the last valid ADC conversion or the default POR value (all zeros if no conversions have taken place). If an ADC parameter is disabled in the middle of an ADC measurement cycle, the device will finish the conversion of that parameter, but will not convert the parameter starting the next conversion cycle. Even though no conversion takes place when all ADC measurement parameters are disabled, the ADC circuitry is active and ready to begin conversion as soon as one of the bits in the ADC Function Disable register is set to '0'. If all channels are disabled in one-shot conversion mode, the ADC\_EN bit is cleared.

The ADC\_DONE\_STAT and ADC\_DONE\_FLAG bits signal when a conversion is completed in one-shot mode only. This event produces an INT pulse, which can be masked with ADC\_DONE\_MASK. During continuous conversion mode, the ADC\_DONE\_STAT bit has no meaning and will be '0'. The ADC\_DONE\_FLAG bit will remain unchanged in continuous conversion mode.

ADC conversion operates independently of the faults present in the device. ADC conversion will continue even after a fault has occurred (such as one that causes the power stage to be disabled), and the host must set `ADC_EN = '0'` to disable the ADC. ADC conversion is interrupted upon adapter plug-in, and will only resume until after Input Source Type Detection is complete. ADC readings are only valid for DC states and not for transients. When host writes `ADC_EN=0`, the ADC stops immediately, and ADC measurement values correspond to last valid ADC reading.

A recommended method to exit ADC conversion is described below:

1. Write `ADC_RATE` to one-shot, and the ADC will stop at the end of a complete cycle of conversions, or
2. Disable all ADC conversion channels, and the ADC will stop at the end of the current measurement.

### 8.3.9 Status Outputs

#### 8.3.9.1 Power Good Indicator ( $\overline{PG}$ )

The `PG_STAT` bit goes HIGH and open drain  $\overline{PG}$  pin goes low to indicate a good input source when:

1.  $V_{BUS}$  above  $V_{V_{BUS\_UVLO\_RISING}}$
2.  $V_{BUS}$  below  $V_{V_{BUS\_OV}}$  threshold
3.  $V_{BUS}$  above  $V_{POORSRC}$  (typ. 3.7 V) when  $I_{POORSRC}$  (typ. 30 mA) current is applied (not a poor source)
4. Input Source Type Detection is completed

#### 8.3.9.2 Charging Status Indicator (`STAT`)

The device indicates charging state on the open drain `STAT` pin. The `STAT` pin can drive LED.

**表 7. STAT Pin State**

CHARGING STATE	STAT INDICATOR
Charging in progress (including trickle charge, pre-charge, fast-charge, recharge)	LOW
Charging complete (including top-off)	HIGH
Sleep mode, charge disable	HIGH
Charge suspend (Input over-voltage, TS fault, timer fault or battery over-voltage) OTG Buck Mode suspend (due to TS fault)	Blinking at 1Hz

#### 8.3.9.3 Interrupt to Host

In some applications, the host does not always monitor the charger operation. The  $\overline{INT}$  pin notifies the system host on the device operation. By default, the following events will generate an active-low, 256 $\mu$ s  $\overline{INT}$  pulse.

1. Good input source detected
  - $V_{V_{BUS}} < V_{V_{BUS\_OV}}$  threshold
  - $V_{V_{BUS}} > V_{POORSRC}$  (typ. 3.7 V) when  $I_{POORSRC}$  (typ. 30 mA) current is applied (not a poor source)
2. `VBUS_STAT` changes state (`VBUS_STAT` any bit change)
3. Good input source removed
4. Entering IINDPM regulation
5. Entering VINDPM regulation
6. Entering IC junction temperature regulation (TREG)
7. I2C Watchdog timer expired
  - At initial power up, this  $\overline{INT}$  gets asserted to signal I2C is ready for communication
8. Charger status changes state (`CHRG_STAT` value change), including Charge Complete
9. `TS_STAT` changes state (`TS_STAT` any bit change)
10.  $V_{BUS}$  over-voltage detected (`VBUS_OVP`)
11. Junction temperature shutdown (TSHUT)
12. Battery over-voltage detected (`BATOVP`)

- 13. Charge safety timer expired
- 14. A rising edge on any of the \*\_STAT bits

Each one of these  $\overline{\text{INT}}$  sources can be masked off to prevent  $\overline{\text{INT}}$  pulses from being sent out when they occur. Three bits exist for each one of these events:

- The STAT bit holds the *current status* of each  $\overline{\text{INT}}$  source
- The FLAG bit holds information on which source produced an  $\overline{\text{INT}}$ , regardless of the current status
- The MASK bit is used to prevent the device from sending out  $\overline{\text{INT}}$  for each particular event

When one of the above conditions occurs (a rising edge on any of the \*\_STAT bits), the device sends out an  $\overline{\text{INT}}$  pulse and keeps track of which source generated the  $\overline{\text{INT}}$  via the FLAG registers. The FLAG register bits are automatically reset to zero after the host reads them, and a new edge on STAT bit is required to re-assert the FLAG.

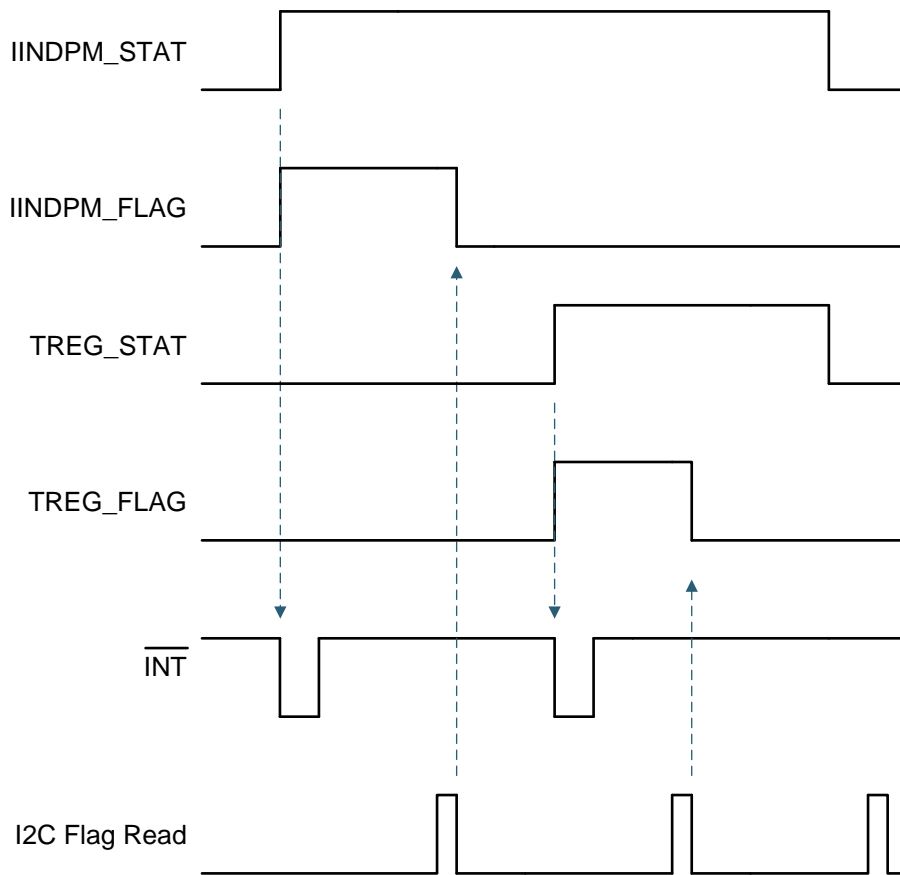

Figure 24.  $\overline{\text{INT}}$  Generation Behavior Example

### 8.3.10 Input Current Limit on ILIM Pin

For safe operation, the BQ2588x has an additional hardware pin on ILIM to limit maximum input current. The maximum input current is set by a resistor from ILIM pin to ground as:

$$I_{\text{INMAX}} = \frac{K_{\text{ILIM}}}{R_{\text{ILIM}}} \quad (3)$$

The actual input current limit is the lower value between ILIM pin setting and register setting (IINDPM). For example, if the register setting is 3.3A (0x1C), and ILIM has a 820-Ω resistor (KILIM = 1276 max) to ground for 1.55A, the input current limit is 1.55A. ILIM pin can be used to set the input current limit rather than the register settings when EN\_ILIM bit is set. The device regulates ILIM pin at 0.8V. If ILIM voltage exceeds 0.8V, the device enters input current regulation (Refer to [Dynamic Power Management](#) section). Entering IINDPM through ILIM pin sets the IINDPM\_STAT and FLAG bits, and produces an interrupt to host. The interrupt can be masked via the IINDPM\_MASK bit.

The ILIM pin can also be used to monitor input current when EN\_ILIM is set. The voltage on ILIM pin is proportional to the input current. ILIM can be used to monitor input current with the following relationship:

$$I_{IN} = \frac{K_{ILIM} \times V_{ILIM}}{R_{ILIM} \times 0.8V} \quad (4)$$

For example, if ILIM pin is set with 820-Ω resistor, and the ILIM voltage 0.5V, the actual input current is 0.795A to 0.973A. If ILIM pin is open, the input current is limited to zero since ILIM voltage floats above 0.8V. If ILIM pin is shorted, the input current limit is set by the register.

The ILIM pin function can be disabled by setting the EN\_ILIM bit to 0. When the pin is disabled, both input current limit function and monitoring function are not available.

### 8.3.11 Voltage and Current Monitoring

The device closely monitors the input voltage and system voltage, as well as internal FET currents for safe boost and buck mode operation.

#### 8.3.11.1 Voltage and Current Monitoring in Boost Mode

##### 8.3.11.1.1 Input Over-Voltage Protection

The valid input voltage range for boost mode operation is  $V_{VBUS\_OP}$ . If VBUS voltage exceeds  $V_{VBUS\_OV}$ , the device stops switching immediately to protect the power FETs. During input over-voltage, an INT pulse is asserted to signal the host, and the VBUS\_OVP\_STAT and VBUS\_OVP\_FLAG registers get set. The device automatically starts switching again when the over-voltage condition goes away.

##### 8.3.11.1.2 Input Under-Voltage Protection

The valid input voltage range for boost mode operation is  $V_{VBUS\_OP}$ . If VBUS voltage falls below  $V_{POORSRC}$  during operation, the device stops switching. During input under-voltage, an INT pulse is asserted to signal the host, and the PG\_STAT bit gets cleared. The PG\_FLAG bit will get set to signal this event. The device automatically attempts to restart switching when the under-voltage condition goes away.

##### 8.3.11.1.3 System Over-Voltage Protection

The charger device clamps the system voltage during load transient so that the components connect to system would not be damaged due to high voltage. SYSOVP threshold is 350 mV above system regulation voltage. Upon SYSOVP, converter stops immediately to clamp the overshoot.

##### 8.3.11.1.4 System Over-Current Protection

The charger device continually monitors and compares VBUS to VSYS to protect against a system short-circuit event. In the event that VSYS drops to within 250 mV of VBUS during operation, a short circuit event is flagged and the converter stops switching. The SYS\_SHORT\_FLAG or SNS\_SHORT\_FLAG bit is set and an INT pulse is asserted to the host. The device attempts to recover from this condition automatically.

#### 8.3.11.2 Voltage and Current Monitoring in OTG Buck Mode

The device closely monitors the VBUS voltage, as well as RBFET (Q1, QBLK) and LSFET (Q3, QLS) current to ensure safe buck mode operation.

##### 8.3.11.2.1 VBUS Over-voltage Protection

When the VBUS voltage rises above regulation target and exceeds  $V_{OTG\_OVP}$ , the device enters over-voltage protection which stops switching, clears the EN\_OTG bit and exits buck mode. During the over-voltage duration, the OTG\_FLAG bits are set high to indicate a fault in buck mode operation. An INT is also asserted to the host.

### 8.3.11.2.2 VBUS Over-Current Protection

The device monitors output current to provide output short protection. The OTG buck mode has built-in constant current regulation to allow OTG to adapt to various types of loads. If short circuit is detected on VBUS, the OTG turns off and retries 7 times. If the retries are not successful, OTG is disabled with EN\_OTG bit cleared. In addition OTG\_FLAG bits are set high to indicate the fault, and an  $\overline{\text{INT}}$  is asserted to the host.

### 8.3.12 Thermal Regulation and Thermal Shutdown

#### 8.3.12.1 Thermal Protection in Boost Mode

The device monitors internal junction temperature,  $T_J$ , to avoid overheating and limits the IC surface temperature in boost mode. When the internal junction temperature exceeds the preset thermal regulation limit (TREG bits), the device reduces charge current. A wide thermal regulation range from 60°C to 120°C allows optimization for the system thermal performance.

During thermal regulation, the actual charging current is usually below the programmed value in ICHG registers. Therefore, termination is disabled, the safety timer runs at half the clock rate, the status register TREG\_STAT bit goes high, and an  $\overline{\text{INT}}$  is asserted to the host.

Additionally, the device has thermal shutdown to turn off the converter when IC surface temperature exceeds  $T_{\text{SHUT}}$ . The fault register bits TSHUT\_STAT and TSHUT\_FLAG are set and an  $\overline{\text{INT}}$  pulse is asserted to the host. The converter turns back on when IC temperature is below  $T_{\text{SHUT\_HYS}}$ .

#### 8.3.12.2 Thermal Protection in OTG Buck Mode

The BQ2588x monitors the internal junction temperature to provide thermal shutdown during OTG buck mode.

### 8.3.13 Battery Protection

#### 8.3.13.1 Battery Over-Voltage Protection (BATOVP)

The battery over-voltage limit is clamped at 4% above the battery regulation voltage while charging. When battery over-voltage occurs, the charger device immediately disables charge. The fault register BATOVP\_STAT bit goes high and an  $\overline{\text{INT}}$  pulse is asserted to signal the host. The battery regulation voltage can be changed by JEITA\_VSET bits and battery temperature, but BATOVP set point will not change.

#### 8.3.13.2 Battery Over-Discharge Protection

When the battery is discharged below  $V_{\text{BAT\_SHORT\_HYS}}$ , the BATFET is turned off to protect battery from over-discharge. To recover from over-discharge, an input source is required at VBUS. When an input source is plugged in, the BATFET turns on. The battery is charged with  $I_{\text{BAT\_SHORT}}$  current when the  $V_{\text{BAT}} < V_{\text{BAT\_SHORT}}$ , or pre-charge current as set in IPRECHG registers when the battery voltage is between  $V_{\text{BAT\_SHORT}}$  and  $V_{\text{BAT\_LOWV}}$ .

### 8.3.14 Serial Interface

The device uses I2C compatible interface for flexible charging parameter programming and instantaneous device status reporting. I2C is a bi-directional 2-wire serial interface. Only two open-drain bus lines are required: a serial data line (SDA), and a serial clock line (SCL). Devices can be considered as masters or slaves when performing data transfers. A master is a device which initiates a data transfer on the bus and generates the clock signals to permit that transfer. At that time, any device addressed is considered a slave.

The device operates as a slave device with address 0x6B, receiving control inputs from the master device like micro-controller or digital signal processor through REG00 – REG25. Register read beyond REG25 (0x25), returns 0xFF. The I2C interface supports both standard mode (up to 100kbits/s), and fast mode (up to 400kbits/s). When the bus is free, both lines are HIGH. The SDA and SCL pins are open drain and must be connected to the positive supply voltage via a current source or pull-up resistor.

#### 8.3.14.1 Data Validity

The data on the SDA line must be stable during the HIGH period of the clock. The HIGH or LOW state of the data line can only change when the clock signal on SCL line is LOW. One clock pulse is generated for each data bit transferred.

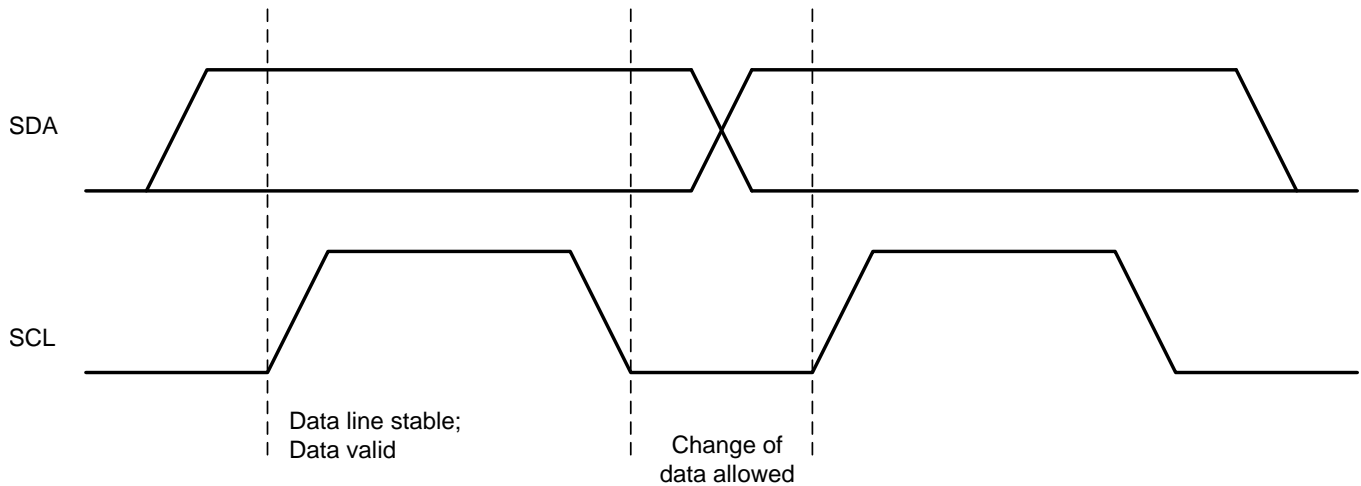

Figure 25. Bit Transfers on the I2C bus

### 8.3.14.2 START and STOP Conditions

All transactions begin with a START (S) and are terminated with a STOP (P). A HIGH to LOW transition on the SDA line while SCL is HIGH defines a START condition. A LOW to HIGH transition on the SDA line when the SCL is HIGH defines a STOP condition.

START and STOP conditions are always generated by the master. The bus is considered busy after the START condition, and free after the STOP condition.

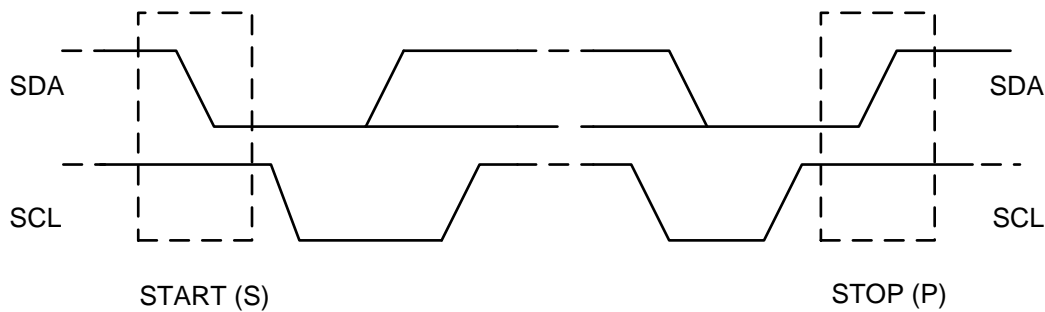

Figure 26. START and STOP conditions on the I2C bus

### 8.3.14.3 Byte Format

Every byte on the SDA line must be 8 bits long. The number of bytes to be transmitted per transfer is unrestricted. Each byte has to be followed by an ACKNOWLEDGE (ACK) bit. Data is transferred with the Most Significant Bit (MSB) first. If a slave cannot receive or transmit another complete byte of data until it has performed some other function, it can hold the SCL line low to force the master into a wait state (clock stretching). Data transfer then continues when the slave is ready for another byte of data and releases the SCL line.

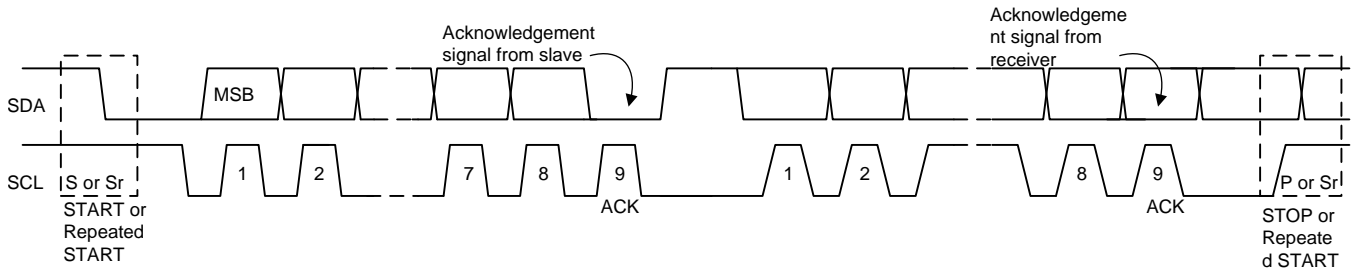

Figure 27. Data Transfer on the I2C Bus

**8.3.14.4 Acknowledge (ACK) and Not Acknowledge (NACK)**

The ACK signaling takes place after byte. The ACK bit allows the receiver to signal the transmitter that the byte was successfully received and another byte may be sent. All clock pulses, including the acknowledge 9<sup>th</sup> clock pulse, are generated by the master.

The transmitter releases the SDA line during the acknowledge clock pulse so the receiver can pull the SDA line LOW and it remains stable LOW during the HIGH period of this 9<sup>th</sup> clock pulse.

A NACK is signaled when the SDA line remains HIGH during the 9<sup>th</sup> clock pulse. The master can then generate either a STOP to abort the transfer or a repeated START to start a new transfer.

**8.3.14.5 Slave Address and Data Direction Bit**

After the START signal, a slave address is sent. This address is 7 bits long, followed by the 8 bit as a data direction bit (bit R/W). A zero indicates a transmission (WRITE) and a one indicates a request for data (READ). The device 7-bit address is defined as 1101 011' (0x6B) by default. The address bit arrangement is shown below.

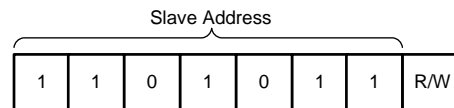

Figure 28. 7-Bit Addressing (0x6B)

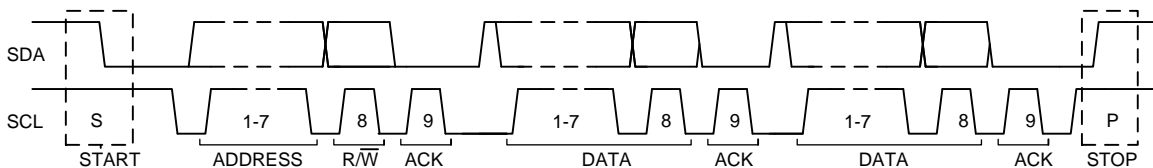

Figure 29. Complete Data Transfer on the I2C Bus

**8.3.14.6 Single Write and Read**

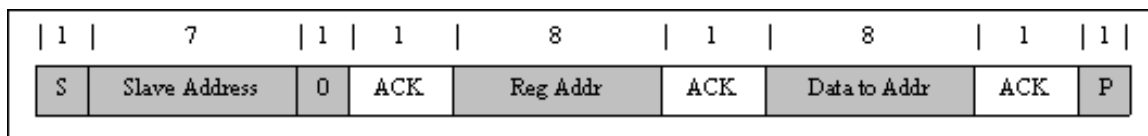
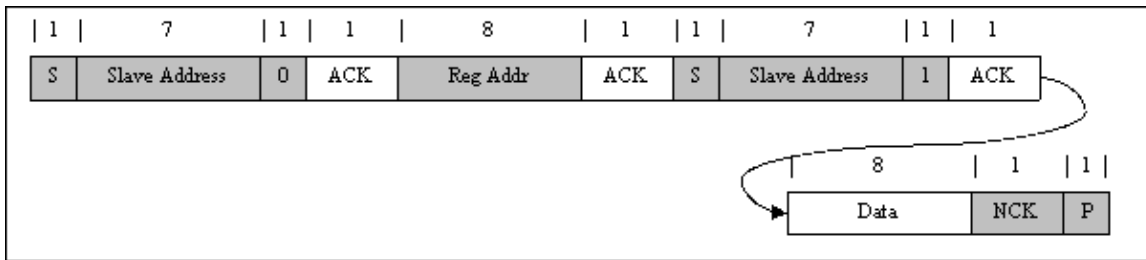

Figure 30. Single Write

**图 31. Single Read**

If the register address is not defined, the charger IC sends back NACK and returns to the idle state.

### 8.3.14.7 Multi-Write and Multi-Read

The charger device supports multi-read and multi-write of all registers.

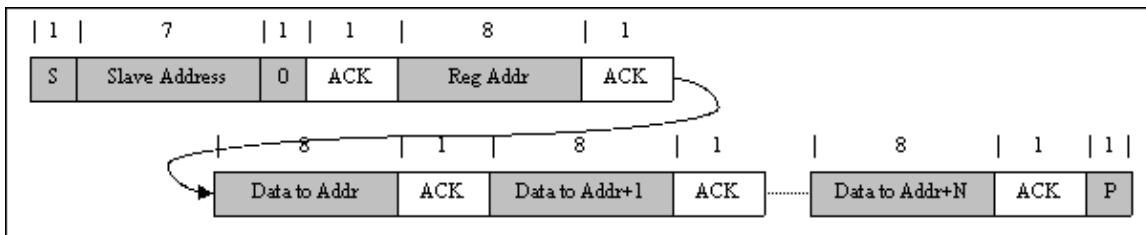
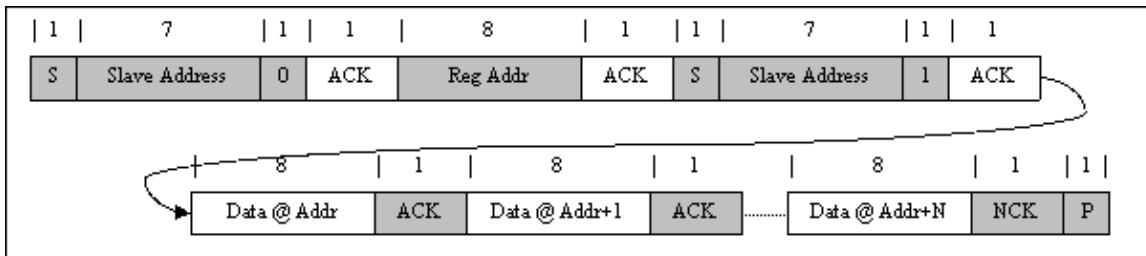
**图 32. Multi-Write**

**图 33. Multi-Read**

## 8.4 Device Functional Modes

### 8.4.1 Host Mode and Default Mode

The BQ2588x is a host controlled charger, but it can operate in default mode without host management. In default mode, the device can be used as an autonomous charger with no host or while host is in sleep mode. When the charger is in default mode, WD\_STAT bit is HIGH. When the charger is in host mode, WD\_STAT bit is LOW.

After power-on-reset, the device starts in default mode with watchdog timer expired, or default mode. All the registers are in the default settings.

In default mode, the device keeps charging the battery with default 12-hour fast charging safety timer. At the end of the 12-hour, the charging is stopped and the boost converter continues to operate to supply system load.

A I2C write to the registers transitions the charger from default mode to host mode and watchdog timer is reset. All the device parameters can be programmed by the host. To keep the device in host mode, the host has to reset the watchdog timer by writing 1 to WD\_RST bit before the watchdog timer expires (WD\_STAT bit is set), or disable watchdog timer by setting WATCHDOG bits=00.

### Device Functional Modes (continued)

When the watchdog timer (WD\_STAT bit = 1) is expired, the device returns to default mode and all registers are reset to default values except as detailed in the [Register Maps](#) section. The Watchdog timer will be reset on any write if the watchdog timer has expired.



图 34. Watchdog Timer Flow Chart

### 8.5 Register Maps

Default I2C Slave Address: 0x6B (1101 011B + R/W)

表 8. I<sup>2</sup>C Registers

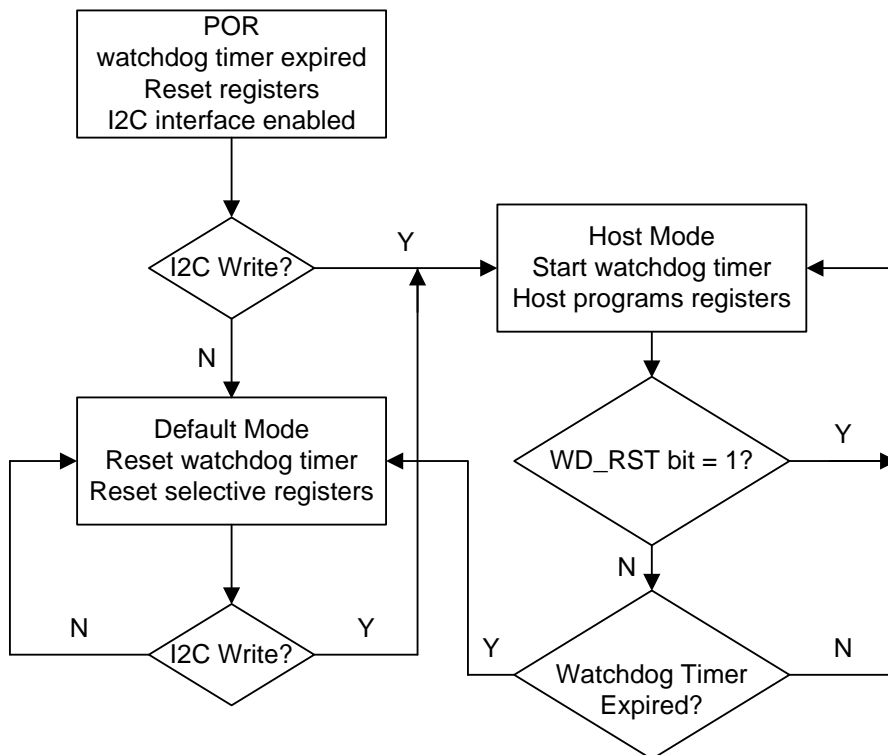
Address	Access Type	Acronym	Register Name	Section
00h	R/W	REG00	Battery Voltage Limit	<a href="#">Go</a>
01h	R/W	REG01	Charge Current Limit	<a href="#">Go</a>
02h	R/W	REG02	Input Voltage Limit	<a href="#">Go</a>
03h	R/W	REG03	Input Current Limit	<a href="#">Go</a>
04h	R/W	REG04	Precharge and Termination Control	<a href="#">Go</a>
05h	R/W	REG05	Charger Control 1	<a href="#">Go</a>
06h	R/W	REG06	Charger Control 2	<a href="#">Go</a>
07h	R/W	REG07	Charger Control 3	<a href="#">Go</a>
08h	R/W	REG08	Charger Control 4	<a href="#">Go</a>
09h	R/W	REG09	OTG Control	<a href="#">Go</a>
0Ah	R	REG0A	ICO Current Limit	<a href="#">Go</a>
0Bh	R	REG0B	Charger Status 1	<a href="#">Go</a>
0Ch	R	REG0C	Charger Status 2	<a href="#">Go</a>
0Dh	R	REG0D	NTC Status	<a href="#">Go</a>
0Eh	R	REG0E	FAULT Status	<a href="#">Go</a>

**表 8. I<sup>2</sup>C Registers (continued)**

Address	Access Type	Acronym	Register Name	Section
0Fh	R	REG0F	Charger Flag 1	<a href="#">Go</a>
10h	R	REG10	Charger Flag 2	<a href="#">Go</a>
11h	R	REG11	Fault Flag	<a href="#">Go</a>
12h	R/W	REG12	Charger Mask 1	<a href="#">Go</a>
13h	R/W	REG13	Charger Mask 2	<a href="#">Go</a>
14h	R/W	REG14	Fault Mask	<a href="#">Go</a>
15h	R/W	REG15	ADC Control	<a href="#">Go</a>
16h	R/W	REG16	ADC Function Disable	<a href="#">Go</a>
17h	R	REG17	IBUS ADC1	<a href="#">Go</a>
18h	R	REG18	IBUS ADC0	<a href="#">Go</a>
19h	R	REG19	ICHG ADC1	<a href="#">Go</a>
1Ah	R	REG1A	ICHG ADC0	<a href="#">Go</a>
1Bh	R	REG1B	VBUS ADC1	<a href="#">Go</a>
1Ch	R	REG1C	VBUS ADC0	<a href="#">Go</a>
1Dh	R	REG1D	VBAT ADC1	<a href="#">Go</a>
1Eh	R	REG1E	VBAT ADC0	<a href="#">Go</a>
1Fh	R	REG1F	VSYS ADC1	<a href="#">Go</a>
20h	R	REG20	VSYS ADC0	<a href="#">Go</a>
21h	R	REG21	TS ADC1	<a href="#">Go</a>
22h	R	REG22	TS ADC0	<a href="#">Go</a>
23h	R	REG23	TDIE ADC1	<a href="#">Go</a>
24h	R	REG24	TDIE ADC0	<a href="#">Go</a>
25h	R/W	REG25	Part Information	<a href="#">Go</a>

Complex bit access types are encoded to fit into small table cells. [表 9](#) shows the codes that are used for access types in this section.

**表 9. I<sup>2</sup>C Access Type Codes**

Access Type	Code	Description
<b>Read Type</b>		
R	R	Read
<b>Write Type</b>		
W	W	Write
<b>Reset Value</b>		
-n		Value after reset
-X		Undefined value

### 8.5.1 Battery Voltage Regulation Limit Register (Address = 00h) [reset = A0h]

REG00 is shown in [图 35](#) and described in [表 10](#).

Return to [Summary Table](#).

**图 35. REG00 Register**

Bit	7	6	5	4	3	2	1	0
Reset	A0h							
Field	VREG[7:0]							

**表 10. REG00 Register Field Descriptions**

Bit	Field	Type	Reset by REG_RST	Reset by WATCHDOG	Description
7	VREG[7]	R/W	Yes	Yes	1280 mV
6	VREG[6]	R/W	Yes	Yes	640 mV
5	VREG[5]	R/W	Yes	Yes	320 mV
4	VREG[4]	R/W	Yes	Yes	160 mV
3	VREG[3]	R/W	Yes	Yes	80 mV
2	VREG[2]	R/W	Yes	Yes	40 mV
1	VREG[1]	R/W	Yes	Yes	20 mV
0	VREG[0]	R/W	Yes	Yes	10 mV

Battery Charge voltage limit  
Offset: 6.80 V  
Range: 6.80 V to 9.20 V  
Default 8.40 V

### 8.5.2 Charger Current Limit Register (Address = 01h) [reset = 5Eh]

REG01 is shown in [图 36](#) and described in [表 11](#).

Return to [Summary Table](#).

**图 36. REG01 Register**

Bit	7	6	5	4	3	2	1	0
Reset	0h	1h	1Eh					
Field	EN_HIZ	EN_ILIM	ICHG[5:0]					

**表 11. REG01 Register Field Descriptions**

Bit	Field	Type	Reset by REG_RST	Reset by WATCHDOG	Description
7	EN_HIZ	R/W	Yes	Yes	Enable HIZ Mode: 0 – Disable (default) 1 – Enable
6	EN_ILIM	R/W	Yes	Yes	Enable ILIM Pin Function: 0 – Disable 1 – Enable (default)
5	ICHG[5]	R/W	Yes	Yes	1600 mA
4	ICHG[4]	R/W	Yes	Yes	800 mA
3	ICHG[3]	R/W	Yes	Yes	400 mA
2	ICHG[2]	R/W	Yes	Yes	200 mA
1	ICHG[1]	R/W	Yes	Yes	100 mA
0	ICHG[0]	R/W	Yes	Yes	50 mA

Fast Charge Current Limit  
Offset: 100 mA  
Range: 100mA – 2200mA  
Default 1500 mA  
Note: ICHG > 2.2A (2Ch) clamped to 2.2A. ICHG < 100mA (01h) clamped at 100mA

### 8.5.3 Input Voltage Limit Register (Address = 02h) [reset = 84h]

REG02 is shown in [图 37](#) and described in [表 12](#).

Return to [Summary Table](#).

**图 37. REG02 Register**

Bit	7	6	5	4	3	2	1	0
Reset	1h	0h	0h	04h				
Field	EN_VINDPM_RST	EN_BAT_DISCHG	PFM_OOA_DIS	VINDPM[4:0]				

**表 12. REG02 Register Field Descriptions**

Bit	Field	Type	Reset by REG_RST	Reset by WATCHDOG	Description	
7	EN_VINDPM_RST	R/W	Yes	Yes	Enable VINDPM automatic reset upon adapter plugin: 0 – Disable VINDPM reset when adapter is plugged in 1 – Enable VINDPM reset when adapter is plugged in (VINDPM resets to default value after Input Source Type Detection) (Default)	
6	EN_BAT_DISCHG	R/W	Yes	Yes	Enable BAT pin discharge load (IBAT_DISCHG): 0 – Disable load (Default) 1 – Enable BAT discharge load	
5	PFM_OOA_DIS	R/W	Yes	No	PFM Out-of-Audio (OOA) Mode Disable: 0 – Out-of-audio mode enabled while converter is in PFM (Default) 1 – Out-of-audio mode disabled while converter is in PFM	
4	VINDPM[4]	R/W	Yes	No	1600 mV	Absolute Input Voltage Limit: Offset: 3.9 V Range: 3.9V – 5.5V Default: 4.3 V Note: VINDPM > 5.5V (10h) clamped to 5.5V. VINDPM register is reset upon adapter plug-in if EN_VINDPM_RST = 1.
3	VINDPM[3]	R/W	Yes	No	800 mV	
2	VINDPM[2]	R/W	Yes	No	400 mV	
1	VINDPM[1]	R/W	Yes	No	200 mV	
0	VINDPM[0]	R/W	Yes	No	100 mV	

### 8.5.4 Input Current Limit Register (Address = 03h) [reset = 39h ]

REG03 is shown in [图 38](#) and described in [表 13](#).

Return to [Summary Table](#).

**图 38. REG03 Register**

Bit	7	6	5	4	3	2	1	0
Reset	0h	0h	1h	19h				
Field	FORCE_ICO	FORCE_INDET	EN_ICO	IINDPM[4:0]				

**表 13. REG03 Register Field Descriptions**

Bit	Field	Type	Reset by REG_RST	Reset by WATCHDOG	Description	
7	FORCE_ICO	R/W	Yes	Yes	Force Start Input Current Optimizer (ICO): 0 – Do not force ICO (default) 1 – Force ICO start Note: This bit can only be set and always returns 0 after ICO starts. This bit only valid when EN_ICO = 1.	
6	FORCE_INDET	R/W	Yes	Yes	Force D+/D– Detection: 0 – Not in D+/D– detection (default) 1 – Force D+/D– detection	
5	EN_ICO	R/W	Yes	No	Input Current Optimization (ICO) Algorithm Control: 0 – Disable ICO 1 – Enable ICO (default)	
4	IINDPM[4]	R/W	Yes	No	1600 mA	Input Current Limit: Offset: 500 mA Range: 500mA – 3300mA Default: 3000mA Note: IINDPM > 3300 mA (1Ch) clamped to 3300mA. Actual input current limit is lower of I2C, ICO_ILIM, ILIM pin or D+/D–.
3	IINDPM[3]	R/W	Yes	No	800 mA	
2	IINDPM[2]	R/W	Yes	No	400 mA	
1	IINDPM[1]	R/W	Yes	No	200 mA	
0	IINDPM[0]	R/W	Yes	No	100 mA	

### 8.5.5 Precharge and Termination Current Limit Register (Address = 04h) [reset = 22h]

REG04 is shown in [图 39](#) and described in [表 14](#).

Return to [Summary Table](#).

**图 39. REG04 Register**

Bit	7	6	5	4	3	2	1	0
Reset	2h				2h			
Field	IPRECHG[3:0]				ITERM[3:0]			

**表 14. REG04 Register Field Descriptions**

Bit	Field	Type	Reset by REG_RST	Reset by WATCHDOG	Description
7	IPRECHG[3]	R/W	Yes	Yes	400 mA
6	IPRECHG[2]	R/W	Yes	Yes	200 mA
5	IPRECHG[1]	R/W	Yes	Yes	100 mA
4	IPRECHG[0]	R/W	Yes	Yes	50 mA
3	ITERM[3]	R/W	Yes	Yes	400 mA
2	ITERM[2]	R/W	Yes	Yes	200 mA
1	ITERM[1]	R/W	Yes	Yes	100 mA
0	ITERM[0]	R/W	Yes	Yes	50 mA

**8.5.6 Charger Control 1 Register (Address = 05h) [reset = 9Dh]**

REG05 is shown in [图 40](#) and described in [表 15](#).

Return to [Summary Table](#).

**图 40. REG05 Register**

Bit	7	6	5	4	3	2	1	0
Reset	1h	0h	1h		1h	2h		1h
Field	EN_TERM	STAT_DIS	WATCHDOG[1:0]		EN_TIMER	CHG_TIMER[1:0]		TMR2X_EN

**表 15. REG05 Register Field Descriptions**

Bit	Field	Type	Reset by REG_RST	Reset by WATCHDOG	Description
7	EN_TERM	R/W	Yes	Yes	Termination Control: 0 – Disable termination 1 – Enable termination (default)
6	STAT_DIS	R/W	Yes	Yes	STAT Pin Disable: 0 – Enable STAT pin function (default) 1 – Disable STAT pin function
5	WATCHDOG[1]	R/W	Yes	Yes	I2C Watchdog Timer Settings: 00 – Disable WD Timer 01 – 40s (default) 10 – 80s 11 – 160s
4	WATCHDOG[0]	R/W	Yes	Yes	
3	EN_TIMER	R/W	Yes	Yes	Charging Safety Timer Enable 0 – Disable 1 – Enable (Default)
2	CHG_TIMER[1]	R/W	Yes	Yes	Fast Charge Timer Setting 00 – 5 hrs 01 – 8 hrs 10 – 12 hrs (Default) 11 – 20 hrs
1	CHG_TIMER[0]	R/W	Yes	Yes	
0	TMR2X_EN	R/W	Yes	Yes	Safety Timer during DPM or TREG 0 – Safety timer always count normally 1 – Safety timer slowed by 2X during input DPM or TREG (Default)

### 8.5.7 Charger Control 2 Register (Address = 06h) [reset = 7Dh]

REG06 is shown in [图 41](#) and described in [表 16](#).

Return to [Summary Table](#).

**图 41. REG06 Register**

Bit	7	6	5	4	3	2	1	0
Reset	0h	1h	3h		1h	1h	0h	
Field	EN_OTG	AUTO_INDET_EN	TREG[1:0]		EN_CHG	BATLOWV	VRECHG[1:0]	

**表 16. REG06 Register Field Descriptions**

Bit	Field	Type	Reset by REG_RST	Reset by WATCHDOG	Description
7	EN_OTG	R/W	Yes	Yes	Buck (OTG) Mode control: 0 – Disable OTG (default) 1 – Enable OTG Note: If EN_OTG and EN_CHG are set simultaneously, EN_CHG takes priority
6	AUTO_INDET_EN	R/W	Yes	Yes	Automatic D+/D– Detection Enable: 0 – Disable D+/D–L detection when VBUS plugs in 1 – Enable D+/D– detection when VBUS plugs in (default)
5	TREG[1]	R/W	Yes	Yes	Thermal Regulation Threshold 00 – 60°C 01 – 80°C 10 – 100°C 11 – 120°C (Default)
4	TREG[0]	R/W	Yes	Yes	
3	EN_CHG	R/W	Yes	Yes	Charger Enable Configuration 0 – Charge Disable 1 – Charge Enable (default) Note: If EN_OTG and EN_CHG are set simultaneously, EN_CHG takes priority
2	BATLOWV	R/W	Yes	Yes	Battery precharge to fast-charge threshold: 0 – 5.6V 1 – 6.0V (default)
1	VRECHG[1]	R/W	Yes	No	Battery Recharge Threshold Offset (below VREG): Offset: 100mV Range: 100mV – 400mV Default: 200mV
0	VRECHG[0]	R/W	Yes	No	

**8.5.8 Charger Control 3 Register (Address = 07h) [reset = 02h]**

 REG07 is shown in [图 42](#) and described in [表 17](#).

 Return to [Summary Table](#).

**图 42. REG07 Register**

Bit	7	6	5	4	3	2	1	0
Reset	0h	0h	0h		2h			
Field	PFM_DIS	WD_RST	TOPOFF_TIMER[1:0]		SYS_MIN[3:0]			

**表 17. REG07 Register Field Descriptions**

Bit	Field	Type	Reset by REG_RST	Reset by WATCHDOG	Description	
7	PFM_DIS	R/W	Yes	No	PFM Mode Disable control: 0 – Enable PFM operation (default) 1 – Disable PFM operation	
6	WD_RST	R/W	Yes	Yes	I2C Watchdog Timer Reset: 0 – Normal 1 – Reset (Bit goes back to 0 after timer reset)	
5	TOPOFF_TIMER[1]	R/W	Yes	Yes	Top-off Timer Control : 00 – Disabled (default) 01 – 15 mins 10 – 30 mins 11 – 45 mins	
4	TOPOFF_TIMER[0]	R/W	Yes	Yes		
3	SYS_MIN[3]	R/W	Yes	No	800 mV	Minimum System Voltage Limit Offset: 6.0 V Range: 6.0 V – 7.5V Default: 6.2 V
2	SYS_MIN[2]	R/W	Yes	No	400 mV	
1	SYS_MIN[1]	R/W	Yes	No	200 mV	
0	SYS_MIN[0]	R/W	Yes	No	100 mV	

### 8.5.9 Charger Control 4 Register (Address = 08h) [reset = 0Dh]

REG08 is shown in [图 43](#) and described in [表 18](#).

Return to [Summary Table](#).

**图 43. REG08 Register**

Bit	7	6	5	4	3	2	1	0
Reset	0h		0h	1h		1h	1h	
Field	BHOT[1:0]		BCOLD	JEITA_VSET[1:0]		JEITA_ISETH	JEITA_ISETC[1:0]	

**表 18. REG08 Register Field Descriptions**

Bit	Field	Type	Reset by REG_RST	Reset by WATCHDOG	Description
7	BHOT[1]	R/W	Yes	Yes	OTG Mode TS HOT Temperature Threshold: 00 – VBHOT1 threshold (34.75%) (default) 01 – VBHOT0 threshold (37.75%) 10 – VBHOT2 threshold (31.25%) 11 – Disable OTG mode thermal protection
6	BHOT[0]	R/W	Yes	Yes	
5	BCOLD	R/W	Yes	Yes	OTG Mode TS COLD Temperature Threshold: 0 – VBCOLD0 threshold (77%) (default) 1 – VBCOLD1 threshold (80%)
4	JEITA_VSET[1]	R/W	Yes	Yes	JEITA High Temp. (45C – 60C) Voltage Setting: 00 – Charge Suspend 01 – Set VREG to 8.0V (default) 10 – Set VREG to 8.3V 11 – VREG unchanged
3	JEITA_VSET[0]	R/W	Yes	Yes	
2	JEITA_ISETH	R/W	Yes	Yes	JEITA High Temp. (45C – 60C) Current Setting (percentage with respect to ICHG REG01[5:0]): 0 – 40% of ICHG 1 – 100% of ICHG (default)
1	JEITA_ISETC[1]	R/W	Yes	Yes	JEITA Low Temp. (0C – 10C) Current Setting (percentage with respect to ICHG REG01[5:0]): 00 – Charge Suspend 01 – 20% of ICHG (default) 10 – 40% of ICHG 11 – 100% of ICHG
0	JEITA_ISETC[0]	R/W	Yes	Yes	

**8.5.10 OTG Control Register (Address = 09h) [reset = F6h]**

 REG09 is shown in [图 44](#) and described in [表 19](#).

 Return to [Summary Table](#).

**图 44. REG09 Register**

Bit	7	6	5	4	3	2	1	0
Reset	Fh				6h			
Field	OTG_ILIM[3:0]				OTG_VLIM[3:0]			

**表 19. REG09 Register Field Descriptions**

Bit	Field	Type	Reset by REG_RST	Reset by WATCHDOG	Description	
7	OTG_ILIM[3]	R/W	Yes	Yes	800 mA	Buck (OTG) Mode Current Limit: Offset: 0.5A Range: 0.5A – 2.0A Default: 2.0A
6	OTG_ILIM[2]	R/W	Yes	Yes	400 mA	
5	OTG_ILIM[1]	R/W	Yes	Yes	200 mA	
4	OTG_ILIM[0]	R/W	Yes	Yes	100 mA	
3	OTG_VLIM[3]	R/W	Yes	Yes	800 mV	Buck (OTG) Mode Regulation Voltage: Offset: 4.5V Range: 4.5V – 5.5V Default: 5.1V Note: Values above 5.5V (Ah) will be clamped to 5.5V
2	OTG_VLIM[2]	R/W	Yes	Yes	400 mV	
1	OTG_VLIM[1]	R/W	Yes	Yes	200 mV	
0	OTG_VLIM[0]	R/W	Yes	Yes	100 mV	

**8.5.11 ICO Current Limit in Use Register (Address = 0Ah) [reset = XXh]**

 REG0A is shown in [图 45](#) and described in [表 20](#).

 Return to [Summary Table](#).

**图 45. REG0A Register**

Bit	7	6	5	4	3	2	1	0
Reset	0	0	0	X	X	X	X	X
Field	RESERVED	RESERVED	RESERVED	ICO_ILIM[4:0]				

**表 20. REG0A Register Field Descriptions**

Bit	Field	Type	Reset by REG_RST	Reset by WATCHDOG	Description
7	RESERVED	R	No	No	Reserved bit always reads 0
6	RESERVED	R	No	No	Reserved bit always reads 0
5	RESERVED	R	No	No	Reserved bit always reads 0
4	ICO_ILIM[4]	R	No	No	1600 mA
3	ICO_ILIM[3]	R	No	No	800 mA
2	ICO_ILIM[2]	R	No	No	400 mA
1	ICO_ILIM[1]	R	No	No	200 mA
0	ICO_ILIM[0]	R	No	No	100 mA

Input Current Limit in use when ICO is enabled:  
Offset: 500 mA  
Range: 500mA – 3300mA

**8.5.12 Charger Status 1 Register (Address = 0Bh) [reset = XXh]**

 REG0B is shown in [图 46](#) and described in [表 21](#).

 Return to [Summary Table](#).

**图 46. REG0B Register**

Bit	7	6	5	4	3	2	1	0
Reset	X	X	X	X	X	X	X	X
Field	Reserved	IINDPM_STAT	VINDPM_STAT	TREG_STAT	WD_STAT	CHRG_STAT[2:0]		

**表 21. REG0B Register Field Descriptions**

Bit	Field	Type	Reset by REG_RST	Reset by WATCHDOG	Description
7	Reserved	R	No	No	Reserved bit always reads 0
6	IINDPM_STAT	R	No	No	IINDPM Status: 0 – Normal 1 – In IINDPM Regulation (ILIM pin or IINDPM register)
5	VINDPM_STAT	R	No	No	VINDPM Status: 0 – Normal 1 – In VINDPM Regulation
4	TREG_STAT	R	No	No	IC Thermal regulation Status: 0 – Normal 1 – In Thermal Regulation
3	WD_STAT	R	No	No	I2C Watchdog Timer Status bit: 0 – Normal 1 – WD Timer expired
2	CHRG_STAT[2]	R	No	No	Charge Status bits: 000 – Not Charging 001 – Trickle Charge (VBAT < VBAT_SHORT) 010 – Pre-charge (VBAT_UVLO_RISING < VBAT < VBAT_LOWV) 011 – Fast-charge (CC mode) 100 – Taper Charge (CV mode) 101 – Top-off Timer Charging 110 – Charge Termination Done 111 – Reserved
1	CHRG_STAT[1]	R	No	No	
0	CHRG_STAT[0]	R	No	No	

### 8.5.13 Charger Status 2 Register (Address = 0Ch) [reset = XXh]

REG0C is shown in [图 47](#) and described in [表 22](#).

Return to [Summary Table](#).

**图 47. REG0C Register**

Bit	7	6	5	4	3	2	1	0
Reset	X	X	X	X	0	X	X	X
Field	PG_STAT	VBUS_STAT[2:0]			RESERVED	ICO_STAT[1]	ICO_STAT[0]	VSYS_STAT

**表 22. REG0C Register Field Descriptions**

Bit	Field	Type	Reset by REG_RST	Reset by WATCHDOG	Description
7	PG_STAT	R	No	No	Power Good Status: 0 – Not Power Good 1 – Power Good
6	VBUS_STAT[2]	R	No	No	VBUS Detection Status 000 – No Input 001 – USB Host SDP 010 - USB CDP (1.5 A) 011 – Adapter (3.0A) 100 – POORSRC detected 7 consecutive times 101 - Unknown Adapter (500 mA) 110 - Non-standard Adapter (1 A/2 A/2.1 A/2.4 A) 111 – OTG
5	VBUS_STAT[1]	R	No	No	
4	VBUS_STAT[0]	R	No	No	
3	RESERVED	R	No	No	Reserved bit always reads 0h
2	ICO_STAT[1]	R	No	No	Input Current Optimizer (ICO) Status: 00 – ICO Disabled 01 – ICO Optimization is in progress 10 – Maximum input current detected 11 – Reserved
1	ICO_STAT[0]	R	No	No	
0	VSYS_STAT	R	No	No	VSYS Regulation Status: 0 – Not in SYS_MIN regulation (BAT > VSYS_MIN) 1 – In SYS_MIN regulation (BAT < VSYS_MIN)

**8.5.14 NTC Status Register (Address = 0Dh) [reset = 0Xh]**

 REG0D is shown in [图 48](#) and described in [表 23](#).

 Return to [Summary Table](#).

**图 48. REG0D Register**

Bit	7	6	5	4	3	2	1	0
Reset	0	0	0	0	0	X	X	X
Field	RESERVED		RESERVED	RESERVED	RESERVED	TS_STAT[2:0]		

**表 23. REG0D Register Field Descriptions**

Bit	Field	Type	Reset by REG_RST	Reset by WATCHDOG	Description
7	RESERVED	R	Yes	No	Reserved bit always reads 0h
6	RESERVED	R	Yes	No	Reserved bit always reads 0h
5	RESERVED	R	Yes	No	Reserved bit always reads 0h
4	RESERVED	R	Yes	No	Reserved bit always reads 0h
3	RESERVED	R	Yes	No	Reserved bit always reads 0h
2	TS_STAT[2]	R	No	No	NTC (TS) Status: 000 – Normal 010 – TS Warm 011 – TS Cool 101 – TS Cold 110 – TS Hot
1	TS_STAT[1]	R	No	No	
0	TS_STAT[0]	R	No	No	

### 8.5.15 FAULT Status Register (Address = 0Eh) [reset = XXh]

REG0E is shown in [图 49](#) and described in [表 24](#).

Return to [Summary Table](#).

**图 49. REG0E Register**

Bit	7	6	5	4	3	2	1	0
Reset	X	X	X	X	0	0	0	X
Field	VBUS_OVP_STAT	TSHUT_STAT	BATOVP_STAT	TMR_STAT	RESERVED	RESERVED	RESERVED	Reserved

**表 24. REG0E Register Field Descriptions**

Bit	Field	Type	Reset by REG_RST	Reset by WATCHDOG	Description
7	VBUS_OVP_STAT	R	No	No	Input over-voltage Status: 0 – Normal 1 – Device in over-voltage protection
6	TSHUT_STAT	R	No	No	IC Temperature shutdown Status: 0 – Normal 1 – Device in thermal shutdown protection
5	BATOVP_STAT	R	No	No	Battery over-voltage Status: 0 – Normal 1 – BATOVP (VBAT > VBATOVP)
4	TMR_STAT	R	No	No	Charge Safety timer Status: 0 – Normal 1 – Charge Safety timer expired
3	RESERVED	R	No	No	Reserved bit always reads 0h
2	RESERVED	R	No	No	Reserved bit always reads 0h
1	RESERVED	R	No	No	Reserved bit always reads 0h
0	RESERVED	R	No	No	Reserved bit always reads 0h

### 8.5.16 Charger Flag 1 Register (Address = 0Fh) [reset = 00h]

REG0F is shown in [图 50](#) and described in [表 25](#).

Return to [Summary Table](#).

**图 50. REG0F Register**

Bit	7	6	5	4	3	2	1	0
Reset	0	0	0	0	0	0	0	0
Field	Reserved	IINDPM_FLAG	VINDPM_FLAG	TREG_FLAG	WD_FLAG	RESERVED	RESERVED	CHRG_FLAG

**表 25. REG0F Register Field Descriptions**

Bit	Field	Type	Reset by REG_RST	Reset by WATCHDOG	Description
7	Reserved	R	Yes	No	Reserved bit always reads 0
6	IINDPM_FLAG	R	Yes	No	IINDPM Regulation $\overline{\text{INT}}$ Flag: 0 – Normal 1 – IINDPM signal rising edge detected
5	VINDPM_FLAG	R	Yes	No	VINDPM regulation $\overline{\text{INT}}$ Flag: 0 – Normal 1 – VINDPM signal rising edge detected
4	TREG_FLAG	R	Yes	No	IC Temperature Regulation $\overline{\text{INT}}$ Flag: 0 – Normal 1 – TREG signal rising edge detected
3	WD_FLAG	R	Yes	No	I2C Watchdog $\overline{\text{INT}}$ Flag: 0 – Normal 1 – WD_STAT signal rising edge detected
2	RESERVED	R	Yes	No	Reserved bit always reads 0h
1	RESERVED	R	Yes	No	Reserved bit always reads 0h
0	CHRG_FLAG	R	Yes	No	Charge Status $\overline{\text{INT}}$ Flag: 0 – Normal 1 – CHRG_STAT[2:0] bits changed (transition to any state)

### 8.5.17 Charger Flag 2 Register (Address = 10h) [reset = 00h]

REG10 is shown in [图 51](#) and described in [表 26](#).

Return to [Summary Table](#).

**图 51. REG10 Register**

Bit	7	6	5	4	3	2	1	0
Reset	0	0	0	0	0	0	0	0
Field	PG_FLAG	RESERVED	RESERVED	VBUS_FLAG	RESERVED	TS_FLAG	ICO_FLAG	VSYS_FLAG

**表 26. REG10 Register Field Descriptions**

Bit	Field	Type	Reset by REG_RST	Reset by WATCHDOG	Description
7	PG_FLAG	R	Yes	No	Power Good $\overline{\text{INT}}$ Flag: 0 – Normal 1 – PG signal toggle detected
6	RESERVED	R	Yes	No	Reserved bit always reads 0h
5	RESERVED	R	Yes	No	Reserved bit always reads 0h
4	VBUS_FLAG	R	Yes	No	VBUS Status $\overline{\text{INT}}$ Flag: 0 – Normal 1 – VBUS_STAT[2:0] bits changed (transition to any state)
3	RESERVED	R	Yes	No	Reserved bit always reads 0h
2	TS_FLAG	R	Yes	No	TS Status $\overline{\text{INT}}$ Flag: 0 – Normal 1 – TS_STAT[2:0] bits changed (transition to any state)
1	ICO_FLAG	R	Yes	No	Input Current Optimizer (ICO) $\overline{\text{INT}}$ Flag: 0 – Normal 1 – ICO_STAT[1:0] changed (transition to any state)
0	VSYS_FLAG	R	Yes	No	VSYS Regulation $\overline{\text{INT}}$ Flag: 0 – Normal 1 – Entered or exited SYS_MIN regulation

**8.5.18 FAULT Flag Register (Address = 11h) [reset = 00h]**

REG11 is shown in [图 52](#) and described in [表 27](#).

Return to [Summary Table](#).

**图 52. REG11 Register**

Bit	7	6	5	4	3	2	1	0
Reset	0	0	0	0	0	0	0	0
Field	VBUS_OVP_FL AG	TSHUT_FLAG	BATOVP_FLAG	TMR_FLAG	RESERVED	RESERVED	RESERVED	OTG_FLAG

**表 27. REG11 Register Field Descriptions**

Bit	Field	Type	Reset by REG_RST	Reset by WATCHDOG	Description
7	VBUS_OVP_FLAG	R	Yes	No	Input over-voltage $\overline{\text{INT}}$ Flag: 0 – Normal 1 – Entered VBUS_OVP Fault
6	TSHUT_FLAG	R	Yes	No	IC Temperature shutdown $\overline{\text{INT}}$ Flag: 0 – Normal 1 – Entered TSHUT Fault
5	BATOVP_FLAG	R	Yes	No	Battery over-voltage $\overline{\text{INT}}$ Flag: 0 – Normal 1 – Entered BATOVP Fault
4	TMR_FLAG	R	Yes	No	Charge Safety timer Fault $\overline{\text{INT}}$ Flag: 0 – Normal 1 – Charge Safety timer expired rising edge detected
3	RESERVED	R	Yes	No	Reserved bit always reads 0
2	RESERVED	R	Yes	No	Reserved bit always reads 0h
1	RESERVED	R	Yes	No	Reserved bit always reads 0h
0	OTG_FLAG	R	Yes	No	OTG Buck Mode Fault $\overline{\text{INT}}$ Flag: 0 – Normal 1 – Entered OTG_STAT (OTG Fault)

### 8.5.19 Charger Mask 1 Register (Address = 12h) [reset = 00h]

REG12 is shown in [图 53](#) and described in [表 28](#).

Return to [Summary Table](#).

**图 53. REG12 Register**

Bit	7	6	5	4	3	2	1	0
Reset	0	0	0	0	0	0	0	0
Field	ADC_DONE_M ASK	IINDPM_MASK	VINDPM_MASK	TREG_MASK	WD_MASK	RESERVED	RESERVED	CHRG_MASK

**表 28. REG12 Register Field Descriptions**

Bit	Field	Type	Reset by REG_RST	Reset by WATCHDOG	Description
7	ADC_DONE_MASK	R/W	Yes	No	ADC Conversion $\overline{\text{INT}}$ Mask Flag (only one-shot mode) 0 – ADC_DONE does produce $\overline{\text{INT}}$ pulse 1 – ADC_DONE does produce not $\overline{\text{INT}}$ pulse Reserved bit always reads 0
6	IINDPM_MASK	R/W	Yes	No	IINDPM Regulation $\overline{\text{INT}}$ Mask 0 – IINDPM entry produces $\overline{\text{INT}}$ pulse 1 – IINDPM entry does not produce $\overline{\text{INT}}$ pulse
5	VINDPM_MASK	R/W	Yes	No	VINDPM Regulation $\overline{\text{INT}}$ Mask 0 – VINDPM entry produces $\overline{\text{INT}}$ pulse 1 – VINDPM entry not produce $\overline{\text{INT}}$ pulse
4	TREG_MASK	R/W	Yes	No	IC Temperature Regulation $\overline{\text{INT}}$ Mask 0 – TREG entry produces $\overline{\text{INT}}$ pulse 1 – TREG entry produce $\overline{\text{INT}}$ pulse
3	WD_MASK	R/W	Yes	No	I2C Watchdog Timer $\overline{\text{INT}}$ Mask 0 – WD_STAT rising edge produces $\overline{\text{INT}}$ pulse 1 – WD_STAT rising edge does not produce $\overline{\text{INT}}$
2	RESERVED	R	Yes	No	Reserved bit always reads 0h
1	RESERVED	R	Yes	No	Reserved bit always reads 0h
0	CHRG_MASK	R/W	Yes	No	Charge Status $\overline{\text{INT}}$ Mask 0 – CHRG_STAT[2:0] bit change produces $\overline{\text{INT}}$ 1 – CHRG_STAT[2:0] bit change does not produce $\overline{\text{INT}}$ pulse

**8.5.20 Charger Mask 2 Register (Address = 13h) [reset = 00h]**

 REG13 is shown in [图 54](#) and described in [表 29](#).

 Return to [Summary Table](#).

**图 54. REG13 Register**

Bit	7	6	5	4	3	2	1	0
Reset	0	0	0	0	0	0	0	0
Field	PG_MASK	RESERVED	RESERVED	VBUS_MASK	RESERVED	TS_MASK	ICO_MASK	VSYS_MASK

**表 29. REG13 Register Field Descriptions**

Bit	Field	Type	Reset by REG_RST	Reset by WATCHDOG	Description
7	PG_MASK	R/W	Yes	No	Power Good $\overline{\text{INT}}$ Mask: 0 – PG toggle produces $\overline{\text{INT}}$ pulse 1 – PG toggle does not produce $\overline{\text{INT}}$ pulse
6	RESERVED	R	Yes	No	Reserved bit always reads 0h
5	RESERVED	R	Yes	No	Reserved bit always reads 0h
4	VBUS_MASK	R/W	Yes	No	VBUS Status $\overline{\text{INT}}$ Mask: 0 – VBUS_STAT[2:0] bit change produces $\overline{\text{INT}}$ 1 – VBUS_STAT[2:0] bit change does not produces $\overline{\text{INT}}$
3	RESERVED	R	Yes	No	Reserved bit always reads 0h
2	TS_MASK	R/W	Yes	No	TS Status $\overline{\text{INT}}$ Mask: 0 – TS_STAT[2:0] bit change produces $\overline{\text{INT}}$ 1 – TS_STAT[2:0] bit change does not produces $\overline{\text{INT}}$ pulse
1	ICO_MASK	R/W	Yes	No	Input Current Optimizer (ICO) $\overline{\text{INT}}$ Mask: 0 – ICO_STAT rising edge produces $\overline{\text{INT}}$ 1 – ICO_STAT rising edge does not produce $\overline{\text{INT}}$
0	VSYS_MASK	R/W	Yes	No	VSYS Regulation $\overline{\text{INT}}$ Mask: 0 – Entering or exiting SYS_MIN produces $\overline{\text{INT}}$ 1 – Entering or exiting SYS_MIN does not produce $\overline{\text{INT}}$

### 8.5.21 FAULT Mask Register (Address = 14h) [reset = 00h]

REG14 is shown in [图 55](#) and described in [表 30](#).

Return to [Summary Table](#).

**图 55. REG14 Register**

Bit	7	6	5	4	3	2	1	0
Reset	0	0	0	0	0	0	0	0
Field	VBUS_OVP_M ASK	TSHUT_MASK	BATOVP_MAS K	TMR_MASK	SYS_SHORT_ MASK	RESERVED	RESERVED	OTG_MASK

**表 30. REG14 Register Field Descriptions**

Bit	Field	Type	Reset by REG_RST	Reset by WATCHDOG	Description
7	VBUS_OVP_MASK	R/W	Yes	No	Input over-voltage $\overline{\text{INT}}$ Mask: 0 – VBUS_OVP rising edge produces $\overline{\text{INT}}$ pulse 1 – VBUS_OVP rising edge does not produce $\overline{\text{INT}}$ pulse
6	TSHUT_MASK	R/W	Yes	No	Thermal Shutdown $\overline{\text{INT}}$ Mask: 0 – TSHUT rising edge produces $\overline{\text{INT}}$ pulse 1 – TSHUT rising edge does not produce $\overline{\text{INT}}$ pulse
5	BATOVP_MASK	R/W	Yes	No	Battery overvoltage $\overline{\text{INT}}$ Mask: 0 – BATOVP rising edge produces $\overline{\text{INT}}$ pulse 1 – BATOVP rising edge does not produce $\overline{\text{INT}}$ pulse
4	TMR_MASK	R/W	Yes	No	Charge Safety Timer Fault $\overline{\text{INT}}$ Mask: 0 – Timer expired rising edge produces $\overline{\text{INT}}$ pulse 1 – Timer expired rising edge does not produce $\overline{\text{INT}}$ pulse
3	SYS_SHORT_MASK	R/W	Yes	No	System Short Fault $\overline{\text{INT}}$ Mask: 0 – System short rising edge produces $\overline{\text{INT}}$ pulse 1 – System short rising edge does not produce $\overline{\text{INT}}$ pulse
2	RESERVED	R	Yes	No	Reserved bit always reads 0h
1	RESERVED	R	Yes	No	Reserved bit always reads 0h
0	OTG_MASK	R/W	Yes	No	OTG Buck Mode Fault $\overline{\text{INT}}$ Mask: 0 – OTG_STAT event produces $\overline{\text{INT}}$ 1 – OTG_STAT event does not produce $\overline{\text{INT}}$

**8.5.22 ADC Control Register (Address = 15h) [reset = 30h]**

 REG15 is shown in [图 56](#) and described in [表 31](#).

 Return to [Summary Table](#).

**图 56. REG15 Register**

Bit	7	6	5	4	3	2	1	0
Reset	0	0	1	1	0	0	0	0
Field	ADC_EN	ADC_RATE	ADC_SAMPLE[1:0]		RESERVED	RESERVED	RESERVED	RESERVED

**表 31. REG15 Register Field Descriptions**

Bit	Field	Type	Reset by REG_RST	Reset by WATCHDOG	Description
7	ADC_EN	R/W	Yes	Yes	ADC Control: 0 – Disable ADC 1 – Enable ADC
6	ADC_RATE	R/W	Yes	No	0 – Continuous conversion 1 – One-shot conversion
5	ADC_SAMPLE[1]	R/W	Yes	No	Sample Speed of ADC: 00 – 15 bit effective resolution 01 – 14 bit effective resolution 10 – 13 bit effective resolution 11 – 12 bit effective resolution
4	ADC_SAMPLE[0]	R/W	Yes	No	
3	RESERVED	R	Yes	No	Reserved bit always reads 0h
2	RESERVED	R	Yes	No	Reserved bit always reads 0h
1	RESERVED	R	Yes	No	Reserved bit always reads 0h
0	RESERVED	R	Yes	No	Reserved bit always reads 0h

### 8.5.23 ADC Function Disable Register (Address = 16h) [reset = 00h]

REG16 is shown in [图 57](#) and described in [表 32](#).

Return to [Summary Table](#).

**图 57. REG16 Register**

Bit	7	6	5	4	3	2	1	0
Reset	0	0	0	0	0	0	1	0
Field	IBUS_ADC_DIS	ICHG_ADC_D IS	VBUS_ADC_DI S	VBAT_ADC_DI S	VSYS_ADC_DI S	TS_ADC_DIS	Reserved	TDIE_ADC_DIS

**表 32. REG16 Register Field Descriptions**

Bit	Field	Type	Reset by REG_RST	Reset by WATCHDOG	Description
7	IBUS_ADC_DIS	R/W	Yes	No	0 – Enable conversion 1 – Disable conversion
6	ICHG_ADC_DIS	R/W	Yes	No	0 – Enable conversion 1 – Disable conversion
5	VBUS_ADC_DIS	R/W	Yes	No	0 – Enable conversion 1 – Disable conversion
4	VBAT_ADC_DIS	R/W	Yes	No	0 – Enable conversion 1 – Disable conversion
3	VSYS_ADC_DIS	R/W	Yes	No	0 – Enable conversion 1 – Disable conversion
2	TS_ADC_DIS	R/W	Yes	No	0 – Enable conversion 1 – Disable conversion
1	RESERVED	R	Yes	No	Reserved bit always reads 1h
0	TDIE_ADC_DIS	R/W	Yes	No	0 – Enable conversion 1 – Disable conversion

### 8.5.24 IBUS ADC 1 Register (Address = 17h) [reset = 00h]

REG17 is shown in [图 58](#) and described in [表 33](#).

Return to [Summary Table](#).

**图 58. REG17 Register**

Bit	7	6	5	4	3	2	1	0
Reset	0	0	0	0	0	0	0	0
Field	IBUS_ADC[15:8]							

**表 33. REG17 Register Field Descriptions**

Bit	Field	Type	Reset by REG_RST	Reset by WATCHDOG	Description
7	IBUS_ADC[15]	R	Yes	No	Sign bit: overall results reported in two's complement.
6	IBUS_ADC[14]	R	Yes	No	16384 mA
5	IBUS_ADC[13]	R	Yes	No	8192 mA
4	IBUS_ADC[12]	R	Yes	No	4096 mA
3	IBUS_ADC[11]	R	Yes	No	2048 mA
2	IBUS_ADC[10]	R	Yes	No	1024 mA
1	IBUS_ADC[9]	R	Yes	No	512 mA
0	IBUS_ADC[8]	R	Yes	No	256 mA

VBUS Current Reading (positive current flows into VBUS pin, negative current flows out of VBUS pin):  
Range: 0A – 4A

### 8.5.25 IBUS ADC 0 Register (Address = 18h) [reset = 00h]

REG18 is shown in [图 59](#) and described in [表 34](#).

Return to [Summary Table](#).

**图 59. REG18 Register**

Bit	7	6	5	4	3	2	1	0
Reset	0	0	0	0	0	0	0	0
Field	IBUS_ADC[7:0]							

**表 34. REG18 Register Field Descriptions**

Bit	Field	Type	Reset by REG_RST	Reset by WATCHDOG	Description
7	IBUS_ADC[7]	R	Yes	No	128 mA
6	IBUS_ADC[6]	R	Yes	No	64 mA
5	IBUS_ADC[5]	R	Yes	No	32 mA
4	IBUS_ADC[4]	R	Yes	No	16 mA
3	IBUS_ADC[3]	R	Yes	No	8 mA
2	IBUS_ADC[2]	R	Yes	No	4 mA
1	IBUS_ADC[1]	R	Yes	No	2 mA
0	IBUS_ADC[0]	R	Yes	No	1 mA

VBUS Current Reading (positive current flows into VBUS pin, negative current flows out of VBUS pin):  
Range: 0A – 4A

### 8.5.26 ICHG ADC 1 Register (Address = 19h) [reset = 00h]

REG19 is shown in [图 60](#) and described in [表 35](#).

Return to [Summary Table](#).

**图 60. REG19 Register**

Bit	7	6	5	4	3	2	1	0
Reset	0	0	0	0	0	0	0	0
Field	RESERVED	ICHG_ADC[14:8]						

**表 35. REG19 Register Field Descriptions**

Bit	Field	Type	Reset by REG_RST	Reset by WATCHDOG	Description
7	Reserved	R	Yes	No	Reserved register always reads 0h.
6	ICHG_ADC[14]	R	Yes	No	16384 mA
5	ICHG_ADC[13]	R	Yes	No	8192 mA
4	ICHG_ADC[12]	R	Yes	No	4096 mA
3	ICHG_ADC[11]	R	Yes	No	2048 mA
2	ICHG_ADC[10]	R	Yes	No	1024 mA
1	ICHG_ADC[9]	R	Yes	No	512 mA
0	ICHG_ADC[8]	R	Yes	No	256 mA

Charge Current Reading:  
Range: 0A – 4A

### 8.5.27 ICHG ADC 0 Register (Address = 1Ah) [reset = 00h]

REG1A is shown in [图 61](#) and described in [表 36](#).

Return to [Summary Table](#).

**图 61. REG1A Register**

Bit	7	6	5	4	3	2	1	0
Reset	0	0	0	0	0	0	0	0
Field	ICHG_ADC[7:0]							

**表 36. REG1A Register Field Descriptions**

Bit	Field	Type	Reset by REG_RST	Reset by WATCHDOG	Description
7	ICHG_ADC[7]	R	Yes	No	128 mA
6	ICHG_ADC[6]	R	Yes	No	64 mA
5	ICHG_ADC[5]	R	Yes	No	32 mA
4	ICHG_ADC[4]	R	Yes	No	16 mA
3	ICHG_ADC[3]	R	Yes	No	8 mA
2	ICHG_ADC[2]	R	Yes	No	4 mA
1	ICHG_ADC[1]	R	Yes	No	2 mA
0	ICHG_ADC[0]	R	Yes	No	1 mA

Charge Current Reading:  
Range: 0A – 4A

**8.5.28 VBUS ADC 1 Register (Address = 1Bh) [reset = 00h]**

 REG1B is shown in [图 62](#) and described in [表 37](#).

 Return to [Summary Table](#).

**图 62. REG1B Register**

Bit	7	6	5	4	3	2	1	0
Reset	0	0	0	0	0	0	0	0
Field	VBUS_ADC[15:8]							

**表 37. REG1B Register Field Descriptions**

Bit	Field	Type	Reset by REG_RST	Reset by WATCHDOG	Description
7	VBUS_ADC[15]	R	Yes	No	Sign bit: overall results reported in two's complement.
6	VBUS_ADC[14]	R	Yes	No	16384 mV
5	VBUS_ADC[13]	R	Yes	No	8192 mV
4	VBUS_ADC[12]	R	Yes	No	4096 mV
3	VBUS_ADC[11]	R	Yes	No	2048 mV
2	VBUS_ADC[10]	R	Yes	No	1024 mV
1	VBUS_ADC[9]	R	Yes	No	512 mV
0	VBUS_ADC[8]	R	Yes	No	256 mV

VBUS Voltage reading  
Range: 0V – 10V

**8.5.29 VBUS ADC 0 Register (Address = 1Ch) [reset = 00h]**

 REG1C is shown in [图 63](#) and described in [表 38](#).

 Return to [Summary Table](#).

**图 63. REG1C Register**

Bit	7	6	5	4	3	2	1	0
Reset	0	0	0	0	0	0	0	0
Field	VBUS_ADC[7:0]							

**表 38. REG1C Register Field Descriptions**

Bit	Field	Type	Reset by REG_RST	Reset by WATCHDOG	Description
7	VBUS_ADC[7]	R	Yes	No	128 mV
6	VBUS_ADC[6]	R	Yes	No	64 mV
5	VBUS_ADC[5]	R	Yes	No	32 mV
4	VBUS_ADC[4]	R	Yes	No	16 mV
3	VBUS_ADC[3]	R	Yes	No	8 mV
2	VBUS_ADC[2]	R	Yes	No	4 mV
1	VBUS_ADC[1]	R	Yes	No	2 mV
0	VBUS_ADC[0]	R	Yes	No	1 mV

VBUS Voltage Reading:  
Range: 0V – 10V

### 8.5.30 VBAT ADC 1 Register (Address = 1Dh) [reset = 00h]

REG1D is shown in [图 64](#) and described in [表 39](#).

Return to [Summary Table](#).

**图 64. REG1D Register**

Bit	7	6	5	4	3	2	1	0
Reset	0	0	0	0	0	0	0	0
Field	VBAT_ADC[15:8]							

**表 39. REG1D Register Field Descriptions**

Bit	Field	Type	Reset by REG_RST	Reset by WATCHDOG	Description
7	VBAT_ADC[15]	R	Yes	No	Sign bit: overall results reported in two's complement.
6	VBAT_ADC[14]	R	Yes	No	16384 mV
5	VBAT_ADC[13]	R	Yes	No	8192 mV
4	VBAT_ADC[12]	R	Yes	No	4096 mV
3	VBAT_ADC[11]	R	Yes	No	2048 mV
2	VBAT_ADC[10]	R	Yes	No	1024 mV
1	VBAT_ADC[9]	R	Yes	No	512 mV
0	VBAT_ADC[8]	R	Yes	No	256 mV

VBAT Voltage reading:  
Range: 0V – 10V

### 8.5.31 VBAT ADC 0 Register (Address = 1Eh) [reset = 00h]

REG1E is shown in [图 65](#) and described in [表 40](#).

Return to [Summary Table](#).

**图 65. REG1E Register**

Bit	7	6	5	4	3	2	1	0
Reset	0	0	0	0	0	0	0	0
Field	VBAT_ADC[7:0]							

**表 40. REG1E Register Field Descriptions**

Bit	Field	Type	Reset by REG_RST	Reset by WATCHDOG	Description
7	VBAT_ADC[7]	R	Yes	No	128 mV
6	VBAT_ADC[6]	R	Yes	No	64 mV
5	VBAT_ADC[5]	R	Yes	No	32 mV
4	VBAT_ADC[4]	R	Yes	No	16 mV
3	VBAT_ADC[3]	R	Yes	No	8 mV
2	VBAT_ADC[2]	R	Yes	No	4 mV
1	VBAT_ADC[1]	R	Yes	No	2 mV
0	VBAT_ADC[0]	R	Yes	No	1 mV

VBAT Voltage reading:  
Range: 0V – 10V

**8.5.32 VSYS ADC 1 Register (Address = 1Fh) [reset = 00h]**

REG1F is shown in [图 66](#) and described in [表 41](#).

Return to [Summary Table](#).

**图 66. REG1F Register**

Bit	7	6	5	4	3	2	1	0
Reset	0	0	0	0	0	0	0	0
Field	VSYS_ADC[15:8]							

**表 41. REG1F Register Field Descriptions**

Bit	Field	Type	Reset by REG_RST	Reset by WATCHDOG	Description
7	VSYS_ADC[15]	R	Yes	No	Sign bit: overall results reported in two's complement.
6	VSYS_ADC[14]	R	Yes	No	16384 mV
5	VSYS_ADC[13]	R	Yes	No	8192 mV
4	VSYS_ADC[12]	R	Yes	No	4096 mV
3	VSYS_ADC[11]	R	Yes	No	2048 mV
2	VSYS_ADC[10]	R	Yes	No	1024 mV
1	VSYS_ADC[9]	R	Yes	No	512 mV
0	VSYS_ADC[8]	R	Yes	No	256 mV

VSYS Voltage reading:  
Range: 0V – 10V

**8.5.33 VSYS ADC 0 Register (Address = 20h) [reset = 00h]**

REG20 is shown in [图 67](#) and described in [表 42](#).

Return to [Summary Table](#).

**图 67. REG20 Register**

Bit	7	6	5	4	3	2	1	0
Reset	0	0	0	0	0	0	0	0
Field	VSYS_ADC[7:0]							

**表 42. REG20 Register Field Descriptions**

Bit	Field	Type	Reset by REG_RST	Reset by WATCHDOG	Description
7	VSYS_ADC[7]	R	Yes	No	128 mV
6	VSYS_ADC[6]	R	Yes	No	64 mV
5	VSYS_ADC[5]	R	Yes	No	32 mV
4	VSYS_ADC[4]	R	Yes	No	16 mV
3	VSYS_ADC[3]	R	Yes	No	8 mV
2	VSYS_ADC[2]	R	Yes	No	4 mV
1	VSYS_ADC[1]	R	Yes	No	2 mV
0	VSYS_ADC[0]	R	Yes	No	1 mV

VSYS Voltage reading:  
Range: 0V – 10V

### 8.5.34 TS ADC 1 Register (Address = 21h) [reset = 00h]

REG21 is shown in [图 68](#) and described in [表 43](#).

Return to [Summary Table](#).

**图 68. REG21 Register**

Bit	7	6	5	4	3	2	1	0
Reset	0	0	0	0	0	0	0	0
Field	TS_ADC[15:8]							

**表 43. REG21 Register Field Descriptions**

Bit	Field	Type	Reset by REG_RST	Reset by WATCHDOG	Description
7	TS_ADC[15]	R	Yes	No	Sign bit: overall results reported in two's complement.
6	TS_ADC[14]	R	Yes	No	
5	TS_ADC[13]	R	Yes	No	
4	TS_ADC[12]	R	Yes	No	
3	TS_ADC[11]	R	Yes	No	
2	TS_ADC[10]	R	Yes	No	
1	TS_ADC[9]	R	Yes	No	50.0 %
0	TS_ADC[8]	R	Yes	No	25.0 %

TS as percentage of REGN reading:  
Range: 0% – 94.9%

### 8.5.35 TS ADC 0 Register (Address = 22h) [reset = 00h]

REG22 is shown in [图 69](#) and described in [表 44](#).

Return to [Summary Table](#).

**图 69. REG22 Register**

Bit	7	6	5	4	3	2	1	0
Reset	0	0	0	0	0	0	0	0
Field	TS_ADC[7:0]							

**表 44. REG22 Register Field Descriptions**

Bit	Field	Type	Reset by REG_RST	Reset by WATCHDOG	Description
7	TS_ADC[7]	R	Yes	No	12.50 %
6	TS_ADC[6]	R	Yes	No	6.25 %
5	TS_ADC[5]	R	Yes	No	3.125 %
4	TS_ADC[4]	R	Yes	No	1.563 %
3	TS_ADC[3]	R	Yes	No	0.781 %
2	TS_ADC[2]	R	Yes	No	0.391 %
1	TS_ADC[1]	R	Yes	No	0.195 %
0	TS_ADC[0]	R	Yes	No	0.098 %

TS as percentage of REGN reading:  
Range: 0% – 94.9%

**8.5.36 TDIE ADC 1 Register (Address = 23h) [reset = 00h]**

 REG23 is shown in [图 70](#) and described in [表 45](#).

 Return to [Summary Table](#).

**图 70. REG23 Register**

Bit	7	6	5	4	3	2	1	0
Reset	0	0	0	0	0	0	0	0
Field	TDIE_ADC[15:8]							

**表 45. REG23 Register Field Descriptions**

Bit	Field	Type	Reset by REG_RST	Reset by WATCHDOG	Description	
7	TDIE_ADC[15]	R	Yes	No	Sign bit: overall results reported in two's complement.	
6	TDIE_ADC[14]	R	Yes	No		
5	TDIE_ADC[13]	R	Yes	No		
4	TDIE_ADC[12]	R	Yes	No		
3	TDIE_ADC[11]	R	Yes	No		
2	TDIE_ADC[10]	R	Yes	No		
1	TDIE_ADC[9]	R	Yes	No		
0	TDIE_ADC[8]	R	Yes	No	128 °C	TDIE (IC Temperature) reading: Range: 0°C – 128°C

**8.5.37 TDIE ADC 0 Register (Address = 24h) [reset = 00h]**

 REG24 is shown in [图 71](#) and described in [表 46](#).

 Return to [Summary Table](#).

**图 71. REG24 Register**

Bit	7	6	5	4	3	2	1	0
Reset	0	0	0	0	0	0	0	0
Field	TDIE_ADC[7:0]							

**表 46. REG24 Register Field Descriptions**

Bit	Field	Type	Reset by REG_RST	Reset by WATCHDOG	Description	
7	TDIE_ADC[7]	R	Yes	No	64 °C	TDIE (IC Temperature) reading: Range: 0°C – 128°C
6	TDIE_ADC[6]	R	Yes	No	32 °C	
5	TDIE_ADC[5]	R	Yes	No	16 °C	
4	TDIE_ADC[4]	R	Yes	No	8 °C	
3	TDIE_ADC[3]	R	Yes	No	4 °C	
2	TDIE_ADC[2]	R	Yes	No	2 °C	
1	TDIE_ADC[1]	R	Yes	No	1 °C	
0	TDIE_ADC[0]	R	Yes	No	0.5 °C	

**8.5.38 Part Information Register (Address = 25h) [reset = 18h]**

 REG25 is shown in [图 72](#) and described in [表 47](#).

 Return to [Summary Table](#).

**图 72. REG25 Register**

Bit	7	6	5	4	3	2	1	0
Reset	0	0	0	1	1	0	0	0
Field	REG_RST	PN[3:0]			DEV_REV[2:0]			

**表 47. REG25 Register Field Descriptions**

Bit	Field	Type	Reset by REG_RST	Reset by WATCHDOG	Description
7	REG_RST	R	Yes	No	Register Reset: 0 – Keep current register settings 1 – Reset to default register value and reset safety timer (bit resets to 0 after register reset is complete)
6	PN[3]	R	Yes	No	0011: BQ25883
5	PN[2]	R	Yes	No	
4	PN[1]	R	Yes	No	
3	PN[0]	R	Yes	No	
2	DEV_REV[2]	R	Yes	No	Device revision: 001
1	DEV_REV[1]	R	Yes	No	
0	DEV_REV[0]	R	Yes	No	

## 9 Application and Implementation

注

Information in the following applications sections is not part of the TI component specification, and TI does not warrant its accuracy or completeness. TI's customers are responsible for determining suitability of components for their purposes. Customers should validate and test their design implementation to confirm system functionality.

### 9.1 Application Information

A typical application consists of the BQ25883 configured as an I2C controlled power path management device and a 2s battery charger for Li-Ion and Li-polymer batteries used in a wide range of portable devices. It integrates an input blocking FET (QBLK, Q1), high-side switching FET (QHS, Q2), low-side switching FET (QLS, Q3), and battery FET (QBAT, Q4) between system and battery. The device also integrates a bootstrap diode for the high-side gate drive.

### 9.2 Typical Application



图 73. BQ25883 (I2C, OTG, and Power Path) Typical Application Diagram

## Typical Application (continued)

### 9.2.1 Design Requirements

For this design example, use the parameters shown in the table below.

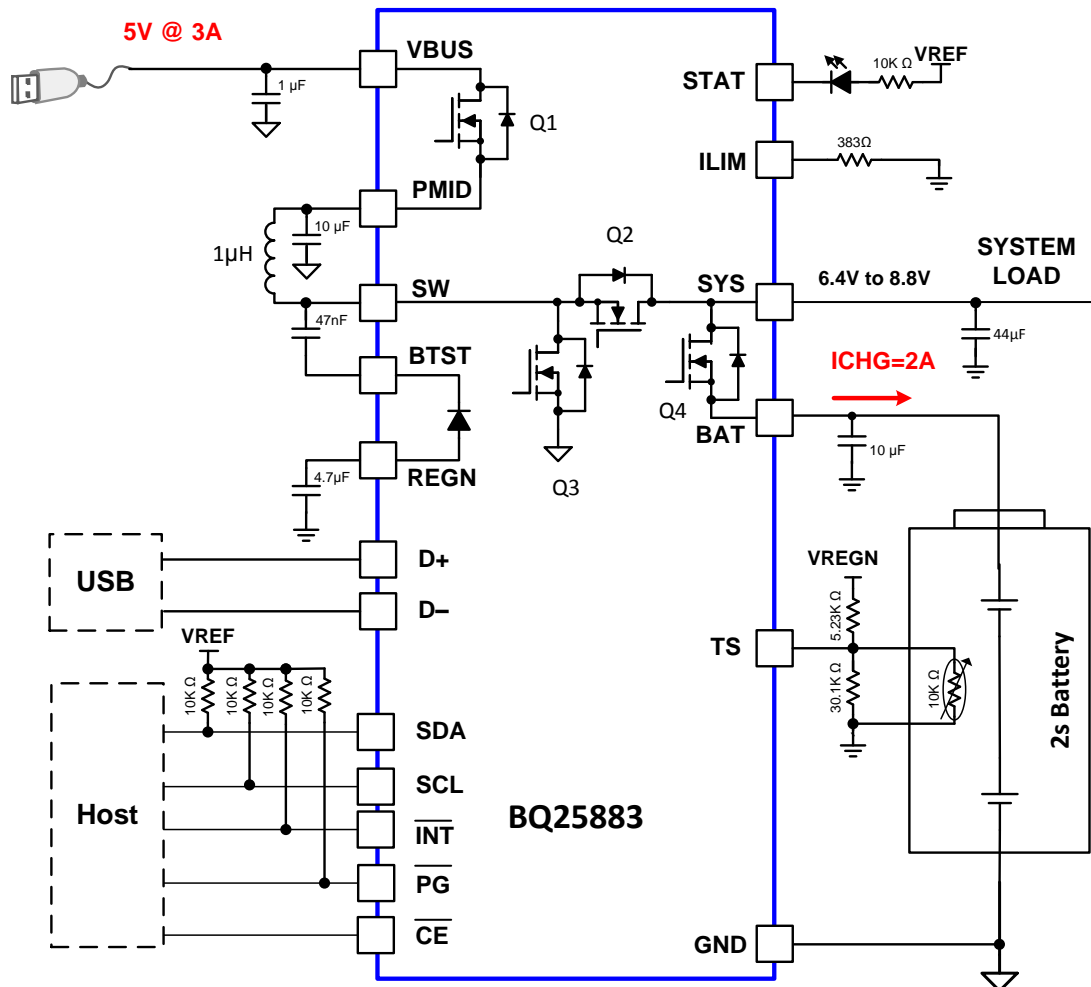
表 48. Design Parameters

PARAMETER	VALUE
VBUS voltage range	3.9 V to 6.2 V
Input current limit (IINDPM[4:0])	2.4 A
Fast charge current limit (ICHG[5:0])	1.5 A
Minimum System Voltage (SYS_MIN[3:0])	6.2 V
Battery Regulation Voltage (VREG[7:0])	8.4 V

### 9.2.2 Detailed Design Procedure

#### 9.2.2.1 Inductor Selection

The device has 1.5MHz switching frequency to allow the use of small inductor and capacitor values. The inductor saturation current should be higher than the input current ( $I_{IN}$ ) plus half the ripple current ( $I_{RIPPLE}$ ):

$$I_{SAT} \geq I_{IN} + \frac{I_{RIPPLE}}{2} \quad (5)$$

The inductor ripple current ( $I_{RIPPLE}$ ) depends on input voltage ( $V_{VBUS}$ ), duty cycle ( $D = V_{BAT}/V_{BUS}$ ), switching frequency ( $f_{SW}$ ) and inductance ( $L$ ):

$$I_{RIPPLE} = \frac{V_{BUS} \times (V_{SYS} - V_{BUS})}{V_{SYS} \times f_{SW} \times L} \quad (6)$$

The maximum inductor ripple current happens in the vicinity of  $D = 0.5$ . Usually inductor ripple is designed in the range of (20 – 40%) maximum charging current as a trade-off between inductor size and efficiency for a practical design.

#### 9.2.2.2 Input (VBUS / PMID) Capacitor

Input capacitor should have enough ripple current rating to absorb input switching ripple current. The worst case RMS ripple current occurs when duty cycle is 0.5. If the converter does not operate at 50% duty cycle, then the worst case capacitor RMS current  $I_{PMID}$  occurs where the duty cycle is closest to 50% and can be estimated by

$$I_{PMID} = \frac{I_{RIPPLE}}{2 \times \sqrt{3}} \approx 0.29 \times I_{RIPPLE} \quad (7)$$

Low ESR ceramic capacitor such as X7R or X5R is preferred for input decoupling capacitor and should be placed close to the PMID and GND pins of the IC. Voltage rating of the capacitor must be higher than normal input voltage level. 25-V rating or higher capacitor is preferred for up to 5-V input voltage. 10- $\mu$ F capacitor is suggested for up to 3.3-A input current.

#### 9.2.2.3 Output (VSYS) Capacitor

SYS capacitor is the boost converter output capacitor and should also have enough ripple current rating to absorb output switching ripple current. The output capacitor RMS current  $I_{COUT}$  is given:

$$I_{CSYS, rms} = I_{OUT} \times \sqrt{\frac{D}{1-D}} \quad (8)$$

The output capacitor voltage ripple is a function of the boost output current ( $I_{OUT}$ ), and can be calculated as follows:

$$\Delta V_{SYS} = \frac{I_{OUT} \times D}{f_{SW} \times C_{SYS}} \quad (9)$$

**BQ25883**

JAJSH75A – FEBRUARY 2019 – REVISED MARCH 2019

[www.tij.co.jp](http://www.tij.co.jp)

Low ESR ceramic capacitor such as X7R or X5R is preferred for SYS decoupling capacitor and should be placed close to the SYS and GND pins of the IC. Voltage rating of the capacitor must be higher than normal output voltage level. 16-V rating or higher capacitor is preferred. 44- $\mu$ F capacitor is suggested for up to 2.2-A boost converter output current.

### 9.2.3 Application Curves

$C_{VBUS} = 1\mu\text{F}$ ,  $C_{PMID} = 10\mu\text{F}$ ,  $C_{BAT} = 10\mu\text{F}$ ,  $C_{SYS} = 44\mu\text{F}$ ,  $L = \text{DFE252012F-1R0}$  ( $1\mu\text{H}$ ) (unless otherwise specified)

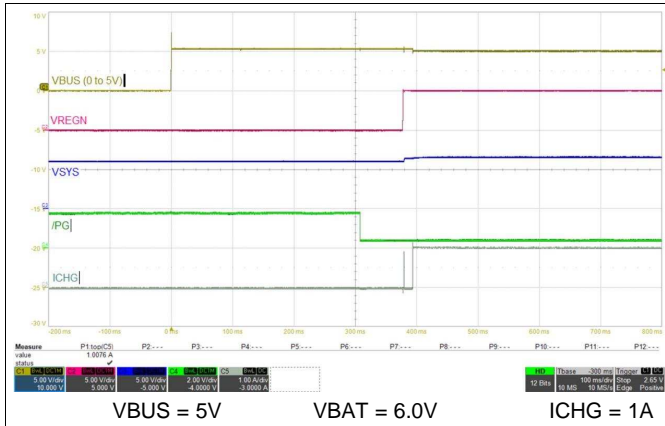

Figure 74. Adapter Power Up with Charge Enabled

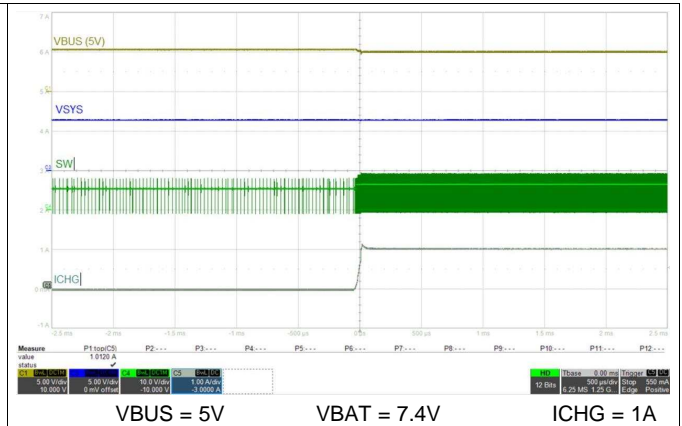

Figure 75. Charge Enable

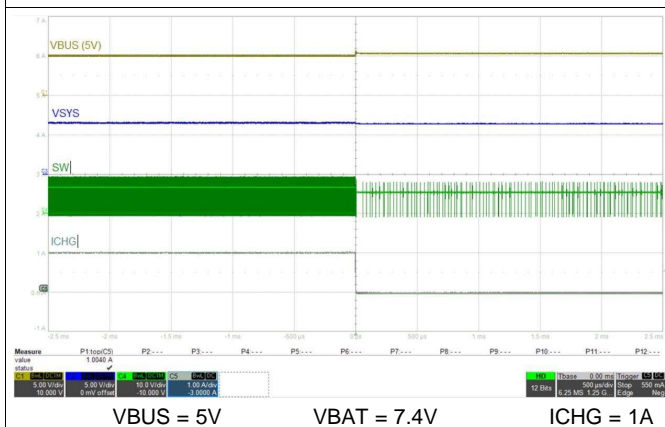

Figure 76. Charge Disabled

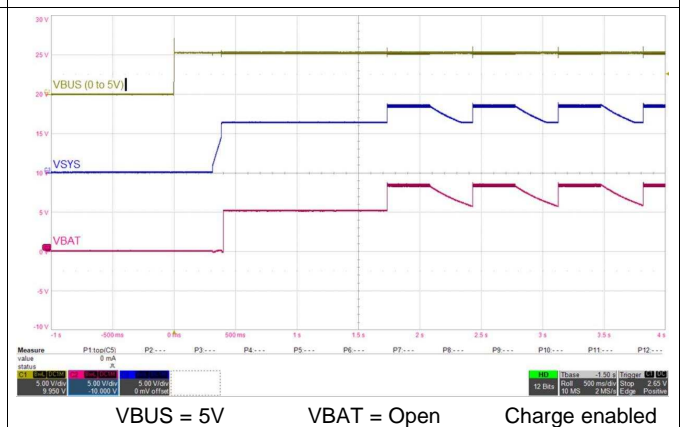

Figure 77. Adapter Plug-in with No Battery

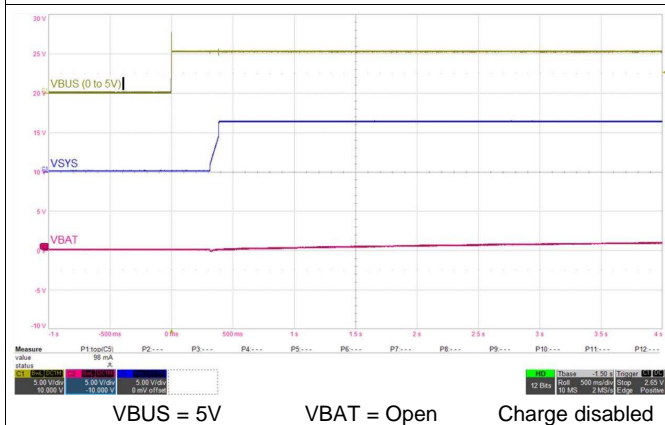

Figure 78. Adapter Plug-in with No Battery Charge Disabled

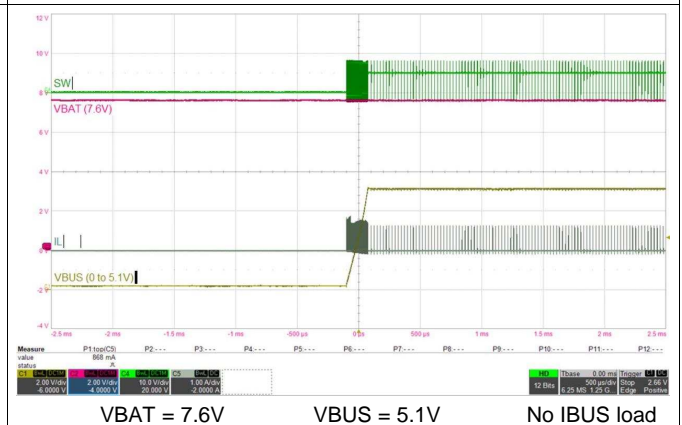
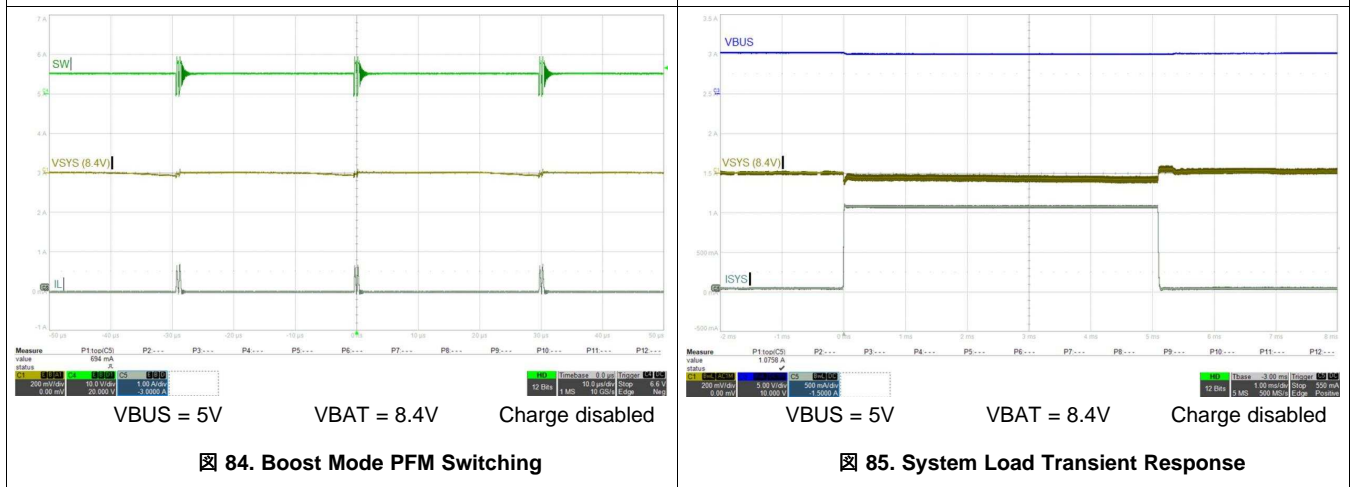
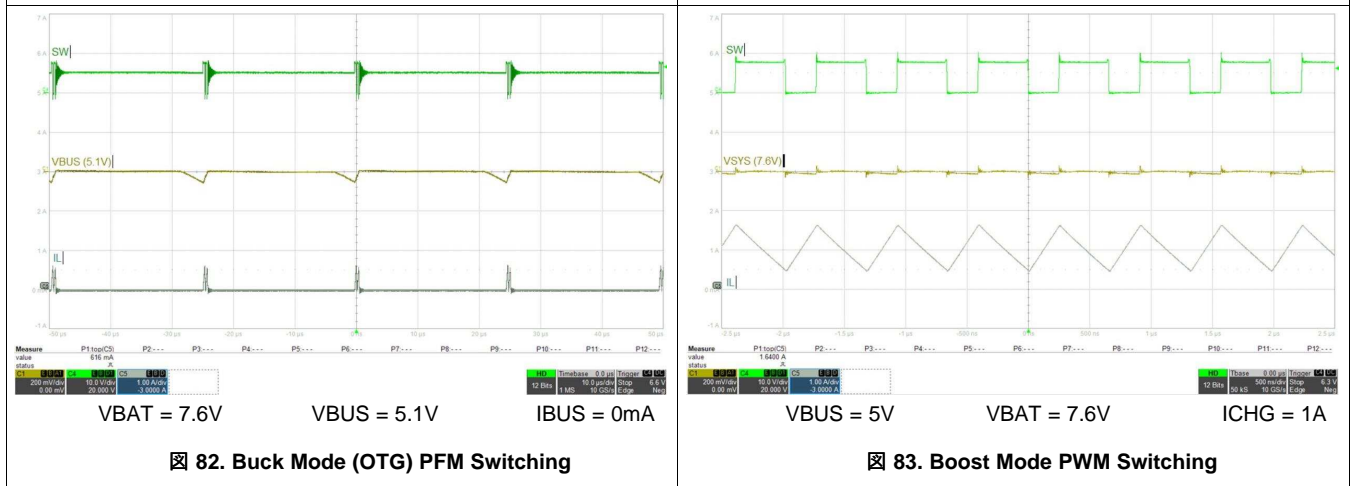
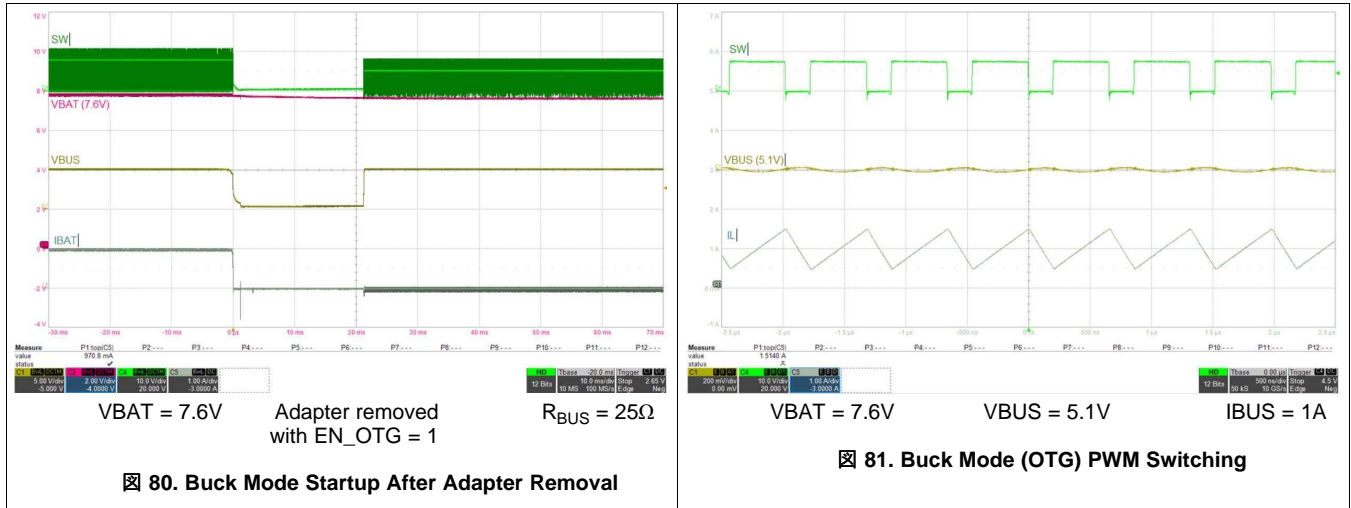
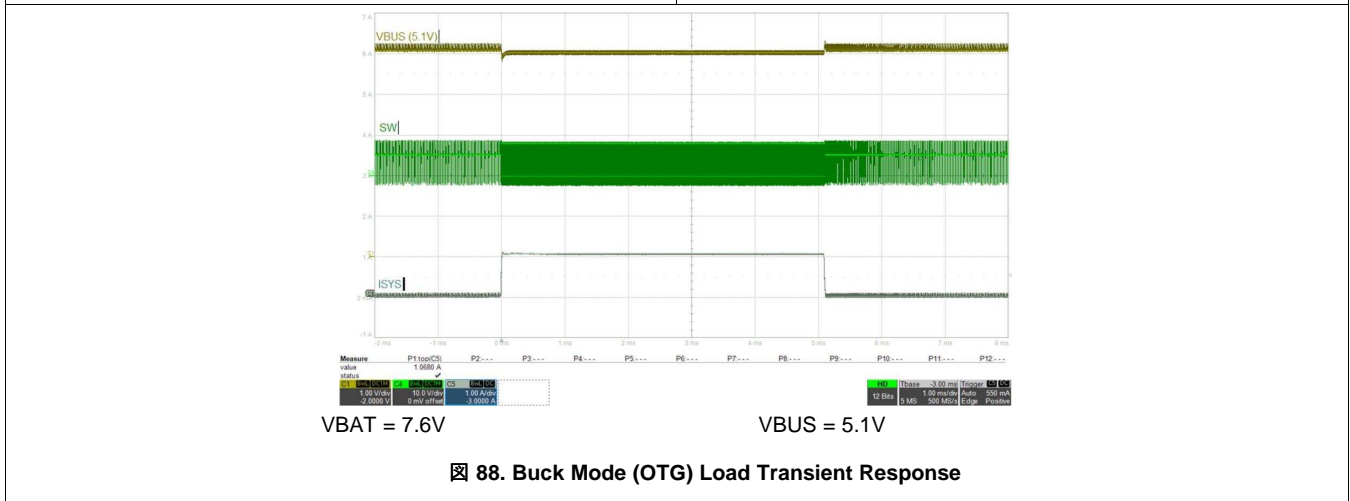
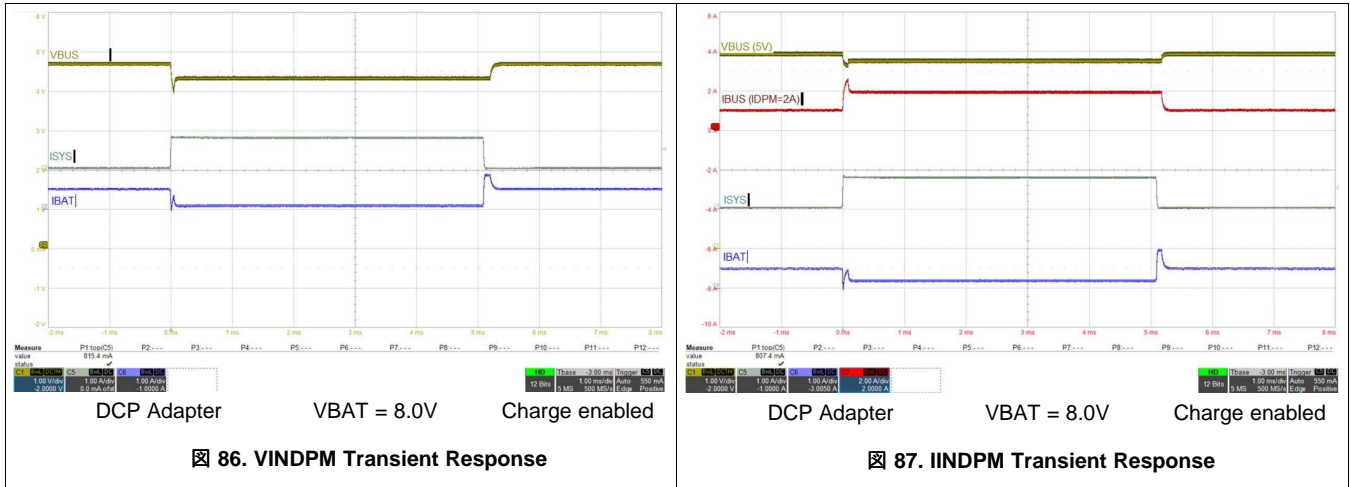

Figure 79. Buck Mode (OTG) Startup

$C_{VBUS} = 1\mu\text{F}$ ,  $C_{PMID} = 10\mu\text{F}$ ,  $C_{BAT} = 10\mu\text{F}$ ,  $C_{SYS} = 44\mu\text{F}$ ,  $L = \text{DFE252012F-1R0}$  ( $1\mu\text{H}$ ) (unless otherwise specified)



$C_{VBUS} = 1\mu\text{F}$ ,  $C_{PMID} = 10\mu\text{F}$ ,  $C_{BAT} = 10\mu\text{F}$ ,  $C_{SYS} = 44\mu\text{F}$ ,  $L = \text{DFE252012F-1R0}$  ( $1\mu\text{H}$ ) (unless otherwise specified)



## 10 Power Supply Recommendations

In order to provide an output voltage on SYS, the device requires a power supply between 3.9 V and 6.2 V input with at least 500-mA current rating connected to VBUS or a 2s Li-Ion battery with voltage > VBAT\_UVLO connected to BAT. The source current rating needs to be at least 3-A in order for the boost converter of the charger to provide maximum output power to SYS.

## 11 Layout

### 11.1 Layout Guidelines

The switching node rise and fall times should be minimized for minimum switching loss. Proper layout of the components to minimize high frequency current path loops is important to prevent electrical and magnetic field radiation and high frequency resonant problems. Here is a PCB layout priority list for proper layout. Layout PCB according to this specific order is essential.

1. Put SYS output capacitor as close to SYS and GND pins as possible. Ground connections need to be tied to the IC ground with a short copper trace connection or GND plane.
2. Place PMID input capacitor as close as possible to PMID pins and PGND pins and use shortest copper trace connection or GND plane.
3. Place inductor input terminal to SW pins as close as possible. Minimize the copper area of this trace to lower electrical and magnetic field radiation but make the trace wide enough to carry the input current. Minimize parasitic capacitance from this area to any other trace or plane.
4. Decoupling capacitors should be placed on the same side of and next to the IC and make trace connection as short as possible.
5. Route analog ground separately from power ground. Connect analog ground and connect power ground separately. Connect analog ground and power ground together using thermal pad as the single ground connection point. Or using a 0-Ω resistor to tie analog ground to power ground.
6. It is critical that the exposed thermal pad on the backside of the device package be soldered to the PCB ground. Ensure that there are sufficient thermal vias directly under the IC, connecting to the ground plane on the other layers.
7. Via size and number should be enough for a given current path.

Refer to the EVM design and the [Layout Example](#) below for the recommended component placement with trace and via locations.

## 11.2 Layout Example

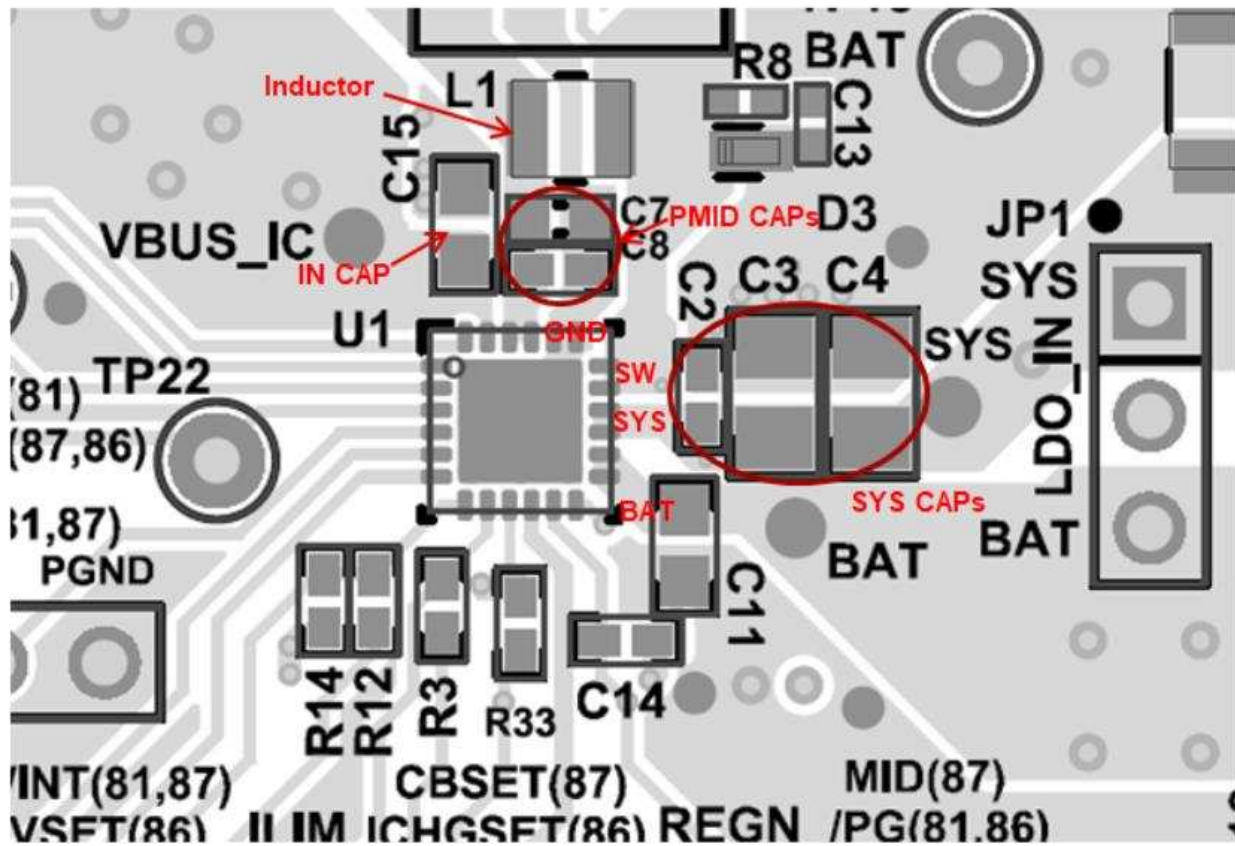

89. PCB Layout Example

## 12 デバイスおよびドキュメントのサポート

### 12.1 デバイス・サポート

#### 12.1.1 デベロッパー・ネットワークの製品に関する免責事項

デベロッパー・ネットワークの製品またはサービスに関するTIの出版物は、単独またはTIの製品、サービスと一緒に提供される場合に関係なく、デベロッパー・ネットワークの製品またはサービスの適合性に関する是認、デベロッパー・ネットワークの製品またはサービスの是認の表明を意味するものではありません。

### 12.2 ドキュメントのサポート

#### 12.2.1 関連資料

関連資料については、以下を参照してください。

- 『BQ2588x EVM User's Guide』(SLUUBU6) (英語)

#### 12.3 ドキュメントの更新通知を受け取る方法

ドキュメントの更新についての通知を受け取るには、[ti.com](http://ti.com)のデバイス製品フォルダを開いてください。右上の「アラートを受け取る」をクリックして登録すると、変更されたすべての製品情報に関するダイジェストを毎週受け取れます。変更の詳細については、修正されたドキュメントに含まれている改訂履歴をご覧ください。

#### 12.4 コミュニティ・リソース

The following links connect to TI community resources. Linked contents are provided "AS IS" by the respective contributors. They do not constitute TI specifications and do not necessarily reflect TI's views; see TI's [Terms of Use](#).

**TI E2E™ Online Community** *TI's Engineer-to-Engineer (E2E) Community*. Created to foster collaboration among engineers. At [e2e.ti.com](http://e2e.ti.com), you can ask questions, share knowledge, explore ideas and help solve problems with fellow engineers.

**Design Support** *TI's Design Support* Quickly find helpful E2E forums along with design support tools and contact information for technical support.

#### 12.5 商標

E2E is a trademark of Texas Instruments.

All other trademarks are the property of their respective owners.

#### 12.6 静電気放電に関する注意事項



すべての集積回路は、適切なESD保護方法を用いて、取扱いと保存を行うようにして下さい。

静電気放電はわずかな性能の低下から完全なデバイスの故障に至るまで、様々な損傷を与えます。高精度の集積回路は、損傷に対して敏感であり、極めてわずかなパラメータの変化により、デバイスに規定された仕様に適合しなくなる場合があります。

#### 12.7 Glossary

**SLYZ022** — *TI Glossary*.

This glossary lists and explains terms, acronyms, and definitions.

### 13 メカニカル、パッケージ、および注文情報

以降のページには、メカニカル、パッケージ、および注文に関する情報が記載されています。この情報は、そのデバイスについて利用可能な最新のデータです。このデータは予告なく変更されることがあり、ドキュメントが改訂される場合もあります。本データシートのブラウザ版を使用されている場合は、画面左側の説明をご覧ください。

**PACKAGING INFORMATION**

Orderable part number	Status (1)	Material type (2)	Package   Pins	Package qty   Carrier	RoHS (3)	Lead finish/ Ball material (4)	MSL rating/ Peak reflow (5)	Op temp (°C)	Part marking (6)
<a href="#">BQ25883RGER</a>	Active	Production	VQFN (RGE)   24	3000   LARGE T&R	Yes	NIPDAU	Level-1-260C-UNLIM	-40 to 85	BQ25883
BQ25883RGER.A	Active	Production	VQFN (RGE)   24	3000   LARGE T&R	Yes	NIPDAU	Level-1-260C-UNLIM	-40 to 85	BQ25883
BQ25883RGERG4	Active	Production	VQFN (RGE)   24	3000   LARGE T&R	Yes	NIPDAU	Level-1-260C-UNLIM	-40 to 85	BQ25883
BQ25883RGERG4.A	Active	Production	VQFN (RGE)   24	3000   LARGE T&R	Yes	NIPDAU	Level-1-260C-UNLIM	-40 to 85	BQ25883
<a href="#">BQ25883RGET</a>	Active	Production	VQFN (RGE)   24	250   SMALL T&R	Yes	NIPDAU	Level-1-260C-UNLIM	-40 to 85	BQ25883
BQ25883RGET.A	Active	Production	VQFN (RGE)   24	250   SMALL T&R	Yes	NIPDAU	Level-1-260C-UNLIM	-40 to 85	BQ25883

(1) **Status:** For more details on status, see our [product life cycle](#).

(2) **Material type:** When designated, preproduction parts are prototypes/experimental devices, and are not yet approved or released for full production. Testing and final process, including without limitation quality assurance, reliability performance testing, and/or process qualification, may not yet be complete, and this item is subject to further changes or possible discontinuation. If available for ordering, purchases will be subject to an additional waiver at checkout, and are intended for early internal evaluation purposes only. These items are sold without warranties of any kind.

(3) **RoHS values:** Yes, No, RoHS Exempt. See the [TI RoHS Statement](#) for additional information and value definition.

(4) **Lead finish/Ball material:** Parts may have multiple material finish options. Finish options are separated by a vertical ruled line. Lead finish/Ball material values may wrap to two lines if the finish value exceeds the maximum column width.

(5) **MSL rating/Peak reflow:** The moisture sensitivity level ratings and peak solder (reflow) temperatures. In the event that a part has multiple moisture sensitivity ratings, only the lowest level per JEDEC standards is shown. Refer to the shipping label for the actual reflow temperature that will be used to mount the part to the printed circuit board.

(6) **Part marking:** There may be an additional marking, which relates to the logo, the lot trace code information, or the environmental category of the part.

Multiple part markings will be inside parentheses. Only one part marking contained in parentheses and separated by a "~" will appear on a part. If a line is indented then it is a continuation of the previous line and the two combined represent the entire part marking for that device.

**Important Information and Disclaimer:** The information provided on this page represents TI's knowledge and belief as of the date that it is provided. TI bases its knowledge and belief on information provided by third parties, and makes no representation or warranty as to the accuracy of such information. Efforts are underway to better integrate information from third parties. TI has taken and continues to take reasonable steps to provide representative and accurate information but may not have conducted destructive testing or chemical analysis on incoming materials and chemicals. TI and TI suppliers consider certain information to be proprietary, and thus CAS numbers and other limited information may not be available for release.

In no event shall TI's liability arising out of such information exceed the total purchase price of the TI part(s) at issue in this document sold by TI to Customer on an annual basis.

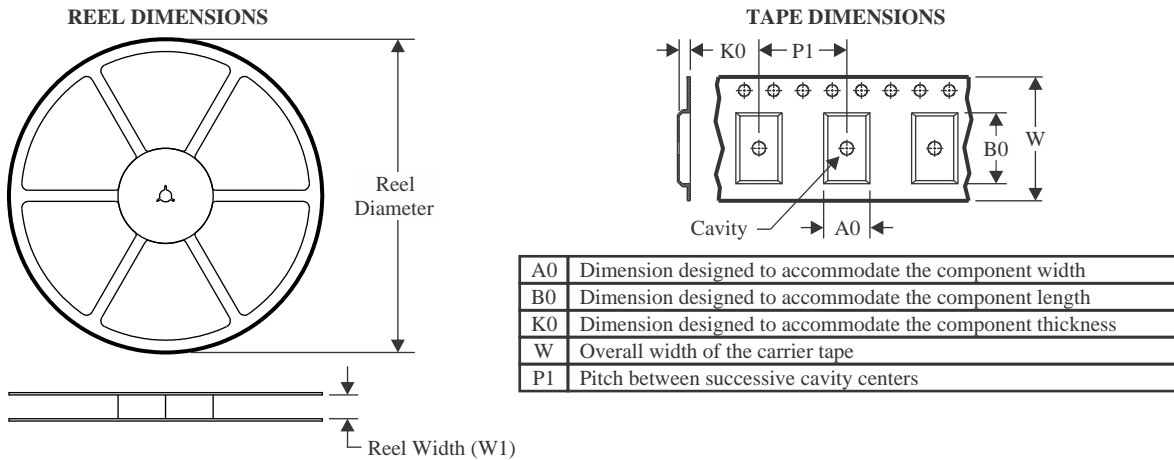
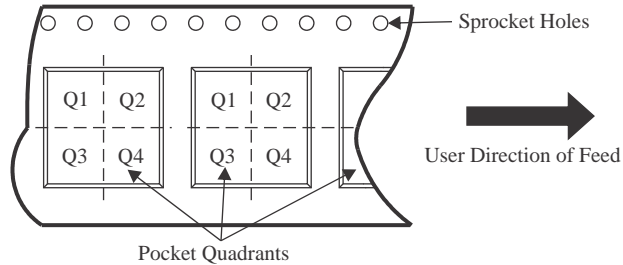

**TAPE AND REEL INFORMATION**

**QUADRANT ASSIGNMENTS FOR PIN 1 ORIENTATION IN TAPE**

\*All dimensions are nominal

Device	Package Type	Package Drawing	Pins	SPQ	Reel Diameter (mm)	Reel Width W1 (mm)	A0 (mm)	B0 (mm)	K0 (mm)	P1 (mm)	W (mm)	Pin1 Quadrant
BQ25883RGER	VQFN	RGE	24	3000	330.0	12.4	4.3	4.3	1.3	8.0	12.0	Q2
BQ25883RGERG4	VQFN	RGE	24	3000	330.0	12.4	4.25	4.25	1.15	8.0	12.0	Q2
BQ25883RGET	VQFN	RGE	24	250	180.0	12.4	4.25	4.25	1.15	8.0	12.0	Q2

**TAPE AND REEL BOX DIMENSIONS**

\*All dimensions are nominal

Device	Package Type	Package Drawing	Pins	SPQ	Length (mm)	Width (mm)	Height (mm)
BQ25883RGER	VQFN	RGE	24	3000	356.0	356.0	36.0
BQ25883RGERG4	VQFN	RGE	24	3000	367.0	367.0	35.0
BQ25883RGET	VQFN	RGE	24	250	210.0	185.0	35.0

**RGE 24**

**GENERIC PACKAGE VIEW**

**VQFN - 1 mm max height**

PLASTIC QUAD FLATPACK - NO LEAD

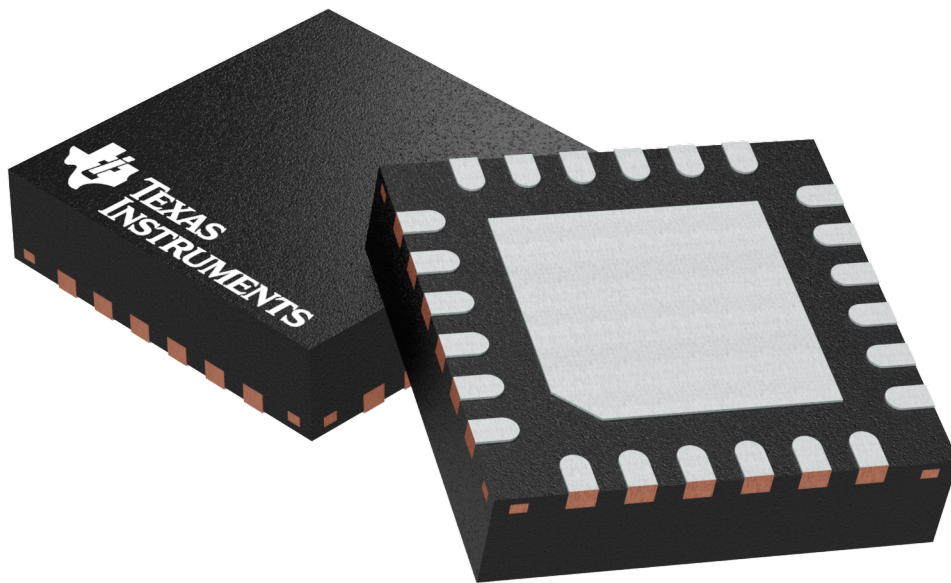

Images above are just a representation of the package family, actual package may vary.  
Refer to the product data sheet for package details.

4204104/H

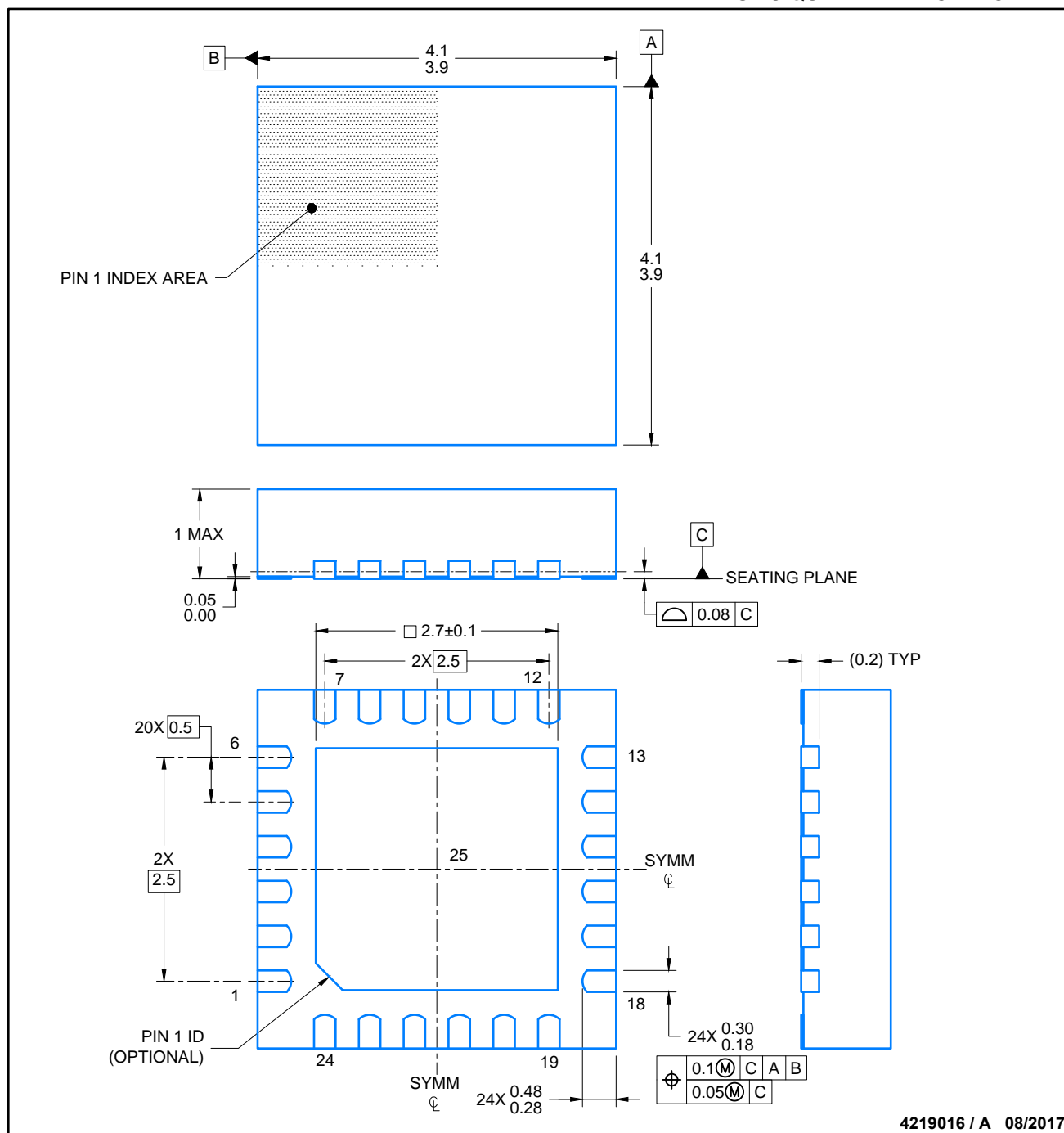

NOTES:

1. All linear dimensions are in millimeters. Any dimensions in parenthesis are for reference only. Dimensioning and tolerancing per ASME Y14.5M.
2. This drawing is subject to change without notice.
3. The package thermal pad must be soldered to the printed circuit board for thermal and mechanical performance.

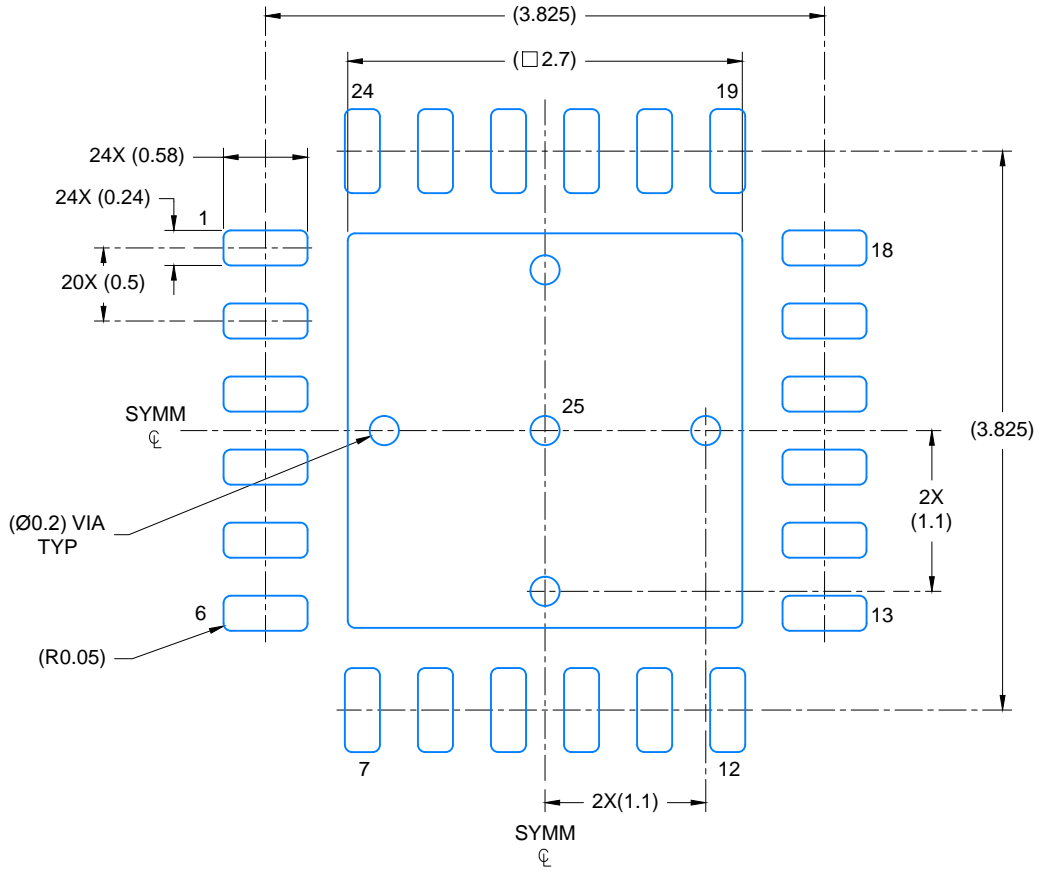

LAND PATTERN EXAMPLE  
SCALE: 20X

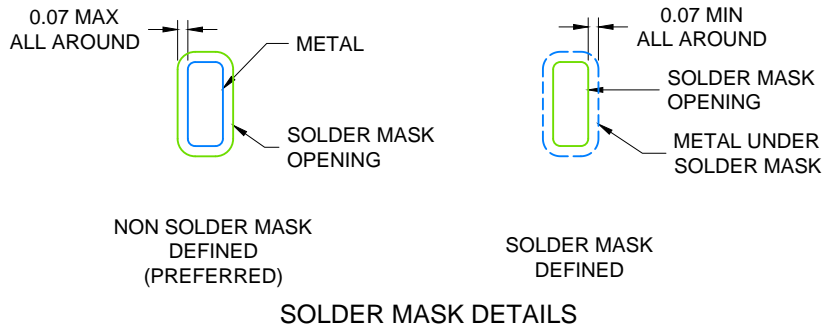

4219016 / A 08/2017

NOTES: (continued)

4. This package is designed to be soldered to a thermal pad on the board. For more information, see Texas Instruments literature number SLUA271 ([www.ti.com/lit/slua271](http://www.ti.com/lit/slua271)).
5. Solder mask tolerances between and around signal pads can vary based on board fabrication site.

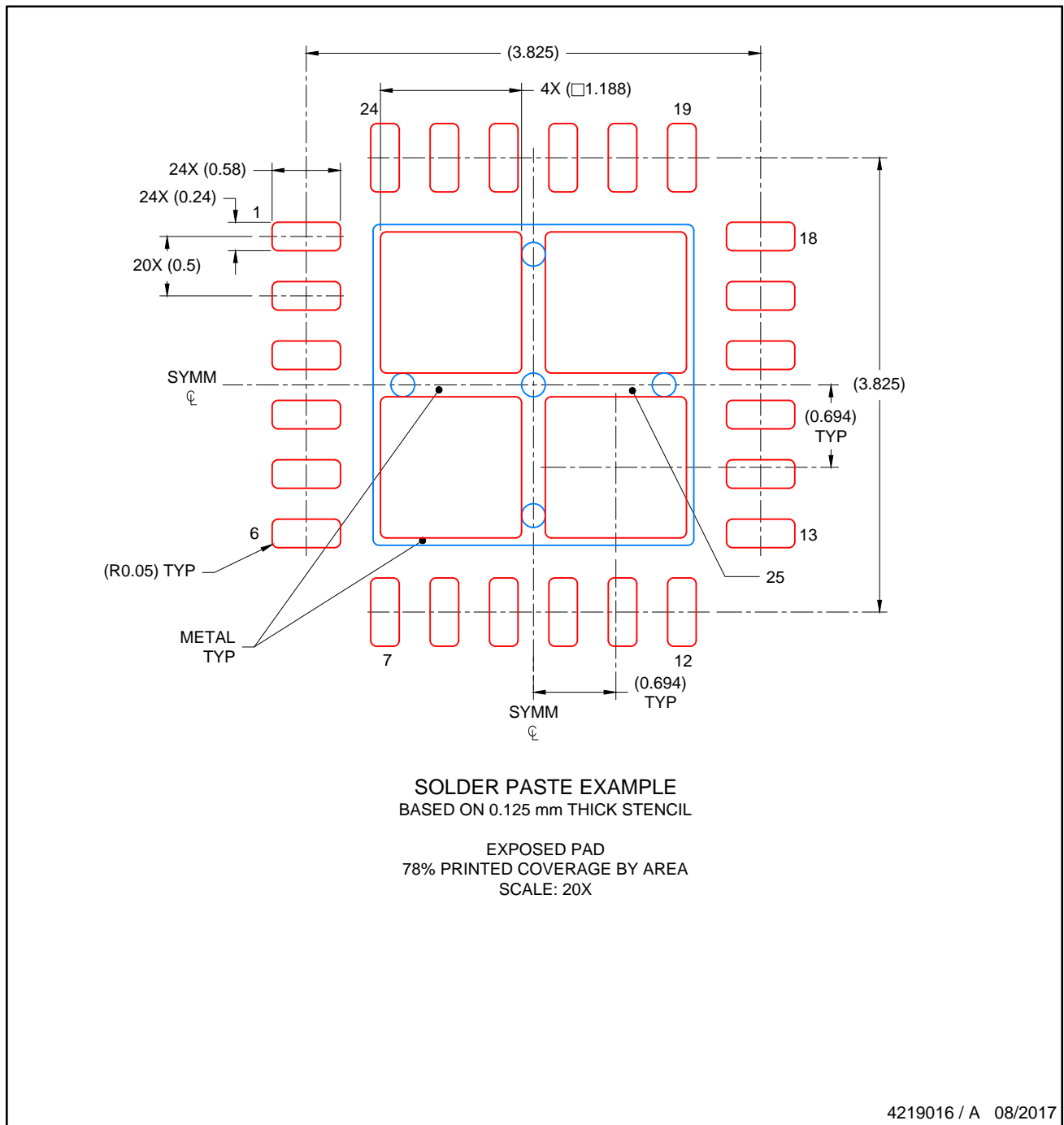

NOTES: (continued)

6. Laser cutting apertures with trapezoidal walls and rounded corners may offer better paste release. IPC-7525 may have alternate design recommendations..

## 重要なお知らせと免責事項

TI は、技術データと信頼性データ (データシートを含みます)、設計リソース (リファレンス デザインを含みます)、アプリケーションや設計に関する各種アドバイス、Web ツール、安全性情報、その他のリソースを、欠陥が存在する可能性のある「現状のまま」提供しており、商品性および特定目的に対する適合性の黙示保証、第三者の知的財産権の非侵害保証を含むいかなる保証も、明示的または黙示的にかかわらず拒否します。

これらのリソースは、TI 製品を使用する設計の経験を積んだ開発者への提供を意図したものです。(1) お客様のアプリケーションに適した TI 製品の選定、(2) お客様のアプリケーションの設計、検証、試験、(3) お客様のアプリケーションに該当する各種規格や、その他のあらゆる安全性、セキュリティ、規制、または他の要件への確実な適合に関する責任を、お客様のみが単独で負うものとし、

上記の各種リソースは、予告なく変更される可能性があります。これらのリソースは、リソースで説明されている TI 製品を使用するアプリケーションの開発の目的でのみ、TI はその使用をお客様に許諾します。これらのリソースに関して、他の目的で複製することや掲載することは禁止されています。TI や第三者の知的財産権のライセンスが付与されている訳ではありません。お客様は、これらのリソースを自身で使用した結果発生するあらゆる申し立て、損害、費用、損失、責任について、TI およびその代理人を完全に補償するものとし、TI は一切の責任を拒否します。

TI の製品は、[TI の販売条件](#)、[TI の総合的な品質ガイドライン](#)、[ti.com](#) または TI 製品などに関連して提供される他の適用条件に従い提供されます。TI がこれらのリソースを提供することは、適用される TI の保証または他の保証の放棄の拡大や変更を意味するものではありません。TI がカスタム、またはカスタマー仕様として明示的に指定していない限り、TI の製品は標準的なカタログに掲載される汎用機器です。

お客様がいかなる追加条項または代替条項を提案する場合も、TI はそれらに異議を唱え、拒否します。

Copyright © 2026, Texas Instruments Incorporated

最終更新日 : 2025 年 10 月