

## TLV62130x 3V~17V 3A、3x3 QFNパッケージ、降圧型コンバータ

### 1 特長

- DCS-Control™ トポロジ
- 入力電圧範囲: 3V~17V
- 最大3Aの出力電流
- 出力電圧を0.9V~5.5Vに変更可能
- ピンにより出力電圧を選択可能(公称値、+5%)
- ソフトスタートとトラッキングをプログラム可能
- シームレスなパワーセーブ・モード移行
- 静止電流19μA (標準値)
- 動作周波数を選択可能
- パワー・グッド出力
- 100%デューティ・サイクル・モード
- 短絡保護機能
- 過熱保護機能
- 改良された機能セットについては、[TPS62130](#)を参照
- [TLV62150](#)とピン互換
- 3mmx3mmのVQFN-16パッケージで供給
- [WEBENCH® Power Designer](#)により、TLV62130を使用するカスタム設計を作成

### 2 アプリケーション

- 標準の12Vレール電源
- 単一または複数のリチウムイオン・バッテリーからのPOL電源
- モータ・ドライブ、電子的POS (Point of Sales)
- モバイルPC、タブレット、モデム、カメラ
- TV、セットトップ・ボックス、オーディオ

### 3 概要

TLV62130デバイスは簡単に使用できる同期降圧型DC/DCコンバータで、電力密度の高いアプリケーション用に最適化されています。スイッチング周波数が標準値で2.5MHzと高いため、小型のインダクタを使用でき、高速な過渡応答が実現されるほか、DCS-Control™ トポロジを使用しているため出力電圧が非常に正確です。

3V~17Vの広い入力電圧範囲で動作するため、このデバイスはリチウムイオンや他のバッテリー、および12Vの中間電力レールで動作するシステムに理想的です。0.9V~5.5Vの出力電圧で、3Aまでの出力電流を連続的にサポートします(100%デューティ・サイクル・モード時)。

出力電圧のスタートアップ・ランプはソフトスタート・ピンにより制御されるため、スタンドアロンの電源またはトラッキング構成で動作できます。イネーブル・ピンおよびオープン・ドレインのパワー・グッド・ピンの構成により、電源シーケンシングも可能です。

パワーセービング・モードでは、このデバイスは $V_{IN}$ から約19μAの静止電流を消費します。負荷が小さい時には自動的かつシームレスにパワーセービング・モードへ移行するため、負荷範囲全体にわたって高い効率が維持されます。シャットダウン・モードではデバイスがオフになり、シャットダウン時の消費電流は2μA未満です。

このデバイスは、3mmx3mm (RGT)の16ピンVQFNパッケージで供給されます。

#### 製品情報(1)

| 型番        | パッケージ     | 本体サイズ(公称)     |
|-----------|-----------|---------------|
| TLV62130  | VQFN (16) | 3.00mmx3.00mm |
| TLV62130A |           |               |

(1) 提供されているすべてのパッケージについては、このデータシートの末尾にある注文情報を参照してください。

#### 代表的なアプリケーションの回路図

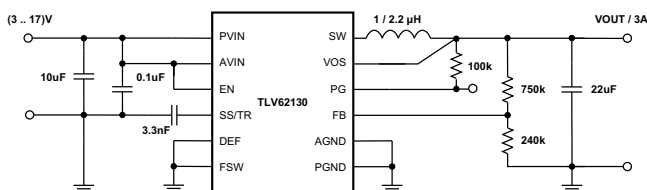

#### 効率と出力電流との関係

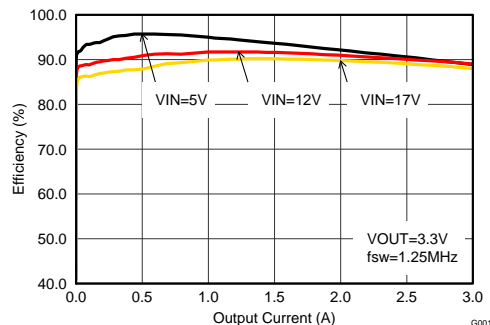

## 目次

|          |  |          |           |   |           |
|----------|--|----------|-----------|---|-----------|
| <b>1</b> | <b>特長</b> .....                              | <b>1</b> | <b>9</b>  | <b>Application and Implementation</b> ..... | <b>13</b> |
| <b>2</b> | <b>アプリケーション</b> .....                        | <b>1</b> | 9.1       | Application Information.....                | 13        |
| <b>3</b> | <b>概要</b> .....                              | <b>1</b> | 9.2       | Typical Application .....                   | 13        |
| <b>4</b> | <b>改訂履歴</b> .....                            | <b>2</b> | 9.3       | System Examples .....                       | 24        |
| <b>5</b> | <b>Device Comparison Table</b> .....         | <b>4</b> | <b>10</b> | <b>Power Supply Recommendations</b> .....   | <b>27</b> |
| <b>6</b> | <b>Pin Configuration and Functions</b> ..... | <b>4</b> | <b>11</b> | <b>Layout</b> .....                         | <b>28</b> |
| <b>7</b> | <b>Specifications</b> .....                  | <b>5</b> | 11.1      | Layout Guidelines .....                     | 28        |
| 7.1      | Absolute Maximum Ratings .....               | 5        | 11.2      | Layout Example .....                        | 28        |
| 7.2      | ESD Ratings .....                            | 5        | 11.3      | Thermal Considerations .....                | 29        |
| 7.3      | Recommended Operating Conditions.....        | 5        | <b>12</b> | <b>デバイスおよびドキュメントのサポート</b> .....             | <b>30</b> |
| 7.4      | Thermal Information .....                    | 5        | 12.1      | デバイス・サポート.....                              | 30        |
| 7.5      | Electrical Characteristics.....              | 6        | 12.2      | ドキュメントの更新通知を受け取る方法.....                     | 30        |
| 7.6      | Typical Characteristics.....                 | 7        | 12.3      | ドキュメントのサポート.....                            | 30        |
| <b>8</b> | <b>Detailed Description</b> .....            | <b>8</b> | 12.4      | 関連リンク.....                                  | 30        |
| 8.1      | Overview .....                               | 8        | 12.5      | コミュニティ・リソース .....                           | 31        |
| 8.2      | Functional Block Diagram .....               | 8        | 12.6      | Trademarks .....                            | 31        |
| 8.3      | Feature Description.....                     | 9        | 12.7      | Electrostatic Discharge Caution.....        | 31        |
| 8.4      | Device Functional Modes.....                 | 10       | 12.8      | Glossary .....                              | 31        |
|          |  |          | <b>13</b> | <b>メカニカル、パッケージ、および注文情報</b> .....            | <b>31</b> |

## 4 改訂履歴

資料番号末尾の英字は改訂を表しています。その改訂履歴は英語版に準じています。

| <b>Revision G (January 2017) to Revision H</b>   | <b>Page</b> |
|--|-------------|
| • 可変出力電圧を「0.9V~5V」から「0.9V~5.5V」へ全面的に変更。.....   | 1           |
| • Changed the V <sub>OUT</sub> MAX value From: 5 V To: 5.5 V in the <a href="#">Electrical Characteristics</a> table ..... | 6           |

| <b>Revision F (January 2017) to Revision G</b>            | <b>Page</b> |
|---|-------------|
| • WEBENCH®の情報を「特長」、「詳細な設計手順」、「開発サポート」の各セクションに Added ..... | 1           |

| <b>Revision E (July 2016) to Revision F</b>   | <b>Page</b> |
|---|-------------|
| • Added ac voltage specification for SW pin in <a href="#">Absolute Maximum Ratings</a> ..... | 5           |

| <b>Revision D (August 2015) to Revision E</b>   | <b>Page</b> |
|---|-------------|
| • <a href="#">特長</a> に「TLV62150とピン互換」を Added .....  | 1           |
| • Changed temperature data in the <a href="#">Thermal Information</a> table.....  | 5           |
| • Changed V <sub>OUT</sub> Initial Output Voltage Accuracy from "-2.5% MIN and +2.5% MAX" to "780 mV MIN, 800 mV TYP, 820 mV MAX" in the <a href="#">Electrical Characteristics</a> table ..... | 6           |
| • Added information to the <a href="#">Power Good (PG)</a> section. ....  | 9           |
| • Changed <a href="#">Layout Example</a> image .....  | 28          |
| • Added 「 <a href="#">ドキュメントの更新通知を受け取る方法</a> 」セクション.....  | 30          |

| <b>Revision C (June 2015) to Revision D</b>    | <b>Page</b> |
|--|-------------|
| • 入力電圧範囲を「4V~17V」から「3V~17V」へ全面的に Changed ..... | 1           |

**Revision B (June 2013) to Revision C**
**Page**

|  |   |
|--|---|
| <ul style="list-style-type: none"> <li>• 「ESD定格」の表、「機能説明」セクション、「デバイスの機能モード」セクション、「アプリケーションと実装」セクション、「電源に関する推奨事項」セクション、「レイアウト」セクション、「デバイスおよびドキュメントのサポート」セクション、「メカニカル、パッケージ、および注文情報」セクション Added .....</li> </ul> | 1 |
|--|---|

**Revision A (February 2013) to Revision B**
**Page**

|  |                    |
|--|--------------------|
| <ul style="list-style-type: none"> <li>• デバイスTLV62130Aをデータシートに Added .....</li> <li>• Added text to Power Good (PG) section regarding TLV62130A function .....</li> <li>• Added additional option to Pin-Selectable Output Voltage (DEF) section footnote. ....</li> <li>• Added text to Frequency Selection (FSW) section regarding pin control.....</li> </ul> | 1<br>9<br>10<br>10 |
|--|--------------------|

**20122**
**Page**

|  |          |
|--|----------|
| <ul style="list-style-type: none"> <li>• Added text to Power Save Mode Operation section for clarification. ....</li> <li>• Changed Layout Considerations description for clarification. ....</li> </ul> | 11<br>28 |
|--|----------|

## 5 Device Comparison Table

| PART NUMBER | OUTPUT VOLTAGE | Power Good Logic Level (EN=Low) |
|-------------|----------------|---------------------------------|
| TLV62130    | Adjustable     | High Impedance                  |
| TLV62130A   | Adjustable     | Low                             |

## 6 Pin Configuration and Functions

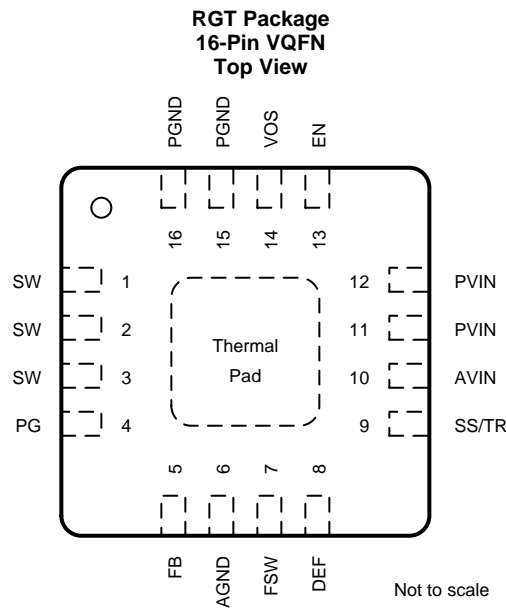

### Pin Functions

| PIN <sup>(1)</sup>  |         | I/O | DESCRIPTION   |
|---------------------|---------|-----|---|
| NAME                | NO.     |     |   |
| AGND                | 6       | —   | Analog Ground. Must be connected directly to the Exposed Thermal Pad and common ground plane.   |
| AVIN                | 10      | I   | Supply voltage for control circuitry. Connect to same source as PVIN.   |
| DEF                 | 8       | I   | Output Voltage Scaling (Low = nominal, High = nominal + 5%) <sup>(2)</sup>  |
| EN                  | 13      | I   | Enable input (High = enabled, Low = disabled) <sup>(2)</sup>  |
| FB                  | 5       | I   | Voltage feedback. Connect resistive voltage divider to this pin.  |
| FSW                 | 7       | I   | Switching Frequency Select (Low ≈ 2.5 MHz, High ≈ 1.25 MHz <sup>(3)</sup> for typical operation) <sup>(2)</sup>   |
| PG                  | 4       | O   | Output power good (High = V <sub>OUT</sub> ready, Low = V <sub>OUT</sub> below nominal regulation) ; open drain (requires pull-up resistor)   |
| PGND                | 15, 16  | —   | Power ground. Must be connected directly to the Exposed Thermal Pad and common ground plane.  |
| PVIN                | 11, 12  | I   | Supply voltage for power stage. Connect to same source as AVIN.   |
| SS/TR               | 9       | I   | Soft-Start / Tracking Pin. An external capacitor connected to this pin sets the internal voltage reference rise time. It can be used for tracking and sequencing.                                       |
| SW                  | 1, 2, 3 | O   | Switch node, which is connected to the internal MOSFET switches. Connect inductor between SW and output capacitor.  |
| VOS                 | 14      | I   | Output voltage sense pin and connection for the control loop circuitry.   |
| Exposed Thermal Pad | —       | —   | Must be connected to AGND (pin 6), PGND (pin 15,16) and common ground plane. See <a href="#">Layout Example</a> . Must be soldered to achieve appropriate power dissipation and mechanical reliability. |

(1) For more information about connecting pins, see [Detailed Description](#) and [Application and Implementation](#) sections.

(2) An internal pull-down resistor keeps logic level low, if pin is floating.

(3) Connect FSW to V<sub>OUT</sub> or PG in this case.

## 7 Specifications

### 7.1 Absolute Maximum Ratings

|                                |  | MIN  | MAX                  | UNIT |
|--------------------------------|--|------|----------------------|------|
| Pin voltage <sup>(1)</sup>     | AVIN, PVIN                             | -0.3 | 20                   | V    |
|                                | EN, SS/TR                              | -0.3 | V <sub>IN</sub> +0.3 |      |
|                                | SW (DC)                                | -0.3 | V <sub>IN</sub> +0.3 | V    |
|                                | SW (AC), less than 10ns <sup>(2)</sup> | -2   | 24.5                 |      |
|                                | DEF, FSW, FB, PG, VOS                  | -0.3 | 7                    | V    |
| Power Good sink current        | PG                                     |      | 10                   | mA   |
| Operating junction temperature | T <sub>J</sub>                         | -40  | 125                  | °C   |
| Storage temperature            | T <sub>stg</sub>                       | -65  | 150                  |      |

(1) All voltages are with respect to network ground terminal.

(2) While switching.

### 7.2 ESD Ratings

|                  |  |  | VALUE | UNIT |
|------------------|--|--|-------|------|
| V <sub>ESD</sub> | Electrostatic discharge <sup>(1)</sup> | Human body model (HBM), per ANSI/ESDA/JEDEC JS-001, all pins <sup>(2)</sup>              | ±2000 | V    |
|                  |  | Charged device model (CDM), per JEDEC specification JESD22-C101, all pins <sup>(3)</sup> | ±500  |      |

(1) ESD testing is performed according to the respective JESD22 JEDEC standard.

(2) JEDEC document JEP155 states that 500-V HBM allows safe manufacturing with a standard ESD control process.

(3) JEDEC document JEP157 states that 250-V CDM allows safe manufacturing with a standard ESD control process.

### 7.3 Recommended Operating Conditions

|  |  | MIX | MAX | UNIT |
|--|--|-----|-----|------|
| Supply Voltage                                 |  | 3   | 17  | V    |
| Operating free air temperature, T <sub>A</sub> |  | -40 | 85  | °C   |
| Operating junction temperature, T <sub>J</sub> |  | -40 | 125 |      |

### 7.4 Thermal Information

| THERMAL METRIC <sup>(1)</sup> |  | TLV62130   | UNIT |
|-------------------------------|--|------------|------|
|                               |  | RGT [VQFN] |      |
|                               |  | 16 PINS    |      |
| R <sub>θJA</sub>              | Junction-to-ambient thermal resistance       | 45         | °C/W |
| R <sub>θJC(top)</sub>         | Junction-to-case (top) thermal resistance    | 53.6       | °C/W |
| R <sub>θJB</sub>              | Junction-to-board thermal resistance         | 17.4       | °C/W |
| Ψ <sub>JT</sub>               | Junction-to-top characterization parameter   | 1.1        | °C/W |
| Ψ <sub>JB</sub>               | Junction-to-board characterization parameter | 17.4       | °C/W |
| R <sub>θJC(bot)</sub>         | Junction-to-case (bottom) thermal resistance | 4.5        | °C/W |

(1) For more information about traditional and new thermal metrics, see the [Semiconductor and IC Package Thermal Metrics](#) application report.

## 7.5 Electrical Characteristics

over operating free-air temperature range ( $T_A = -40^\circ\text{C}$  to  $+85^\circ\text{C}$ ), typical values at  $V_{IN} = 12\text{ V}$  and  $T_A = 25^\circ\text{C}$  (unless otherwise noted)

| PARAMETER                                |  | TEST CONDITIONS  | MIN  | TYP           | MAX | UNIT             |
|--|--|--|------|---------------|-----|------------------|
| <b>POWER SUPPLY</b>                      |  |  |      |               |     |                  |
| $V_{IN}$                                 | Input Voltage Range <sup>(1)</sup>   |  | 3    |               | 17  | V                |
| $I_Q$                                    | Operating Quiescent Current  | EN=High, $I_{OUT} = 0\text{ mA}$ , device not switching                |      | 19            | 27  | $\mu\text{A}$    |
| $I_{SD}$                                 | Shutdown Current <sup>(2)</sup>  | EN=Low   |      | 1.5           | 4   | $\mu\text{A}$    |
| $V_{UVLO}$                               | Undervoltage Lockout Threshold   | Falling Input Voltage (PWM mode operation)                             | 2.6  | 2.7           | 2.8 | V                |
|  |  | Hysteresis   |      | 200           |     | mV               |
| $T_{SD}$                                 | Thermal Shutdown Temperature   |  |      | 160           |     | $^\circ\text{C}$ |
|  | Thermal Shutdown Hysteresis  |  |      | 20            |     |                  |
| <b>CONTROL (EN, DEF, FSW, SS/TR, PG)</b> |  |  |      |               |     |                  |
| $V_H$                                    | High Level Input Threshold Voltage (EN, DEF, FSW)  |  | 0.9  |               |     | V                |
| $V_L$                                    | Low Level Input Threshold Voltage (EN, DEF, FSW)   |  |      |               | 0.3 | V                |
| $I_{LKG}$                                | Input Leakage Current (EN, DEF, FSW)   | EN = $V_{IN}$ or GND; DEF, FSW = $V_{OUT}$ or GND                      |      | 0.01          | 1   | $\mu\text{A}$    |
| $V_{TH\_PG}$                             | Power Good Threshold Voltage   | Rising (% $V_{OUT}$ )  | 92%  | 95%           | 98% |                  |
|  |  | Falling (% $V_{OUT}$ )   | 87%  | 90%           | 94% |                  |
| $V_{OL\_PG}$                             | Power Good Output Low  | $I_{PG} = -2\text{ mA}$  |      | 0.07          | 0.3 | V                |
| $I_{LKG\_PG}$                            | Input Leakage Current (PG)   | $V_{PG} = 1.8\text{ V}$  |      | 1             | 400 | nA               |
| $I_{SS/TR}$                              | SS/TR Pin Source Current   |  | 2.3  | 2.5           | 2.7 | $\mu\text{A}$    |
| <b>POWER SWITCH</b>                      |  |  |      |               |     |                  |
| $R_{DS(ON)}$                             | High-Side MOSFET ON-Resistance   | $V_{IN} \geq 6\text{ V}$   |      | 90            |     | $\text{m}\Omega$ |
|  | Low-Side MOSFET ON-Resistance  | $V_{IN} \geq 6\text{ V}$   |      | 40            |     | $\text{m}\Omega$ |
| $I_{LIMF}$                               | High-Side MOSFET Forward Current Limit <sup>(3)</sup>  | $V_{IN} = 12\text{ V}$ , $T_A = 25^\circ\text{C}$                      | 3.6  | 4.2           |     | A                |
| <b>OUTPUT</b>                            |  |  |      |               |     |                  |
| $I_{LKG\_FB}$                            | Input Leakage Current (FB)   | $V_{FB} = 0.8\text{ V}$  |      | 1             | 100 | nA               |
| $V_{OUT}$                                | Output Voltage Range   | $V_{IN} \geq V_{OUT}$  | 0.9  |               | 5.5 | V                |
|  | DEF (Output Voltage Programming)   | DEF=0 (GND)  |      | $V_{OUT}$     |     |                  |
|  |  | DEF=1 ( $V_{OUT}$ )  |      | $V_{OUT}+5\%$ |     |                  |
|  | Initial Output Voltage Accuracy <sup>(4)</sup>   | PWM mode operation, $V_{IN} \geq V_{OUT} + 1\text{ V}$                 | 780  | 800           | 820 | mV               |
|  | Load Regulation <sup>(5)</sup>   | $V_{IN} = 12\text{ V}$ , $V_{OUT} = 3.3\text{ V}$ , PWM mode operation |      | 0.05          |     | %/A              |
| Line Regulation <sup>(5)</sup>           | $4\text{ V} \leq V_{IN} \leq 17\text{ V}$ , $V_{OUT} = 3.3\text{ V}$ , $I_{OUT} = 1\text{ A}$ , PWM mode operation |  | 0.02 |               | %/V |                  |

(1) The device is still functional down to Undervoltage Lockout (see parameter  $V_{UVLO}$ ).

(2) Current into AVIN + PVIN pin.

(3) This is the static current limit. It can be temporarily higher in applications due to internal propagation delay (see [Current Limit and Short Circuit Protection](#)).

(4) This is the accuracy provided at the FB pin (line and load regulation effects are not included).

(5) Line and load regulation depend on external component selection and layout (see [Figure 20](#) and [Figure 21](#)).

## 7.6 Typical Characteristics

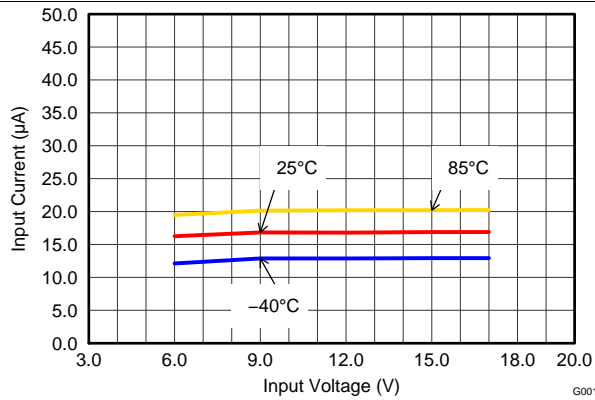

Figure 1. Quiescent Current

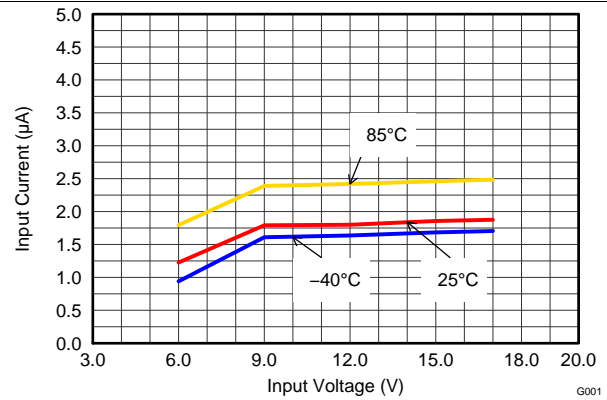

Figure 2. Shutdown Current

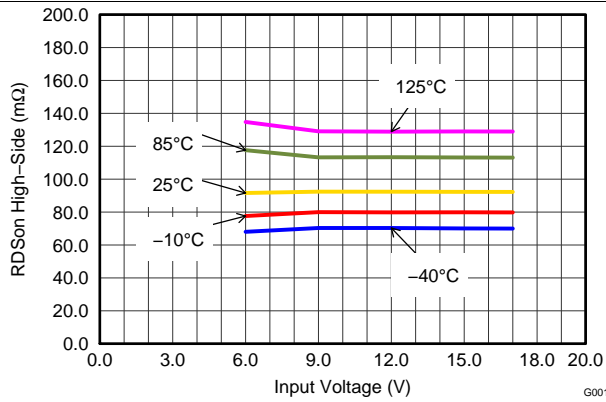

Figure 3. High-Side Switch Resistance

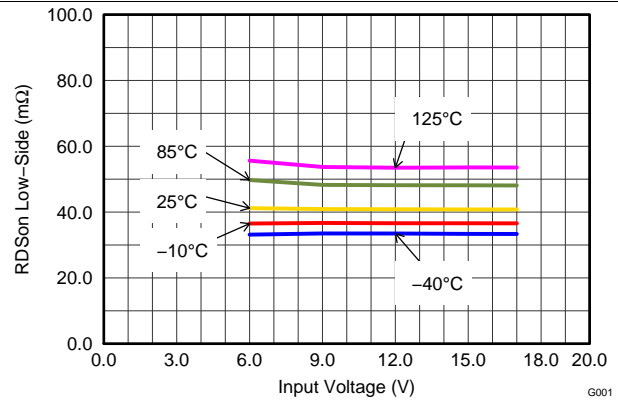

Figure 4. Low-Side Switch Resistance

## 8 Detailed Description

### 8.1 Overview

The TLV62130 synchronous switched-mode power converters are based on DCS-Control™ (Direct Control with Seamless Transition into Power Save Mode), an advanced regulation topology, that combines the advantages of hysteretic, voltage mode and current mode control including an AC loop directly associated to the output voltage. This control loop takes information about output voltage changes and feeds it directly to a fast comparator stage. It sets the switching frequency, which is constant for steady state operating conditions, and provides immediate response to dynamic load changes. To get accurate DC load regulation, a voltage feedback loop is used. The internally compensated regulation network achieves fast and stable operation with small external components and low ESR capacitors.

The DCS-Control™ topology supports Pulse Width Modulation (PWM) mode for medium and heavy load conditions and a Power Save Mode at light loads. During PWM, it operates at its nominal switching frequency in continuous conduction mode. This frequency is typically about 2.5 MHz or 1.25 MHz with a controlled frequency variation depending on the input voltage. If the load current decreases, the converter enters Power Save Mode to sustain high efficiency down to very light loads. In Power Save Mode the switching frequency decreases linearly with the load current. Since DCS-Control™ supports both operation modes within one single building block, the transition from PWM to Power Save Mode is seamless without effects on the output voltage. An internal current limit supports nominal output currents of up to 3 A.

The TLV62130 offers both excellent DC voltage and superior load transient regulation, combined with very low output voltage ripple, minimizing interference with RF circuits.

### 8.2 Functional Block Diagram

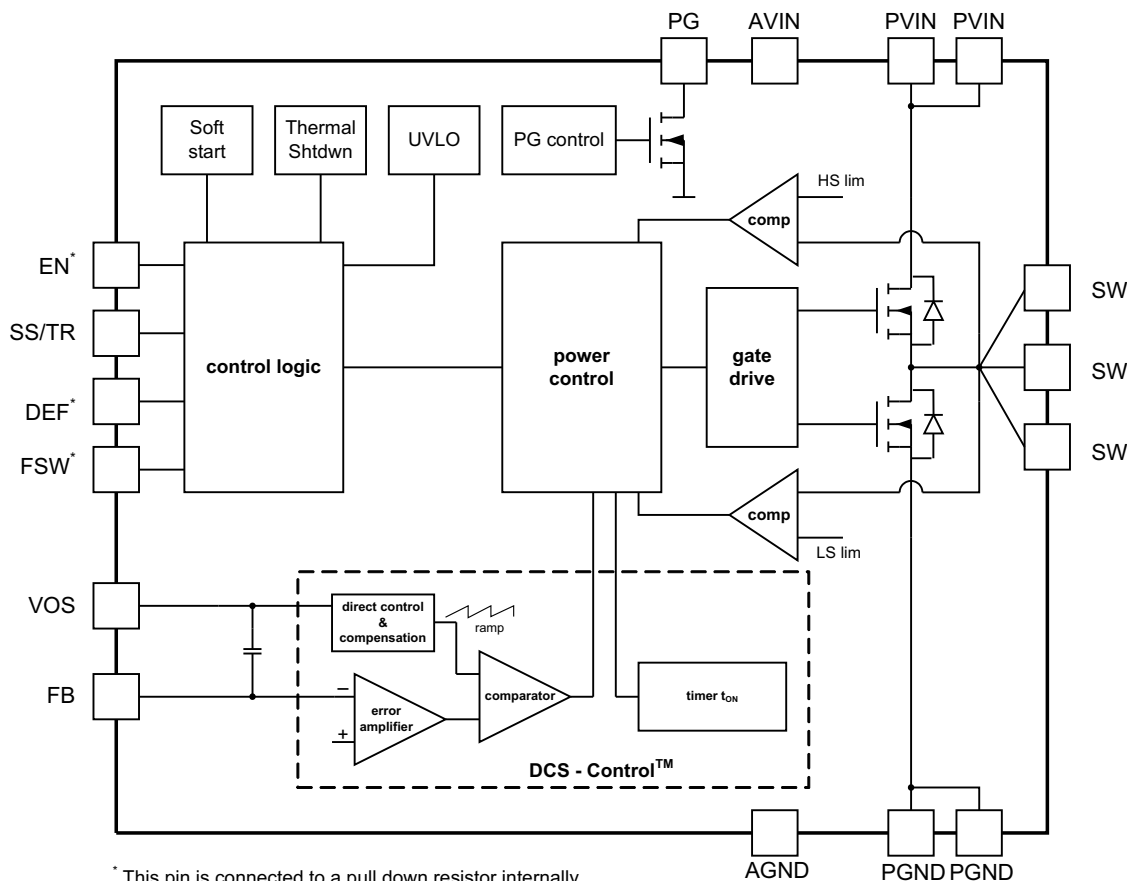

\* This pin is connected to a pull down resistor internally (see Feature Description section).

## 8.3 Feature Description

### 8.3.1 Enable / Shutdown (EN)

When Enable (EN) is set High, the device starts operation. Shutdown is forced if EN is pulled Low with a shutdown current of typically 1.5  $\mu$ A. During shutdown, the internal power MOSFETs as well as the entire control circuitry are turned off. The EN signal must be set externally to High or Low. An internal pull-down resistor of about 400 k $\Omega$  is connected and keeps EN logic low, if the pin is floating. It is disconnected if the pin is High.

Connecting the EN pin to an appropriate output signal of another power rail provides sequencing of multiple power rails.

### 8.3.2 Soft Start / Tracking (SS/TR)

The internal soft start circuitry controls the output voltage slope during startup. This avoids excessive inrush current and ensures a controlled output voltage rise time. It also prevents unwanted voltage drops from high-impedance power sources or batteries. When EN is set to start device operation, the device starts switching after a delay of about 50  $\mu$ s and VOUT rises with a slope controlled by an external capacitor connected to the SS/TR pin. See [Figure 32](#) and [Figure 33](#) for typical startup operation.

Using a very small capacitor (or leaving SS/TR pin un-connected) provides fastest startup behavior. There is no theoretical limit for the longest startup time. The TLV62130 can start into a pre-biased output. During monotonic pre-biased startup, the low-side MOSFET is not allowed to turn on until the device's internal ramp sets an output voltage above the pre-bias voltage. As long as the output is below about 0.5 V, a reduced current limit of typically 1.6 A is set internally. If the device is set to shutdown (EN=GND), undervoltage lockout or thermal shutdown, an internal resistor pulls the SS/TR pin down to ensure a proper low level. Returning from those states causes a new startup sequence as set by the SS/TR connection.

A voltage supplied to SS/TR can be used for tracking a master voltage. The output voltage will follow this voltage in both directions up and down (see [Application and Implementation](#)).

### 8.3.3 Power Good (PG)

The TLV62130 has a built in power good (PG) function to indicate whether the output voltage has reached its appropriate level or not. The PG signal can be used for startup sequencing of multiple rails. The PG pin is an open-drain output that requires a pull-up resistor (to any voltage below 7 V). It can sink 2 mA of current and maintain its specified logic low level. With TLV62130 it is high impedance when the device is turned off due to EN, UVLO or thermal shutdown. TLV62130A features PG=Low in this case and can be used to actively discharge Vout (see [Figure 39](#)). VIN must remain present for the PG pin to stay Low. See [SLVA644](#) for application details. If not used, the PG pin should be connected to GND but may be left floating.

**Table 1. Power Good Pin Logic Table (TLV62130)**

| Device State         |                            | PG Logic Status |     |
|----------------------|----------------------------|-----------------|-----|
|                      |                            | High Impedance  | Low |
| Enable (EN=High)     | $V_{FB} \geq V_{TH\_PG}$   | √               |     |
|                      | $V_{FB} \leq V_{TH\_PG}$   |                 | √   |
| Shutdown (EN=Low)    |                            | √               |     |
| UVLO                 | $0.7V < V_{IN} < V_{UVLO}$ | √               |     |
| Thermal Shutdown     | $T_J > T_{SD}$             | √               |     |
| Power Supply Removal | $V_{IN} < 0.7V$            | √               |     |

**Table 2. Power Good Pin Logic Table (TLV62130A)**

| Device State         |                            | PG Logic Status |     |
|----------------------|----------------------------|-----------------|-----|
|                      |                            | High Impedance  | Low |
| Enable (EN=High)     | $V_{FB} \geq V_{TH\_PG}$   | √               |     |
|                      | $V_{FB} \leq V_{TH\_PG}$   |                 | √   |
| Shutdown (EN=Low)    |                            |                 | √   |
| UVLO                 | $0.7V < V_{IN} < V_{UVLO}$ |                 | √   |
| Thermal Shutdown     | $T_J > T_{SD}$             |                 | √   |
| Power Supply Removal | $V_{IN} < 0.7V$            | √               |     |

### 8.3.4 Pin-Selectable Output Voltage (DEF)

The output voltage of the TLV62130 devices can be increased by 5% above the nominal voltage by setting the DEF pin to High <sup>(1)</sup>. When DEF is Low, the device regulates to the nominal output voltage. Increasing the nominal voltage allows adapting the power supply voltage to the variations of the application hardware. More detailed information on voltage margining using TLV62130 can be found in [SLVA489](#). A pull down resistor of about 400 kΩ is internally connected to the pin, to ensure a proper logic level if the pin is high impedance or floating after initially set to Low. The resistor is disconnected if the pin is set High.

### 8.3.5 Frequency Selection (FSW)

To get high power density with very small solution size, a high switching frequency allows the use of small external components for the output filter. However switching losses increase with the switching frequency. If efficiency is the key parameter, more than solution size, the switching frequency can be set to half (1.25 MHz typical) by pulling FSW to High. It is mandatory to start with FSW=Low to limit inrush current, which can be done by connecting to  $V_{OUT}$  or PG. Running with lower frequency a higher efficiency, but also a higher output voltage ripple, is achieved. Pull FSW to Low for high frequency operation (2.5 MHz typical). To get low ripple and full output current at the lower switching frequency, it's recommended to use an inductor of at least 2.2 μH. The switching frequency can be changed during operation, if needed. A pull down resistor of about 400kOhm is internally connected to the pin, acting the same way as at the DEF Pin (see above).

### 8.3.6 Undervoltage Lockout (UVLO)

If the input voltage drops, the undervoltage lockout prevents misoperation of the device by switching off both the power FETs. The undervoltage lockout threshold is set typically to 2.7 V. The device is fully operational for voltages above the UVLO threshold and turns off if the input voltage trips the threshold. The converter starts operation again once the input voltage exceeds the threshold by a hysteresis of typically 200 mV.

### 8.3.7 Thermal Shutdown

The junction temperature ( $T_J$ ) of the device is monitored by an internal temperature sensor. If  $T_J$  exceeds 160°C (typical), the device goes into thermal shut down. Both the high-side and low-side power FETs are turned off and PG goes high impedance. When  $T_J$  decreases below the hysteresis amount, the converter resumes normal operation, beginning with Soft Start. To avoid unstable conditions, a hysteresis of typically 20°C is implemented on the thermal shut down temperature.

## 8.4 Device Functional Modes

### 8.4.1 Pulse Width Modulation (PWM) Operation

The TLV62130 operates with pulse width modulation in continuous conduction mode (CCM) with a nominal switching frequency of 2.5 MHz or 1.25 MHz, selectable with the FSW pin. The frequency variation in PWM is controlled and depends on  $V_{IN}$ ,  $V_{OUT}$  and the inductance. The device operates in PWM mode as long the output current is higher than half the inductor's ripple current. To maintain high efficiency at light loads, the device enters Power Save Mode at the boundary to discontinuous conduction mode (DCM). This happens if the output current becomes smaller than half the inductor's ripple current.

(1) Maximum allowed voltage is 7 V. Therefore, TI recommends connecting it to  $V_{OUT}$  or PG, not  $V_{IN}$ .

## Device Functional Modes (continued)

### 8.4.2 Power Save Mode Operation

The TLV62130X enters its built in Power Save Mode seamlessly if the load current decreases. This secures a high efficiency in light load operation. The device remains in Power Save Mode as long as the inductor current is discontinuous.

In Power Save Mode the switching frequency decreases linearly with the load current maintaining high efficiency. The transition into and out of Power Save Mode happens within the entire regulation scheme and is seamless in both directions.

TLV62130 includes a fixed on-time circuitry. This on-time, in steady-state operation, can be estimated (for FSW=Low) as:

$$t_{ON} = \frac{V_{OUT}}{V_{IN}} \times 400 \text{ ns} \quad (1)$$

For very small output voltages, an absolute minimum on-time of about 80ns is kept to limit switching losses. The operating frequency is thereby reduced from its nominal value, which keeps efficiency high. Also the off-time can reach its minimum value at high duty cycles. The output voltage remains regulated in such cases. Using  $t_{ON}$ , the typical peak inductor current in Power Save Mode can be approximated by:

$$I_{LPSM(\text{peak})} = \frac{(V_{IN} - V_{OUT})}{L} \times t_{ON} \quad (2)$$

When  $V_{IN}$  decreases to typically 15% above  $V_{OUT}$ , the TLV62130 won't enter Power Save Mode, regardless of the load current. The device maintains output regulation in PWM mode.

### 8.4.3 100% Duty-Cycle Operation

The duty cycle of the buck converter is given by  $D=V_{out}/V_{in}$  and increases as the input voltage comes close to the output voltage. In this case, the device starts 100% duty cycle operation turning on the high-side switch 100% of the time. The high-side switch stays turned on as long as the output voltage is below the internal setpoint. This allows the conversion of small input to output voltage differences, for example, for longest operation time of battery-powered applications. In 100% duty cycle mode, the low-side FET is switched off.

The minimum input voltage to maintain output voltage regulation, depending on the load current and the output voltage level, can be calculated as:

$$V_{IN(\text{min})} = V_{OUT(\text{min})} + I_{OUT}(R_{DS(\text{on})} + R_L)$$

where

- $I_{OUT}$  is the output current.
  - $R_{DS(\text{on})}$  is the  $R_{DS(\text{on})}$  of the high-side FET.
  - $R_L$  is the DC resistance of the inductor used.
- (3)

### 8.4.4 Current Limit and Short Circuit Protection

The TLV62130 device is protected against heavy load and short circuit events. If a short circuit is detected ( $V_{OUT}$  drops below 0.5 V), the current limit is reduced to 1.6 A typically. If the output voltage rises above 0.5 V, the device runs in normal operation again. At heavy loads, the current limit determines the maximum output current. If the current limit is reached, the high-side FET is turned off. Avoiding shoot through current, then the low-side FET switches on to allow the inductor current to decrease. The low-side current limit is typically 3.5 A. The high-side FET turns on again only if the current in the low-side FET has decreased below the low side current limit threshold.

## Device Functional Modes (continued)

The output current of the device is limited by the current limit (see [Electrical Characteristics](#)). Due to internal propagation delay, the actual current can exceed the static current limit during that time. The dynamic current limit can be calculated as follows:

$$I_{\text{peak(typ)}} = I_{\text{LIMF}} + \frac{V_L}{L} \times t_{\text{PD}}$$

where

- $I_{\text{LIMF}}$  is the static current limit, specified in the [Electrical Characteristics](#).
- $L$  is the inductor value.
- $V_L$  is the voltage across the inductor ( $V_{\text{IN}} - V_{\text{OUT}}$ ).
- $t_{\text{PD}}$  is the internal propagation delay. (4)

The current limit can exceed static values, especially if the input voltage is high and very small inductances are used. The dynamic high side switch peak current can be calculated as follows:

$$I_{\text{peak(typ)}} = I_{\text{LIMF}} + \frac{(V_{\text{IN}} - V_{\text{OUT}})}{L} \times 30\text{ns} \quad (5)$$

## 9 Application and Implementation

### NOTE

Information in the following applications sections is not part of the TI component specification, and TI does not warrant its accuracy or completeness. TI's customers are responsible for determining suitability of components for their purposes. Customers should validate and test their design implementation to confirm system functionality.

### 9.1 Application Information

The TLV62130 is a switched-mode step-down converter, able to convert a 3-V to 17-V input voltage into a 0.9-V to 5.5-V output voltage, providing up to 3 A. It needs a minimum amount of external components. Apart from the LC output filter and the input capacitors, the TLV62130 (TLV62130A) needs an additional resistive divider to set the output voltage level.

### 9.2 Typical Application

Figure 5 shows an application for Point-Of-Load Power Supply Using TLV62130.

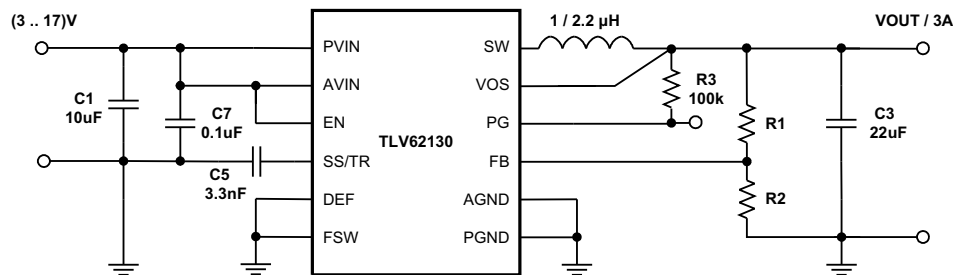

Figure 5. 3-A Step-Down Converter

#### 9.2.1 Design Requirements

The following design guideline provides a component selection to operate the device within the recommended operating conditions. Using the FSW pin, the design can be optimized for highest efficiency or smallest solution size and lowest output voltage ripple. For highest efficiency set FSW=High and the device operates at the lower switching frequency. For smallest solution size and lowest output voltage ripple set FSW=Low and the device operates with higher switching frequency. The typical values for all measurements are  $V_{IN} = 12\text{ V}$ ,  $V_{OUT} = 3.3\text{ V}$  and  $T = 25^\circ\text{C}$ , using the external components of Table 3.

#### 9.2.2 Detailed Design Procedure

##### 9.2.2.1 Custom Design With WEBENCH® Tools

[Click here](#) to create a custom design using the TLV62130 device with the WEBENCH® Power Designer.

1. Start by entering the input voltage ( $V_{IN}$ ), output voltage ( $V_{OUT}$ ), and output current ( $I_{OUT}$ ) requirements.
2. Optimize the design for key parameters such as efficiency, footprint, and cost using the optimizer dial.
3. Compare the generated design with other possible solutions from Texas Instruments.

The WEBENCH Power Designer provides a customized schematic along with a list of materials with real-time pricing and component availability.

In most cases, these actions are available:

### Typical Application (continued)

- Run electrical simulations to see important waveforms and circuit performance
- Run thermal simulations to understand board thermal performance
- Export customized schematic and layout into popular CAD formats
- Print PDF reports for the design, and share the design with colleagues

Get more information about WEBENCH tools at [www.ti.com/WEBENCH](http://www.ti.com/WEBENCH).

The component selection used for measurements is given as follows:

**Table 3. List of Components<sup>(1)</sup>**

| REFERENCE | DESCRIPTION                         | MANUFACTURER                   |
|-----------|-------------------------------------|--------------------------------|
| IC        | 17-V, 3-A Step-Down Converter, VQFN | TLV62130RGT, Texas Instruments |
| L1        | 2.2 µH, 0.165 x 0.165 in            | XFL4020-222MEB, Coilcraft      |
| C1        | 10 µF, 25 V, Ceramic, 1210          | Standard                       |
| C3        | 22 µF, 6.3 V, Ceramic, 0805         | Standard                       |
| C5        | 3300 pF, 25 V, Ceramic, 0603        |                                |
| C7        | 0.1 µF, 25V, Ceramic, 0603          |                                |
| R1        | depending on Vout                   |                                |
| R2        | depending on Vout                   |                                |
| R3        | 100 kΩ, Chip, 0603, 1/16W, 1%       | Standard                       |

(1) See [Third-Party Products](#) Disclaimer

#### 9.2.2.2 Programming the Output Voltage

The TLV62130 (TLV62130A) can be programmed for output voltages from 0.9 V to 5.5 V by using a resistive divider from V<sub>OUT</sub> to AGND. The voltage at the FB pin is regulated to 800 mV. The value of the output voltage is set by the selection of the resistive divider from [Equation 6](#). It is recommended to choose resistor values which allow a current of at least 2 µA, meaning the value of R2 should not exceed 400 kΩ. Lower resistor values are recommended for highest accuracy and most robust design.

$$R_1 = R_2 \left( \frac{V_{OUT}}{0.8V} - 1 \right) \quad (6)$$

In case the FB pin gets opened, the device clamps the output voltage at the VOS pin internally to about 7.4 V.

#### 9.2.2.3 External Component Selection

The external components have to fulfill the needs of the application, but also the stability criteria of the devices control loop. The TLV62130 is optimized to work within a range of external components. The LC output filter's inductance and capacitance have to be considered together, creating a double pole, responsible for the corner frequency of the converter (see [Output Filter and Loop Stability](#)). [Table 4](#) can be used to simplify the output filter component selection. Checked cells represent combinations that are proven for stability by simulation and lab test. Further combinations should be checked for each individual application. See [SLVA463](#) for details.

**Table 4. Recommended LC Output Filter Combinations<sup>(1)</sup>**

|         | 4.7 µF | 10 µF | 22 µF            | 47 µF | 100 µF | 200 µF | 400 µF |
|---------|--------|-------|------------------|-------|--------|--------|--------|
| 0.47 µH |        |       |                  |       |        |        |        |
| 1 µH    |        |       | √                | √     | √      | √      |        |
| 2.2 µH  |        | √     | √ <sup>(2)</sup> | √     | √      | √      |        |
| 3.3 µH  |        | √     | √                | √     | √      |        |        |
| 4.7 µH  |        |       |                  |       |        |        |        |

(1) The values in the table are nominal values. The effective capacitance was considered to vary by +20% and -50%.

(2) This LC combination is the standard value and recommended for most applications.

The TLV62130 can be run with an inductor as low as 1  $\mu\text{H}$ . FSW should be set Low in this case. However, for applications running with the low frequency setting (FSW=High) or with low input voltages, 2.2  $\mu\text{H}$  is recommended.

### 9.2.2.3.1 Inductor Selection

The inductor selection is affected by several effects like inductor ripple current, output ripple voltage, PWM-to-PSM transition point and efficiency. In addition, the inductor selected has to be rated for appropriate saturation current and DC resistance (DCR). Equation 7 and Equation 8 calculate the maximum inductor current under static load conditions.

$$I_{L(\max)} = I_{\text{OUT}(\max)} + \frac{\Delta I_{L(\max)}}{2} \quad (7)$$

$$\Delta I_{L(\max)} = V_{\text{OUT}} \times \left( \frac{1 - \frac{V_{\text{OUT}}}{V_{\text{IN}(\max)}}}{L_{(\min)} \times f_{\text{SW}}} \right) \quad (8)$$

where

- $I_{L(\max)}$  is the maximum inductor current.
- $\Delta I_L$  is the Peak to Peak Inductor Ripple Current.
- $L_{(\min)}$  is the minimum effective inductor value.
- $f_{\text{SW}}$  is the actual PWM Switching Frequency.

Calculating the maximum inductor current using the actual operating conditions gives the minimum saturation current of the inductor needed. A margin of about 20% is recommended to add. A larger inductor value is also useful to get lower ripple current, but increases the transient response time and size as well. The following inductors have been used with the TLV62130 and are recommended for use:

**Table 5. List of Inductors**

| Type           | Inductance [ $\mu\text{H}$ ]   | Current [A] <sup>(1)</sup> | Dimensions [LxBxH]<br>mm | MANUFACTURER <sup>(2)</sup> |
|----------------|--------------------------------|----------------------------|--------------------------|-----------------------------|
| XFL4020-102ME_ | 1.0 $\mu\text{H}$ , $\pm 20\%$ | 4.7                        | 4 x 4 x 2.1              | Coilcraft                   |
| XFL4020-152ME_ | 1.5 $\mu\text{H}$ , $\pm 20\%$ | 4.2                        | 4 x 4 x 2.1              | Coilcraft                   |
| XFL4020-222ME_ | 2.2 $\mu\text{H}$ , $\pm 20\%$ | 3.8                        | 4 x 4 x 2.1              | Coilcraft                   |
| IHLP1212BZ-11  | 1.0 $\mu\text{H}$ , $\pm 20\%$ | 4.5                        | 3 x 3.6 x 2              | Vishay                      |
| IHLP1212BZ-11  | 2.2 $\mu\text{H}$ , $\pm 20\%$ | 3.0                        | 3 x 3.6 x 2              | Vishay                      |
| SRP4020-3R3M   | 3.3 $\mu\text{H}$ , $\pm 20\%$ | 3.3                        | 4.8 x 4 x 2              | Bourns                      |
| VLC5045T-3R3N  | 3.3 $\mu\text{H}$ , $\pm 30\%$ | 4.0                        | 5 x 5 x 4.5              | TDK                         |

(1) Lower of  $I_{\text{RMS}}$  at 40°C rise or  $I_{\text{SAT}}$  at 30% drop.

(2) See [Third-Party Products](#) Disclaimer

The inductor value also determines the load current at which Power Save Mode is entered:

$$I_{\text{load(PSM)}} = \frac{1}{2} \Delta I_L \quad (9)$$

Using Equation 8, this current level can be adjusted by changing the inductor value.

### 9.2.2.3.2 Capacitor Selection

#### 9.2.2.3.2.1 Output Capacitor

The recommended value for the output capacitor is 22  $\mu\text{F}$ . The architecture of the TLV62130 allows the use of tiny ceramic output capacitors which have low equivalent series resistance (ESR). These capacitors provide low output voltage ripple and are recommended. To keep its low resistance up to high frequencies and to get narrow capacitance variation with temperature, it's recommended to use X7R or X5R dielectric. Using a higher value can have some advantages like smaller voltage ripple and a tighter DC output accuracy in Power Save Mode (see [SLVA463](#)).

Note: In power save mode, the output voltage ripple depends on the output capacitance, its ESR and the peak inductor current. Using ceramic capacitors provides small ESR and low ripple.

#### 9.2.2.3.2.2 Input Capacitor

For most applications, 10  $\mu\text{F}$  will be sufficient and is recommended, though a larger value reduces input current ripple further. The input capacitor buffers the input voltage for transient events and also decouples the converter from the supply. A low ESR multilayer ceramic capacitor is recommended for best filtering and should be placed between PVIN and PGND as close as possible to those pins. Even though AVIN and PVIN must be supplied from the same input source, it's required to place a capacitance of 0.1  $\mu\text{F}$  from AVIN to AGND, to avoid potential noise coupling. An RC, low-pass filter from PVIN to AVIN may be used but is not required.

#### 9.2.2.3.2.3 Soft Start Capacitor

A capacitance connected between SS/TR pin and AGND allows a user programmable start-up slope of the output voltage. A constant current source supports 2.5  $\mu\text{A}$  to charge the external capacitance. The capacitor required for a given soft-start ramp time for the output voltage is given by:

$$C_{SS} = t_{SS} \times \frac{2.5\mu\text{A}}{1.25\text{V}} [\text{F}] \quad (10)$$

where

- $C_{SS}$  is the capacitance (F) required at the SS/TR pin.
- $t_{SS}$  is the desired soft-start ramp time (s).

---

#### NOTE

**DC Bias effect:** High capacitance ceramic capacitors have a DC Bias effect, which will have a strong influence on the final effective capacitance. Therefore the right capacitor value has to be chosen carefully. Package size and voltage rating in combination with dielectric material are responsible for differences between the rated capacitor value and the effective capacitance.

---

### 9.2.2.4 Tracking Function

If a tracking function is desired, the SS/TR pin can be used for this purpose by connecting it to an external tracking voltage. The output voltage tracks that voltage. If the tracking voltage is between 50 mV and 1.2 V, the FB pin will track the SS/TR pin voltage as described in [Equation 11](#) and shown in [Figure 6](#).

$$V_{FB} = 0.64 \cdot V_{SS/TR} \text{ with } \pm 2\% \text{ (typ.)} \quad (11)$$

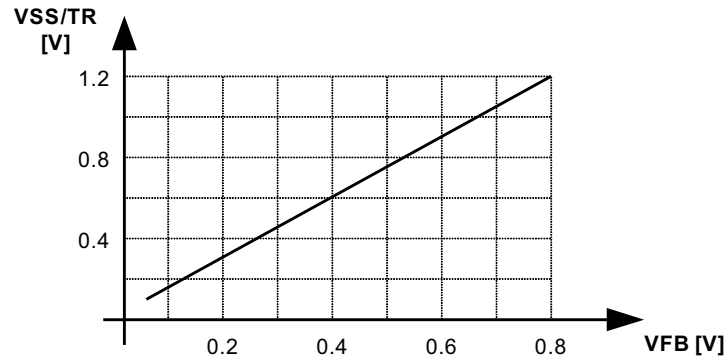

Figure 6. Voltage Tracking Relationship

Once the SS/TR pin voltage reaches about 1.2 V, the internal voltage is clamped to the internal feedback voltage and device goes to normal regulation. This works for rising and falling tracking voltages with the same behavior, as long as the input voltage is inside the recommended operating conditions. For decreasing SS/TR pin voltage, the device doesn't sink current from the output. So, the resulting decrease of the output voltage may be slower than the SS/TR pin voltage if the load is light. When driving the SS/TR pin with an external voltage, do not exceed the voltage rating of the SS/TR pin which is  $V_{IN} + 0.3$  V.

If the input voltage drops into undervoltage lockout or even down to zero, the output voltage will go to zero, independent of the tracking voltage. Figure 7 shows how to connect devices to get ratiometric and simultaneous sequencing by using the tracking function.

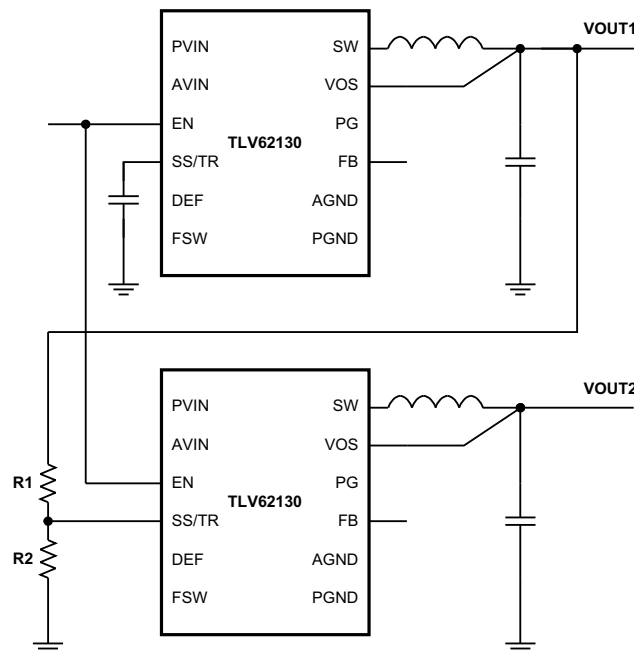

Figure 7. Sequence for Ratiometric and Simultaneous Startup

The resistive divider of R1 and R2 can be used to change the ramp rate of VOUT2 faster, slower or the same as VOUT1.

A sequential startup is achieved by connecting the PG pin of VOUT1 to the EN pin of VOUT2. Ratiometric start-up sequence happens if both supplies are sharing the same soft start capacitor. Equation 10 calculates the soft start time, though the SS/TR current has to be doubled. Details about these and other tracking and sequencing circuits are found in SLVA470.

Note: If the voltage at the FB pin is below its typical value of 0.8 V, the output voltage accuracy may have a wider tolerance than specified.

### 9.2.2.5 Output Filter and Loop Stability

The TLV62130 is internally compensated to be stable with L-C filter combinations corresponding to a corner frequency to be calculated with [Equation 12](#):

$$f_{LC} = \frac{1}{2\pi\sqrt{L \times C}} \quad (12)$$

Proven nominal values for inductance and ceramic capacitance are given in [Table 4](#) and are recommended for use. Different values may work, but care has to be taken on the loop stability which will be affected. More information including a detailed LC stability matrix can be found in [SLVA463](#).

The TLV62130 device includes an internal 25-pF feedforward capacitor, connected between the VOS and FB pins. This capacitor impacts the frequency behavior and sets a pole and zero in the control loop with the resistors of the feedback divider, per equation [Equation 13](#) and [Equation 14](#):

$$f_{zero} = \frac{1}{2\pi \times R_1 \times 25\text{pF}} \quad (13)$$

$$f_{pole} = \frac{1}{2\pi \times 25\text{pF}} \times \left( \frac{1}{R_1} + \frac{1}{R_2} \right) \quad (14)$$

Though the TLV62130 is stable without the pole and zero being in a particular location, adjusting their location to the specific needs of the application can provide better performance in Power Save mode and/or improved transient response. An external feedforward capacitor can also be added. A more detailed discussion on the optimization for stability vs. transient response can be found in [SLVA289](#) and [SLVA466](#).

### 9.2.3 Application Curves

$V_{IN} = 12\text{ V}$ ,  $V_{OUT} = 3.3\text{ V}$ ,  $T_A = 25^\circ\text{C}$ , (unless otherwise noted)

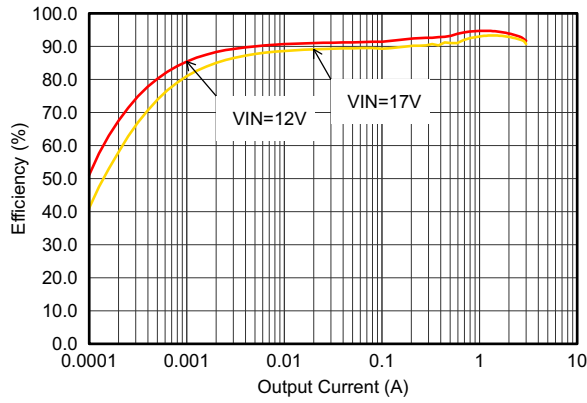

Figure 8. Efficiency With 1.25 MHz,  $V_{out} = 5\text{ V}$

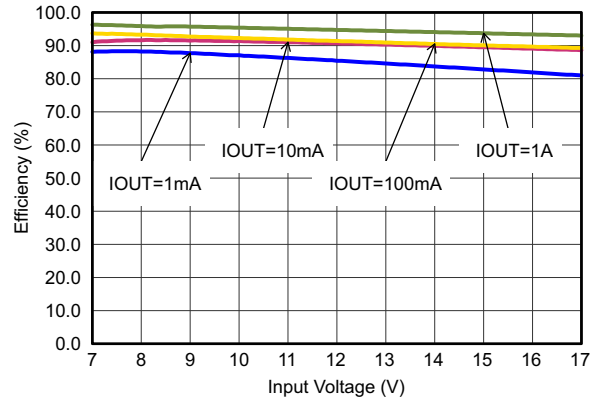

Figure 9. Efficiency With 1.25 MHz,  $V_{out} = 5\text{ V}$

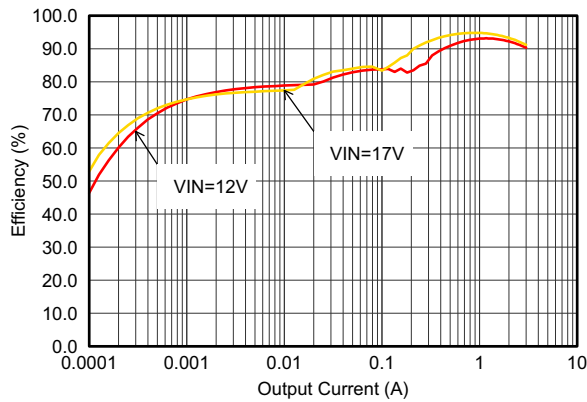

Figure 10. Efficiency With 2.5 MHz,  $V_{out} = 5\text{ V}$

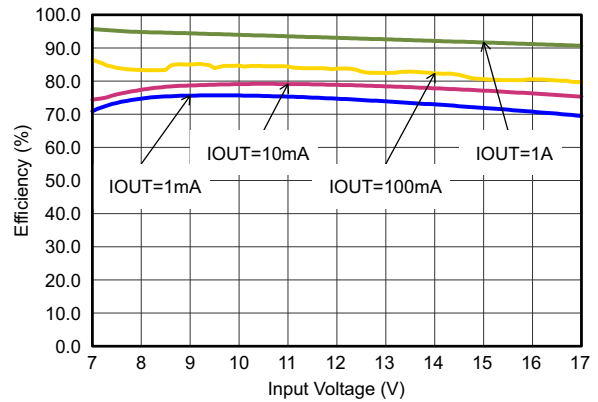

Figure 11. Efficiency With 2.5 MHz,  $V_{out} = 5\text{ V}$

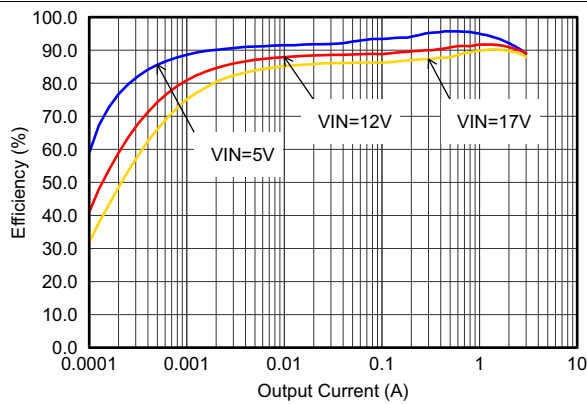

Figure 12. Efficiency With 1.25 MHz,  $V_{out} = 3.3\text{ V}$

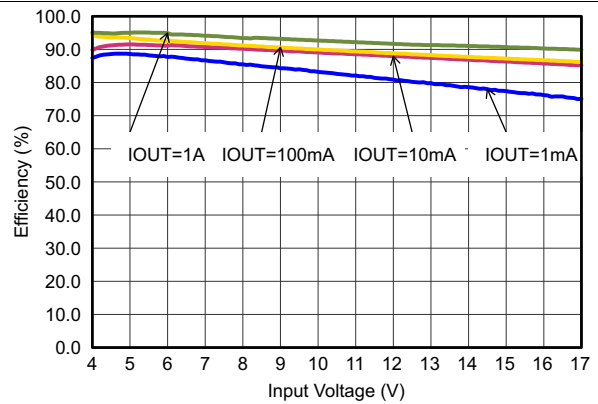

Figure 13. Efficiency With 1.25 MHz,  $V_{out} = 3.3\text{ V}$

TLV62130, TLV62130A

JAJ5BR5H – FEBRUARY 2012 – REVISED JUNE 2018

www.ti.com

$V_{IN} = 12\text{ V}$ ,  $V_{OUT} = 3.3\text{ V}$ ,  $T_A = 25^\circ\text{C}$ , (unless otherwise noted)

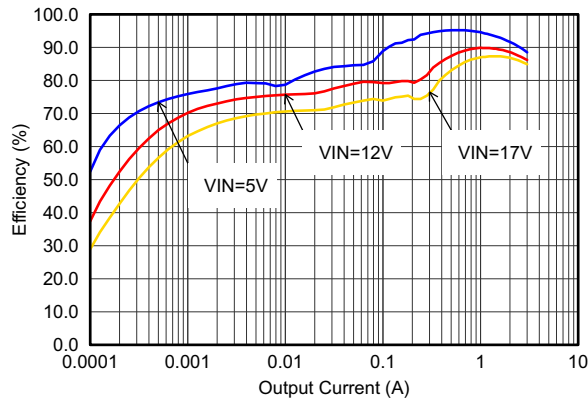

Figure 14. Efficiency With 2.5 MHz,  $V_{out} = 3.3\text{ V}$

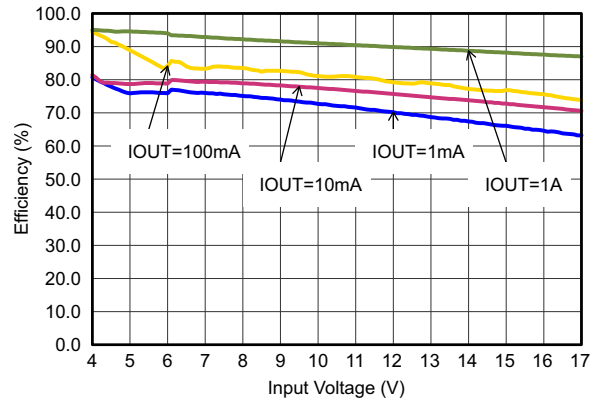

Figure 15. Efficiency With 2.5 MHz,  $V_{out} = 3.3\text{ V}$

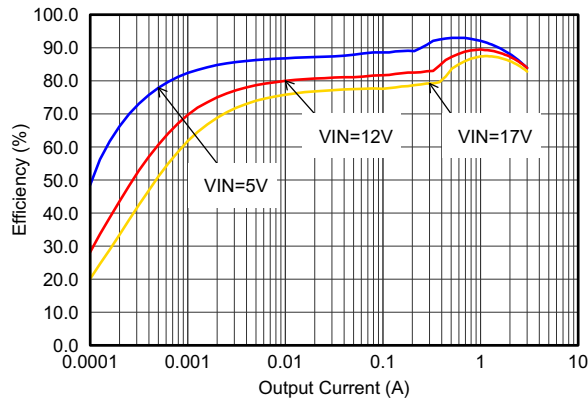

Figure 16. Efficiency With 1.25 MHz,  $V_{out} = 1.8\text{ V}$

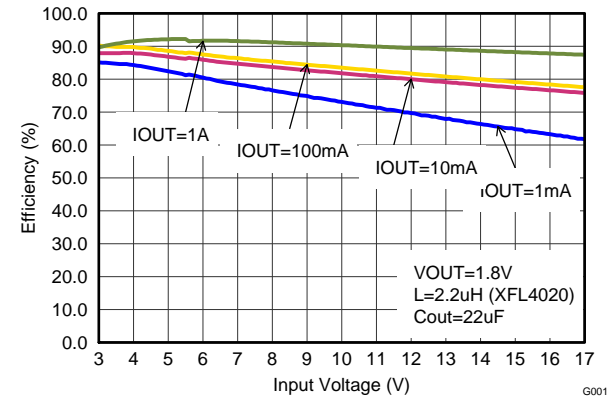

Figure 17. Efficiency With 1.25 MHz,  $V_{out} = 1.8\text{ V}$

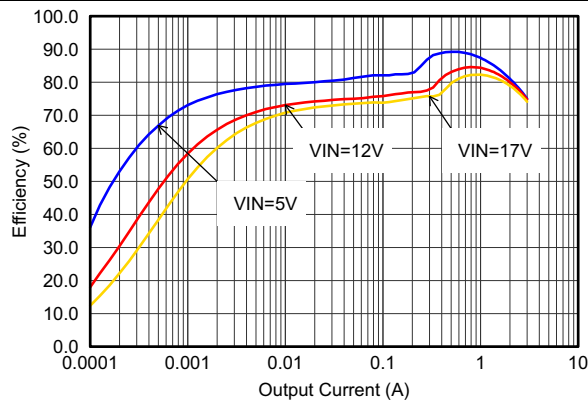

Figure 18. Efficiency With 1.25 MHz,  $V_{out} = 0.9\text{ V}$

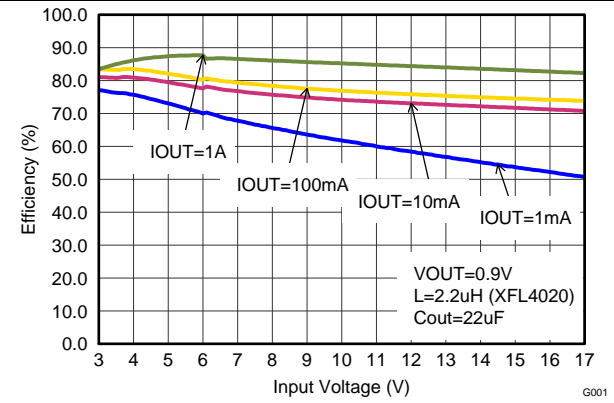

Figure 19. Efficiency With 1.25 MHz,  $V_{out} = 0.9\text{ V}$

$V_{IN} = 12\text{ V}$ ,  $V_{OUT} = 3.3\text{ V}$ ,  $T_A = 25^\circ\text{C}$ , (unless otherwise noted)

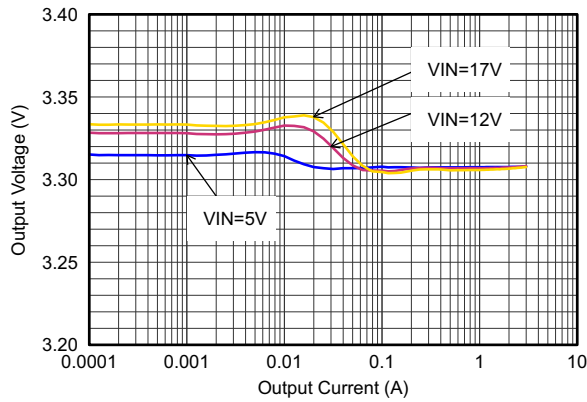

Figure 20. Output Voltage Accuracy (Load Regulation)

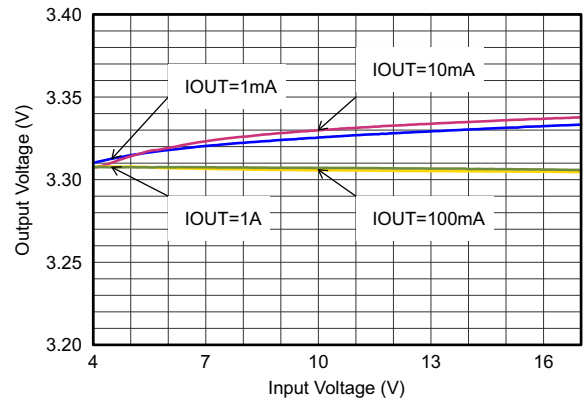

Figure 21. Output Voltage Accuracy (Line Regulation)

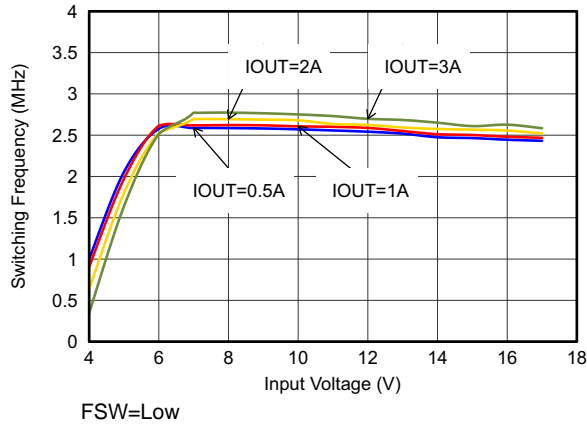

Figure 22. Switching Frequency

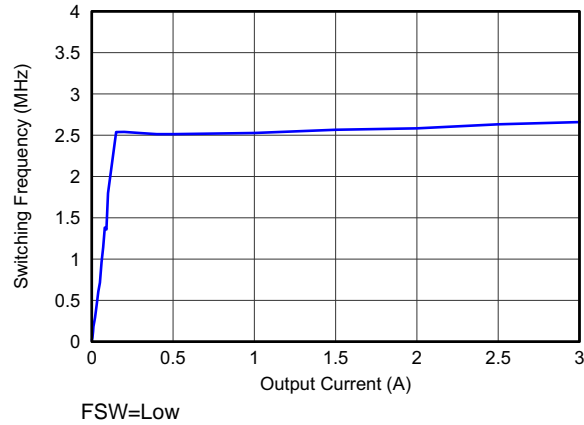

Figure 23. Switching Frequency

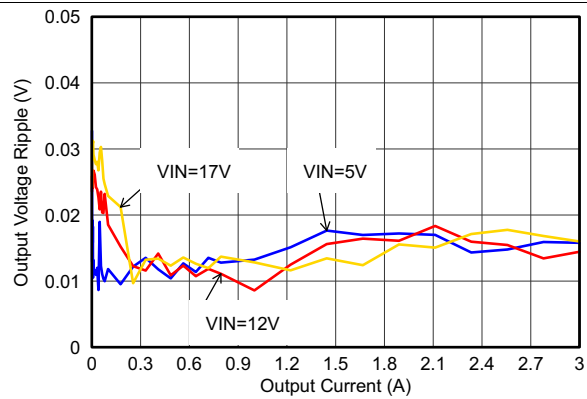

Figure 24. Output Voltage Ripple

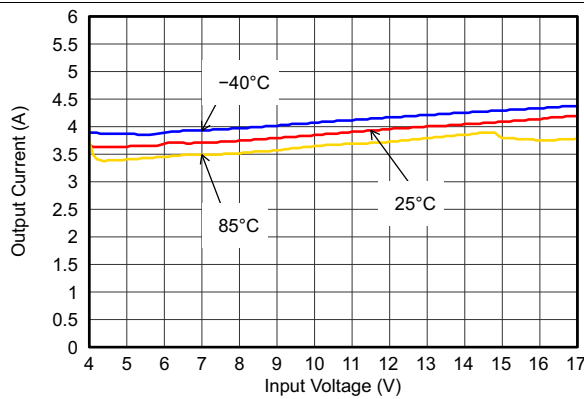

Figure 25. Maximum Output Current

$V_{IN} = 12\text{ V}$ ,  $V_{OUT} = 3.3\text{ V}$ ,  $T_A = 25^\circ\text{C}$ , (unless otherwise noted)

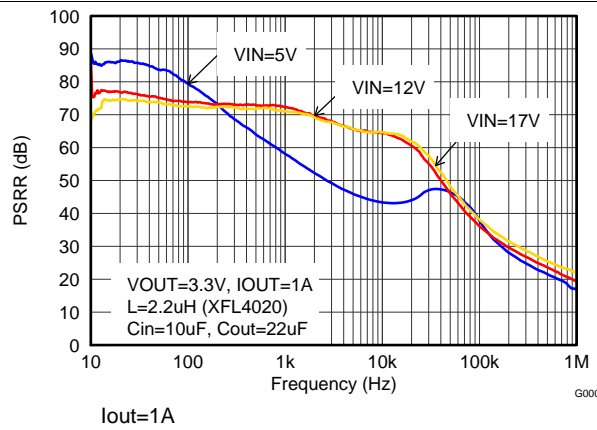

Figure 26. Power Supply Rejection Ratio,  $F_{SW} = 2.5\text{ MHz}$

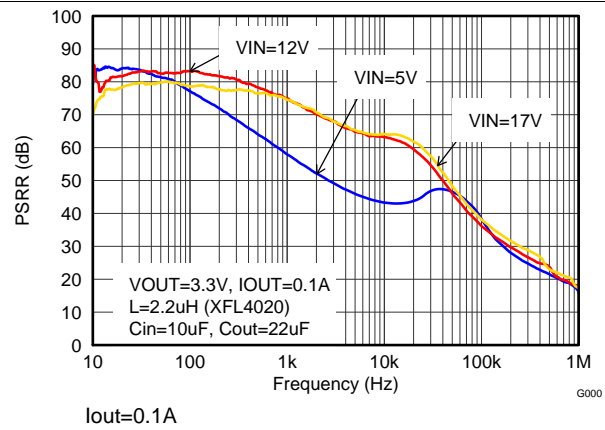

Figure 27. Power Supply Rejection Ratio,  $F_{SW} = 2.5\text{ MHz}$

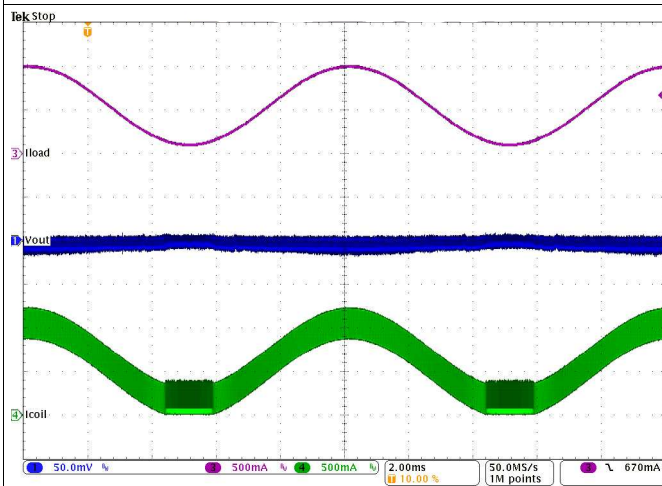

Figure 28. PWM-PSM-Transition  
( $V_{IN} = 12\text{ V}$ ,  $V_{OUT} = 3.3\text{ V}$  with 50 mV/Div)

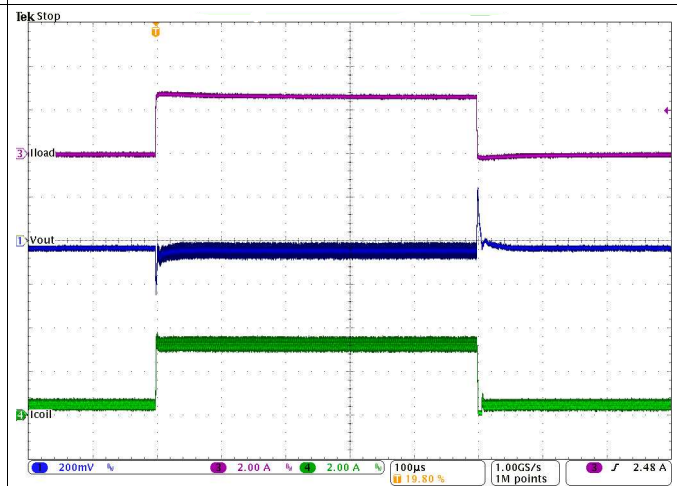

Figure 29. Load Transient Response  
( $I_{OUT} = 0.5\text{ to }3\text{ to }0.5\text{ A}$ )

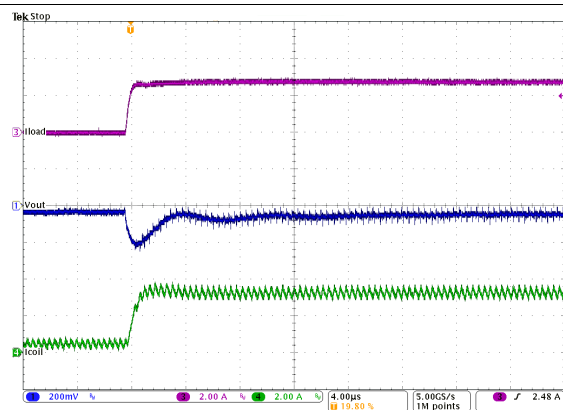

Figure 30. Load Transient Response of Figure 29,  
Rising Edge

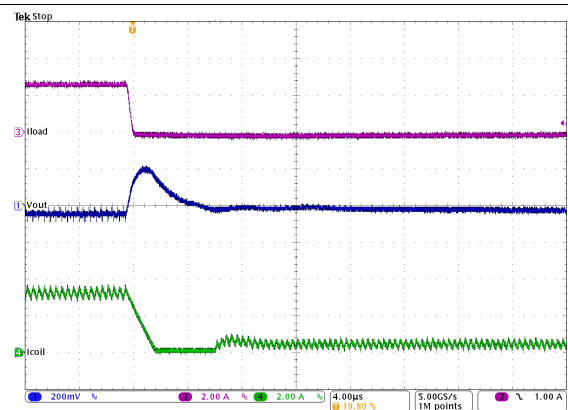

Figure 31. Load Transient Response of Figure 29,  
Falling Edge

$V_{IN} = 12\text{ V}$ ,  $V_{OUT} = 3.3\text{ V}$ ,  $T_A = 25^\circ\text{C}$ , (unless otherwise noted)

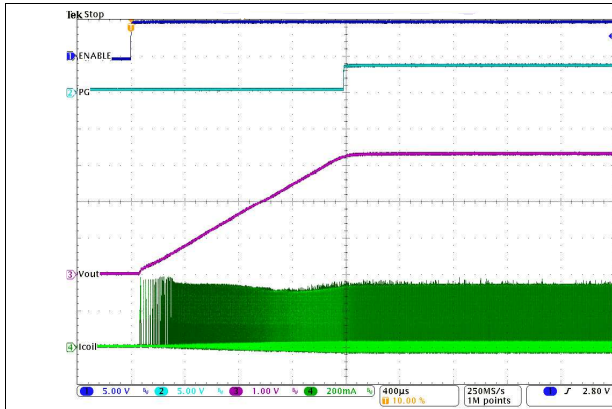

Figure 32. Startup into 100 mA

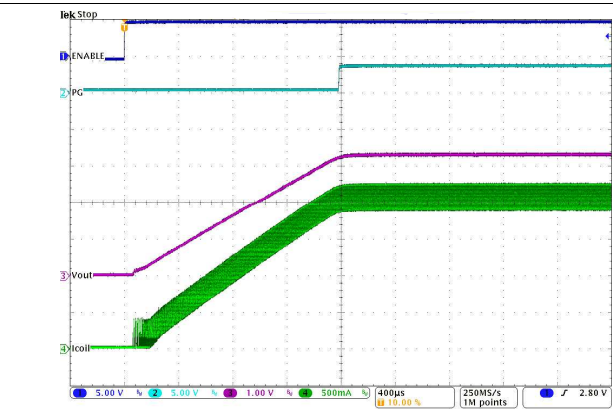

Figure 33. Startup into 3 A

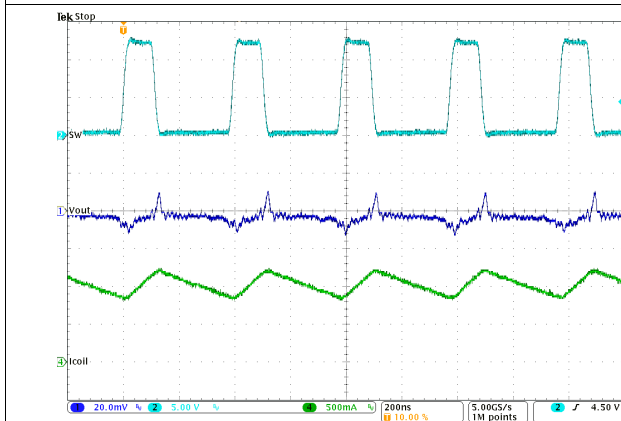

Figure 34. Typical Operation in PWM Mode ( $I_{OUT} = 1\text{ A}$ )

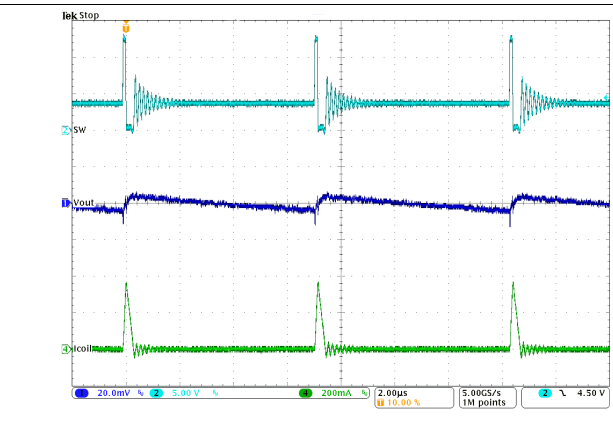

Figure 35. Typical Operation in Power Save Mode ( $I_{OUT} = 10\text{ mA}$ )

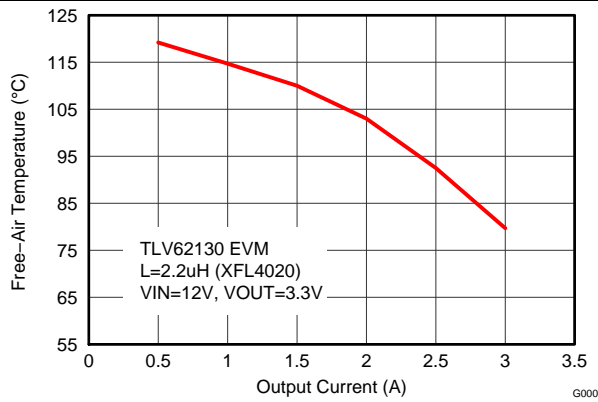

Figure 36. Maximum Ambient Temperature ( $F_{SW} = 2.5\text{ MHz}$ )

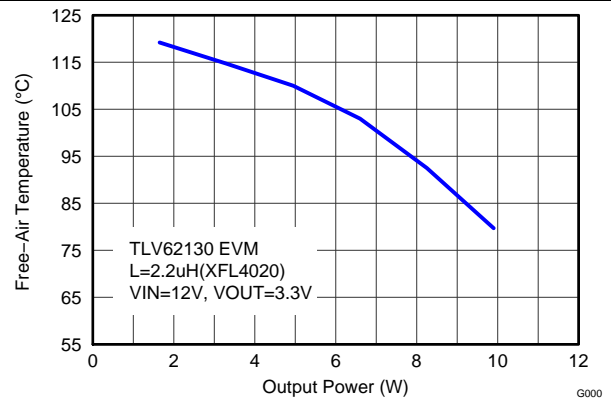
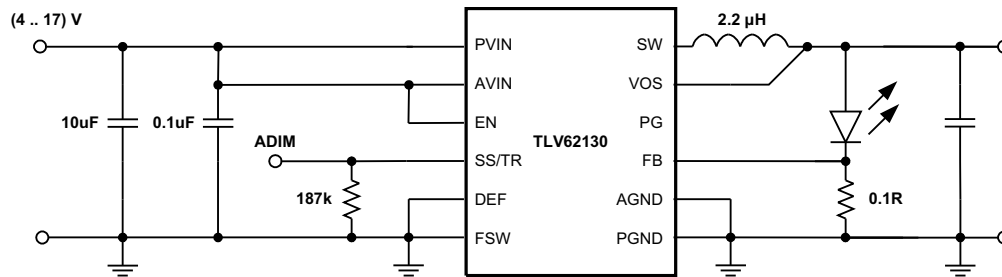

Figure 37. Maximum Ambient Temperature ( $F_{SW} = 2.5\text{ MHz}$ )

## 9.3 System Examples

### 9.3.1 LED Power Supply

The TLV62130 can be used as a power supply for power LEDs. The FB pin can be easily set down to lower values than nominal by using the SS/TR pin. With that, the voltage drop on the sense resistor is low to avoid excessive power loss. Since this pin provides 2.5  $\mu\text{A}$ , the feedback pin voltage can be adjusted by an external resistor per [Equation 15](#). This drop, proportional to the LED current, is used to regulate the output voltage (anode voltage) to a proper level to drive the LED. Both analog and PWM dimming are supported with the TLV62130. [Figure 38](#) shows an application circuit, tested with analog dimming:



**Figure 38. 3 A Single LED Power Supply**

The resistor at SS/TR sets the FB voltage to a level of about 300 mV and is calculated from [Equation 15](#).

$$V_{FB} = 0.64 \times 2.5\mu\text{A} \times R_{SS/TR} \quad (15)$$

The device now supplies a constant current, set by the resistor at the FB pin, by regulating the output voltage accordingly. The minimum input voltage has to be rated according the forward voltage needed by the LED used. More information is available in the Application Note [SLVA451](#).

### 9.3.2 Active Output Discharge

The TLV62130A pulls the PG pin Low, when the device is shut down by EN, UVLO or thermal shutdown. Connecting PG to Vout through a resistor can be used to discharge Vout in those cases (see [Figure 39](#)). The discharge rate can be adjusted by R3, which is also used to pull up the PG pin in normal operation. For reliability, keep the maximum current into the PG pin less than 10 mA.

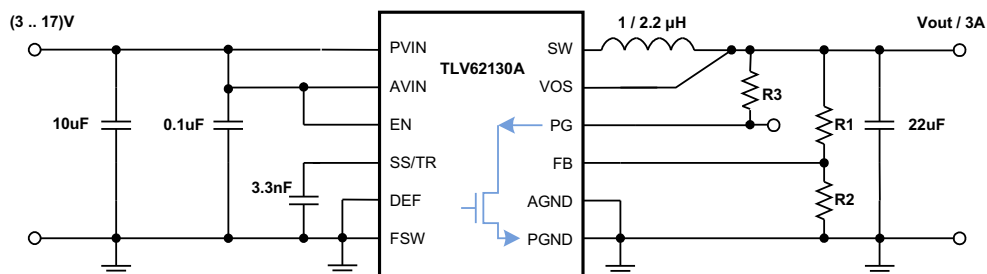

**Figure 39. Discharge Vout Through PG Pin With TLV62130A**

## System Examples (continued)

### 9.3.3 Inverting Power Supply

The TLV62130 can be used as inverting power supply by rearranging external circuitry as shown in Figure 40. As the former GND node now represents a voltage level below system ground, the voltage difference between  $V_{IN}$  and  $V_{OUT}$  has to be limited for operation to the maximum supply voltage of 17 V (see Equation 16).

$$V_{IN} + |V_{OUT}| \leq V_{INmax} \quad (16)$$

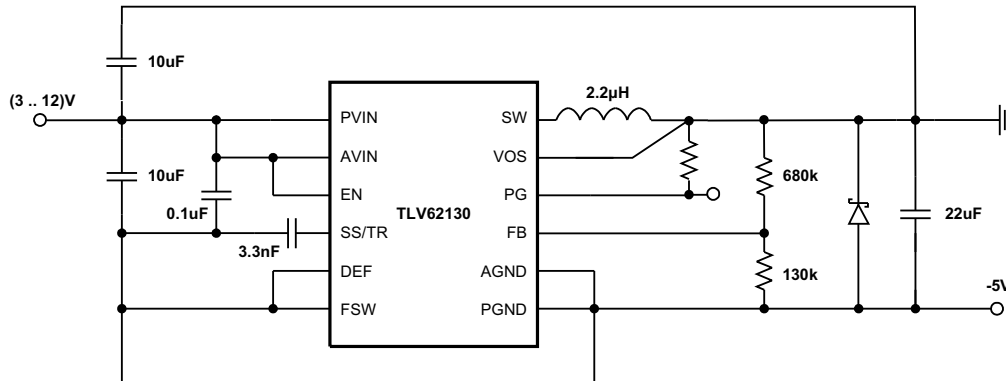

Figure 40. -5 V Inverting Power Supply

The transfer function of the inverting power supply configuration differs from the buck mode transfer function, incorporating a Right Half Plane Zero additionally. The loop stability has to be adapted and an output capacitance of at least 22  $\mu\text{F}$  is recommended. A detailed design example is given in SLVA469.

### 9.3.4 Various Output Voltages

The following example circuits show how to configure the external circuitry to furnish different output voltages at 3 A.

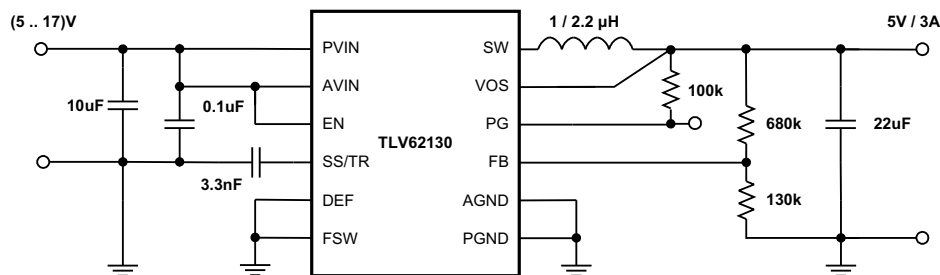
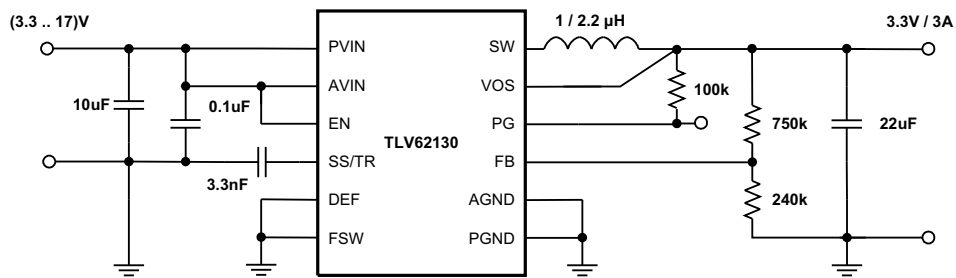
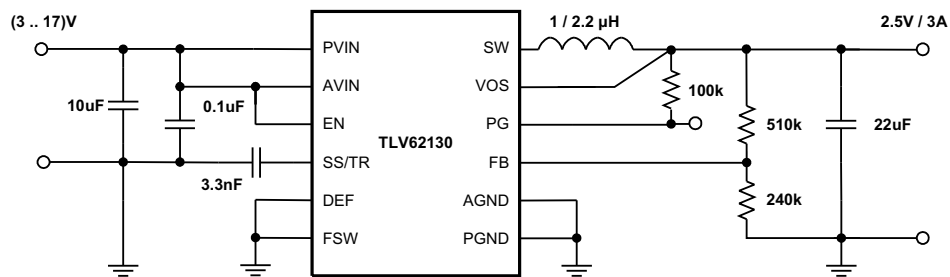
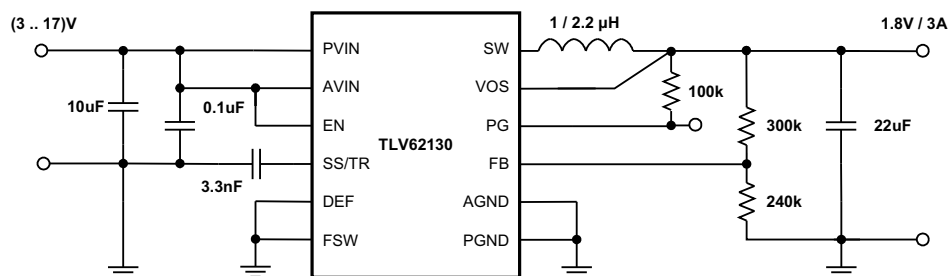

Figure 41. 5-V / 3-A Power Supply

**System Examples (continued)**

**Figure 42. 3.3-V / 3-A Power Supply**

**Figure 43. 2.5-V / 3-A Power Supply**

**Figure 44. 1.8-V / 3-A Power Supply**

System Examples (continued)

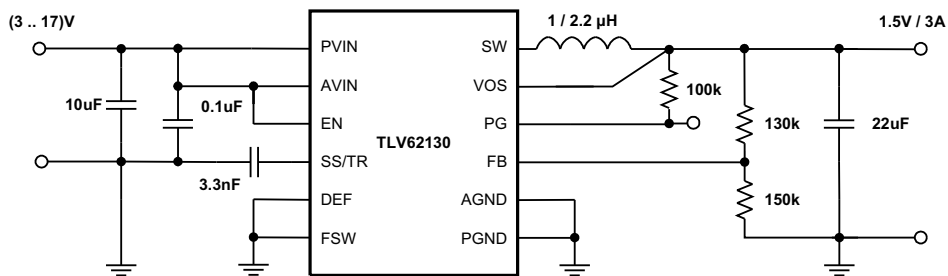

Figure 45. 1.5-V / 3-A Power Supply

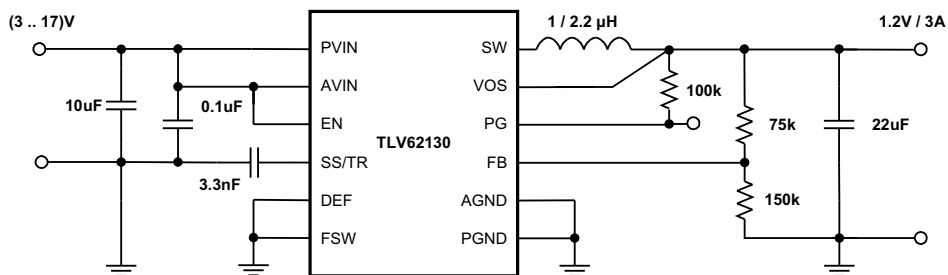

Figure 46. 1.2-V / 3-A Power Supply

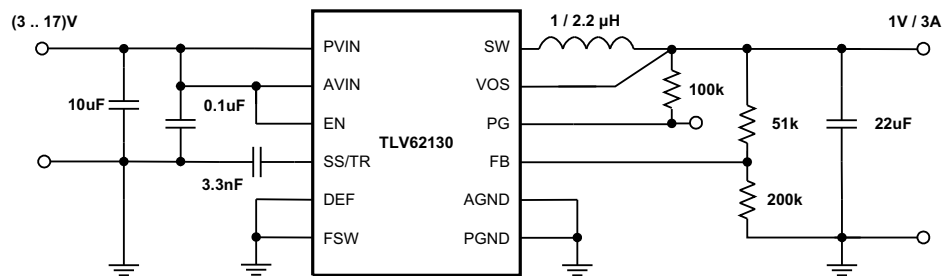

Figure 47. 1-V / 3-A Power Supply

10 Power Supply Recommendations

The TLV62130 are designed to operate from a 3-V to 17-V input voltage supply. The input power supply's output current needs to be rated according to the output voltage and the output current of the power rail application.



### 11.3 Thermal Considerations

Implementation of integrated circuits in low-profile and fine-pitch surface-mount packages typically requires special attention to power dissipation. Many system-dependent issues such as thermal coupling, airflow, added heat sinks and convection surfaces, and the presence of other heat-generating components affect the power-dissipation limits of a given component.

Three basic approaches for enhancing thermal performance are listed below:

- Improving the power dissipation capability of the PCB design
- Improving the thermal coupling of the component to the PCB by soldering the Exposed Thermal Pad
- Introducing airflow in the system

For more details on how to use the thermal parameters, see the application notes: thermal characteristics application note ([SZZA017](#)), and ([SPRA953](#)).

The TLV62130 is designed for a maximum operating junction temperature ( $T_j$ ) of 125°C. Therefore the maximum output power is limited by the power losses that can be dissipated over the actual thermal resistance, given by the package and the surrounding PCB structures. Since the thermal resistance of the package is fixed, increasing the size of the surrounding copper area and improving the thermal connection to the IC can reduce the thermal resistance. To get an improved thermal behavior, it's recommended to use top layer metal to connect the device with wide and thick metal lines. Internal ground layers can connect to vias directly under the IC for improved thermal performance.

If short circuit or overload conditions are present, the device is protected by limiting internal power dissipation. Experimental data, taken from the TLV62130 EVM, shows the maximum ambient temperature (without additional cooling like airflow or heat sink), that can be allowed to limit the junction temperature to at most 125°C (see [Figure 36](#)).

## 12 デバイスおよびドキュメントのサポート

### 12.1 デバイス・サポート

#### 12.1.1 デベロッパー・ネットワークの製品に関する免責事項

デベロッパー・ネットワークの製品またはサービスに関するTIの出版物は、単独またはTIの製品、サービスと一緒に提供される場合に関係なく、デベロッパー・ネットワークの製品またはサービスの適合性に関する是認、デベロッパー・ネットワークの製品またはサービスの是認の表明を意味するものではありません。

#### 12.1.2 開発サポート

##### 12.1.2.1 WEBENCH®ツールによるカスタム設計

[ここをクリック](#)すると、WEBENCH® Power Designerにより、TLV62130を使用するカスタム設計を作成できます。

1. 最初に、入力電圧( $V_{IN}$ )、出力電圧( $V_{OUT}$ )、出力電流( $I_{OUT}$ )の要件を入力します。
2. オプティマイザのダイヤルを使用して、効率、占有面積、コストなどの主要なパラメータについて設計を最適化します。
3. 生成された設計を、テキサス・インスツルメンツが提供する他の方式と比較します。

WEBENCH Power Designerでは、カスタマイズされた回路図と部品リストを、リアルタイムの価格と部品の在庫情報と併せて参照できます。

通常、次の操作を実行可能です。

- 電氣的なシミュレーションを実行し、重要な波形と回路の性能を確認する。
- 熱シミュレーションを実行し、基板の熱特性を把握する。
- カスタマイズされた回路図やレイアウトを、一般的なCADフォーマットで出力する。
- 設計のレポートをPDFで印刷し、設計を共有する。

WEBENCHツールの詳細は、[www.ti.com/WBENCH](http://www.ti.com/WBENCH)でご覧になれます。

### 12.2 ドキュメントの更新通知を受け取る方法

ドキュメントの更新についての通知を受け取るには、[ti.com](http://ti.com)のデバイス製品フォルダを開いてください。右上の隅にある「通知を受け取る」をクリックして登録すると、変更されたすべての製品情報に関するダイジェストを毎週受け取れます。変更の詳細については、修正されたドキュメントに含まれている改訂履歴をご覧ください。

### 12.3 ドキュメントのサポート

#### 12.3.1 関連資料

関連資料については、以下を参照してください。

- 『TLV62130EVM-505およびTLV62150EVM-505評価モジュール』、[SLAU416](#)
- EVM Gerberデータ、[SLVC394](#)
- 『JEDEC PCB設計を使用するリニアおよびロジック・パッケージの熱特性』、[SZZA017](#)
- 『半導体およびICパッケージの熱指標』、[SPRA953](#)

### 12.4 関連リンク

次の表に、クイック・アクセス・リンクを示します。カテゴリには、技術資料、サポートおよびコミュニティ・リソース、ツールとソフトウェア、およびサンプル注文またはご購入へのクイック・アクセスが含まれます。

表 6. 関連リンク

| 製品        | プロダクト・フォルダ              | ご注文はこちら                 | 技術資料                    | ツールとソフトウェア              | サポートとコミュニティ             |
|-----------|-------------------------|-------------------------|-------------------------|-------------------------|-------------------------|
| TLV62130  | <a href="#">ここをクリック</a> | <a href="#">ここをクリック</a> | <a href="#">ここをクリック</a> | <a href="#">ここをクリック</a> | <a href="#">ここをクリック</a> |
| TLV62130A | <a href="#">ここをクリック</a> | <a href="#">ここをクリック</a> | <a href="#">ここをクリック</a> | <a href="#">ここをクリック</a> | <a href="#">ここをクリック</a> |

## 12.5 コミュニティ・リソース

The following links connect to TI community resources. Linked contents are provided "AS IS" by the respective contributors. They do not constitute TI specifications and do not necessarily reflect TI's views; see TI's [Terms of Use](#).

**TI E2E™オンライン・コミュニティ** *TIのE2E ( Engineer-to-Engineer )* コミュニティ。エンジニア間の共同作業を促進するために開設されたものです。e2e.ti.comでは、他のエンジニアに質問し、知識を共有し、アイデアを検討して、問題解決に役立てることができます。

**設計サポート** *TIの設計サポート* 役に立つE2Eフォーラムや、設計サポート・ツールをすばやく見つけることができます。技術サポート用の連絡先情報も参照できます。

## 12.6 Trademarks

DCS-Control, E2E are trademarks of Texas Instruments.  
WEBENCH is a registered trademark of Texas Instruments.  
All other trademarks are the property of their respective owners.

## 12.7 Electrostatic Discharge Caution



これらのデバイスは、限定的なESD (静電破壊) 保護機能を内蔵しています。保存時または取り扱い時は、MOSゲートに対する静電破壊を防止するために、リード線同士をショートさせておくか、デバイスを導電フォームに入れる必要があります。

## 12.8 Glossary

**SLYZ022** — *TI Glossary*.

This glossary lists and explains terms, acronyms, and definitions.

## 13 メカニカル、パッケージ、および注文情報

以降のページには、メカニカル、パッケージ、および注文に関する情報が記載されています。この情報は、そのデバイスについて利用可能な最新のデータです。このデータは予告なく変更されることがあり、ドキュメントが改訂される場合もあります。本データシートのブラウザ版を使用されている場合は、画面左側の説明をご覧ください。

**PACKAGING INFORMATION**

| Orderable part number         | Status<br>(1) | Material type<br>(2) | Package   Pins  | Package qty   Carrier | RoHS<br>(3) | Lead finish/<br>Ball material<br>(4) | MSL rating/<br>Peak reflow<br>(5) | Op temp (°C) | Part marking<br>(6) |
|-------------------------------|---------------|----------------------|-----------------|-----------------------|-------------|--------------------------------------|-----------------------------------|--------------|---------------------|
| <a href="#">TLV62130ARGTR</a> | Active        | Production           | VQFN (RGT)   16 | 3000   LARGE T&R      | Yes         | NIPDAU                               | Level-2-260C-1 YEAR               | -40 to 85    | VUNI                |
| TLV62130ARGTR.A               | Active        | Production           | VQFN (RGT)   16 | 3000   LARGE T&R      | Yes         | NIPDAU                               | Level-2-260C-1 YEAR               | -40 to 85    | VUNI                |
| TLV62130ARGTR.B               | Active        | Production           | VQFN (RGT)   16 | 3000   LARGE T&R      | Yes         | NIPDAU                               | Level-2-260C-1 YEAR               | -40 to 85    | VUNI                |
| TLV62130ARGTRG4               | Active        | Production           | VQFN (RGT)   16 | 3000   LARGE T&R      | Yes         | NIPDAU                               | Level-2-260C-1 YEAR               | -40 to 85    | VUNI                |
| TLV62130ARGTRG4.A             | Active        | Production           | VQFN (RGT)   16 | 3000   LARGE T&R      | Yes         | NIPDAU                               | Level-2-260C-1 YEAR               | -40 to 85    | VUNI                |
| TLV62130ARGTRG4.B             | Active        | Production           | VQFN (RGT)   16 | 3000   LARGE T&R      | Yes         | NIPDAU                               | Level-2-260C-1 YEAR               | -40 to 85    | VUNI                |
| <a href="#">TLV62130ARGTT</a> | Active        | Production           | VQFN (RGT)   16 | 250   SMALL T&R       | Yes         | NIPDAU                               | Level-2-260C-1 YEAR               | -40 to 85    | VUNI                |
| TLV62130ARGTT.A               | Active        | Production           | VQFN (RGT)   16 | 250   SMALL T&R       | Yes         | NIPDAU                               | Level-2-260C-1 YEAR               | -40 to 85    | VUNI                |
| TLV62130ARGTT.B               | Active        | Production           | VQFN (RGT)   16 | 250   SMALL T&R       | Yes         | NIPDAU                               | Level-2-260C-1 YEAR               | -40 to 85    | VUNI                |
| <a href="#">TLV62130RGTR</a>  | Active        | Production           | VQFN (RGT)   16 | 3000   LARGE T&R      | Yes         | NIPDAU                               | Level-2-260C-1 YEAR               | -40 to 85    | VUBI                |
| TLV62130RGTR.A                | Active        | Production           | VQFN (RGT)   16 | 3000   LARGE T&R      | Yes         | NIPDAU                               | Level-2-260C-1 YEAR               | -40 to 85    | VUBI                |
| TLV62130RGTR.B                | Active        | Production           | VQFN (RGT)   16 | 3000   LARGE T&R      | Yes         | NIPDAU                               | Level-2-260C-1 YEAR               | -40 to 85    | VUBI                |
| TLV62130RGTRG4                | Active        | Production           | VQFN (RGT)   16 | 3000   LARGE T&R      | Yes         | NIPDAU                               | Level-2-260C-1 YEAR               | -40 to 85    | VUBI                |
| TLV62130RGTRG4.A              | Active        | Production           | VQFN (RGT)   16 | 3000   LARGE T&R      | Yes         | NIPDAU                               | Level-2-260C-1 YEAR               | -40 to 85    | VUBI                |
| TLV62130RGTRG4.B              | Active        | Production           | VQFN (RGT)   16 | 3000   LARGE T&R      | Yes         | NIPDAU                               | Level-2-260C-1 YEAR               | -40 to 85    | VUBI                |
| <a href="#">TLV62130RGTT</a>  | Active        | Production           | VQFN (RGT)   16 | 250   SMALL T&R       | Yes         | NIPDAU                               | Level-2-260C-1 YEAR               | -40 to 85    | VUBI                |
| TLV62130RGTT.A                | Active        | Production           | VQFN (RGT)   16 | 250   SMALL T&R       | Yes         | NIPDAU                               | Level-2-260C-1 YEAR               | -40 to 85    | VUBI                |
| TLV62130RGTT.B                | Active        | Production           | VQFN (RGT)   16 | 250   SMALL T&R       | Yes         | NIPDAU                               | Level-2-260C-1 YEAR               | -40 to 85    | VUBI                |

(1) **Status:** For more details on status, see our [product life cycle](#).

(2) **Material type:** When designated, preproduction parts are prototypes/experimental devices, and are not yet approved or released for full production. Testing and final process, including without limitation quality assurance, reliability performance testing, and/or process qualification, may not yet be complete, and this item is subject to further changes or possible discontinuation. If available for ordering, purchases will be subject to an additional waiver at checkout, and are intended for early internal evaluation purposes only. These items are sold without warranties of any kind.

(3) **RoHS values:** Yes, No, RoHS Exempt. See the [TI RoHS Statement](#) for additional information and value definition.

(4) **Lead finish/Ball material:** Parts may have multiple material finish options. Finish options are separated by a vertical ruled line. Lead finish/Ball material values may wrap to two lines if the finish value exceeds the maximum column width.

(5) **MSL rating/Peak reflow:** The moisture sensitivity level ratings and peak solder (reflow) temperatures. In the event that a part has multiple moisture sensitivity ratings, only the lowest level per JEDEC standards is shown. Refer to the shipping label for the actual reflow temperature that will be used to mount the part to the printed circuit board.

(6) **Part marking:** There may be an additional marking, which relates to the logo, the lot trace code information, or the environmental category of the part.

Multiple part markings will be inside parentheses. Only one part marking contained in parentheses and separated by a "~" will appear on a part. If a line is indented then it is a continuation of the previous line and the two combined represent the entire part marking for that device.

**Important Information and Disclaimer:**The information provided on this page represents TI's knowledge and belief as of the date that it is provided. TI bases its knowledge and belief on information provided by third parties, and makes no representation or warranty as to the accuracy of such information. Efforts are underway to better integrate information from third parties. TI has taken and continues to take reasonable steps to provide representative and accurate information but may not have conducted destructive testing or chemical analysis on incoming materials and chemicals. TI and TI suppliers consider certain information to be proprietary, and thus CAS numbers and other limited information may not be available for release.

In no event shall TI's liability arising out of such information exceed the total purchase price of the TI part(s) at issue in this document sold by TI to Customer on an annual basis.

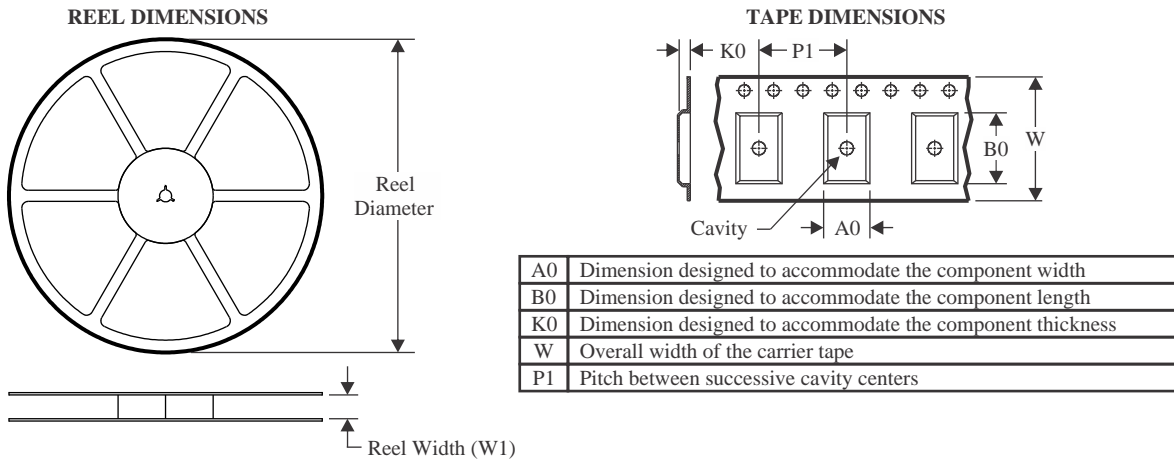
**TAPE AND REEL INFORMATION**

**QUADRANT ASSIGNMENTS FOR PIN 1 ORIENTATION IN TAPE**



\*All dimensions are nominal

| Device          | Package Type | Package Drawing | Pins | SPQ  | Reel Diameter (mm) | Reel Width W1 (mm) | A0 (mm) | B0 (mm) | K0 (mm) | P1 (mm) | W (mm) | Pin1 Quadrant |
|-----------------|--------------|-----------------|------|------|--------------------|--------------------|---------|---------|---------|---------|--------|---------------|
| TLV62130ARGTR   | VQFN         | RGT             | 16   | 3000 | 330.0              | 12.4               | 3.3     | 3.3     | 1.1     | 8.0     | 12.0   | Q2            |
| TLV62130ARGTRG4 | VQFN         | RGT             | 16   | 3000 | 330.0              | 12.4               | 3.3     | 3.3     | 1.1     | 8.0     | 12.0   | Q2            |
| TLV62130ARGTT   | VQFN         | RGT             | 16   | 250  | 180.0              | 12.4               | 3.3     | 3.3     | 1.1     | 8.0     | 12.0   | Q2            |
| TLV62130RGTR    | VQFN         | RGT             | 16   | 3000 | 330.0              | 12.4               | 3.3     | 3.3     | 1.1     | 8.0     | 12.0   | Q2            |
| TLV62130RGTR    | VQFN         | RGT             | 16   | 3000 | 330.0              | 12.4               | 3.3     | 3.3     | 1.1     | 8.0     | 12.0   | Q2            |
| TLV62130RGTRG4  | VQFN         | RGT             | 16   | 3000 | 330.0              | 12.4               | 3.3     | 3.3     | 1.1     | 8.0     | 12.0   | Q2            |
| TLV62130RGTT    | VQFN         | RGT             | 16   | 250  | 180.0              | 12.5               | 3.3     | 3.3     | 1.1     | 8.0     | 12.0   | Q2            |
| TLV62130RGTT    | VQFN         | RGT             | 16   | 250  | 180.0              | 12.4               | 3.3     | 3.3     | 1.1     | 8.0     | 12.0   | Q2            |

**TAPE AND REEL BOX DIMENSIONS**

\*All dimensions are nominal

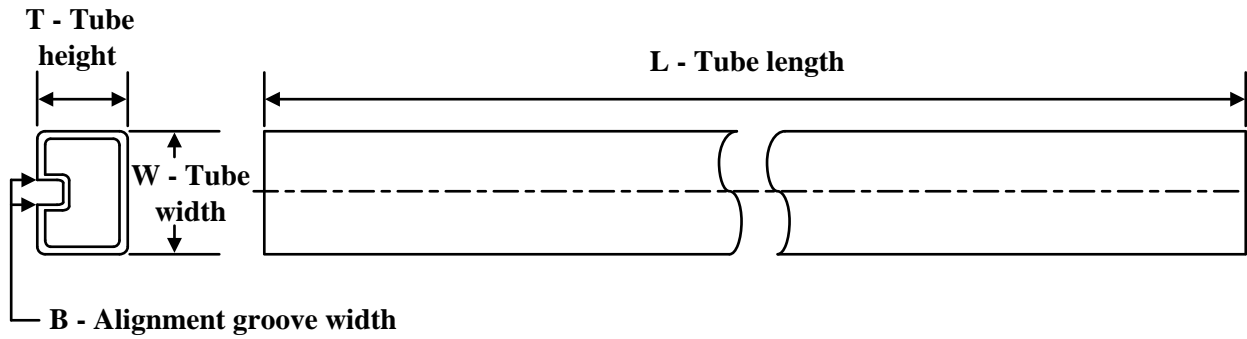
| Device          | Package Type | Package Drawing | Pins | SPQ  | Length (mm) | Width (mm) | Height (mm) |
|-----------------|--------------|-----------------|------|------|-------------|------------|-------------|
| TLV62130ARGTR   | VQFN         | RGT             | 16   | 3000 | 346.0       | 346.0      | 33.0        |
| TLV62130ARGTRG4 | VQFN         | RGT             | 16   | 3000 | 346.0       | 346.0      | 33.0        |
| TLV62130ARGTT   | VQFN         | RGT             | 16   | 250  | 210.0       | 185.0      | 35.0        |
| TLV62130RGTR    | VQFN         | RGT             | 16   | 3000 | 338.0       | 355.0      | 35.0        |
| TLV62130RGTR    | VQFN         | RGT             | 16   | 3000 | 552.0       | 346.0      | 36.0        |
| TLV62130RGTRG4  | VQFN         | RGT             | 16   | 3000 | 552.0       | 346.0      | 36.0        |
| TLV62130RGTT    | VQFN         | RGT             | 16   | 250  | 338.0       | 355.0      | 35.0        |
| TLV62130RGTT    | VQFN         | RGT             | 16   | 250  | 552.0       | 185.0      | 36.0        |

**TUBE**

\*All dimensions are nominal

| Device           | Package Name | Package Type | Pins | SPQ  | L (mm) | W (mm) | T (μm) | B (mm) |
|------------------|--------------|--------------|------|------|--------|--------|--------|--------|
| TLV62130RGTR     | RGT          | VQFN         | 16   | 3000 | 381    | 4.83   | 2286   | 0      |
| TLV62130RGTR.A   | RGT          | VQFN         | 16   | 3000 | 381    | 4.83   | 2286   | 0      |
| TLV62130RGTR.B   | RGT          | VQFN         | 16   | 3000 | 381    | 4.83   | 2286   | 0      |
| TLV62130RGTRG4   | RGT          | VQFN         | 16   | 3000 | 381    | 4.83   | 2286   | 0      |
| TLV62130RGTRG4.A | RGT          | VQFN         | 16   | 3000 | 381    | 4.83   | 2286   | 0      |
| TLV62130RGTRG4.B | RGT          | VQFN         | 16   | 3000 | 381    | 4.83   | 2286   | 0      |
| TLV62130RGTT     | RGT          | VQFN         | 16   | 250  | 381    | 4.83   | 2286   | 0      |
| TLV62130RGTT.A   | RGT          | VQFN         | 16   | 250  | 381    | 4.83   | 2286   | 0      |
| TLV62130RGTT.B   | RGT          | VQFN         | 16   | 250  | 381    | 4.83   | 2286   | 0      |

**RGT 16**

**GENERIC PACKAGE VIEW**

**VQFN - 1 mm max height**

PLASTIC QUAD FLATPACK - NO LEAD

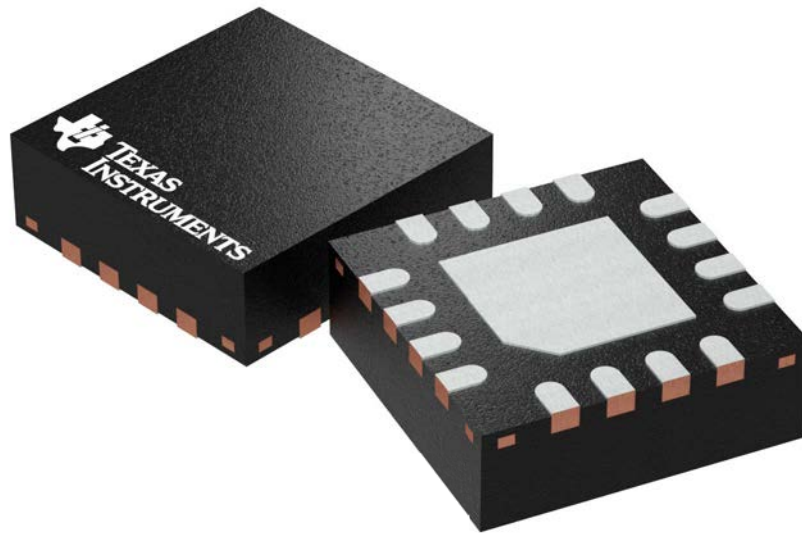

Images above are just a representation of the package family, actual package may vary.  
Refer to the product data sheet for package details.

4203495/1

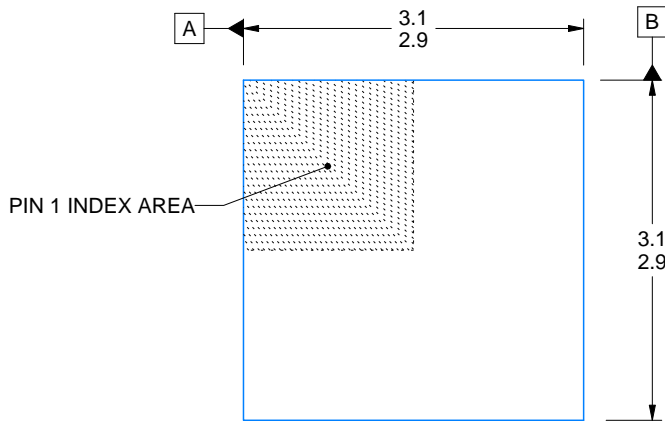
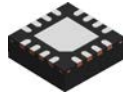

| SIDE WALL METAL THICKNESS DIM A |          |
|---------------------------------|----------|
| OPTION 1                        | OPTION 2 |
| 0.1                             | 0.2      |

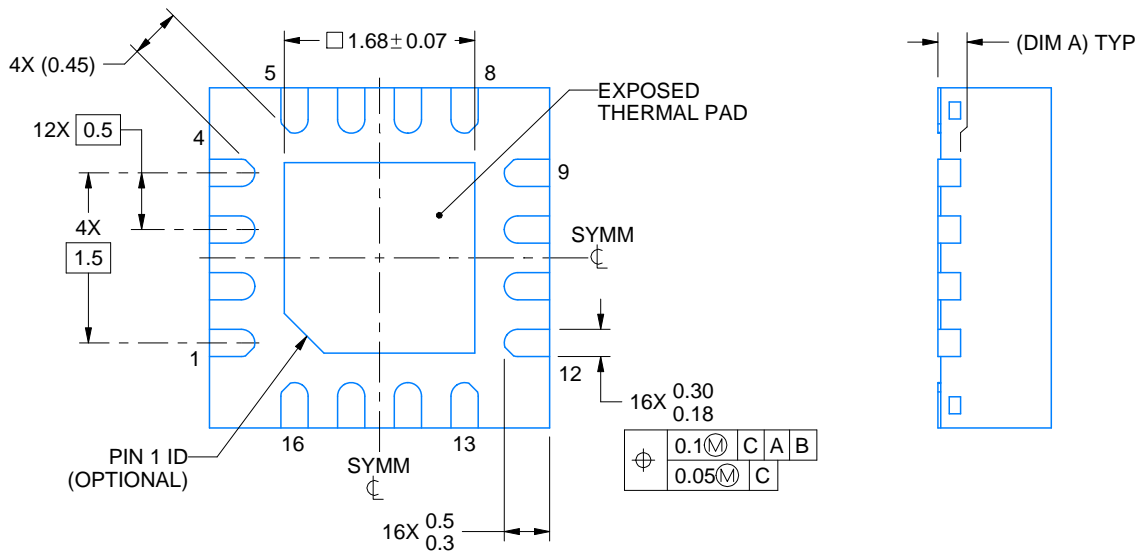
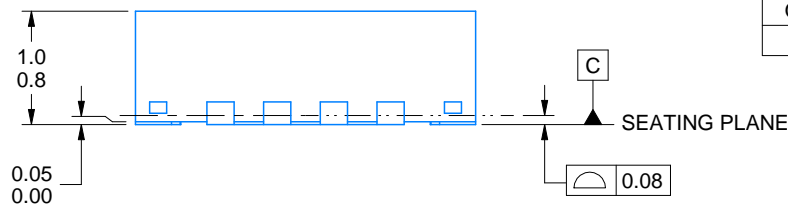

4222419/E 07/2025

NOTES:

1. All linear dimensions are in millimeters. Any dimensions in parenthesis are for reference only. Dimensioning and tolerancing per ASME Y14.5M.
2. This drawing is subject to change without notice.
3. The package thermal pad must be soldered to the printed circuit board for thermal and mechanical performance.





## 重要なお知らせと免責事項

TI は、技術データと信頼性データ (データシートを含みます)、設計リソース (リファレンス デザインを含みます)、アプリケーションや設計に関する各種アドバイス、Web ツール、安全性情報、その他のリソースを、欠陥が存在する可能性のある「現状のまま」提供しており、商品性および特定目的に対する適合性の黙示保証、第三者の知的財産権の非侵害保証を含むいかなる保証も、明示的または黙示的にかかわらず拒否します。

これらのリソースは、TI 製品を使用する設計の経験を積んだ開発者への提供を意図したものです。(1) お客様のアプリケーションに適した TI 製品の選定、(2) お客様のアプリケーションの設計、検証、試験、(3) お客様のアプリケーションに該当する各種規格や、その他のあらゆる安全性、セキュリティ、規制、または他の要件への確実な適合に関する責任を、お客様のみが単独で負うものとし、

上記の各種リソースは、予告なく変更される可能性があります。これらのリソースは、リソースで説明されている TI 製品を使用するアプリケーションの開発の目的でのみ、TI はその使用をお客様に許諾します。これらのリソースに関して、他の目的で複製することや掲載することは禁止されています。TI や第三者の知的財産権のライセンスが付与されている訳ではありません。お客様は、これらのリソースを自身で使用した結果発生するあらゆる申し立て、損害、費用、損失、責任について、TI およびその代理人を完全に補償するものとし、TI は一切の責任を拒否します。

TI の製品は、[TI の販売条件](#)、[TI の総合的な品質ガイドライン](#)、[ti.com](#) または TI 製品などに関連して提供される他の適用条件に従い提供されます。TI がこれらのリソースを提供することは、適用される TI の保証または他の保証の放棄の拡大や変更を意味するものではありません。TI がカスタム、またはカスタマー仕様として明示的に指定していない限り、TI の製品は標準的なカタログに掲載される汎用機器です。

お客様がいかなる追加条項または代替条項を提案する場合も、TI はそれらに異議を唱え、拒否します。

Copyright © 2026, Texas Instruments Incorporated

最終更新日 : 2025 年 10 月