

TPS61098x 超低静止電流、同期整流昇圧コンバータ、LDO / ロード・スイッチ内蔵

1 特長

- 低消費電力モードで 300nA のきわめて低い I_Q を実現
- 有負荷状態でも入力電圧 0.7V からスタートアップ
- 動作入力電圧: 0.7V~4.5V
- 最大 4.3V までの出力電圧を選択可能
- 最小 350mA のスイッチ・ピーク電流制限
- LDO / ロード・スイッチを内蔵
- MODE ピンにより 2 つのモードを制御
 - アクティブ・モード: デュアル出力を設定値に設定
 - 低電力モード: LDO / ロード・スイッチ・オフ、昇圧コンバータはオンを維持
- 自動パス・スルー
- 2V から 3.3V への変換時、10 μ A の負荷で最大 88% の効率 (低消費電力モード)
- 2V から 3.3V への変換時、5mA~100mA の負荷で最大 93% の効率
- 1.5mm × 1.5mm WSON パッケージ

2 アプリケーション

- スマート・リモート・コントロール
- BLE タグ
- ウェアラブル・アプリケーション
- 低消費電力ワイヤレス・アプリケーション
- ポータブル・コンシューマ または医療 製品
- 1 コイン・セル、1 セルまたは 2 セルのアルカリ電池駆動アプリケーション

3 概要

TPS61098x は、1 セルまたは 2 セルのアルカリ、NiCd、NiMH、1 セルのコイン電池、1 セルのリチウムイオンまたはリチウムポリマ・バッテリーのいずれかで電力を供給する製品向けの超低消費電力ソリューションです。低ドロップアウト

トリア・レギュレータ (LDO) または昇圧コンバータ付きのロード・スイッチを内蔵し、2 つの出力レールを提供します。昇圧出力 $V_{(MAIN)}$ はメイン・システムの常時オン電源として設計され、LDO またはロード・スイッチ出力 $V_{(SUB)}$ はペリフェラル・デバイスへの電力供給用です。

TPS61098x には、MODE ピンで制御される 2 つのモード、すなわち、アクティブ・モードと低消費電力モードがあります。アクティブ・モードでは、両方の出力が有効になり、応答性能が強化されています。低消費電力モードでは、LDO またはロード・スイッチがディセーブルになり、周辺回路を切断します。TPS61098x の静止電流はわずか 300nA で、低消費電力モードのとき 10 μ A の負荷で最大 88% の効率を実現します。

TPS61098x は自動パススルー機能をサポートしています。入力電圧がパススルー・スレッシュホールドを上回ると、昇圧コンバータはスイッチングを停止し、入力電圧を V_{MAIN} レールに通過させます。入力電圧がスレッシュホールドを下回ると、昇圧モードで動作し、目標値に合わせて出力をレギュレートします。TPS61098x には、出力設定値が異なるバージョンがあります。

TPS61098x は、0.7V の入力から 3.3V の出力への変換時に、最大 50mA の合計出力電流を供給できます。昇圧コンバータは、同期整流を使用するヒステリシス式の制御トポロジに基づいて、最小の静止電流で最大の効率を実現します。

TPS61098x は 1.5mm × 1.5mm の WSON パッケージで供給されるため、回路のレイアウトを小型化できます。

製品情報

部品番号	パッケージ ⁽¹⁾	本体サイズ (公称)
TPS61098x	6 ピン WSON	1.50mm × 1.50mm

- (1) 利用可能なすべてのパッケージについては、このデータシートの末尾にある注文情報を参照してください。

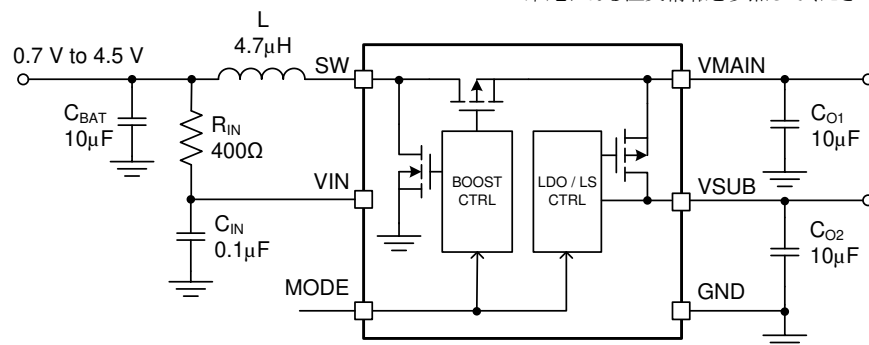

Copyright © 2016, Texas Instruments Incorporated

概略回路図



Table of Contents

1 特長	1	9 Applications and Implementation	21
2 アプリケーション	1	9.1 Application Information.....	21
3 概要	1	9.2 Typical Applications.....	21
4 Revision History	2	10 Power Supply Recommendations	33
5 Device Comparison Table	3	11 Layout	34
6 Pin Configuration and Functions	3	11.1 Layout Guidelines.....	34
7 Specifications	4	11.2 Layout Example.....	34
7.1 Absolute Maximum Ratings.....	4	12 Device and Documentation Support	35
7.2 ESD Ratings.....	4	12.1 Device Support.....	35
7.3 Recommended Operating Conditions.....	4	12.2 Documentation Support.....	35
7.4 Thermal Information.....	4	12.3 Receiving Notification of Documentation Updates..	35
7.5 Electrical Characteristics.....	5	12.4 サポート・リソース.....	35
7.6 Typical Characteristics.....	7	12.5 Trademarks.....	35
8 Detailed Description	16	12.6 静電気放電に関する注意事項.....	35
8.1 Overview.....	16	12.7 用語集.....	35
8.2 Functional Block Diagrams.....	16	13 Mechanical, Packaging, and Orderable	
8.3 Feature Description.....	17	Information	35
8.4 Device Functional Modes.....	19		

4 Revision History

資料番号末尾の英字は改訂を表しています。その改訂履歴は英語版に準じています。

Changes from Revision E (December 2016) to Revision F (September 2021)	Page
• 文書全体にわたって表、図、相互参照の採番方法を更新.....	1

Changes from Revision D (April 2016) to Revision E (November 2016)	Page
• Changed the HBM value From: ± 1000 To: ± 2000 in セクション 7.2	4
• Changed the CDM value From: ± 250 To: ± 750 in セクション 7.2	4

5 Device Comparison Table

PART NUMBER	INTEGRATED LDO OR LOAD SWITCH	VMAIN (ACTIVE MODE)	VMAIN (LOW POWER MODE)	VSUB (ACTIVE MODE)	VSUB (LOW POWER MODE)	VSUB ACTIVE DISCHARGE IN LOW POWER MODE
TPS61098DSE ⁽¹⁾	LDO	4.3 V	2.2 V	3.1 V	OFF	No
TPS610981DSE	LDO	3.3 V	3.3 V	3.0 V	OFF	Yes
TPS610982DSE	LDO	3.3 V	3.3 V	2.8 V	2.8 V	No
TPS610985DSE	Load Switch	3.0 V	3.0 V	ON	OFF	Yes
TPS610986DSE	Load Switch	3.3 V	3.3 V	ON	OFF	Yes
TPS610987DSE	LDO	4.3 V	2.2 V	3.1 V	OFF	Yes

(1) The DSE package is available taped and reeled. Add R suffix to device type (for example, TPS61098DSER) to order quantities of 3000 devices per reel. Add T suffix to device type (for example, TPS61098DSET) to order quantities of 250 devices per reel. For detailed ordering information, please check the [package option addendum](#) at the end of this data sheet.

6 Pin Configuration and Functions



图 6-1. DSE Package 6-Pin WSON Top View

表 6-1. Pin Functions

PIN		I/O	DESCRIPTION
NAME	NO.		
VMAIN	1	PWR	Boost converter output
SW	2	PWR	Connection for inductor
VIN	3	I	IC power supply input
MODE	4	I	Mode selection pin. 1: Active mode; 0: Low Power mode. Must be actively tied high or low. Do not leave floating.
VSUB	5	PWR	LDO or load switch output
GND	6	PWR	IC ground

7 Specifications

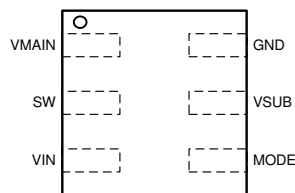
7.1 Absolute Maximum Ratings

over operating free-air temperature range (unless otherwise noted)⁽¹⁾

		MIN	MAX	UNIT
Input voltage	VIN, SW, VMAIN, VSUB	-0.3	4.7	V
	MODE	-0.3	5.0	V
Operating junction temperature, T _J		-40	150	°C
Storage temperature range, T _{stg}		-65	150	°C

- (1) Stresses beyond those listed under *Absolute Maximum Ratings* may cause permanent damage to the device. These are stress ratings only, and functional operation of the device at these or any other conditions beyond those indicated under *Recommended Operating Conditions* is not implied. Exposure to absolute-maximum-rated conditions for extended periods may affect device reliability.

7.2 ESD Ratings

		VALUE	UNIT
V _(ESD)	Electrostatic discharge		
	Human Body Model (HBM), per ANSI/ESDA/JEDEC JS-001, all pins ⁽¹⁾	±2000	V
	Charged Device Model (CDM), per JEDEC specification JESD22-C101, all pins ⁽²⁾	±750	

- (1) JEDEC document JEP155 states that 500V HBM rating allows safe manufacturing with a standard ESD control process.
 (2) JEDEC document JEP157 states that 250V CDM rating allows safe manufacturing with a standard ESD control process.

7.3 Recommended Operating Conditions

		MIN	NOM	MAX	UNIT
V _{IN}	Input voltage range	0.7		4.5	V
V _(MAIN)	Boost converter output voltage range	2.2		4.3	V
V _(SUB)	Load switch / LDO output voltage range	1.8		3.7	V
L	Effective inductance range	1.54	4.7	6.11	µH
C _{BAT}	Effective input capacitance range at input ⁽¹⁾	5			µF
C _{O1}	Effective output capacitance range at VMAIN pin for boost converter output ⁽¹⁾	5	10	22	µF
C _{O2}	Effective output capacitance range at VSUB pin for LDO output ⁽¹⁾	1 ⁽²⁾	5	10	µF
	Effective output capacitance range at VSUB pin for load switch output ^{(1) (3)}		1	2.2	µF
T _J	Operating virtual junction temperature	-40		125	°C

- (1) Effective value. Ceramic capacitor's derating effect under bias should be considered. Choose the right nominal capacitance by checking capacitor DC bias characteristics.
 (2) If LDO output current is lower than 20 mA, the minimum effective output capacitance value can be lower to 0.5 µF.
 (3) With load switch version, the output capacitor at VSUB pin is only required if smaller voltage ripple is needed.

7.4 Thermal Information

THERMAL METRIC ⁽¹⁾		TPS61098x	UNIT
		DSE 6 PINS	
R _{θJA}	Junction-to-ambient thermal resistance	207.3	°C/W
R _{θJctop}	Junction-to-case (top) thermal resistance	118.9	°C/W
R _{θJB}	Junction-to-board thermal resistance	136.4	°C/W
Ψ _{JT}	Junction-to-top characterization parameter	8.3	°C/W
Ψ _{JB}	Junction-to-board characterization parameter	136.4	°C/W
R _{θJcbot}	Junction-to-case (bottom) thermal resistance	N/A	°C/W

- (1) For more information about traditional and new thermal metrics, see the [Semiconductor and IC Package Thermal Metrics](#) application report.

7.5 Electrical Characteristics

$T_J = -40^{\circ}\text{C}$ to 125°C and $V_{IN} = 0.7\text{ V}$ to 4.5 V . Typical values are at $V_{IN} = 1.5\text{ V}$, $T_J = 25^{\circ}\text{C}$, unless otherwise noted.

PARAMETER		VERSION	TEST CONDITIONS	MIN	TYP	MAX	UNIT
Power Supply							
V_{IN}	Input voltage range	TPS61098x		0.7		4.5	V
$V_{IN(\text{start})}$	Minimum input voltage at start-up	TPS61098x	$R_{\text{Load}} \geq 3\text{ k}\Omega$ ⁽¹⁾			0.7	V
$I_{Q(VIN)}$	Quiescent current into the VIN pin in Active mode	TPS61098x	MODE = High, Boost or Pass-through no load, no switching $T_J = -40^{\circ}\text{C}$ to 85°C		2	4	μA
	Quiescent current into the VIN pin in Low Power mode	TPS61098x	MODE = Low, Boost or Pass-through no load, no switching		5	90	nA
$I_{Q(VMAIN)}$	Quiescent current into the VMAIN pin in Active mode	TPS61098/1/5/6/7	MODE = High, Boost or Pass-through no load, no switching $T_J = -40^{\circ}\text{C}$ to 85°C		15	23	μA
		TPS610982	MODE = High, Boost or Pass-through no load, no switching $T_J = -40^{\circ}\text{C}$ to 85°C		18	23	μA
	Quiescent current into the VMAIN pin in Low Power mode	TPS61098/1/7	MODE = Low, Boost or Pass-through no load, no switching $T_J = 25^{\circ}\text{C}$		300	400	nA
		TPS61098/1/5/6/7	MODE = Low, Boost or Pass-through no load, no switching $T_J = -40^{\circ}\text{C}$ to 85°C		300	800	nA
		TPS610982	MODE = Low, Boost or Pass-through no load, no switching $T_J = -40^{\circ}\text{C}$ to 85°C		4	10	μA
$I_{\text{LKG}(SW)}$	Leakage current of the SW pin (from the SW pin to GND pin)	TPS61098x	$V_{(MAIN)} = V_{(SW)} = 4.7\text{ V}$, no load $T_J = -40^{\circ}\text{C}$ to 85°C		5	100	nA
$I_{\text{LKG}(MAIN)}$	Leakage current of the VMAIN pin (from the VMAIN pin to SW pin)	TPS61098x	$V_{(MAIN)} = 4.7\text{ V}$, $V_{(SW)} = 0\text{ V}$, no load $T_J = -40^{\circ}\text{C}$ to 85°C		10	200	nA
$I_{\text{LKG}(SUB)}$	Leakage current of the VSUB pin (from the VMAIN pin to VSUB pin)	TPS61098/1/5/6/7	MODE = Low, $V_{(MAIN)} = 4.7\text{ V}$, $V_{(SUB)} = 0\text{ V}$ $T_J = -40^{\circ}\text{C}$ to 85°C		10	150	nA
$I_{\text{LKG}(MODE)}$	Leakage current into the MODE pin	TPS61098x	$V_{(MODE)} = 5\text{ V}$ $T_J = -40^{\circ}\text{C}$ to 85°C		5	30	nA
Power Switch							
$R_{DS(\text{on})_LS}$	Low-side switch on resistance	TPS61098/7	MODE = Low		600	1000	m Ω
			MODE = High		300	600	m Ω
		TPS610981/2/6	MODE = Low / High		350	650	m Ω
		TPS610985	MODE = Low / High		400	700	m Ω
$R_{DS(\text{on})_HS}$	Rectifier on resistance	TPS61098/7	MODE = Low		700	1000	m Ω
			MODE = High		450	700	m Ω
		TPS610981/2/6	MODE = Low / High		500	700	m Ω
		TPS610985	MODE = Low / High		550	750	m Ω
$R_{(LS)}$	Load switch on resistance	TPS610985/6			1.2	2	Ω
$V_{(\text{Dropout})}$	LDO dropout voltage	TPS61098/1/2/7	$I_{\text{SUB}} = 50\text{ mA}$		60	100	mV
I_{LH}	Inductor current ripple	TPS61098x			100		mA
$I_{\text{LIM}(BST)}$	Boost switch current limit	TPS61098x	$0.7\text{ V} < V_{IN} < V_{(MAIN)}$	350	500	650	mA
$I_{\text{LIM}(SUB)}$	VSUB output current limit	TPS61098x	$T_J = -20^{\circ}\text{C}$ to 125°C	200			mA
$I_{(\text{DISCH})}$	Discharge current from the VSUB pin to GND pin	TPS610981/5/6/7	MODE = Low, $V_{(SUB)} = 3\text{ V}$	5	8		mA

$T_J = -40^{\circ}\text{C}$ to 125°C and $V_{IN} = 0.7\text{ V}$ to 4.5 V . Typical values are at $V_{IN} = 1.5\text{ V}$, $T_J = 25^{\circ}\text{C}$, unless otherwise noted.

PARAMETER		VERSION	TEST CONDITIONS	MIN	TYP	MAX	UNIT
Output							
$V_{(MAIN)}$	Boost converter output voltage	TPS61098/7	MODE = High, $V_{IN} < V_{(PSTH)}$, Burst mode, open loop		4.45		V
			MODE = High, $V_{IN} < V_{(PSTH)}$, PWM mode, open loop	4.142	4.27	4.398	V
			MODE = Low, $V_{IN} < V_{(PSTH)}$, Burst mode, open loop		2.3		V
			MODE = Low, $V_{IN} < V_{(PSTH)}$, PWM mode, open loop	2.163	2.23	2.297	V
		TPS610981	MODE = High / Low, $V_{IN} < V_{(PSTH)}$, Burst mode, open loop		3.4		V
			MODE = High / Low, $V_{IN} < V_{(PSTH)}$, PWM mode, open loop	3.201	3.3	3.399	V
		TPS610982	MODE = High / Low, $V_{IN} < V_{(PSTH)}$, Burst mode, open loop		3.4		V
			MODE = High / Low, $V_{IN} < V_{(PSTH)}$, PWM mode, open loop	3.201	3.3	3.399	V
		TPS610985	MODE = High / Low, $V_{IN} < V_{(PSTH)}$, Burst mode, open loop		3.1		V
			MODE = High / Low, $V_{IN} < V_{(PSTH)}$, PWM mode, open loop	2.91	3.0	3.09	V
		TPS610986	MODE = High / Low, $V_{IN} < V_{(PSTH)}$, Burst mode, open loop		3.4		V
			MODE = High / Low, $V_{IN} < V_{(PSTH)}$, PWM mode, open loop	3.201	3.3	3.399	V
$V_{(SUB)}$	LDO output voltage (LDO version)	TPS61098/7	MODE = High	3.038	3.1	3.162	V
		TPS610981	MODE = High	2.94	3.0	3.06	V
		TPS610982	MODE = High / Low	2.744	2.8	2.856	V
$V_{(PSTH)}$	Pass-through mode threshold	TPS61098/7	MODE = High, V_{IN} rising		4.4		V
			MODE = High, Hysteresis		0.1		V
			MODE = Low, V_{IN} rising		2.25		V
			MODE = Low, Hysteresis		0.1		V
		TPS610981	MODE = High / Low, V_{IN} rising		3.35		V
			MODE = High / Low, Hysteresis		0.1		V
		TPS610982	MODE = High / Low, V_{IN} rising		3.35		V
			MODE = High / Low, Hysteresis		0.1		V
		TPS610985	MODE = High / Low, V_{IN} rising		3.05		V
			MODE = High / Low, Hysteresis		0.1		V
		TPS610986	MODE = High / Low, V_{IN} rising		3.35		V
			MODE = High / Low, Hysteresis		0.1		V
PSRR	Power-supply rejection ratio from LDO input to output	TPS61098/1/2/7	$f = 1\text{ kHz}$, $C_{O2} = 10\text{ }\mu\text{F}$, $I_{SUB} = 10\text{ mA}$ MODE = High		40		dB
		TPS610982	$f = 1\text{ kHz}$, $C_{O2} = 10\text{ }\mu\text{F}$, $I_{SUB} = 10\text{ mA}$ MODE = Low		28		dB
$t_{\text{stup_LDO}}$	VSUB start-up time (LDO version and load switch version)	TPS61098x	No load time from MODE high to 90% of $V_{(SUB)}$		1		ms
Control Logic							
V_{IL}	MODE input low voltage	TPS61098x				0.4	V
V_{IH}	MODE input high voltage	TPS61098x		1.2			V
	Overtemperature protection	TPS61098x			150		$^{\circ}\text{C}$
	Overtemperature hysteresis	TPS61098x			25		$^{\circ}\text{C}$

 (1) TPS61098x is able to drive $R_{\text{Load}} > 150\text{ }\Omega$ after V_{MAIN} is established over 1.8 V.

7.6 Typical Characteristics

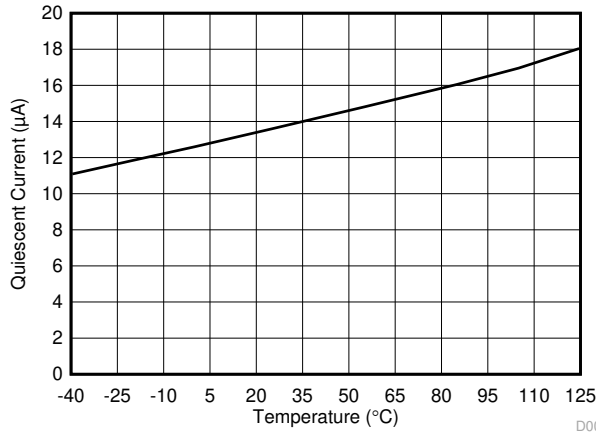

TPS61098, '1, '5, '6 MODE = High

7-1. I_Q into VMAIN Pin at Active Mode vs Temperature

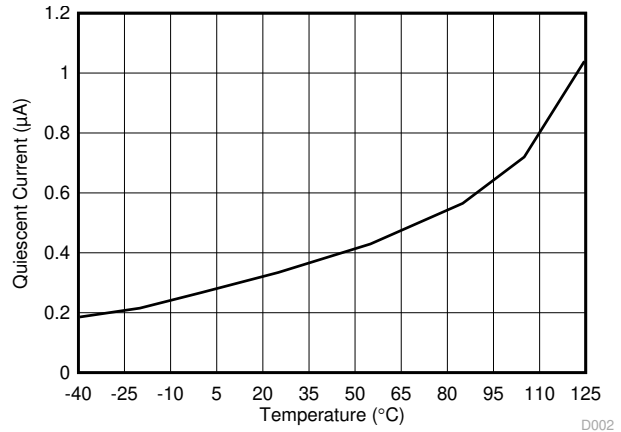

TPS61098, '1, '5, '6 MODE = Low

7-2. I_Q into VMAIN Pin at Low Power Mode vs Temperature

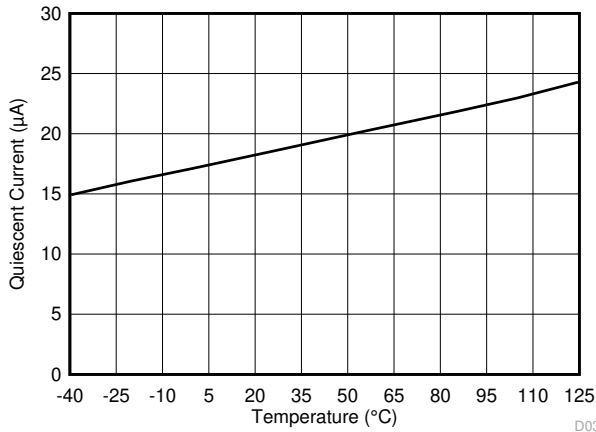

TPS610982 MODE = High

7-3. I_Q into VMAIN Pin at Active Mode vs Temperature

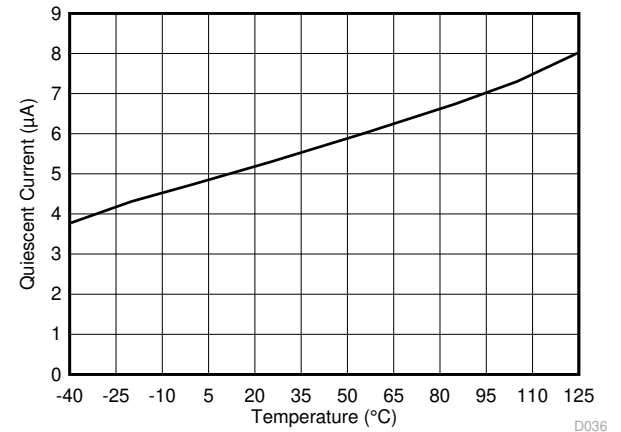

TPS610982 MODE = Low

7-4. I_Q into VMAIN Pin at Low Power Mode vs Temperature

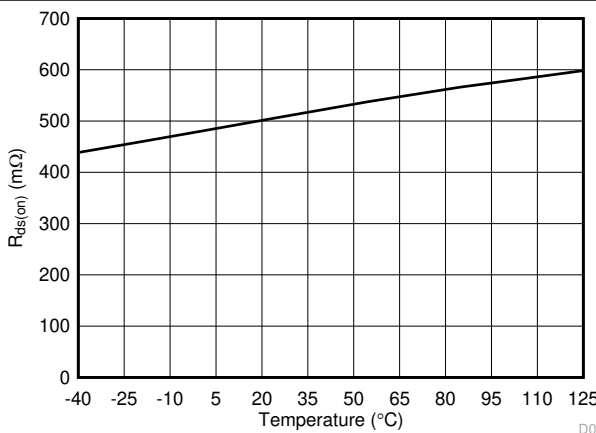

TPS61098, '7 MODE = High

7-5. Rectifier On Resistance vs Temperature

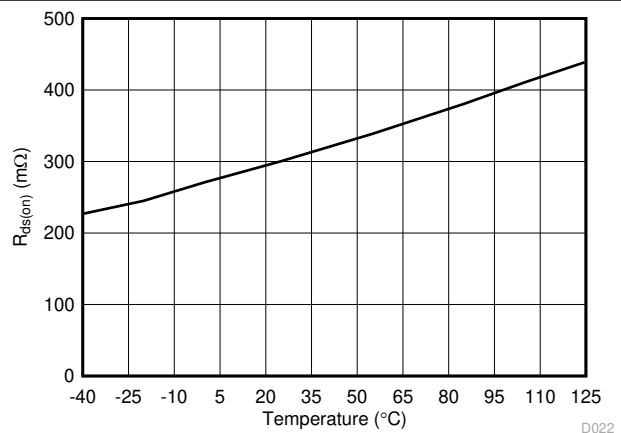

TPS61098, '7 MODE = High

7-6. Low Side Switch On Resistance vs Temperature

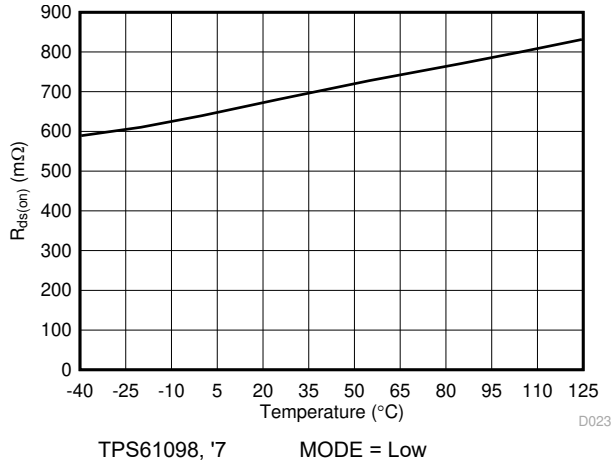

7-7. Rectifier On Resistance vs Temperature

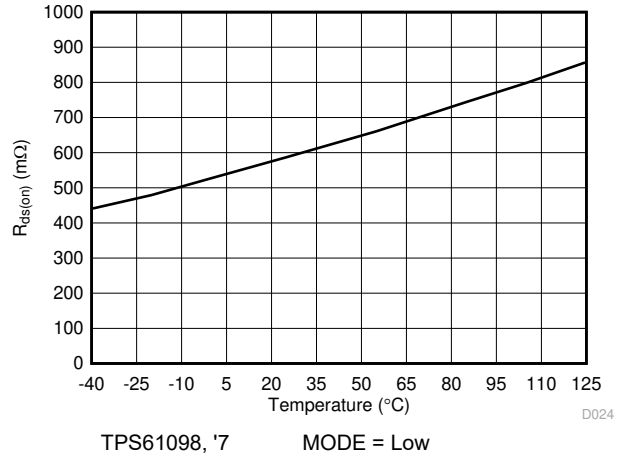

7-8. Low Side Switch On Resistance vs Temperature

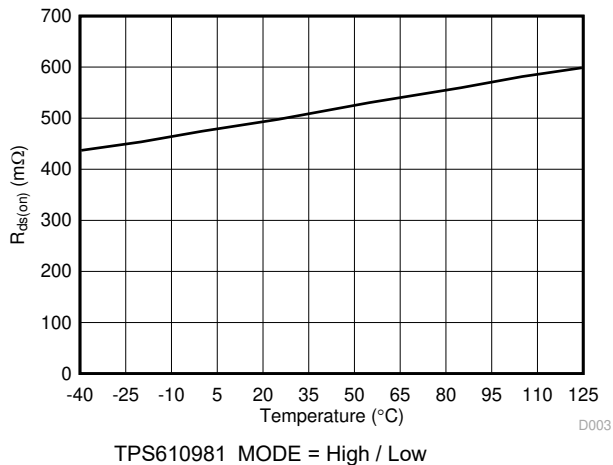

7-9. Rectifier On Resistance vs Temperature

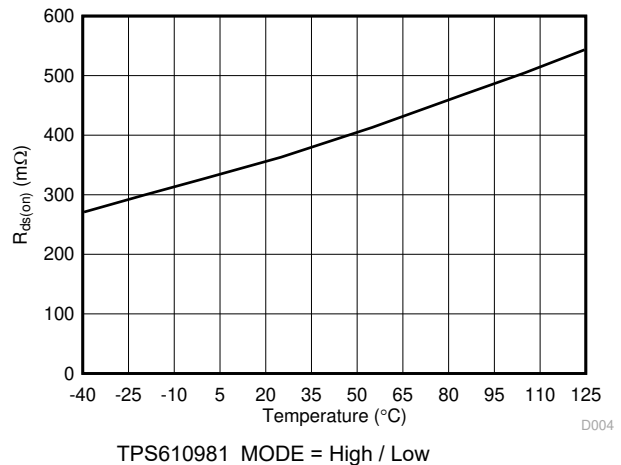

7-10. Low Side Switch On Resistance vs Temperature

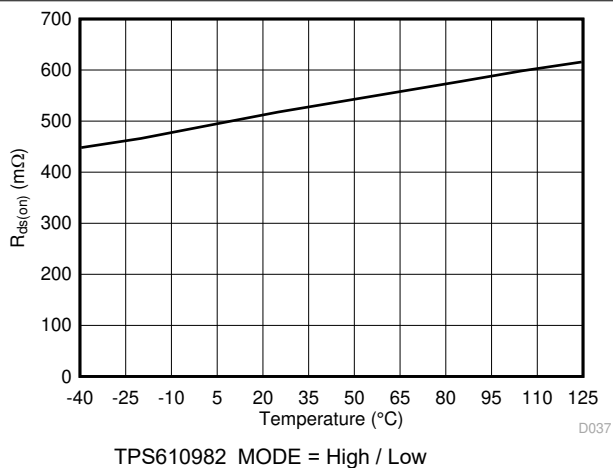

7-11. Rectifier On Resistance vs Temperature

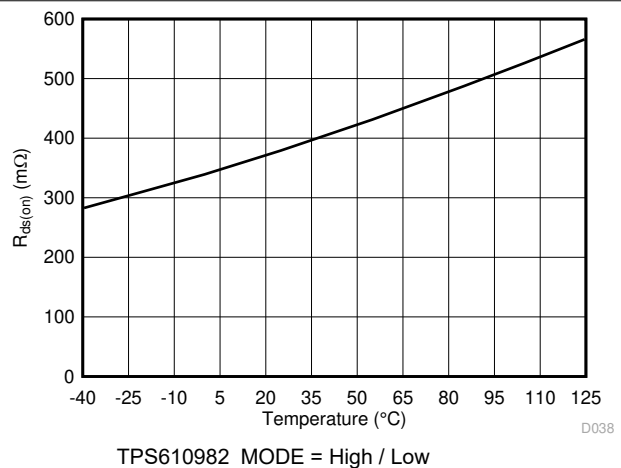

7-12. Low Side Switch On Resistance vs Temperature

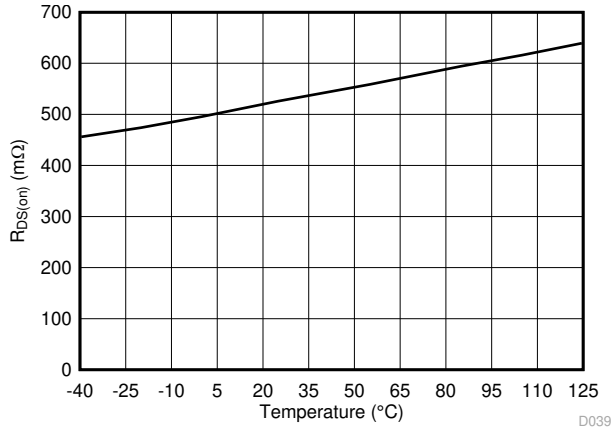

TPS610985 MODE = High / Low

7-13. Rectifier on Resistance vs Temperature

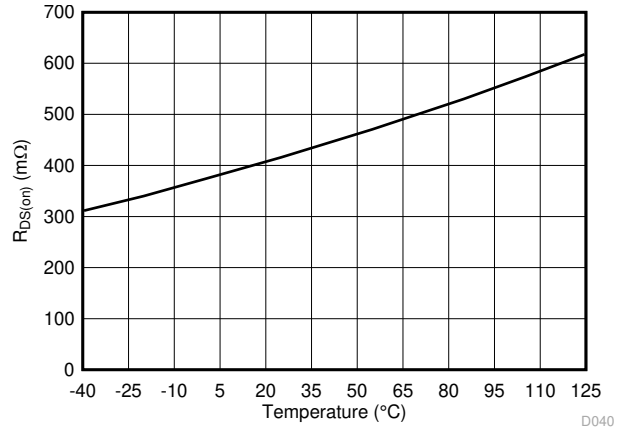

TPS610985 MODE = High / Low

7-14. Low Side Switch On Resistance vs Temperature

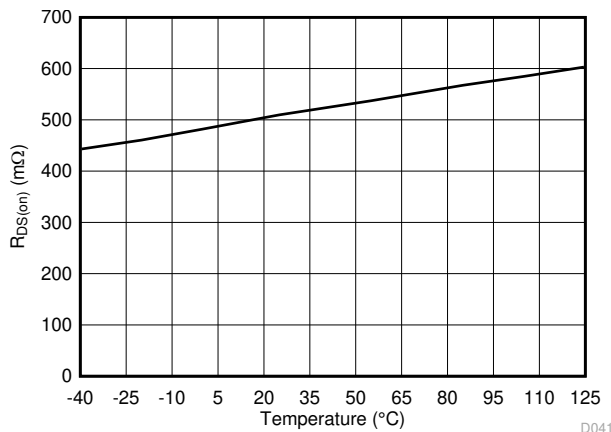

TPS610986 MODE = High / Low

7-15. Rectifier on Resistance vs Temperature

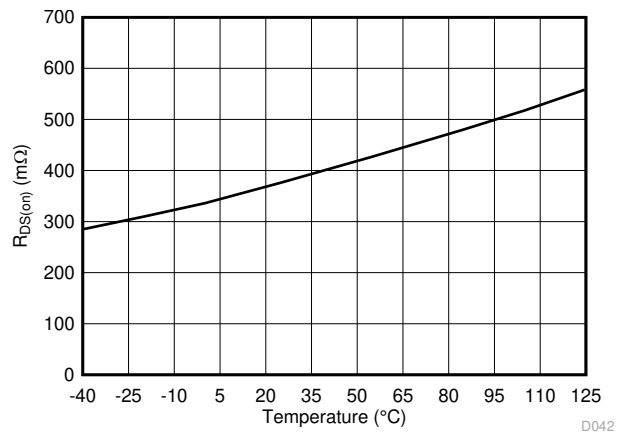

TPS610986 MODE = High / Low

7-16. Low Side Switch on Resistance vs Temperature

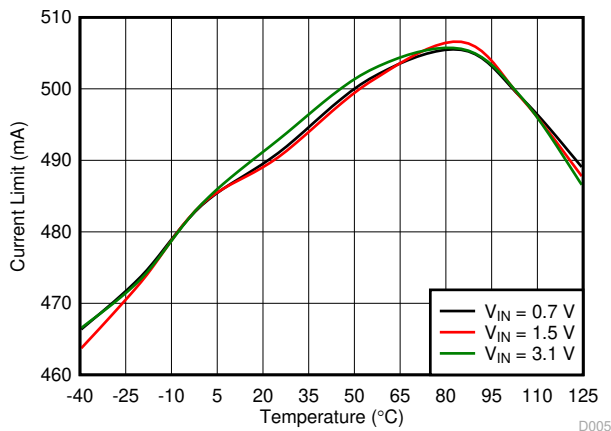

TPS61098x $V_{IN} < V_{(MAIN)}$

7-17. Current Limit vs Temperature

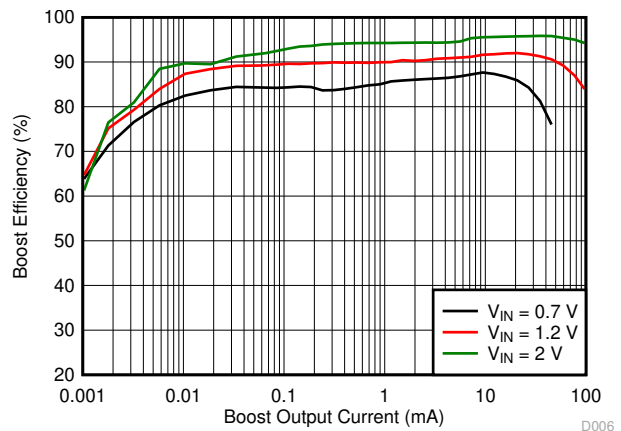

TPS61098, '7 MODE = Low $V_{(MAIN)} = 2.2 V$

7-18. Boost Efficiency vs Output Current (Low Power Mode)

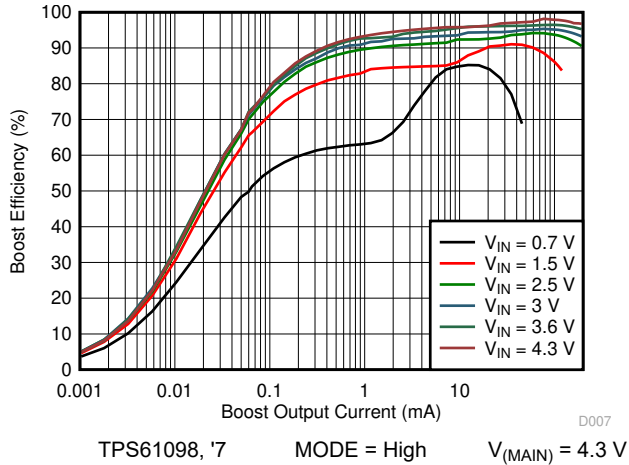

7-19. Boost Efficiency vs Output Current (Active Mode)

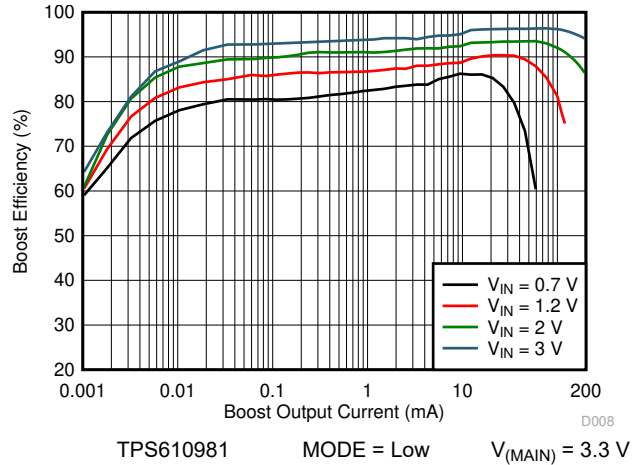

7-20. Boost Efficiency vs Output Current (Low Power Mode)

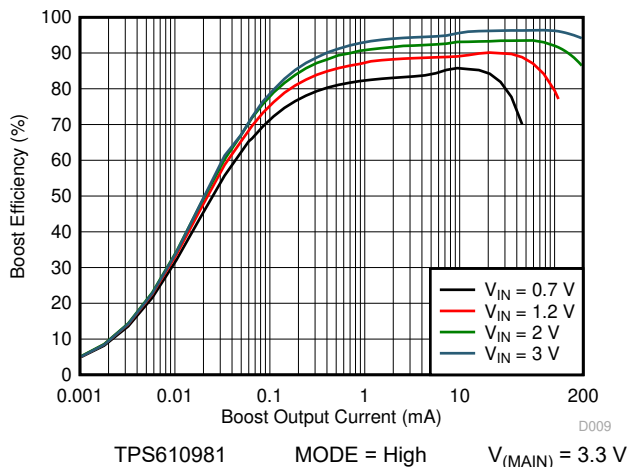

7-21. Boost Efficiency vs Output Current (Active Mode)

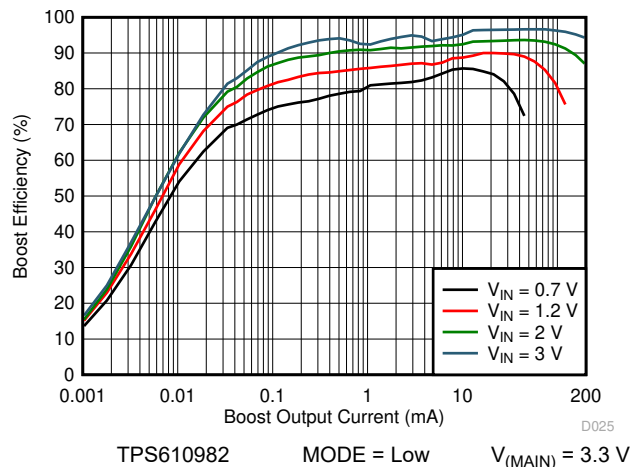

7-22. Boost Efficiency vs Output Current (Low Power Mode)

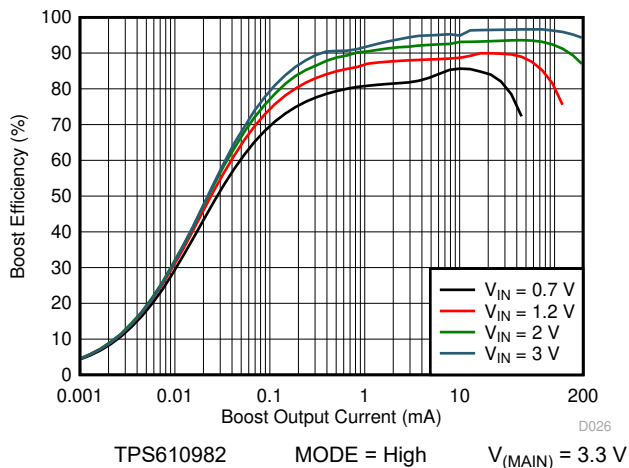

7-23. Boost Efficiency vs Output Current (Active Mode)

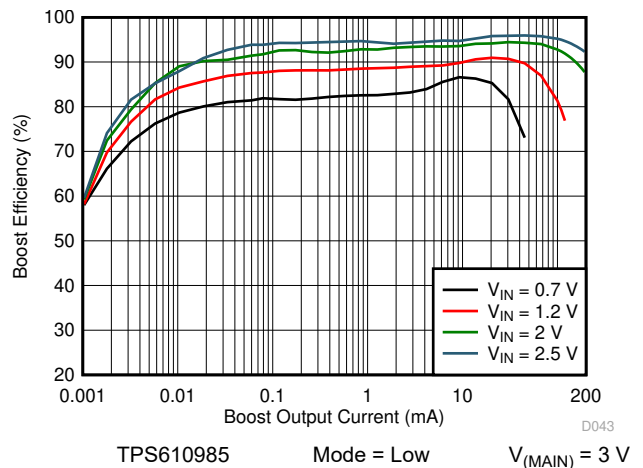

7-24. Boost Efficiency vs Output Current (Low Power Mode)

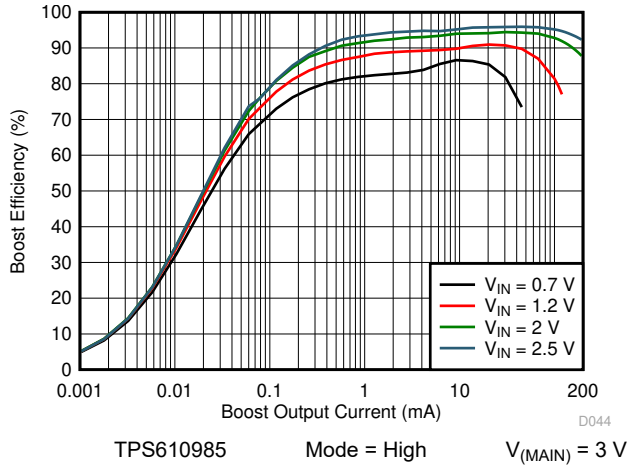

7-25. Boost Efficiency vs Output Current (Active Mode)

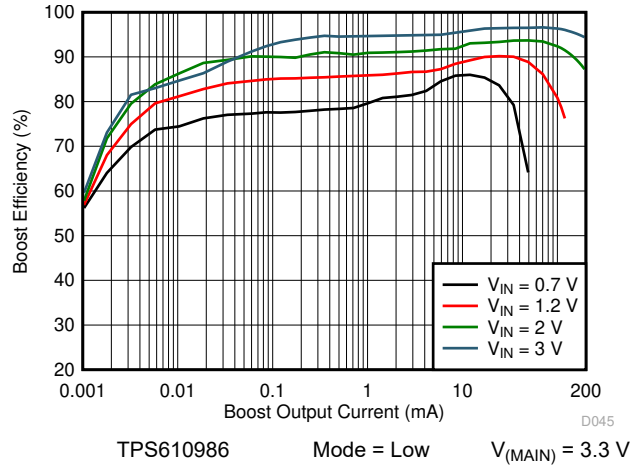

7-26. Boost Efficiency vs Output Current (Low Power Mode)

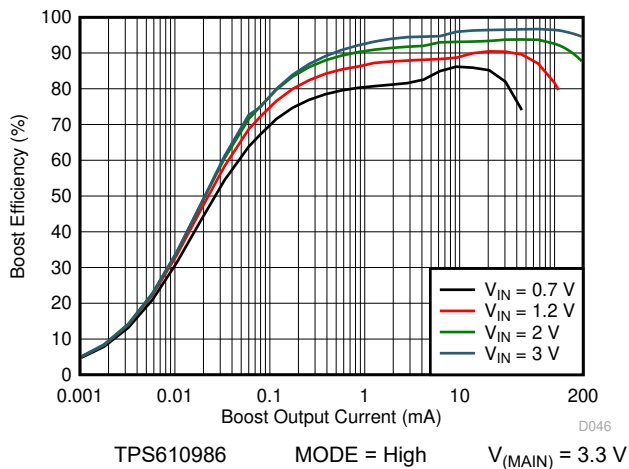

7-27. Boost Efficiency vs Output Current (Active Mode)

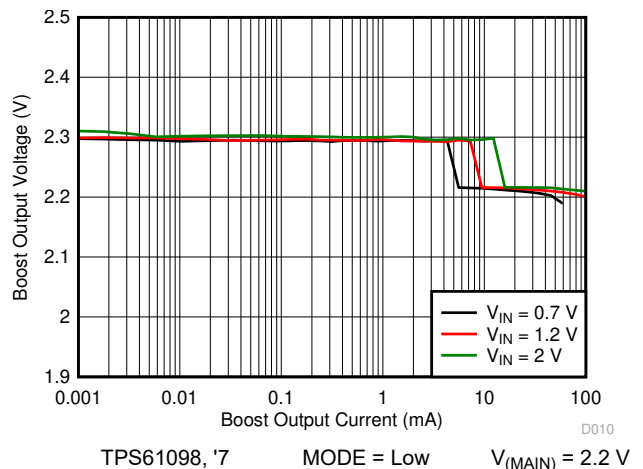

7-28. Boost Load Regulation (Low Power Mode)

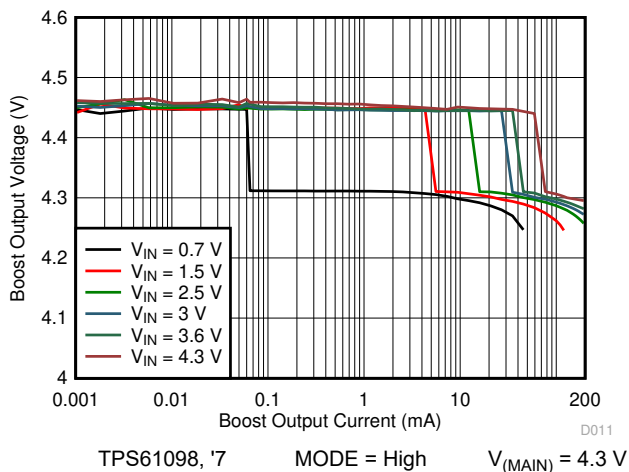

7-29. Boost Load Regulation (Active Mode)

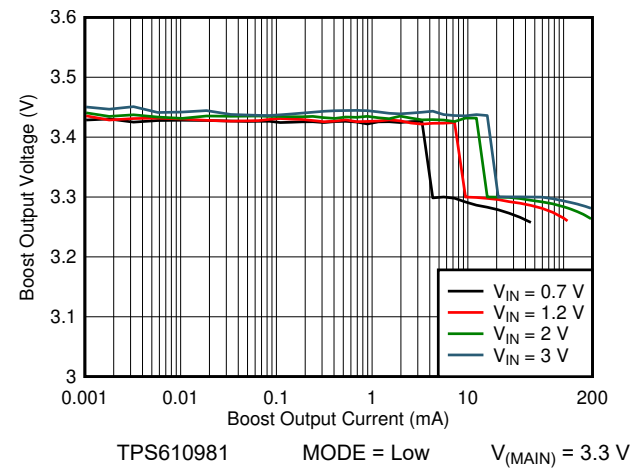

7-30. Boost Load Regulation (Low Power Mode)

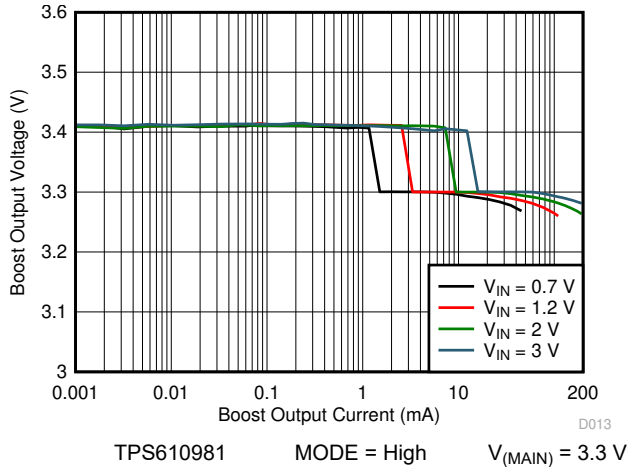

7-31. Boost Load Regulation (Active Mode)

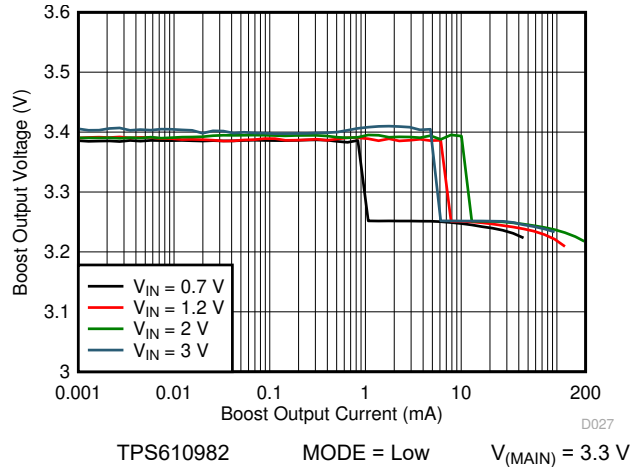

7-32. Boost Load Regulation (Low Power Mode)

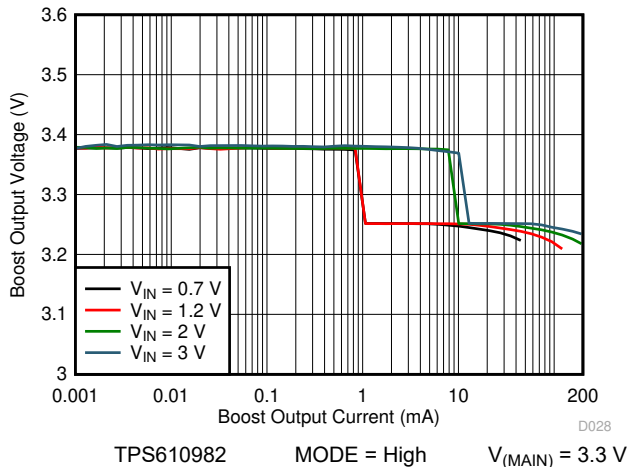

7-33. Boost Load Regulation (Active Mode)

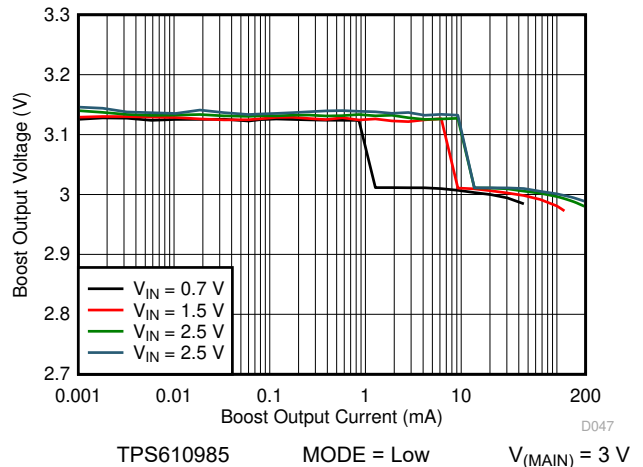

7-34. Boost Load Regulation (Low Power Mode)

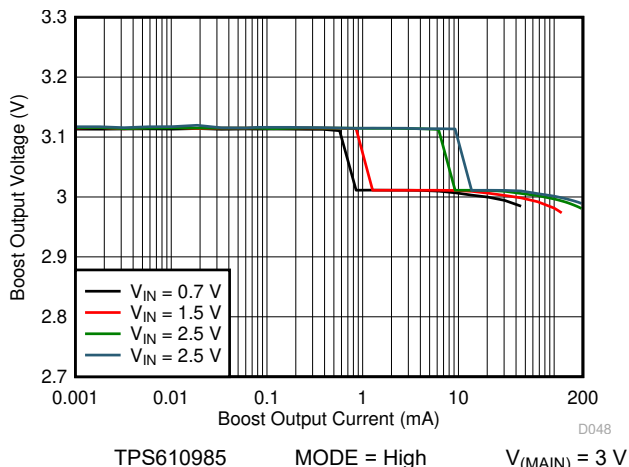

7-35. Boost Load Regulation (Active Mode)

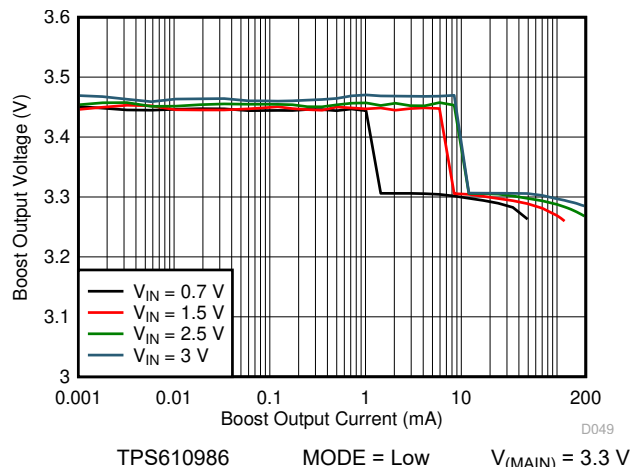

7-36. Boost Load Regulation (Low Power Mode)

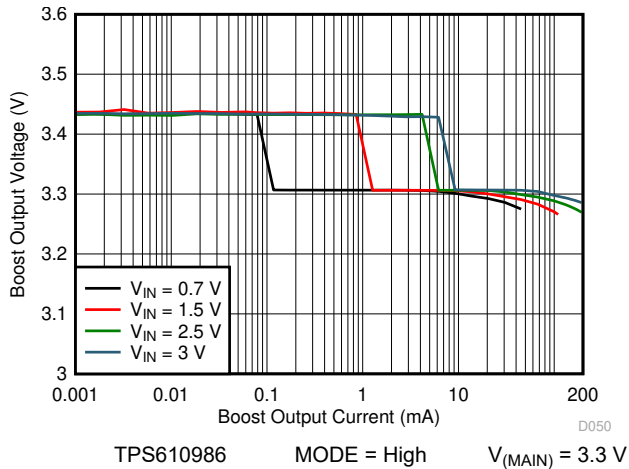

7-37. Boost Load Regulation (Active Mode)

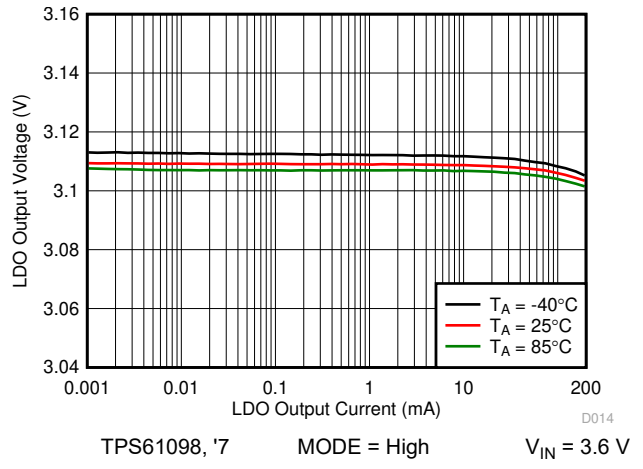

7-38. LDO Load Regulation

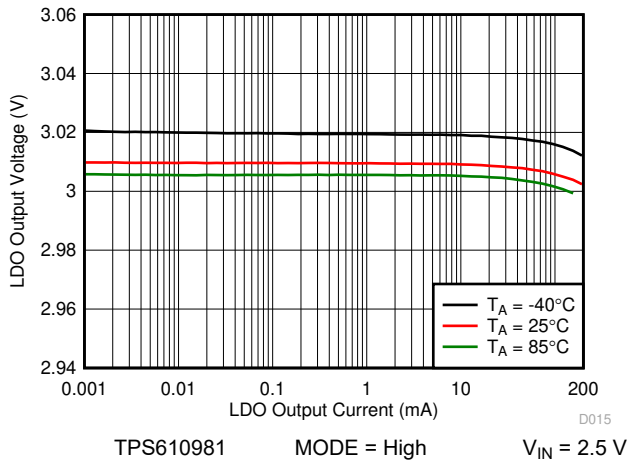

7-39. LDO Load Regulation

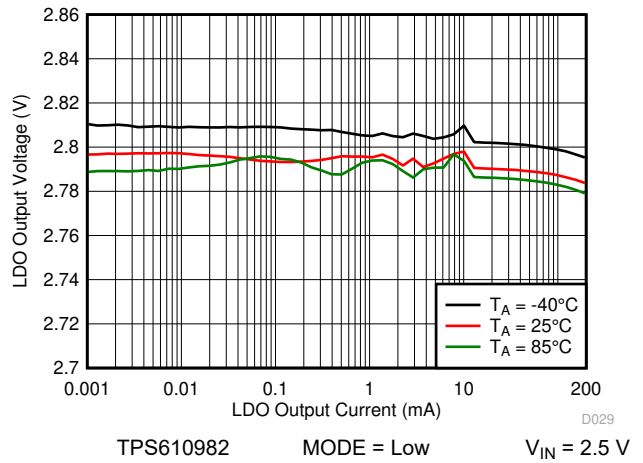

7-40. LDO Load Regulation (Low Power Mode)

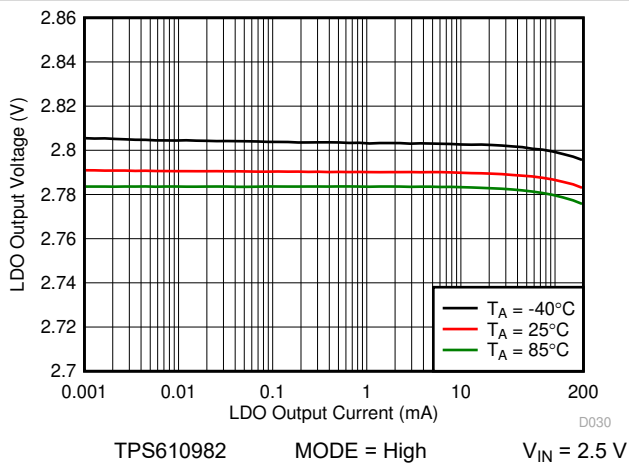

7-41. LDO Load Regulation (Active Mode)

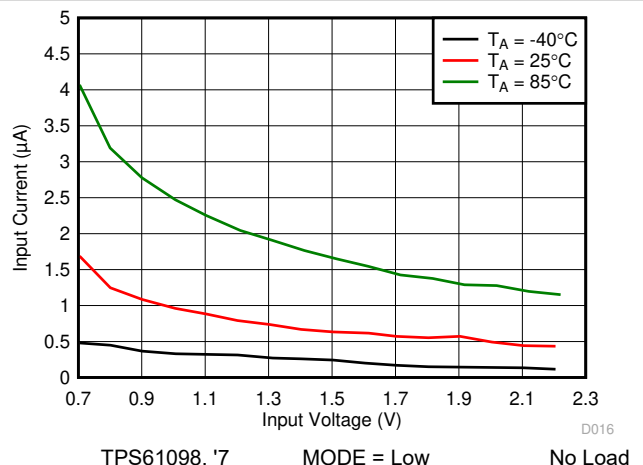

7-42. Input Current vs Input Voltage (Low Power Mode)

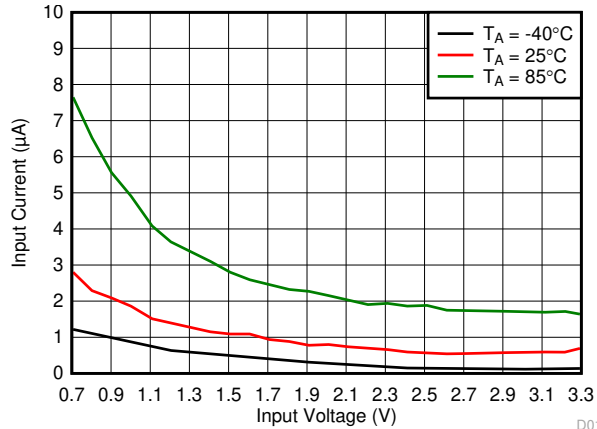

TPS610981 MODE = Low No Load

7-43. Input Current vs Input Voltage (Low Power Mode)

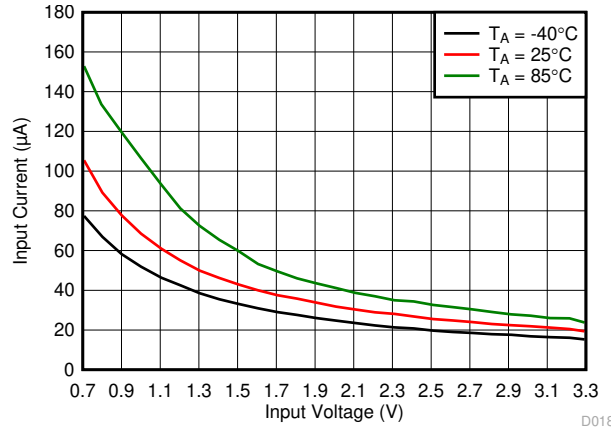

TPS610981 MODE = High No Load

7-44. Input Current vs Input Voltage (Active Mode)

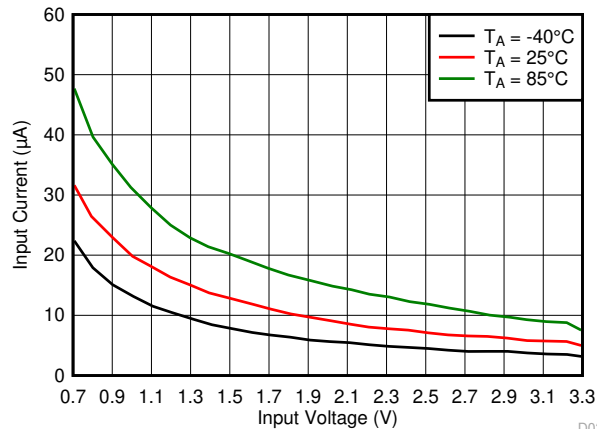

TPS610982 MODE = Low No Load

7-45. No Load Input Current vs Input Voltage (Low Power Mode)

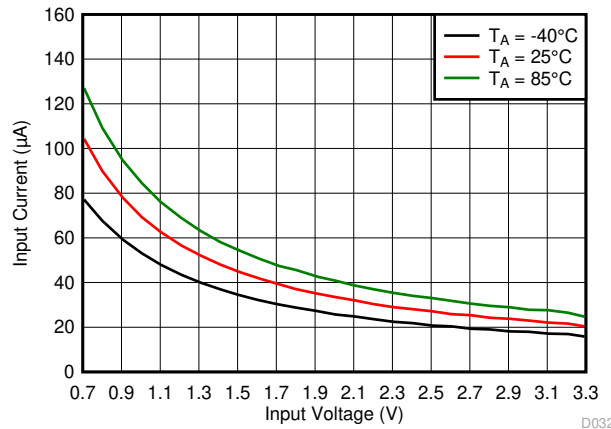

TPS610982 MODE = High No Load

7-46. No Load Input Current vs Input Voltage (Active Mode)

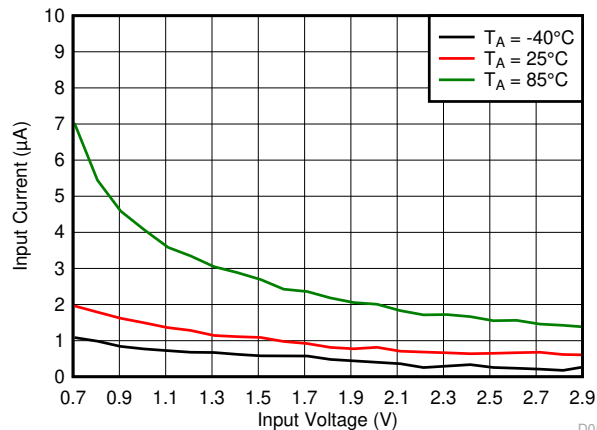

TPS610985 MODE = Low $V_{(MAIN)} = 3\text{ V}$

7-47. Input Current vs Input Voltage (Low Power Mode)

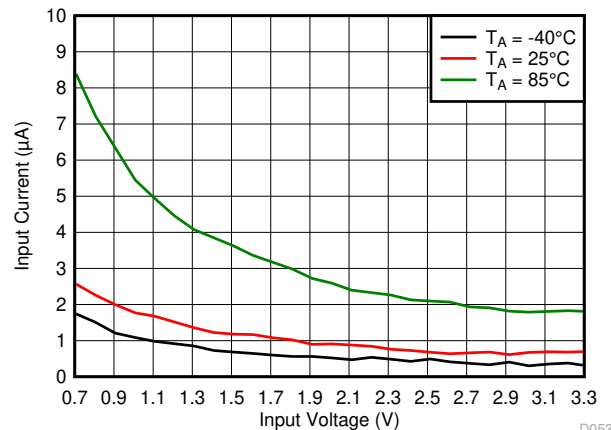

TPS610986 MODE = Low $V_{(MAIN)} = 3.3\text{ V}$

7-48. Input Current vs Input Voltage (Low Power Mode)

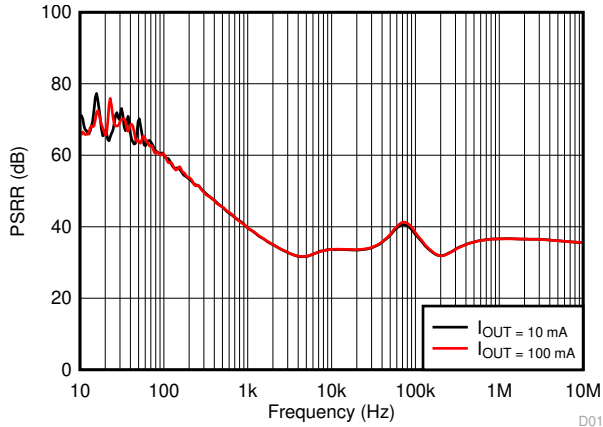

TPS61098.7 MODE = High $C_{O2} = 10 \mu\text{F}$
 $V_{IN} - V_{OUT} = 4.3 \text{ V} - 3.1 \text{ V} = 1.2 \text{ V}$

 **7-49. LDO PSRR vs Frequency**

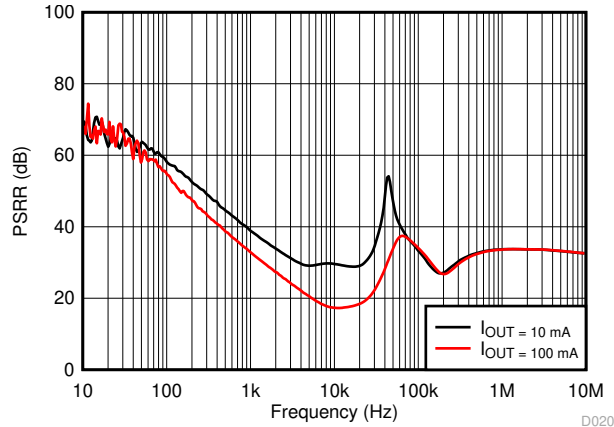

TPS610981 MODE = High $C_{O2} = 10 \mu\text{F}$
 $V_{IN} - V_{OUT} = 3.3 \text{ V} - 3 \text{ V} = 0.3 \text{ V}$

 **7-50. LDO PSRR vs Frequency**

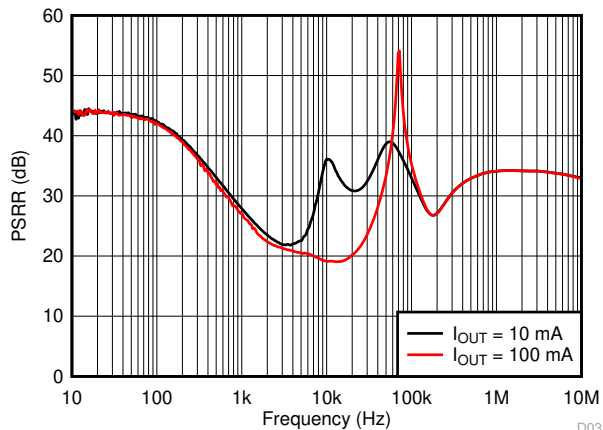

TPS610982 MODE = Low $C_{O2} = 10 \mu\text{F}$
 $V_{IN} - V_{OUT} = 3.3 \text{ V} - 2.8 \text{ V} = 0.5 \text{ V}$

 **7-51. LDO PSRR vs Frequency (Low Power Mode)**

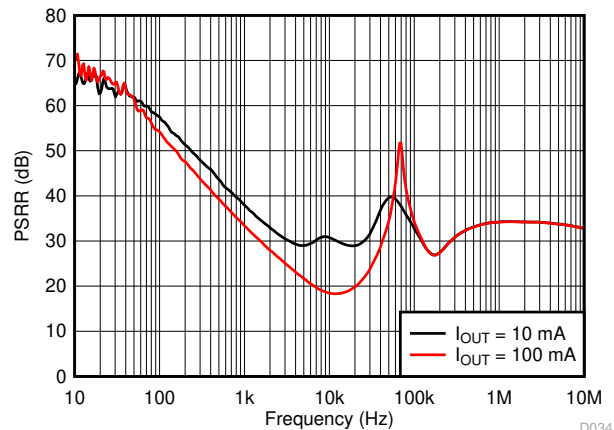

TPS610982 MODE = High $C_{O2} = 10 \mu\text{F}$
 $V_{IN} - V_{OUT} = 3.3 \text{ V} - 2.8 \text{ V} = 0.5 \text{ V}$

 **7-52. LDO PSRR vs Frequency (Active Mode)**

8 Detailed Description

8.1 Overview

The TPS61098x is an ultra-low power solution optimized for products powered by either a one-cell or two-cell alkaline, NiCd or NiMH, one-cell coin cell battery or one-cell Li-Ion or Li-polymer battery. To simplify system design and save PCB space, the TPS61098x integrates an LDO or load switch with a boost converter (different configurations for different versions) to provide two output rails in a compact package. The boost output $V_{(MAIN)}$ is designed as an always-on supply to power a main system, and the LDO or load switch output $V_{(SUB)}$ is designed to power peripheral devices and can be turned off.

The TPS61098x features two modes controlled by MODE pin: Active mode and Low Power mode. In Active mode, both outputs are enabled, and the transient response performance of the boost converter and LDO/load switch are enhanced, so it is able to respond load transient quickly. In Low Power mode, the LDO/load switch is disabled, so the peripherals can be disconnected to minimize the battery drain. Besides that, the boost consumes only 300 nA quiescent current in Low Power mode, so up to 88% efficiency at 10 μ A load can be achieved to extend the battery run time. The TPS610982 is an exception. Its LDO is always on in both Active mode and Low Power mode. The main differences between the two modes of the TPS610982 are the quiescent current and performance. Refer to [セクション 8.4.1](#) for details.

The TPS61098x supports automatic pass-through function in both Active mode and Low Power mode. When V_{IN} is detected higher than a pass-through threshold, which is around the target $V_{(MAIN)}$ voltage, the boost converter stops switching and passes the input voltage through inductor and internal rectifier switch to $V_{(MAIN)}$, so $V_{(MAIN)}$ follows V_{IN} ; when V_{IN} is lower than the threshold, the boost works in boost mode and regulates $V_{(MAIN)}$ at the target value. The TPS61098x can support different $V_{(MAIN)}$ target values in Active mode and Low Power mode to meet various requirements. For example, for TPS61098, the set value of $V_{(MAIN)}$ is 4.3 V in Active mode but 2.2 V in Low Power mode.

8.2 Functional Block Diagrams

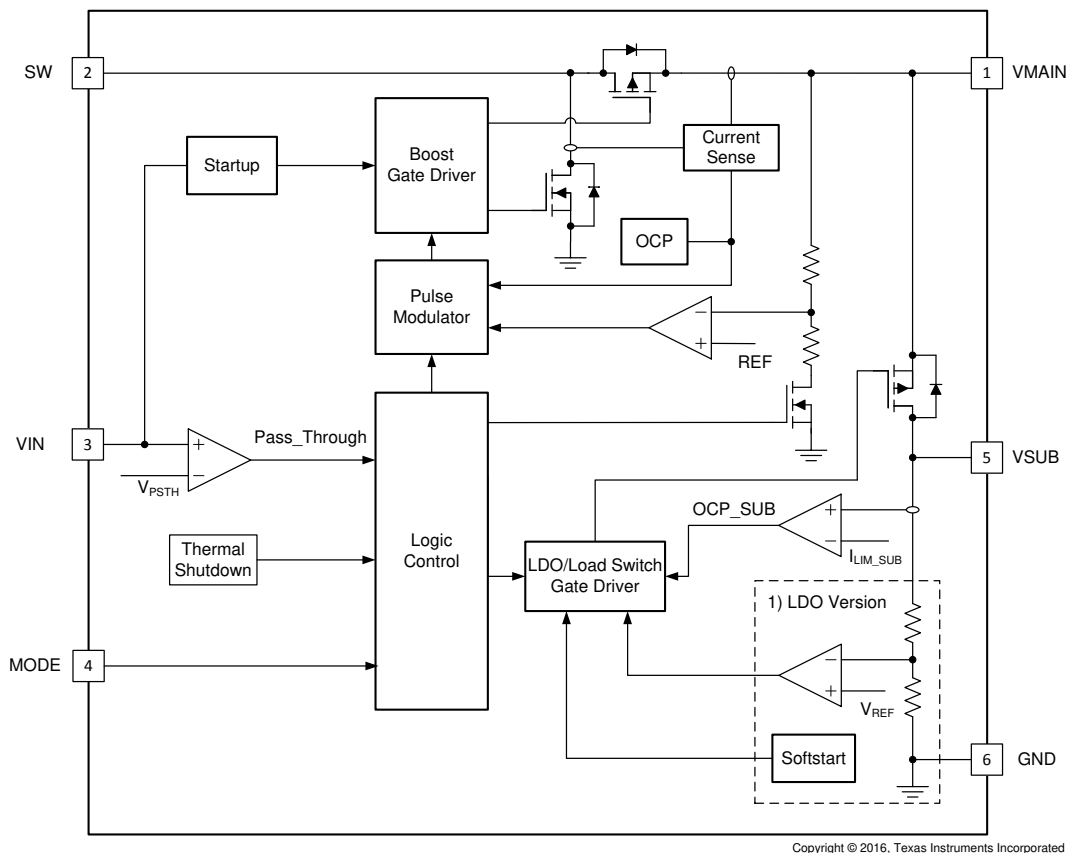

A. Implemented in versions with LDO configuration.

8.3 Feature Description

8.3.1 Boost Controller Operation

The TPS61098x boost converter is controlled by a hysteretic current mode controller. This controller regulates the output voltage by keeping the inductor ripple current constant in the range of 100 mA and adjusting the offset of this inductor current depending on the output load. Since the input voltage, output voltage and inductor value all affect the rising and falling slopes of inductor ripple current, the switching frequency is not fixed and is decided by the operation condition. If the required average input current is lower than the average inductor current defined by this constant ripple, the inductor current goes discontinuous to keep the efficiency high under light load conditions. [Figure 8-1](#) illustrates the hysteretic current operation. If the load is reduced further, the boost converter enters into Burst mode. In Burst mode, the boost converter ramps up the output voltage with several pulses and it stops operating once the output voltage exceeds a set threshold, and then it goes into a sleep status and consumes less quiescent current. It resumes switching when the output voltage is below the set threshold. It exits the Burst mode when the output current can no longer be supported in this mode. Refer to [Figure 8-2](#) for Burst mode operation details.

To achieve high efficiency, the power stage is realized as a synchronous boost topology. The output voltage $V_{(MAIN)}$ is monitored via an internal feedback network which is connected to the voltage error amplifier. To regulate the output voltage, the voltage error amplifier compares this feedback voltage to the internal voltage reference and adjusts the required offset of the inductor current accordingly.

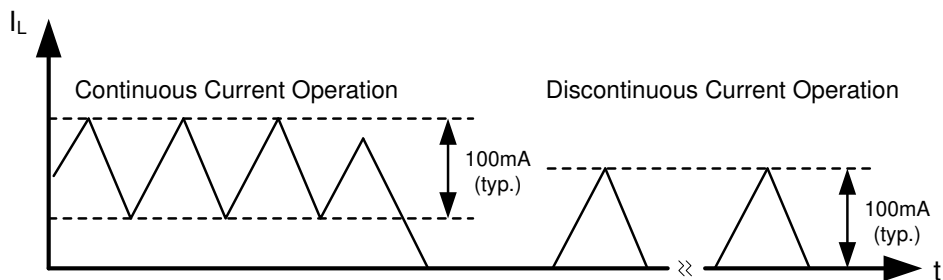

Figure 8-1. Hysteretic Current Operation

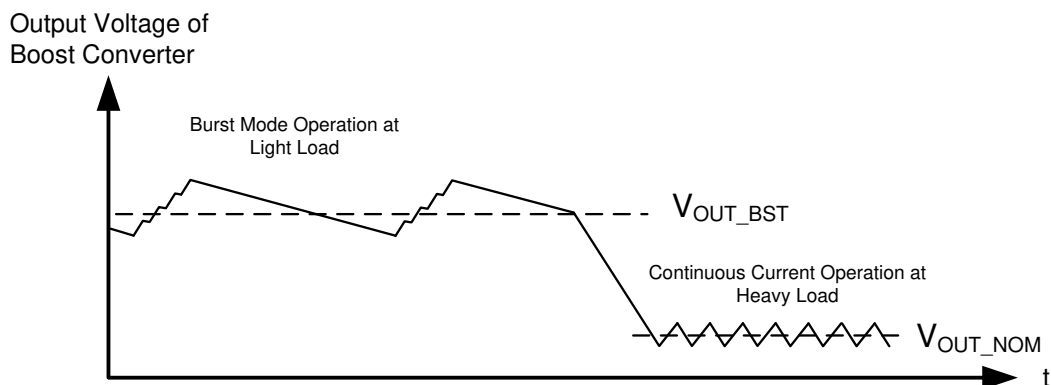

Figure 8-2. Burst Mode Operation

8.3.2 Pass-Through Operation

The TPS61098x supports automatic pass-through function for the boost converter. When the input voltage is detected higher than the pass-through threshold $V_{(PSTH)}$, which is around $V_{(MAIN)}$ set value, the boost converter enters into pass-through operation mode. In this mode, the boost converter stops switching, the rectifier is constantly turned on and the low side switch is turned off. The input voltage passes through external inductor and the internal rectifier to the output. The output voltage in this mode depends on the resistance between the input and the output, calculated as [Equation 1](#):

$$V_{\text{MAIN}} = V_{\text{IN}} - (I_{\text{MAIN}} + I_{\text{SUB}}) \times (R_{\text{L}} + R_{\text{DS(on)_HS}}) \quad (1)$$

where

- R_{L} is the DCR of external inductor
- $R_{\text{DS(on)_HS}}$ is the resistance of internal rectifier

When the input voltage is lower than $V_{(\text{PSTH})}$, the boost converter resumes switching to regulate the output at target value.

The TPS61098x can support automatic pass-through function in both Active mode and Low Power mode.

8.3.3 LDO / Load Switch Operation

The TPS61098x uses a PMOS as a pass element of its integrated LDO / load switch. The input of the PMOS is connected to the output of the boost converter. When the MODE pin is pulled logic high, the PMOS is enabled to output a voltage on VSUB pin.

For load switch version, the PMOS pass element is fully turned on when enabled, no matter the boost converter works in boost operation mode or pass-through operation mode. So the output voltage at VSUB pin is decided by the output voltage at VMAIN pin and the current passing through the PMOS as 式 2:

$$V_{\text{SUB}} = V_{\text{MAIN}} - I_{\text{SUB}} \times R_{\text{LS}} \quad (2)$$

where

- $I_{(\text{SUB})}$ is the load of VSUB rail
- R_{LS} is the resistance of the PMOS when it is fully turned on

For LDO version, the output voltage $V_{(\text{SUB})}$ is regulated at the set value when the voltage difference between its input and output is higher than the dropout voltage $V_{(\text{Dropout})}$, no matter the boost converter works in boost operation mode or pass-through operation mode. The $V_{(\text{SUB})}$ is monitored via an internal feedback network which is connected to the voltage error amplifier. To regulate $V_{(\text{SUB})}$, the voltage error amplifier compares the feedback voltage to the internal voltage reference and adjusts the gate voltage of the PMOS accordingly. When the voltage drop across the PMOS is lower than the dropout voltage, the PMOS will be fully turned on and the output voltage at $V_{(\text{SUB})}$ is decided by 式 2.

When the MODE pin is pulled low, the LDO or load switch is turned off to disconnect the load at VSUB pin. For some versions, active discharge function at VSUB pin is offered, which can discharge the $V_{(\text{SUB})}$ to ground after MODE pin is pulled low, to avoid any bias condition to downstream devices. For versions without the active discharge function, the VSUB pin is floating after MODE pin is pulled low, and its voltage normally drops down slowly due to leakage. Refer to the [セクション 5](#) for version differences.

When MODE pin is toggled from low to high, soft-start is implemented for the LDO versions to avoid inrush current during LDO startup. The start up time of LDO is typically 1 ms. For load switch versions, the load switch is turned on faster, so the output capacitor at VSUB pin is suggested 10X smaller than the output capacitor at VMAIN pin to avoid obvious voltage drop of $V_{(\text{MAIN})}$ during load switch turning on process.

8.3.4 Start Up and Power Down

The boost converter of the TPS61098x is designed always-on, so there is no enable or disable control of it. The boost converter starts operation once input voltage is applied. If the input voltage is not high enough, a low voltage startup oscillator operates the switches first. During this phase, the switching frequency is controlled by the oscillator, and the maximum switch current is limited. Once the converter has built up the output voltage $V_{(\text{MAIN})}$ to approximately 1.8 V, the device switches to the normal hysteretic current mode operation and the VMAIN rail starts to supply the internal control circuit. If the input voltage is too low or the load during startup is too heavy, which makes the converter unable to build up 1.8 V at $V_{(\text{MAIN})}$ rail, the boost converter can't start up successfully. It will keep in this status until the input voltage is increased or removed.

The TPS61098x is able to startup with 0.7 V input voltage with $\geq 3 \text{ k}\Omega$ load. The startup time depends on input voltage and load conditions. After the $V_{(\text{MAIN})}$ reaches 1.8 V to start the normal hysteretic current mode

operation, an internal ramp-up reference controls soft-start time of the boost converter until $V_{(MAIN)}$ reaches its set value.

The TPS61098x does not support undervoltage lockout function. When the input voltage drops to a low voltage and can't provide the required energy to the boost converter, the $V_{(MAIN)}$ drops. When and to what extent $V_{(MAIN)}$ drops are dependent on the input and load conditions. When the boost converter is unable to maintain 1.8 V at VMAIN rail to supply the internal circuit, the TPS61098x powers down and enters into startup process again.

8.3.5 Over Load Protection

The boost converter of the TPS61098x supports a cycle-by-cycle current limit function in boost mode operation. If the peak inductor current reaches the internal switch current limit threshold, the main switch is turned off to stop a further increase of the input current. In this case the output voltage will decrease since the device cannot provide sufficient power to maintain the set output voltage. If the output voltage drops below the input voltage, the backgate diode of the rectifying switch gets forward biased and current starts to flow through it. Because this diode cannot be turned off, the load current is only limited by the remaining DC resistance. After the overload condition is removed, the converter automatically resumes normal operation.

The overload protection is not active in pass-through mode operation, in which the load current is only limited by the DC resistance.

The integrated LDO / load switch also supports over load protection. When the load current of VSUB rail reaches the I_{LIM_SUB} , the $V_{(SUB)}$ output current will be regulated at this limit value and will not increase further. In this case the $V_{(SUB)}$ voltage will decrease since the device cannot provide sufficient power to the load.

8.3.6 Thermal Shutdown

The TPS61098x has a built-in temperature sensor which monitors the internal junction temperature in boost mode operation. If the junction temperature exceeds the threshold (150°C typical), the device stops operating. As soon as the junction temperature has decreased below the programmed threshold with a hysteresis, it starts operating again. There is a built-in hysteresis (25°C typical) to avoid unstable operation at the overtemperature threshold. The over temperature protection is not active in pass-through mode operation.

8.4 Device Functional Modes

8.4.1 Operation Modes by MODE Pin

The TPS61098x features two operation modes controlled by MODE pin: the Active mode and Low Power mode. It can provide quick transient response in Active mode and ultra-low quiescent current in Low Power mode. So a low power system can easily use the TPS61098x to get high performance in its active mode and meantime minimize its power consumption to extend the battery run time in its sleep mode.

The MODE pin is usually controlled by an I/O pin of a controller, and should not be left floating.

8.4.1.1 Active Mode

The TPS61098x works in Active mode when MODE pin is logic high. In Active mode, both of the boost converter and the integrated LDO/load switch are enabled, and the TPS61098x can provide dual outputs simultaneously. The transient response performance of the boost converter is enhanced in Active mode, and the device consumes around 15 μ A quiescent current. It is able to respond load transient quickly.

When MODE pin is toggled from low to high, soft-start is implemented for the LDO versions to avoid inrush current during startup. For load switch versions, the load switch is turned on faster, so the output capacitor at VSUB pin is suggested 10X smaller than the output capacitor at VMAIN pin to avoid obvious voltage drop of $V_{(MAIN)}$ during turning on process.

8.4.1.2 Low Power Mode

The TPS61098x works in Low Power mode when MODE pin is logic low. In Low Power mode, the LDO/load switch is turned off, so the peripherals can be disconnected to minimize the battery drain. The VSUB pin either outputs high impedance or is pulled to ground by internal active discharge circuit, depending on different versions. The boost converter consumes only 300 nA quiescent current typically, and can achieve up to 88% efficiency at 10 μ A load.

The Low Power mode is designed to keep the load device powered with minimum power consumption. For example, it can be used to keep powering the main system, like an MCU, in a system's sleep mode even under < 0.7 V input voltage condition.

☒ 8-3 and ☒ 8-4 illustrate the outputs of the TPS61098 and TPS610981 under different input voltages in Active mode and Low Power mode.

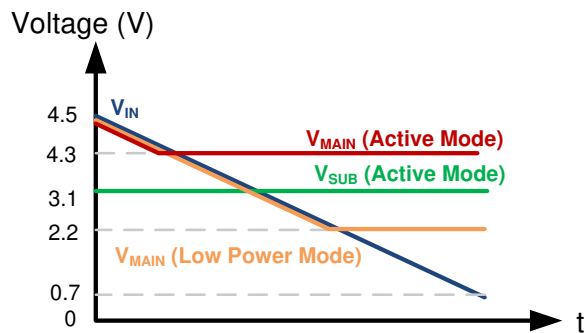

☒ 8-3. TPS61098 Output under Different Input Voltages

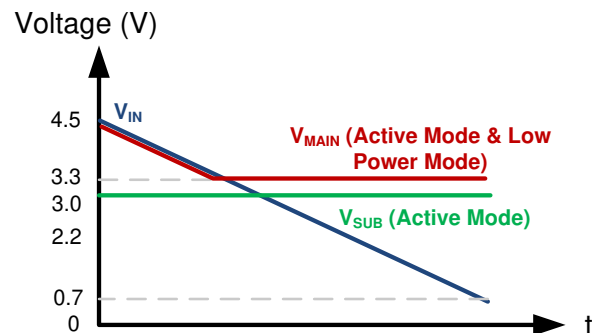

☒ 8-4. TPS610981 Output under Different Input Voltages

The TPS610982 is an exception. Its LDO is always on in both Active mode and Low Power mode with higher quiescent current consumption than other versions. The TPS610982 can be used to replace discrete boost and LDO solutions where the LDO output is always on, and its two modes provide users two options of different quiescent current consumption and performance. Refer to [セクション 8.4.1](#), [セクション 7](#) and [セクション 7.6](#) for details.

8.4.2 Burst Mode Operation under Light Load Condition

The boost converter of TPS61098x enters into Burst Mode operation under light load condition. Refer to [セクション 8.3.1](#) for details.

8.4.3 Pass-Through Mode Operation

The boost converter of TPS61098x automatically enters into pass-through mode operation when input voltage is higher than the target output voltage. Refer to [セクション 8.3.2](#) for details.

9 Applications and Implementation

Note

以下のアプリケーション情報は、TI の製品仕様に含まれるものではなく、TI ではその正確性または完全性を保証いたしません。個々の目的に対する製品の適合性については、お客様の責任で判断していただくこととなります。お客様は自身の設計実装を検証しテストすることで、システムの機能を確認する必要があります。

9.1 Application Information

The TPS61098x is an ultra low power solution for products powered by either a one-cell or two-cell alkaline, NiCd or NiMH, one-cell coin cell or one-cell Li-Ion or Li-polymer battery. It integrates either a Low-dropout Linear Regulator (LDO) or a load switch with a boost converter and provides dual output rails. The $V_{(MAIN)}$ rail is the output of the boost converter. It is an always-on output and can only be turned off by removing input voltage. The $V_{(SUB)}$ rail is the output of the integrated LDO or load switch, and it can be turned off by pulling the MODE pin low.

9.2 Typical Applications

9.2.1 VMAIN to Power MCU and VSUB to Power Subsystem

The TPS61098x suits for low power systems very well, especially for the system which spends the most of time in sleep mode and wakes up periodically to sense or transmit signals. For this kind of application, the boost output $V_{(MAIN)}$ can be used as an always-on supply for the main system, such as an MCU controller, and the LDO or load switch output $V_{(SUB)}$ is used to power peripheral devices or subsystem.

As shown in [Figure 9-1](#), the MCU can control both of the subsystem and the TPS61098x. When the system goes into sleep mode, the MCU can disable the subsystem first, and then force the TPS61098x enter into Low Power mode, where the $V_{(SUB)}$ rail is disconnected but the $V_{(MAIN)}$ rail still powers the MCU with only 300 nA quiescent current. When the system wakes up, the MCU pulls the MODE pin of TPS61098x high first to turn on the $V_{(SUB)}$ rail, and then enables the subsystem. In this way, the system can benefit both of the enhanced transient response performance in active mode and the ultra-low quiescent current in sleep mode.

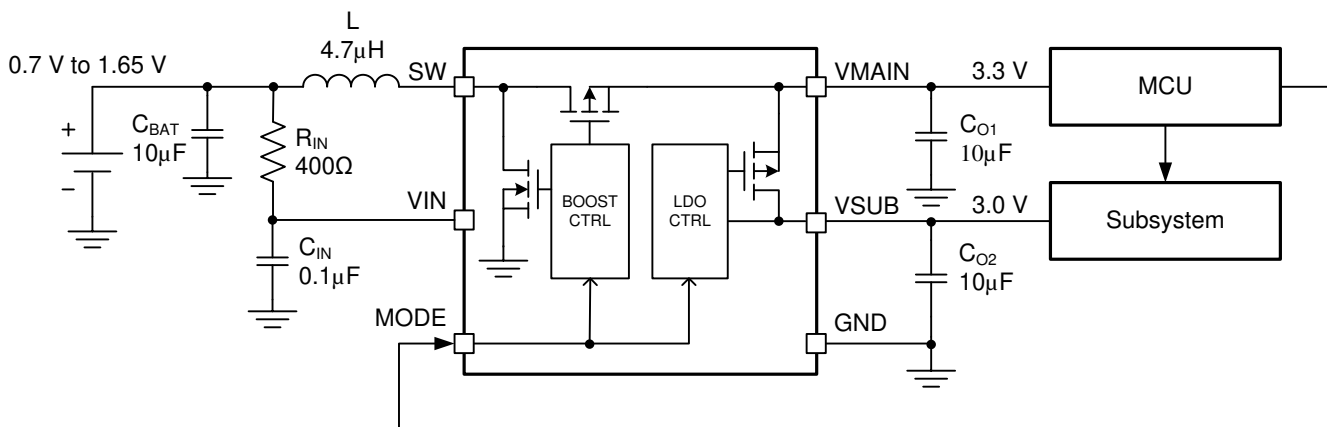

Copyright © 2016, Texas Instruments Incorporated

Figure 9-1. Typical Application of TPS610981 to Power Low Power System

9.2.1.1 Design Requirements

- 3.3 V $V_{(MAIN)}$ rail to power MCU with 15 mA load current, 3 V $V_{(SUB)}$ rail to power subsystem with 10 mA load current
- Power source, single-cell alkaline battery (0.7 V to 1.65 V range)
- Greater than 90% conversion efficiency

9.2.1.2 Detailed Design Procedure

9.2.1.2.1 Device Choice

In the TPS61098x family, different versions are provided. Refer to [セクション 5](#) for version details and select the right version for target applications. It is OK to use only one output rail, either $V_{(MAIN)}$ or $V_{(BUS)}$, as long as it suits the application.

In this example, dual rails of 3.3 V and 3 V are required to power both MCU and subsystem, so the TPS610981 is selected.

9.2.1.2.2 Maximum Output Current

For the boost converter, it provides output current for both $V_{(MAIN)}$ and $V_{(SUB)}$ rails. Its maximum output capability is determined by the input to output ratio and the current limit of the boost converter and can be estimated by [式 3](#).

$$I_{OUT(max)} = \frac{V_{IN} \times (I_{LIM_BST} - 50mA) \times \eta}{V_{MAIN}} \quad (3)$$

where

- η is the boost converter power efficiency estimation
- 50 mA is half of the inductor current ripple value

Minimum input voltage, maximum boost output voltage and minimum current limit I_{LIM_BST} should be used as the worst case condition for the estimation.

Internal current limit is also implemented for the integrated LDO/load switch. So the maximum output current of V_{SUB} rail should be lower than I_{LIM_SUB} , which has 200 mA minimum value. For LDO version, the maximum output current is also limited by its input to output headroom, that is $V_{(MAIN)} - V_{(SUB)}$. Make sure the headroom voltage is enough to support the load current. Please refer to [セクション 7.5](#) for the dropout voltage information.

In this example, assume the power efficiency is 80% (lower than typical value for the worst case estimation), so the calculated maximum output current of the boost converter is 50.9 mA, which satisfies the application requirements (15 mA + 10 mA). The load of V_{SUB} rail is 10 mA, which is well below the $V_{(SUB)}$ rail current limit and the dropout voltage is also within the headroom.

9.2.1.2.3 Inductor Selection

Because the selection of the inductor affects steady state operation, transient behavior, and loop stability, the inductor is the most important component in power regulator design. There are three important inductor specifications, inductor value, saturation current, and dc resistance (DCR).

The TPS61098x is designed to work with inductor values between 2.2 μ H and 4.7 μ H. The inductance values affects the switching frequency f in continuous current operation, which is proportional to $1/L$ as shown in [式 4](#).

$$f = \frac{1}{L \times 100mA} \times \frac{V_{IN} \times (V_{MAIN} - V_{IN} \times \eta)}{V_{MAIN}} \quad (4)$$

The inductor current ripple is fixed to 100mA typical value by internal design, but it can be affected by the inductor value indirectly. Normally when a smaller inductor value is applied, the inductor current ramps up and down more quickly, so the current ripple becomes bigger because the internal current comparator has some delay to respond. So if smaller inductor peak current is required in applications, a higher inductor value can be tried. However, the TPS61098x is optimized to work within a range of L and C combinations. The LC output filter inductance and capacitance must be considered together. The output capacitor sets the corner frequency of the converter while the inductor creates a Right-Half-Plane-Zero degrading the stability of the converter. Consequently with a larger inductor, a bigger capacitor normally should be used to ensure the same L/C ratio thus a stable loop.

Having selected an inductance value, the peak current for the inductor in steady-state operation varies as a function of the load, the input and output voltages and can be estimated using 式 5.

$$I_{L,MAX} = \frac{V_{MAIN} \times (I_{MAIN} + I_{SUB})}{V_{IN} \times \eta} + 50\text{mA}; \text{ continuous current operation}$$

$$I_{L,MAX} = 100\text{mA}; \text{ discontinuous current operation} \quad (5)$$

where, 80% can be used for the boost converter power efficiency estimation, 100 mA is the typical inductor current ripple value and 50mA is half of the ripple value, which may be affected a little bit by inductor value. 式 5 provides a suitable inductor current rating by using minimum input voltage, maximum boost output voltage and maximum load current for the calculation. Load transients and error conditions may cause higher inductor currents.

式 6 provides an easy way to estimate whether the device will work in continuous or discontinuous operation depending on the operating points. As long as the 式 6 is true, continuous operation is typically established. If 式 6 becomes false, discontinuous operation is typically established.

$$\frac{V_{MAIN} \times (I_{MAIN} + I_{SUB})}{V_{IN} \times \eta} > 50\text{mA} \quad (6)$$

Selecting an inductor with insufficient saturation performance can lead to excessive peak current in the converter. This could eventually harm the device and reduce its reliability.

In this example, the maximum load for the boost converter is 25 mA, and the minimum input voltage is 0.7 V, and the efficiency under this condition can be estimated at 80%, so the boost converter works in continuous operation by the calculation. The inductor peak current is calculated as 197 mA. To leave some margin, a 4.7 μH inductor with at least 250 mA saturation current is recommended for this application.

表 9-1 also lists the recommended inductor for the TPS61098x device.

表 9-1. List of Inductors

INDUCTANCE [μH]	ISAT [A]	IRMS [A]	DC RESISTANCE [mΩ]	PART NUMBER	MANUFACTURER
4.7	0.86	1.08	168	VLF302510MT-4R7M	TDK
4.7	0.57	0.95	300	VLF252010MT-4R7M	TDK
2.2	1.23	1.5	84	VLF302510MT-2R2M	TDK
2.2	0.83	0.92	120	VLF252010MT-2R2M	TDK

9.2.1.2.4 Capacitor Selection

For best output and input voltage filtering, low ESR X5R or X7R ceramic capacitors are recommended.

The input capacitor minimizes input voltage ripple, suppresses input voltage spikes and provides a stable system rail for the device. An input capacitor value of at least 10 μF is recommended to improve transient behavior of the regulator and EMI behavior of the total power supply circuit. A ceramic capacitor placed as close as possible to the VIN and GND pins of the IC is recommended. For applications where line transient is expected, an input filter composed of 400-Ω resistor and 0.1-μF capacitor as shown in 图 9-1 is mandatory to avoid interference to internal pass-through threshold comparison circuitry.

For the output capacitor of VMAIN pin, small ceramic capacitors are recommended, placed as close as possible to the VMAIN and GND pins of the IC. If, for any reason, the application requires the use of large capacitors which cannot be placed close to the IC, the use of a small ceramic capacitor with a capacitance value of around 2.2 μF in parallel to the large one is recommended. This small capacitor should be placed as close as possible to the VMAIN and GND pins of the IC. The recommended typical output capacitor values are 10 μF and 22 μF (nominal values).

For LDO version, like all low dropout regulators, VSUB rail requires an output capacitor connected between VSUB and GND pins to stabilize the internal control loop. Ceramic capacitor of 10 μF (nominal value) is

recommended for most applications. If the $V_{(SUB)}$ drop during load transient is much cared, higher capacitance value up to 22 μF is recommended to provide better load transient performance. Capacitor below 10 μF is only recommended for light load operation. For load switch version, capacitor of 10x smaller value than capacitor at VMAIN pin is recommended to minimize the voltage drop caused by charge sharing when the load switch is turned on.

When selecting capacitors, ceramic capacitor's derating effect under bias should be considered. Choose the right nominal capacitance by checking capacitor's DC bias characteristics. In this example, GRM188R60J106ME84D, which is a 10 μF ceramic capacitor with high effective capacitance value at DC biased condition, is selected for both VMAIN and VSUB rails. The load transient response performance is shown in [セクション 9.2.1.3](#).

For load switch version, VSUB rails requires an output capacitor connected between VSUB and GND pins. Ceramic capacitor of 1 μF (nominal value) is recommended for most applications.

9.2.1.2.5 Control Sequence

In this example, the MCU is powered by the boost output $V_{(MAIN)}$ and the subsystem is powered by the LDO $V_{(SUB)}$. MCU controls both of the TPS610981 and subsystem. The control sequence as shown in [図 9-2](#) is recommended.



図 9-2. System Control Sequence

When the system is waking up, the MCU wakes up itself first, and it then pulls the MODE pin of TPS610981 to high to turn on the $V_{(SUB)}$ rail. TPS610981 enters into Active mode and gets ready to provide power to the subsystem. Then the MCU enables the subsystem.

When the system is entering into sleep mode, the MCU disables the subsystem first and then pulls the MODE pin to low to turn off the $V_{(SUB)}$, so the subsystem is disconnected from the supply to minimize the current drain. TPS610981 enters into Low Power mode and the VMAIN rail still powers the MCU with only 300 nA quiescent current. The MCU enters into sleep mode itself finally.

9.2.1.3 Application Curves

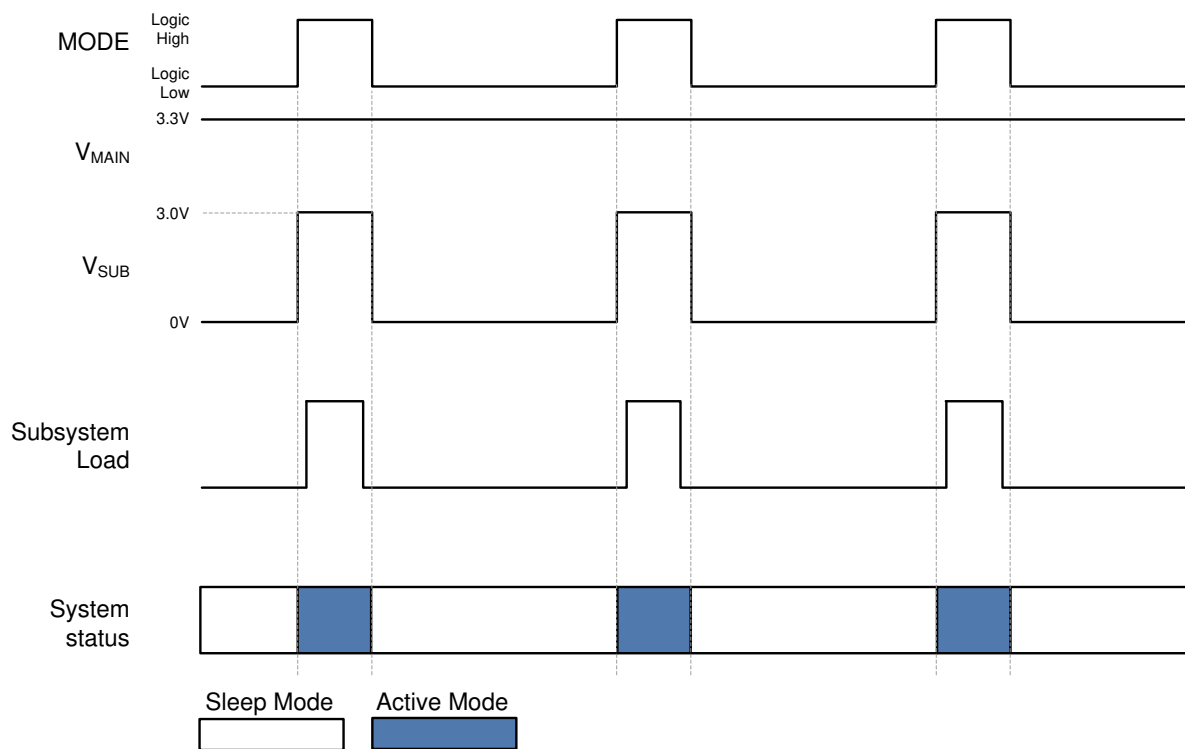
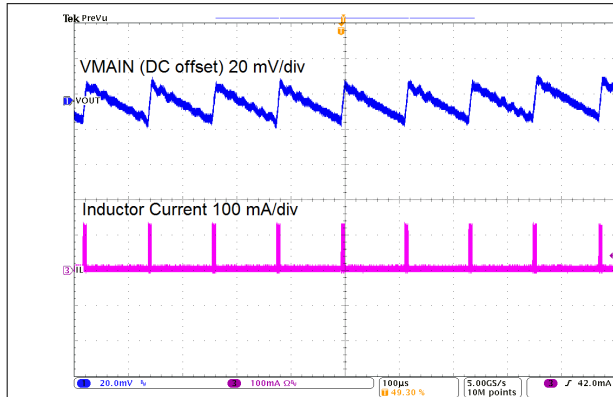

TPS610981 $I_{(MAIN)} = 1 \text{ mA}$ $I_{(SUB)} = 0 \text{ mA}$
 MODE = L $V_{IN} = 1.5 \text{ V}$

9-3. Switching Waveforms

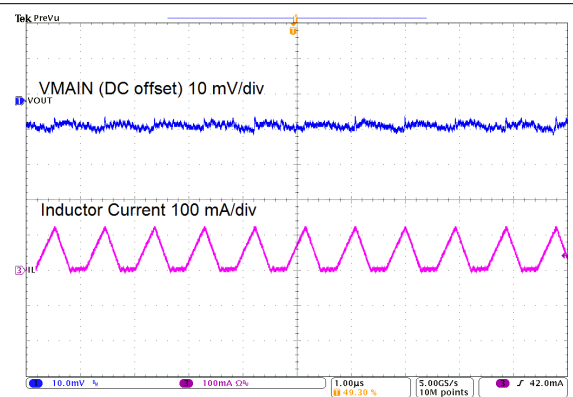

TPS610981 $I_{(MAIN)} = 10 \text{ mA}$ $I_{(SUB)} = 0 \text{ mA}$
 MODE = L $V_{IN} = 1.5 \text{ V}$

9-4. Switching Waveforms

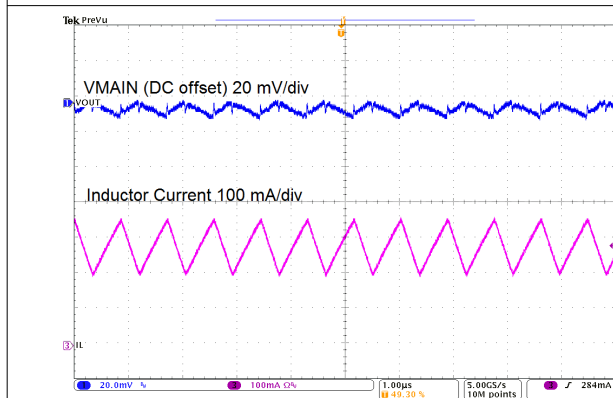

TPS610981 $I_{(MAIN)} = 100 \text{ mA}$ $I_{(SUB)} = 0 \text{ mA}$
 MODE = L $V_{IN} = 1.5 \text{ V}$

9-5. Switching Waveforms

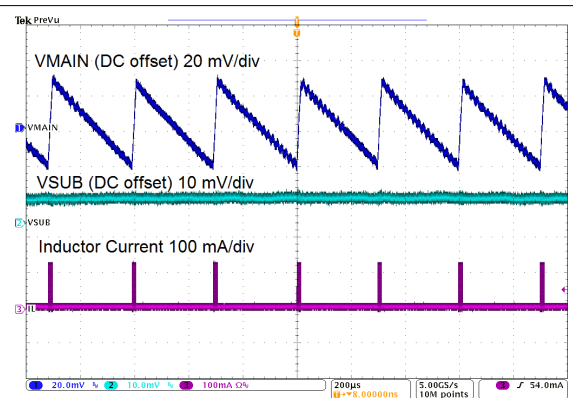

TPS610981 $I_{(MAIN)} = 0 \text{ mA}$ $I_{(SUB)} = 1 \text{ mA}$
 MODE = H $V_{IN} = 1.5 \text{ V}$

9-6. Switching Waveforms

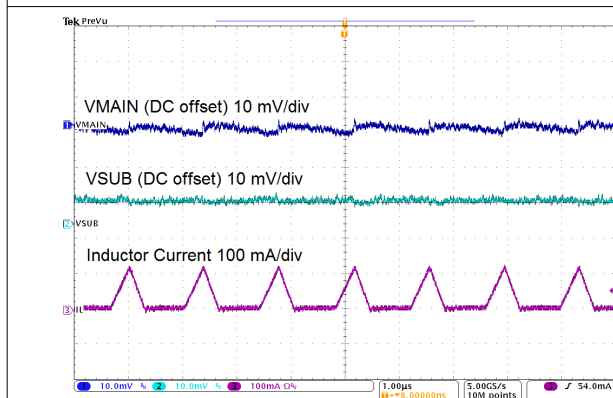

TPS610981 $I_{(MAIN)} = 0 \text{ mA}$ $I_{(SUB)} = 10 \text{ mA}$
 MODE = H $V_{IN} = 1.5 \text{ V}$

9-7. Switching Waveforms

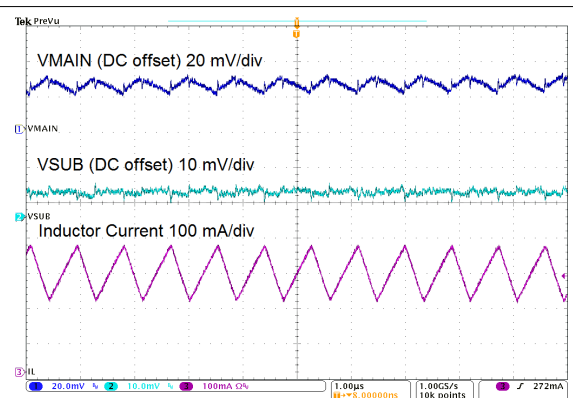

TPS610981 $I_{(MAIN)} = 0 \text{ mA}$ $I_{(SUB)} = 100 \text{ mA}$
 MODE = H $V_{IN} = 1.5 \text{ V}$

9-8. Switching Waveforms

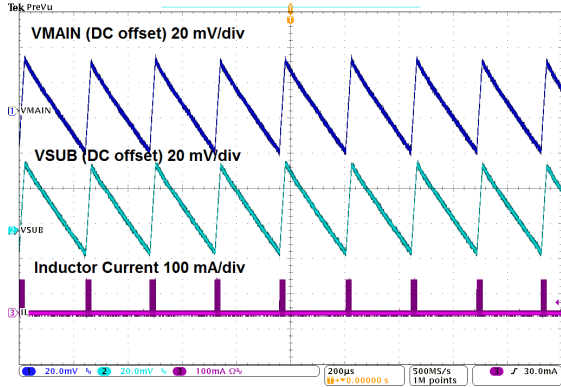

TPS610986 $I_{(MAIN)} = 0 \text{ mA}$ $I_{(SUB)} = 1 \text{ mA}$
MODE = H $V_{IN} = 1.5 \text{ V}$

9-9. Switching Waveforms

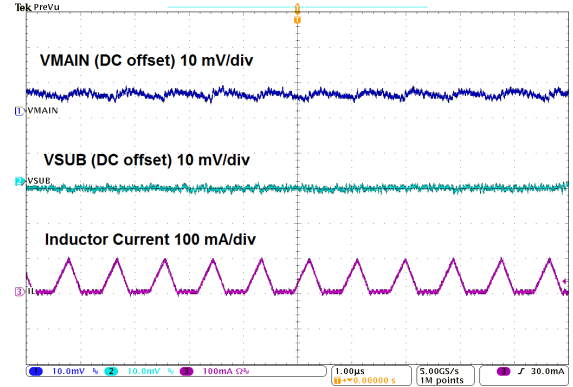

TPS610986 $I_{(MAIN)} = 0 \text{ mA}$ $I_{(SUB)} = 10 \text{ mA}$
MODE = H $V_{IN} = 1.5 \text{ V}$

9-10. Switching Waveforms

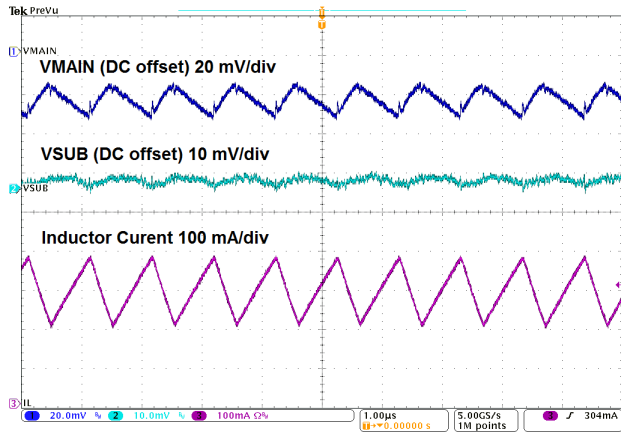

TPS610986 $I_{(MAIN)} = 0 \text{ mA}$ $I_{(SUB)} = 100 \text{ mA}$
MODE = H $V_{IN} = 1.5 \text{ V}$

9-11. Switching Waveforms

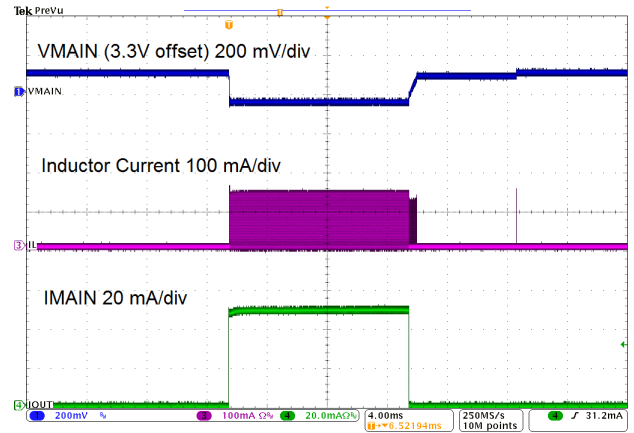

TPS610981 $V_{IN} = 2.5 \text{ V}$ $I_{(SUB)} = 0 \text{ mA}$
MODE = L $I_{(MAIN)} = 0 \text{ mA to } 50 \text{ mA}$, $5 \mu\text{s}$ rising/falling edge

9-12. Load Transient Response

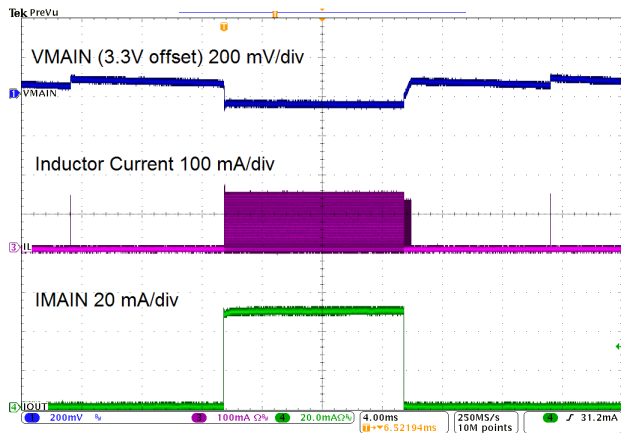

TPS610981 $V_{IN} = 2.5 \text{ V}$ $I_{(SUB)} = 0 \text{ mA}$
MODE = H $I_{(MAIN)} = 0 \text{ mA to } 50 \text{ mA}$, $5 \mu\text{s}$ rising/falling edge

9-13. Load Transient Response

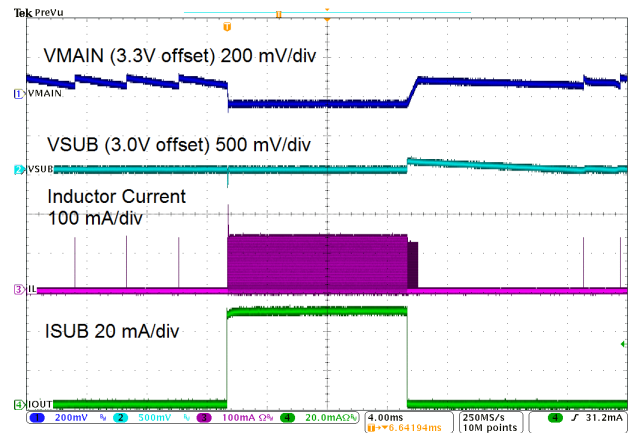

TPS610981 $V_{IN} = 2.5 \text{ V}$ $I_{(MAIN)} = 0 \text{ mA}$
MODE = H $I_{(SUB)} = 0 \text{ mA to } 50 \text{ mA}$, $5 \mu\text{s}$ rising/falling edge

9-14. LDO Load Transient Response

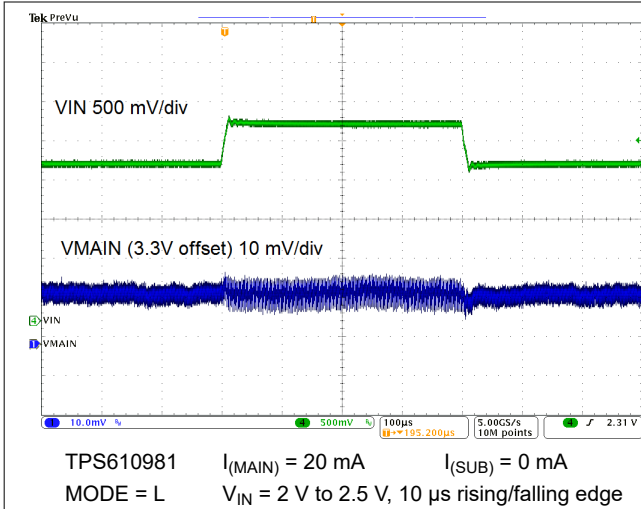

9-15. Line Transient Response

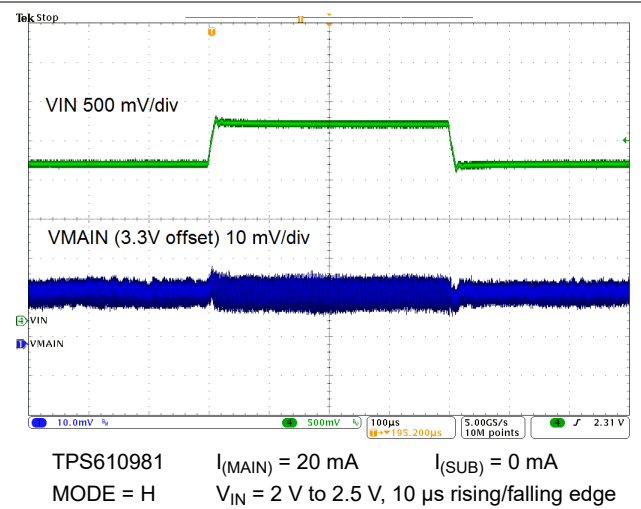

9-16. Line Transient Response

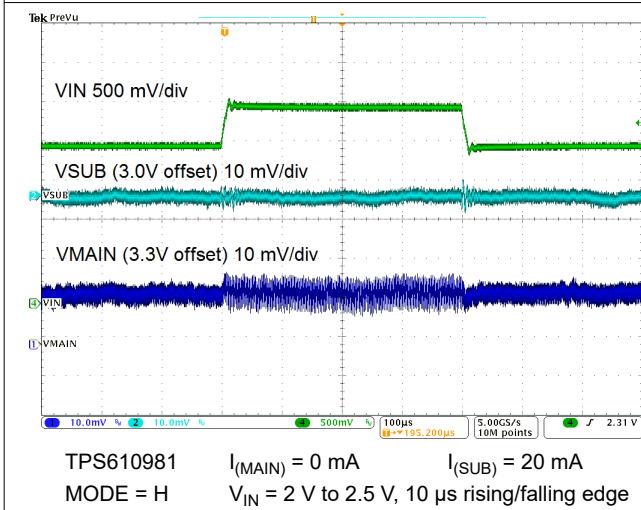

9-17. Line Transient Response

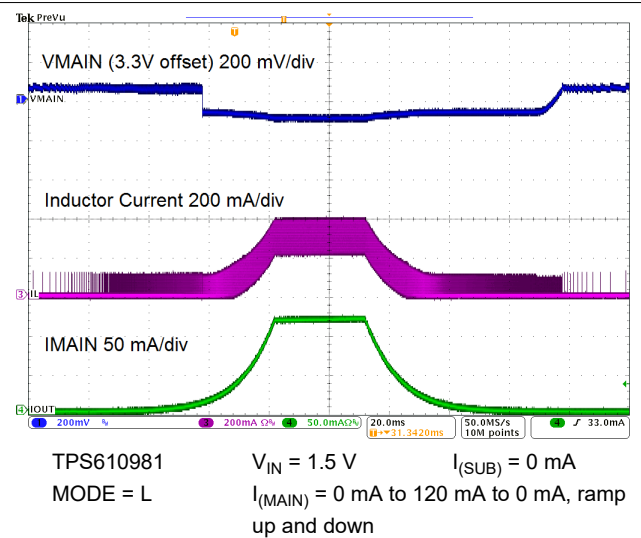

9-18. Load Regulation

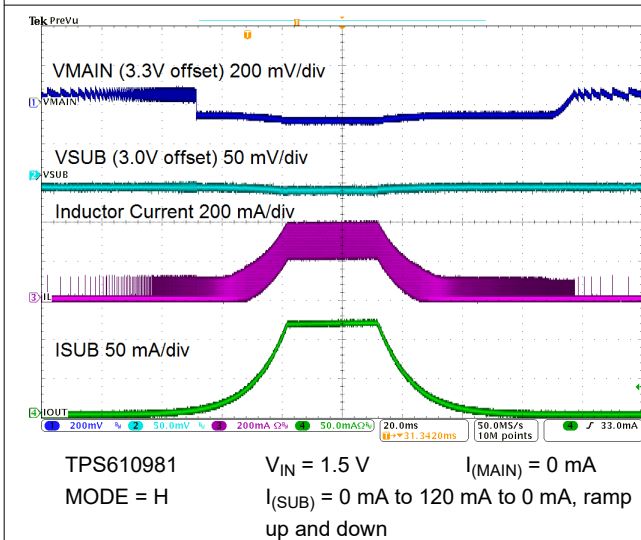

9-19. Load Regulation

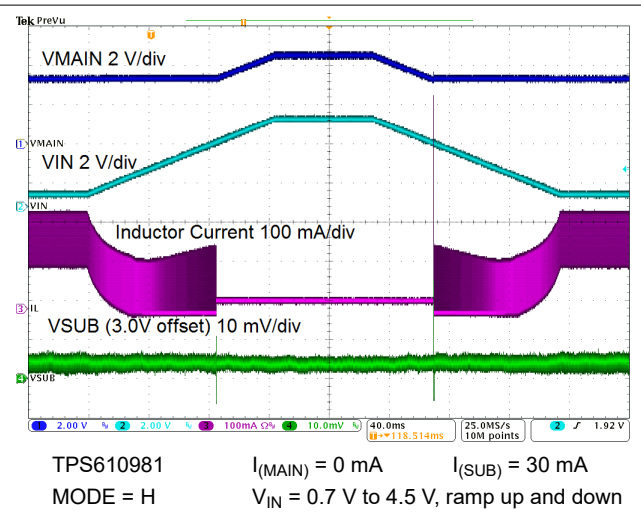

9-20. Line Regulation

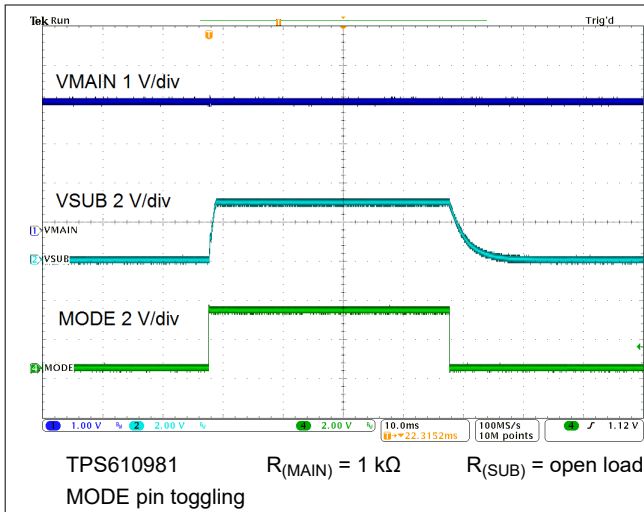

9-21. Mode Toggling

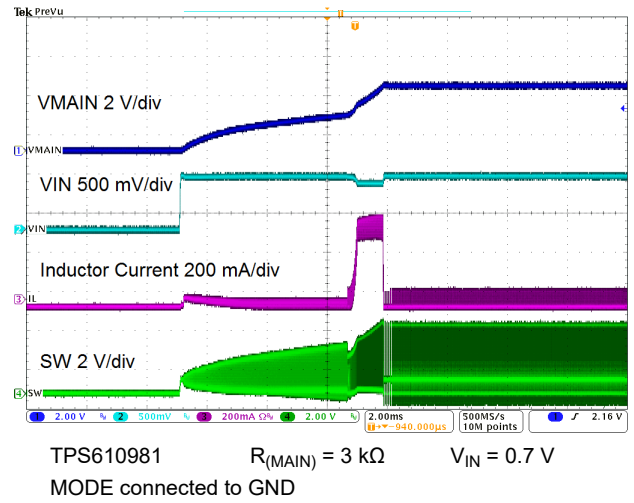

9-22. Startup

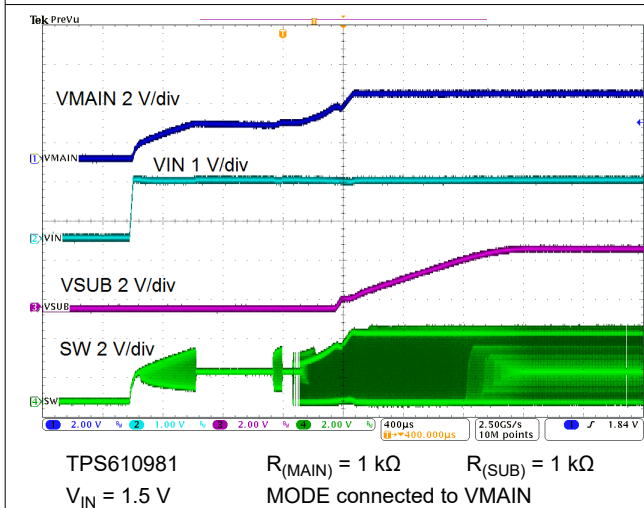

9-23. Startup

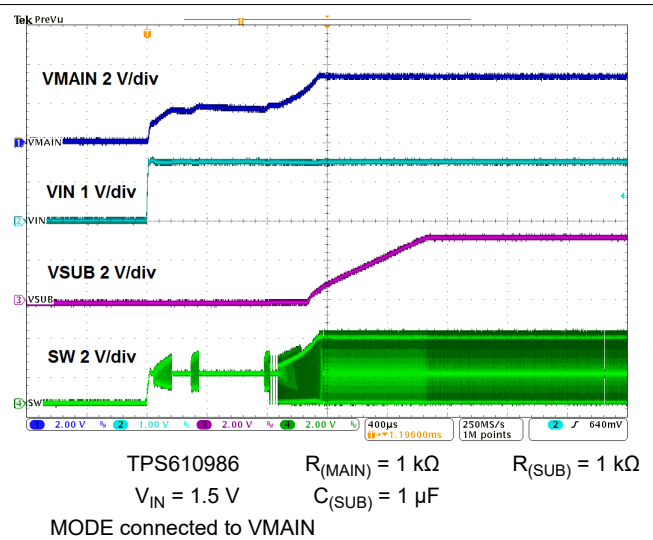

9-24. Startup

9.2.2 VMAIN to Power the System in Low Power Mode

If only one power supply is needed for the whole system, users can easily leave the VSUB pin float and only use the VMAIN rail as the power supply. In this case, the TPS61098x functions as a standard boost converter. If enhanced load transient performance is needed when the system works in Active mode, the controller can control the MODE pin to switch the TPS61098x between the Active mode and Low Power mode. If the ultra-low I_q is critical for the application, users can connect the MODE pin to GND so the TPS61098x keeps working in Low Power mode with only 300 nA quiescent current. Below shows a typical application where the TPS61098 is used in Low Power mode to generate 2.2 V with only 300 nA I_q to power the whole system.

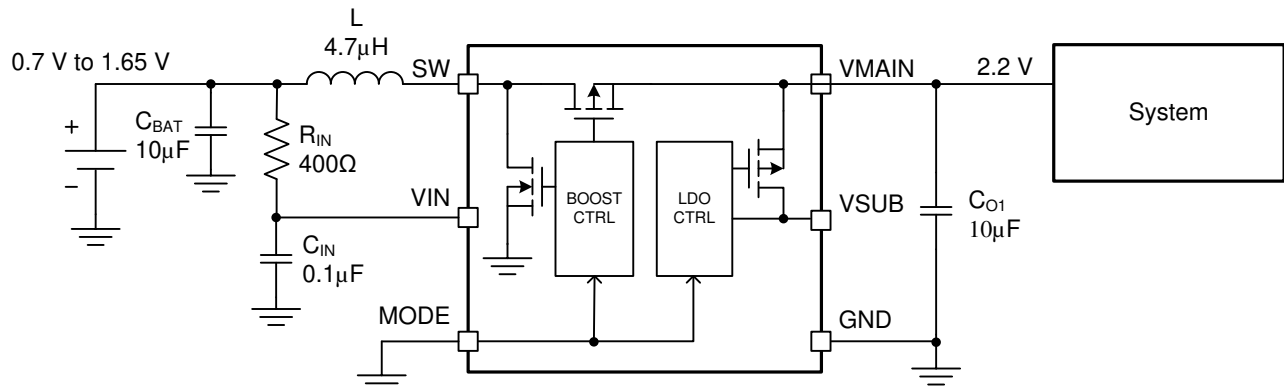

Copyright © 2016, Texas Instruments Incorporated

☒ 9-25. Typical Application of TPS61098 VMAIN to Power the System in Low Power Mode

9.2.2.1 Design Requirements

- 2.2 V $V_{(MAIN)}$ to power the whole system
- Power source, single-cell alkaline battery (0.7 V to 1.65 V range)
- $\geq 80\%$ conversion efficiency at 10 μ A load

9.2.2.2 Detailed Design Procedure

Refer to [セクション 9.2.1.2](#) for the detailed design steps.

9.2.2.3 Application Curves

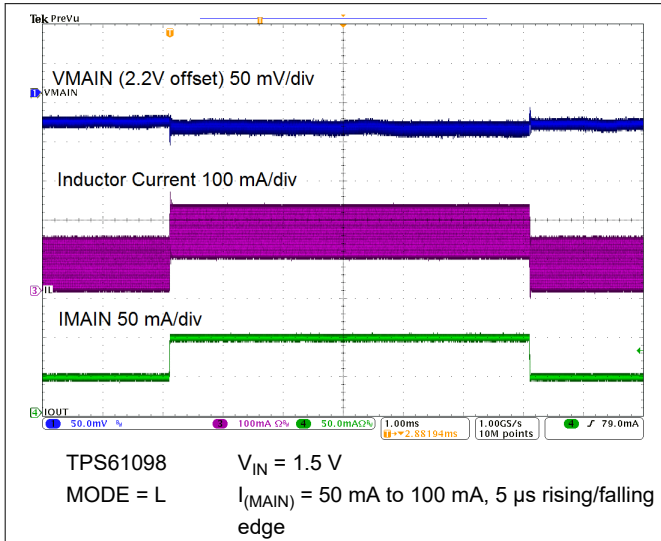

9-26. Load Transient Response

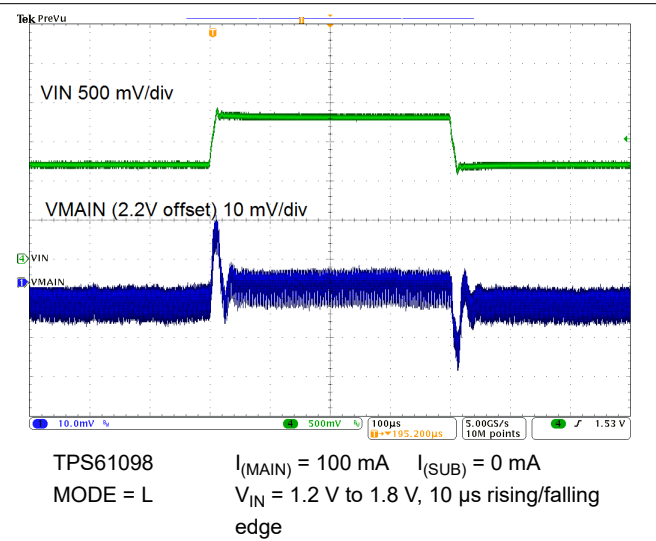

9-27. Line Transient Response

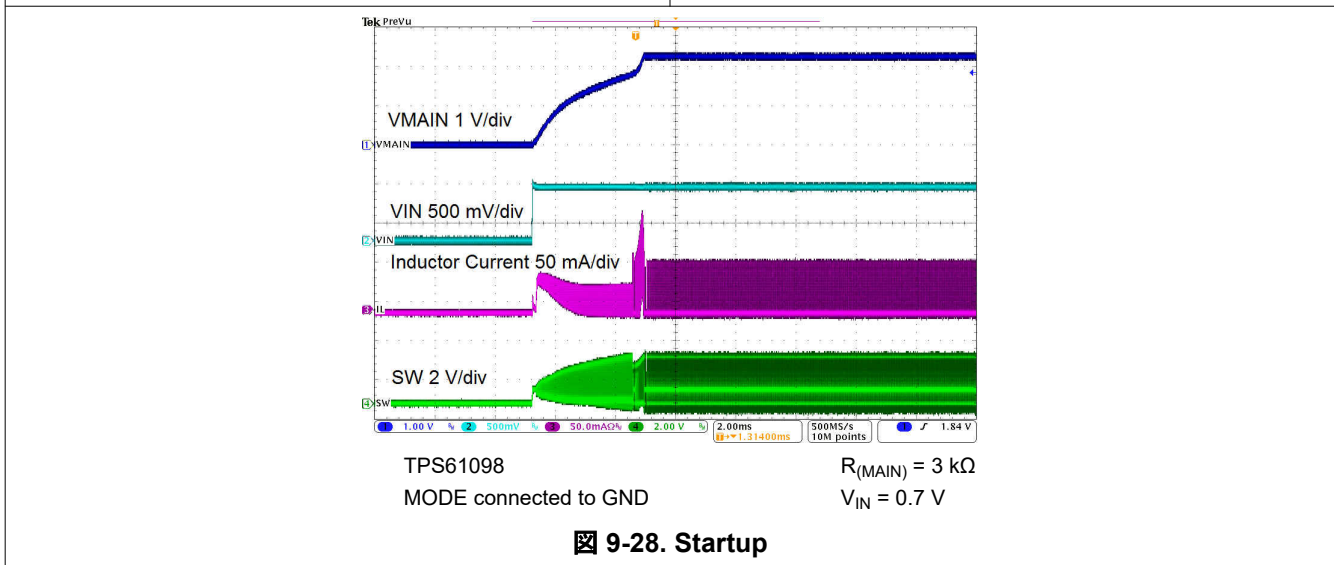

9-28. Startup

9.2.3 VSUB to Power the System in Active Mode

In some applications, the system controller can be powered by the battery directly, but a buck-boost or a boost converter with an LDO is needed to provide a quiet power supply for a subsystem like a sensor. In this type of application, the TPS61098x can be used to replace the discrete boost converter and the LDO, providing a compact solution to simplify the system design and save the PCB space. The LDO can be turned on and off by the MODE pin. When the MODE pin is pulled low, the LDO is turned off to disconnect the load, and the TPS61098x also enters into Low Power mode to save power consumption. [Figure 9-29](#) shows an application where the VSUB of the TPS61098 is used to supply the 3.1 V for a sensor in a system. The boost converter of the TPS61098 outputs 4.3 V and provides enough headroom for the LDO operation.

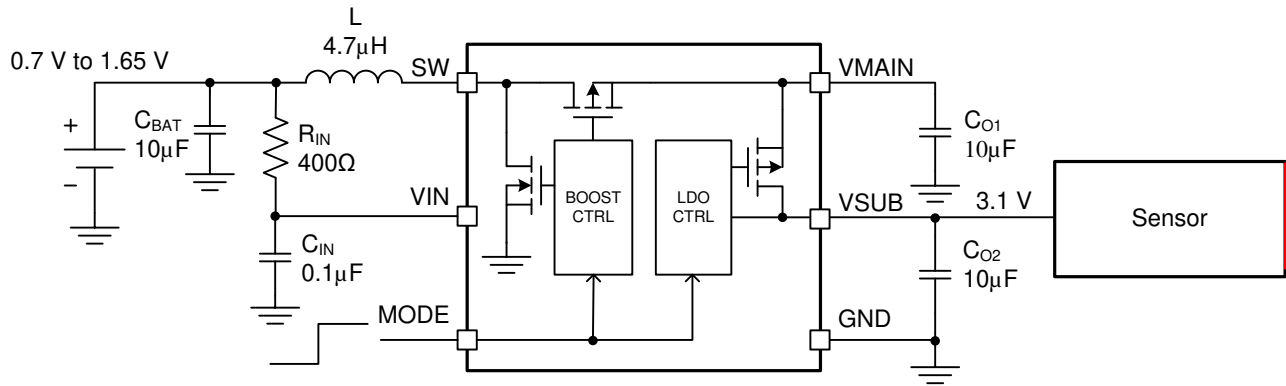

Copyright © 2016, Texas Instruments Incorporated

Figure 9-29. Typical Application of TPS61098 VSUB to Power the System in Active Mode

9.2.3.1 Design Requirements

- 3.1 V rail to power a sensor
- Power source, single-cell li-ion battery (2.7 V to 4.3 V range)

9.2.3.2 Detailed Design Procedure

Refer to [Section 9.2.1.2](#) for the detailed design steps.

9.2.3.3 Application Curves

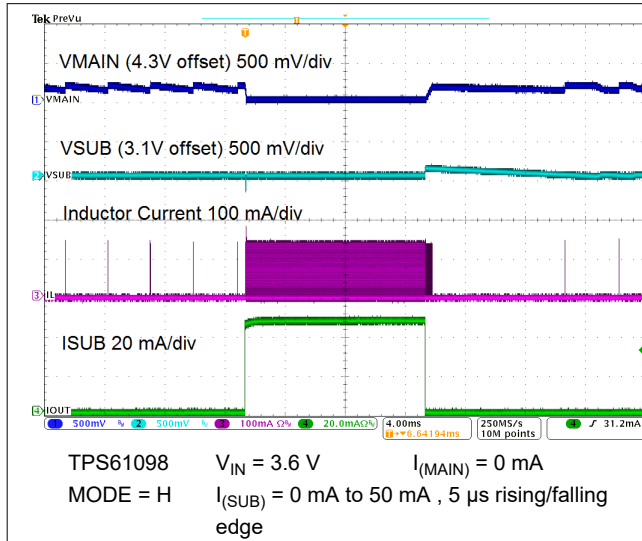

9-30. LDO Load Transient Response

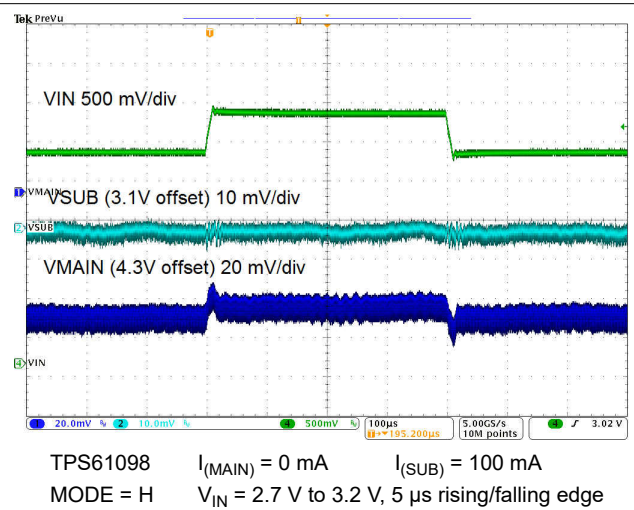

9-31. Line Transient Response

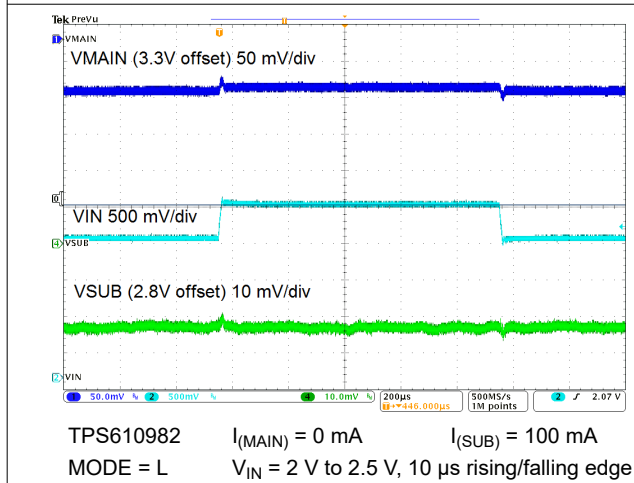

9-32. Line Transient Response

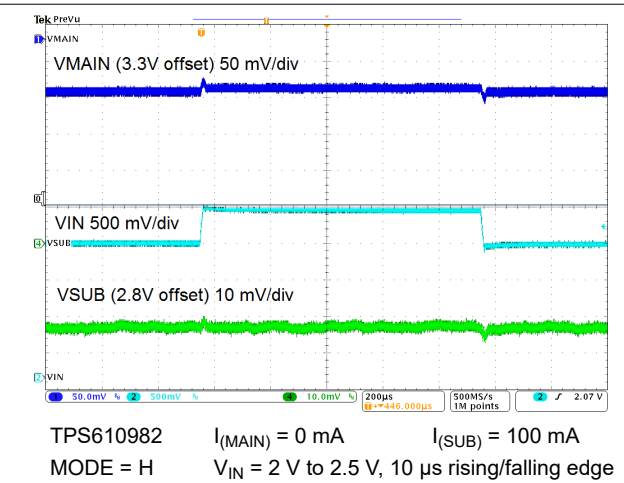

9-33. Line Transient Response

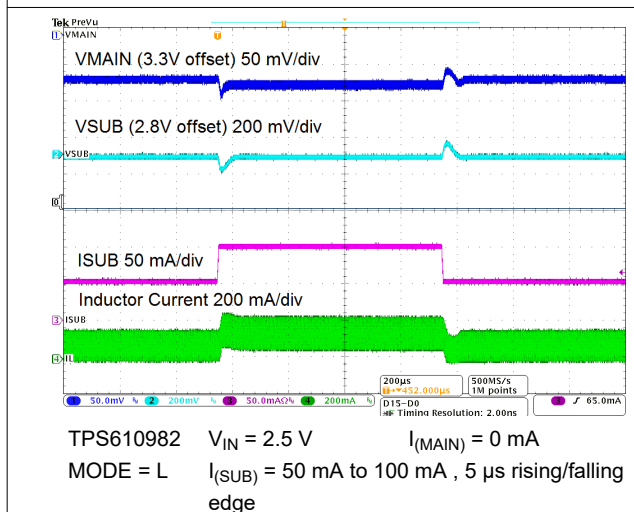

9-34. LDO Load Transient Response

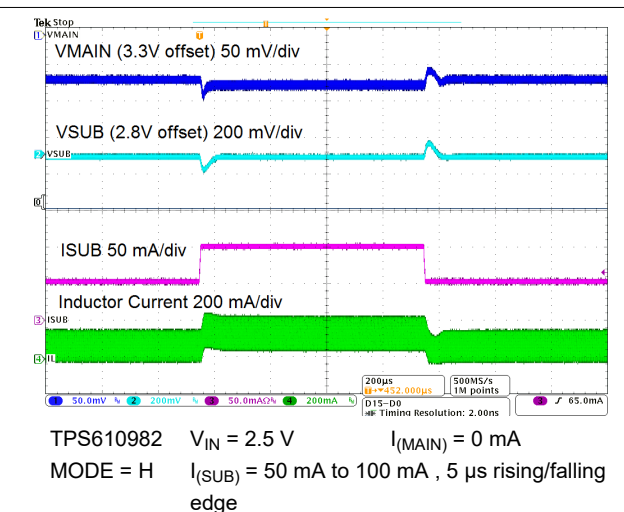

9-35. LDO Load Transient Response

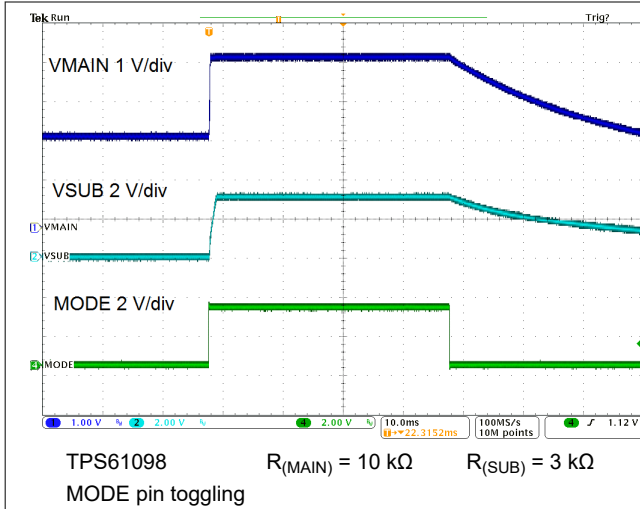

9-36. MODE Toggling

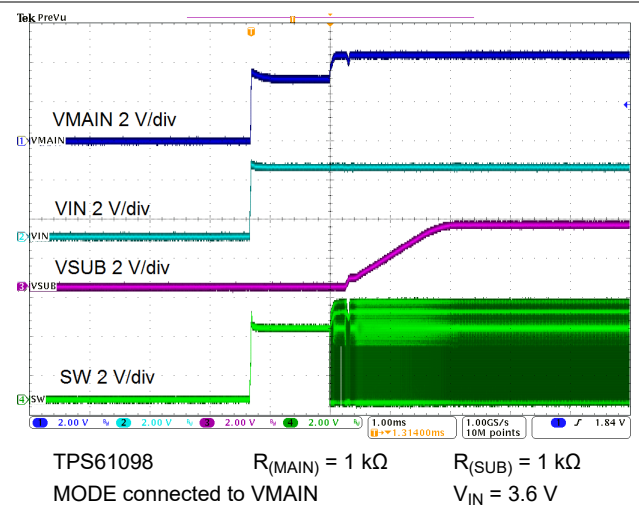

9-37. Startup

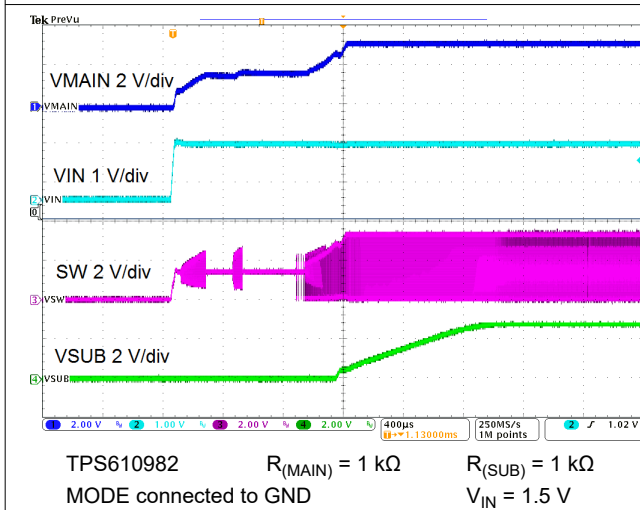

9-38. Startup

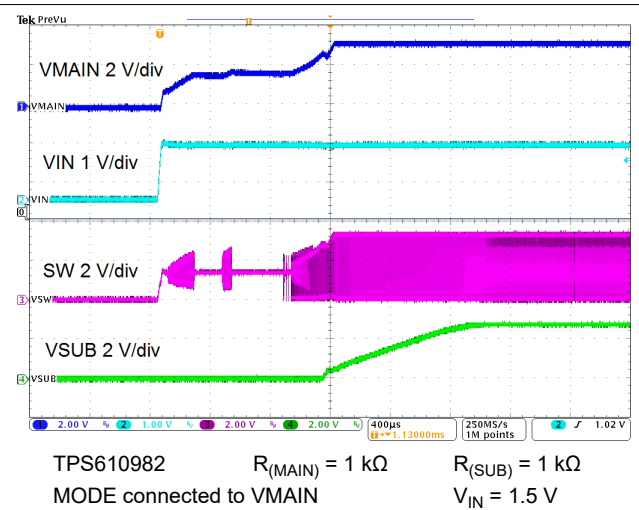

9-39. Startup

10 Power Supply Recommendations

The TPS61098x family is designed to operate from an input voltage supply range between 0.7 V to 4.5 V. The power supply can be either a one-cell or two-cell alkaline, NiCd or NiMH, one-cell coin cell or one-cell Li-Ion or Li-polymer battery. The input supply should be well regulated with the rating of TPS61098x.

11 Layout

11.1 Layout Guidelines

As for all switching power supplies, the layout is an important step in the design, especially at high peak currents and high switching frequencies. If the layout is not carefully done, the regulator could show stability problems as well as EMI problems. Therefore, use wide and short traces for the main current path and for the power ground paths. The input and output capacitor, as well as the inductor should be placed as close as possible to the IC.

11.2 Layout Example

The bottom layer is a large GND plane connected by vias.

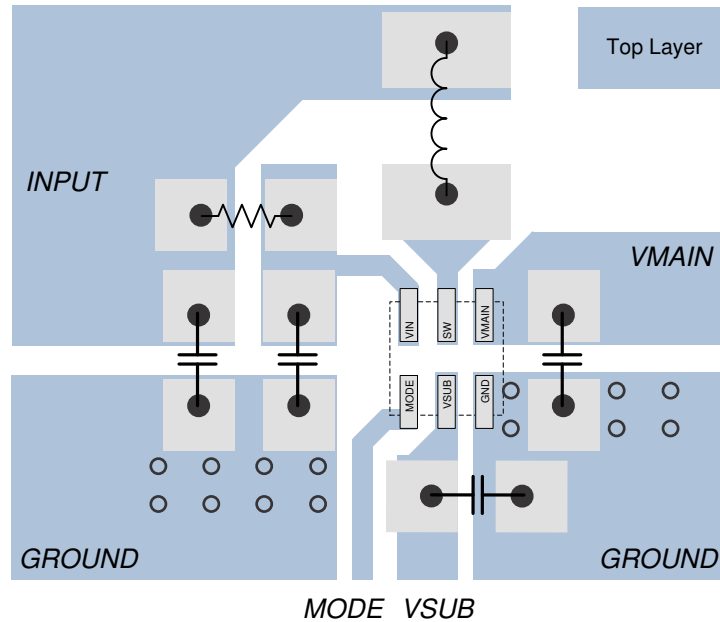

11-1. Layout

12 Device and Documentation Support

12.1 Device Support

12.1.1 Third-Party Products Disclaimer

TI'S PUBLICATION OF INFORMATION REGARDING THIRD-PARTY PRODUCTS OR SERVICES DOES NOT CONSTITUTE AN ENDORSEMENT REGARDING THE SUITABILITY OF SUCH PRODUCTS OR SERVICES OR A WARRANTY, REPRESENTATION OR ENDORSEMENT OF SUCH PRODUCTS OR SERVICES, EITHER ALONE OR IN COMBINATION WITH ANY TI PRODUCT OR SERVICE.

12.2 Documentation Support

12.2.1 Related Documentation

- Texas Instruments, [Performing Accurate PFM Mode Efficiency Measurements Application Report](#)
- Texas Instruments, [Accurately Measuring Efficiency Of Ultra Low-IQ Devices Technical Brief](#)
- Texas Instruments, [IQ: What It Is, What It Isn't, And How To Use It Technical Brief](#)

12.3 Receiving Notification of Documentation Updates

To receive notification of documentation updates, navigate to the device product folder on [ti.com](#). Click on *Subscribe to updates* to register and receive a weekly digest of any product information that has changed. For change details, review the revision history included in any revised document.

12.4 サポート・リソース

[TI E2E™ サポート・フォーラム](#)は、エンジニアが検証済みの回答と設計に関するヒントをエキスパートから迅速かつ直接得ることができる場所です。既存の回答を検索したり、独自の質問をしたりすることで、設計に必要な支援を迅速に得ることができます。

リンクされているコンテンツは、該当する貢献者により、現状のまま提供されるものです。これらは TI の仕様を構成するものではなく、必ずしも TI の見解を反映したものではありません。TI の[使用条件](#)を参照してください。

12.5 Trademarks

TI E2E™ is a trademark of Texas Instruments.

すべての商標は、それぞれの所有者に帰属します。

12.6 静電気放電に関する注意事項



この IC は、ESD によって破損する可能性があります。テキサス・インスツルメンツは、IC を取り扱う際には常に適切な注意を払うことを推奨します。正しい ESD 対策をとらないと、デバイスを破損するおそれがあります。

ESD による破損は、わずかな性能低下からデバイスの完全な故障まで多岐にわたります。精密な IC の場合、パラメータがわずかに変化するだけで公表されている仕様から外れる可能性があるため、破損が発生しやすくなっています。

12.7 用語集

[TI 用語集](#) この用語集には、用語や略語の一覧および定義が記載されています。

13 Mechanical, Packaging, and Orderable Information

The following pages include mechanical packaging and orderable information. This information is the most current data available for the designated devices. This data is subject to change without notice and revision of this document. For browser-based versions of this data sheet, refer to the left-hand navigation.

PACKAGING INFORMATION

Orderable part number	Status (1)	Material type (2)	Package Pins	Package qty Carrier	RoHS (3)	Lead finish/ Ball material (4)	MSL rating/ Peak reflow (5)	Op temp (°C)	Part marking (6)
TPS610981DSER	Active	Production	WSON (DSE) 6	3000 LARGE T&R	Yes	NIPDAU	Level-1-260C-UNLIM	-40 to 125	GM
TPS610981DSER.B	Active	Production	WSON (DSE) 6	3000 LARGE T&R	Yes	NIPDAU	Level-1-260C-UNLIM	-40 to 125	GM
TPS610981DSERG4	Active	Production	WSON (DSE) 6	3000 LARGE T&R	Yes	NIPDAU	Level-1-260C-UNLIM	-40 to 125	GM
TPS610981DSERG4.B	Active	Production	WSON (DSE) 6	3000 LARGE T&R	Yes	NIPDAU	Level-1-260C-UNLIM	-40 to 125	GM
TPS610981DSET	Active	Production	WSON (DSE) 6	250 SMALL T&R	Yes	NIPDAU	Level-1-260C-UNLIM	-40 to 125	GM
TPS610981DSET.B	Active	Production	WSON (DSE) 6	250 SMALL T&R	Yes	NIPDAU	Level-1-260C-UNLIM	-40 to 125	GM
TPS610982DSER	Active	Production	WSON (DSE) 6	3000 LARGE T&R	Yes	NIPDAU	Level-1-260C-UNLIM	-40 to 125	G8
TPS610982DSER.B	Active	Production	WSON (DSE) 6	3000 LARGE T&R	Yes	NIPDAU	Level-1-260C-UNLIM	-40 to 125	G8
TPS610982DSET	Active	Production	WSON (DSE) 6	250 SMALL T&R	Yes	NIPDAU	Level-1-260C-UNLIM	-40 to 125	G8
TPS610982DSET.B	Active	Production	WSON (DSE) 6	250 SMALL T&R	Yes	NIPDAU	Level-1-260C-UNLIM	-40 to 125	G8
TPS610985DSER	Active	Production	WSON (DSE) 6	3000 LARGE T&R	Yes	NIPDAU	Level-1-260C-UNLIM	-40 to 125	1G
TPS610985DSER.B	Active	Production	WSON (DSE) 6	3000 LARGE T&R	Yes	NIPDAU	Level-1-260C-UNLIM	-40 to 125	1G
TPS610985DSERG4	Active	Production	WSON (DSE) 6	3000 LARGE T&R	Yes	NIPDAU	Level-1-260C-UNLIM	-40 to 125	1G
TPS610985DSERG4.B	Active	Production	WSON (DSE) 6	3000 LARGE T&R	Yes	NIPDAU	Level-1-260C-UNLIM	-40 to 125	1G
TPS610985DSET	Active	Production	WSON (DSE) 6	250 SMALL T&R	Yes	NIPDAU	Level-1-260C-UNLIM	-40 to 125	1G
TPS610985DSET.B	Active	Production	WSON (DSE) 6	250 SMALL T&R	Yes	NIPDAU	Level-1-260C-UNLIM	-40 to 125	1G
TPS610986DSER	Active	Production	WSON (DSE) 6	3000 LARGE T&R	Yes	NIPDAU	Level-1-260C-UNLIM	-40 to 125	1H
TPS610986DSER.B	Active	Production	WSON (DSE) 6	3000 LARGE T&R	Yes	NIPDAU	Level-1-260C-UNLIM	-40 to 125	1H
TPS610986DSET	Active	Production	WSON (DSE) 6	250 SMALL T&R	Yes	NIPDAU	Level-1-260C-UNLIM	-40 to 125	1H
TPS610986DSET.B	Active	Production	WSON (DSE) 6	250 SMALL T&R	Yes	NIPDAU	Level-1-260C-UNLIM	-40 to 125	1H
TPS610987DSER	Active	Production	WSON (DSE) 6	3000 LARGE T&R	Yes	NIPDAU	Level-1-260C-UNLIM	-40 to 125	3X
TPS610987DSER.B	Active	Production	WSON (DSE) 6	3000 LARGE T&R	Yes	NIPDAU	Level-1-260C-UNLIM	-40 to 125	3X
TPS610987DSET	Active	Production	WSON (DSE) 6	250 SMALL T&R	Yes	NIPDAU	Level-1-260C-UNLIM	-40 to 125	3X
TPS610987DSET.B	Active	Production	WSON (DSE) 6	250 SMALL T&R	Yes	NIPDAU	Level-1-260C-UNLIM	-40 to 125	3X
TPS61098DSER	Active	Production	WSON (DSE) 6	3000 LARGE T&R	Yes	NIPDAU	Level-1-260C-UNLIM	-40 to 125	GL
TPS61098DSER.B	Active	Production	WSON (DSE) 6	3000 LARGE T&R	Yes	NIPDAU	Level-1-260C-UNLIM	-40 to 125	GL
TPS61098DSERG4	Active	Production	WSON (DSE) 6	3000 LARGE T&R	Yes	NIPDAU	Level-1-260C-UNLIM	-40 to 125	GL
TPS61098DSERG4.B	Active	Production	WSON (DSE) 6	3000 LARGE T&R	Yes	NIPDAU	Level-1-260C-UNLIM	-40 to 125	GL
TPS61098DSET	Active	Production	WSON (DSE) 6	250 SMALL T&R	Yes	NIPDAU	Level-1-260C-UNLIM	-40 to 125	GL

Orderable part number	Status (1)	Material type (2)	Package Pins	Package qty Carrier	RoHS (3)	Lead finish/ Ball material (4)	MSL rating/ Peak reflow (5)	Op temp (°C)	Part marking (6)
TPS61098DSET.B	Active	Production	WSON (DSE) 6	250 SMALL T&R	Yes	NIPDAU	Level-1-260C-UNLIM	-40 to 125	GL

(1) **Status:** For more details on status, see our [product life cycle](#).

(2) **Material type:** When designated, preproduction parts are prototypes/experimental devices, and are not yet approved or released for full production. Testing and final process, including without limitation quality assurance, reliability performance testing, and/or process qualification, may not yet be complete, and this item is subject to further changes or possible discontinuation. If available for ordering, purchases will be subject to an additional waiver at checkout, and are intended for early internal evaluation purposes only. These items are sold without warranties of any kind.

(3) **RoHS values:** Yes, No, RoHS Exempt. See the [TI RoHS Statement](#) for additional information and value definition.

(4) **Lead finish/Ball material:** Parts may have multiple material finish options. Finish options are separated by a vertical ruled line. Lead finish/Ball material values may wrap to two lines if the finish value exceeds the maximum column width.

(5) **MSL rating/Peak reflow:** The moisture sensitivity level ratings and peak solder (reflow) temperatures. In the event that a part has multiple moisture sensitivity ratings, only the lowest level per JEDEC standards is shown. Refer to the shipping label for the actual reflow temperature that will be used to mount the part to the printed circuit board.

(6) **Part marking:** There may be an additional marking, which relates to the logo, the lot trace code information, or the environmental category of the part.

Multiple part markings will be inside parentheses. Only one part marking contained in parentheses and separated by a "~" will appear on a part. If a line is indented then it is a continuation of the previous line and the two combined represent the entire part marking for that device.

Important Information and Disclaimer: The information provided on this page represents TI's knowledge and belief as of the date that it is provided. TI bases its knowledge and belief on information provided by third parties, and makes no representation or warranty as to the accuracy of such information. Efforts are underway to better integrate information from third parties. TI has taken and continues to take reasonable steps to provide representative and accurate information but may not have conducted destructive testing or chemical analysis on incoming materials and chemicals. TI and TI suppliers consider certain information to be proprietary, and thus CAS numbers and other limited information may not be available for release.

In no event shall TI's liability arising out of such information exceed the total purchase price of the TI part(s) at issue in this document sold by TI to Customer on an annual basis.

TAPE AND REEL INFORMATION



QUADRANT ASSIGNMENTS FOR PIN 1 ORIENTATION IN TAPE



*All dimensions are nominal

Device	Package Type	Package Drawing	Pins	SPQ	Reel Diameter (mm)	Reel Width W1 (mm)	A0 (mm)	B0 (mm)	K0 (mm)	P1 (mm)	W (mm)	Pin1 Quadrant
TPS610981DSER	WSON	DSE	6	3000	178.0	8.4	1.7	1.7	0.95	4.0	8.0	Q2
TPS610981DSERG4	WSON	DSE	6	3000	178.0	8.4	1.7	1.7	0.95	4.0	8.0	Q2
TPS610981DSET	WSON	DSE	6	250	178.0	8.4	1.7	1.7	0.95	4.0	8.0	Q2
TPS610982DSER	WSON	DSE	6	3000	178.0	8.4	1.7	1.7	0.95	4.0	8.0	Q2
TPS610982DSET	WSON	DSE	6	250	178.0	8.4	1.7	1.7	0.95	4.0	8.0	Q2
TPS610985DSER	WSON	DSE	6	3000	178.0	8.4	1.7	1.7	0.95	4.0	8.0	Q2
TPS610985DSERG4	WSON	DSE	6	3000	178.0	8.4	1.7	1.7	0.95	4.0	8.0	Q2
TPS610985DSET	WSON	DSE	6	250	178.0	8.4	1.7	1.7	0.95	4.0	8.0	Q2
TPS610986DSER	WSON	DSE	6	3000	178.0	8.4	1.7	1.7	0.95	4.0	8.0	Q2
TPS610986DSET	WSON	DSE	6	250	178.0	8.4	1.7	1.7	0.95	4.0	8.0	Q2
TPS610987DSER	WSON	DSE	6	3000	178.0	8.4	1.7	1.7	0.95	4.0	8.0	Q2
TPS610987DSET	WSON	DSE	6	250	178.0	8.4	1.7	1.7	0.95	4.0	8.0	Q2
TPS61098DSER	WSON	DSE	6	3000	178.0	8.4	1.7	1.7	0.95	4.0	8.0	Q2
TPS61098DSERG4	WSON	DSE	6	3000	178.0	8.4	1.7	1.7	0.95	4.0	8.0	Q2
TPS61098DSET	WSON	DSE	6	250	178.0	8.4	1.7	1.7	0.95	4.0	8.0	Q2

TAPE AND REEL BOX DIMENSIONS

*All dimensions are nominal

Device	Package Type	Package Drawing	Pins	SPQ	Length (mm)	Width (mm)	Height (mm)
TPS610981DSER	WSON	DSE	6	3000	205.0	200.0	33.0
TPS610981DSERG4	WSON	DSE	6	3000	205.0	200.0	33.0
TPS610981DSET	WSON	DSE	6	250	205.0	200.0	33.0
TPS610982DSER	WSON	DSE	6	3000	205.0	200.0	33.0
TPS610982DSET	WSON	DSE	6	250	205.0	200.0	33.0
TPS610985DSER	WSON	DSE	6	3000	205.0	200.0	33.0
TPS610985DSERG4	WSON	DSE	6	3000	205.0	200.0	33.0
TPS610985DSET	WSON	DSE	6	250	205.0	200.0	33.0
TPS610986DSER	WSON	DSE	6	3000	205.0	200.0	33.0
TPS610986DSET	WSON	DSE	6	250	205.0	200.0	33.0
TPS610987DSER	WSON	DSE	6	3000	205.0	200.0	33.0
TPS610987DSET	WSON	DSE	6	250	205.0	200.0	33.0
TPS61098DSER	WSON	DSE	6	3000	205.0	200.0	33.0
TPS61098DSERG4	WSON	DSE	6	3000	205.0	200.0	33.0
TPS61098DSET	WSON	DSE	6	250	205.0	200.0	33.0

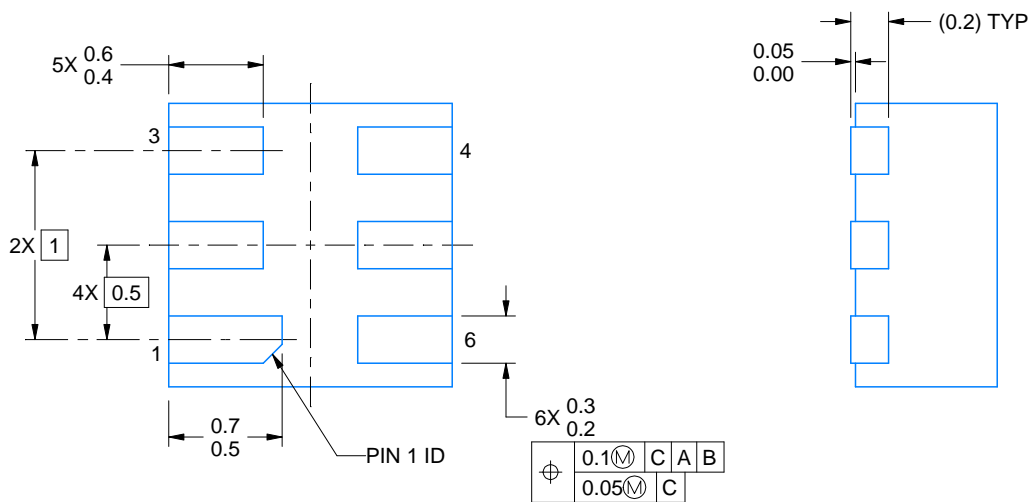
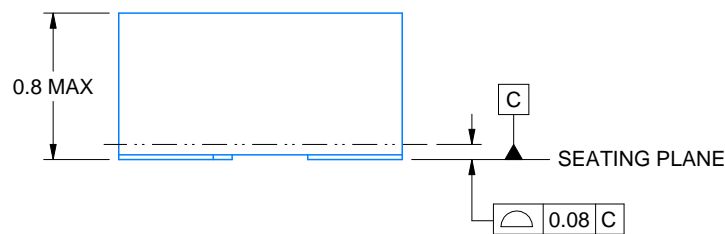
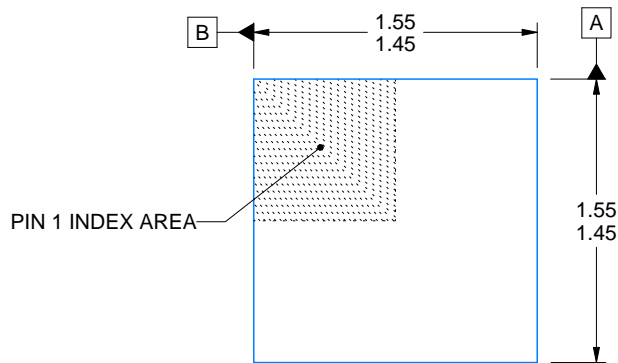
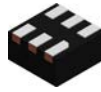

4220552/B 01/2024

NOTES:

1. All linear dimensions are in millimeters. Any dimensions in parenthesis are for reference only. Dimensioning and tolerancing per ASME Y14.5M.
2. This drawing is subject to change without notice.

EXAMPLE BOARD LAYOUT

DSE0006A

WSON - 0.8 mm max height

PLASTIC SMALL OUTLINE - NO LEAD

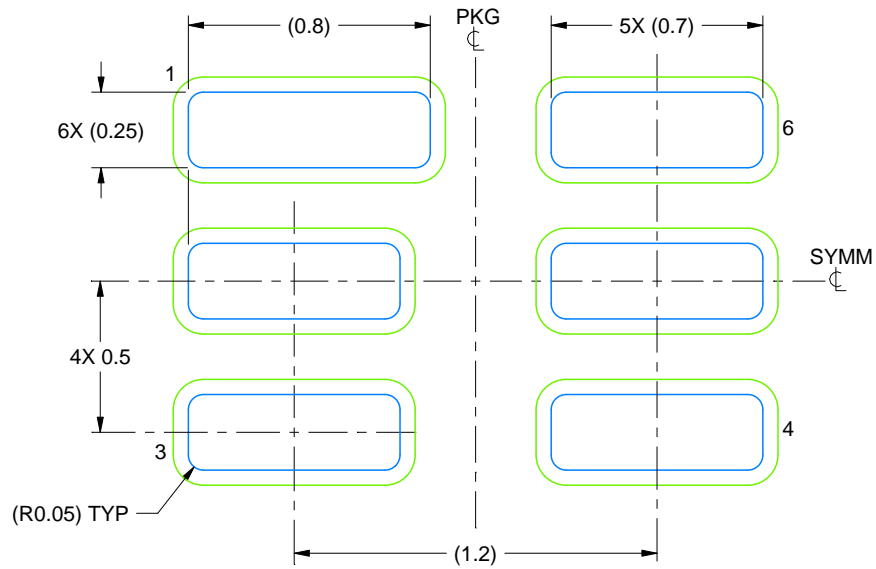

LAND PATTERN EXAMPLE
SCALE:40X

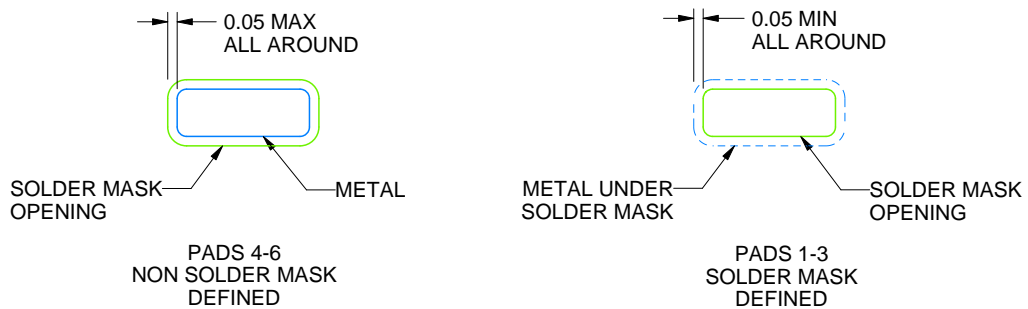

SOLDER MASK DETAILS

4220552/B 01/2024

NOTES: (continued)

3. For more information, see Texas Instruments literature number SLUA271 (www.ti.com/lit/slua271).

EXAMPLE STENCIL DESIGN

DSE0006A

WSON - 0.8 mm max height

PLASTIC SMALL OUTLINE - NO LEAD

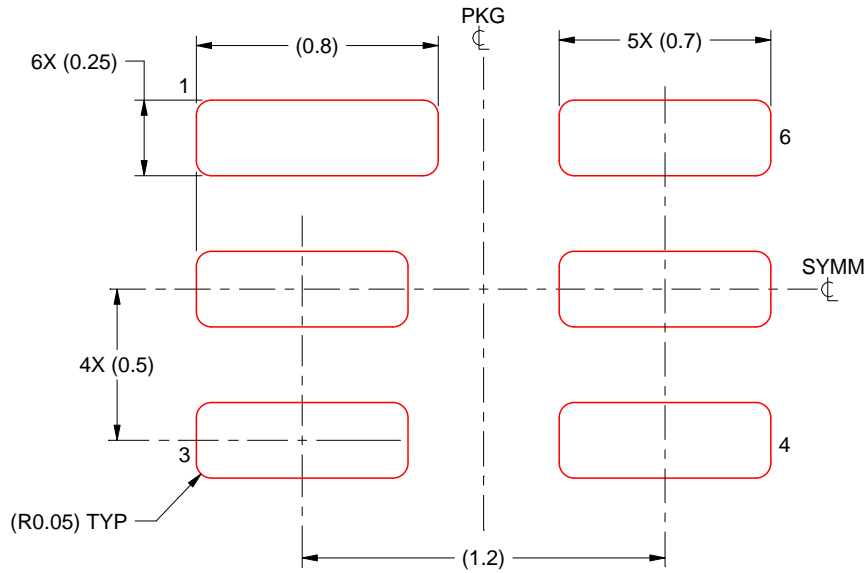

SOLDER PASTE EXAMPLE
BASED ON 0.125 mm THICK STENCIL
SCALE:40X

NOTES: (continued)

4. Laser cutting apertures with trapezoidal walls and rounded corners may offer better paste release. IPC-7525 may have alternate design recommendations.

重要なお知らせと免責事項

TI は、技術データと信頼性データ(データシートを含みます)、設計リソース(リファレンス デザインを含みます)、アプリケーションや設計に関する各種アドバイス、Web ツール、安全性情報、その他のリソースを、欠陥が存在する可能性のある「現状のまま」提供しており、商品性および特定目的に対する適合性の黙示保証、第三者の知的財産権の非侵害保証を含むいかなる保証も、明示的または黙示的にかかわらず拒否します。

これらのリソースは、TI 製品を使用する設計の経験を積んだ開発者への提供を意図したものです。(1) お客様のアプリケーションに適した TI 製品の選定、(2) お客様のアプリケーションの設計、検証、試験、(3) お客様のアプリケーションに該当する各種規格や、その他のあらゆる安全性、セキュリティ、規制、または他の要件への確実な適合に関する責任を、お客様のみが単独で負うものとし、

上記の各種リソースは、予告なく変更される可能性があります。これらのリソースは、リソースで説明されている TI 製品を使用するアプリケーションの開発の目的でのみ、TI はその使用をお客様に許諾します。これらのリソースに関して、他の目的で複製することや掲載することは禁止されています。TI や第三者の知的財産権のライセンスが付与されている訳ではありません。お客様は、これらのリソースを自身で使用した結果発生するあらゆる申し立て、損害、費用、損失、責任について、TI およびその代理人を完全に補償するものとし、TI は一切の責任を拒否します。

TI の製品は、[TI の販売条件](#)、[TI の総合的な品質ガイドライン](#)、[ti.com](#) または TI 製品などに関連して提供される他の適用条件に従い提供されます。TI がこれらのリソースを提供することは、適用される TI の保証または他の保証の放棄の拡大や変更を意味するものではありません。TI がカスタム、またはカスタマー仕様として明示的に指定していない限り、TI の製品は標準的なカタログに掲載される汎用機器です。

お客様がいかなる追加条項または代替条項を提案する場合も、TI はそれらに異議を唱え、拒否します。

Copyright © 2025, Texas Instruments Incorporated

最終更新日：2025 年 10 月