

# TPS65251 4.5V~18V入力、大電流、同期整流降圧、FET内蔵の3降圧スイッチャー

## 1 特長

- 広い入力電源電圧範囲(4.5~18V)
- 0.8V、1%精度の基準電圧
- 連続負荷: 3A (降圧1)、2A (降圧2および3)
- 最大電流: 3.5A (降圧1)、2.5A (降圧2および3)
- 可変スイッチング周波数  
外付け抵抗により300kHz~2.2MHzに設定
- 各降圧に専用のイネーブル
- 発振器用の外部同期ピン
- 外部イネーブル/シーケンシングおよびソフトスタート・ピン
- 外付け抵抗で電流制限を変更可能
- ソフトスタート・ピン
- 簡単な補償回路による電流モード制御
- パワー・グッド
- (オプション)軽負荷時の低消費電力モード動作
- VQFNパッケージ、40ピン6mmx6mm RHA

## 2 アプリケーション

- セット・トップ・ボックス
- Blu-ray DVD
- DVR
- DTV
- 車内用オーディオおよびビデオ
- セキュリティ・カメラ

## 3 概要

TPS65251には、同期整流、広い入力範囲、高効率の降圧コンバータが3つ搭載されています。これらのコンバータは、アプリケーションを簡素化するとともに、設計者が対象アプリケーションに応じて使用を最適化できるよう設計されています。

コンバータは、5、9、12、15Vのシステムで動作し、パワー・トランジスタが内蔵されています。出力電圧は外付けの分圧抵抗を使用して、0.8Vから入力電源電圧近くまでの任意の値に設定できます。各コンバータにはイネーブル・ピンがあり、シーケンシングの目的で遅延スタートアップが可能です。ソフトスタート・ピンにより、ソフトスタート・コンデンサを選択してソフトスタート時間を変更でき、電流制限(RLIMx)ピンを使用して外付け抵抗を選択し、最適なインダクタを選択することで、電流制限を設定できます。電流モード制御により、RC補償が簡単になります。

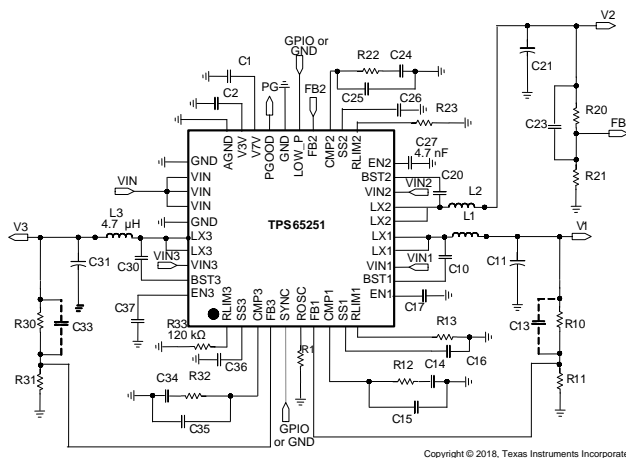
コンバータのスイッチング周波数は、ROSCピンに接続される外付け抵抗で設定するか、または必要に応じてSYNCピンに接続される外部クロックにも同期できます。スイッチング・レギュレータは、300kHz~2.2MHzで動作するよう設計されています。降圧1と降圧2、3は位相差180°で動作するため(降圧2と降圧3は同相動作)、入力フィルタの要件が最小化されます。

### 製品情報<sup>(1)</sup>

型番	パッケージ	本体サイズ(公称)
TPS65251	VQFN (40)	6.00mmx6.00mm

(1) 利用可能なすべてのパッケージについては、このデータシートの末尾にある注文情報を参照してください。

### 代表的なアプリケーションの回路図



Copyright © 2018, Texas Instruments Incorporated



## 目次

1	特長 .....	1	8.4	Device Functional Modes .....	15
2	アプリケーション .....	1	<b>9</b>	<b>Application and Implementation</b> .....	<b>17</b>
3	概要 .....	1	9.1	Application Information .....	17
4	改訂履歴 .....	2	9.2	Typical Application .....	17
5	概要 (続き) .....	3	<b>10</b>	<b>Power Supply Recommendations</b> .....	<b>24</b>
6	<b>Pin Configuration and Functions</b> .....	<b>3</b>	<b>11</b>	<b>Layout</b> .....	<b>24</b>
7	<b>Specifications</b> .....	<b>5</b>	11.1	Layout Guidelines .....	24
7.1	Absolute Maximum Ratings .....	5	11.2	Layout Example .....	25
7.2	ESD Ratings .....	5	11.3	Power Dissipation .....	25
7.3	Recommended Operating Conditions .....	5	<b>12</b>	<b>デバイスおよびドキュメントのサポート</b> .....	<b>27</b>
7.4	Thermal Information .....	5	12.1	ドキュメントの更新通知を受け取る方法 .....	27
7.5	Electrical Characteristics .....	6	12.2	コミュニティ・リソース .....	27
7.6	Typical Characteristics .....	8	12.3	商標 .....	27
<b>8</b>	<b>Detailed Description</b> .....	<b>11</b>	12.4	静電気放電に関する注意事項 .....	27
8.1	Overview .....	11	12.5	Glossary .....	27
8.2	Functional Block Diagram .....	11	<b>13</b>	<b>メカニカル、パッケージ、および注文情報</b> .....	<b>27</b>
8.3	Feature Description .....	12			

## 4 改訂履歴

資料番号末尾の英字は改訂を表しています。その改訂履歴は英語版に準じています。

<b>Revision F (July 2015) から Revision G に変更</b>	<b>Page</b>
<ul style="list-style-type: none"> <li>Changed the values for Voltage at LX1, LX2, LX3 From: MIN = -1 V, MAX = 20 V To: MIN = -3 V, MAX = 23 V in the <i>Absolute Maximum Ratings</i> .....</li> </ul>	5

<b>Revision E (December 2014) から Revision F に変更</b>	<b>Page</b>
<ul style="list-style-type: none"> <li>Changed the MAX value for Voltage at VIN1, VIN2, VIN3, LX1, LX2, LX3 From: 18 V To: 20 V in the <i>Absolute Maximum Ratings</i> .....</li> <li>「コミュニティ・リソース」を追加 .....</li> </ul>	5 27

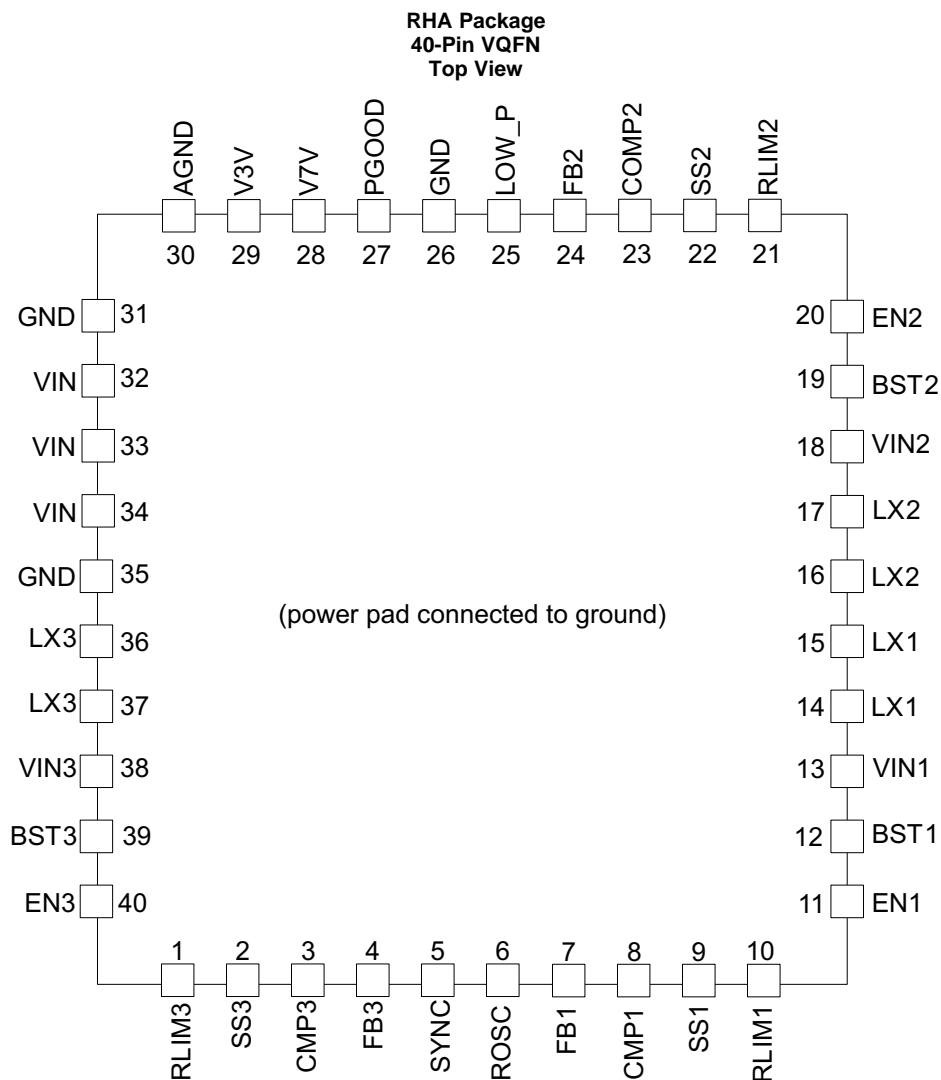
<b>Revision D (December 2012) から Revision E に変更</b>	<b>Page</b>
<ul style="list-style-type: none"> <li>「ピン構成および機能」セクション、「ESD定格」表、「機能説明」セクション、「デバイスの機能モード」セクション、「アプリケーションと実装」セクション、「電源に関する推奨事項」セクション、「レイアウト」セクション、「デバイスおよびドキュメントのサポート」セクション、「メカニカル、パッケージ、および注文情報」セクション 追加 .....</li> </ul>	1

## 5 概要 (続き)

TPS65251にはスーパーバイザ回路があり、各コンバータの出力を監視します。シーケンシングが完了し、すべてのPG信号が通知され、選択可能なリセット終了時間が経過すると、PGOODピンがアサートされます。PGOOD信号の極性はアクティブHIGHです。

TPS65251には軽負荷パルス・スキップ・モード(PSM)も搭載されており、LOW\_PピンをV3Vに接続すると有効になります。PSMモードでは、ホスト・プロセッサがスタンバイ(低活性)モードのときに、システムへの入力電力を低減できます。

## 6 Pin Configuration and Functions



**Pin Functions**

PIN		I/O	DESCRIPTION
NAME	NO.		
RLIM3	1	I	Current limit setting for Buck 3. Fit a resistor from this pin to ground to set the peak current limit on the output inductor.
SS3	2	I	Soft-start pin for Buck 3. Fit a small ceramic capacitor to this pin to set the converter soft-start time.
COMP3	3	O	Compensation for Buck 3. Fit a series RC circuit to this pin to complete the compensation circuit of this converter.
FB3	4	I	Feedback input for Buck 3. Connect a divider set to 0.8V from the output of the converter to ground.

**Pin Functions (continued)**

PIN		I/O	DESCRIPTION
NAME	NO.		
SYNC	5	I	Synchronous clock input. If there is a sync clock in the system, connect to the pin. When not used connect to GND.
ROSC	6	I	Oscillator set. This resistor sets the frequency of internal autonomous clock. If external synchronization is used resistor should be fitted and set to about 70% of external clock frequency.
FB1	7	I	Feedback pin for Buck 1. Connect a divider set to 0.8 V from the output of the converter to ground.
COMP1	8	O	Compensation pin for Buck 1. Fit a series RC circuit to this pin to complete the compensation circuit of this converter.
SS1	9	I	Soft-start pin for Buck 1. Fit a small ceramic capacitor to this pin to set the converter soft-start time.
RLIM1	10	I	Current limit setting pin for Buck 1. Fit a resistor from this pin to ground to set the peak current limit on the output inductor.
EN1	11	I	Enable pin for Buck 1. A low level signal on this pin disables it. If pin is left open a weak internal pullup to V3V will allow for automatic enable. For a delayed start-up add a small ceramic capacitor from this pin to ground.
BST1	12	I	Bootstrap capacitor for Buck 1. Fit a 47-nF ceramic capacitor from this pin to the switching node.
VIN1	13	I	Input supply for Buck 1. Fit a 10- $\mu$ F ceramic capacitor close to this pin.
LX1	14	O	Switching node for Buck 1
	15		
LX2	16	O	Switching node for Buck 2
	17		
VIN2	18	I	Input supply for Buck 2. Fit a 10- $\mu$ F ceramic capacitor close to this pin.
BST2	19	I	Bootstrap capacitor for Buck 2. Fit a 47-nF ceramic capacitor from this pin to the switching node.
EN2	20	I	Enable pin for Buck 2. A low level signal on this pin disables it. If pin is left open a weak internal pullup to V3V will allow for automatic enable. For a delayed start-up add a small ceramic capacitor from this pin to ground.
RLIM2	21	I	Current limit setting for Buck 2. Fit a resistor from this pin to ground to set the peak current limit on the output inductor.
SS2	22	I	Soft-start pin for Buck 2. Fit a small ceramic capacitor to this pin to set the converter soft-start time.
COMP2	23	O	Compensation pin for Buck 2. Fit a series RC circuit to this pin to complete the compensation circuit of this converter
FB2	24	I	Feedback input for Buck 2. Connect a divider set to 0.8 V from the output of the converter to ground.
LOW_P	25	I	Low-power operation mode (active high) input for TPS65251
GND	26		Ground pin
PGOOD	27	O	Powergood. Open-drain output asserted after all converters are sequenced and within regulation. Polarity is factory selectable (active high default).
V7V	28	O	Internal supply. Connect a 10- $\mu$ F ceramic capacitor from this pin to ground.
V3V	29	O	Internal supply. Connect a 3.3- $\mu$ F to 10- $\mu$ F ceramic capacitor from this pin to ground.
AGND	30		Analog ground. Connect all GND pins and the power pad together.
GND	31		Ground pin
VIN	32	I	Input supply
VIN	33	I	Input supply
VIN	34	I	Input supply
GND	35		Ground pin
LX3	36	O	Switching node for Buck 3
	37		
VIN3	38		Input supply for Buck 3. Fit a 10- $\mu$ F ceramic capacitor close to this pin.
BST3	39	I	Bootstrap capacitor for Buck 3. Fit a 47-nF ceramic capacitor from this pin to the switching node.
EN3	40	I	Enable pin for Buck 3. A low level signal on this pin disables it. If pin is left open a weak internal pullup to V3V will allow for automatic enable. For a delayed start-up add a small ceramic capacitor from this pin to ground.
PAD	—	—	Power pad. Connect to ground.

## 7 Specifications

### 7.1 Absolute Maximum Ratings

over operating free-air temperature (unless otherwise noted)<sup>(1)</sup>

	MIN	MAX	UNIT
Voltage at VIN1, VIN2, VIN3, LX1, LX2, LX3	-0.3	20	V
Voltage at LX1, LX2, LX3 (maximum withstand voltage transient < 10 ns)	-3	23	V
Voltage at BST1, BST2, BST3, referenced to Lx pin	-0.3	7	V
Voltage at V7V, COMP1, COMP2, COMP3	-0.3	7	V
Voltage at V3V, RLIM1, RLIM2, RLIM3, EN1, EN2, EN3, SS1, SS2, SS3, FB1, FB2, FB3, PGOOD, SYNC, ROOSC, LOW_P	-0.3	3.6	V
Voltage at AGND, GND	-0.3	0.3	V
T <sub>J</sub> Operating virtual junction temperature	-40	125	°C
T <sub>stg</sub> Storage temperature	-55	150	°C

- (1) Stresses beyond those listed under *Absolute Maximum Ratings* may cause permanent damage to the device. These are stress ratings only, and functional operation of the device at these or any other conditions beyond those indicated under *Recommended Operating Conditions* is not implied. Exposure to absolute-maximum-rated conditions for extended periods may affect device reliability.

### 7.2 ESD Ratings

	VALUE	UNIT
V <sub>(ESD)</sub> Electrostatic discharge	Human-body model (HBM), per ANSI/ESDA/JEDEC JS-001 <sup>(1)</sup>	±2000
	Charged-device model (CDM), per JEDEC specification JESD22-C101 <sup>(2)</sup>	±500

- (1) JEDEC document JEP155 states that 500-V HBM allows safe manufacturing with a standard ESD control process.

- (2) JEDEC document JEP157 states that 250-V CDM allows safe manufacturing with a standard ESD control process.

### 7.3 Recommended Operating Conditions

over operating free-air temperature range (unless otherwise noted)

	MIN	MAX	UNIT
V <sub>IN</sub> Input operating voltage	4.5	18	V
T <sub>J</sub> Junction temperature	-40	125	°C

### 7.4 Thermal Information

THERMAL METRIC <sup>(1)</sup>	TPS65251	UNIT
	RHA (VQFN)	
	40 PINS	
R <sub>θJA</sub> Junction-to-ambient thermal resistance	30	°C/W
R <sub>θJC(top)</sub> Junction-to-case (top) thermal resistance	25.3	°C/W
R <sub>θJB</sub> Junction-to-board thermal resistance	73	°C/W
ψ <sub>JT</sub> Junction-to-top characterization parameter	0.2	°C/W
ψ <sub>JB</sub> Junction-to-board characterization parameter	7.6	°C/W
R <sub>θJC(bot)</sub> Junction-to-case (bottom) thermal resistance	1.9	°C/W

- (1) For more information about traditional and new thermal metrics, see the *Semiconductor and IC Package Thermal Metrics* application report, [SPRA953](#).

## 7.5 Electrical Characteristics

 $T_J = -40^{\circ}\text{C}$  to  $125^{\circ}\text{C}$ ,  $V_{IN} = 12\text{ V}$ ,  $f_{SW} = 1\text{ MHz}$  (unless otherwise noted)

PARAMETER		TEST CONDITIONS	MIN	TYP	MAX	UNIT
<b>INPUT SUPPLY UVLO AND INTERNAL SUPPLY VOLTAGE</b>						
$V_{IN}$	Input Voltage range		4.5		18	V
$IDD_{SDN}$	Shutdown	EN pin = low for all converters		1.3		mA
$IDD_Q$	Quiescent, low-power disabled (Lo)	Converters enabled, no load Buck 1 = 3.3 V, Buck 2 = 2.5 V, Buck 3 = 7.5 V, L = 4.7 $\mu\text{H}$ , $f_{SW} = 800\text{ kHz}$		20		mA
$IDD_{Q\_LOW\_P}$	Quiescent, low-power enabled (Hi)	Converters enabled, no load Buck 1 = 3.3 V, Buck 2 = 2.5 V, Buck 3 = 7.5 V, L = 4.7 $\mu\text{H}$ , $f_{SW} = 800\text{ kHz}$		1.5		mA
$UVLO_{VIN}$	$V_{IN}$ under voltage lockout	Rising $V_{IN}$		4.22		V
		Falling $V_{IN}$		4.1		
$UVLO_{DEGLITCH}$		Both edges		110		$\mu\text{s}$
$V_{3V}$	Internal biasing supply	$I_{LOAD} = 0\text{ mA}$	3.2	3.3	3.4	V
$I_{3V}$	Biasing supply output current	$V_{IN} = 12\text{ V}$			10	mA
$V_{7V}$	Internal biasing supply	$I_{LOAD} = 0\text{ mA}$	5.63	6.25	6.88	V
$I_{7V}$	Biasing supply output current	$V_{IN} = 12\text{ V}$			10	mA
$V7V_{UVLO}$	UVLO for internal V7V rail	Rising V7V		3.8		V
		Falling V7V		3.6		
$V7V_{UVLO\_DEGLITCH}$		Falling edge		110		$\mu\text{s}$
<b>BUCK CONVERTERS (ENABLE CIRCUIT, CURRENT LIMIT, SOFT-START, SWITCHING FREQUENCY AND SYNC CIRCUIT, LOW-POWER MODE)</b>						
$V_{IH}$	Enable threshold high	V3p3 = 3.2 V - 3.4 V, $V_{ENX}$ rising	1.55		1.82	V
	Enable high level	External GPIO, $V_{ENX}$ rising	$0.66 \times V_{3V}$			
$V_{IL}$	Enable threshold low	V3p3 = 3.2 V - 3.4 V, $V_{ENX}$ falling	0.98		1.24	V
	Enable low level	External GPIO, $V_{ENX}$ falling			$0.33 \times V_{3V}$	
$R_{EN\_DIS}$	Enable discharge resistor		-10%	2.1	10%	k $\Omega$
$ICH_{EN}$	Pullup current enable pin			1.1		$\mu\text{A}$
$t_D$	Discharge time enable pins	Power-up		10		ms
$I_{SS}$	Soft-start pin current source			5		$\mu\text{A}$
$F_{SW\_BK}$	Converter switching frequency range	Set externally with resistor	0.3		2.2	MHz
$R_{FSW}$	Frequency setting resistor	Depending on set frequency	50		600	k $\Omega$
$f_{SW\_TOL}$	Internal oscillator accuracy	$f_{SW} = 800\text{ kHz}$	-10%		10%	
$V_{SYNCH}$	External clock threshold high	V3p3 = 3.3 V	1.55			V
$V_{SYNCL}$	External clock threshold Low	V3p3 = 3.3 V			1.24	V
$SYNC_{RANGE}$	Synchronization range		0.2		2.2	MHz
$SYNC_{CLK\_MIN}$	Sync signal minimum duty cycle		40%			
$SYNC_{CLK\_MAX}$	Sync signal maximum duty cycle				60%	
$VIH_{LOW\_P}$	Low-power mode threshold high	V3p3 = 3.3 V, $V_{ENX}$ rising	1.55			V
$VIL_{LOW\_P}$	Low-power mode threshold Low	V3p3 = 3.3 V, $V_{ENX}$ falling	0.98		1.24	V
<b>FEEDBACK, REGULATION, OUTPUT STAGE</b>						
$V_{FB}$	Feedback voltage	$V_{IN} = 12\text{ V}$ , $T_J = 25^{\circ}\text{C}$	-1%	0.8	1%	V
		$V_{IN} = 4.5$ to $18\text{ V}$	-2%	0.8	2%	
$I_{FB}$	Feedback leakage current				50	nA
$t_{ON\_MIN}$	Minimum on-time (current sense blanking)			80	120	ns
$V_{LINEREG}$	Line regulation - DC $\Delta V_{OUT}/\Delta V_{INB}$	$V_{INB} = 4.5$ to $18\text{ V}$ , $I_{OUT} = 1000\text{ mA}$		0.5		% $V_{OUT}$
$V_{LOADREG}$	Load regulation - DC $\Delta V_{OUT}/\Delta I_{OUT}$	$I_{OUT} = 10\%$ - $90\%$ $I_{OUT,MAX}$		0.5		% $V_{OUT}/A$
<b>MOSFET (BUCK 1)</b>						
H.S. Switch	Turn-On resistance high-side FET on CH1	$V_{IN} = 12\text{ V}$ , $T_J = 25^{\circ}\text{C}$		95		m $\Omega$
L.S. Switch	Turn-On resistance low-side FET on CH1	$V_{IN} = 12\text{ V}$ , $T_J = 25^{\circ}\text{C}$		50		m $\Omega$

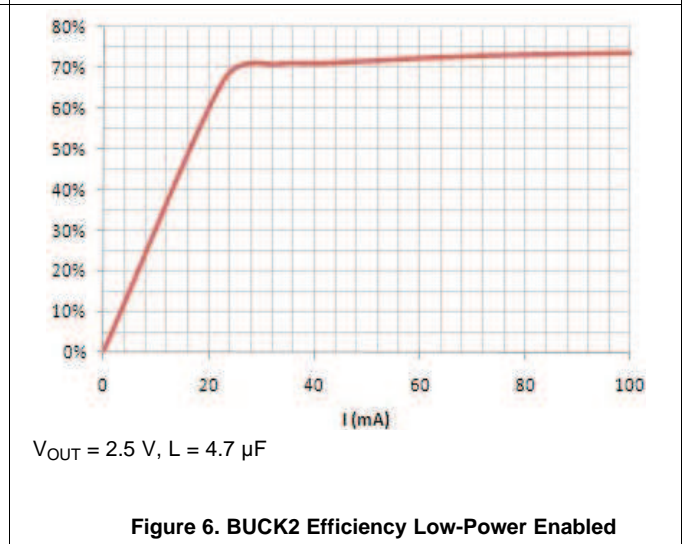
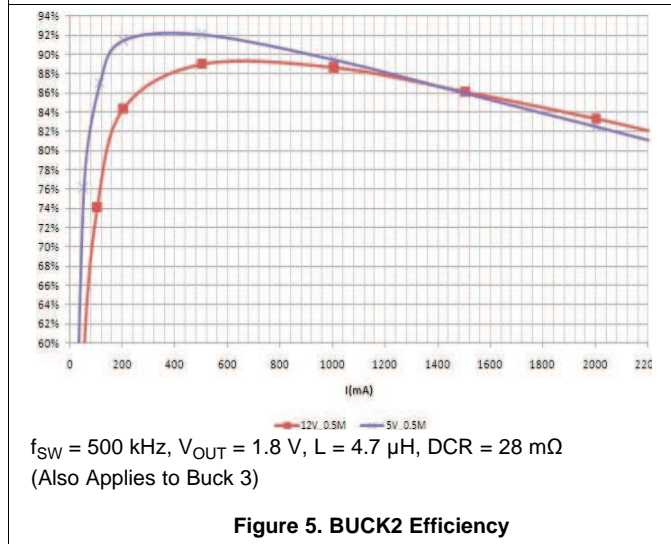
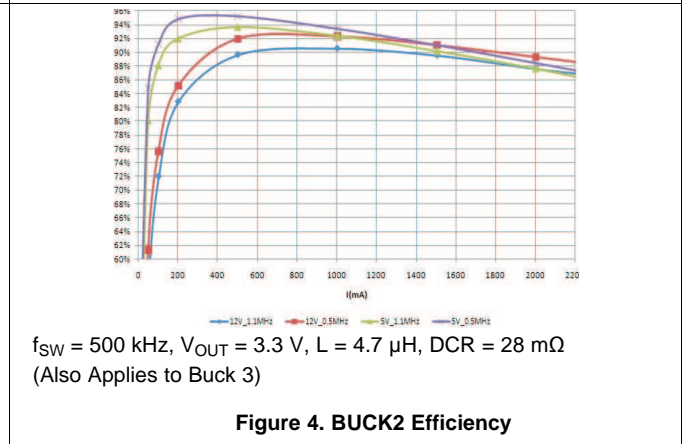
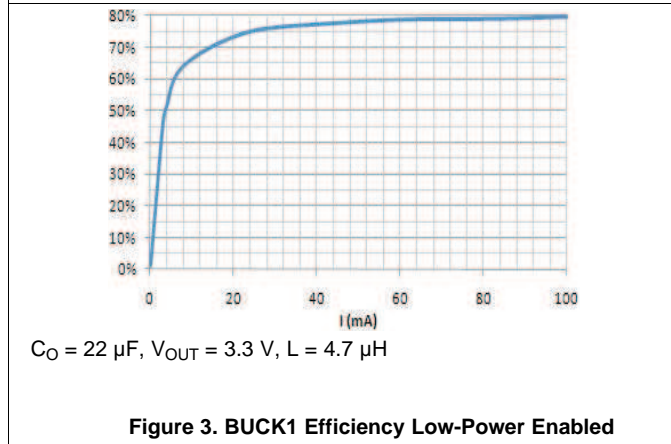
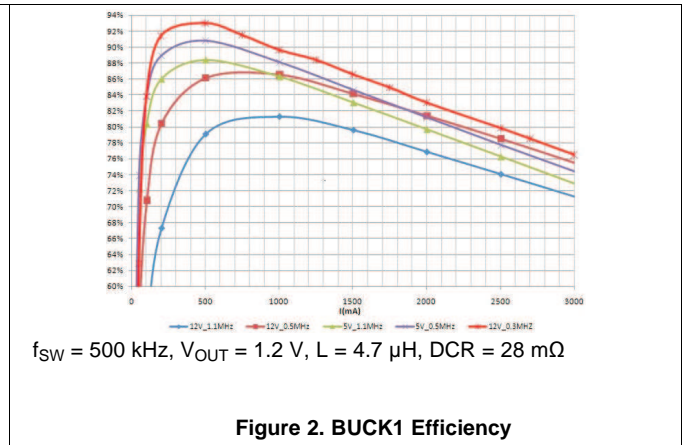
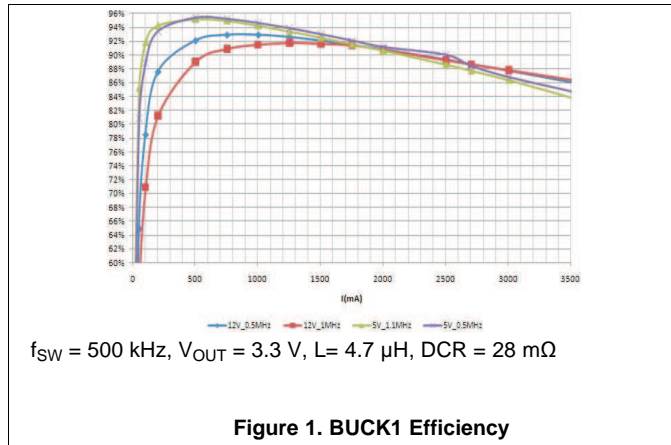
## Electrical Characteristics (continued)

 $T_J = -40^{\circ}\text{C}$  to  $125^{\circ}\text{C}$ ,  $V_{IN} = 12\text{ V}$ ,  $f_{SW} = 1\text{ MHz}$  (unless otherwise noted)

PARAMETER		TEST CONDITIONS	MIN	TYP	MAX	UNIT
<b>MOSFET (BUCK 2)</b>						
H.S. Switch	Turn-On resistance high-side FET on CH2	$V_{IN} = 12\text{ V}$ , $T_J = 25^{\circ}\text{C}$		120		$\text{m}\Omega$
L.S. Switch	Turn-On resistance low-side FET on CH2	$V_{IN} = 12\text{ V}$ , $T_J = 25^{\circ}\text{C}$		80		$\text{m}\Omega$
<b>MOSFET (BUCK 3)</b>						
H.S. Switch	Turn-On resistance high-side FET on CH3	$V_{IN} = 12\text{ V}$ , $T_J = 25^{\circ}\text{C}$		120		$\text{m}\Omega$
L.S. Switch	Turn-On resistance low-side FET on CH3	$V_{IN} = 12\text{ V}$ , $T_J = 25^{\circ}\text{C}$		80		$\text{m}\Omega$
<b>ERROR AMPLIFIER</b>						
$g_M$	Error amplifier transconductance	$-2\ \mu\text{A} < I_{COMP} < 2\ \mu\text{A}$		130		$\mu\text{S}$
$g_{mPS}$	COMP to ILX $g_M$	ILX = 0.5 A		10		A/V
<b>POWERGOOD RESET GENERATOR</b>						
$V_{UV\_BUCKX}$	Threshold voltage for buck under voltage	Output falling (device will be disabled after $t_{ON\_HICCUP}$ )		85%		
		Output rising (PG will be asserted)		90%		
$t_{UV\_deglitch}$	Deglintch time (both edges)	Each buck		11		ms
$t_{ON\_HICCUP}$	Hiccup mode ON time	$V_{UV\_BUCKX}$ asserted		12		ms
$t_{OFF\_HICCUP}$	Hiccup mode OFF time before restart is attempted	All converters disabled. Once $t_{OFF\_HICCUP}$ elapses, all converters will go through sequencing again.		15		ms
$V_{OV\_BUCKX}$	Threshold voltage for buck overvoltage	Output rising (high-side FET will be forced off)		109%		
		Output falling (high-side FET will be allowed to switch)		107%		
$t_{RP}$	Minimum reset period	Measured after minimum reset period of all bucks power-up successfully		1		s
<b>THERMAL SHUTDOWN</b>						
$T_{TRIP}$	Thermal shutdown trip point	Rising temperature		160		$^{\circ}\text{C}$
$T_{HYST}$	Thermal shutdown hysteresis	Device restarts		20		$^{\circ}\text{C}$
$T_{TRIP\_DEGLITCH}$	Thermal shutdown deglitch			110		$\mu\text{s}$
<b>CURRENT LIMIT PROTECTION</b>						
$RLIM_1$	Limit resistance range Buck 1		75		300	$\text{k}\Omega$
$RLIM_{2\&3}$	Limit resistance range Bucks 2 and 3		100		300	$\text{k}\Omega$
$ILIM_1$	Buck 1 adjustable current limit range	$V_{IN} = 12\text{ V}$ , $f_{SW} = 500\text{ kHz}$ , see <a href="#">Figure 17</a>	1.2		5.5	A
$ILIM_2$	Buck 2 adjustable current limit range	$V_{IN} = 12\text{ V}$ , $f_{SW} = 500\text{ kHz}$ , see <a href="#">Figure 18</a>	1		4.1	A
$ILIM_3$	Buck 3 adjustable current limit range	$V_{IN} = 12\text{ V}$ , $f_{SW} = 500\text{ kHz}$ , see <a href="#">Figure 19</a>	1.3		4.4	A

## 7.6 Typical Characteristics

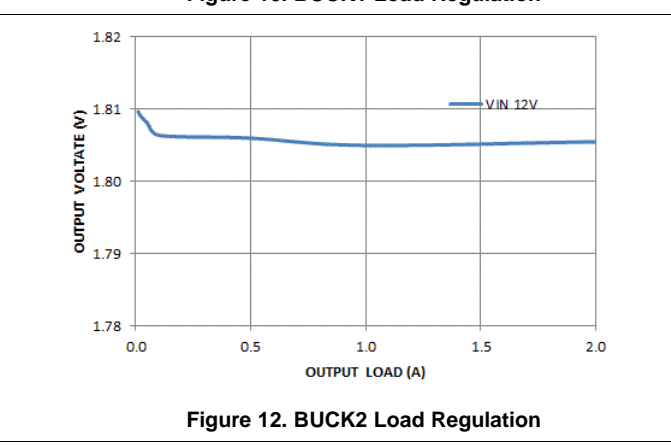
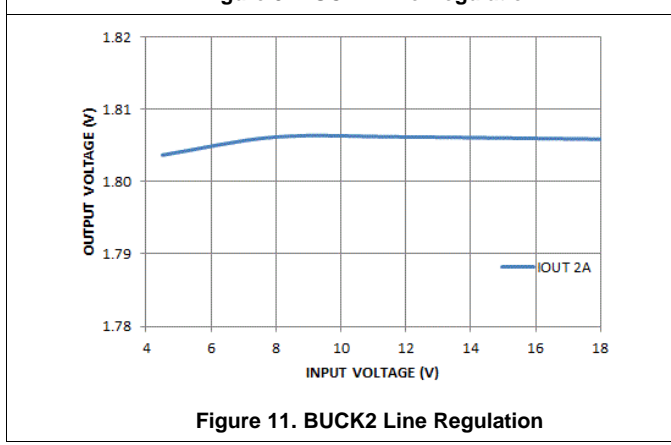
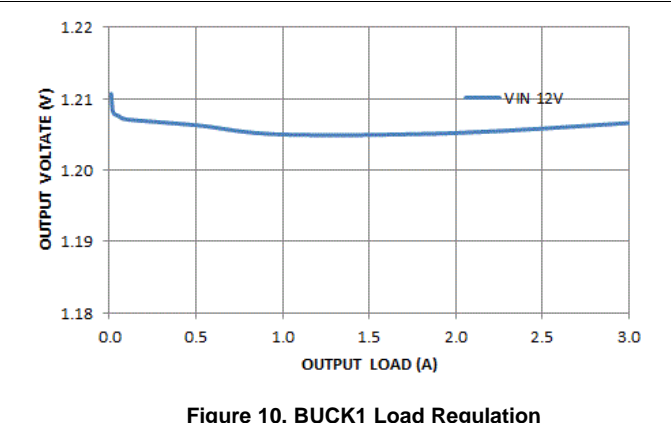
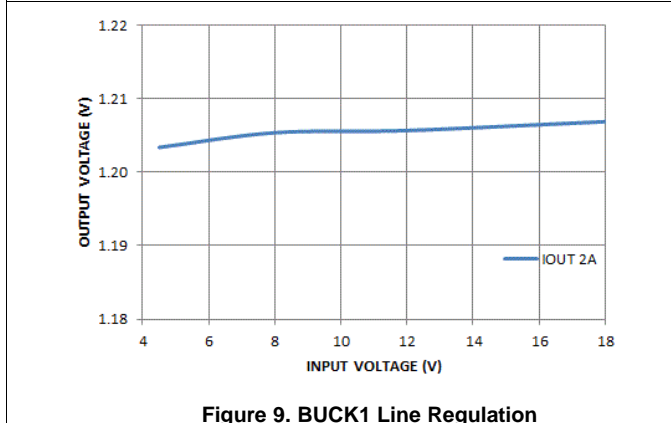
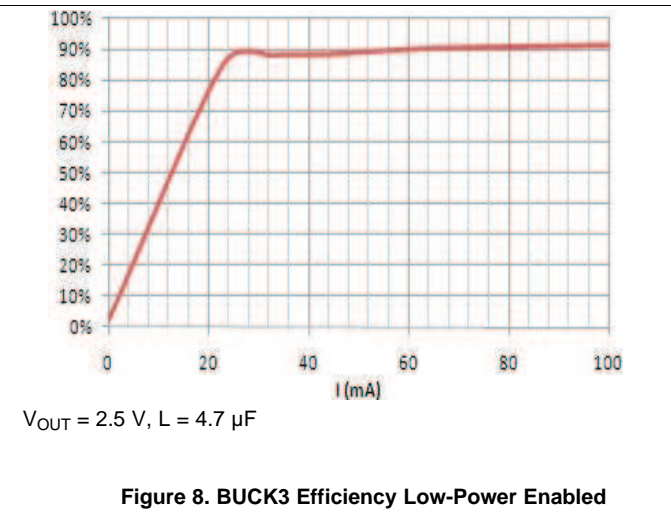
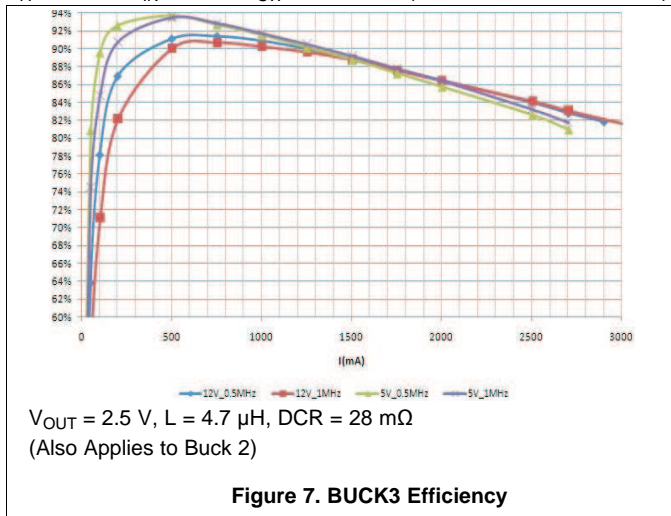
$T_A = 25^\circ\text{C}$ ,  $V_{IN} = 12\text{ V}$ ,  $f_{SW} = 500\text{ kHz}$  (unless otherwise noted)





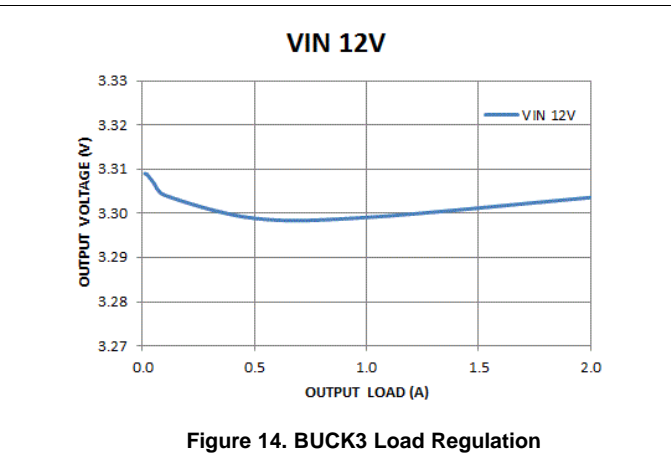
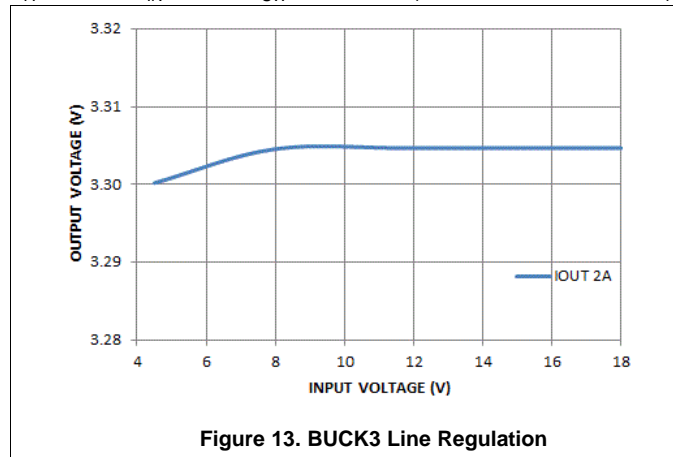
Typical Characteristics (continued)

$T_A = 25^\circ\text{C}$ ,  $V_{IN} = 12\text{ V}$ ,  $f_{SW} = 500\text{ kHz}$  (unless otherwise noted)



**Typical Characteristics (continued)**

$T_A = 25^\circ\text{C}$ ,  $V_{IN} = 12\text{ V}$ ,  $f_{SW} = 500\text{ kHz}$  (unless otherwise noted)



## 8 Detailed Description

### 8.1 Overview

TPS65251 is a power management IC with three step-down buck converters. Both high-side and low-side MOSFETs are integrated to provide fully synchronous conversion with higher efficiency. TPS65251 can support 4.5-V to 18-V input supply, high load current, 300-kHz to 2.2-MHz clocking. The buck converters have an optional PSM mode, which can improve power dissipation during light loads. Alternatively, the device implements a constant frequency mode by connecting the LOW\_P pin to ground. The wide switching frequency of 300 kHz to 2.2 MHz allows for efficiency and size optimization. The switching frequency is adjustable by selecting a resistor to ground on the ROSC pin. The SYNC pin also provides a means to synchronize the power converter to an external signal. Input ripple is reduced by 180 degree out-of-phase operation between Buck 1 and Buck 2. Buck 3 operates in phase with Buck 2.

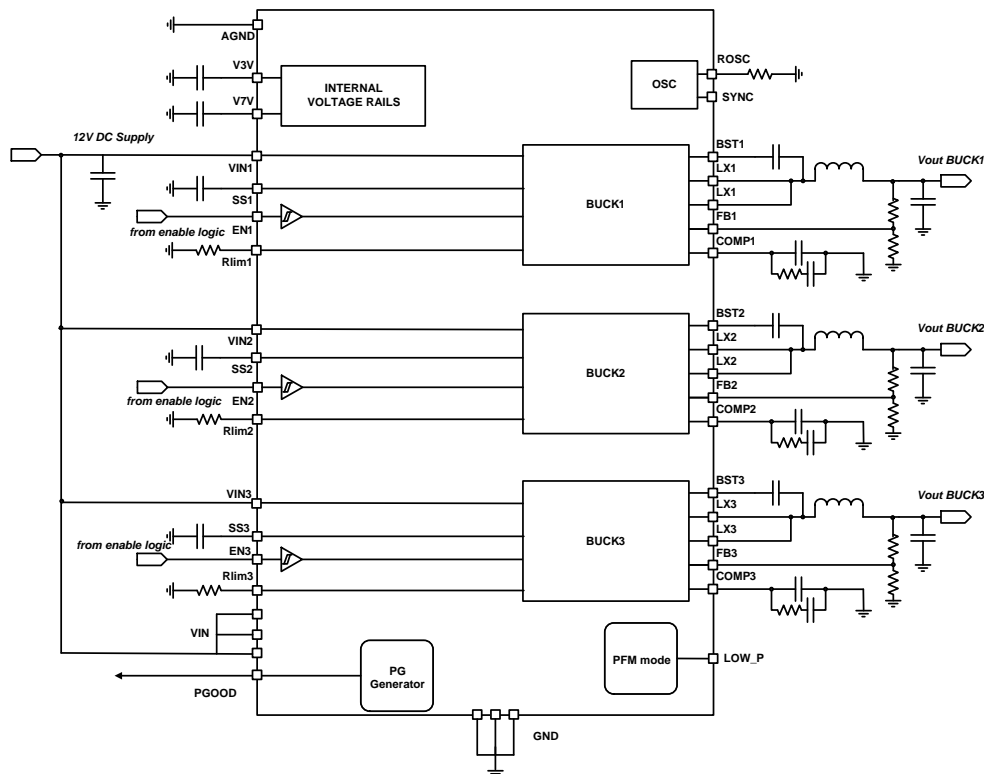
All three buck converters have peak current mode control which simplifies external frequency compensation. A traditional type II compensation network can stabilize the system and achieve fast transient response. Moreover, an optional capacitor in parallel with the upper resistor of the feedback divider provides one more zero and makes the crossover frequency over 100 kHz.

Each buck converter has an individual current limit, which can be set up by a resistor to ground from the RLIM pin. The adjustable current limiting enables high efficiency design with smaller and less expensive inductors.

The device has two built-in LDO regulators. During a standby mode, the 3.3-V LDO and the 6.5-V LDO can be used to drive MCU and other active loads. By this, the system is able to turn off the three buck converters and improve the standby efficiency.

The device has a powergood comparator monitoring the output voltage. Each converter has its own soft-start and enable pins, which provide independent control and programmable soft-start.

### 8.2 Functional Block Diagram

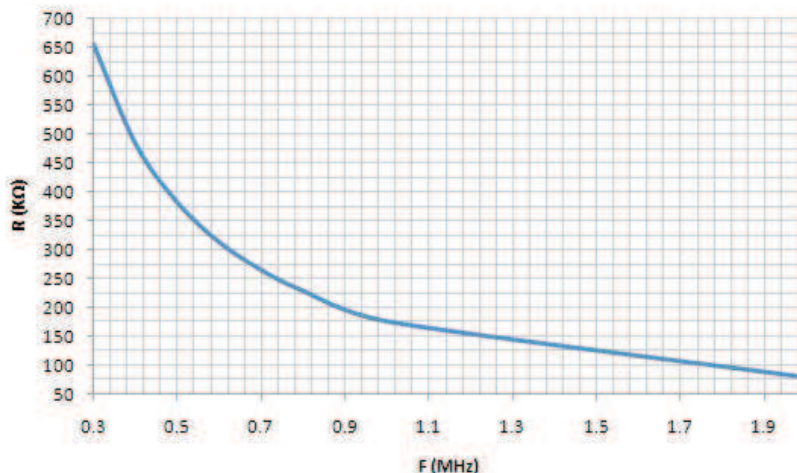


Copyright © 2018, Texas Instruments Incorporated

## 8.3 Feature Description

### 8.3.1 Adjustable Switching Frequency

To select the internal switching frequency connect a resistor from ROOSC to ground. [Figure 15](#) shows the required resistance for a given switching frequency.



**Figure 15. ROOSC vs Switching Frequency**

$$R_{\text{OSC}} (\text{k}\Omega) = 174 \times f (\text{MHz})^{-1.122} \quad (1)$$

For operation at 800 kHz a 230-kΩ resistor is required.

### 8.3.2 Synchronization

The status of the SYNC pin will be ignored during start-up and the TPS65251's control will only synchronize to an external signal after the PGOOD signal is asserted. The status of the SYNC pin will be ignored during start-up and the TPS65251 will only synchronize to an external clock if the PGOOD signal is asserted. When synchronization is applied, the PWM oscillator frequency must be lower than the sync pulse frequency to allow the external signal trumping the oscillator pulse reliably. When synchronization is not applied, the SYNC pin should be connected to ground.

### 8.3.3 Out-of-Phase Operation

Buck 1 has a low conduction resistance compared to Buck 2 and 3. Normally Buck 1 is used to drive higher system loads. Buck 2 and 3 are used to drive some peripheral loads like I/O and line drivers. The combination of loads from Buck 2 and 3 may be on par with the load of Buck 1. To reduce input ripple current, Buck 2 operates in phase with Buck 3; Buck 1 and Buck 2 operate 180° out-of-phase. This enables the system, having less input ripple, to lower component cost, save board space and reduce EMI.

### 8.3.4 Delayed Start-Up

If a delayed start-up is required on any of the buck converters fit a ceramic capacitor to the ENx pins. The delay added is about 1.67 ms per nF connected to the pin. Note that the EN pins have a weak 1-μA pullup to the 3V3 rail.

### 8.3.5 Soft-Start Time

The device has an internal pullup current source of 5 μA that charges an external slow start capacitor to implement a slow start time. [Equation 2](#) shows how to select a slow start capacitor based on an expected slow start time. The voltage reference ( $V_{\text{REF}}$ ) is 0.8 V and the slow start charge current ( $I_{\text{SS}}$ ) is 5 μA. The soft-start circuit requires 1 nF per 200 μs to be connected at the SS pin. A 1-ms soft-start time is implemented for all converters fitting 4.7 nF to the relevant pins.

## Feature Description (continued)

$$t_{SS} \text{ (ms)} = V_{REF} \text{ (V)} \times \left( \frac{C_{SS} \text{ (nF)}}{I_{SS} \text{ (}\mu\text{A)}} \right) \quad (2)$$

### 8.3.6 Adjusting the Output Voltage

The output voltage is set with a resistor divider from the output node to the FB pin. TI recommends to use 1% tolerance or better divider resistors. In order to improve efficiency at light load, start with 40.2 kΩ for the R1 resistor and use the Equation 3 to calculate R2.

$$R2 = R1 \times \left( \frac{0.8 \text{ V}}{V_O - 0.8 \text{ V}} \right) \quad (3)$$

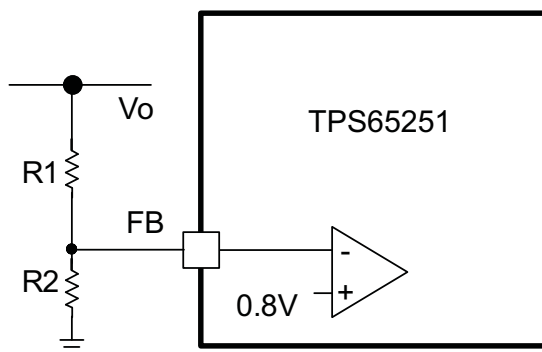


Figure 16. Voltage Divider Circuit

### 8.3.7 Input Capacitor

Use 10-μF X7R/X5R ceramic capacitors at the input of the converter inputs. These capacitors should be connected as close as physically possible to the input pins of the converters.

### 8.3.8 Bootstrap Capacitor

The device has three integrated boot regulators and requires a small ceramic capacitor between the BST and LX pin to provide the gate drive voltage for the high-side MOSFET. The value of the ceramic capacitor should be 0.047 μF. A ceramic capacitor with an X7R or X5R grade dielectric is recommended because of the stable characteristics over temperature and voltage.

### 8.3.9 Error Amplifier

The device has a transconductance error amplifier. The frequency compensation network is connected between the COMP pin and ground.

### 8.3.10 Loop Compensation

TPS65251 is a current mode control DC - DC converter. The error amplifier is a transconductance amplifier with a of 130 μA/V.

### 8.3.11 Slope Compensation

The device has a built-in slope compensation ramp. The slope compensation can prevent subharmonic oscillations in peak current mode control.

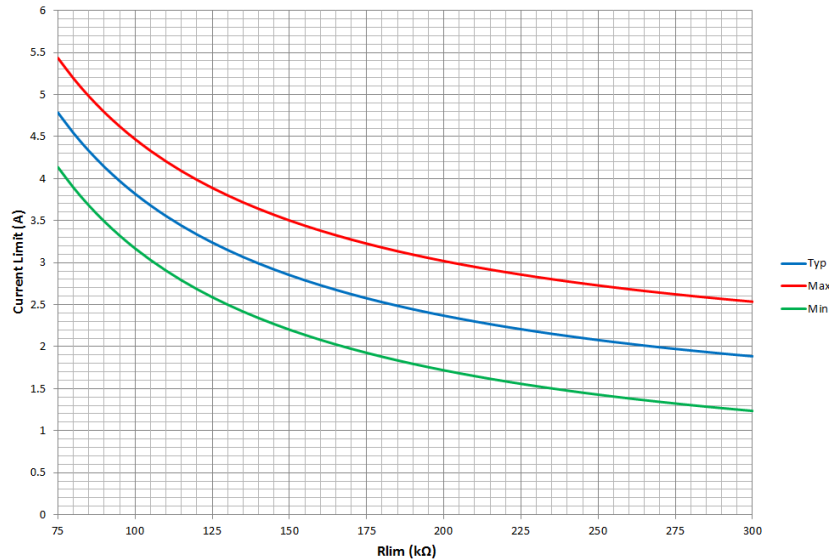
### 8.3.12 Powergood

The PGOOD pin is an open-drain output. The PGOOD pin is pulled low when any buck converter is pulled below 85% of the nominal output voltage. The PGOOD is pulled up when all three buck converters' outputs are more than 90% of its nominal output voltage and reset time of 1 second elapses. The polarity of the PGOOD is active high.

## Feature Description (continued)

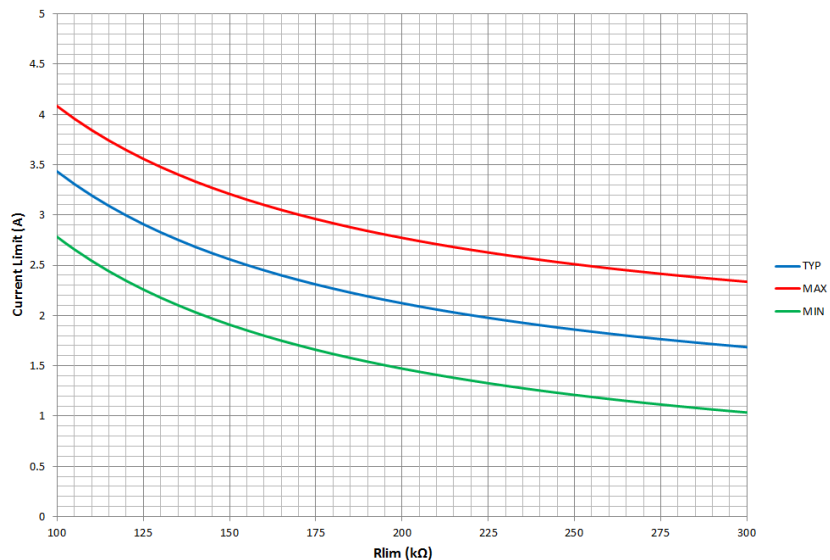
### 8.3.13 Current Limit Protection

Figure 17 shows the (peak) inductor current limit for Buck 1. The typical limit can be approximated with the following graph.



**Figure 17. Buck 1**

Figure 18 shows the (peak) inductor current limit for Buck 2. The typical limit can be approximated with the following graph.



**Figure 18. Buck 2**

Figure 19 shows the (peak) inductor current limit for Buck 3. The typical limit can be approximated with the following graph.

## Feature Description (continued)

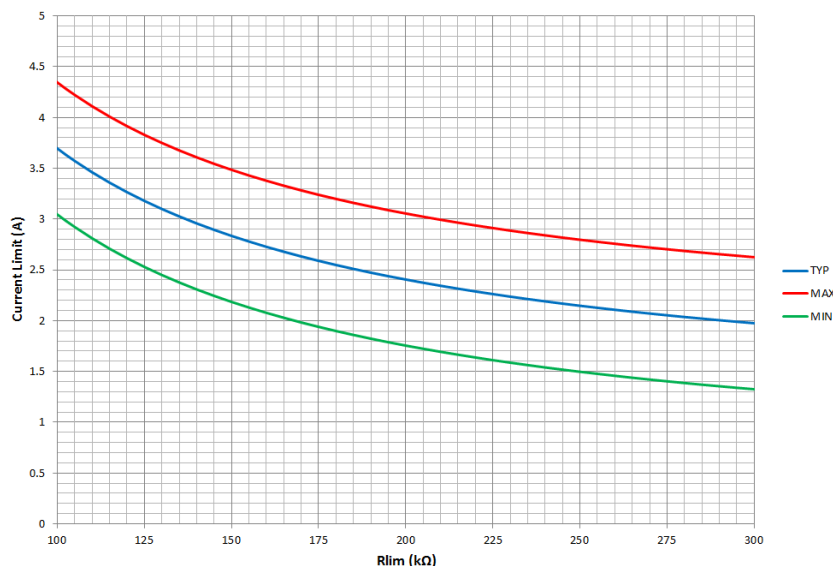


Figure 19. Buck 3

All converters operate in hiccup mode: Once an over-current lasting more than 10 ms is sensed in any of the converters, all the converters will shut down for 10 ms and then the start-up sequencing will be tried again. If the overload has been removed, the converter will ramp up and operate normally. If this is not the case the converter will see another over-current event and shuts-down again repeating the cycle (hiccup) until the failure is cleared.

If an overload condition lasts for less than 10 ms, only the relevant converter affected will go into and out of under-voltage and no global hiccup mode will occur. The converter will be protected by the cycle-by-cycle current limit during that time.

### 8.3.14 Overvoltage Transient Protection

The device incorporates an overvoltage transient protection (OVP) circuit to minimize voltage overshoot. The OVP feature minimizes the output overshoot by implementing a circuit to compare the FB pin voltage to OVP threshold which is 109% of the internal voltage reference. If the FB pin voltage is greater than the OVP threshold, the high-side MOSFET is disabled preventing current from flowing to the output and minimizing output overshoot. When the FB voltage drops below the lower OVP threshold which is 107%, the high-side MOSFET is allowed to turn on the next clock cycle.

### 8.3.15 Thermal Shutdown

The device implements an internal thermal shutdown to protect itself if the junction temperature exceeds 160°C. The thermal shutdown forces the device to stop switching when the junction temperature exceeds thermal trip threshold. Once the die temperature decreases below 140°C, the device reinitiates the power-up sequence. The thermal shutdown hysteresis is 20°C.

## 8.4 Device Functional Modes

### 8.4.1 Low-Power Mode Operation

By pulling the LOW\_P pin high all converters will operate in pulse-skipping mode, greatly reducing the overall power consumption at light and no load conditions. Although each buck converter has a skip comparator that makes sure regulation is not lost when a heavy load is applied and low-power mode is enabled, system design needs to make sure that the LP pin is pulled low for continuous loading in excess of 100 mA.

When low-power is implemented, the peak inductor current used to charge the output capacitor is:

**Device Functional Modes (continued)**

$$I_{LIMIT} = 0.25 \cdot T_{SLEEP\_CLK} \cdot \frac{V_{IN} - V_{OUT}}{L} \quad (4)$$

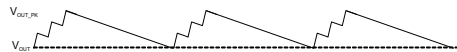
Where  $T_{SLEEP\_CLK}$  is half of the converter switching period,  $2/f_{SW}$ .

The size of the additional ripple added to the output is:

$$\Delta V_{OUT} = \frac{1}{C} \cdot \left( \frac{L \cdot I_{LIMIT}^2}{2} \cdot \frac{V_{IN}}{V_{OUT} \cdot (V_{IN} - V_{OUT})} - \frac{I_{LOAD}}{f_{SLEEP\_CLK}} \right) \quad (5)$$

And the peak output voltage during low-power operation is:

$$V_{OUT\_PK} = V_{OUT} + \frac{\Delta V_{OUT}}{2} \quad (6)$$



**Figure 20. Peak Output Voltage During Low-Power Operation**



## 9 Application and Implementation

### NOTE

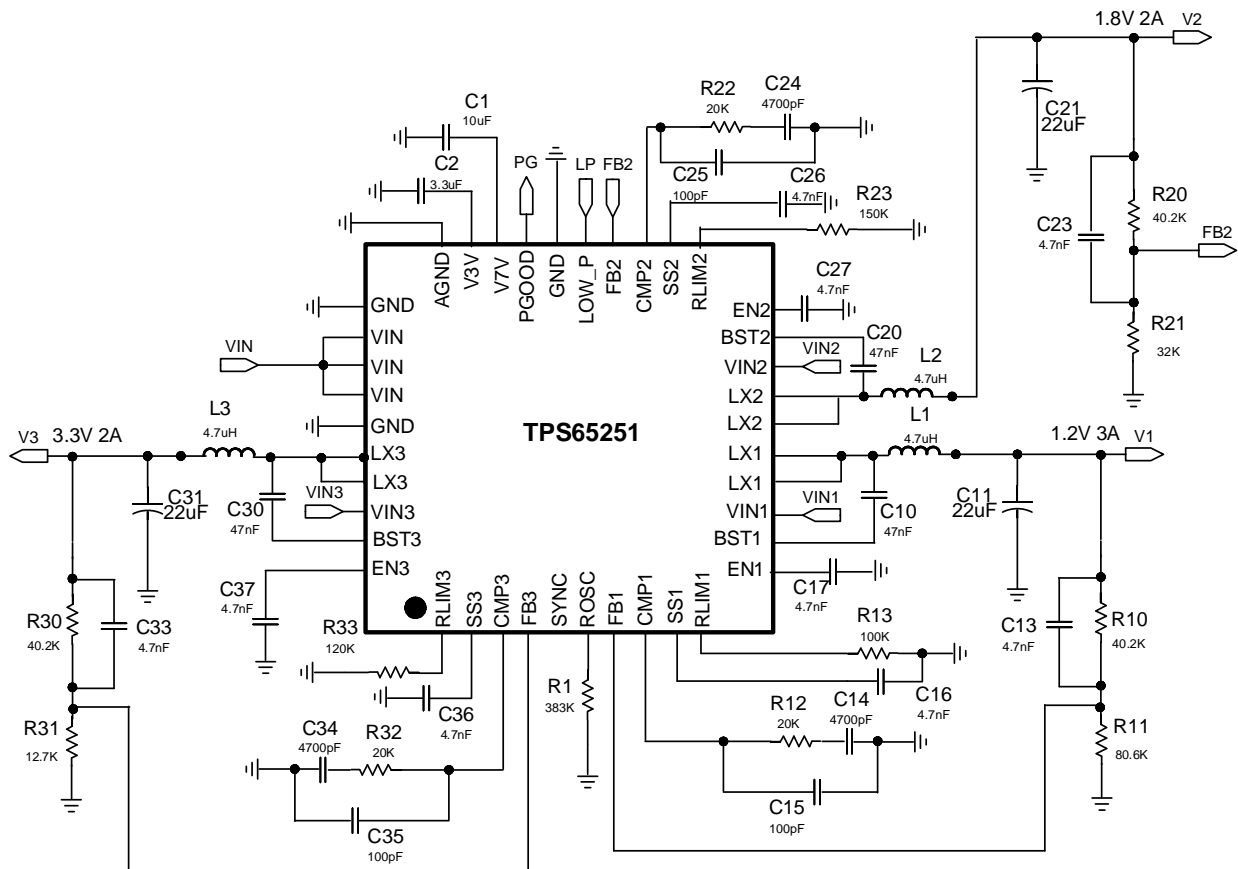
Information in the following applications sections is not part of the TI component specification, and TI does not warrant its accuracy or completeness. TI's customers are responsible for determining suitability of components for their purposes. Customers should validate and test their design implementation to confirm system functionality.

### 9.1 Application Information

The device is triple synchronous step down dc/dc converter. It is typically used to convert a higher dc voltage to lower dc voltages with continuous available output current of 3A/2A/2A.

### 9.2 Typical Application

The following design procedure can be used to select component values for the TPS65251.



Copyright © 2018, Texas Instruments Incorporated

A. VIN pins require local decoupling capacitors.

Figure 21. Typical Application Circuit

#### 9.2.1 Design Requirements

DESIGN PARAMETERS	VALUE
Output voltage	1.2 V
Transient response 0.5-A to 2-A load step	120 mV
Maximum output current	3 A

DESIGN PARAMETERS	VALUE
Input voltage	12 V nom, 9.6 V to 14.4 V
Output voltage ripple	< 30 mV p-p
Switching frequency	500 kHz

## 9.2.2 Detailed Design Procedure

### 9.2.2.1 Loop Compensation Circuit

A typical compensation circuit could be type II ( $R_c$  and  $C_c$ ) to have a phase margin between 60 and 90 degrees, or type III ( $R_c$ ,  $C_c$  and  $C_{roll}$ ) to improve the converter transient response.  $C_{Roll}$  adds a high frequency pole to attenuate high-frequency noise when needed. It may also prevent noise coupling from other rails if there is possibility of cross coupling in between rails when layout is very compact.

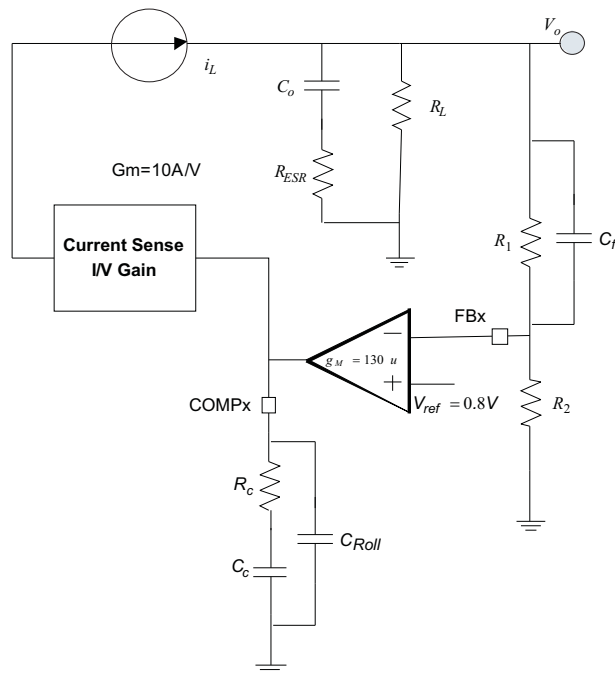


Figure 22. Loop Compensation

To calculate the external compensation components use [Table 1](#):

Table 1. Design Guideline for the Loop Compensation

	TYPE II CIRCUIT	TYPE III CIRCUIT
Select switching frequency that is appropriate for application depending on L, C sizes, output ripple, EMI concerns and etc. Switching frequencies between 500 kHz and 1 MHz give best trade off between performance and cost. When using smaller L and Cs, switching frequency can be increased. To optimize efficiency, switching frequency can be lowered.		Type III circuit recommended for switching frequencies higher than 500 kHz.
Select cross over frequency ( $f_c$ ) to be less than 1/5 to 1/10 of switching frequency.	Suggested $f_c = f_s/10$	Suggested $f_c = f_s/10$
Set and calculate $R_c$ .	$R_c = \frac{2\pi \times f_c \times V_o \times C_o}{g_M \times V_{ref} \times g_{m_{ps}}} \quad (7)$	$R_c = \frac{2\pi \times f_c \times C_o}{g_M \times g_{m_{ps}}} \quad (8)$

**Table 1. Design Guideline for the Loop Compensation (continued)**

	TYPE II CIRCUIT	TYPE III CIRCUIT
Calculate $C_c$ by placing a compensation zero at or before the converter dominant pole $f_p = \frac{1}{C_o \times R_L \times 2\pi} \quad (9)$	$C_c = \frac{R_L \times C_o}{R_c} \quad (10)$	$C_c = \frac{R_L \times C_o}{R_c} \quad (11)$
Add $C_{Roll}$ if needed to remove large signal coupling to high impedance COMP node. Make sure that $f_{pRoll} = \frac{1}{2 \times \pi \times R_c \times C_{Roll}} \quad (12)$ is at least twice the cross over frequency.	$C_{Roll} = \frac{R_{e_{sr}} \times C_o}{R_c} \quad (13)$	$C_{Roll} = \frac{R_{e_{sr}} \times C_o}{R_c} \quad (14)$
Calculate $C_{ff}$ compensation zero at low frequency to boost the phase margin at the crossover frequency. Make sure that the zero frequency ( $f_{zff}$ ) is smaller than soft-start equivalent frequency ( $1/T_{ss}$ ).	NA	$C_{ff} = \frac{1}{2 \times \pi \times f_{zff} \times R_1} \quad (15)$

### 9.2.2.2 Selecting the Switching Frequency

The first step is to decide on a switching frequency for the regulator. Typically, you will want to choose the highest switching frequency possible since this will produce the smallest solution size. The high switching frequency allows for lower valued inductors and smaller output capacitors compared to a power supply that switches at a lower frequency. However, the highest switching frequency causes extra switching losses, which hurt the converter's performance. The converter is capable of running from 300 kHz to 2.2 MHz. Unless a small solution size is an ultimate goal, a moderate switching frequency of 500 kHz is selected to achieve both a small solution size and a high efficiency operation. Using [Figure 15](#),  $R_1$  is determined to be 383 k $\Omega$ .

### 9.2.2.3 Output Inductor Selection

To calculate the value of the output inductor, use [Equation 16](#).  $KIND$  is a coefficient that represents the amount of inductor ripple current relative to the maximum output current. In general,  $KIND$  is normally from 0.1 to 0.3 for the majority of applications.

For this design example, use  $KIND = 0.2$  and the inductor value is calculated to be 3.6  $\mu$ H. For this design, a nearest standard value was chosen: 4.7  $\mu$ H. For the output filter inductor, it is important that the RMS current and saturation current ratings not be exceeded. The RMS and peak inductor current can be found from [Equation 17](#) and [Equation 18](#).

$$L_o = \frac{V_{in} - V_{out}}{I_o \times K_{ind}} \times \frac{V_{out}}{V_{in} \times f_{sw}} \quad (16)$$

$$I_{ripple} = \frac{V_{in} - V_{out}}{L_o} \times \frac{V_{out}}{V_{in} \times f_{sw}} \quad (17)$$

$$I_{Lrms} = \sqrt{I_o^2 + \frac{1}{12} \times \left( \frac{V_o \times (V_{inmax} - V_o)}{V_{inmax} \times L_o \times f_{sw}} \right)^2} \quad (18)$$

$$I_{Lpeak} = I_{out} + \frac{I_{ripple}}{2} \quad (19)$$

### 9.2.2.4 Output Capacitor

There are two primary considerations for selecting the value of the output capacitor. The output capacitors are selected to meet load transient and output ripple's requirements.

[Equation 20](#) gives the minimum output capacitance to meet the transient specification. For this example,  $L_o = 4.7 \mu$ H,  $\Delta I_{OUT} = 1.5 \text{ A} - 0.75 \text{ A} = 0.75 \text{ A}$  and  $\Delta V_{OUT} = 120 \text{ mV}$ . Using these numbers gives a minimum capacitance of 18  $\mu$ F. A standard 22- $\mu$ F ceramic capacitor is chose in the design.

$$C_o > \frac{\Delta I_{OUT}^2 \times L_o}{V_{out} \times \Delta V_{out}} \quad (20)$$

**Equation 21** calculates the minimum output capacitance needed to meet the output voltage ripple specification. Where  $f_{sw}$  is the switching frequency,  $V_{RIPPLE}$  is the maximum allowable output voltage ripple, and  $I_{RIPPLE}$  is the inductor ripple current. In this case, the maximum output voltage ripple is 30 mV. From **Equation 17**, the output current ripple is 0.46 A. From **Equation 21**, the minimum output capacitance meeting the output voltage ripple requirement is 1.74  $\mu\text{F}$ .

$$C_o > \frac{1}{8 \times f_{sw}} \times \frac{1}{\frac{V_{ripple}}{I_{ripple}}} \quad (21)$$

Additional capacitance de-rating for aging, temperature and DC bias should influence this minimum value. For this example, one 22- $\mu\text{F}$ , 6.3-V X7R ceramic capacitor with 3 m $\Omega$  of ESR will be used.

### 9.2.2.5 Input Capacitor

A minimum 10- $\mu\text{F}$  X7R/X5R ceramic input capacitor is recommended to be added between VIN and GND. These capacitors should be connected as close as physically possible to the input pins of the converters as they handle the RMS ripple current shown in **Equation 22**. For this example,  $I_{OUT} = 3 \text{ A}$ ,  $V_{OUT} = 1.2 \text{ V}$ ,  $V_{INmin} = 9.6 \text{ V}$ , from **Equation 22**, the input capacitors must support a ripple current of 0.99 A RMS.

$$I_{cirms} = I_{out} \times \sqrt{\frac{V_{out}}{V_{inmin}} \times \frac{(V_{inmin} - V_{out})}{V_{inmin}}} \quad (22)$$

The input capacitance value determines the input ripple voltage of the regulator. The input voltage ripple can be calculated using **Equation 23**. Using the design example values,  $I_{OUTmax} = 3 \text{ A}$ ,  $C_{IN} = 10 \mu\text{F}$ ,  $f_{SW} = 500 \text{ kHz}$ , yields an input voltage ripple of 150 mV.

$$\Delta V_{in} = \frac{I_{outmax} \times 0.25}{C_{in} \times f_{sw}} \quad (23)$$

### 9.2.2.6 Soft-Start Capacitor

The soft-start capacitor determines the minimum amount of time it will take for the output voltage to reach its nominal programmed value during power-up. This is useful if the output capacitance is very large and would require large amounts of current to quickly charge the capacitor to the output voltage level.

The soft-start capacitor value can be calculated using **Equation 24**. In this example, the converter's soft-start time is 0.8 ms. In TPS65251,  $I_{ss}$  is 5  $\mu\text{A}$  and  $V_{ref}$  is 0.8 V. From **Equation 24**, the soft-start capacitance is 5 nF. A standard 4.7-nF ceramic capacitor is chosen in this design. In this example, C16 is 4.7nF

$$C_{ss}(nF) = \frac{T_{ss}(ms) \times I_{ss}(\mu A)}{V_{ref}(V)} \quad (24)$$

### 9.2.2.7 Bootstrap Capacitor Selection

A 0.047- $\mu\text{F}$  ceramic capacitor must be connected between the BST to LX pin for proper operation. It is recommended to use a ceramic capacitor with X5R or better grade dielectric. The capacitor should have 10-V or higher voltage rating.

### 9.2.2.8 Adjustable Current Limiting Resistor Selection

The converter uses the voltage drop on the high-side MOSFET to measure the inductor current. The over current protection threshold can be optimized by changing the trip resistor. **Figure 17** governs the threshold of over current protection for Buck 1. When selecting a resistor, do not exceed the graph limits. In this example, the over current threshold is 3.2 A. In order to prevent a premature limit trip, the minimum line is used and the resistor is 100 k $\Omega$ .

When setting high-side current limit to large current values, ensure that the additional load immediately prior to an overcurrent condition will not cause the switching node voltage to exceed 20 V. Additionally, ensure during worst case operation, with all bucks loaded immediately prior to current limit, the maximum virtual junction temperature of the device does not exceed 125°C.

### 9.2.2.9 Output Voltage and Feedback Resistors Selection

For the example design, 40.2 kΩ was selected for R10. Vout is 1.2 V, Vref = 0.8 V. Using Equation 25, R11 is calculated as 80.4 kΩ. A standard 80.6-kΩ resistor is chose in this design.

$$R11 = \frac{V_{out} - V_{ref}}{V_{ref}} \times R10 \tag{25}$$

### 9.2.2.10 Compensation

A type-II compensation circuit is adequate for the converter to have a phase margin between 60 and 90 degrees. The following equations show the procedure of designing a peak current mode control dc/dc converter.

The compensation design takes the following steps:

1. Set up the anticipated cross-over frequency. In this example, the anticipated cross-over frequency (fc) is 65 kHz. The power stage gain (gm<sub>PS</sub>) is 10 A/V and the GM amplifier gain (g<sub>M</sub>) is 130 μA/V.

$$R12 = \frac{2\pi \times f_c \times V_o \times C_o}{g_M \times V_{ref} \times g_{m_{ps}}} \tag{26}$$

2. Place compensation zero at low frequency to boost the phase margin at the crossover frequency. From the procedures above, the compensation network includes a 20-kΩ resistor (R12) and a 4700-pF capacitor (C1).
3. An additional pole can be added to attenuate high frequency noise.

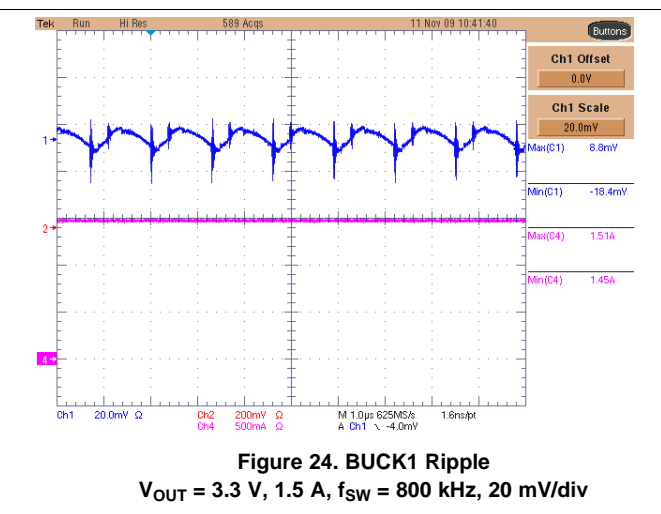
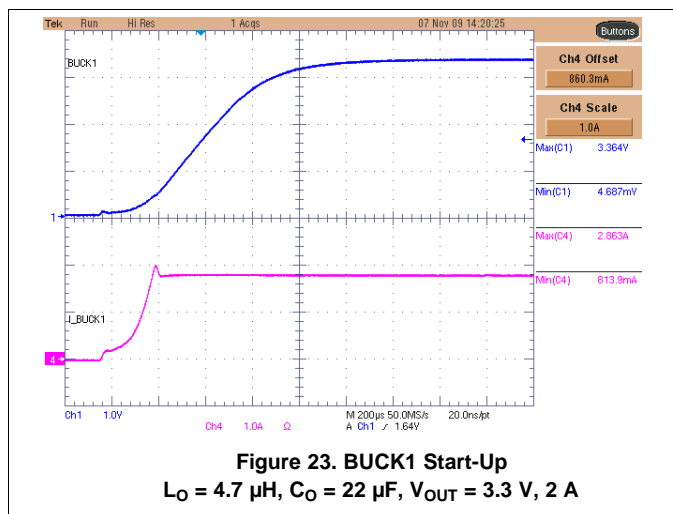
From the procedures above, the compensation network includes a 20-kΩ resistor (R12) and a 4700-pF capacitor (C14).

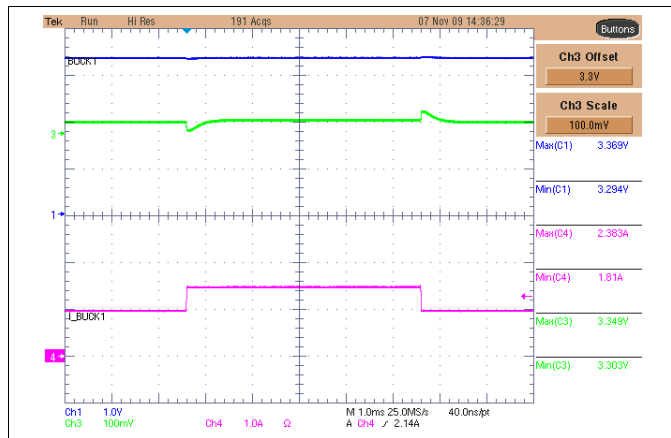
### 9.2.2.11 3.3-V and 6.5-V LDO Regulators

The following ceramic capacitor (X7R/X5R) should be connected as close as possible to the described pins:

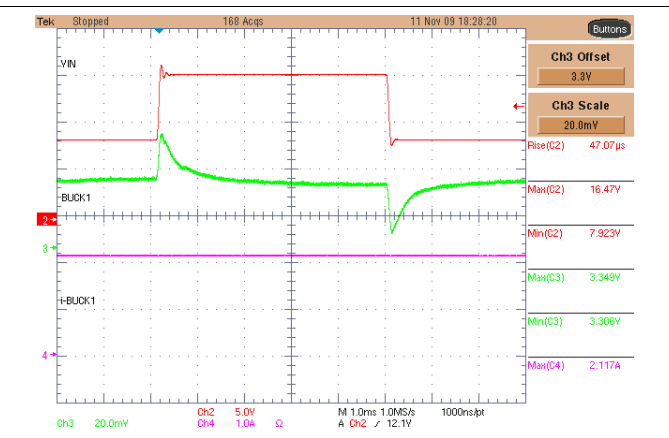
- 10 μF for V7V pin 28
- 3.3 μF to 10 μF for V3V pin 29

## 9.2.3 Application Curves

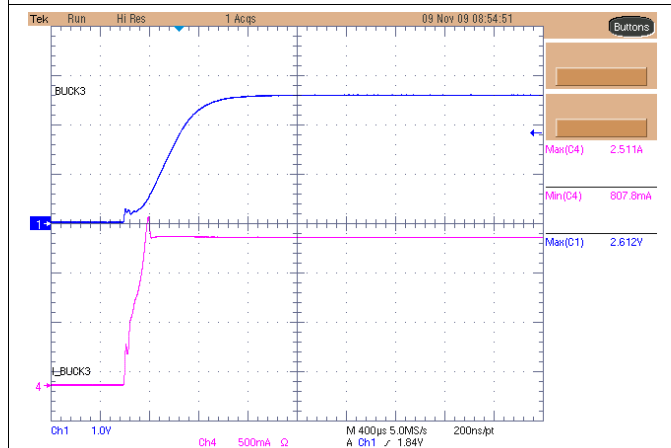




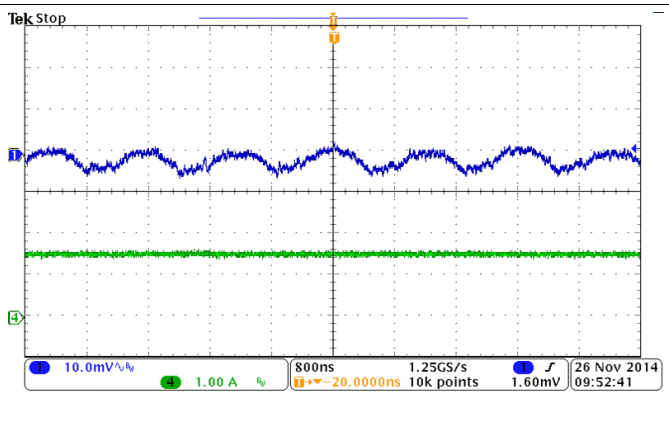
**Figure 25. BUCK1 Transient Load Response**  
 $L_O = 4.7 \mu\text{H}$ ,  $C_O = 22 \mu\text{F}$ ,  $V_{OUT} = 3.3 \text{ V}$ ,  $\Delta I = 1 \text{ A to } 1.5 \text{ A}$ , 100 mV/div



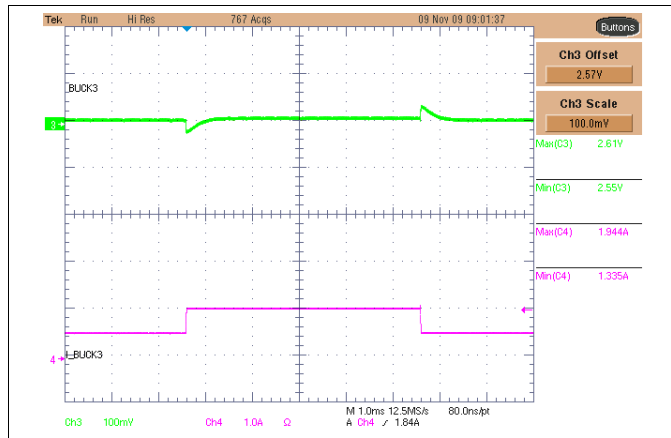
**Figure 26. BUCK1 Transient Supply Response**  
 $L_O = 4.7 \mu\text{H}$ ,  $C_O = 22 \mu\text{F}$ ,  $V_{OUT} = 3.3 \text{ V}$ ,  $\Delta V_{IN} = 8 \text{ V to } 16.5 \text{ V}$ , 20 mV/div



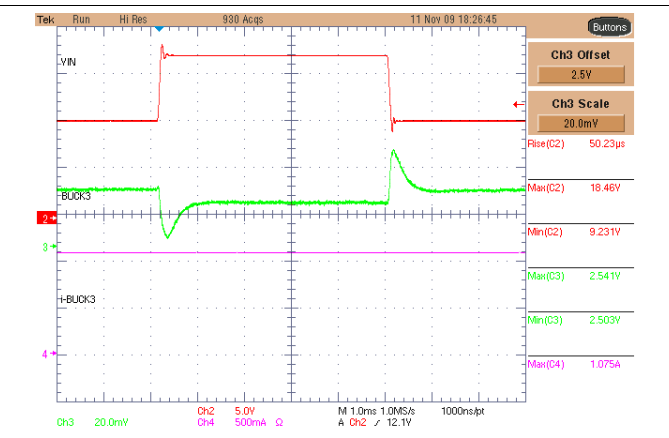
**Figure 27. BUCK2 Start-Up**  
 $L_O = 4.7 \mu\text{H}$ ,  $C_O = 22 \mu\text{F}$ ,  $V_{OUT} = 2.5 \text{ V}$ , 1.5 A



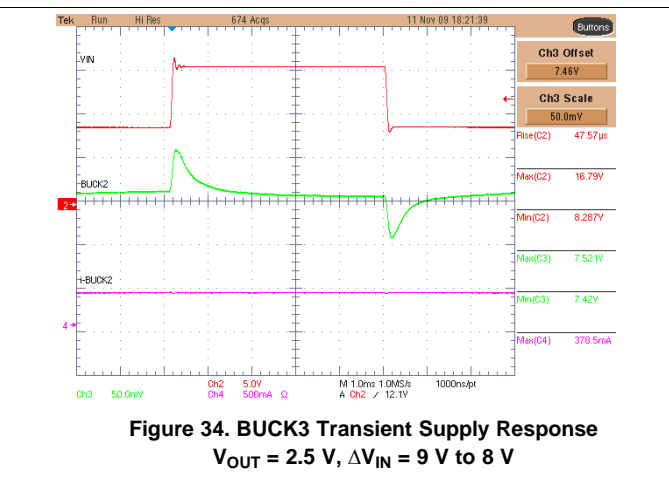
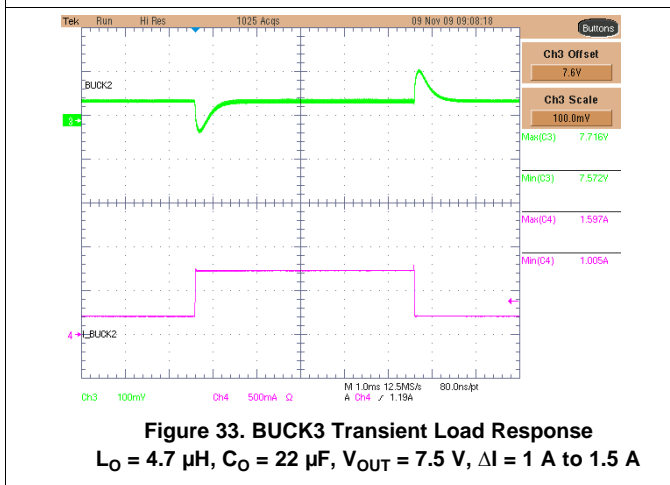
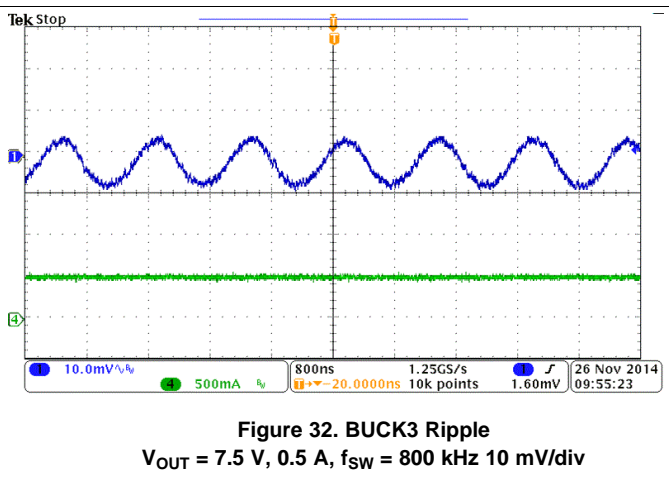
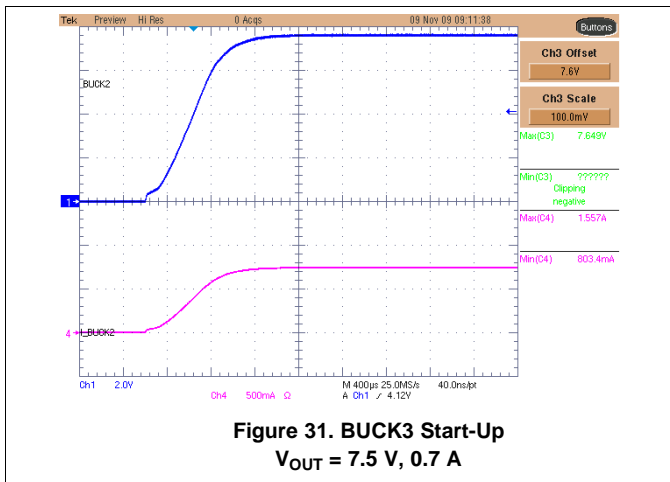
**Figure 28. BUCK2 Ripple**  
 $V_{OUT} = 2.5 \text{ V}$ , 1.5 A,  $f_{SW} = 800 \text{ kHz}$ , 10 mV/div



**Figure 29. BUCK2 Transient Load Response**  
 $L_O = 4.7 \mu\text{H}$ ,  $C_O = 22 \mu\text{F}$ ,  $V_{OUT} = 2.5 \text{ V}$ ,  $\Delta I = 1 \text{ A to } 1.5 \text{ A}$



**Figure 30. BUCK2 Transient Supply Response**  
 $L_O = 4.7 \mu\text{H}$ ,  $C_O = 22 \mu\text{F}$ ,  $V_{OUT} = 2.5 \text{ V}$ ,  $\Delta V_{IN} = 9 \text{ V to } 8 \text{ V}$



## 10 Power Supply Recommendations

The device is designed to operate from an input voltage supply range between 4.5 V and 18 V. This input power supply should be well regulated. If the input supply is located more than a few inches from the TPS65251 converter, additional bulk capacitance may be required in addition to the ceramic bypass capacitors. An electrolytic capacitor with a value of 47  $\mu$ F is a typical choice.

## 11 Layout

### 11.1 Layout Guidelines

Layout is a critical portion of PMIC designs.

- Place VOUT, and LX on the top layer and an inner power plane for VIN.
- Fit also on the top layer connections for the remaining pins of the PMIC and a large top side area filled with ground.
- The top layer ground area should be connected to the internal ground layer(s) using vias at the input bypass capacitor, the output filter capacitor and directly under the TPS65251 device to provide a thermal path from the Powerpad land to ground.
- The AGND pin should be tied directly to the power pad under the IC and the power pad.
- For operation at full rated load, the top side ground area together with the internal ground plane, must provide adequate heat dissipating area.
- There are several signals paths that conduct fast changing currents or voltages that can interact with stray inductance or parasitic capacitance to generate noise or degrade the power supplies performance. To help eliminate these problems, the VIN pin should be bypassed to ground with a low ESR ceramic bypass capacitor with X5R or X7R dielectric. Care should be taken to minimize the loop area formed by the bypass capacitor connections, the VIN pins, and the ground connections. Since the LX connection is the switching node, the output inductor should be located close to the LX pins, and the area of the PCB conductor minimized to prevent excessive capacitive coupling.
- The output filter capacitor ground should use the same power ground trace as the VIN input bypass capacitor. Try to minimize this conductor length while maintaining adequate width.
- The compensation should be as close as possible to the COMP pins. The COMP and OSC pins are sensitive to noise so the components associated to these pins should be located as close as possible to the IC and routed with minimal lengths of trace.



## 11.2 Layout Example

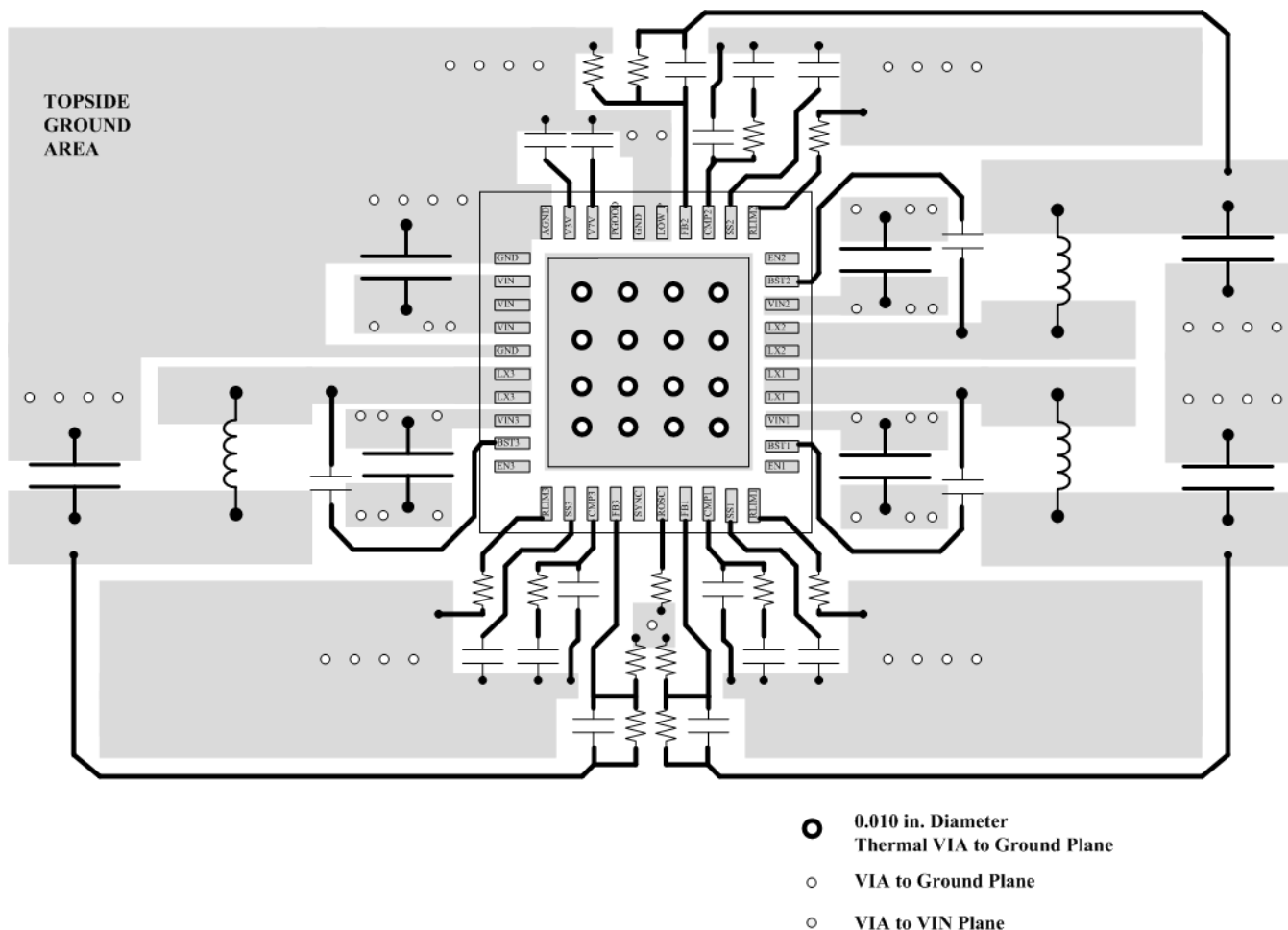


Figure 35. Layout Schematic

## 11.3 Power Dissipation

The total power dissipation inside TPS65251 should not to exceed the maximum allowable junction temperature of 125°C. The maximum allowable power dissipation is a function of the thermal resistance of the package ( $R_{JA}$ ) and ambient temperature.

To calculate the temperature inside the device under continuous loading use the following procedure.

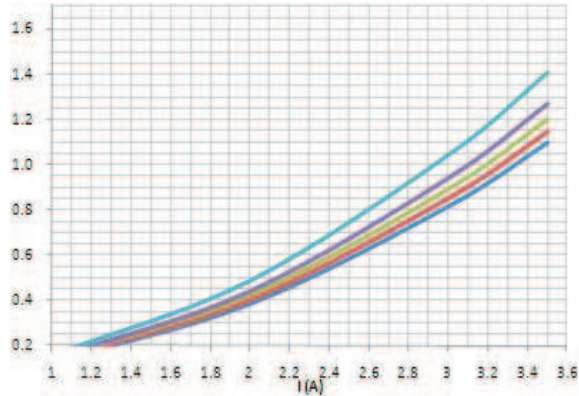
1. Define the set voltage for each converter.
2. Define the continuous loading on each converter. Make sure do not exceed the converter maximum loading.
3. Determine from the graphs below the expected losses (Y axis) in watts per converter inside the device. The losses depend on the input supply, the selected switching frequency, the output voltage and the converter chosen.
4. To calculate the maximum temperature inside the IC use the following formula:

$$T_{HOT\_SPOT} = T_A + P_{DIS} \times R_{\theta JA}$$

where

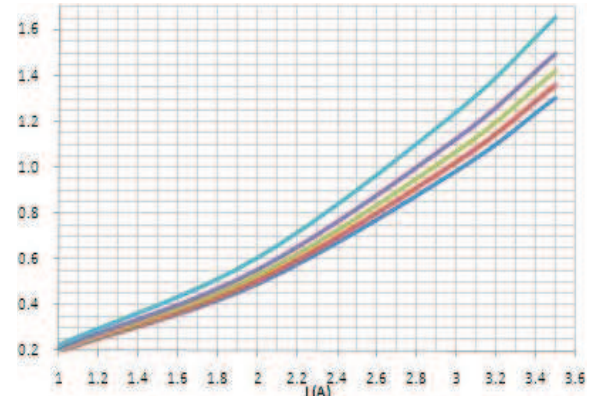
- $T_A$  is the ambient temperature
- $P_{DIS}$  is the sum of losses in all converters
- $\theta_{JA}$  is the junction to ambient thermal impedance of the device and it is heavily dependant on board layout (27)

**Power Dissipation (continued)**



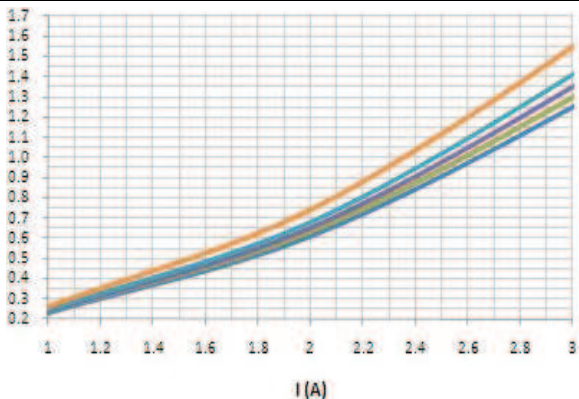
$V_O$  (from top to bottom) = 5 V , 3.3 V, 2.5 V, 1.8 V, 1.2 V

**Figure 36. Buck 1 Losses (W) vs Output Current**  
 $V_{IN} = 12\text{ V}$ ,  $f_{SW} = 500\text{ kHz}$



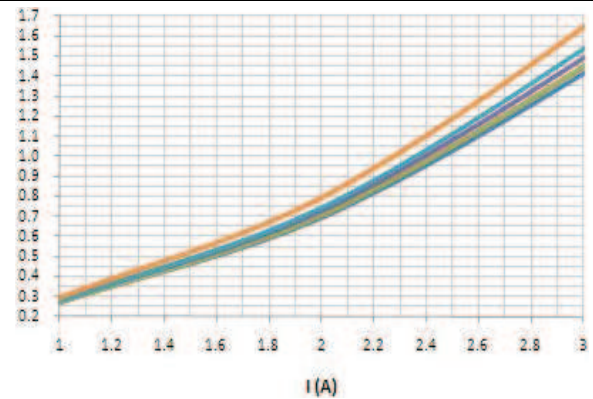
$V_O$  (from top to bottom) = 5 V , 3.3 V, 2.5 V, 1.8 V, 1.2 V

**Figure 37. Buck 1 Losses (W) vs Output Current**  
 $V_{IN} = 12\text{ V}$ ,  $f_{SW} = 1.1\text{ MHz}$



$V_O$  (from top to bottom) = 5 V , 3.3 V, 2.5 V, 1.8 V, 1.2 V

**Figure 38. Buck 2 and 3 Losses (W) vs Output Current**  
 $V_{IN} = 12\text{ V}$ ,  $f_{SW} = 500\text{ kHz}$



$V_O$  (from top to bottom) = 5 V , 3.3 V, 2.5 V, 1.8 V, 1.2 V

**Figure 39. Buck 2 and 3 Losses (W) vs Output Current**  
 $V_{IN} = 12\text{ V}$ ,  $f_{SW} = 1.1\text{ MHz}$

## 12 デバイスおよびドキュメントのサポート

### 12.1 ドキュメントの更新通知を受け取る方法

ドキュメントの更新についての通知を受け取るには、[ti.com](http://ti.com)のデバイス製品フォルダを開いてください。右上の隅にある「通知を受け取る」をクリックして登録すると、変更されたすべての製品情報に関するダイジェストを毎週受け取れます。変更の詳細については、修正されたドキュメントに含まれている改訂履歴をご覧ください。

### 12.2 コミュニティ・リソース

The following links connect to TI community resources. Linked contents are provided "AS IS" by the respective contributors. They do not constitute TI specifications and do not necessarily reflect TI's views; see TI's [Terms of Use](#).

**TI E2E™オンライン・コミュニティ** *TIのE2E (Engineer-to-Engineer) コミュニティ*。エンジニア間の共同作業を促進するために開設されたものです。e2e.ti.comでは、他のエンジニアに質問し、知識を共有し、アイデアを検討して、問題解決に役立てることができます。

**設計サポート** *TIの設計サポート* 役に立つE2Eフォーラムや、設計サポート・ツールをすばやく見つけることができます。技術サポート用の連絡先情報も参照できます。

### 12.3 商標

E2E is a trademark of Texas Instruments.  
All other trademarks are the property of their respective owners.

### 12.4 静電気放電に関する注意事項



これらのデバイスは、限定的なESD(静電破壊)保護機能を内蔵しています。保存時または取り扱い時は、MOSゲートに対する静電破壊を防止するために、リード線同士をショートさせておくか、デバイスを導電フォームに入れる必要があります。

### 12.5 Glossary

[SLYZ022](#) — *TI Glossary*.

This glossary lists and explains terms, acronyms, and definitions.

## 13 メカニカル、パッケージ、および注文情報

以降のページには、メカニカル、パッケージ、および注文に関する情報が記載されています。この情報は、そのデバイスについて利用可能な最新のデータです。このデータは予告なく変更されることがあり、ドキュメントが改訂される場合もあります。本データシートのブラウザ版を使用されている場合は、画面左側の説明をご覧ください。

**PACKAGING INFORMATION**

Orderable part number	Status (1)	Material type (2)	Package   Pins	Package qty   Carrier	RoHS (3)	Lead finish/ Ball material (4)	MSL rating/ Peak reflow (5)	Op temp (°C)	Part marking (6)
905-6525100	Active	Production	VQFN (RHA)   40	2500   LARGE T&R	Yes	NIPDAU	Level-3-260C-168 HR	-40 to 125	TPS 65251
<a href="#">TPS65251RHAR</a>	Active	Production	VQFN (RHA)   40	2500   LARGE T&R	Yes	NIPDAU	Level-3-260C-168 HR	-40 to 125	TPS 65251
TPS65251RHAR.A	Active	Production	VQFN (RHA)   40	2500   LARGE T&R	Yes	NIPDAU	Level-3-260C-168 HR	-40 to 125	TPS 65251
TPS65251RHAR.B	Active	Production	VQFN (RHA)   40	2500   LARGE T&R	Yes	NIPDAU	Level-3-260C-168 HR	-40 to 125	TPS 65251
TPS65251RHARG4	Active	Production	VQFN (RHA)   40	2500   LARGE T&R	Yes	NIPDAU	Level-3-260C-168 HR	-40 to 125	TPS 65251
TPS65251RHARG4.A	Active	Production	VQFN (RHA)   40	2500   LARGE T&R	Yes	NIPDAU	Level-3-260C-168 HR	-40 to 125	TPS 65251
TPS65251RHARG4.B	Active	Production	VQFN (RHA)   40	2500   LARGE T&R	Yes	NIPDAU	Level-3-260C-168 HR	-40 to 125	TPS 65251
<a href="#">TPS65251RHAT</a>	Active	Production	VQFN (RHA)   40	250   SMALL T&R	Yes	NIPDAU	Level-3-260C-168 HR	-40 to 125	TPS 65251
TPS65251RHAT.A	Active	Production	VQFN (RHA)   40	250   SMALL T&R	Yes	NIPDAU	Level-3-260C-168 HR	-40 to 125	TPS 65251
TPS65251RHAT.B	Active	Production	VQFN (RHA)   40	250   SMALL T&R	Yes	NIPDAU	Level-3-260C-168 HR	-40 to 125	TPS 65251

(1) **Status:** For more details on status, see our [product life cycle](#).

(2) **Material type:** When designated, preproduction parts are prototypes/experimental devices, and are not yet approved or released for full production. Testing and final process, including without limitation quality assurance, reliability performance testing, and/or process qualification, may not yet be complete, and this item is subject to further changes or possible discontinuation. If available for ordering, purchases will be subject to an additional waiver at checkout, and are intended for early internal evaluation purposes only. These items are sold without warranties of any kind.

(3) **RoHS values:** Yes, No, RoHS Exempt. See the [TI RoHS Statement](#) for additional information and value definition.

(4) **Lead finish/Ball material:** Parts may have multiple material finish options. Finish options are separated by a vertical ruled line. Lead finish/Ball material values may wrap to two lines if the finish value exceeds the maximum column width.

(5) **MSL rating/Peak reflow:** The moisture sensitivity level ratings and peak solder (reflow) temperatures. In the event that a part has multiple moisture sensitivity ratings, only the lowest level per JEDEC standards is shown. Refer to the shipping label for the actual reflow temperature that will be used to mount the part to the printed circuit board.

(6) **Part marking:** There may be an additional marking, which relates to the logo, the lot trace code information, or the environmental category of the part.

Multiple part markings will be inside parentheses. Only one part marking contained in parentheses and separated by a "~" will appear on a part. If a line is indented then it is a continuation of the previous line and the two combined represent the entire part marking for that device.

**Important Information and Disclaimer:**The information provided on this page represents TI's knowledge and belief as of the date that it is provided. TI bases its knowledge and belief on information provided by third parties, and makes no representation or warranty as to the accuracy of such information. Efforts are underway to better integrate information from third parties. TI has taken and continues to take reasonable steps to provide representative and accurate information but may not have conducted destructive testing or chemical analysis on incoming materials and chemicals. TI and TI suppliers consider certain information to be proprietary, and thus CAS numbers and other limited information may not be available for release.

In no event shall TI's liability arising out of such information exceed the total purchase price of the TI part(s) at issue in this document sold by TI to Customer on an annual basis.

**TAPE AND REEL INFORMATION**

**QUADRANT ASSIGNMENTS FOR PIN 1 ORIENTATION IN TAPE**


\*All dimensions are nominal

Device	Package Type	Package Drawing	Pins	SPQ	Reel Diameter (mm)	Reel Width W1 (mm)	A0 (mm)	B0 (mm)	K0 (mm)	P1 (mm)	W (mm)	Pin1 Quadrant
TPS65251RHAR	VQFN	RHA	40	2500	330.0	16.4	6.3	6.3	1.1	12.0	16.0	Q2
TPS65251RHARG4	VQFN	RHA	40	2500	330.0	16.4	6.3	6.3	1.1	12.0	16.0	Q2
TPS65251RHAT	VQFN	RHA	40	250	180.0	16.4	6.3	6.3	1.1	12.0	16.0	Q2

**TAPE AND REEL BOX DIMENSIONS**


\*All dimensions are nominal

Device	Package Type	Package Drawing	Pins	SPQ	Length (mm)	Width (mm)	Height (mm)
TPS65251RHAR	VQFN	RHA	40	2500	367.0	367.0	38.0
TPS65251RHARG4	VQFN	RHA	40	2500	367.0	367.0	38.0
TPS65251RHAT	VQFN	RHA	40	250	210.0	185.0	35.0

## GENERIC PACKAGE VIEW

**RHA 40**

**VQFN - 1 mm max height**

6 x 6, 0.5 mm pitch

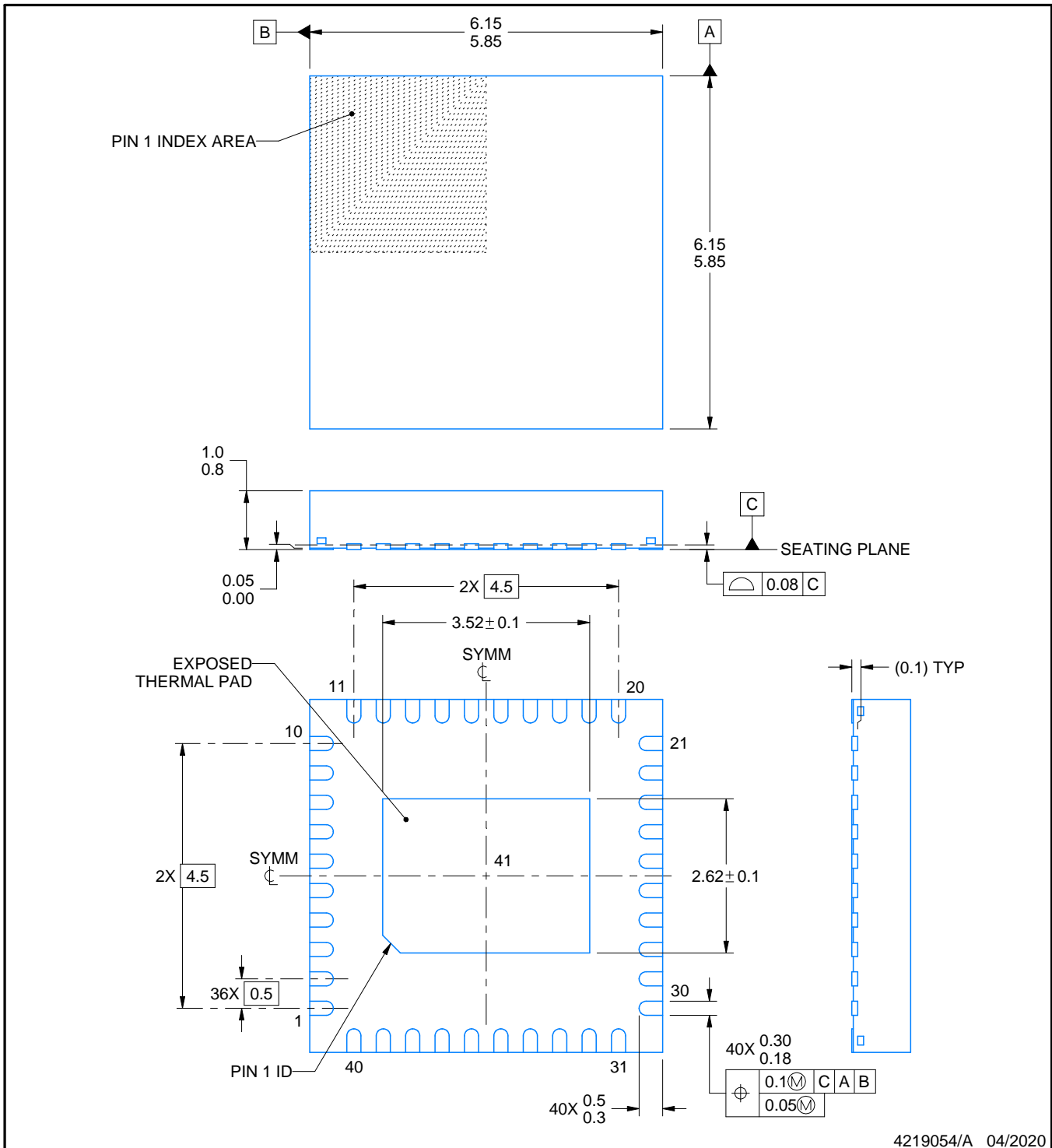
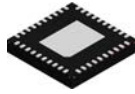
PLASTIC QUAD FLATPACK - NO LEAD

This image is a representation of the package family, actual package may vary.  
Refer to the product data sheet for package details.



4225870/A





4219054/A 04/2020

NOTES:

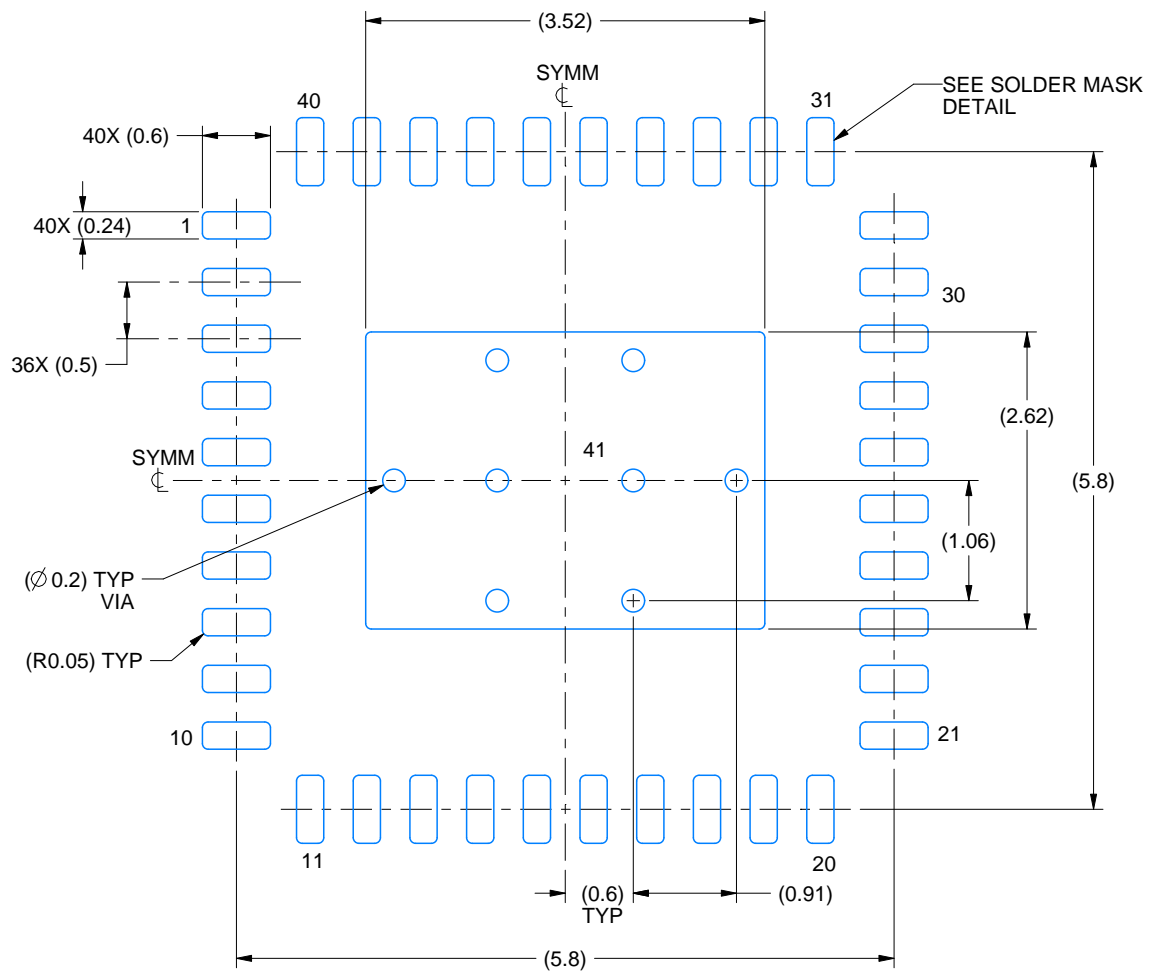
1. All linear dimensions are in millimeters. Any dimensions in parenthesis are for reference only. Dimensioning and tolerancing per ASME Y14.5M.
2. This drawing is subject to change without notice.
3. The package thermal pad must be soldered to the printed circuit board for thermal and mechanical performance.

# EXAMPLE BOARD LAYOUT

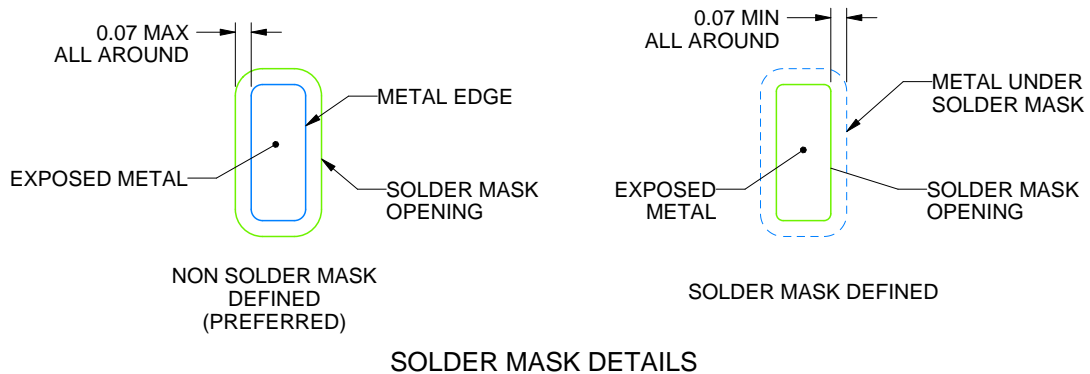
RHA0040E

VQFN - 1 mm max height

PLASTIC QUAD FLATPACK - NO LEAD



LAND PATTERN EXAMPLE  
EXPOSED METAL SHOWN  
SCALE: 15X



4219054/A 04/2020

NOTES: (continued)

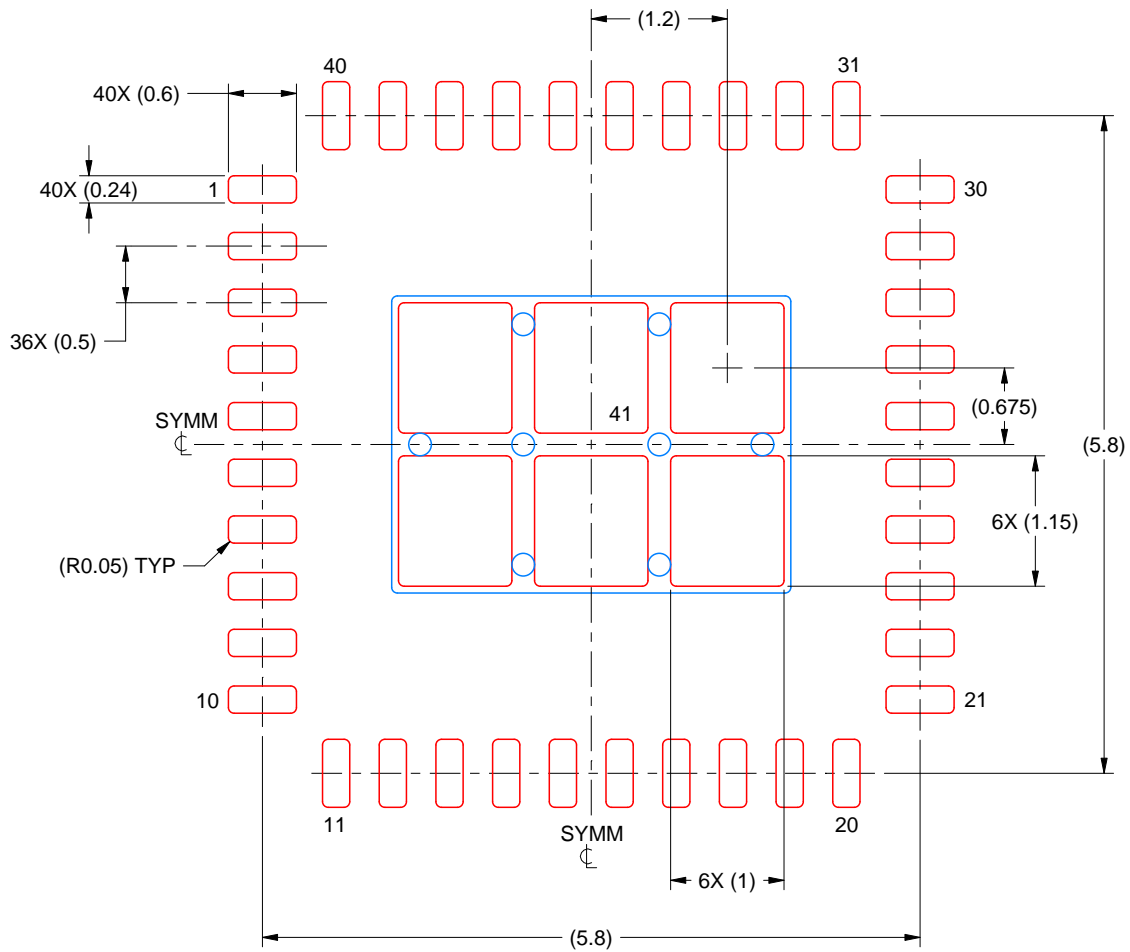
- This package is designed to be soldered to a thermal pad on the board. For more information, see Texas Instruments literature number SLUA271 ([www.ti.com/lit/slua271](http://www.ti.com/lit/slua271)).
- Vias are optional depending on application, refer to device data sheet. If any vias are implemented, refer to their locations shown on this view. It is recommended that vias under paste be filled, plugged or tented.

# EXAMPLE STENCIL DESIGN

RHA0040E

VQFN - 1 mm max height

PLASTIC QUAD FLATPACK - NO LEAD



SOLDER PASTE EXAMPLE  
 BASED ON 0.125 MM THICK STENCIL  
 SCALE: 15X

EXPOSED PAD 41  
 75% PRINTED SOLDER COVERAGE BY AREA UNDER PACKAGE

4219054/A 04/2020

NOTES: (continued)

6. Laser cutting apertures with trapezoidal walls and rounded corners may offer better paste release. IPC-7525 may have alternate design recommendations.

## 重要なお知らせと免責事項

TI は、技術データと信頼性データ(データシートを含みます)、設計リソース(リファレンス デザインを含みます)、アプリケーションや設計に関する各種アドバイス、Web ツール、安全性情報、その他のリソースを、欠陥が存在する可能性のある「現状のまま」提供しており、商品性および特定目的に対する適合性の黙示保証、第三者の知的財産権の非侵害保証を含むいかなる保証も、明示的または黙示的にかかわらず拒否します。

これらのリソースは、TI 製品を使用する設計の経験を積んだ開発者への提供を意図したものです。(1) お客様のアプリケーションに適した TI 製品の選定、(2) お客様のアプリケーションの設計、検証、試験、(3) お客様のアプリケーションに該当する各種規格や、その他のあらゆる安全性、セキュリティ、規制、または他の要件への確実な適合に関する責任を、お客様のみが単独で負うものとし、

上記の各種リソースは、予告なく変更される可能性があります。これらのリソースは、リソースで説明されている TI 製品を使用するアプリケーションの開発の目的でのみ、TI はその使用をお客様に許諾します。これらのリソースに関して、他の目的で複製することや掲載することは禁止されています。TI や第三者の知的財産権のライセンスが付与されている訳ではありません。お客様は、これらのリソースを自身で使用した結果発生するあらゆる申し立て、損害、費用、損失、責任について、TI およびその代理人を完全に補償するものとし、TI は一切の責任を拒否します。

TI の製品は、[TI の販売条件](#)、[TI の総合的な品質ガイドライン](#)、[ti.com](#) または TI 製品などに関連して提供される他の適用条件に従い提供されます。TI がこれらのリソースを提供することは、適用される TI の保証または他の保証の放棄の拡大や変更を意味するものではありません。TI がカスタム、またはカスタマー仕様として明示的に指定していない限り、TI の製品は標準的なカタログに掲載される汎用機器です。

お客様がいかなる追加条項または代替条項を提案する場合も、TI はそれらに異議を唱え、拒否します。

Copyright © 2025, Texas Instruments Incorporated

最終更新日：2025 年 10 月