

# CC2651P3 SimpleLink™ シングルプロトコル 2.4GHz ワイヤレス MCU、 パワー・アンプ内蔵

## 1 特長

### ワイヤレス・マイクロコントローラ

- 強力な 48MHz Arm® Cortex®-M4 プロセッサ
- 352KB フラッシュ・プログラム・メモリ
- 32KB の超低リーク SRAM
- 8KB のキャッシュ SRAM (汎用 RAM としても使用可能)
- プログラマブルな無線機能には、2-(G)FSK、4-(G)FSK、MSK、Bluetooth® 5.2 Low Energy、IEEE 802.15.4 PHY、MAC のサポートが含まれます。
- OTA (Over-The-Air) アップグレードに対応

### 低い消費電力

- MCU の消費電流:
  - 2.91mA (アクティブ・モード、CoreMark®)
  - 61µA/MHz (CoreMark 実行中)
  - 0.8µA (スタンバイ・モード、RTC、32KB RAM)
  - 0.1µA (シャットダウン・モード、ウェークアップ・オン・ピン)
- 無線の消費電流:
  - 6.4mA (RX)
  - 7.1mA (TX、0dBm)
  - 9.5mA (TX、+5dBm)
  - 22mA (TX、+10dBm)
  - 101mA (TX、+20dBm、7x7 パッケージ)

### 無線プロトコルのサポート

- Zigbee®
- Bluetooth® 5.2 Low Energy
- SimpleLink™ TI 15.4 スタック
- 独自システム

### 高性能の無線

- 104dBm (Bluetooth® Low Energy、125kbps)
- 温度補償付きで最大 +20dBm の出力電力

### 法規制の順守

- 以下の規格への準拠を目的としたシステムに最適:
  - ETSI EN 300 328、EN 300 440 Cat.2 および 3
  - FCC CFR47 Part 15
  - ARIB STD-T66

### MCU のペリフェラル

- デジタル・ペリフェラルを任意の GPIO に接続可能
- 4 つの 32 ビットまたは 8 つの 16 ビット汎用タイマ
- 12 ビット ADC、200k サンプル/秒、8 チャンネル
- 8 ビット DAC
- アナログ・コンパレータ
- UART、SSI、I<sup>2</sup>C、I<sup>2</sup>S
- リアルタイム・クロック (RTC)
- 温度およびバッテリー・モニタを内蔵

### セキュリティを実現する機能

- AES 128 ビット暗号化アクセラレータ
- 真性乱数生成器 (TRNG)
- その他の暗号化ドライバをソフトウェア開発キット (SDK) で利用可能

### 開発ツールとソフトウェア

- LP-CC2651P3 開発キット
- SimpleLink™ CC13xx および CC26xx ソフトウェア開発キット (SDK)
- SmartRF™ Studio による容易な無線構成
- SysConfig システム・コンフィギュレーション・ツール

### 動作範囲

- オンチップの降圧型 DC/DC コンバータ
- 1.8V~3.8V のシングル電源電圧
- 40~+105°C

### パッケージ

- 7mm × 7mm RGZ VQFN48 (26GPIO)
- 5mm × 5mm RKP VQFN40 (18GPIO)
- RoHS 準拠のパッケージ



## 2 アプリケーション

- 2400～2500MHz の ISM および SRD システム<sup>1</sup> (最小 4kHz の受信帯域幅)
- ビル・オートメーション
  - ビル・セキュリティ・システム – モーション検出器、電子スマート・ロック、ドアおよび窓センサ、ガレージ・ドア・システム、ゲートウェイ
  - HVAC – サーモスタット、ワイヤレス環境センサ、HVAC システム・コントローラ、ゲートウェイ
  - 防火システム – 煙および熱感知器、火災警報制御パネル (FACP)
  - ビデオ監視 – IP ネットワーク・カメラ
  - エレベータとエスカレータ – エレベータおよびエスカレータのためのエレベータ・メイン制御パネル
- 産業用輸送 – アセット・トラッキング
- ファクトリ・オートメーションおよび制御
- 医療用
- 電子 POS (EPOS) – 電子棚札 (ESL)
- 通信機器
  - 有線ネットワーク – 無線 LAN または Wi-Fi アクセス・ポイント、エッジ・ルータ、小規模企業向けルータ
- パーソナル・エレクトロニクス
  - ホーム・シアターおよびエンターテインメント – スマート・スピーカ、スマート・ディスプレイ、セット・トップ・ボックス
  - ウェアラブル (非医療用) – スマート・トラッカー、スマート衣料

## 3 説明

この SimpleLink™ CC2651P3 デバイスは、ZigBee®、Bluetooth®5.2 Low Energy、IEEE 802.15.4g、TI 15.4-スタック (2.4GHz) をサポートするシングル・プロトコル 2.4GHz ワイヤレス・マイクロコントローラです。CC2651P3 は、Arm® Cortex® M4 メイン・プロセッサをベースにしており、グリッド・インフラストラクチャ、ビル・オートメーション、リテール・オートメーション、パーソナル・エレクトロニクス、医療用アプリケーションの低消費電力の無線通信および高度なセンシングに最適化されています。

CC2651P3 は、Arm® Cortex® M0 で実行するソフトウェア無線を内蔵しているため、各種の物理層と RF 規格をサポートできます。本デバイスは、2360～2500MHz の周波数帯域での動作をサポートしています。CC2651P3 は、+10dBm TX (21mA) または +20dBm TX (101mA) (7x7 パッケージ) をサポートする高効率 PA を内蔵しています。CC2651P3 CC2651R3 は -104dBm (125kbps の Bluetooth® Low Energy Coded PHY) の受信感度を実現しています。

CC2651P3 は 0.8µA という低いスリープ電流 (RTC 動作、32KB RAM を保持) を実現しています。

多くのお客様の 10～15 年またはそれ以上の長いライフ・サイクル要件に沿って、TI は、製品寿命と製品供給の継続性を約束する製品ライフ・サイクル・ポリシーを制定しています。

CC2651P3 デバイスは SimpleLink™ MCU プラットフォームの一部です。このプラットフォームは Wi-Fi®, Bluetooth® Low Energy、Thread、Zigbee、Wi-SUN®, Amazon Sidewalk、mioty、Sub-1GHz MCU、ホスト MCU で構成されます。CC2651P3 CC2651R3 は、32KB～704KB のフラッシュ・サイズに対応し、ピン互換パッケージを選択可能なスクレーラブルなポートフォリオの一部です。共通の SimpleLink™ CC13xx および CC26xx ソフトウェア開発キット (SDK) と SysConfig システム・コンフィギュレーション・ツールは、ポートフォリオ内のデバイス間の移行を支援します。多数のソフトウェア・スタック、アプリケーション例、SimpleLink™ Academy トレーニング・セッションが本 SDK に含まれます。詳細については、ワイヤレス・コネクティビティ製品をご覧ください。

### 製品情報

部品番号 <sup>(1)</sup>	パッケージ	本体サイズ (公称)
CC2651P31T0RGZR	VQFN (48)	7.00mm × 7.00mm
CC2651P31T0RKPR	VQFN (40)	5.00mm × 5.00mm

(1) 提供中の全デバイスに関する最新の製品、パッケージ、および注文情報については、セクション 12 のパッケージ・オプションに関する付録、または TI Web サイトを参照してください。

<sup>1</sup> サポートしているプロトコル規格、変調フォーマット、データ・レートの詳細については、RF コアを参照してください。

## 4 機能ブロック図



図 4-1. CC2651P3 機能ブロック図

## Table of Contents

<b>1 特長</b> .....	1	8.15 Peripheral Characteristics.....	25
<b>2 アプリケーション</b> .....	2	8.16 Typical Characteristics.....	31
<b>3 説明</b> .....	2	<b>9 Detailed Description</b> .....	39
<b>4 機能ブロック図</b> .....	3	9.1 Overview.....	39
<b>5 Revision History</b> .....	4	9.2 System CPU.....	39
<b>6 Device Comparison</b> .....	5	9.3 Radio (RF Core).....	40
<b>7 Pin Configuration and Functions</b> .....	6	9.4 Memory.....	41
7.1 Pin Diagram – RGZ Package (Top View).....	6	9.5 Cryptography.....	42
7.2 Signal Descriptions – RGZ Package.....	7	9.6 Timers.....	43
7.3 Pin Diagram – RKP Package (Top View).....	9	9.7 Serial Peripherals and I/O.....	44
7.4 Signal Descriptions – RKP Package.....	9	9.8 Battery and Temperature Monitor.....	44
7.5 Connections for Unused Pins and Modules.....	11	9.9 $\mu$ DMA.....	44
<b>8 Specifications</b> .....	12	9.10 Debug.....	44
8.1 Absolute Maximum Ratings.....	12	9.11 Power Management.....	45
8.2 ESD Ratings.....	12	9.12 Clock Systems.....	46
8.3 Recommended Operating Conditions.....	12	9.13 Network Processor.....	46
8.4 Power Supply and Modules.....	12	<b>10 Application, Implementation, and Layout</b> .....	47
8.5 Power Consumption - Power Modes.....	13	10.1 Reference Designs.....	47
8.6 Power Consumption - Radio Modes.....	14	<b>11 Device and Documentation Support</b> .....	48
8.7 Nonvolatile (Flash) Memory Characteristics.....	14	11.1 Device Nomenclature.....	48
8.8 Thermal Resistance Characteristics.....	14	11.2 Tools and Software.....	49
8.9 RF Frequency Bands.....	15	11.3 Documentation Support.....	51
8.10 Bluetooth Low Energy - Receive (RX).....	16	11.4 サポート・リソース.....	51
8.11 Bluetooth Low Energy - Transmit (TX).....	19	11.5 Trademarks.....	51
8.12 Zigbee - IEEE 802.15.4-2006 2.4 GHz (OQPSK DSSS1:8, 250 kbps) - RX.....	20	11.6 Electrostatic Discharge Caution.....	52
8.13 Zigbee - IEEE 802.15.4-2006 2.4 GHz (OQPSK DSSS1:8, 250 kbps) - TX.....	21	11.7 Glossary.....	52
8.14 Timing and Switching Characteristics.....	22	<b>12 Mechanical, Packaging, and Orderable Information</b> .....	53

## 5 Revision History

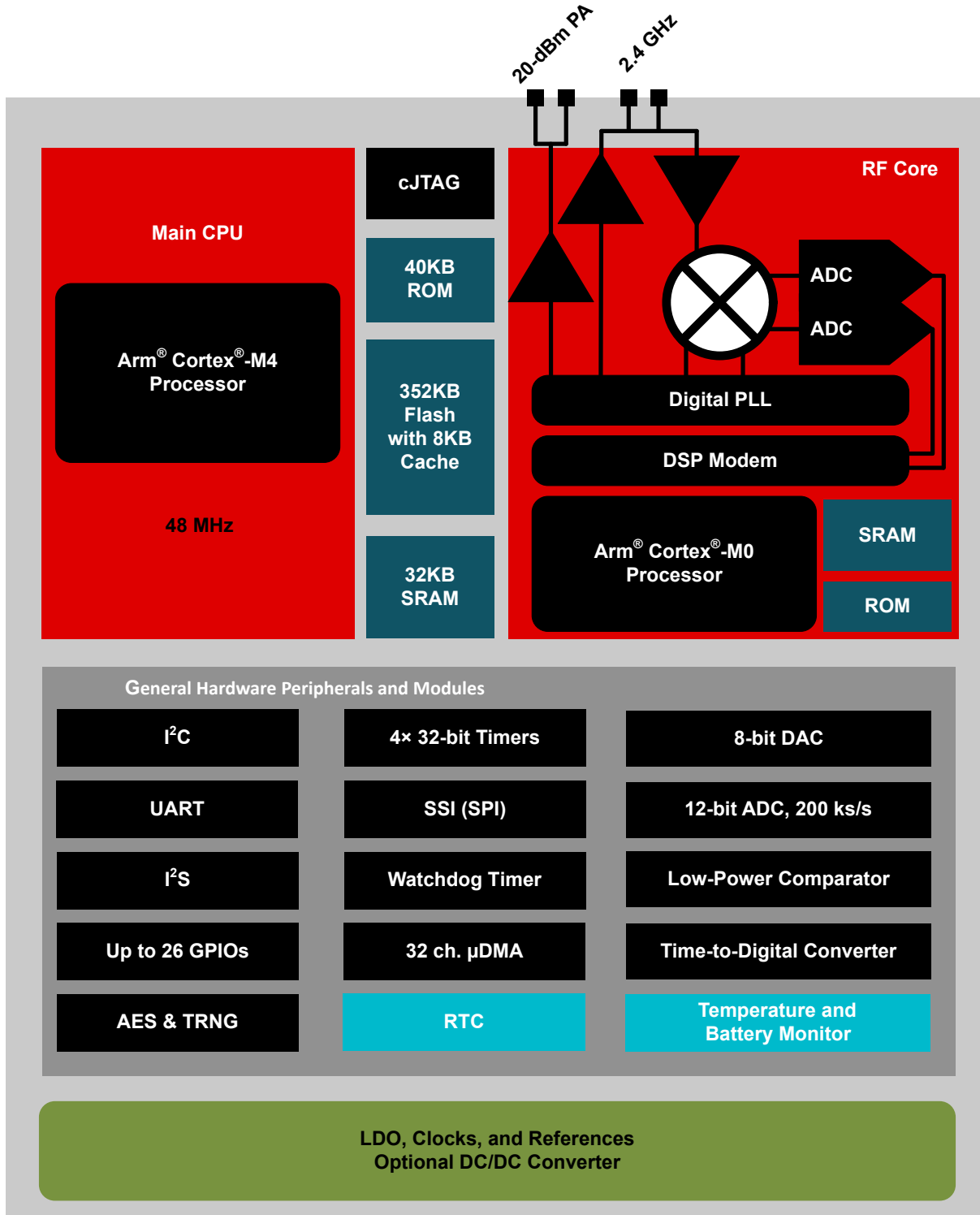
資料番号末尾の英字は改訂を表しています。その改訂履歴は英語版に準じています。

DATE	REVISION	NOTES
March 2022	*	Initial Release

## 6 Device Comparison

Device	RADIO SUPPORT											FLASH (KB)	RAM + Cache (KB)	GPIO	PACKAGE SIZE			
	Sub-1 GHz Prop.	2.4GHz Prop.	Wireless M-Bus		WI-SUN®	Sidewalk	Bluetooth® 5.2 LE	ZigBee	Thread	Multiprotocol	+20 dBm PA				4 X 4 mm VQFN (32)	5 X 5 mm VQFN (32)	5 X 5 mm VQFN (40)	7 X 7 mm VQFN (48)
CC1310	X		X	X								32-128	16-20 + 8	10-30	X	X		X
CC1311R3	X		X	X								352	32 + 8	22-30			X	X
CC1311P3	X		X	X							X	352	32 + 8	26				X
CC1312R	X		X	X	X							352	80 + 8	30				X
CC1312R7	X		X	X	X	X				X		704	144 + 8	30				X
CC1352R	X	X	X	X	X		X	X	X	X		352	80 + 8	28				X
CC1352P	X	X	X	X	X		X	X	X	X	X	352	80 + 8	26				X
CC1352P7	X	X	X	X	X	X	X	X	X	X	X	704	144 + 8	26				X
CC2640R2F							X					128	20 + 8	10-31	X	X		X
CC2642R							X					352	80 + 8	31				X
CC2642R-Q1							X					352	80 + 8	31				X
CC2651R3		X					X	X				352	32 + 8	23-31			X	X
CC2651P3		X					X	X			X	352	32 + 8	22-26			X	X
CC2652R		X					X	X	X	X		352	80 + 8	31				X
CC2652RB		X					X	X	X	X		352	80 + 8	31				X
CC2652R7		X					X	X	X	X		704	144 + 8	31				X
CC2652P		X					X	X	X	X	X	352	80 + 8	26				X
CC2652P7		X					X	X	X	X	X	704	144 + 8	26				X

## 7 Pin Configuration and Functions

### 7.1 Pin Diagram – RGZ Package (Top View)

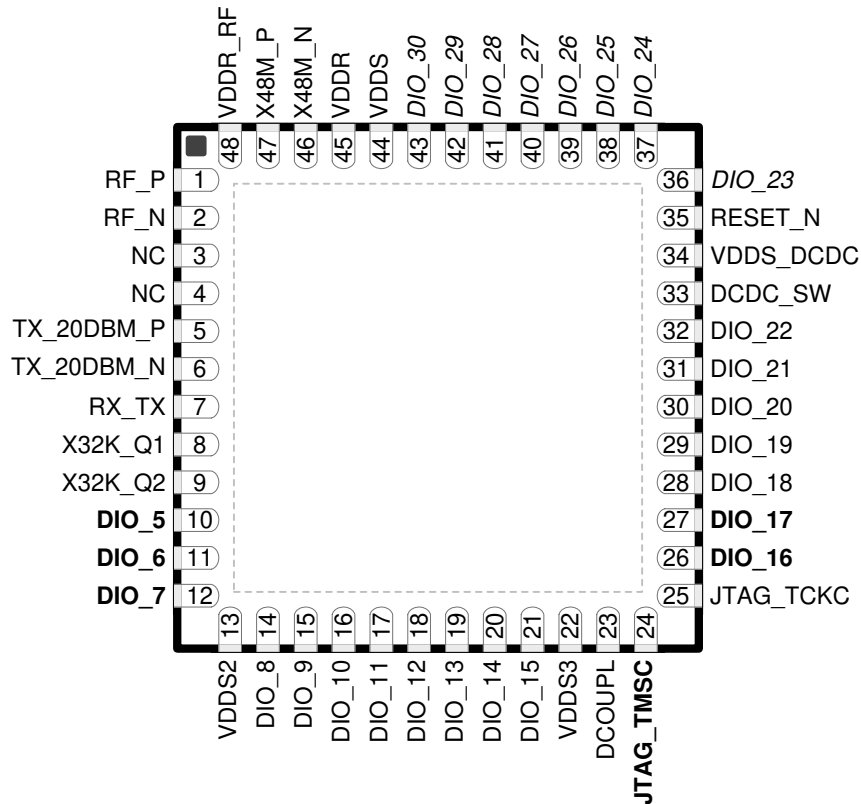

**7-1. RGZ (7-mm × 7-mm) Pinout, 0.5-mm Pitch (Top View)**

The following I/O pins marked in [7-1](#) in **bold** have high-drive capabilities:

- Pin 10, DIO\_5
- Pin 11, DIO\_6
- Pin 12, DIO\_7
- Pin 24, JTAG\_TMSC
- Pin 26, DIO\_16
- Pin 27, DIO\_17

The following I/O pins marked in [7-1](#) in *italics* have analog capabilities:

- Pin 36, DIO\_23
- Pin 37, DIO\_24
- Pin 38, DIO\_25
- Pin 39, DIO\_26
- Pin 40, DIO\_27
- Pin 41, DIO\_28
- Pin 42, DIO\_29
- Pin 43, DIO\_30

## 7.2 Signal Descriptions – RGZ Package

**表 7-1. Signal Descriptions – RGZ Package**

PIN		I/O	TYPE	DESCRIPTION
NAME	NO.			
DCDC_SW	33	—	Power	Output from internal DC/DC converter <sup>(1)</sup>
DCOUPPL	23	—	Power	For decoupling of internal 1.27 V regulated digital-supply <sup>(2)</sup>
DIO_5	10	I/O	Digital	GPIO, high-drive capability
DIO_6	11	I/O	Digital	GPIO, high-drive capability
DIO_7	12	I/O	Digital	GPIO, high-drive capability
DIO_8	14	I/O	Digital	GPIO
DIO_9	15	I/O	Digital	GPIO
DIO_10	16	I/O	Digital	GPIO
DIO_11	17	I/O	Digital	GPIO
DIO_12	18	I/O	Digital	GPIO
DIO_13	19	I/O	Digital	GPIO
DIO_14	20	I/O	Digital	GPIO
DIO_15	21	I/O	Digital	GPIO
DIO_16	26	I/O	Digital	GPIO, JTAG_TDO, high-drive capability
DIO_17	27	I/O	Digital	GPIO, JTAG_TDI, high-drive capability
DIO_18	28	I/O	Digital	GPIO
DIO_19	29	I/O	Digital	GPIO
DIO_20	30	I/O	Digital	GPIO
DIO_21	31	I/O	Digital	GPIO
DIO_22	32	I/O	Digital	GPIO
DIO_23	36	I/O	Digital or Analog	GPIO, analog capability
DIO_24	37	I/O	Digital or Analog	GPIO, analog capability
DIO_25	38	I/O	Digital or Analog	GPIO, analog capability
DIO_26	39	I/O	Digital or Analog	GPIO, analog capability
DIO_27	40	I/O	Digital or Analog	GPIO, analog capability
DIO_28	41	I/O	Digital or Analog	GPIO, analog capability
DIO_29	42	I/O	Digital or Analog	GPIO, analog capability
DIO_30	43	I/O	Digital or Analog	GPIO, analog capability
EGP	—	—	GND	Ground – exposed ground pad <sup>(3)</sup>
JTAG_TMSC	24	I/O	Digital	JTAG TMSC, high-drive capability
JTAG_TCKC	25	I	Digital	JTAG TCKC
RESET_N	35	I	Digital	Reset, active low. No internal pullup resistor
RF_P	1	—	RF	Positive RF input signal to LNA during RX Positive RF output signal from PA during TX
RF_N	2	—	RF	Negative RF input signal to LNA during RX Negative RF output signal from PA during TX
RX_TX	7	—	RF	Optional bias pin for the RF LNA
TX_20DBM_P	5	—	RF	Positive high-power TX signal
TX_20DBM_N	6	—	RF	Negative high-power TX signal
VDDR	45	—	Power	Internal supply, must be powered from the internal DC/DC converter or the internal LDO <sup>(2) (4) (6)</sup>
VDDR_RF	48	—	Power	Internal supply, must be powered from the internal DC/DC converter or the internal LDO <sup>(2) (5) (6)</sup>
VDDS	44	—	Power	1.8-V to 3.8-V main chip supply <sup>(1)</sup>

表 7-1. Signal Descriptions – RGZ Package (continued)

PIN		I/O	TYPE	DESCRIPTION
NAME	NO.			
VDDS2	13	—	Power	1.8-V to 3.8-V DIO supply <sup>(1)</sup>
VDDS3	22	—	Power	1.8-V to 3.8-V DIO supply <sup>(1)</sup>
VDDS_DCDC	34	—	Power	1.8-V to 3.8-V DC/DC converter supply
X48M_N	46	—	Analog	48-MHz crystal oscillator pin 1
X48M_P	47	—	Analog	48-MHz crystal oscillator pin 2
X32K_Q1	8	—	Analog	32-kHz crystal oscillator pin 1
X32K_Q2	9	—	Analog	32-kHz crystal oscillator pin 2

- (1) For more details, see the device technical reference manual listed in [セクション 11.3](#).
- (2) Do not supply external circuitry from this pin.
- (3) EGP is the only ground connection for the device. Good electrical connection to device ground on printed circuit board (PCB) is imperative for proper device operation.
- (4) If internal DC/DC converter is not used, this pin is supplied internally from the main LDO.
- (5) If internal DC/DC converter is not used, this pin must be connected to VDDR for supply from the main LDO.
- (6) Output from internal DC/DC and LDO is trimmed to 1.68 V.

### 7.3 Pin Diagram – RKP Package (Top View)



图 7-2. RKP (5-mm × 5-mm) Pinout, 0.4-mm Pitch (Top View)

The following I/O pins marked in 图 7-2 in **bold** have high-drive capabilities:

- Pin 10, DIO\_5
- Pin 11, DIO\_6
- Pin 12, DIO\_7
- Pin 18, JTAG\_TMSC
- Pin 20, DIO\_10
- Pin 21, DIO\_11

The following I/O pins marked in 图 7-2 in *italics* have analog capabilities:

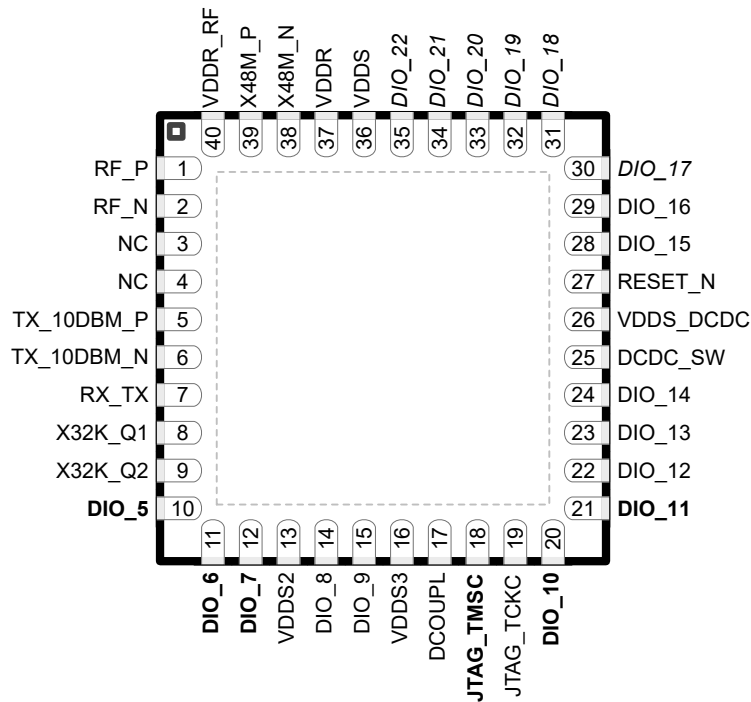
- Pin 28, DIO\_15
- Pin 29, DIO\_16
- Pin 30, DIO\_17
- Pin 31, DIO\_18
- Pin 32, DIO\_19
- Pin 33, DIO\_20
- Pin 34, DIO\_21
- Pin 35, DIO\_22

### 7.4 Signal Descriptions – RKP Package

表 7-2. Signal Descriptions – RKP Package

PIN		I/O	TYPE	DESCRIPTION
NAME	NO.			
DCDC_SW	25	—	Power	Output from internal DC/DC converter <sup>(1)</sup>
DCOUPPL	17	—	Power	For decoupling of internal 1.27 V regulated digital-supply <sup>(2)</sup>
DIO_5	10	I/O	Digital	GPIO, high-drive capability
DIO_6	11	I/O	Digital	GPIO, high-drive capability
DIO_7	12	I/O	Digital	GPIO, high-drive capability

表 7-2. Signal Descriptions – RKP Package (continued)

PIN		I/O	TYPE	DESCRIPTION
NAME	NO.			
DIO_8	14	I/O	Digital	GPIO
DIO_9	15	I/O	Digital	GPIO
DIO_10	20	I/O	Digital	GPIO, JTAG_TDO, high-drive capability
DIO_11	21	I/O	Digital	GPIO, JTAG_TDI, high-drive capability
DIO_12	22	I/O	Digital	GPIO
DIO_13	23	I/O	Digital	GPIO
DIO_14	24	I/O	Digital	GPIO
DIO_15	28	I/O	Digital	GPIO, analog capability
DIO_16	29	I/O	Digital	GPIO, analog capability
DIO_17	30	I/O	Digital	GPIO, analog capability
DIO_18	31	I/O	Digital	GPIO, analog capability
DIO_19	32	I/O	Digital	GPIO, analog capability
DIO_20	33	I/O	Digital	GPIO, analog capability
DIO_21	34	I/O	Digital	GPIO, analog capability
DIO_22	35	I/O	Digital	GPIO, analog capability
EGP	—	—	GND	Ground – exposed ground pad <sup>(3)</sup>
JTAG_TSMC	18	I/O	Digital	JTAG TSMC, high-drive capability
JTAG_TCKC	19	I	Digital	JTAG TCKC
RESET_N	27	I	Digital	Reset, active low. No internal pullup resistor
RF_P	1	—	RF	Positive RF input signal to LNA during RX Positive RF output signal from PA during TX
RF_N	2	—	RF	Negative RF input signal to LNA during RX Negative RF output signal from PA during TX
RX_TX	7	—	RF	Optional bias pin for the RF LNA
TX_20DBM_P	5	—	RF	Positive high-power TX signal
TX_20DBM_N	6	—	RF	Negative high-power TX signal
VDDR	37	—	Power	Internal supply, must be powered from the internal DC/DC converter or the internal LDO <sup>(2) (4) (6)</sup>
VDDR_RF	40	—	Power	Internal supply, must be powered from the internal DC/DC converter or the internal LDO <sup>(2) (5) (6)</sup>
VDDS	36	—	Power	1.8-V to 3.8-V main chip supply <sup>(1)</sup>
VDDS2	13	—	Power	1.8-V to 3.8-V DIO supply <sup>(1)</sup>
VDDS3	16	—	Power	1.8-V to 3.8-V DIO supply <sup>(1)</sup>
VDDS_DCDC	26	—	Power	1.8-V to 3.8-V DC/DC converter supply
X48M_N	38	—	Analog	48-MHz crystal oscillator pin 1
X48M_P	39	—	Analog	48-MHz crystal oscillator pin 2
X32K_Q1	8	—	Analog	32-kHz crystal oscillator pin 1
X32K_Q2	9	—	Analog	32-kHz crystal oscillator pin 2

(1) For more details, see the device technical reference manual listed in [セクション 11.3](#).

(2) Do not supply external circuitry from this pin.

(3) EGP is the only ground connection for the device. Good electrical connection to device ground on printed circuit board (PCB) is imperative for proper device operation.

(4) If internal DC/DC converter is not used, this pin is supplied internally from the main LDO.

(5) If internal DC/DC converter is not used, this pin must be connected to VDDR for supply from the main LDO.

(6) Output from internal DC/DC and LDO is trimmed to 1.68 V.

## 7.5 Connections for Unused Pins and Modules

**表 7-3. Connections for Unused Pins – RGZ Package**

FUNCTION	SIGNAL NAME	PIN NUMBER	ACCEPTABLE PRACTICE <sup>(1)</sup>	PREFERRED PRACTICE <sup>(1)</sup>
GPIO	DIO_n	10–12 14–21 26–32 36–43	NC or GND	NC
32.768-kHz crystal	X32K_Q1	8	NC or GND	NC
	X32K_Q2	9		
No Connects	NC	3–4	NC	NC
DC/DC converter <sup>(2)</sup>	DCDC_SW	33	NC	NC
	VDDS_DCDC	34	VDDS	VDDS

(1) NC = No connect

(2) When the DC/DC converter is not used, the inductor between DCDC\_SW and VDDR can be removed. VDDR and VDDR\_RF must still be connected and the 22 uF DCDC capacitor must be kept on the VDDR net.

**表 7-4. Connection for Unused Pins and Modules – RKP Package**

FUNCTION	SIGNAL NAME	PIN NUMBER	ACCEPTABLE PRACTICE	PREFERRED PRACTICE
GPIO	DIO_n	10-12 14-15 20-24 28-35	NC or GND	NC
32.768-kHz crystal	X32K_Q1	3	NC or GND	NC
	X32K_Q2	4		
No Connects	NC	3–4	NC	NC
DC/DC converter	DCDC_SW	25	NC	NC
	VDDS_DCDC	26	VDDS	VDDS

## 8 Specifications

### 8.1 Absolute Maximum Ratings

over operating free-air temperature range (unless otherwise noted)<sup>(1) (2)</sup>

		MIN	MAX	UNIT
V <sub>DDS</sub> <sup>(3) (6)</sup>	Supply voltage	-0.3	4.1	V
	Voltage on any digital pin <sup>(4) (5)</sup>	-0.3	V <sub>DDS</sub> + 0.3, max 4.1	V
	Voltage on crystal oscillator pins, X32K_Q1, X32K_Q2, X48M_N and X48M_P	-0.3	V <sub>DDR</sub> + 0.3, max 2.25	V
V <sub>in</sub>	Voltage on ADC input	Voltage scaling enabled	V <sub>DDS</sub>	V
		Voltage scaling disabled, internal reference	1.49	
		Voltage scaling disabled, V <sub>DDS</sub> as reference	V <sub>DDS</sub> / 2.9	
	Input level, RF pins (RF_P and RF_N)		5	dBm
T <sub>stg</sub>	Storage temperature	-40	150	°C

- Operation outside the Absolute Maximum Ratings may cause permanent device damage. Absolute Maximum Ratings do not imply functional operation of the device at these or any other conditions beyond those listed under Recommended Operating Conditions. If used outside the Recommended Operating Conditions but within the Absolute Maximum Ratings, the device may not be fully functional, and this may affect device reliability, functionality, performance, and shorten the device lifetime
- All voltage values are with respect to ground, unless otherwise noted.
- V<sub>DDS\_DCDC</sub>, V<sub>DDS2</sub> and V<sub>DDS3</sub> must be at the same potential as V<sub>DDS</sub>.
- Including analog capable DIOs.
- Injection current is not supported on any GPIO pin
- Connect V<sub>DDR</sub> to the external PA bias voltage for +10dBm and V<sub>DDS</sub> to the external PA bias voltage for +14dBm to +20dBm

### 8.2 ESD Ratings

			VALUE	UNIT	
V <sub>ESD</sub>	Electrostatic discharge	Human body model (HBM), per ANSI/ESDA/JEDEC JS001 <sup>(1)</sup>	All pins	±2000	V
		Charged device model (CDM), per JESD22-C101 <sup>(2)</sup>	All pins	±500	V

- JEDEC document JEP155 states that 500-V HBM allows safe manufacturing with a standard ESD control process.
- JEDEC document JEP157 states that 250-V CDM allows safe manufacturing with a standard ESD control process.

### 8.3 Recommended Operating Conditions

over operating free-air temperature range (unless otherwise noted)

	MIN	MAX	UNIT
Operating ambient temperature <sup>(1) (2)</sup>	-40	105	°C
Operating junction temperature <sup>(1) (2)</sup>	-40	115	°C
Operating supply voltage (V <sub>DDS</sub> )	1.8	3.8	V
Rising supply voltage slew rate	0	100	mV/μs
Falling supply voltage slew rate <sup>(3)</sup>	0	20	mV/μs

- Operation at or near maximum operating temperature for extended durations will result in lifetime reduction.
- For thermal resistance characteristics refer to [セクション 8.8](#).
- For small coin-cell batteries, with high worst-case end-of-life equivalent source resistance, a 22-μF V<sub>DDS</sub> input capacitor must be used to ensure compliance with this slew rate.

### 8.4 Power Supply and Modules

over operating free-air temperature range (unless otherwise noted)

PARAMETER		MIN	TYP	MAX	UNIT
V <sub>DDS</sub> Power-on-Reset (POR) threshold		1.1 - 1.55			V
V <sub>DDS</sub> Brown-out Detector (BOD)	Rising threshold	1.77			V
V <sub>DDS</sub> Brown-out Detector (BOD), before initial boot <sup>(1)</sup>	Rising threshold	1.70			V
V <sub>DDS</sub> Brown-out Detector (BOD)	Falling threshold	1.75			V

- Brown-out Detector is trimmed at initial boot, value is kept until device is reset by a POR reset or the RESET\_N pin

## 8.5 Power Consumption - Power Modes

When measured on the CC26x1-P3EM-XD24-PA24 reference design with  $T_c = 25\text{ }^\circ\text{C}$ ,  $V_{DD5} = 3.0\text{ V}$  with DC/DC enabled unless otherwise noted.

PARAMETER		TEST CONDITIONS	MIN	TYP	MAX	UNIT
<b>Core Current Consumption</b>						
$I_{core}$	Reset and Shutdown	Reset. RESET_N pin asserted or VDD5 below power-on-reset threshold		150		nA
		Shutdown. No clocks running, no retention		100		
	Standby without cache retention	RTC running, CPU, 32KB RAM and (partial) register retention. RCOSC_LF		0.8		$\mu\text{A}$
		RTC running, CPU, 32KB RAM and (partial) register retention. XOSC_LF		0.9		$\mu\text{A}$
	Standby with cache retention	RTC running, CPU, 32KB RAM and (partial) register retention. RCOSC_LF		2.4		$\mu\text{A}$
		RTC running, CPU, 32KB RAM and (partial) register retention. XOSC_LF		2.6		$\mu\text{A}$
	Idle	Supply Systems and RAM powered. RCOSC_HF		650		$\mu\text{A}$
Active	MCU running CoreMark at 48 MHz. RCOSC_HF		2.91		mA	
<b>Peripheral Current Consumption</b>						
$I_{peri}$	Peripheral power domain	Delta current with domain enabled		56.0		$\mu\text{A}$
	Serial power domain	Delta current with domain enabled		5.0		
	RF Core	Delta current with power domain enabled, clock enabled, RF core idle		144		
	$\mu\text{DMA}$	Delta current with clock enabled, module is idle		68.6		
	Timers	Delta current with clock enabled, module is idle <sup>(1)</sup>		102		
	I2C	Delta current with clock enabled, module is idle		12.1		
	I2S	Delta current with clock enabled, module is idle		30.8		
	SSI	Delta current with clock enabled, module is idle		71.7		
	UART	Delta current with clock enabled, module is idle		147		
	CRYPTO (AES)	Delta current with clock enabled, module is idle		28.1		
	TRNG	Delta current with clock enabled, module is idle		27.1		

(1) Only one GPTimer running

## 8.6 Power Consumption - Radio Modes

When measured on the CC26x1-P3EM-XD24-PA24 reference design with  $T_c = 25\text{ }^\circ\text{C}$ ,  $V_{DD5} = 3.0\text{ V}$  with DC/DC enabled unless otherwise noted.

High-power PA connected to  $V_{DD5}$  unless otherwise noted.

PARAMETER	TEST CONDITIONS	MIN	TYP	MAX	UNIT
Radio receive current	2440 MHz		6.4		mA
Radio transmit current 2.4 GHz PA (Bluetooth Low Energy)	0 dBm output power setting 2440 MHz		7.1		mA
	+5 dBm output power setting 2440 MHz		9.5		mA
Radio transmit current High-power PA	+20 dBm output power setting <sup>(1)</sup> 2440 MHz. $V_{DD5} = 3.3\text{ V}$		101		mA
Radio transmit current High-power PA, 10 dBm configuration <sup>(2)</sup>	+10 dBm output power setting 2440 MHz $V_{DDR} = 1.67\text{ V}$		22		mA

(1) +20 dBm is only available on the RGZ (7x7) package

(2) Measured on evaluation board as described in <https://www.ti.com/lit/pdf/swra636>.

## 8.7 Nonvolatile (Flash) Memory Characteristics

Over operating free-air temperature range and  $V_{DD5} = 3.0\text{ V}$  (unless otherwise noted)

PARAMETER	TEST CONDITIONS	MIN	TYP	MAX	UNIT
Flash sector size			8		KB
Supported flash erase cycles before failure, full bank <sup>(1) (5)</sup>		30			k Cycles
Supported flash erase cycles before failure, single sector <sup>(2)</sup>		60			k Cycles
Maximum number of write operations per row before sector erase <sup>(3)</sup>				83	Write Operations
Flash retention	105 °C	11.4			Years
Flash sector erase current	Average delta current		9.7		mA
Flash sector erase time <sup>(4)</sup>	Zero cycles		10		ms
	30k cycles			4000	ms
Flash write current	Average delta current, 4 bytes at a time		5.3		mA
Flash write time <sup>(4)</sup>	4 bytes at a time		21.6		µs

(1) A full bank erase is counted as a single erase cycle on each sector.

(2) Up to 4 customer-designated sectors can be individually erased an additional 30k times beyond the baseline bank limitation of 30k cycles

(3) Each wordline is 2048 bits (or 256 bytes) wide. This limitation corresponds to sequential memory writes of 4 (3.1) bytes minimum per write over a whole wordline. If additional writes to the same wordline are required, a sector erase is required once the maximum number of write operations per row is reached.

(4) This number is dependent on Flash aging and increases over time and erase cycles

(5) Aborting flash during erase or program modes is not a safe operation.

## 8.8 Thermal Resistance Characteristics

THERMAL METRIC <sup>(1)</sup>		PACKAGE		UNIT
		RGZ (VQFN)	RKP (VQFN)	
		48 PINS	40 PINS	
$R_{\theta JA}$	Junction-to-ambient thermal resistance	25.0	30.9	°C/W <sup>(2)</sup>
$R_{\theta JC(top)}$	Junction-to-case (top) thermal resistance	14.5	20.2	°C/W <sup>(2)</sup>
$R_{\theta JB}$	Junction-to-board thermal resistance	8.7	10.3	°C/W <sup>(2)</sup>
$\psi_{JT}$	Junction-to-top characterization parameter	0.2	0.2	°C/W <sup>(2)</sup>
$\psi_{JB}$	Junction-to-board characterization parameter	8.6	10.3	°C/W <sup>(2)</sup>
$R_{\theta JC(bot)}$	Junction-to-case (bottom) thermal resistance	2.1	2.1	°C/W <sup>(2)</sup>

(1) For more information about traditional and new thermal metrics, see [Semiconductor and IC Package Thermal Metrics](#).

(2) °C/W = degrees Celsius per watt.

## 8.9 RF Frequency Bands

Over operating free-air temperature range (unless otherwise noted).

PARAMETER	MIN	TYP	MAX	UNIT
Frequency bands	2360		2500	MHz

## 8.10 Bluetooth Low Energy - Receive (RX)

Measured on the CC26x1-P3EM-7XD24-PA24 reference design with  $T_c = 25\text{ }^\circ\text{C}$ ,  $V_{DD5} = 3.0\text{ V}$ ,  $f_{RF} = 2440\text{ MHz}$  with DC/DC enabled and high power PA connected to  $V_{DD5}$  unless otherwise noted.

All measurements are performed at the antenna input with a combined RX and TX path, except for high power PA which is measured at a dedicated antenna connection. All measurements are performed conducted.

PARAMETER	TEST CONDITIONS	MIN	TYP	MAX	UNIT
<b>125 kbps (LE Coded)</b>					
Receiver sensitivity	Differential mode. BER = $10^{-3}$		-104		dBm
Receiver sensitivity	Single ended mode. Measured on CC26x1-P3EM-5XS24, at the SMA connector, BER = $10^{-3}$		-104		dBm
Receiver saturation	Differential mode. BER = $10^{-3}$		>5		dBm
Frequency error tolerance	Difference between the incoming carrier frequency and the internally generated carrier frequency		> (-300 / 300)		kHz
Data rate error tolerance	Difference between incoming data rate and the internally generated data rate (37-byte packets)		> (-320 / 240)		ppm
Data rate error tolerance	Difference between incoming data rate and the internally generated data rate (255-byte packets)		> (-125 / 125)		ppm
Co-channel rejection <sup>(1)</sup>	Wanted signal at -79 dBm, modulated interferer in channel, BER = $10^{-3}$		-1.5		dB
Selectivity, $\pm 1\text{ MHz}$ <sup>(1)</sup>	Wanted signal at -79 dBm, modulated interferer at $\pm 1\text{ MHz}$ , BER = $10^{-3}$		8 / 4.5 <sup>(2)</sup>		dB
Selectivity, $\pm 2\text{ MHz}$ <sup>(1)</sup>	Wanted signal at -79 dBm, modulated interferer at $\pm 2\text{ MHz}$ , BER = $10^{-3}$		44 / 39 <sup>(2)</sup>		dB
Selectivity, $\pm 3\text{ MHz}$ <sup>(1)</sup>	Wanted signal at -79 dBm, modulated interferer at $\pm 3\text{ MHz}$ , BER = $10^{-3}$		46 / 44 <sup>(2)</sup>		dB
Selectivity, $\pm 4\text{ MHz}$ <sup>(1)</sup>	Wanted signal at -79 dBm, modulated interferer at $\pm 4\text{ MHz}$ , BER = $10^{-3}$		44 / 46 <sup>(2)</sup>		dB
Selectivity, $\pm 6\text{ MHz}$ <sup>(1)</sup>	Wanted signal at -79 dBm, modulated interferer at $\geq \pm 6\text{ MHz}$ , BER = $10^{-3}$		48 / 44 <sup>(2)</sup>		dB
Selectivity, $\pm 7\text{ MHz}$	Wanted signal at -79 dBm, modulated interferer at $\geq \pm 7\text{ MHz}$ , BER = $10^{-3}$		51 / 45 <sup>(2)</sup>		dB
Selectivity, Image frequency <sup>(1)</sup>	Wanted signal at -79 dBm, modulated interferer at image frequency, BER = $10^{-3}$		39		dB
Selectivity, Image frequency $\pm 1\text{ MHz}$ <sup>(1)</sup>	Note that Image frequency + 1 MHz is the Co- channel - 1 MHz. Wanted signal at -79 dBm, modulated interferer at $\pm 1\text{ MHz}$ from image frequency, BER = $10^{-3}$		4.5 / 44 <sup>(2)</sup>		dB
<b>500 kbps (LE Coded)</b>					
Receiver sensitivity	Differential mode. BER = $10^{-3}$		-100		dBm
Receiver sensitivity	Single ended mode. Measured on CC26x1-P3EM-5XS24, at the SMA connector, BER = $10^{-3}$		-100		dBm
Receiver saturation	Differential mode. BER = $10^{-3}$		> 5		dBm
Frequency error tolerance	Difference between the incoming carrier frequency and the internally generated carrier frequency		> (-300 / 300)		kHz
Data rate error tolerance	Difference between incoming data rate and the internally generated data rate (37-byte packets)		> (-450 / 450)		ppm
Data rate error tolerance	Difference between incoming data rate and the internally generated data rate (255-byte packets)		> (-175 / 175)		ppm
Co-channel rejection <sup>(1)</sup>	Wanted signal at -72 dBm, modulated interferer in channel, BER = $10^{-3}$		-3.5		dB
Selectivity, $\pm 1\text{ MHz}$ <sup>(1)</sup>	Wanted signal at -72 dBm, modulated interferer at $\pm 1\text{ MHz}$ , BER = $10^{-3}$		8 / 4 <sup>(2)</sup>		dB
Selectivity, $\pm 2\text{ MHz}$ <sup>(1)</sup>	Wanted signal at -72 dBm, modulated interferer at $\pm 2\text{ MHz}$ , BER = $10^{-3}$		44 / 37 <sup>(2)</sup>		dB
Selectivity, $\pm 3\text{ MHz}$ <sup>(1)</sup>	Wanted signal at -72 dBm, modulated interferer at $\pm 3\text{ MHz}$ , BER = $10^{-3}$		46 / 46 <sup>(2)</sup>		dB
Selectivity, $\pm 4\text{ MHz}$ <sup>(1)</sup>	Wanted signal at -72 dBm, modulated interferer at $\pm 4\text{ MHz}$ , BER = $10^{-3}$		45 / 47 <sup>(2)</sup>		dB
Selectivity, $\pm 6\text{ MHz}$ <sup>(1)</sup>	Wanted signal at -72 dBm, modulated interferer at $\geq \pm 6\text{ MHz}$ , BER = $10^{-3}$		46 / 45 <sup>(2)</sup>		dB

## 8.10 Bluetooth Low Energy - Receive (RX) (continued)

Measured on the CC26x1-P3EM-7XD24-PA24 reference design with  $T_c = 25\text{ }^\circ\text{C}$ ,  $V_{DD5} = 3.0\text{ V}$ ,  $f_{RF} = 2440\text{ MHz}$  with DC/DC enabled and high power PA connected to  $V_{DD5}$  unless otherwise noted.

All measurements are performed at the antenna input with a combined RX and TX path, except for high power PA which is measured at a dedicated antenna connection. All measurements are performed conducted.

PARAMETER	TEST CONDITIONS	MIN	TYP	MAX	UNIT
Selectivity, $\pm 7\text{ MHz}$	Wanted signal at $-72\text{ dBm}$ , modulated interferer at $\geq \pm 7\text{ MHz}$ , BER = $10^{-3}$		49 / 45 <sup>(2)</sup>		dB
Selectivity, Image frequency <sup>(1)</sup>	Wanted signal at $-72\text{ dBm}$ , modulated interferer at image frequency, BER = $10^{-3}$		37		dB
Selectivity, Image frequency $\pm 1\text{ MHz}$ <sup>(1)</sup>	Note that Image frequency + 1 MHz is the Co- channel – 1 MHz. Wanted signal at $-72\text{ dBm}$ , modulated interferer at $\pm 1\text{ MHz}$ from image frequency, BER = $10^{-3}$		4 / 46 <sup>(2)</sup>		dB
<b>1 Mbps (LE 1M)</b>					
Receiver sensitivity	Differential mode. BER = $10^{-3}$		-97		dBm
Receiver sensitivity	Single ended mode. Measured on CC26x1-P3EM-5XS24, at the SMA connector, BER = $10^{-3}$		-97		dBm
Receiver saturation	Differential mode. BER = $10^{-3}$		> 5		dBm
Frequency error tolerance	Difference between the incoming carrier frequency and the internally generated carrier frequency		> (-350 / 350)		kHz
Data rate error tolerance	Difference between incoming data rate and the internally generated data rate (37-byte packets)		> (-750 / 750)		ppm
Co-channel rejection <sup>(1)</sup>	Wanted signal at $-67\text{ dBm}$ , modulated interferer in channel, BER = $10^{-3}$		-6		dB
Selectivity, $\pm 1\text{ MHz}$ <sup>(1)</sup>	Wanted signal at $-67\text{ dBm}$ , modulated interferer at $\pm 1\text{ MHz}$ , BER = $10^{-3}$		7 / 4 <sup>(2)</sup>		dB
Selectivity, $\pm 2\text{ MHz}$ <sup>(1)</sup>	Wanted signal at $-67\text{ dBm}$ , modulated interferer at $\pm 2\text{ MHz}$ , BER = $10^{-3}$		40 / 33 <sup>(2)</sup>		dB
Selectivity, $\pm 3\text{ MHz}$ <sup>(1)</sup>	Wanted signal at $-67\text{ dBm}$ , modulated interferer at $\pm 3\text{ MHz}$ , BER = $10^{-3}$		36 / 41 <sup>(2)</sup>		dB
Selectivity, $\pm 4\text{ MHz}$ <sup>(1)</sup>	Wanted signal at $-67\text{ dBm}$ , modulated interferer at $\pm 4\text{ MHz}$ , BER = $10^{-3}$		37 / 45 <sup>(2)</sup>		dB
Selectivity, $\pm 5\text{ MHz or more}$ <sup>(1)</sup>	Wanted signal at $-67\text{ dBm}$ , modulated interferer at $\geq \pm 5\text{ MHz}$ , BER = $10^{-3}$		40		dB
Selectivity, image frequency <sup>(1)</sup>	Wanted signal at $-67\text{ dBm}$ , modulated interferer at image frequency, BER = $10^{-3}$		33		dB
Selectivity, image frequency $\pm 1\text{ MHz}$ <sup>(1)</sup>	Note that Image frequency + 1 MHz is the Co- channel – 1 MHz. Wanted signal at $-67\text{ dBm}$ , modulated interferer at $\pm 1\text{ MHz}$ from image frequency, BER = $10^{-3}$		4 / 41 <sup>(2)</sup>		dB
Out-of-band blocking <sup>(3)</sup>	30 MHz to 2000 MHz		-10		dBm
Out-of-band blocking	2003 MHz to 2399 MHz		-18		dBm
Out-of-band blocking	2484 MHz to 2997 MHz		-12		dBm
Out-of-band blocking	3000 MHz to 12.75 GHz		-2		dBm
Intermodulation	Wanted signal at 2402 MHz, $-64\text{ dBm}$ . Two interferers at 2405 and 2408 MHz respectively, at the given power level		-42		dBm
Spurious emissions, 30 to 1000 MHz	Measurement in a 50- $\Omega$ single-ended load.		< -59		dBm
Spurious emissions, 1 to 12.75 GHz	Measurement in a 50- $\Omega$ single-ended load.		< -47		dBm
RSSI dynamic range			70		dB
RSSI accuracy			$\pm 4$		dB
<b>2 Mbps (LE 2M)</b>					
Receiver sensitivity	Differential mode. Measured at SMA connector, BER = $10^{-3}$		-92		dBm
Receiver sensitivity	Single ended mode. Measured on CC26x1-P3EM-5XS24, at the SMA connector, BER = $10^{-3}$		-92		dBm
Receiver saturation	Differential mode. Measured at SMA connector, BER = $10^{-3}$		> 5		dBm

## 8.10 Bluetooth Low Energy - Receive (RX) (continued)

Measured on the CC26x1-P3EM-7XD24-PA24 reference design with  $T_c = 25\text{ }^\circ\text{C}$ ,  $V_{DD3} = 3.0\text{ V}$ ,  $f_{RF} = 2440\text{ MHz}$  with DC/DC enabled and high power PA connected to  $V_{DD3}$  unless otherwise noted.

All measurements are performed at the antenna input with a combined RX and TX path, except for high power PA which is measured at a dedicated antenna connection. All measurements are performed conducted.

PARAMETER	TEST CONDITIONS	MIN	TYP	MAX	UNIT
Frequency error tolerance	Difference between the incoming carrier frequency and the internally generated carrier frequency		> (-500 / 500)		kHz
Data rate error tolerance	Difference between incoming data rate and the internally generated data rate (37-byte packets)		> (-700 / 750)		ppm
Co-channel rejection <sup>(1)</sup>	Wanted signal at -67 dBm, modulated interferer in channel, BER = $10^{-3}$		-7		dB
Selectivity, $\pm 2\text{ MHz}$ <sup>(1)</sup>	Wanted signal at -67 dBm, modulated interferer at $\pm 2\text{ MHz}$ , Image frequency is at -2 MHz, BER = $10^{-3}$		8 / 4 <sup>(2)</sup>		dB
Selectivity, $\pm 4\text{ MHz}$ <sup>(1)</sup>	Wanted signal at -67 dBm, modulated interferer at $\pm 4\text{ MHz}$ , BER = $10^{-3}$		36 / 31 <sup>(2)</sup>		dB
Selectivity, $\pm 6\text{ MHz}$ <sup>(1)</sup>	Wanted signal at -67 dBm, modulated interferer at $\pm 6\text{ MHz}$ , BER = $10^{-3}$		37 / 36 <sup>(2)</sup>		dB
Selectivity, image frequency <sup>(1)</sup>	Wanted signal at -67 dBm, modulated interferer at image frequency, BER = $10^{-3}$		4		dB
Selectivity, image frequency $\pm 2\text{ MHz}$ <sup>(1)</sup>	Note that Image frequency + 2 MHz is the Co-channel. Wanted signal at -67 dBm, modulated interferer at $\pm 2\text{ MHz}$ from image frequency, BER = $10^{-3}$		-7 / 36 <sup>(2)</sup>		dB
Out-of-band blocking <sup>(3)</sup>	30 MHz to 2000 MHz		-16		dBm
Out-of-band blocking	2003 MHz to 2399 MHz		-21		dBm
Out-of-band blocking	2484 MHz to 2997 MHz		-15		dBm
Out-of-band blocking	3000 MHz to 12.75 GHz		-12		dBm
Intermodulation	Wanted signal at 2402 MHz, -64 dBm. Two interferers at 2408 and 2414 MHz respectively, at the given power level		-38		dBm

(1) Numbers given as I/C dB

(2) X / Y, where X is +N MHz and Y is -N MHz

(3) Excluding one exception at  $F_{\text{wanted}} / 2$ , per Bluetooth Specification

## 8.11 Bluetooth Low Energy - Transmit (TX)

Measured on the CC26x1-P3EM-7XD24-PA24 reference design with  $T_c = 25\text{ }^\circ\text{C}$ ,  $V_{DD5} = 3.0\text{ V}$ ,  $f_{RF} = 2440\text{ MHz}$  with DC/DC enabled and high power PA connected to  $V_{DD5}$  unless otherwise noted.

All measurements are performed at the antenna input with a combined RX and TX path, except for high power PA which is measured at a dedicated antenna connection. All measurements are performed conducted.

PARAMETER	TEST CONDITIONS	MIN	TYP	MAX	UNIT
<b>General Parameters</b>					
Max output power, high power PA	Differential mode, delivered to a single-ended 50 $\Omega$ load through a balun		20		dBm
Output power programmable range high power PA	Differential mode, delivered to a single-ended 50 $\Omega$ load through a balun		6		dB
Max output power, high power PA, 10 dBm configuration <sup>(3)</sup>	Differential mode, delivered to a single-ended 50 $\Omega$ load through a balun		10.5		dBm
Max output power, high power PA, 10 dBm configuration <sup>(3)</sup>	Single-ended mode. Measured on CC26x1-P3EM-5XS24, delivered to a single-ended 50 $\Omega$ load through a balun		9		dBm
Output power programmable range high power PA, 10 dBm configuration <sup>(3)</sup>	Differential mode, delivered to a single-ended 50 $\Omega$ load through a balun		5		dB
Max output power, regular PA	Differential mode, delivered to a single-ended 50 $\Omega$ load through a balun		5		dBm
Max output power, regular PA	Single-ended mode. Measured on CC26x1-P3EM-5XS24, delivered to a single-ended 50 $\Omega$ load through a balun		3		dBm
Output power programmable range, regular PA	Differential mode, delivered to a single-ended 50 $\Omega$ load through a balun		26		dB
<b>Spurious emissions and harmonics</b>					
Spurious emissions, high-power PA <sup>(1)</sup>	f < 1 GHz, outside restricted bands	+20 dBm setting	< -36		dBm
	f < 1 GHz, restricted bands FCC		< -55		dBm
	f > 1 GHz, including harmonics		-37		dBm
Harmonics, high-power PA <sup>(2)</sup>	Second harmonic		-35		dBm
	Third harmonic		-42		dBm
Spurious emissions, high-power PA, 10 dBm configuration <sup>(1)</sup> <sup>(3)</sup>	f < 1 GHz, outside restricted bands	+10 dBm setting <sup>(3)</sup>	< -36		dBm
	f < 1 GHz, restricted bands ETSI		< -54		dBm
	f < 1 GHz, restricted bands FCC		< -55		dBm
	f > 1 GHz, including harmonics		-41		dBm
Harmonics, high-power PA, 10 dBm configuration <sup>(3)</sup>	Second harmonic		< -42		dBm
	Third harmonic		< -42		dBm
Spurious emissions, regular PA	f < 1 GHz, outside restricted bands	+5 dBm setting	< -36		dBm
	f < 1 GHz, restricted bands ETSI		< -54		dBm
	f < 1 GHz, restricted bands FCC		< -55		dBm
	f > 1 GHz, including harmonics		< -42		dBm
Harmonics, regular PA	Second harmonic		< -42		dBm
	Third harmonic		< -42		dBm

- (1) To ensure margins for passing FCC band edge requirements at 2483.5 MHz, a lower than maximum output-power setting or less than 100% duty cycle may be used when operating at the upper Bluetooth Low Energy channel(s).
- (2) To ensure margins for passing FCC requirements for harmonic emission, duty cycling may be required. The CC2651P3 LaunchPad reference design should also be reviewed as the filter provides higher attenuation of harmonics compared to the CC26x1-P3EM-XD24-PA24 reference design.
- (3) Measured on evaluation board as described in [www.ti.com/lit/pdf/swra636](http://www.ti.com/lit/pdf/swra636).

## 8.12 Zigbee - IEEE 802.15.4-2006 2.4 GHz (OQPSK DSSS1:8, 250 kbps) - RX

Measured on the CC26x1-P3EM-7XD24-PA24 reference design with  $T_c = 25\text{ }^\circ\text{C}$ ,  $V_{DD5} = 3.0\text{ V}$ ,  $f_{RF} = 2440\text{ MHz}$  with DC/DC enabled and high power PA connected to  $V_{DD5}$  unless otherwise noted.

All measurements are performed at the antenna input with a combined RX and TX path, except for high power PA which is measured at a dedicated antenna connection. All measurements are performed conducted.

PARAMETER	TEST CONDITIONS	MIN	TYP	MAX	UNIT
<b>General Parameters</b>					
Receiver sensitivity	Differential mode PER = 1%		-100		dBm
Receiver sensitivity	Single-Ended mode. Measured on CC26x1-P3EM-5XS24 at the SMA connector. PER = 1%		-99		dBm
Receiver saturation	PER = 1%		> 5		dBm
Adjacent channel rejection	Wanted signal at -82 dBm, modulated interferer at $\pm 5\text{ MHz}$ , PER = 1%		36		dB
Alternate channel rejection	Wanted signal at -82 dBm, modulated interferer at $\pm 10\text{ MHz}$ , PER = 1%		57		dB
Channel rejection, $\pm 15\text{ MHz}$ or more	Wanted signal at -82 dBm, undesired signal is IEEE 802.15.4 modulated channel, stepped through all channels 2405 to 2480 MHz, PER = 1%		59		dB
Blocking and desensitization, 5 MHz from upper band edge	Wanted signal at -97 dBm (3 dB above the sensitivity level), CW jammer, PER = 1%		57		dB
Blocking and desensitization, 10 MHz from upper band edge	Wanted signal at -97 dBm (3 dB above the sensitivity level), CW jammer, PER = 1%		63		dB
Blocking and desensitization, 20 MHz from upper band edge	Wanted signal at -97 dBm (3 dB above the sensitivity level), CW jammer, PER = 1%		63		dB
Blocking and desensitization, 50 MHz from upper band edge	Wanted signal at -97 dBm (3 dB above the sensitivity level), CW jammer, PER = 1%		66		dB
Blocking and desensitization, -5 MHz from lower band edge	Wanted signal at -97 dBm (3 dB above the sensitivity level), CW jammer, PER = 1%		60		dB
Blocking and desensitization, -10 MHz from lower band edge	Wanted signal at -97 dBm (3 dB above the sensitivity level), CW jammer, PER = 1%		60		dB
Blocking and desensitization, -20 MHz from lower band edge	Wanted signal at -97 dBm (3 dB above the sensitivity level), CW jammer, PER = 1%		63		dB
Blocking and desensitization, -50 MHz from lower band edge	Wanted signal at -97 dBm (3 dB above the sensitivity level), CW jammer, PER = 1%		65		dB
Spurious emissions, 30 MHz to 1000 MHz	Measurement in a 50- $\Omega$ single-ended load <sup>(1)</sup>		-66		dBm
Spurious emissions, 1 GHz to 12.75 GHz	Measurement in a 50- $\Omega$ single-ended load <sup>(1)</sup>		-53		dBm
Frequency error tolerance	Difference between the incoming carrier frequency and the internally generated carrier frequency		> 350		ppm
Symbol rate error tolerance	Difference between incoming symbol rate and the internally generated symbol rate		> 1000		ppm
RSSI dynamic range			95		dB
RSSI accuracy			$\pm 4$		dB

(1) Suitable for systems targeting compliance with EN 300 328, EN 300 440 class 2, FCC CFR47, Part 15 and ARIB STD-T-66

### 8.13 Zigbee - IEEE 802.15.4-2006 2.4 GHz (OQPSK DSSS1:8, 250 kbps) - TX

Measured on the CC26x1-P3EM-7XD24-PA24 reference design with  $T_c = 25\text{ }^\circ\text{C}$ ,  $V_{DD5} = 3.0\text{ V}$ ,  $f_{RF} = 2440\text{ MHz}$  with DC/DC enabled and high power PA connected to  $V_{DD5}$  unless otherwise noted.

All measurements are performed at the antenna input with a combined RX and TX path, except for high power PA which is measured at a dedicated antenna connection. All measurements are performed conducted.

PARAMETER	TEST CONDITIONS	MIN	TYP	MAX	UNIT
<b>General Parameters</b>					
Max output power, high power PA	Differential mode, delivered to a single-ended 50-Ω load through a balun		20		dBm
Output power programmable range, high power PA	Differential mode, delivered to a single-ended 50-Ω load through a balun		6		dB
Max output power, high power PA, 10 dBm configuration <sup>(4)</sup>	Differential mode, delivered to a single-ended 50-Ω load through a balun		10.5		dBm
Max output power, high power PA, 10 dBm configuration <sup>(4)</sup>	Single-ended mode. Measured on CC26x1-P3EM-5XS24, delivered to a single-ended 50-Ω load through a balun		9		dBm
Output power programmable range, high power PA, 10 dBm configuration <sup>(4)</sup>	Differential mode, delivered to a single-ended 50-Ω load through a balun		5		dB
Max output power, regular PA	Differential mode, delivered to a single-ended 50-Ω load through a balun		5		dBm
Output power programmable range, regular PA	Differential mode, delivered to a single-ended 50-Ω load through a balun		26		dB
<b>Spurious emissions and harmonics</b>					
Spurious emissions, high-power PA <sup>(2)</sup>	f < 1 GHz, outside restricted bands	+20 dBm setting	< -39		dBm
	f < 1 GHz, restricted bands FCC		< -49		dBm
	f > 1 GHz, including harmonics		-40		dBm
Harmonics, high-power PA <sup>(3)</sup>	Second harmonic		-35		dBm
	Third harmonic		-42		dBm
Spurious emissions, high-power PA, 10 dBm configuration <sup>(2) (4)</sup>	f < 1 GHz, outside restricted bands	+10 dBm setting <sup>(4)</sup>	< -36		dBm
	f < 1 GHz, restricted bands ETSI		< -47		dBm
	f < 1 GHz, restricted bands FCC		< -55		dBm
	f > 1 GHz, including harmonics		-42		dBm
Harmonics, high-power PA, 10 dBm configuration <sup>(4)</sup>	Second harmonic		< -42		dBm
	Third harmonic		< -42		dBm
Spurious emissions, regular PA <sup>(1)</sup>	f < 1 GHz, outside restricted bands	+5 dBm setting	< -36		dBm
	f < 1 GHz, restricted bands ETSI		< -47		dBm
	f < 1 GHz, restricted bands FCC		< -55		dBm
	f > 1 GHz, including harmonics		< -42		dBm
Harmonics, regular PA	Second harmonic		< -42		dBm
	Third harmonic		< -42		dBm
<b>IEEE 802.15.4-2006 2.4 GHz (OQPSK DSSS1:8, 250 kbps)</b>					
Error vector magnitude, high power PA	+20 dBm setting		2		%
Error vector magnitude, high power PA, 10 dBm configuration <sup>(4)</sup>	+10 dBm setting		2		%
Error vector magnitude Regular PA	+5 dBm setting		2		%

(1) To ensure margins for passing FCC band edge requirements at 2483.5 MHz, a lower than maximum output-power setting or less than 100% duty cycle may be used when operating at 2480 MHz.

- (2) To ensure margins for passing FCC band edge requirements at 2483.5 MHz, a lower than maximum output-power setting or less than 100% duty cycle may be used when operating at the upper 802.15.4 channel(s).
- (3) To ensure margins for passing FCC requirements for harmonic emission, duty cycling may be required. The CC2651P3 LaunchPad reference design should also be reviewed as the filter provides higher attenuation of harmonics compared to the CC26x1-P3EM-7XD24-PA24 reference design.
- (4) Measured on evaluation board as described in <https://www.ti.com/lit/pdf/swra636>.

## 8.14 Timing and Switching Characteristics

### 8.14.1 Reset Timing

PARAMETER	MIN	TYP	MAX	UNIT
RESET_N low duration	1			μs

### 8.14.2 Wakeup Timing

Measured over operating free-air temperature with  $V_{DD5} = 3.0\text{ V}$  (unless otherwise noted). The times listed here do not include software overhead.

PARAMETER	TEST CONDITIONS	MIN	TYP	MAX	UNIT
MCU, Reset to Active <sup>(1)</sup>		850	4000		μs
MCU, Shutdown to Active <sup>(1)</sup>		850	4000		μs
MCU, Standby to Active			160		μs
MCU, Active to Standby			36		μs
MCU, Idle to Active			14		μs

- (1) The wakeup time is dependent on remaining charge on VDDR capacitor when starting the device, and thus how long the device has been in Reset or Shutdown before starting up again. The wake up time increases with a higher capacitor value.

### 8.14.3 Clock Specifications

#### 8.14.3.1 48 MHz Crystal Oscillator (XOSC\_HF)

Measured on a Texas Instruments reference design with  $T_c = 25\text{ °C}$ ,  $V_{DD5} = 3.0\text{ V}$ , unless otherwise noted.<sup>(1)</sup>

	PARAMETER	MIN	TYP	MAX	UNIT
	Crystal frequency		48		MHz
ESR	Equivalent series resistance $6\text{ pF} < C_L \leq 9\text{ pF}$		20	60	Ω
ESR	Equivalent series resistance $5\text{ pF} < C_L \leq 6\text{ pF}$			80	Ω
$L_M$	Motional inductance, relates to the load capacitance that is used for the crystal ( $C_L$ in Farads) <sup>(5)</sup>		$< 3 \times 10^{-25} / C_L^2$		H
$C_L$	Crystal load capacitance <sup>(4)</sup>	5	7 <sup>(3)</sup>	9	pF
	Start-up time <sup>(2)</sup>		200		μs

- (1) Probing or otherwise stopping the crystal while the DC/DC converter is enabled may cause permanent damage to the device.
- (2) Start-up time using the TI-provided power driver. Start-up time may increase if driver is not used.
- (3) On-chip default connected capacitance including reference design parasitic capacitance. Connected internal capacitance is changed through software in the Customer Configuration section (CCFG).
- (4) Adjustable load capacitance is integrated into the device. External load capacitors are required for systems targeting compliance with certain regulations. See the device errata for further details.
- (5) The crystal manufacturer's specification must satisfy this requirement for proper operation.

#### 8.14.3.2 48 MHz RC Oscillator (RCOSC\_HF)

Measured on a Texas Instruments reference design with  $T_c = 25\text{ °C}$ ,  $V_{DD5} = 3.0\text{ V}$ , unless otherwise noted.

	MIN	TYP	MAX	UNIT
Frequency		48		MHz
Uncalibrated frequency accuracy		±1		%
Calibrated frequency accuracy <sup>(1)</sup>		±0.25		%
Start-up time		5		μs

- (1) Accuracy relative to the calibration source (XOSC\_HF)

### 8.14.3.3 32.768 kHz Crystal Oscillator (XOSC\_LF)

Measured on a Texas Instruments reference design with  $T_c = 25\text{ }^\circ\text{C}$ ,  $V_{DD5} = 3.0\text{ V}$ , unless otherwise noted.

		MIN	TYP	MAX	UNIT
	Crystal frequency		32.768		kHz
ESR	Equivalent series resistance		30	100	k $\Omega$
$C_L$	Crystal load capacitance	6	7 <sup>(1)</sup>	12	pF

- (1) Default load capacitance using TI reference designs including parasitic capacitance. Crystals with different load capacitance may be used.

### 8.14.3.4 32 kHz RC Oscillator (RCOSC\_LF)

Measured on a Texas Instruments reference design with  $T_c = 25\text{ }^\circ\text{C}$ ,  $V_{DD5} = 3.0\text{ V}$ , unless otherwise noted.

		MIN	TYP	MAX	UNIT
	Calibrated frequency		32.8		kHz
Calibrated RTC variation <sup>(1)</sup>	Calibrated periodically against XOSC_HF <sup>(2)</sup>		$\pm 600$ <sup>(3)</sup>		ppm
	Temperature coefficient.		50		ppm/ $^\circ\text{C}$

- (1) When using RCOSC\_LF as source for the low frequency system clock (SCLK\_LF), the accuracy of the SCLK\_LF-derived Real Time Clock (RTC) can be improved by measuring RCOSC\_LF relative to XOSC\_HF and compensating for the RTC tick speed. This functionality is available through the TI-provided Power driver.
- (2) TI driver software calibrates the RTC every time XOSC\_HF is enabled.
- (3) Some device's variation can exceed 1000 ppm. Further calibration will not improve variation.

## 8.14.4 Synchronous Serial Interface (SSI) Characteristics

### 8.14.4.1 Synchronous Serial Interface (SSI) Characteristics

over operating free-air temperature range (unless otherwise noted)

PARAMETER NO.	PARAMETER		MIN	TYP	MAX	UNIT
S1	$t_{\text{clk\_per}}$	SSIClk cycle time	12		65024	System Clocks <sup>(2)</sup>
S2 <sup>(1)</sup>	$t_{\text{clk\_high}}$	SSIClk high time		0.5		$t_{\text{clk\_per}}$
S3 <sup>(1)</sup>	$t_{\text{clk\_low}}$	SSIClk low time		0.5		$t_{\text{clk\_per}}$

- (1) Refer to SSI timing diagrams [8-1](#), [8-2](#), and [8-3](#).
- (2) When using the TI-provided Power driver, the SSI system clock is always 48 MHz.

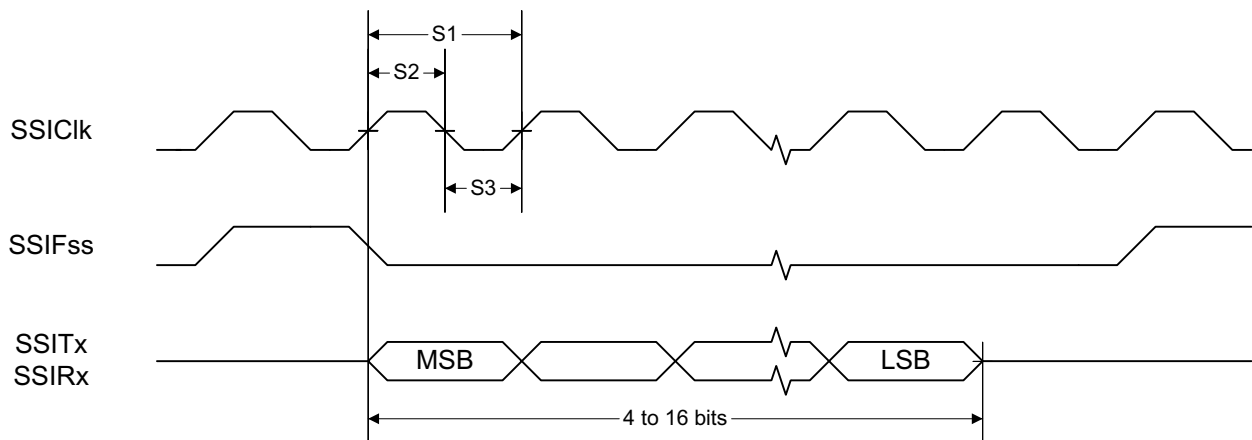

**8-1. SSI Timing for TI Frame Format (FRF = 01), Single Transfer Timing Measurement**

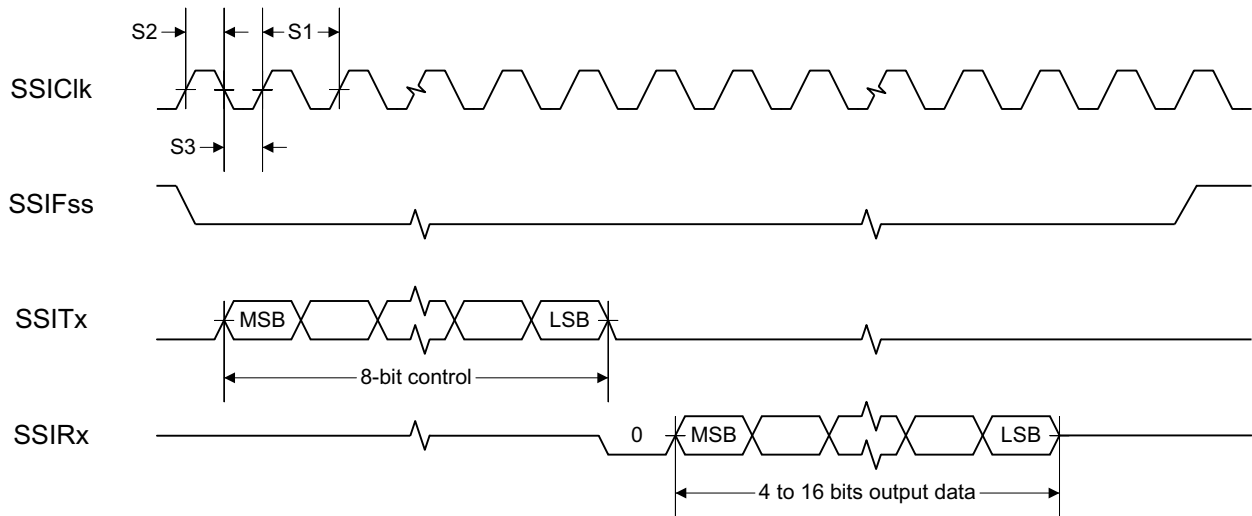

**8-2. SSI Timing for MICROWIRE Frame Format (FRF = 10), Single Transfer**

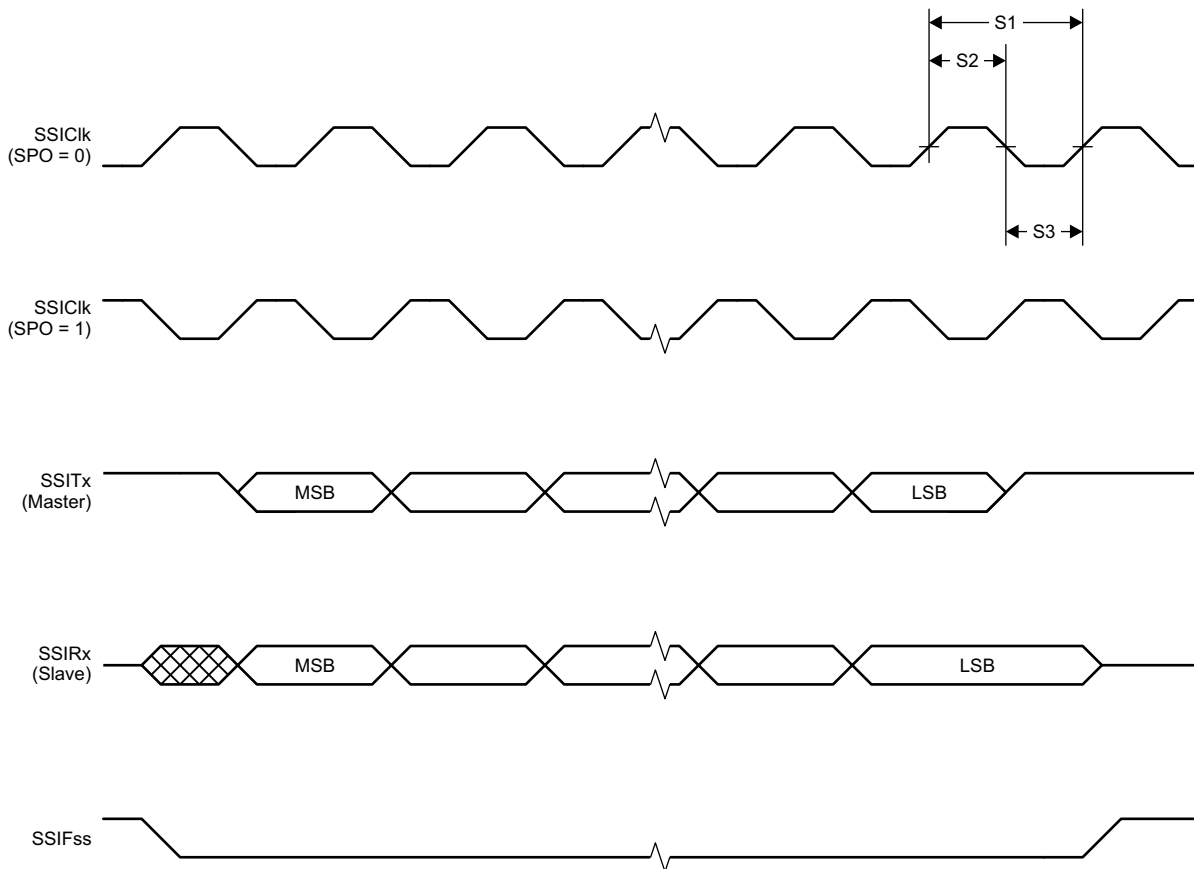

**8-3. SSI Timing for SPI Frame Format (FRF = 00), With SPH = 1**

### 8.14.5 UART

#### 8.14.5.1 UART Characteristics

over operating free-air temperature range (unless otherwise noted)

PARAMETER	MIN	TYP	MAX	UNIT
UART rate			3	MBaud

## 8.15 Peripheral Characteristics

### 8.15.1 ADC

#### 8.15.1.1 Analog-to-Digital Converter (ADC) Characteristics

$T_c = 25\text{ }^\circ\text{C}$ ,  $V_{DD5} = 3.0\text{ V}$  and voltage scaling enabled, unless otherwise noted.<sup>(1)</sup>

Performance numbers require use of offset and gain adjustments in software by TI-provided ADC drivers.

PARAMETER		TEST CONDITIONS	MIN	TYP	MAX	UNIT
	Input voltage range		0		VDDS	V
	Resolution			12		Bits
	Sample Rate				200	ksps
	Offset	Internal 4.3 V equivalent reference <sup>(2)</sup>		-0.24		LSB
	Gain error	Internal 4.3 V equivalent reference <sup>(2)</sup>		7.14		LSB
DNL <sup>(4)</sup>	Differential nonlinearity			>-1		LSB
INL	Integral nonlinearity			±4		LSB
ENOB	Effective number of bits	Internal 4.3 V equivalent reference <sup>(2)</sup> , 200 kSamples/s, 9.6 kHz input tone		9.8		Bits
		Internal 4.3 V equivalent reference <sup>(2)</sup> , 200 kSamples/s, 9.6 kHz input tone, DC/DC enabled		9.8		
		VDDS as reference, 200 kSamples/s, 9.6 kHz input tone		10.1		
		Internal reference, voltage scaling disabled, 32 samples average (software), 200 kSamples/s, 300 Hz input tone		11.1		
		Internal reference, voltage scaling disabled, 14-bit mode, 200 kSamples/s, 300 Hz input tone <sup>(5)</sup>		11.3		
		Internal reference, voltage scaling disabled, 15-bit mode, 200 kSamples/s, 300 Hz input tone <sup>(5)</sup>		11.6		
THD	Total harmonic distortion	Internal 4.3 V equivalent reference <sup>(2)</sup> , 200 kSamples/s, 9.6 kHz input tone		-65		dB
		VDDS as reference, 200 kSamples/s, 9.6 kHz input tone		-70		
		Internal reference, voltage scaling disabled, 32 samples average, 200 kSamples/s, 300 Hz input tone		-72		
SINAD, SNDR	Signal-to-noise and distortion ratio	Internal 4.3 V equivalent reference <sup>(2)</sup> , 200 kSamples/s, 9.6 kHz input tone		60		dB
		VDDS as reference, 200 kSamples/s, 9.6 kHz input tone		63		
		Internal reference, voltage scaling disabled, 32 samples average (software), 200 kSamples/s, 300 Hz input tone		68		
SFDR	Spurious-free dynamic range	Internal 4.3 V equivalent reference <sup>(2)</sup> , 200 kSamples/s, 9.6 kHz input tone		70		dB
		VDDS as reference, 200 kSamples/s, 9.6 kHz input tone		73		
		Internal reference, voltage scaling disabled, 32 samples average (software), 200 kSamples/s, 300 Hz input tone		75		
	Conversion time	Serial conversion, time-to-output, 24 MHz clock		50		Clock Cycles
	Current consumption	Internal 4.3 V equivalent reference <sup>(2)</sup>		0.39		mA
	Current consumption	VDDS as reference		0.56		mA
	Reference voltage	Equivalent fixed internal reference (input voltage scaling enabled). For best accuracy, the ADC conversion should be initiated through the TI-RTOS API in order to include the gain/offset compensation factors stored in FCFG1		4.3 <sup>(2)</sup> (3)		V
	Reference voltage	Fixed internal reference (input voltage scaling disabled). For best accuracy, the ADC conversion should be initiated through the TI-RTOS API in order to include the gain/offset compensation factors stored in FCFG1. This value is derived from the scaled value (4.3 V) as follows: $V_{ref} = 4.3\text{ V} \times 1408 / 4095$		1.48		V
	Reference voltage	VDDS as reference, input voltage scaling enabled		VDDS		V
	Reference voltage	VDDS as reference, input voltage scaling disabled		VDDS / 2.82 <sup>(3)</sup>		V

### 8.15.1.1 Analog-to-Digital Converter (ADC) Characteristics (continued)

$T_c = 25\text{ }^\circ\text{C}$ ,  $V_{DD5} = 3.0\text{ V}$  and voltage scaling enabled, unless otherwise noted.<sup>(1)</sup>

Performance numbers require use of offset and gain adjustments in software by TI-provided ADC drivers.

PARAMETER		TEST CONDITIONS	MIN	TYP	MAX	UNIT
	Input impedance	200 kSamples/s, voltage scaling enabled. Capacitive input, Input impedance depends on sampling frequency and sampling time		>1		MΩ

- (1) Using IEEE Std 1241-2010 for terminology and test methods
- (2) Input signal scaled down internally before conversion, as if voltage range was 0 to 4.3 V
- (3) Applied voltage must be within Absolute Maximum Ratings at all times
- (4) No missing codes
- (5)  $\text{ADC\_output} = \Sigma(4^n \text{ samples}) \gg n$ ,  $n =$  desired extra bits

## 8.15.2 DAC

### 8.15.2.1 Digital-to-Analog Converter (DAC) Characteristics

$T_c = 25\text{ }^\circ\text{C}$ ,  $V_{DD5} = 3.0\text{ V}$ , unless otherwise noted.

PARAMETER		TEST CONDITIONS	MIN	TYP	MAX	UNIT
<b>General Parameters</b>						
	Resolution			8		Bits
$V_{DD5}$	Supply voltage	Any load, any $V_{REF}$ , pre-charge OFF, DAC charge-pump ON	1.8		3.8	V
		External Load <sup>(4)</sup> , any $V_{REF}$ , pre-charge OFF, DAC charge-pump OFF	2.0		3.8	
		Any load, $V_{REF} = \text{DCOUPPL}$ , pre-charge ON	2.6		3.8	
$F_{DAC}$	Clock frequency	Buffer ON (recommended for external load)	16		250	kHz
		Buffer OFF (internal load)	16		1000	
	Voltage output settling time	$V_{REF} = V_{DD5}$ , buffer OFF, internal load		13		1 / $F_{DAC}$
		$V_{REF} = V_{DD5}$ , buffer ON, external capacitive load = 20 pF <sup>(3)</sup>		13.8		
	External capacitive load			20	200	pF
	External resistive load		10			MΩ
	Short circuit current				400	μA
$Z_{MAX}$	Max output impedance $V_{ref} = V_{DD5}$ , buffer ON, CLK 250 kHz	$V_{DD5} = 3.8\text{ V}$ , DAC charge-pump OFF		50.8		kΩ
		$V_{DD5} = 3.0\text{ V}$ , DAC charge-pump ON		51.7		
		$V_{DD5} = 3.0\text{ V}$ , DAC charge-pump OFF		53.2		
		$V_{DD5} = 2.0\text{ V}$ , DAC charge-pump ON		48.7		
		$V_{DD5} = 2.0\text{ V}$ , DAC charge-pump OFF		70.2		
		$V_{DD5} = 1.8\text{ V}$ , DAC charge-pump ON		46.3		
		$V_{DD5} = 1.8\text{ V}$ , DAC charge-pump OFF		88.9		
<b>Internal Load - Continuous Time Comparator / Low Power Clocked Comparator</b>						
DNL	Differential nonlinearity	$V_{REF} = V_{DD5}$ , load = Continuous Time Comparator or Low Power Clocked Comparator $F_{DAC} = 250\text{ kHz}$		±1		LSB <sup>(1)</sup>
	Differential nonlinearity	$V_{REF} = V_{DD5}$ , load = Continuous Time Comparator or Low Power Clocked Comparator $F_{DAC} = 16\text{ kHz}$		±1.2		
	Offset error <sup>(2)</sup> Load = Continuous Time Comparator	$V_{REF} = V_{DD5} = 3.8\text{ V}$		±0.64		LSB <sup>(1)</sup>
		$V_{REF} = V_{DD5} = 3.0\text{ V}$		±0.81		
		$V_{REF} = V_{DD5} = 1.8\text{ V}$		±1.27		
		$V_{REF} = \text{DCOUPPL}$ , pre-charge ON		±3.43		
		$V_{REF} = \text{DCOUPPL}$ , pre-charge OFF		±2.88		
		$V_{REF} = \text{ADCREf}$		±2.37		

### 8.15.2.1 Digital-to-Analog Converter (DAC) Characteristics (continued)

T<sub>c</sub> = 25 °C, V<sub>DD5</sub> = 3.0 V, unless otherwise noted.

PARAMETER	TEST CONDITIONS	MIN	TYP	MAX	UNIT
Offset error <sup>(2)</sup> Load = Low Power Clocked Comparator	V <sub>REF</sub> = VDD5 = 3.8 V		±0.78		LSB <sup>(1)</sup>
	V <sub>REF</sub> = VDD5 = 3.0 V		±0.77		
	V <sub>REF</sub> = VDD5 = 1.8 V		±3.46		
	V <sub>REF</sub> = DCOUPL, pre-charge ON		±3.44		
	V <sub>REF</sub> = DCOUPL, pre-charge OFF		±4.70		
	V <sub>REF</sub> = ADCREF		±4.11		
Max code output voltage variation <sup>(2)</sup> Load = Continuous Time Comparator	V <sub>REF</sub> = VDD5 = 3.8 V		±1.53		LSB <sup>(1)</sup>
	V <sub>REF</sub> = VDD5 = 3.0 V		±1.71		
	V <sub>REF</sub> = VDD5 = 1.8 V		±2.10		
	V <sub>REF</sub> = DCOUPL, pre-charge ON		±6.00		
	V <sub>REF</sub> = DCOUPL, pre-charge OFF		±3.85		
	V <sub>REF</sub> = ADCREF		±5.84		
Max code output voltage variation <sup>(2)</sup> Load = Low Power Clocked Comparator	V <sub>REF</sub> = VDD5 = 3.8 V		±2.92		LSB <sup>(1)</sup>
	V <sub>REF</sub> = VDD5 = 3.0 V		±3.06		
	V <sub>REF</sub> = VDD5 = 1.8 V		±3.91		
	V <sub>REF</sub> = DCOUPL, pre-charge ON		±7.84		
	V <sub>REF</sub> = DCOUPL, pre-charge OFF		±4.06		
	V <sub>REF</sub> = ADCREF		±6.94		
Output voltage range <sup>(2)</sup> Load = Continuous Time Comparator	V <sub>REF</sub> = VDD5 = 3.8 V, code 1		0.03		V
	V <sub>REF</sub> = VDD5 = 3.8 V, code 255		3.62		
	V <sub>REF</sub> = VDD5 = 3.0 V, code 1		0.02		
	V <sub>REF</sub> = VDD5 = 3.0 V, code 255		2.86		
	V <sub>REF</sub> = VDD5 = 1.8 V, code 1		0.01		
	V <sub>REF</sub> = VDD5 = 1.8 V, code 255		1.71		
	V <sub>REF</sub> = DCOUPL, pre-charge OFF, code 1		0.01		
	V <sub>REF</sub> = DCOUPL, pre-charge OFF, code 255		1.21		
	V <sub>REF</sub> = DCOUPL, pre-charge ON, code 1		1.27		
	V <sub>REF</sub> = DCOUPL, pre-charge ON, code 255		2.46		
	V <sub>REF</sub> = ADCREF, code 1		0.01		
	V <sub>REF</sub> = ADCREF, code 255		1.41		
	Output voltage range <sup>(2)</sup> Load = Low Power Clocked Comparator	V <sub>REF</sub> = VDD5 = 3.8 V, code 1		0.03	
V <sub>REF</sub> = VDD5 = 3.8 V, code 255			3.61		
V <sub>REF</sub> = VDD5 = 3.0 V, code 1			0.02		
V <sub>REF</sub> = VDD5 = 3.0 V, code 255			2.85		
V <sub>REF</sub> = VDD5 = 1.8 V, code 1			0.01		
V <sub>REF</sub> = VDD5 = 1.8 V, code 255			1.71		
V <sub>REF</sub> = DCOUPL, pre-charge OFF, code 1			0.01		
V <sub>REF</sub> = DCOUPL, pre-charge OFF, code 255			1.21		
V <sub>REF</sub> = DCOUPL, pre-charge ON, code 1			1.27		
V <sub>REF</sub> = DCOUPL, pre-charge ON, code 255			2.46		
V <sub>REF</sub> = ADCREF, code 1			0.01		
V <sub>REF</sub> = ADCREF, code 255			1.41		
<b>External Load (Keysight 34401A Multimeter)</b>					
INL	Integral nonlinearity	V <sub>REF</sub> = VDD5, F <sub>DAC</sub> = 250 kHz		±1	LSB <sup>(1)</sup>
		V <sub>REF</sub> = DCOUPL, F <sub>DAC</sub> = 250 kHz		±1	
		V <sub>REF</sub> = ADCREF, F <sub>DAC</sub> = 250 kHz		±1	
DNL	Differential nonlinearity	V <sub>REF</sub> = VDD5, F <sub>DAC</sub> = 250 kHz		±1	LSB <sup>(1)</sup>

### 8.15.2.1 Digital-to-Analog Converter (DAC) Characteristics (continued)

$T_c = 25\text{ }^\circ\text{C}$ ,  $V_{DD5} = 3.0\text{ V}$ , unless otherwise noted.

PARAMETER	TEST CONDITIONS	MIN	TYP	MAX	UNIT
Offset error	$V_{REF} = V_{DD5} = 3.8\text{ V}$		$\pm 0.20$		LSB <sup>(1)</sup>
	$V_{REF} = V_{DD5} = 3.0\text{ V}$		$\pm 0.25$		
	$V_{REF} = V_{DD5} = 1.8\text{ V}$		$\pm 0.45$		
	$V_{REF} = \text{DCOUPPL}$ , pre-charge ON		$\pm 1.55$		
	$V_{REF} = \text{DCOUPPL}$ , pre-charge OFF		$\pm 1.30$		
	$V_{REF} = \text{ADCREf}$		$\pm 1.10$		
Max code output voltage variation	$V_{REF} = V_{DD5} = 3.8\text{ V}$		$\pm 0.60$		LSB <sup>(1)</sup>
	$V_{REF} = V_{DD5} = 3.0\text{ V}$		$\pm 0.55$		
	$V_{REF} = V_{DD5} = 1.8\text{ V}$		$\pm 0.60$		
	$V_{REF} = \text{DCOUPPL}$ , pre-charge ON		$\pm 3.45$		
	$V_{REF} = \text{DCOUPPL}$ , pre-charge OFF		$\pm 2.10$		
	$V_{REF} = \text{ADCREf}$		$\pm 1.90$		
Output voltage range Load = Low Power Clocked Comparator	$V_{REF} = V_{DD5} = 3.8\text{ V}$ , code 1		0.03		V
	$V_{REF} = V_{DD5} = 3.8\text{ V}$ , code 255		3.61		
	$V_{REF} = V_{DD5} = 3.0\text{ V}$ , code 1		0.02		
	$V_{REF} = V_{DD5} = 3.0\text{ V}$ , code 255		2.85		
	$V_{REF} = V_{DD5} = 1.8\text{ V}$ , code 1		0.02		
	$V_{REF} = V_{DD5} = 1.8\text{ V}$ , code 255		1.71		
	$V_{REF} = \text{DCOUPPL}$ , pre-charge OFF, code 1		0.02		
	$V_{REF} = \text{DCOUPPL}$ , pre-charge OFF, code 255		1.20		
	$V_{REF} = \text{DCOUPPL}$ , pre-charge ON, code 1		1.27		
	$V_{REF} = \text{DCOUPPL}$ , pre-charge ON, code 255		2.46		
	$V_{REF} = \text{ADCREf}$ , code 1		0.02		
	$V_{REF} = \text{ADCREf}$ , code 255		1.42		

(1) 1 LSB ( $V_{REF} = 3.8\text{ V}/3.0\text{ V}/1.8\text{ V}/\text{DCOUPPL}/\text{ADCREf}$ ) = 14.10 mV/11.13 mV/6.68 mV/4.67 mV/5.48 mV

(2) Includes comparator offset

(3) A load > 20 pF will increase the settling time

(4) Keysight 34401A Multimeter

## 8.15.3 Temperature and Battery Monitor

### 8.15.3.1 Temperature Sensor

Measured on a Texas Instruments reference design with  $T_c = 25\text{ }^\circ\text{C}$ ,  $V_{\text{DDS}} = 3.0\text{ V}$ , unless otherwise noted.

PARAMETER	TEST CONDITIONS	MIN	TYP	MAX	UNIT
Resolution			2		$^\circ\text{C}$
Accuracy	$-40\text{ }^\circ\text{C}$ to $0\text{ }^\circ\text{C}$		$\pm 4.0$		$^\circ\text{C}$
Accuracy	$0\text{ }^\circ\text{C}$ to $105\text{ }^\circ\text{C}$		$\pm 2.5$		$^\circ\text{C}$
Supply voltage coefficient <sup>(1)</sup>			3.9		$^\circ\text{C}/\text{V}$

(1) The temperature sensor is automatically compensated for  $V_{\text{DDS}}$  variation when using the TI-provided driver.

### 8.15.3.2 Battery Monitor

Measured on a Texas Instruments reference design with  $T_c = 25\text{ }^\circ\text{C}$ , unless otherwise noted.

PARAMETER	TEST CONDITIONS	MIN	TYP	MAX	UNIT
Resolution			25		mV
Range		1.8		3.8	V
Integral nonlinearity (max)			23		mV
Accuracy	$V_{\text{DDS}} = 3.0\text{ V}$		22.5		mV
Offset error			-32		mV
Gain error			-1		%

## 8.15.4 Comparator

### 8.15.4.1 Continuous Time Comparator

$T_c = 25\text{ }^\circ\text{C}$ ,  $V_{\text{DDS}} = 3.0\text{ V}$ , unless otherwise noted.

PARAMETER	TEST CONDITIONS	MIN	TYP	MAX	UNIT
Input voltage range <sup>(1)</sup>		0		$V_{\text{DDS}}$	V
Offset	Measured at $V_{\text{DDS}} / 2$		$\pm 5$		mV
Decision time	Step from $-10\text{ mV}$ to $10\text{ mV}$		0.78		$\mu\text{s}$
Current consumption	Internal reference		9.2		$\mu\text{A}$

(1) The input voltages can be generated externally and connected throughout I/Os or an internal reference voltage can be generated using the DAC

## 8.15.5 GPIO

### 8.15.5.1 GPIO DC Characteristics

PARAMETER	TEST CONDITIONS	MIN	TYP	MAX	UNIT
<b><math>T_A = 25\text{ }^\circ\text{C}</math>, <math>V_{\text{DDS}} = 1.8\text{ V}</math></b>					
GPIO VOH at 8 mA load	IOCURR = 2, high-drive GPIOs only		1.56		V
GPIO VOL at 8 mA load	IOCURR = 2, high-drive GPIOs only		0.24		V
GPIO VOH at 4 mA load	IOCURR = 1		1.59		V
GPIO VOL at 4 mA load	IOCURR = 1		0.21		V
GPIO pullup current	Input mode, pullup enabled, $V_{\text{pad}} = 0\text{ V}$		73		$\mu\text{A}$
GPIO pulldown current	Input mode, pulldown enabled, $V_{\text{pad}} = V_{\text{DDS}}$		19		$\mu\text{A}$
GPIO low-to-high input transition, with hysteresis	IH = 1, transition voltage for input read as $0 \rightarrow 1$		1.08		V
GPIO high-to-low input transition, with hysteresis	IH = 1, transition voltage for input read as $1 \rightarrow 0$		0.73		V
GPIO input hysteresis	IH = 1, difference between $0 \rightarrow 1$ and $1 \rightarrow 0$ points		0.35		V
<b><math>T_A = 25\text{ }^\circ\text{C}</math>, <math>V_{\text{DDS}} = 3.0\text{ V}</math></b>					
GPIO VOH at 8 mA load	IOCURR = 2, high-drive GPIOs only		2.59		V
GPIO VOL at 8 mA load	IOCURR = 2, high-drive GPIOs only		0.42		V
GPIO VOH at 4 mA load	IOCURR = 1		2.63		V
GPIO VOL at 4 mA load	IOCURR = 1		0.40		V

### 8.15.5.1 GPIO DC Characteristics (continued)

PARAMETER	TEST CONDITIONS	MIN	TYP	MAX	UNIT
<b>T<sub>A</sub> = 25 °C, V<sub>DDs</sub> = 3.8 V</b>					
GPIO pullup current	Input mode, pullup enabled, V <sub>pad</sub> = 0 V		282		μA
GPIO pulldown current	Input mode, pulldown enabled, V <sub>pad</sub> = V <sub>DDs</sub>		110		μA
GPIO low-to-high input transition, with hysteresis	IH = 1, transition voltage for input read as 0 → 1		1.97		V
GPIO high-to-low input transition, with hysteresis	IH = 1, transition voltage for input read as 1 → 0		1.55		V
GPIO input hysteresis	IH = 1, difference between 0 → 1 and 1 → 0 points		0.42		V
<b>T<sub>A</sub> = 25 °C</b>					
VIH	Lowest GPIO input voltage reliably interpreted as a <i>High</i>	0.8*V <sub>DDs</sub>			V
VIL	Highest GPIO input voltage reliably interpreted as a <i>Low</i>			0.2*V <sub>DDs</sub>	V

## 8.16 Typical Characteristics

All measurements in this section are done with  $T_c = 25\text{ }^\circ\text{C}$  and  $V_{DD5} = 3.0\text{ V}$ , unless otherwise noted. See *Recommended Operating Conditions*, [セクション 8.3](#), for device limits. Values exceeding these limits are for reference only.

### 8.16.1 MCU Current

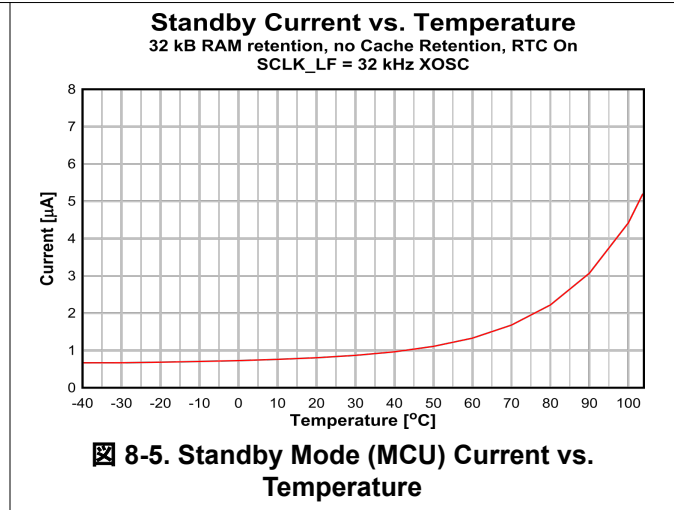
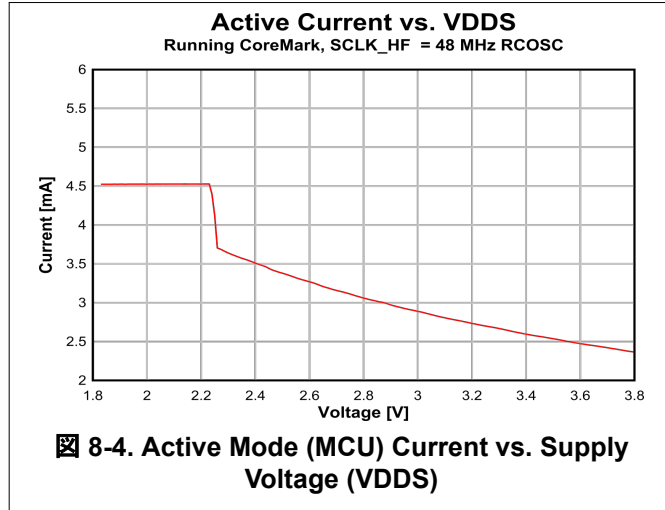

### 8.16.2 RX Current

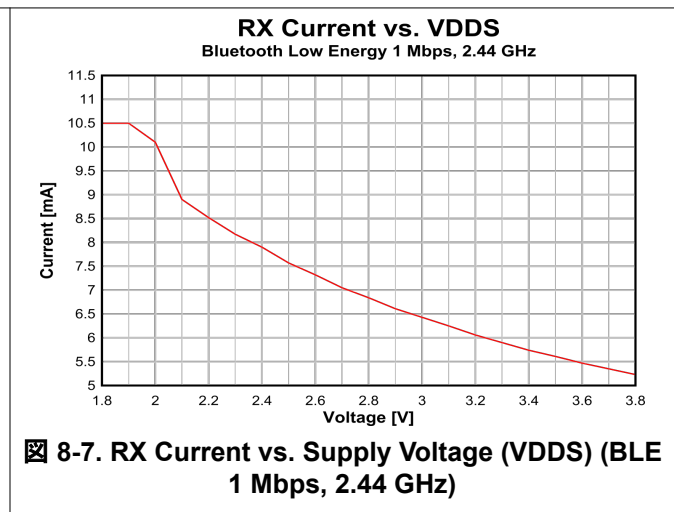
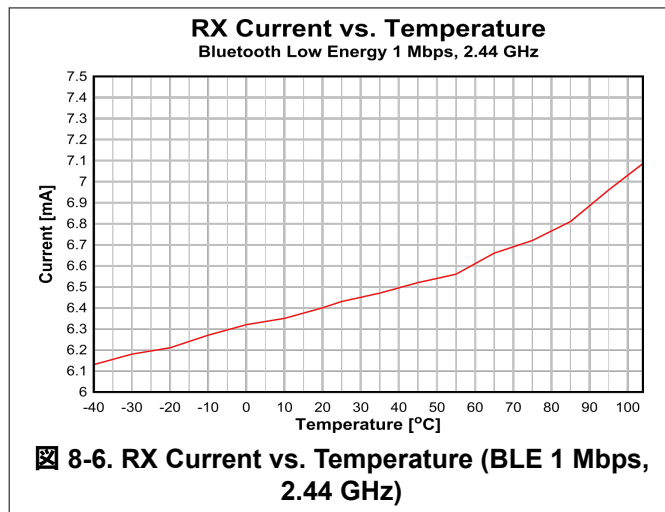

8.16.3 TX Current

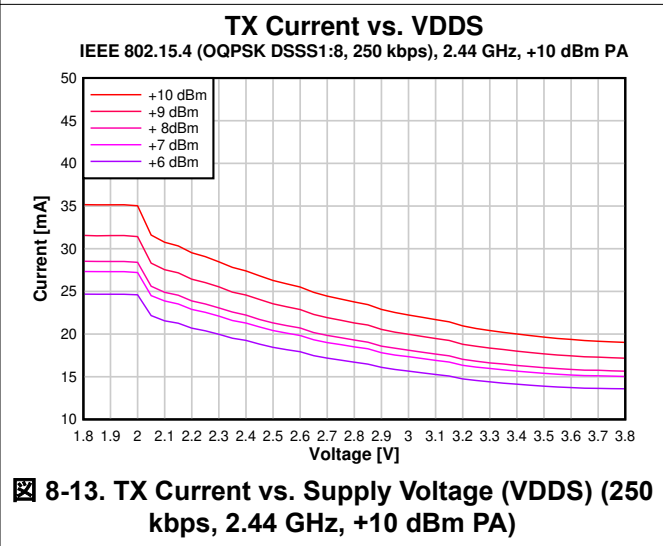
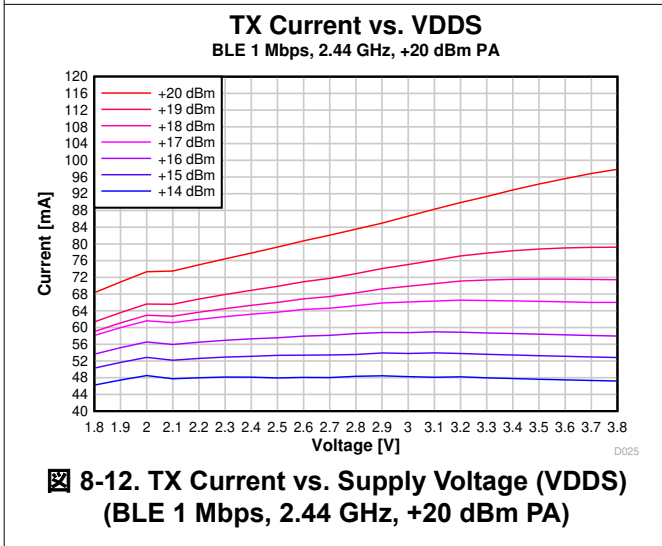
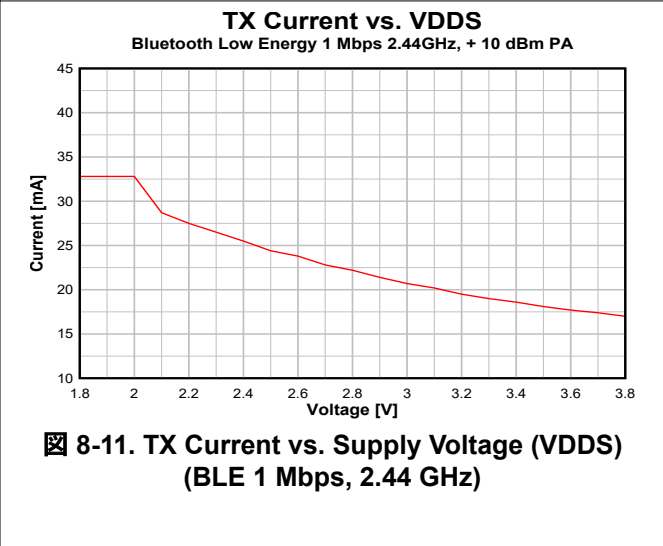
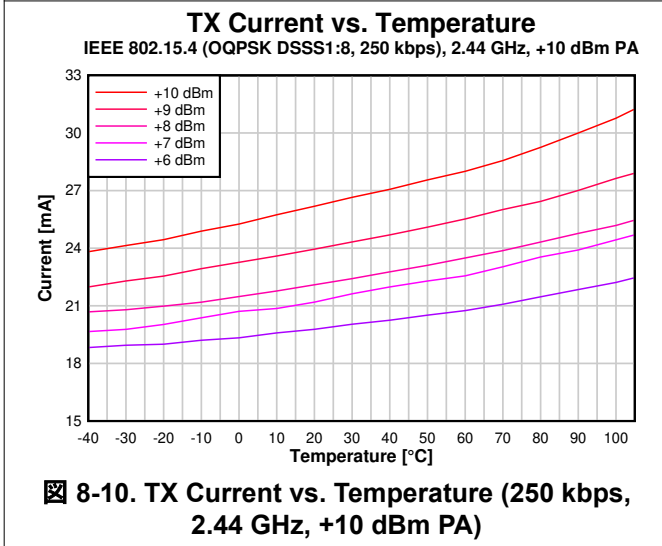
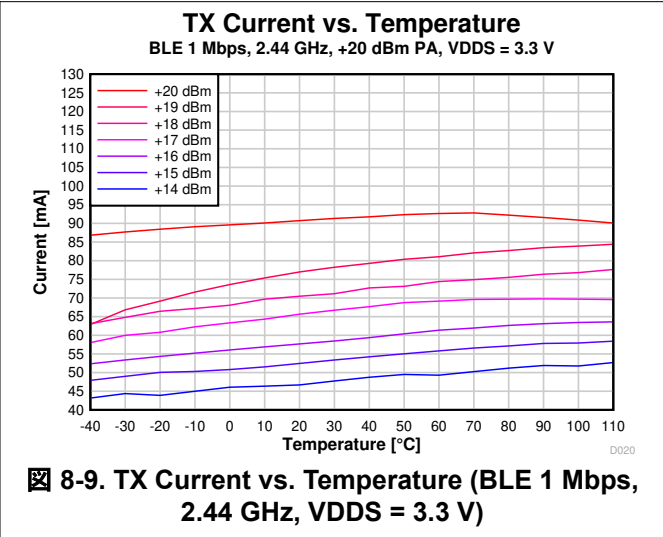
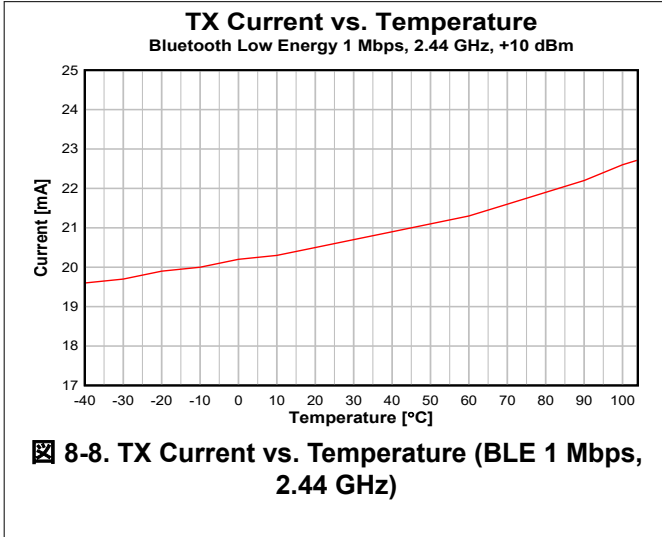

**表 8-1. Typical TX Current and Output Power, regular PA**

CC2651P3 at 2.4 GHz, VDD5 = 3.0 V (Measured on CC2651-P3EM-7XD24-PA24)			
txPower	TX Power Setting (SmartRF Studio)	Typical Output Power [dBm]	Typical Current Consumption [mA]
0x701F	5	5.5	12.5
0x3A17	4	4.5	11.9
0x3A64	3	3.1	11.2
0x325F	2	2.0	10.8
0x2C5C	1	1.3	10.5
0x2659	0	0.4	10.2
0x1697	-3	-2.8	9.4
0x1693	-5	-4.8	8.9
0x1292	-6	-5.4	8.8
0xCD3	-9	-9.0	8.4
0xAD1	-10	-10.4	8.2
0xACF	-12	-12.0	8.1
0x6CD	-15	-13.7	7.9
0x6CA	-18	-16.8	7.7
0x4C8	-20	-19.3	7.6

**表 8-2. Typical TX Current and Output Power, high power PA, 10 dBm mode**

CC2651P3 at 2.4 GHz, VDD5 = 3.0 V (Measured on CC261-P3EM-5XS24-PA24_10dBm)			
txPower	TX Power Setting (SmartRF Studio)	Typical Output Power [dBm]	Typical Current Consumption [mA]
0x14395A	10	10.1	23.6
0x142F55	9	9.0	22.1
0x62F35	8	7.8	21.1
0x63930	7	6.9	20.1
0x6292B	6	5.9	19.1

**表 8-3. Typical TX Current and Output Power, high power PA, 20 dBm mode**

CC2651P3 at 2.4 GHz, VDD5 = 3.3 V (Measured on CC2651-P3EM-7XD24-PA24)			
txPower	TX Power Setting (SmartRF Studio)	Typical Output Power [dBm]	Typical Current Consumption [mA]
0x3F75F5	20	20.0	100.1
0x3F61E2	19	19.4	91.1
0x3047E0	18	19.0	86.4
0x1B4FE5	17	18.1	78.3
0x1B39DE	16	17.3	71.8
0x1B2FDA	15	16.7	67.1
0x1B27D6	14	15.9	61.8

8.16.4 RX Performance

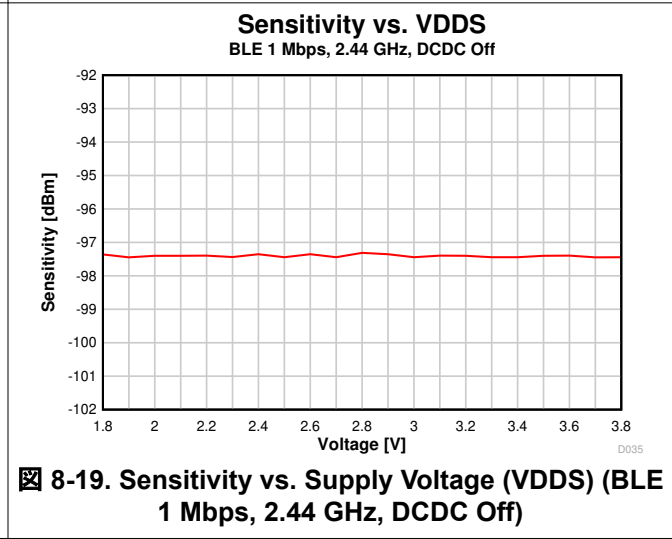
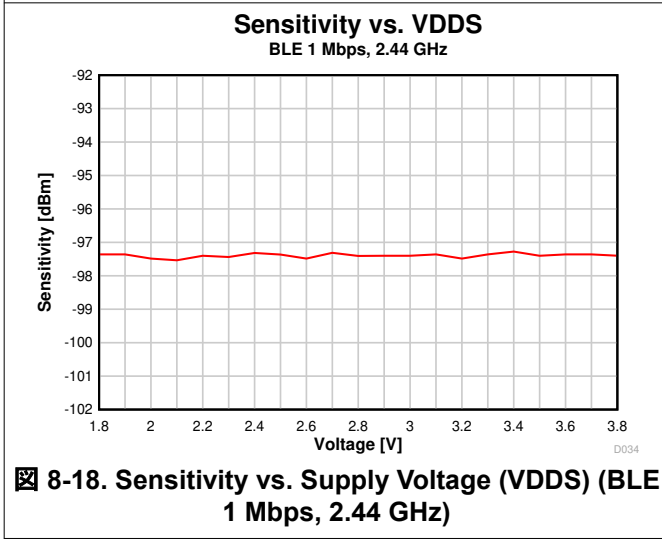
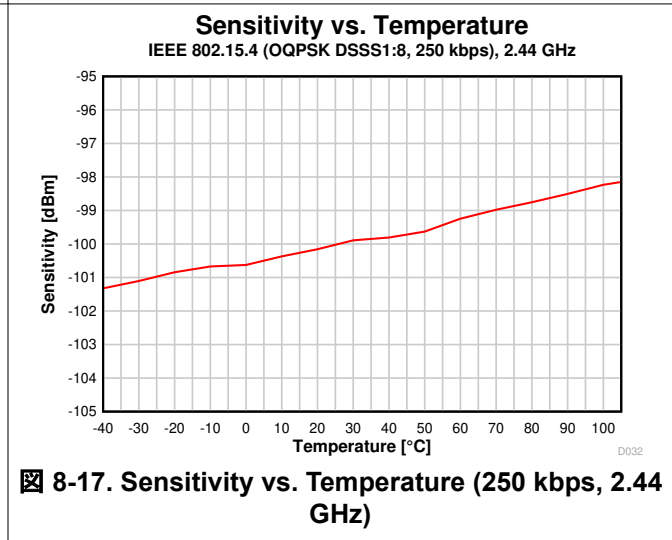
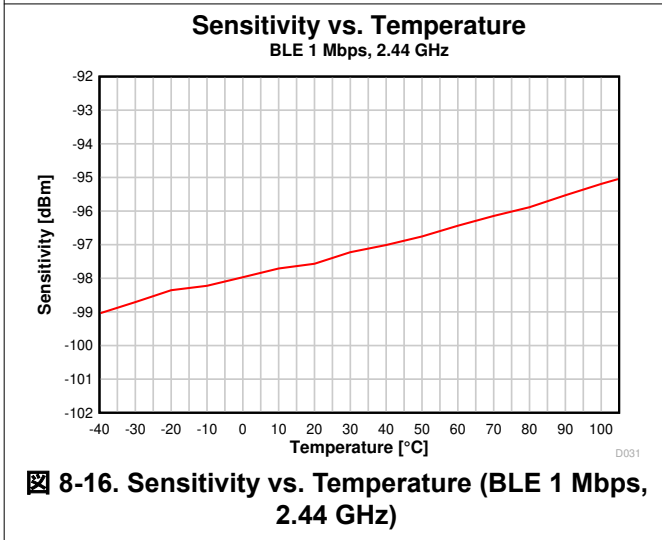
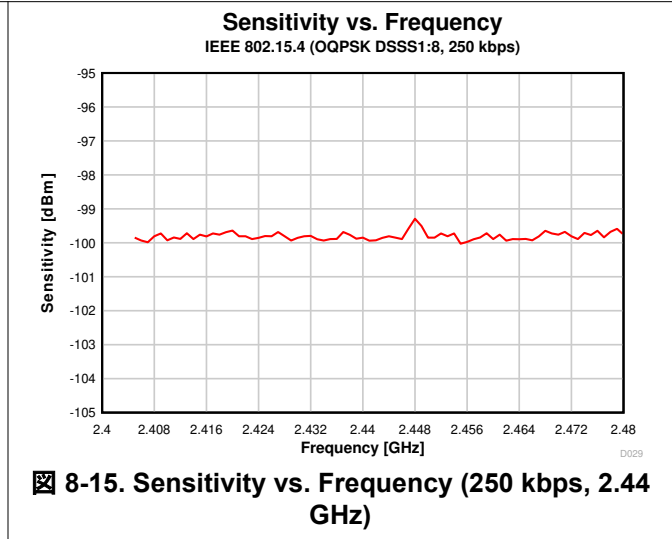
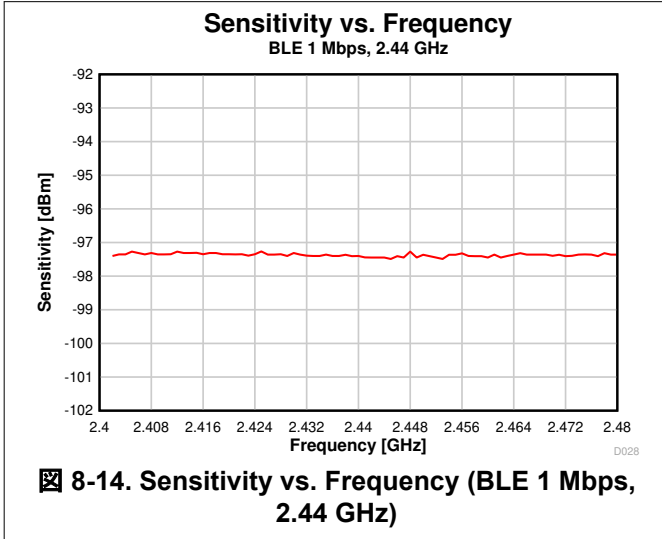

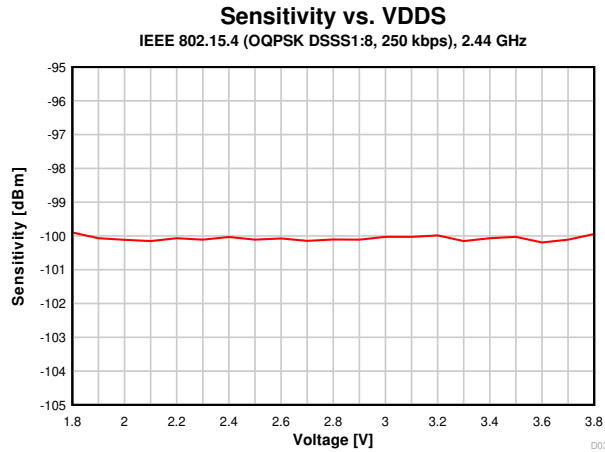

8-20. Sensitivity vs. Supply Voltage (VDD5) (250 kbps, 2.44 GHz)

8.16.5 TX Performance

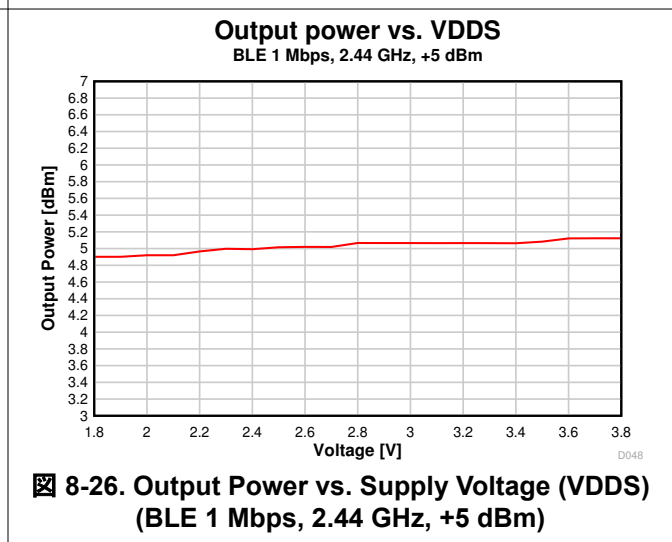
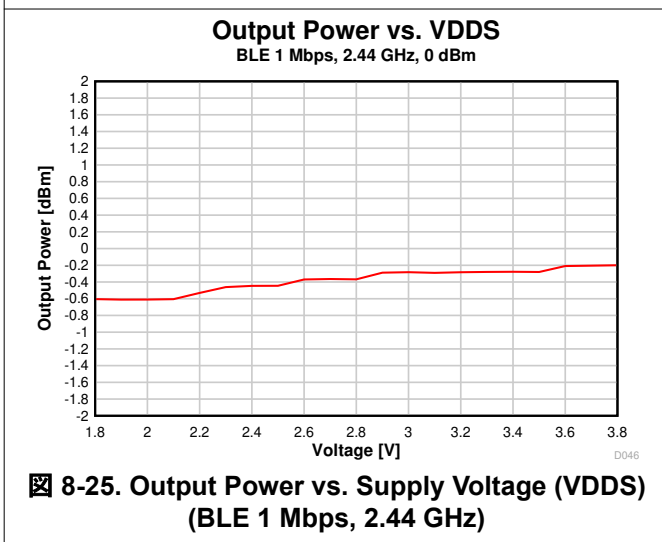
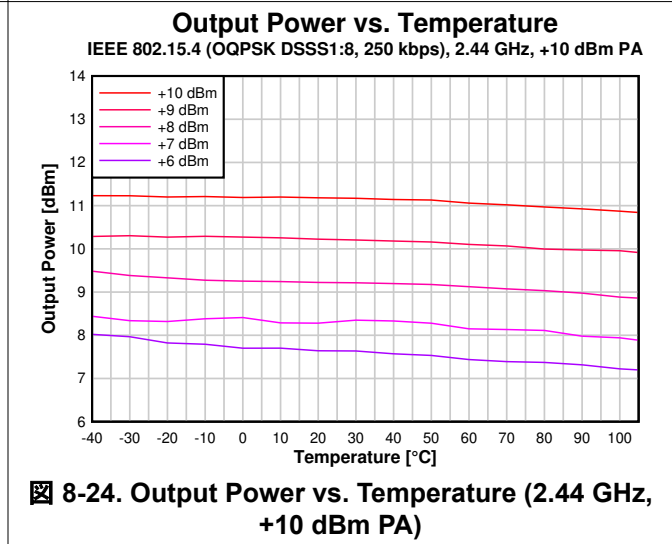
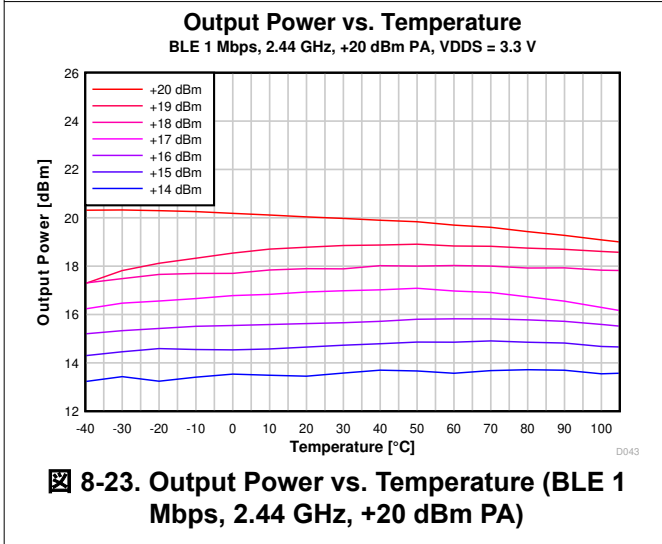
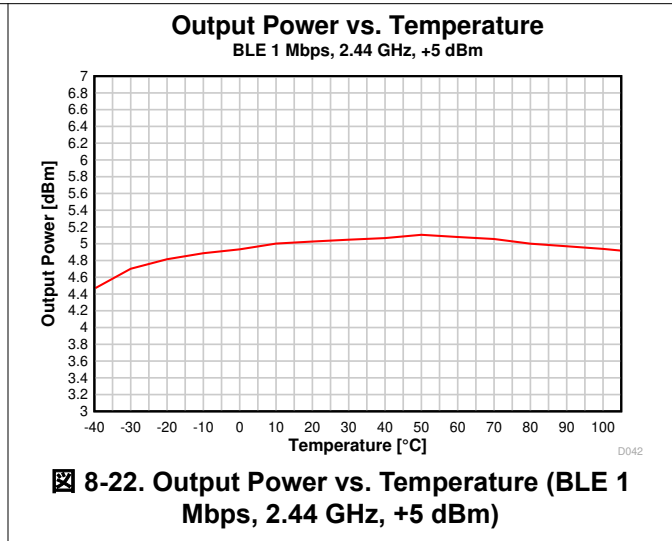
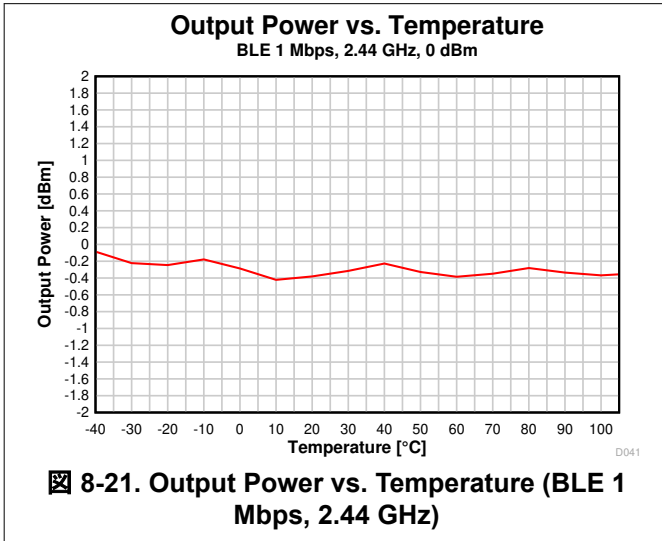

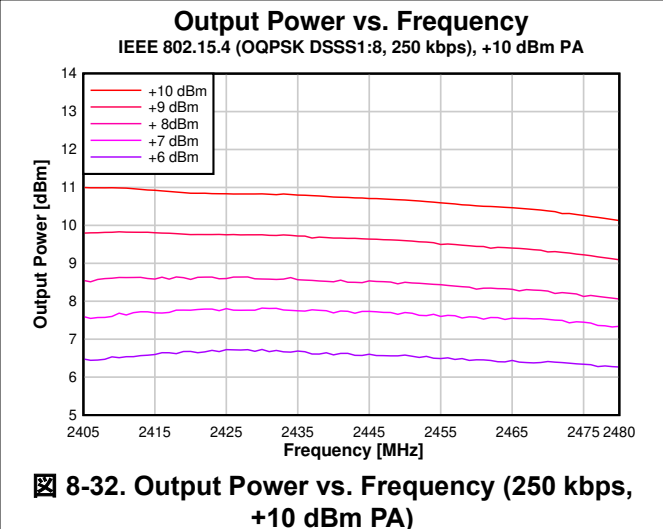
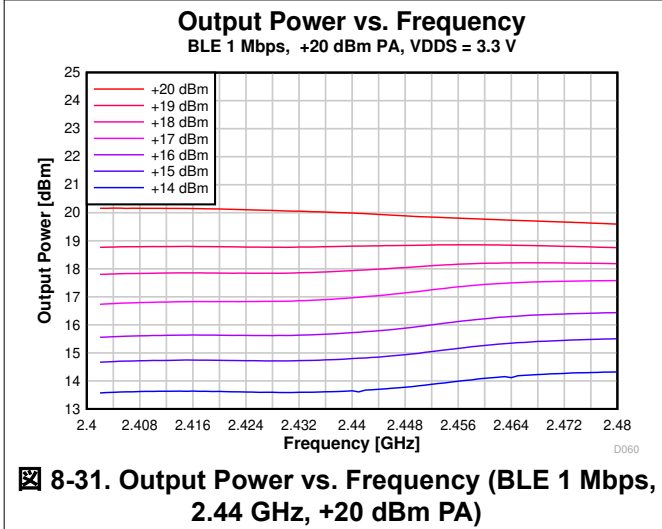
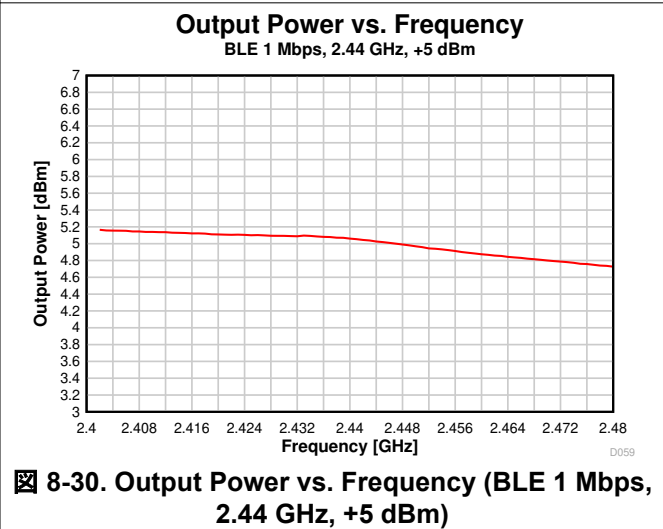
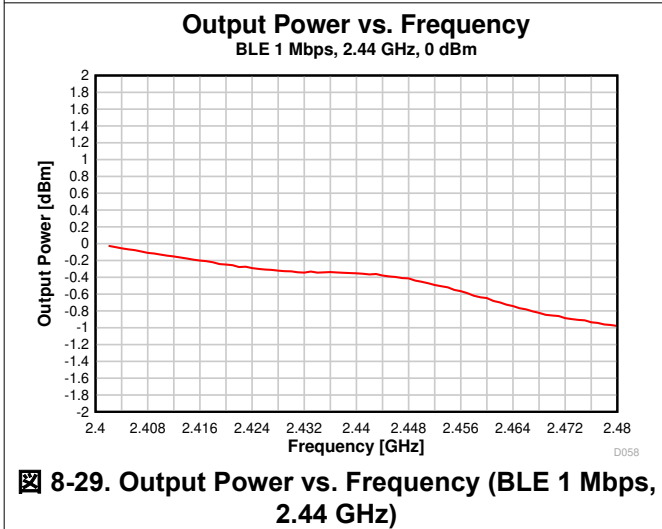
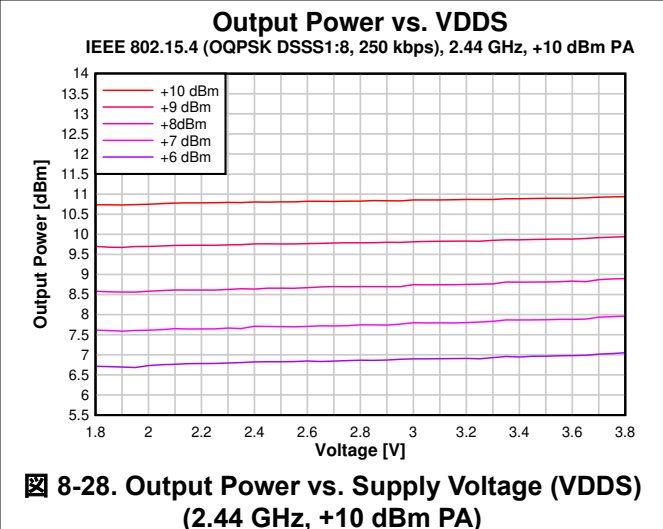
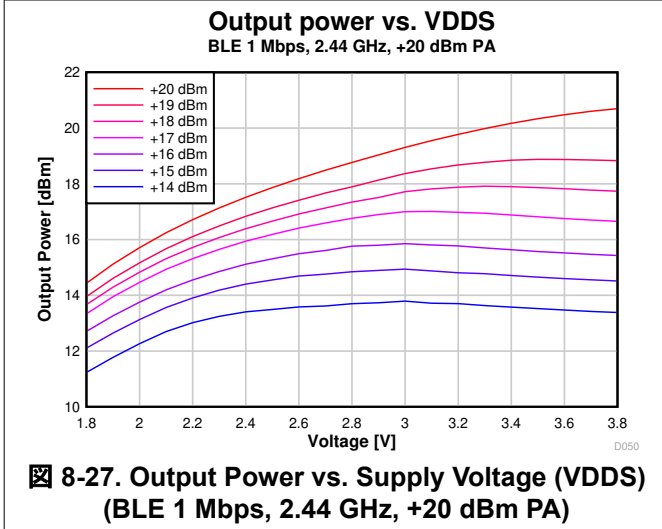

### 8.16.6 ADC Performance

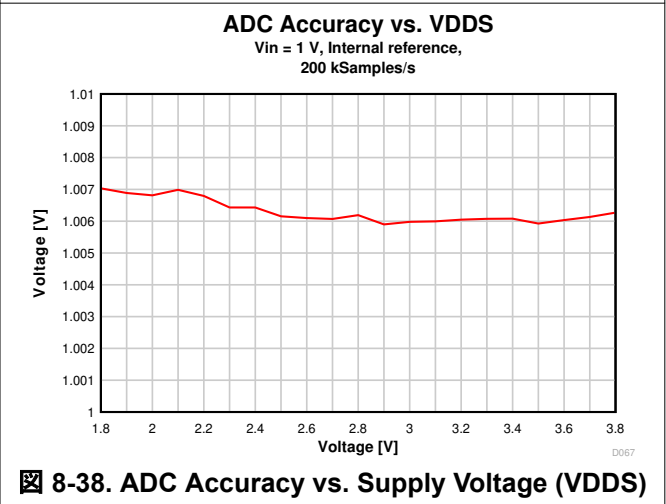
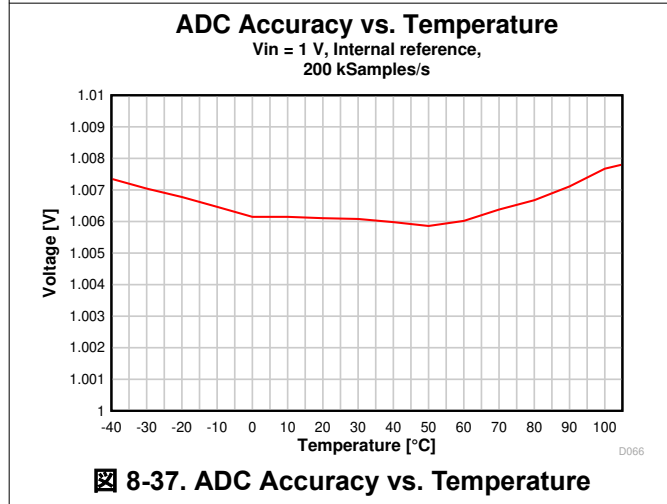
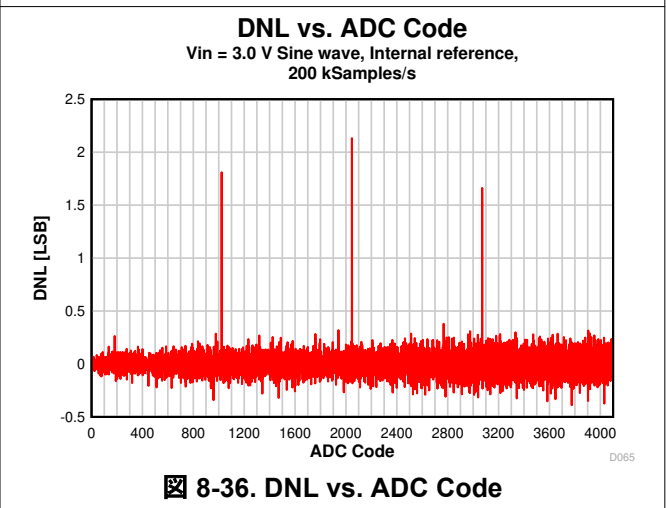
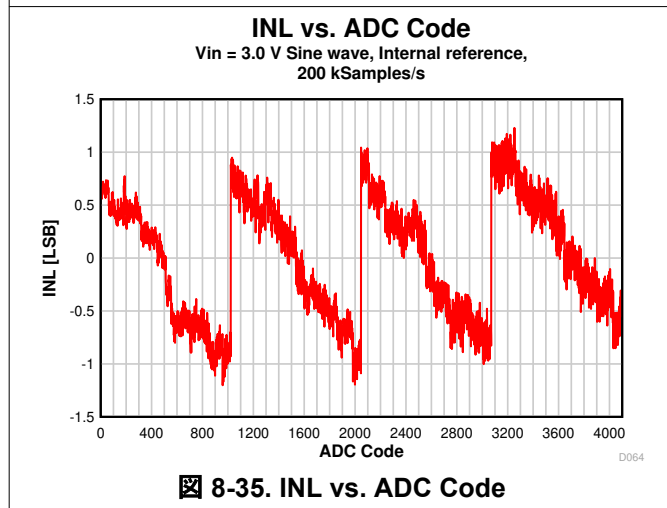
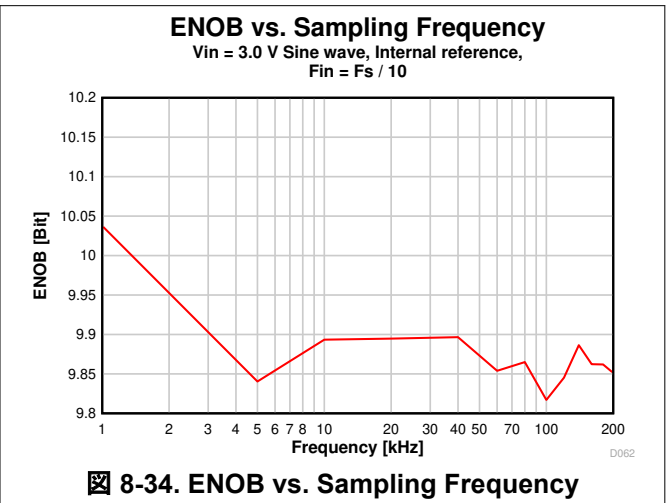
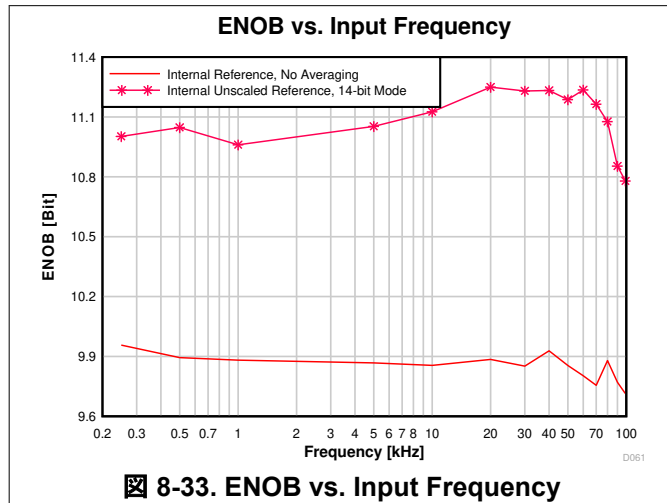

## 9 Detailed Description

### 9.1 Overview

[セクション 4](#) shows the core modules of the CC2651P3 device.

### 9.2 System CPU

The CC2651P3 SimpleLink™ Wireless MCU contains an Arm® Cortex®-M4 system CPU, which runs the application and the higher layers of radio protocol stacks.

The system CPU is the foundation of a high-performance, low-cost platform that meets the system requirements of minimal memory implementation, and low-power consumption, while delivering outstanding computational performance and exceptional system response to interrupts.

Its features include the following:

- ARMv7-M architecture optimized for small-footprint embedded applications
- Arm Thumb®-2 mixed 16- and 32-bit instruction set delivers the high performance expected of a 32-bit Arm core in a compact memory size
- Fast code execution permits increased sleep mode time
- Deterministic, high-performance interrupt handling for time-critical applications
- Single-cycle multiply instruction and hardware divide
- Hardware division and fast digital-signal-processing oriented multiply accumulate
- Saturating arithmetic for signal processing
- Full debug with data matching for watchpoint generation
  - Data Watchpoint and Trace Unit (DWT)
  - JTAG Debug Access Port (DAP)
  - Flash Patch and Breakpoint Unit (FPB)
- Trace support reduces the number of pins required for debugging and tracing
  - Instrumentation Trace Macrocell Unit (ITM)
  - Trace Port Interface Unit (TPIU) with asynchronous serial wire output (SWO)
- Optimized for single-cycle flash memory access
- Tightly connected to 8-KB 4-way random replacement cache for minimal active power consumption and wait states
- Ultra-low-power consumption with integrated sleep modes
- 48 MHz operation
- 1.25 DMIPS per MHz

## 9.3 Radio (RF Core)

The RF Core is a highly flexible and future proof radio module which contains an Arm Cortex-M0 processor that interfaces the analog RF and base-band circuitry, handles data to and from the system CPU side, and assembles the information bits in a given packet structure. The RF core offers a high level, command-based API to the main CPU that configurations and data are passed through. The Arm Cortex-M0 processor is not programmable by customers and is interfaced through the TI-provided RF driver that is included with the SimpleLink Software Development Kit (SDK).

The RF core can autonomously handle the time-critical aspects of the radio protocols, thus offloading the main CPU, which reduces power and leaves more resources for the user application. Several signals are also available to control external circuitry such as RF switches or range extenders autonomously.

The various physical layer radio formats are partly built as a software defined radio where the radio behavior is either defined by radio ROM contents or by non-ROM radio formats delivered in form of firmware patches with the SimpleLink SDKs. This allows the radio platform to be updated for support of future versions of standards even with over-the-air (OTA) updates while still using the same silicon.

### 9.3.1 Bluetooth 5.2 Low Energy

The RF Core offers full support for Bluetooth 5.2 Low Energy, including the high-speed 2-Mbps physical layer and the 500-kbps and 125-kbps long range PHYs (Coded PHY) through the TI provided Bluetooth 5.2 stack or through a high-level Bluetooth API.

The new high-speed mode allows data transfers up to 2 Mbps, twice the speed of Bluetooth 4.2 and five times the speed of Bluetooth 4.0, without increasing power consumption. In addition to faster speeds, this mode offers significant improvements for energy efficiency and wireless coexistence with reduced radio communication time.

Bluetooth 5.2 also enables unparalleled flexibility for adjustment of speed and range based on application needs, which capitalizes on the high-speed or long-range modes respectively. Data transfers are now possible at 2 Mbps, enabling development of applications using voice, audio, imaging, and data logging that were not previously an option using Bluetooth low energy. With high-speed mode, existing applications deliver faster responses, richer engagement, and longer battery life. Bluetooth 5.2 enables fast, reliable firmware updates.

### 9.3.2 802.15.4 (Zigbee and 6LoWPAN)

Through a dedicated IEEE radio API, the RF Core supports the 2.4-GHz IEEE 802.15.4-2011 physical layer (2 Mcps per second Offset-QPSK with DSSS 1:8), used in Zigbee and 6LoWPAN protocols. TI provides royalty-free protocol stacks for Zigbee as part of the SimpleLink SDK, enabling a robust end-to-end solution.

## 9.4 Memory

The up to 352-KB nonvolatile (Flash) memory provides storage for code and data. The flash memory is in-system programmable and erasable. The last flash memory sector must contain a Customer Configuration section (CCFG) that is used by boot ROM and TI provided drivers to configure the device. This configuration is done through the `ccfg.c` source file that is included in all TI provided examples.

The ultra-low leakage system static RAM (SRAM) is a single 32-KB block and can be used for both storage of data and execution of code. Retention of SRAM contents in Standby power mode is enabled by default and included in Standby mode power consumption numbers.

To improve code execution speed and lower power when executing code from nonvolatile memory, a 4-way nonassociative 8-KB cache is enabled by default to cache and prefetch instructions read by the system CPU. The cache can be used as a general-purpose RAM by enabling this feature in the Customer Configuration Area (CCFG).

The ROM contains a serial (SPI and UART) bootloader that can be used for initial programming of the device.

## 9.5 Cryptography

The CC2651P3 device comes with a wide set of cryptography-related hardware accelerators, reducing code footprint and execution time for cryptographic operations. It also has the benefit of being lower power and improves availability and responsiveness of the system because the cryptography operations run in a background hardware thread.

The hardware accelerator modules are:

- **True Random Number Generator (TRNG)** module provides a true, nondeterministic noise source for the purpose of generating keys, initialization vectors (IVs), and other random number requirements. The TRNG is built on 24 ring oscillators that create unpredictable output to feed a complex nonlinear-combinatorial circuit.
- **Advanced Encryption Standard (AES)** with 128 bit key lengths

Together with the hardware accelerator module, a large selection of open-source cryptography libraries provided with the Software Development Kit (SDK), this allows for secure and future proof IoT applications to be easily built on top of the platform. The TI provided cryptography drivers are:

- **Key Agreement Schemes**
  - Elliptic curve Diffie–Hellman with static or ephemeral keys (ECDH and ECDHE)
- **Signature Generation**
  - Elliptic curve Diffie–Hellman Digital Signature Algorithm (ECDSA)
- **Curve Support**
  - Short Weierstrass form (full hardware support), such as:
    - NIST-P256
  - Montgomery form (hardware support for multiplication), such as:
    - Curve25519
- **Hash**
  - SHA256
- **MACs**
  - HMAC with SHA256
  - AES CBC-MAC
- **Block ciphers**
  - AESECB
  - AESCBC
  - AESCTR
- **Authenticated Encryption**
  - AESCCM
- **Random number generation**
  - True Random Number Generator
  - AES CTR DRBG

## 9.6 Timers

A large selection of timers are available as part of the CC2651P3 device. These timers are:

- **Real-Time Clock (RTC)**

A 70-bit 3-channel timer running on the 32 kHz low frequency system clock (SCLK\_LF)

This timer is available in all power modes except Shutdown. The timer can be calibrated to compensate for frequency drift when using the LF RCOSC as the low frequency system clock. If an external LF clock with frequency different from 32.768 kHz is used, the RTC tick speed can be adjusted to compensate for this. When using TI-RTOS, the RTC is used as the base timer in the operating system and should thus only be accessed through the kernel APIs such as the Clock module. By default, the RTC halts when a debugger halts the device.

- **General Purpose Timers (GPTIMER)**

The four flexible GPTIMERS can be used as either 4× 32 bit timers or 8× 16 bit timers, all running on up to 48 MHz. Each of the 16- or 32-bit timers support a wide range of features such as one-shot or periodic counting, pulse width modulation (PWM), time counting between edges and edge counting. The inputs and outputs of the timer are connected to the device event fabric, which allows the timers to interact with signals such as GPIO inputs, other timers, DMA and ADC. The GPTIMERS are available in Active and Idle power modes.

- **Radio Timer**

A multichannel 32-bit timer running at 4 MHz is available as part of the device radio. The radio timer is typically used as the timing base in wireless network communication using the 32-bit timing word as the network time. The radio timer is synchronized with the RTC by using a dedicated radio API when the device radio is turned on or off. This ensures that for a network stack, the radio timer seems to always be running when the radio is enabled. The radio timer is in most cases used indirectly through the trigger time fields in the radio APIs and should only be used when running the accurate 48 MHz high frequency crystal is the source of SCLK\_HF.

- **Watchdog timer**

The watchdog timer is used to regain control if the system operates incorrectly due to software errors. It is typically used to generate an interrupt to and reset of the device for the case where periodic monitoring of the system components and tasks fails to verify proper functionality. The watchdog timer runs on a 1.5 MHz clock rate and cannot be stopped once enabled. The watchdog timer pauses to run in Standby power mode and when a debugger halts the device.

## 9.7 Serial Peripherals and I/O

The SSI is a synchronous serial interface that is compatible with SPI, MICROWIRE, and TI's synchronous serial interfaces. The SSI support both SPI master and slave up to 4 MHz. The SSI module support configurable phase and polarity.

The UART implement universal asynchronous receiver and transmitter functions. It support flexible baud-rate generation up to a maximum of 3 Mbps.

The I<sup>2</sup>S interface is used to handle digital audio and can also be used to interface pulse-density modulation microphones (PDM).

The I<sup>2</sup>C interface is also used to communicate with devices compatible with the I<sup>2</sup>C standard. The I<sup>2</sup>C interface can handle 100 kHz and 400 kHz operation, and can serve as both master and slave.

The I/O controller (IOC) controls the digital I/O pins and contains multiplexer circuitry to allow a set of peripherals to be assigned to I/O pins in a flexible manner. All digital I/Os are interrupt and wake-up capable, have a programmable pullup and pulldown function, and can generate an interrupt on a negative or positive edge (configurable). When configured as an output, pins can function as either push-pull or open-drain. Five GPIOs have high-drive capabilities, which are marked in **bold** in [セクション 7](#). All digital peripherals can be connected to any digital pin on the device.

For more information, see the [CC13x1x3, CC26x1x3 SimpleLink™ Wireless MCU Technical Reference Manual](#).

## 9.8 Battery and Temperature Monitor

A combined temperature and battery voltage monitor is available in the CC2651P3 device. The battery and temperature monitor allows an application to continuously monitor on-chip temperature and supply voltage and respond to changes in environmental conditions as needed. The module contains window comparators to interrupt the system CPU when temperature or supply voltage go outside defined windows. These events can also be used to wake up the device from Standby mode through the Always-On (AON) event fabric.

## 9.9 $\mu$ DMA

The device includes a direct memory access ( $\mu$ DMA) controller. The  $\mu$ DMA controller provides a way to offload data-transfer tasks from the system CPU, thus allowing for more efficient use of the processor and the available bus bandwidth. The  $\mu$ DMA controller can perform a transfer between memory and peripherals. The  $\mu$ DMA controller has dedicated channels for each supported on-chip module and can be programmed to automatically perform transfers between peripherals and memory when the peripheral is ready to transfer more data.

Some features of the  $\mu$ DMA controller include the following (this is not an exhaustive list):

- Highly flexible and configurable channel operation of up to 32 channels
- Transfer modes: memory-to-memory, memory-to-peripheral, peripheral-to-memory, and peripheral-to-peripheral
- Data sizes of 8, 16, and 32 bits
- Ping-pong mode for continuous streaming of data

## 9.10 Debug

The on-chip debug support is done through a dedicated cJTAG (IEEE 1149.7) or JTAG (IEEE 1149.1) interface. The device boots by default into cJTAG mode and must be reconfigured to use 4-pin JTAG.

## 9.11 Power Management

To minimize power consumption, the CC2651P3 supports a number of power modes and power management features (see [表 9-1](#)).

**表 9-1. Power Modes**

MODE	SOFTWARE CONFIGURABLE POWER MODES				RESET PIN HELD
	ACTIVE	IDLE	STANDBY	SHUTDOWN	
<b>CPU</b>	Active	Off	Off	Off	Off
<b>Flash</b>	On	Available	Off	Off	Off
<b>SRAM</b>	On	On	Retention	Off	Off
<b>Supply System</b>	On	On	Duty Cycled	Off	Off
Register and CPU retention	Full	Full	Partial	No	No
SRAM retention	Full	Full	Full	No	No
48 MHz high-speed clock (SCLK_HF)	XOSC_HF or RCOSC_HF	XOSC_HF or RCOSC_HF	Off	Off	Off
32 kHz low-speed clock (SCLK_LF)	XOSC_LF or RCOSC_LF	XOSC_LF or RCOSC_LF	XOSC_LF or RCOSC_LF	Off	Off
Peripherals	Available	Available	Off	Off	Off
Wake-up on RTC	Available	Available	Available	Off	Off
Wake-up on pin edge	Available	Available	Available	Available	Off
Wake-up on reset pin	On	On	On	On	On
Brownout detector (BOD)	On	On	Duty Cycled	Off	Off
Power-on reset (POR)	On	On	On	Off	Off
Watchdog timer (WDT)	Available	Available	Paused	Off	Off

In **Active** mode, the application system CPU is actively executing code. Active mode provides normal operation of the processor and all of the peripherals that are currently enabled. The system clock can be any available clock source (see [表 9-1](#)).

In **Idle** mode, all active peripherals can be clocked, but the Application CPU core and memory are not clocked and no code is executed. Any interrupt event brings the processor back into active mode.

In **Standby** mode, only the always-on (AON) domain is active. An external wake-up event or RTC event is required to bring the device back to active mode. MCU peripherals with retention do not need to be reconfigured when waking up again, and the CPU continues execution from where it went into standby mode. All GPIOs are latched in standby mode.

In **Shutdown** mode, the device is entirely turned off (including the AON domain), and the I/Os are latched with the value they had before entering shutdown mode. A change of state on any I/O pin defined as a *wake from shutdown pin* wakes up the device and functions as a reset trigger. The CPU can differentiate between reset in this way and reset-by-reset pin or power-on reset by reading the reset status register. The only state retained in this mode is the latched I/O state and the flash memory contents.

### Note

The power, RF and clock management for the CC2651P3 device require specific configuration and handling by software for optimized performance. This configuration and handling is implemented in the TI-provided drivers that are part of the CC2651P3 software development kit (SDK). Therefore, TI highly recommends using this software framework for all application development on the device. The complete [SDK](#) with TI-RTOS (optional), device drivers, and examples are offered free of charge in source code.

## 9.12 Clock Systems

The CC2651P3 device has several internal system clocks.

The 48 MHz SCLK\_HF is used as the main system (MCU and peripherals) clock. This can be driven by the internal 48 MHz RC Oscillator (RCOSC\_HF) or an external 48 MHz crystal (XOSC\_HF). Radio operation requires an external 48 MHz crystal.

SCLK\_LF is the 32.768 kHz internal low-frequency system clock. It can be used for the RTC and to synchronize the radio timer before or after Standby power mode. SCLK\_LF can be driven by the internal 32.8 kHz RC Oscillator (RCOSC\_LF), a 32.768 kHz watch-type crystal, or a clock input on any digital IO.

When using a crystal or the internal RC oscillator, the device can output the 32 kHz SCLK\_LF signal to other devices, thereby reducing the overall system cost.

## 9.13 Network Processor

Depending on the product configuration, the CC2651P3 device can function as a wireless network processor (WNP - a device running the wireless protocol stack with the application running on a separate host MCU), or as a system-on-chip (SoC) with the application and protocol stack running on the system CPU inside the device.

In the first case, the external host MCU communicates with the device using SPI or UART. In the second case, the application must be written according to the application framework supplied with the wireless protocol stack.

## 10 Application, Implementation, and Layout

### Note

以下のアプリケーション情報は、TI の製品仕様に含まれるものではなく、TI ではその正確性または完全性を保証いたしません。個々の目的に対する製品の適合性については、お客様の責任で判断していただくこととなります。お客様は自身の設計実装を検証しテストすることで、システムの機能を確認する必要があります。

For general design guidelines and hardware configuration guidelines, refer to [CC13xx/CC26xx Hardware Configuration and PCB Design Considerations Application Report](#).

For optimum RF performance, especially when using the high-power PA, it is important to accurately follow the reference design with respect to component values and layout. Failure to do so may lead to reduced RF performance due to balun mismatch. The amplitude- and phase balance through the balun must be <1 dB and <6 degrees, respectively.

PCB stack-up is also critical for proper operation. The CC2651P3 EVMs and characterization boards use a finished thickness between the top layer (RF signals) and layer 2 (ground plane) of 175  $\mu\text{m}$ . It is very important to use the same substrate thickness, or slightly thicker, in an end product implementing the CC2651P3 device.

### 10.1 Reference Designs

The following reference designs should be followed closely when implementing designs using the CC2651P3 device.

Special attention must be paid to RF component placement, decoupling capacitors and DCDC regulator components, as well as ground connections for all of these.

#### [CC26x1-P3EM-5XS24-PA24\\_10dBm Design Files](#)

The CC26x1PEM-5XS24-PA24\_10dBm reference design provides schematic, layout and production files for the characterization board used for deriving the performance number found in this document. This design is optimized for operating the high power PA at 10 dBm output power and is using a single-ended front-end configuration with external LNA bias for RX.

#### [CC26x1-P3EM-7XD24-PA24 Design Files](#)

The CC26x1-P3EM-7XD24-PA24 reference design provides schematic, layout and production files for the characterization board used for deriving the performance number found in this document. This design is configured for 20 dBm operation on the high output power PA.

#### [LP-CC2651P3 Design Files](#)

The CC2651P3 LaunchPad Design Files contain detailed schematics and layouts to build application specific boards using the CC2651P3 device.

#### [Sub-1 GHz and 2.4 GHz Antenna Kit for LaunchPad™ Development Kit and SensorTag](#)

The antenna kit allows real-life testing to identify the optimal antenna for your application. The antenna kit includes 16 antennas for frequencies from 169 MHz to 2.4 GHz, including:

- PCB antennas
- Helical antennas
- Chip antennas
- Dual-band antennas for 868 MHz and 915 MHz combined with 2.4 GHz

The antenna kit includes a JSC cable to connect to the Wireless MCU LaunchPad Development Kits and SensorTags.

## 11 Device and Documentation Support

TI offers an extensive line of development tools. Tools and software to evaluate the performance of the device, generate code, and develop solutions are listed as follows.

### 11.1 Device Nomenclature

To designate the stages in the product development cycle, TI assigns prefixes to all part numbers and/or date-code. Each device has one of three prefixes/identifications: X, P, or null (no prefix) (for example, XCC2651P3 is in preview; therefore, an X prefix/identification is assigned).

Device development evolutionary flow:

- X** Experimental device that is not necessarily representative of the final device's electrical specifications and may not use production assembly flow.
- P** Prototype device that is not necessarily the final silicon die and may not necessarily meet final electrical specifications.
- null** Production version of the silicon die that is fully qualified.

Support tool development evolutionary flow:

- TMDX** Development-support product that has not yet completed Texas Instruments internal qualification testing.
- TMDS** Fully-qualified development-support product.

X and P devices and TMDX development-support tools are shipped against the following disclaimer:

"Developmental product is intended for internal evaluation purposes."

Production devices and TMDS development-support tools have been characterized fully, and the quality and reliability of the device have been demonstrated fully. TI's standard warranty applies.

Predictions show that prototype devices (X or P) have a greater failure rate than the standard production devices. Texas Instruments recommends that these devices not be used in any production system because their expected end-use failure rate still is undefined. Only qualified production devices are to be used.

TI device nomenclature also includes a suffix with the device family name. This suffix indicates the package type (for example, RGZ).

For orderable part numbers of CC2651P3 devices in the RGZ (7-mm x 7-mm) package type, see the *Package Option Addendum* of this document, the Device Information in [セクション 3](#), the TI website ([www.ti.com](http://www.ti.com)), or contact your TI sales representative.

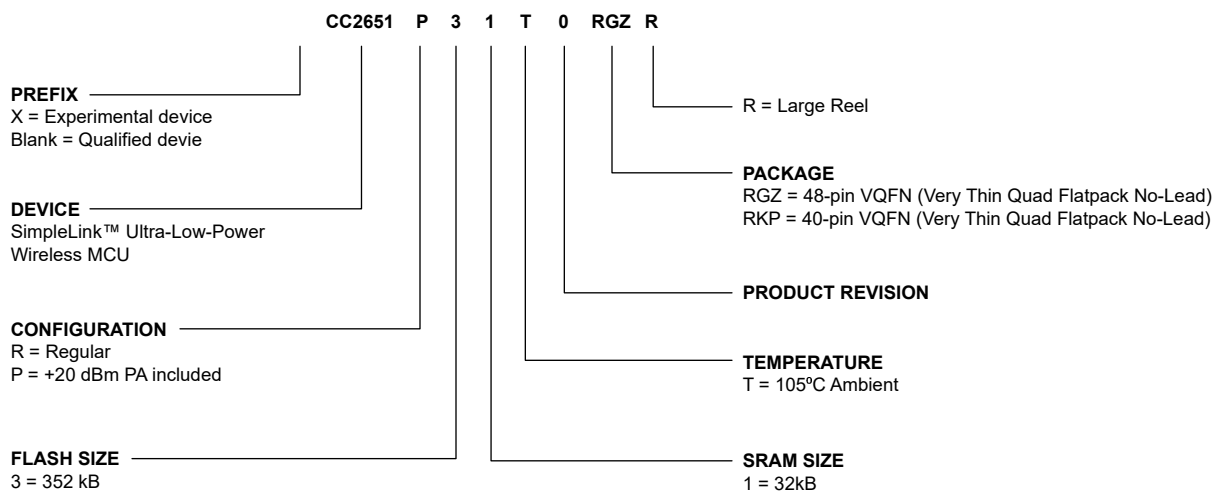

11-1. Device Nomenclature

## 11.2 Tools and Software

The CC2651P3 device is supported by a variety of software and hardware development tools.

### Development Kit

#### [CC2651P3 LaunchPad™ Development Kit](#)

The CC2651P3 LaunchPad™ Development Kit enables development of high-performance wireless applications that benefit from low-power operation. The kit features the CC2651P3 SimpleLink Wireless MCU, which allows you to quickly evaluate and prototype 2.4-GHz wireless applications such as Bluetooth 5 Low Energy, Zigbee and Thread, plus combinations of these. The kit works with the LaunchPad ecosystem, easily enabling additional functionality like sensors, display and more.

### Software

#### [SimpleLink™ CC13XX- CC26XX SDK](#)

The SimpleLink CC13xx and CC26xx Software Development Kit (SDK) provides a complete package for the development of wireless applications on the CC13XX / CC26XX family of devices. The SDK includes a comprehensive software package for the CC2651P3 device, including the following protocol stacks:

- Bluetooth Low Energy 4 and 5.2
- Thread (based on OpenThread)
- Zigbee 3.0
- Wi-SUN®
- TI 15.4-Stack - an IEEE 802.15.4-based star networking solution for Sub-1 GHz and 2.4 GHz
- Proprietary RF - a large set of building blocks for building proprietary RF software
- Multiprotocol support - concurrent operation between stacks using the Dynamic Multiprotocol Manager (DMM)

The SimpleLink CC13XX-CC26XX SDK is part of TI's SimpleLink MCU platform, offering a single development environment that delivers flexible hardware, software and tool options for customers developing wired and wireless applications. For more information about the SimpleLink MCU Platform, visit <http://www.ti.com/simplelink>.

## Development Tools

### Code Composer Studio™ Integrated Development Environment (IDE)

Code Composer Studio is an integrated development environment (IDE) that supports TI's Microcontroller and Embedded Processors portfolio. Code Composer Studio comprises a suite of tools used to develop and debug embedded applications. It includes an optimizing C/C++ compiler, source code editor, project build environment, debugger, profiler, and many other features. The intuitive IDE provides a single user interface taking you through each step of the application development flow. Familiar tools and interfaces allow users to get started faster than ever before. Code Composer Studio combines the advantages of the Eclipse® software framework with advanced embedded debug capabilities from TI resulting in a compelling feature-rich development environment for embedded developers.

CCS has support for all SimpleLink Wireless MCUs and includes support for EnergyTrace™ software (application energy usage profiling). A real-time object viewer plugin is available for TI-RTOS, part of the SimpleLink SDK.

Code Composer Studio is provided free of charge when used in conjunction with the XDS debuggers included on a LaunchPad Development Kit.

### Code Composer Studio™ Cloud IDE

Code Composer Studio (CCS) Cloud is a web-based IDE that allows you to create, edit and build CCS and Energia™ projects. After you have successfully built your project, you can download and run on your connected LaunchPad. Basic debugging, including features like setting breakpoints and viewing variable values is now supported with CCS Cloud.

### IAR Embedded Workbench® for Arm®

IAR Embedded Workbench® is a set of development tools for building and debugging embedded system applications using assembler, C and C++. It provides a completely integrated development environment that includes a project manager, editor, and build tools. IAR has support for all SimpleLink Wireless MCUs. It offers broad debugger support, including XDS110, IAR I-jet™ and Segger J-Link™. A real-time object viewer plugin is available for TI-RTOS, part of the SimpleLink SDK. IAR is also supported out-of-the-box on most software examples provided as part of the SimpleLink SDK.

A 30-day evaluation or a 32 KB size-limited version is available through [iar.com](http://iar.com).

### SmartRF™ Studio

SmartRF™ Studio is a Windows® application that can be used to evaluate and configure SimpleLink Wireless MCUs from Texas Instruments. The application will help designers of RF systems to easily evaluate the radio at an early stage in the design process. It is especially useful for generation of configuration register values and for practical testing and debugging of the RF system. SmartRF Studio can be used either as a standalone application or together with applicable evaluation boards or debug probes for the RF device. Features of the SmartRF Studio include:

- Link tests - send and receive packets between nodes
- Antenna and radiation tests - set the radio in continuous wave TX and RX states
- Export radio configuration code for use with the TI SimpleLink SDK RF driver
- Custom GPIO configuration for signaling and control of external switches

### CCS UniFlash

CCS UniFlash is a standalone tool used to program on-chip flash memory on TI MCUs. UniFlash has a GUI, command line, and scripting interface. CCS UniFlash is available free of charge.

### 11.2.1 SimpleLink™ Microcontroller Platform

The SimpleLink microcontroller platform sets a new standard for developers with the broadest portfolio of wired and wireless Arm® MCUs (System-on-Chip) in a single software development environment. Delivering flexible hardware, software and tool options for your IoT applications. Invest once in the SimpleLink software development kit and use throughout your entire portfolio. Learn more on [ti.com/simplelink](https://ti.com/simplelink).

### 11.3 Documentation Support

To receive notification of documentation updates on data sheets, errata, application notes and similar, navigate to the device product folder on [ti.com/product/CC2651P3](https://ti.com/product/CC2651P3). In the upper right corner, click on *Alert me* to register and receive a weekly digest of any product information that has changed. For change details, review the revision history included in any revised document.

The current documentation that describes the MCU, related peripherals, and other technical collateral is listed as follows.

#### TI Resource Explorer

[TI Resource Explorer](#) Software examples, libraries, executables, and documentation are available for your device and development board.

#### Errata

[CC2651P3 Silicon Errata](#) The silicon errata describes the known exceptions to the functional specifications for each silicon revision of the device and description on how to recognize a device revision.

#### Application Reports

All application reports for the CC2651P3 device are found on the device product folder at: [ti.com/product/CC2651P3/#tech-docs](https://ti.com/product/CC2651P3/#tech-docs).

#### Technical Reference Manual (TRM)

[CC13x1x, CC26x1x SimpleLink™ Wireless MCU TRM](#) The TRM provides a detailed description of all modules and peripherals available in the device family.

### 11.4 サポート・リソース

[TI E2E™ サポート・フォーラム](#)は、エンジニアが検証済みの回答と設計に関するヒントをエキスパートから迅速かつ直接得ることができる場所です。既存の回答を検索したり、独自の質問をしたりすることで、設計に必要な支援を迅速に得ることができます。

リンクされているコンテンツは、該当する貢献者により、現状のまま提供されるものです。これらは TI の仕様を構成するものではなく、必ずしも TI の見解を反映したものではありません。TI の[使用条件](#)を参照してください。

### 11.5 Trademarks

SimpleLink™, LaunchPad™, Code Composer Studio™, EnergyTrace™, and TI E2E™ are trademarks of Texas Instruments.

I-jet™ is a trademark of IAR Systems AB.

J-Link™ is a trademark of SEGGER Microcontroller Systeme GmbH.

Arm® and Cortex® are registered trademarks of Arm Limited (or its subsidiaries) in the US and/or elsewhere.

CoreMark® is a registered trademark of Embedded Microprocessor Benchmark Consortium Corporation.

ZigBee® is a registered trademark of Zigbee Alliance Inc.

Bluetooth® is a registered trademark of Bluetooth SIG Inc.

Arm Thumb® is a registered trademark of Arm Limited (or its subsidiaries).

Wi-SUN® is a registered trademark of Wi-SUN Alliance Inc.

Eclipse® is a registered trademark of Eclipse Foundation.

IAR Embedded Workbench® is a registered trademark of IAR Systems AB.

Windows® is a registered trademark of Microsoft Corporation.

すべての商標は、それぞれの所有者に帰属します。

## 11.6 Electrostatic Discharge Caution



This integrated circuit can be damaged by ESD. Texas Instruments recommends that all integrated circuits be handled with appropriate precautions. Failure to observe proper handling and installation procedures can cause damage.

ESD damage can range from subtle performance degradation to complete device failure. Precision integrated circuits may be more susceptible to damage because very small parametric changes could cause the device not to meet its published specifications.

## 11.7 Glossary

### [TI Glossary](#)

This glossary lists and explains terms, acronyms, and definitions.

## 12 Mechanical, Packaging, and Orderable Information

**PACKAGING INFORMATION**

Orderable part number	Status (1)	Material type (2)	Package   Pins	Package qty   Carrier	RoHS (3)	Lead finish/ Ball material (4)	MSL rating/ Peak reflow (5)	Op temp (°C)	Part marking (6)
<a href="#">CC2651P31T0RGZR</a>	Active	Production	VQFN (RGZ)   48	2500   LARGE T&R	Yes	NIPDAU	Level-3-260C-168 HR	-40 to 105	CC2651 P31
CC2651P31T0RGZR.A	Active	Production	VQFN (RGZ)   48	2500   LARGE T&R	Yes	NIPDAU	Level-3-260C-168 HR	-40 to 105	CC2651 P31
CC2651P31T0RGZR.B	Active	Production	VQFN (RGZ)   48	2500   LARGE T&R	Yes	NIPDAU	Level-3-260C-168 HR	-40 to 105	CC2651 P31
<a href="#">CC2651P31T0RKPR</a>	Active	Production	VQFN (RKP)   40	3000   LARGE T&R	Yes	NIPDAU	Level-3-260C-168 HR	-40 to 105	CC2651 P31
CC2651P31T0RKPR.A	Active	Production	VQFN (RKP)   40	3000   LARGE T&R	Yes	NIPDAU	Level-3-260C-168 HR	-40 to 105	CC2651 P31
CC2651P31T0RKPR.B	Active	Production	VQFN (RKP)   40	3000   LARGE T&R	Yes	NIPDAU	Level-3-260C-168 HR	-40 to 105	CC2651 P31
CC2651P31T0RKPRG4	Active	Production	VQFN (RKP)   40	3000   LARGE T&R	Yes	NIPDAU	Level-3-260C-168 HR	-40 to 105	CC2651 P31
CC2651P31T0RKPRG4.A	Active	Production	VQFN (RKP)   40	3000   LARGE T&R	Yes	NIPDAU	Level-3-260C-168 HR	-40 to 105	CC2651 P31
CC2651P31T0RKPRG4.B	Active	Production	VQFN (RKP)   40	3000   LARGE T&R	Yes	NIPDAU	Level-3-260C-168 HR	-40 to 105	CC2651 P31

(1) **Status:** For more details on status, see our [product life cycle](#).

(2) **Material type:** When designated, preproduction parts are prototypes/experimental devices, and are not yet approved or released for full production. Testing and final process, including without limitation quality assurance, reliability performance testing, and/or process qualification, may not yet be complete, and this item is subject to further changes or possible discontinuation. If available for ordering, purchases will be subject to an additional waiver at checkout, and are intended for early internal evaluation purposes only. These items are sold without warranties of any kind.

(3) **RoHS values:** Yes, No, RoHS Exempt. See the [TI RoHS Statement](#) for additional information and value definition.

(4) **Lead finish/Ball material:** Parts may have multiple material finish options. Finish options are separated by a vertical ruled line. Lead finish/Ball material values may wrap to two lines if the finish value exceeds the maximum column width.

(5) **MSL rating/Peak reflow:** The moisture sensitivity level ratings and peak solder (reflow) temperatures. In the event that a part has multiple moisture sensitivity ratings, only the lowest level per JEDEC standards is shown. Refer to the shipping label for the actual reflow temperature that will be used to mount the part to the printed circuit board.

**(6) Part marking:** There may be an additional marking, which relates to the logo, the lot trace code information, or the environmental category of the part.

Multiple part markings will be inside parentheses. Only one part marking contained in parentheses and separated by a "-" will appear on a part. If a line is indented then it is a continuation of the previous line and the two combined represent the entire part marking for that device.

**Important Information and Disclaimer:**The information provided on this page represents TI's knowledge and belief as of the date that it is provided. TI bases its knowledge and belief on information provided by third parties, and makes no representation or warranty as to the accuracy of such information. Efforts are underway to better integrate information from third parties. TI has taken and continues to take reasonable steps to provide representative and accurate information but may not have conducted destructive testing or chemical analysis on incoming materials and chemicals. TI and TI suppliers consider certain information to be proprietary, and thus CAS numbers and other limited information may not be available for release.

In no event shall TI's liability arising out of such information exceed the total purchase price of the TI part(s) at issue in this document sold by TI to Customer on an annual basis.

**TAPE AND REEL INFORMATION**

**QUADRANT ASSIGNMENTS FOR PIN 1 ORIENTATION IN TAPE**

\*All dimensions are nominal

Device	Package Type	Package Drawing	Pins	SPQ	Reel Diameter (mm)	Reel Width W1 (mm)	A0 (mm)	B0 (mm)	K0 (mm)	P1 (mm)	W (mm)	Pin1 Quadrant
CC2651P31T0RGZR	VQFN	RGZ	48	2500	330.0	16.4	7.3	7.3	1.1	12.0	16.0	Q2
CC2651P31T0RGZR	VQFN	RGZ	48	2500	330.0	16.4	7.3	7.3	1.1	12.0	16.0	Q2
CC2651P31T0RKPR	VQFN	RKP	40	3000	330.0	12.4	5.3	5.3	1.1	8.0	12.0	Q2
CC2651P31T0RKPR	VQFN	RKP	40	3000	330.0	12.4	5.3	5.3	1.1	8.0	12.0	Q2
CC2651P31T0RKPRG4	VQFN	RKP	40	3000	330.0	12.4	5.3	5.3	1.1	8.0	12.0	Q2

**TAPE AND REEL BOX DIMENSIONS**

\*All dimensions are nominal

Device	Package Type	Package Drawing	Pins	SPQ	Length (mm)	Width (mm)	Height (mm)
CC2651P31T0RGZR	VQFN	RGZ	48	2500	360.0	360.0	36.0
CC2651P31T0RGZR	VQFN	RGZ	48	2500	367.0	367.0	35.0
CC2651P31T0RKPR	VQFN	RKP	40	3000	360.0	360.0	36.0
CC2651P31T0RKPR	VQFN	RKP	40	3000	367.0	367.0	35.0
CC2651P31T0RKPRG4	VQFN	RKP	40	3000	367.0	367.0	35.0

## GENERIC PACKAGE VIEW

**RKP 40**

**VQFN - 1 mm max height**

5 x 5, 0.4 mm pitch

PLASTIC QUAD FLATPACK - NO LEAD

This image is a representation of the package family, actual package may vary.  
Refer to the product data sheet for package details.

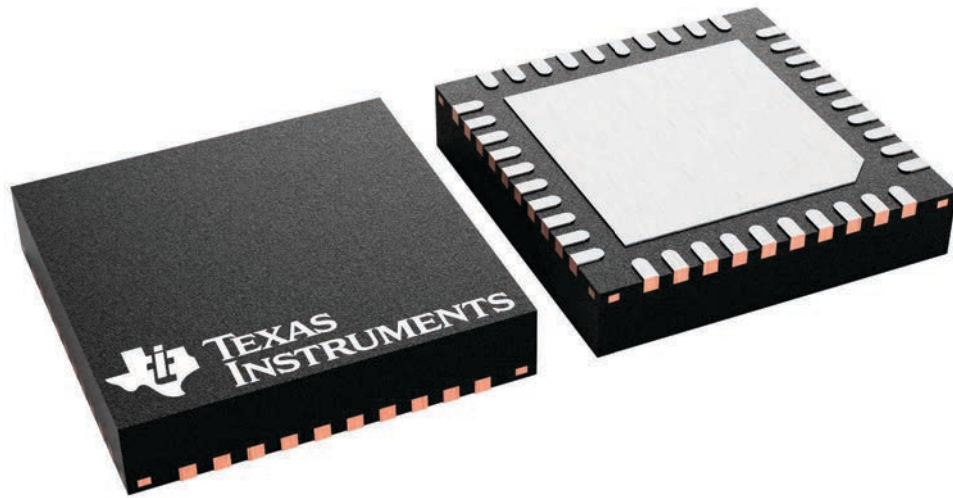

4229305/A



# EXAMPLE BOARD LAYOUT

RKP0040B

VQFN - 1 mm max height

PLASTIC QUAD FLATPACK- NO LEAD

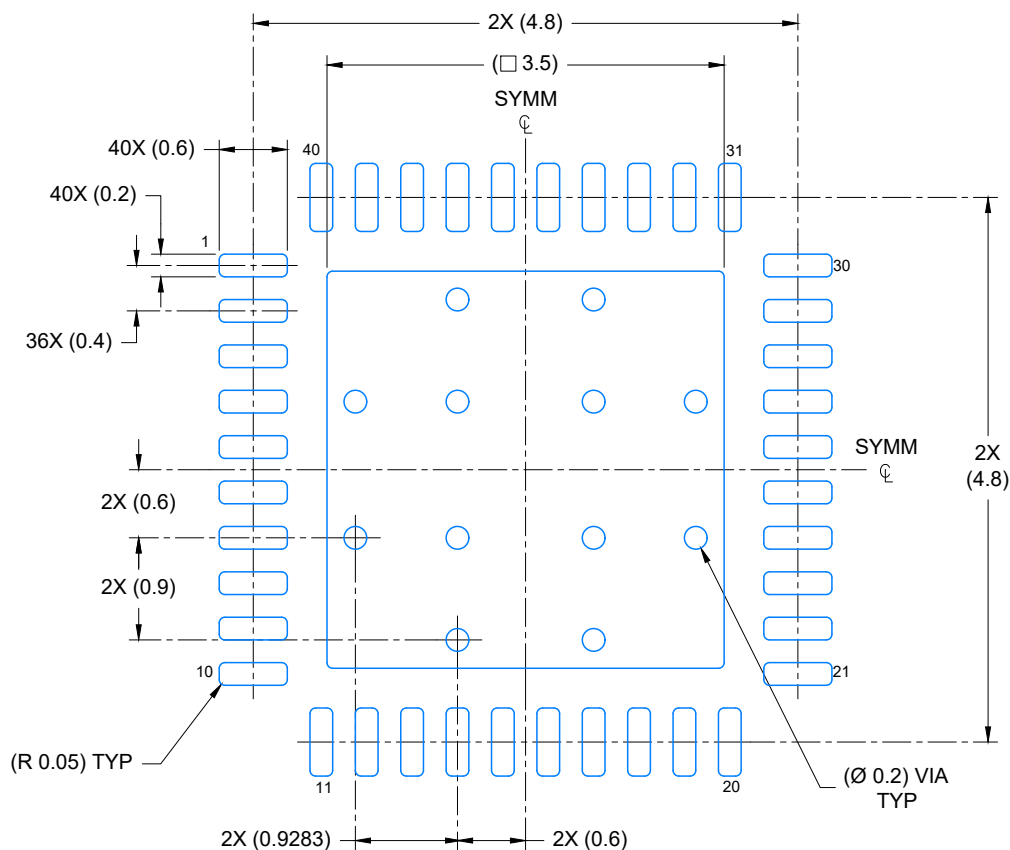

LAND PATTERN EXAMPLE  
EXPOSED METAL SHOWN  
SCALE: 15X

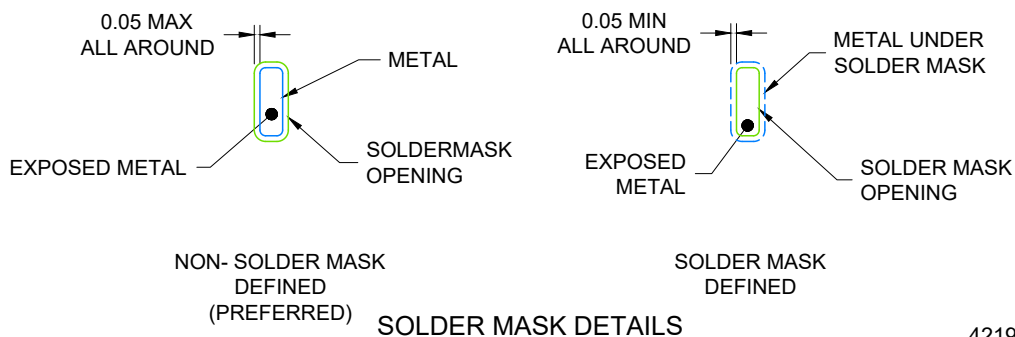

4219083/A 03/2021

NOTES: (continued)

4. This package is designed to be soldered to a thermal pad on the board. For more information, see Texas Instruments literature number SLUA271 ([www.ti.com/lit/slua271](http://www.ti.com/lit/slua271)).
5. Vias are optional depending on application, refer to device data sheet. If any vias are implemented, refer to their locations shown on this view. It is recommended that vias under paste be filled, plugged or tented.

# EXAMPLE STENCIL DESIGN

VQFN - 1 mm max height

RKP0040B

PLASTIC QUAD FLATPACK- NO LEAD

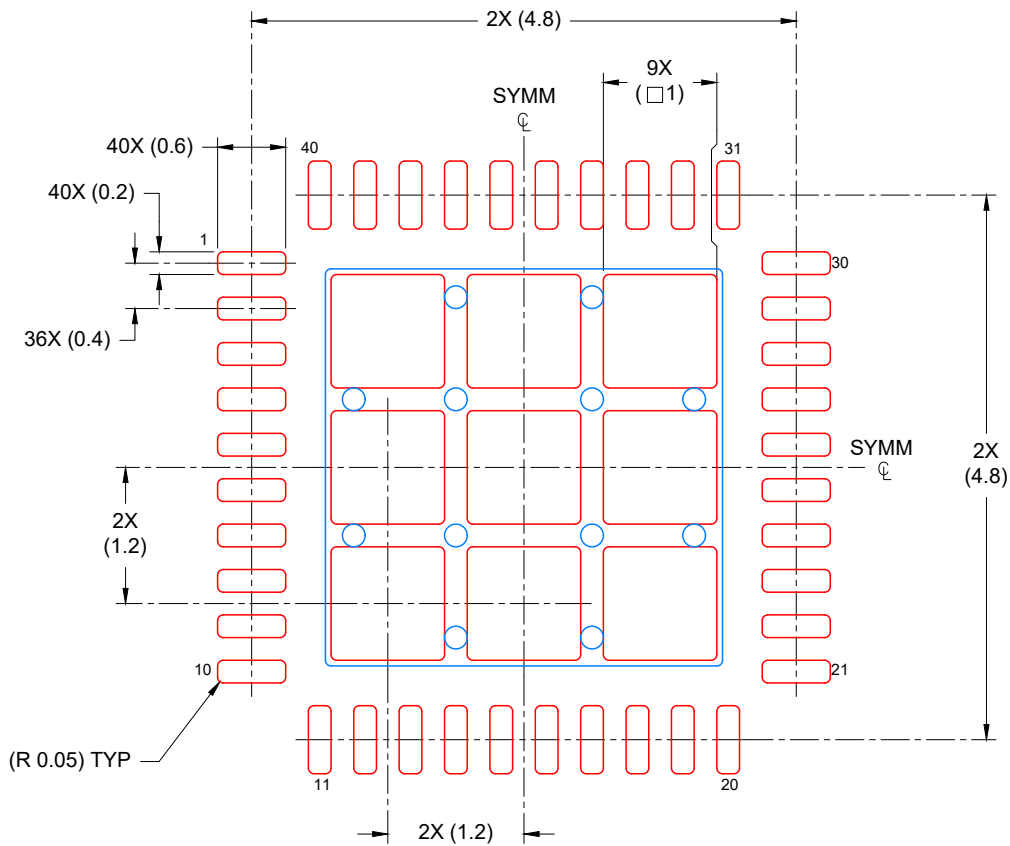

SOLDER PASTE EXAMPLE  
BASED ON 0.125 mm THICK STENCIL

EXPOSED PAD  
74% PRINTED COVERAGE BY AREA  
SCALE: 15X

4219083/A 03/2021

NOTES: (continued)

6. Laser cutting apertures with trapezoidal walls and rounded corners may offer better paste release. IPC-7525 may have alternate design recommendations.

## GENERIC PACKAGE VIEW

**RGZ 48**

**VQFN - 1 mm max height**

7 x 7, 0.5 mm pitch

PLASTIC QUADFLAT PACK- NO LEAD

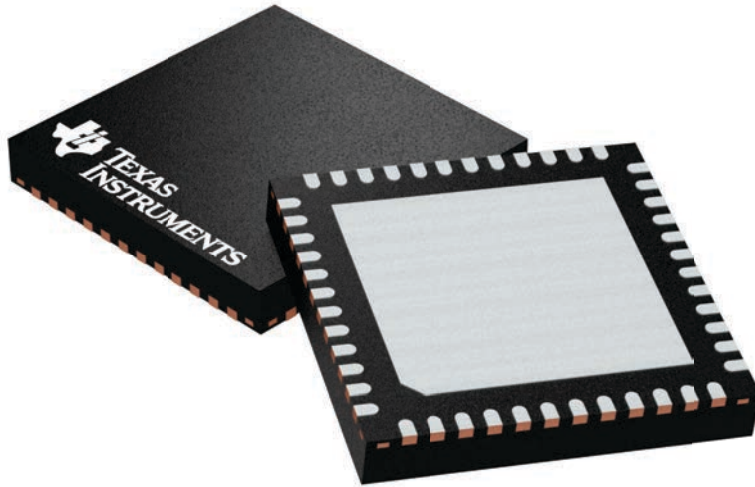

Images above are just a representation of the package family, actual package may vary.  
Refer to the product data sheet for package details.

4224671/A

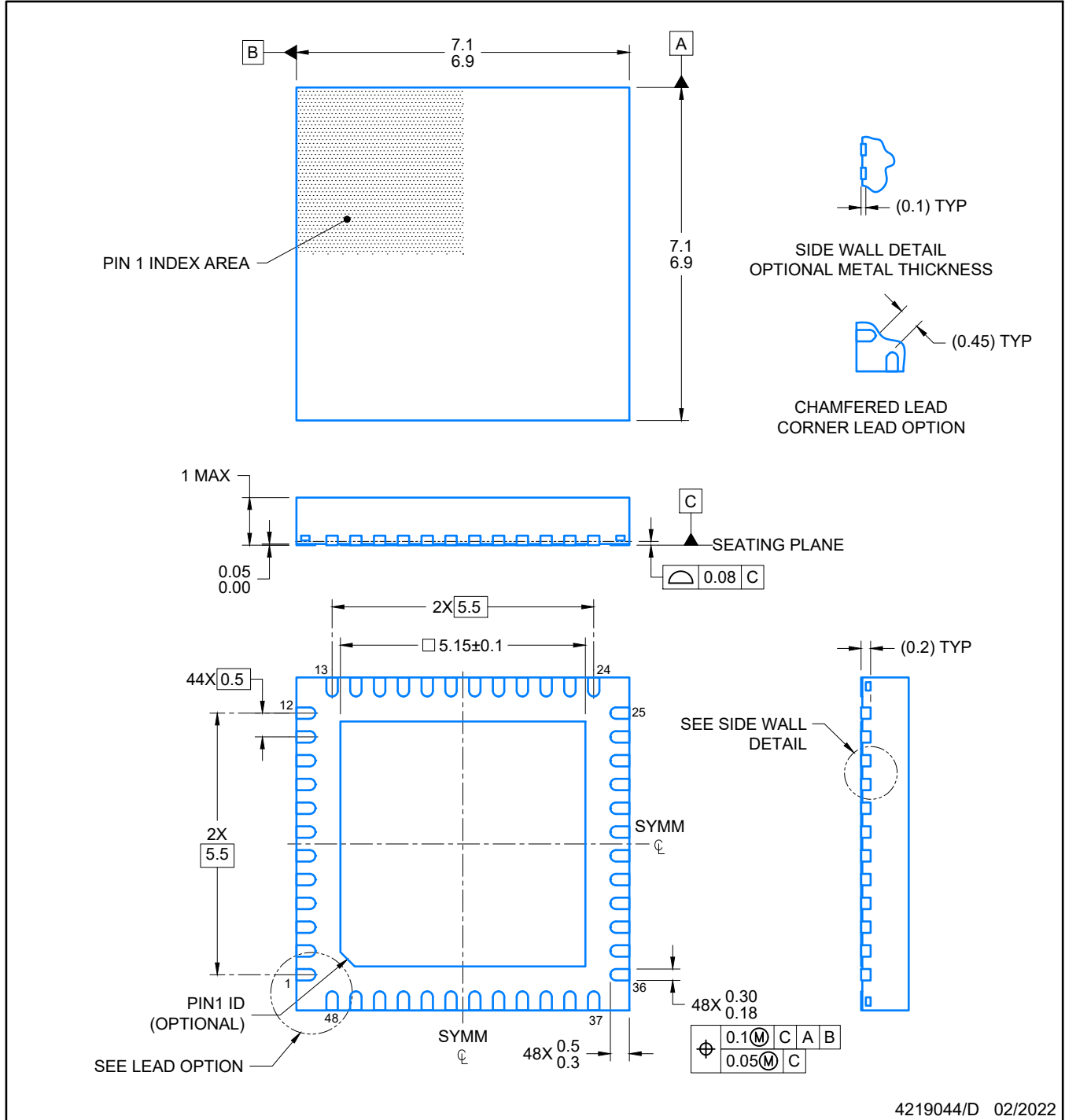

NOTES:

1. All linear dimensions are in millimeters. Any dimensions in parenthesis are for reference only. Dimensioning and tolerancing per ASME Y14.5M.
2. This drawing is subject to change without notice.
3. The package thermal pad must be soldered to the printed circuit board for optimal thermal and mechanical performance.

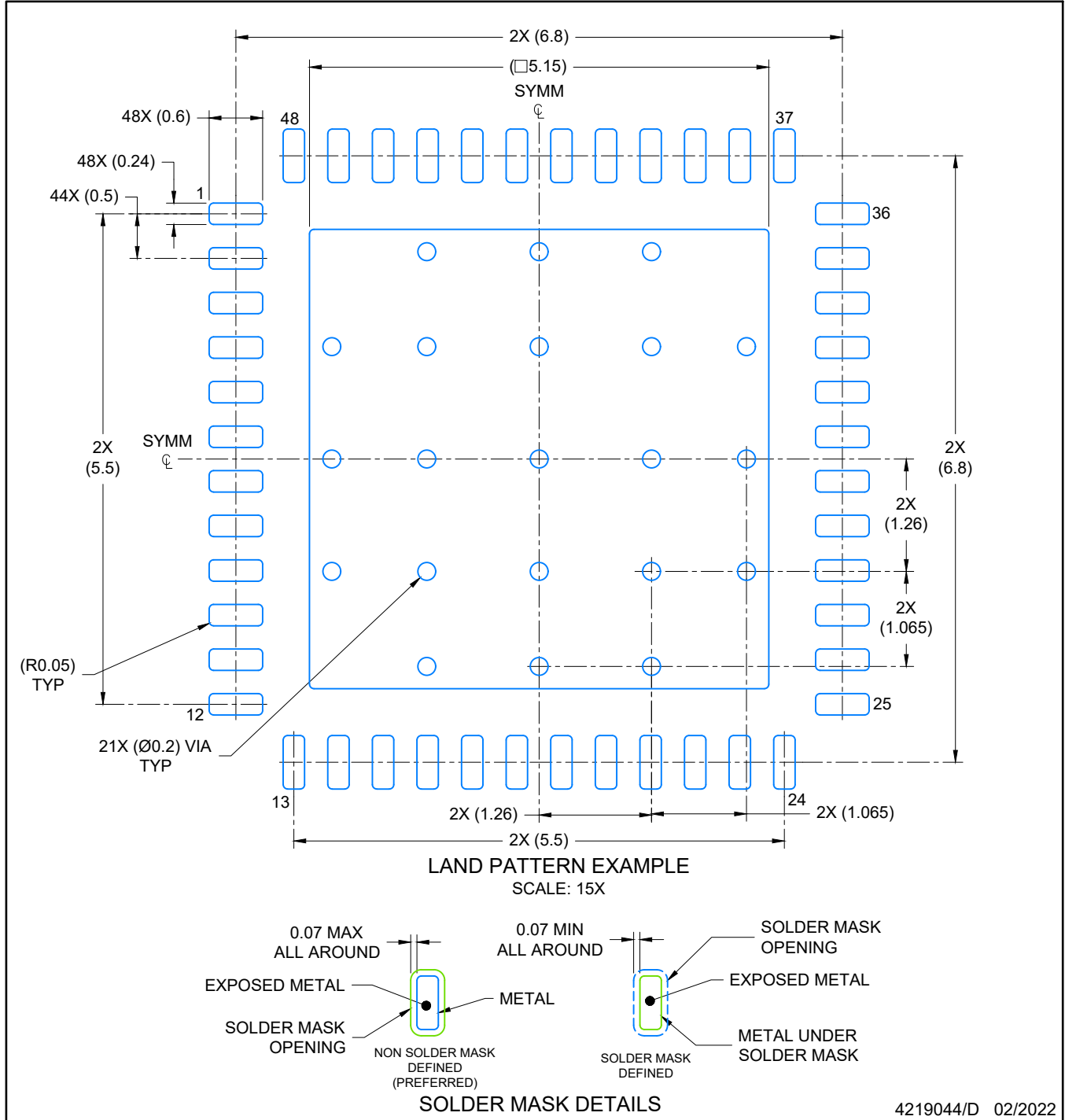

NOTES: (continued)

4. This package is designed to be soldered to a thermal pad on the board. For more information, see Texas Instruments literature number SLUA271 ([www.ti.com/lit/slua271](http://www.ti.com/lit/slua271)).
5. Vias are optional depending on application, refer to device data sheet. If any vias are implemented, refer to their locations shown on this view. It is recommended that vias under paste be filled, plugged or tented.

# EXAMPLE STENCIL DESIGN

RGZ0048A

VQFN - 1 mm max height

PLASTIC QUADFLAT PACK- NO LEAD

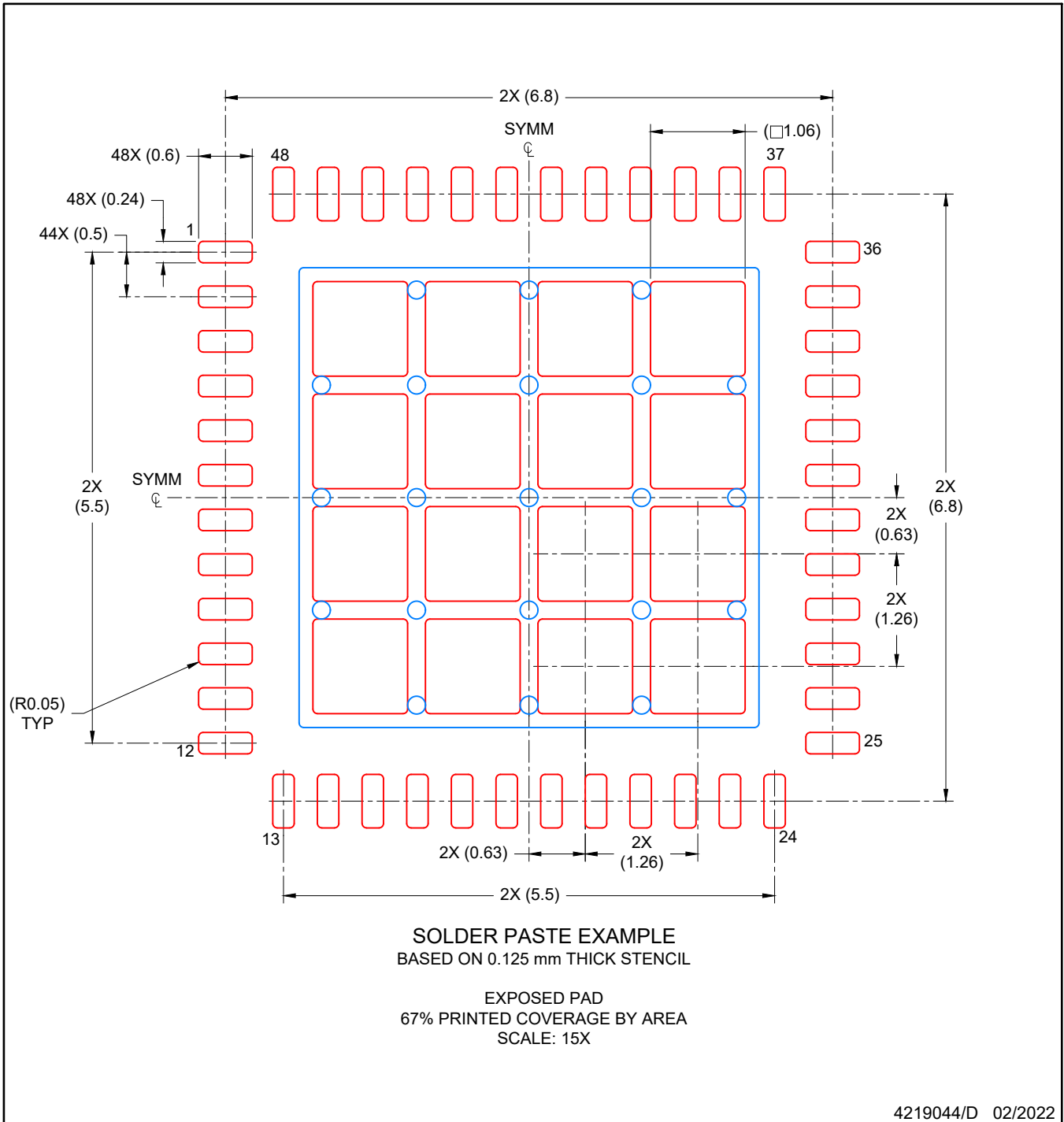

NOTES: (continued)

6. Laser cutting apertures with trapezoidal walls and rounded corners may offer better paste release. IPC-7525 may have alternate design recommendations.

## 重要なお知らせと免責事項

TI は、技術データと信頼性データ (データシートを含みます)、設計リソース (リファレンス デザインを含みます)、アプリケーションや設計に関する各種アドバイス、Web ツール、安全性情報、その他のリソースを、欠陥が存在する可能性のある「現状のまま」提供しており、商品性および特定目的に対する適合性の黙示保証、第三者の知的財産権の非侵害保証を含むいかなる保証も、明示的または黙示的にかかわらず拒否します。

これらのリソースは、TI 製品を使用する設計の経験を積んだ開発者への提供を意図したものです。(1) お客様のアプリケーションに適した TI 製品の選定、(2) お客様のアプリケーションの設計、検証、試験、(3) お客様のアプリケーションに該当する各種規格や、その他のあらゆる安全性、セキュリティ、規制、または他の要件への確実な適合に関する責任を、お客様のみが単独で負うものとし、

上記の各種リソースは、予告なく変更される可能性があります。これらのリソースは、リソースで説明されている TI 製品を使用するアプリケーションの開発の目的でのみ、TI はその使用をお客様に許諾します。これらのリソースに関して、他の目的で複製することや掲載することは禁止されています。TI や第三者の知的財産権のライセンスが付与されている訳ではありません。お客様は、これらのリソースを自身で使用した結果発生するあらゆる申し立て、損害、費用、損失、責任について、TI およびその代理人を完全に補償するものとし、TI は一切の責任を拒否します。

TI の製品は、[TI の販売条件](#)、[TI の総合的な品質ガイドライン](#)、[ti.com](#) または TI 製品などに関連して提供される他の適用条件に従い提供されます。TI がこれらのリソースを提供することは、適用される TI の保証または他の保証の放棄の拡大や変更を意味するものではありません。TI がカスタム、またはカスタマー仕様として明示的に指定していない限り、TI の製品は標準的なカタログに掲載される汎用機器です。

お客様がいかなる追加条項または代替条項を提案する場合も、TI はそれらに異議を唱え、拒否します。

Copyright © 2026, Texas Instruments Incorporated

最終更新日 : 2025 年 10 月