

# CD4001B, CD4002B, CD4025B Types

## CMOS NOR Gates

High-Voltage Types (20-Volt Rating)

Quad 2 Input – CD4001B

Dual 4 Input – CD4002B

Triple 3 Input – CD4025B

■ CD4001B, CD4002B, and CD4025B NOR gates provide the system designer with direct implementation of the NOR function and supplement the existing family of CMOS gates. All inputs and outputs are buffered.

The CD4001B, CD4002B, and CD4025B types are supplied in 14-lead hermetic dual-in-line ceramic packages (F3A suffix), 14-lead dual-in-line plastic packages (E suffix), 14-lead small-outline packages (M, MT, M96, and NSR suffixes), and 14-lead thin shrink small-outline packages (PW and PWR suffixes).

### Features:

- Propagation delay time = 60 ns (typ.) at  $C_L = 50 \text{ pF}$ ,  $V_{DD} = 10 \text{ V}$
- Buffered inputs and outputs
- Standardized symmetrical output characteristics
- 100% tested for maximum quiescent current at 20 V
- 5-V, 10-V, and 15-V parametric ratings
- Maximum input current of  $1 \mu\text{A}$  at 18 V over full package-temperature range;  $100 \text{ nA}$  at 18 V and  $25^\circ\text{C}$
- Noise margin (over full package temperature range):
  - 1 V at  $V_{DD} = 5 \text{ V}$
  - 2 V at  $V_{DD} = 10 \text{ V}$
  - 2.5 V at  $V_{DD} = 15 \text{ V}$
- Meets all requirements of JEDEC Tentative Standard No. 13B, "Standard Specifications for Description of "B" Series CMOS Devices"

### STATIC ELECTRICAL CHARACTERISTICS

CHARACTER- ISTIC	CONDITIONS			LIMITS AT INDICATED TEMPERATURES ( $^\circ\text{C}$ )							UNITS
	$V_O$ (V)	$V_{IN}$ (V)	$V_{DD}$ (V)	+25							
				-55	-40	+85	+125	Min.	Typ.	Max.	
Quiescent Device Current, $I_{DD} \text{ Max.}$	–	0,5	5	0,25	0,25	7,5	7,5	–	0,01	0,25	$\mu\text{A}$
	–	0,10	10	0,5	0,5	15	15	–	0,01	0,5	
	–	0,15	15	1	1	30	30	–	0,01	1	
	–	0,20	20	5	5	150	150	–	0,02	5	
Output Low (Sink) Current $I_{OL} \text{ Min.}$	0,4	0,5	5	0,64	0,61	0,42	0,36	0,51	1	–	$\text{mA}$
	0,5	0,10	10	1,6	1,5	1,1	0,9	1,3	2,6	–	
	1,5	0,15	15	4,2	4	2,8	2,4	3,4	6,8	–	
	–	–	–	–	–	–	–	–	–	–	
Output High (Source) Current, $I_{OH} \text{ Min.}$	4,6	0,5	5	-0,64	-0,61	-0,42	-0,36	-0,51	-1	–	$\text{mA}$
	2,5	0,5	5	-2	-1,8	-1,3	-1,15	-1,6	-3,2	–	
	9,5	0,10	10	-1,6	-1,5	-1,1	-0,9	-1,3	-2,6	–	
	13,5	0,15	15	-4,2	-4	-2,8	-2,4	-3,4	-6,8	–	
Output Voltage: Low-Level, $V_{OL} \text{ Max.}$	–	0,5	5	0,05				–	0	0,05	V
	–	0,10	10	0,05				–	0	0,05	
	–	0,15	15	0,05				–	0	0,05	
Output Voltage: High-Level, $V_{OH} \text{ Min.}$	–	0,5	5	4,95				4,95	5	–	V
	–	0,10	10	9,95				9,95	10	–	
	–	0,15	15	14,95				14,95	15	–	
Input Low Voltage, $V_{IL} \text{ Max.}$	0,5,4,5	–	5	1,5				–	–	1,5	V
	1,9	–	10	3				–	–	3	
	1,5,13,5	–	15	4				–	–	4	
Input High Voltage, $V_{IH} \text{ Min.}$	0,5	–	5	3,5				3,5	–	–	V
	1	–	10	7				7	–	–	
	1,5	–	15	11				11	–	–	
Input Current $I_{IN} \text{ Max.}$		0,18	18	$\pm 0,1$	$\pm 0,1$	$\pm 1$	$\pm 1$	–	$\pm 10^{-5}$	$\pm 0,1$	$\mu\text{A}$

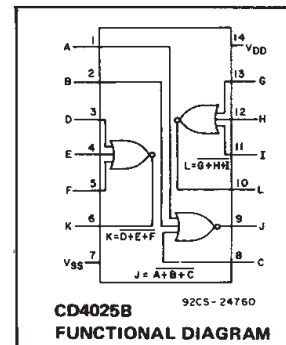
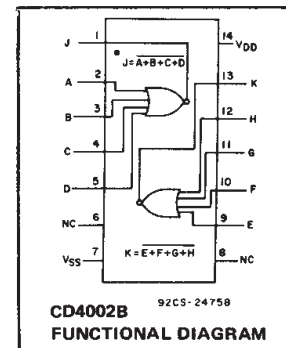
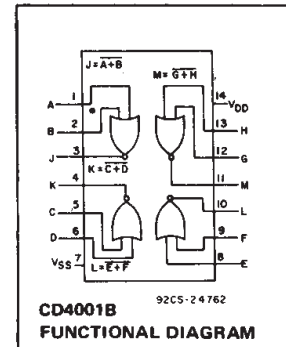

**3**  
 COMMERCIAL CMOS  
 HIGH VOLTAGE ICs

# CD4001B, CD4002B, CD4025B Types

## RECOMMENDED OPERATING CONDITIONS

For maximum reliability, nominal operating conditions should be selected so that operation is always within the following ranges:

CHARACTERISTIC	LIMITS		UNITS
	MIN.	MAX.	
Supply-Voltage Range (For $T_A$ = Full Package Temperature Range)	3	18	V

## MAXIMUM RATINGS, Absolute-Maximum Values:

### DC SUPPLY-VOLTAGE RANGE, ( $V_{DD}$ )

Volts referenced to  $V_{SS}$  Terminal ..... -0.5V to +20V

### INPUT VOLTAGE RANGE, ALL INPUTS

..... -0.5V to  $V_{DD}$  + 0.5V

### DC INPUT CURRENT, ANY ONE INPUT

.....  $\pm 10$ mA

### POWER DISSIPATION PER PACKAGE ( $P_D$ ):

For  $T_A = -55^\circ\text{C}$  to  $+100^\circ\text{C}$  ..... 500mW

For  $T_A = +100^\circ\text{C}$  to  $+125^\circ\text{C}$  ..... Derate Linearly at 12mW/ $^\circ\text{C}$  to 200mW

### DEVICE DISSIPATION PER OUTPUT TRANSISTOR

FOR  $T_A$  = FULL PACKAGE-TEMPERATURE RANGE (All Package Types) ..... 100mW

### OPERATING-TEMPERATURE RANGE ( $T_A$ )

.....  $-55^\circ\text{C}$  to  $+125^\circ\text{C}$

### STORAGE TEMPERATURE RANGE ( $T_{stg}$ )

.....  $-65^\circ\text{C}$  to  $+150^\circ\text{C}$

### LEAD TEMPERATURE (DURING SOLDERING):

At distance 1/16  $\pm$  1/32 inch (1.59  $\pm$  0.79mm) from case for 10s max .....  $+265^\circ\text{C}$

## DYNAMIC ELECTRICAL CHARACTERISTICS

At  $T_A = 25^\circ\text{C}$ ; Input  $t_r, t_f = 20$  ns,  $C_L = 50$  pF,  $R_L = 200k\Omega$

CHARACTERISTIC	TEST CONDITIONS	ALL TYPES LIMITS		UNITS	
		$V_{DD}$ VOLTS	TYP.		MAX.
Propagation Delay Time, $t_{PHL}, t_{PLH}$		5	125	250	ns
		10	60	120	
		15	45	90	
Transition Time, $t_{THL}, t_{TLH}$		5	100	200	ns
		10	50	100	
		15	40	80	
Input Capacitance, $C_{IN}$	Any Input		5	7.5	pF

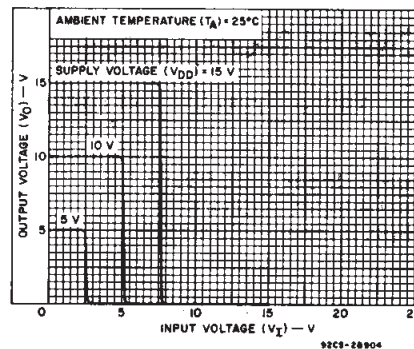

Fig. 1 - Typical voltage transfer characteristics.

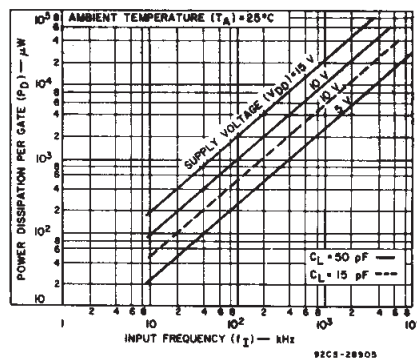

Fig. 2 - Typical power dissipation vs. frequency.

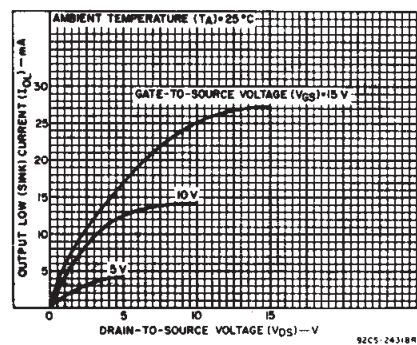

Fig. 3 - Typical output low (sink) current characteristics.

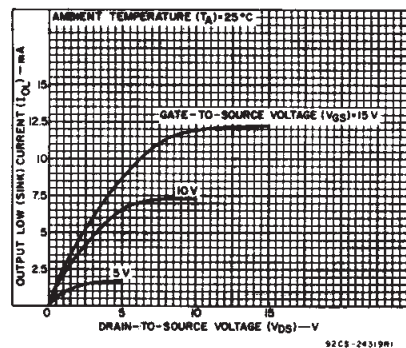

Fig. 4 - Minimum output low (sink) current characteristics.

# CD4001B, CD4002B, CD4025B Types

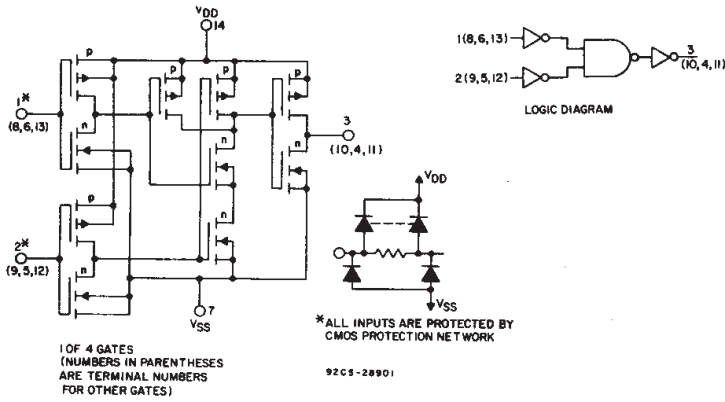

Fig.5 - Schematic and logic diagrams for CD4001B.

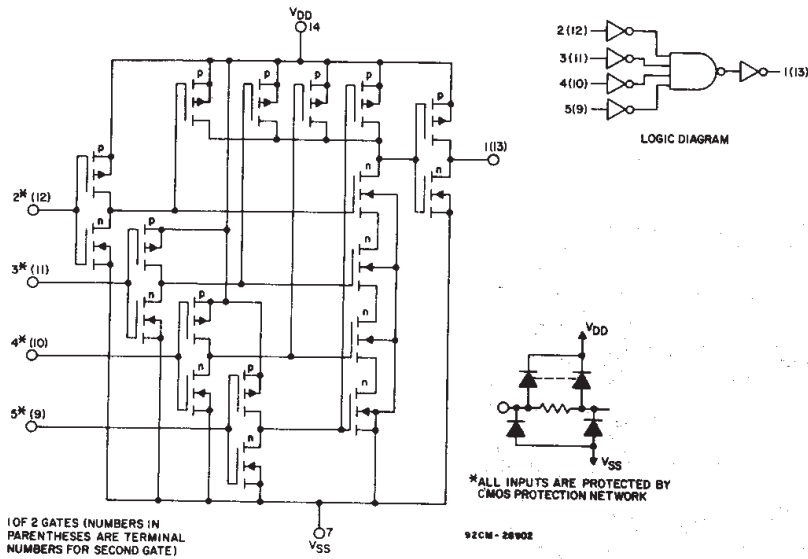

Fig.6 - Schematic and logic diagrams for CD4002B.

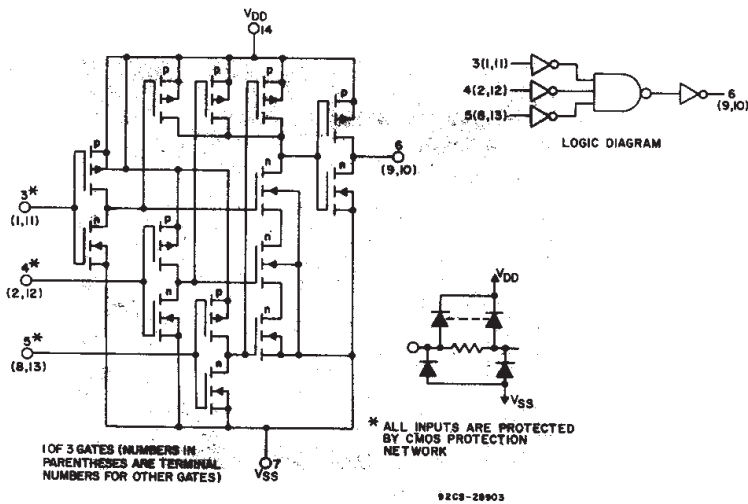

Fig.7 - Schematic and logic diagrams for CD4025B.

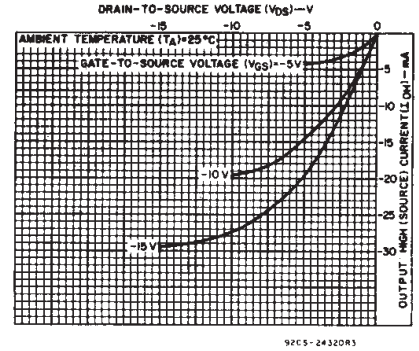

Fig.8 - Typical output high (source) current characteristics.

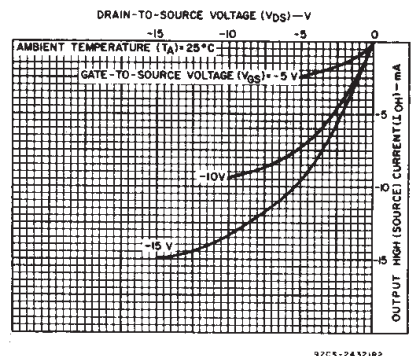

Fig.9 - Minimum output high (source) current characteristics.

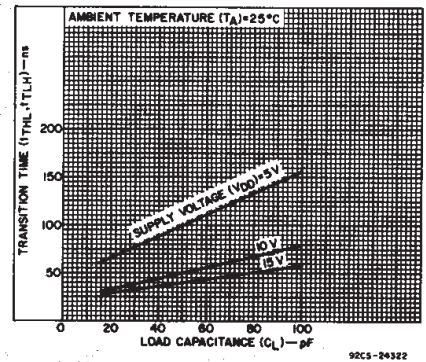

Fig.10 - Typical transition time vs. load capacitance.

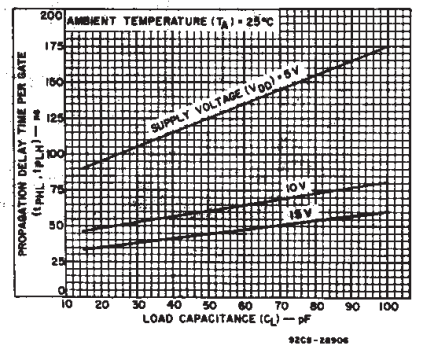

Fig.11 - Typical propagation delay time vs. load capacitance.

COMMERCIAL CMOS HIGH VOLTAGE ICs

# CD4001B, CD4002B, CD4025B Types



Fig. 13 - Input leakage current test circuit.



Fig. 14 - Input-voltage test circuit.

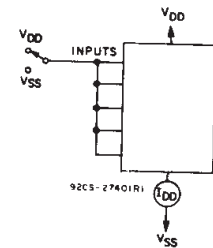
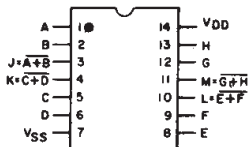

Fig. 15 - Quiescent-device current test circuit.

## TERMINAL ASSIGNMENTS (TOP VIEW)



NC = NO CONNECTION

CD4001B

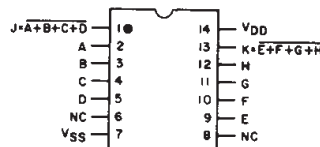

NC = NO CONNECTION

CD4002B

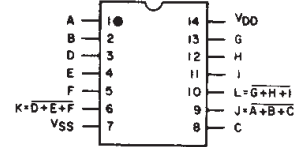

NC = NO CONNECTION

CD4025B

## Chip Dimensions and Pad Layouts

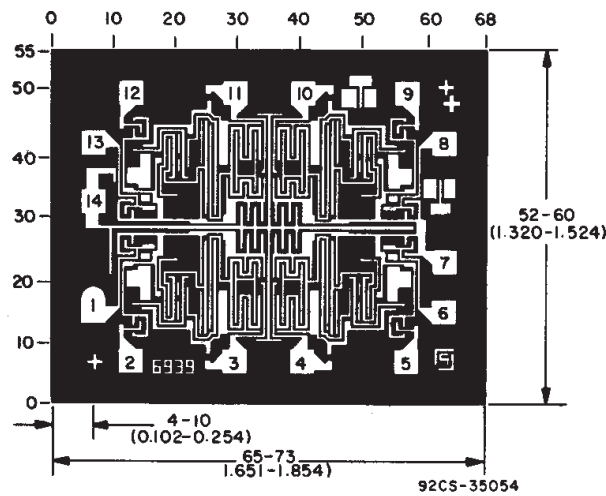

CD4001B

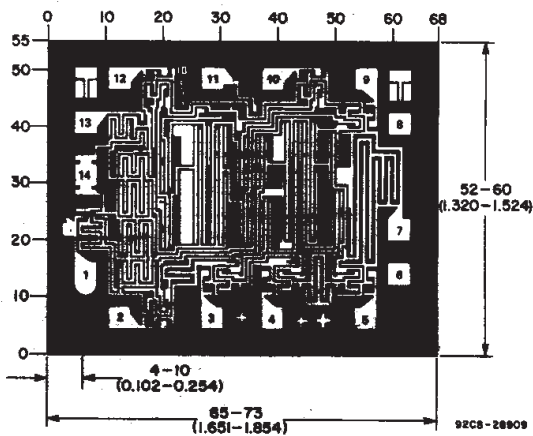

CD4002B

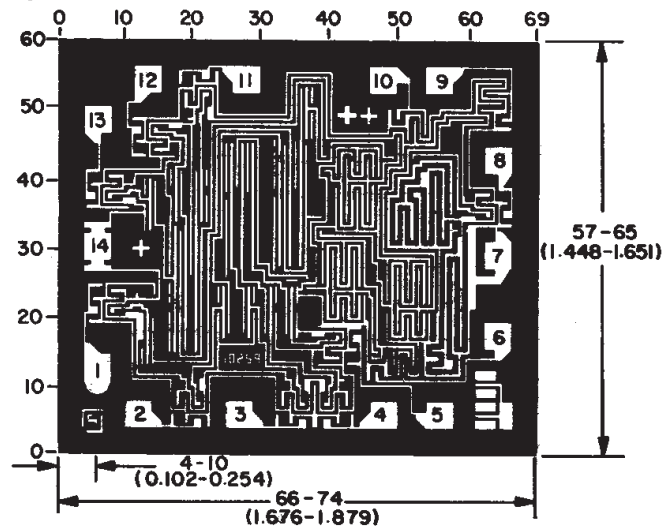

CD4025B

**PACKAGING INFORMATION**

Orderable part number	Status (1)	Material type (2)	Package   Pins	Package qty   Carrier	RoHS (3)	Lead finish/ Ball material (4)	MSL rating/ Peak reflow (5)	Op temp (°C)	Part marking (6)
<a href="#">7704403CA</a>	Active	Production	CDIP (J)   14	25   TUBE	No	SNPB	N/A for Pkg Type	-55 to 125	7704403CA CD4002BF3A
<a href="#">CD4001BE</a>	Active	Production	PDIP (N)   14	25   TUBE	Yes	NIPDAU	N/A for Pkg Type	-55 to 125	CD4001BE
CD4001BE.A	Active	Production	PDIP (N)   14	25   TUBE	Yes	NIPDAU	N/A for Pkg Type	-55 to 125	CD4001BE
CD4001BEE4	Active	Production	PDIP (N)   14	25   TUBE	Yes	NIPDAU	N/A for Pkg Type	-55 to 125	CD4001BE
<a href="#">CD4001BF</a>	Active	Production	CDIP (J)   14	25   TUBE	No	SNPB	N/A for Pkg Type	-55 to 125	CD4001BF
CD4001BF.A	Active	Production	CDIP (J)   14	25   TUBE	No	SNPB	N/A for Pkg Type	-55 to 125	CD4001BF
<a href="#">CD4001BF3A</a>	Active	Production	CDIP (J)   14	25   TUBE	No	SNPB	N/A for Pkg Type	-55 to 125	CD4001BF3A
CD4001BF3A.A	Active	Production	CDIP (J)   14	25   TUBE	No	SNPB	N/A for Pkg Type	-55 to 125	CD4001BF3A
<a href="#">CD4001BM</a>	Active	Production	SOIC (D)   14	50   TUBE	Yes	NIPDAU	Level-1-260C-UNLIM	-55 to 125	CD4001BM
CD4001BM.A	Active	Production	SOIC (D)   14	50   TUBE	Yes	NIPDAU	Level-1-260C-UNLIM	-55 to 125	CD4001BM
<a href="#">CD4001BM96</a>	Active	Production	SOIC (D)   14	2500   LARGE T&R	Yes	NIPDAU	Level-1-260C-UNLIM	-55 to 125	CD4001BM
CD4001BM96.A	Active	Production	SOIC (D)   14	2500   LARGE T&R	Yes	NIPDAU	Level-1-260C-UNLIM	-55 to 125	CD4001BM
CD4001BM96E4	Active	Production	SOIC (D)   14	2500   LARGE T&R	Yes	NIPDAU	Level-1-260C-UNLIM	-55 to 125	CD4001BM
CD4001BM96G4	Active	Production	SOIC (D)   14	2500   LARGE T&R	Yes	NIPDAU	Level-1-260C-UNLIM	-55 to 125	CD4001BM
<a href="#">CD4001BMT</a>	Obsolete	Production	SOIC (D)   14	-	-	Call TI	Call TI	-55 to 125	CD4001BM
<a href="#">CD4001BNSR</a>	Active	Production	SOP (NS)   14	2000   LARGE T&R	Yes	NIPDAU	Level-1-260C-UNLIM	-55 to 125	CD4001B
CD4001BNSR.A	Active	Production	SOP (NS)   14	2000   LARGE T&R	Yes	NIPDAU	Level-1-260C-UNLIM	-55 to 125	CD4001B
CD4001BNSRG4	Active	Production	SOP (NS)   14	2000   LARGE T&R	Yes	NIPDAU	Level-1-260C-UNLIM	-55 to 125	CD4001B
<a href="#">CD4001BPW</a>	Obsolete	Production	TSSOP (PW)   14	-	-	Call TI	Call TI	-55 to 125	CM001B
<a href="#">CD4001BPWR</a>	Active	Production	TSSOP (PW)   14	2000   LARGE T&R	Yes	NIPDAU   SN	Level-1-260C-UNLIM	-55 to 125	CM001B
CD4001BPWR.A	Active	Production	TSSOP (PW)   14	2000   LARGE T&R	Yes	NIPDAU	Level-1-260C-UNLIM	-55 to 125	CM001B
<a href="#">CD4001BPWRG4</a>	Active	Production	TSSOP (PW)   14	2000   LARGE T&R	Yes	NIPDAU	Level-1-260C-UNLIM	-55 to 125	CM001B
<a href="#">CD4002BE</a>	Active	Production	PDIP (N)   14	25   TUBE	Yes	NIPDAU	N/A for Pkg Type	-55 to 125	CD4002BE
CD4002BE.A	Active	Production	PDIP (N)   14	25   TUBE	Yes	NIPDAU	N/A for Pkg Type	-55 to 125	CD4002BE
<a href="#">CD4002BF</a>	Active	Production	CDIP (J)   14	25   TUBE	No	SNPB	N/A for Pkg Type	-55 to 125	CD4002BF
CD4002BF.A	Active	Production	CDIP (J)   14	25   TUBE	No	SNPB	N/A for Pkg Type	-55 to 125	CD4002BF
<a href="#">CD4002BF3A</a>	Active	Production	CDIP (J)   14	25   TUBE	No	SNPB	N/A for Pkg Type	-55 to 125	7704403CA CD4002BF3A

Orderable part number	Status (1)	Material type (2)	Package   Pins	Package qty   Carrier	RoHS (3)	Lead finish/ Ball material (4)	MSL rating/ Peak reflow (5)	Op temp (°C)	Part marking (6)
CD4002BF3A.A	Active	Production	CDIP (J)   14	25   TUBE	No	SNPB	N/A for Pkg Type	-55 to 125	7704403CA CD4002BF3A
<a href="#">CD4002BM</a>	Obsolete	Production	SOIC (D)   14	-	-	Call TI	Call TI	-55 to 125	CD4002BM
<a href="#">CD4002BM96</a>	Active	Production	SOIC (D)   14	2500   LARGE T&R	Yes	NIPDAU	Level-1-260C-UNLIM	-55 to 125	CD4002BM
CD4002BM96.A	Active	Production	SOIC (D)   14	2500   LARGE T&R	Yes	NIPDAU	Level-1-260C-UNLIM	-55 to 125	CD4002BM
<a href="#">CD4002BNSR</a>	Active	Production	SOP (NS)   14	2000   LARGE T&R	Yes	NIPDAU	Level-1-260C-UNLIM	-55 to 125	CD4002B
CD4002BNSR.A	Active	Production	SOP (NS)   14	2000   LARGE T&R	Yes	NIPDAU	Level-1-260C-UNLIM	-55 to 125	CD4002B
<a href="#">CD4002BPW</a>	Obsolete	Production	TSSOP (PW)   14	-	-	Call TI	Call TI	-55 to 125	CM002B
<a href="#">CD4002BPWR</a>	Active	Production	TSSOP (PW)   14	2000   LARGE T&R	Yes	NIPDAU	Level-1-260C-UNLIM	-55 to 125	CM002B
CD4002BPWR.A	Active	Production	TSSOP (PW)   14	2000   LARGE T&R	Yes	NIPDAU	Level-1-260C-UNLIM	-55 to 125	CM002B
<a href="#">CD4025BE</a>	Active	Production	PDIP (N)   14	25   TUBE	Yes	NIPDAU	N/A for Pkg Type	-55 to 125	CD4025BE
CD4025BE.A	Active	Production	PDIP (N)   14	25   TUBE	Yes	NIPDAU	N/A for Pkg Type	-55 to 125	CD4025BE
CD4025BEE4	Active	Production	PDIP (N)   14	25   TUBE	Yes	NIPDAU	N/A for Pkg Type	-55 to 125	CD4025BE
<a href="#">CD4025BF</a>	Active	Production	CDIP (J)   14	25   TUBE	No	SNPB	N/A for Pkg Type	-55 to 125	CD4025BF
CD4025BF.A	Active	Production	CDIP (J)   14	25   TUBE	No	SNPB	N/A for Pkg Type	-55 to 125	CD4025BF
<a href="#">CD4025BF3A</a>	Active	Production	CDIP (J)   14	25   TUBE	No	SNPB	N/A for Pkg Type	-55 to 125	CD4025BF3A
CD4025BF3A.A	Active	Production	CDIP (J)   14	25   TUBE	No	SNPB	N/A for Pkg Type	-55 to 125	CD4025BF3A
<a href="#">CD4025BM</a>	Obsolete	Production	SOIC (D)   14	-	-	Call TI	Call TI	-55 to 125	CD4025BM
<a href="#">CD4025BM96</a>	Active	Production	SOIC (D)   14	2500   LARGE T&R	Yes	NIPDAU	Level-1-260C-UNLIM	-55 to 125	CD4025BM
CD4025BM96.A	Active	Production	SOIC (D)   14	2500   LARGE T&R	Yes	NIPDAU	Level-1-260C-UNLIM	-55 to 125	CD4025BM
<a href="#">CD4025BMT</a>	Obsolete	Production	SOIC (D)   14	-	-	Call TI	Call TI	-55 to 125	CD4025BM
<a href="#">CD4025BNSR</a>	Active	Production	SOP (NS)   14	2000   LARGE T&R	Yes	NIPDAU	Level-1-260C-UNLIM	-55 to 125	CD4025B
CD4025BNSR.A	Active	Production	SOP (NS)   14	2000   LARGE T&R	Yes	NIPDAU	Level-1-260C-UNLIM	-55 to 125	CD4025B
<a href="#">CD4025BPW</a>	Active	Production	TSSOP (PW)   14	90   TUBE	Yes	NIPDAU	Level-1-260C-UNLIM	-55 to 125	CM025B
CD4025BPW.A	Active	Production	TSSOP (PW)   14	90   TUBE	Yes	NIPDAU	Level-1-260C-UNLIM	-55 to 125	CM025B
CD4025BPWE4	Active	Production	TSSOP (PW)   14	90   TUBE	Yes	NIPDAU	Level-1-260C-UNLIM	-55 to 125	CM025B
<a href="#">JM38510/05252BCA</a>	Active	Production	CDIP (J)   14	25   TUBE	No	SNPB	N/A for Pkg Type	-55 to 125	JM38510/ 05252BCA
JM38510/05252BCA.A	Active	Production	CDIP (J)   14	25   TUBE	No	SNPB	N/A for Pkg Type	-55 to 125	JM38510/ 05252BCA
<a href="#">JM38510/05254BCA</a>	Active	Production	CDIP (J)   14	25   TUBE	No	SNPB	N/A for Pkg Type	-55 to 125	JM38510/ 05254BCA

Orderable part number	Status (1)	Material type (2)	Package   Pins	Package qty   Carrier	RoHS (3)	Lead finish/ Ball material (4)	MSL rating/ Peak reflow (5)	Op temp (°C)	Part marking (6)
JM38510/05254BCA.A	Active	Production	CDIP (J)   14	25   TUBE	No	SNPB	N/A for Pkg Type	-55 to 125	JM38510/ 05254BCA
<a href="#">M38510/05252BCA</a>	Active	Production	CDIP (J)   14	25   TUBE	No	SNPB	N/A for Pkg Type	-55 to 125	JM38510/ 05252BCA
<a href="#">M38510/05254BCA</a>	Active	Production	CDIP (J)   14	25   TUBE	No	SNPB	N/A for Pkg Type	-55 to 125	JM38510/ 05254BCA

(1) **Status:** For more details on status, see our [product life cycle](#).

(2) **Material type:** When designated, preproduction parts are prototypes/experimental devices, and are not yet approved or released for full production. Testing and final process, including without limitation quality assurance, reliability performance testing, and/or process qualification, may not yet be complete, and this item is subject to further changes or possible discontinuation. If available for ordering, purchases will be subject to an additional waiver at checkout, and are intended for early internal evaluation purposes only. These items are sold without warranties of any kind.

(3) **RoHS values:** Yes, No, RoHS Exempt. See the [TI RoHS Statement](#) for additional information and value definition.

(4) **Lead finish/Ball material:** Parts may have multiple material finish options. Finish options are separated by a vertical ruled line. Lead finish/Ball material values may wrap to two lines if the finish value exceeds the maximum column width.

(5) **MSL rating/Peak reflow:** The moisture sensitivity level ratings and peak solder (reflow) temperatures. In the event that a part has multiple moisture sensitivity ratings, only the lowest level per JEDEC standards is shown. Refer to the shipping label for the actual reflow temperature that will be used to mount the part to the printed circuit board.

(6) **Part marking:** There may be an additional marking, which relates to the logo, the lot trace code information, or the environmental category of the part.

Multiple part markings will be inside parentheses. Only one part marking contained in parentheses and separated by a "-" will appear on a part. If a line is indented then it is a continuation of the previous line and the two combined represent the entire part marking for that device.

**Important Information and Disclaimer:** The information provided on this page represents TI's knowledge and belief as of the date that it is provided. TI bases its knowledge and belief on information provided by third parties, and makes no representation or warranty as to the accuracy of such information. Efforts are underway to better integrate information from third parties. TI has taken and continues to take reasonable steps to provide representative and accurate information but may not have conducted destructive testing or chemical analysis on incoming materials and chemicals. TI and TI suppliers consider certain information to be proprietary, and thus CAS numbers and other limited information may not be available for release.

In no event shall TI's liability arising out of such information exceed the total purchase price of the TI part(s) at issue in this document sold by TI to Customer on an annual basis.

**OTHER QUALIFIED VERSIONS OF CD4001B, CD4001B-MIL, CD4002B, CD4002B-MIL, CD4025B, CD4025B-MIL :**

- Catalog : [CD4001B](#), [CD4002B](#), [CD4025B](#)
- Military : [CD4001B-MIL](#), [CD4002B-MIL](#), [CD4025B-MIL](#)

NOTE: Qualified Version Definitions:

- Catalog - TI's standard catalog product
- Military - QML certified for Military and Defense Applications

**TAPE AND REEL INFORMATION**

**QUADRANT ASSIGNMENTS FOR PIN 1 ORIENTATION IN TAPE**



\*All dimensions are nominal

Device	Package Type	Package Drawing	Pins	SPQ	Reel Diameter (mm)	Reel Width W1 (mm)	A0 (mm)	B0 (mm)	K0 (mm)	P1 (mm)	W (mm)	Pin1 Quadrant
CD4001BM96	SOIC	D	14	2500	330.0	16.4	6.5	9.0	2.1	8.0	16.0	Q1
CD4001BNSR	SOP	NS	14	2000	330.0	16.4	8.1	10.4	2.5	12.0	16.0	Q1
CD4001BPWR	TSSOP	PW	14	2000	330.0	12.4	6.9	5.6	1.6	8.0	12.0	Q1
CD4001BPWRG4	TSSOP	PW	14	2000	330.0	12.4	6.9	5.6	1.6	8.0	12.0	Q1
CD4002BM96	SOIC	D	14	2500	330.0	16.4	6.5	9.0	2.1	8.0	16.0	Q1
CD4002BNSR	SOP	NS	14	2000	330.0	16.4	8.1	10.4	2.5	12.0	16.0	Q1
CD4002BPWR	TSSOP	PW	14	2000	330.0	12.4	6.9	5.6	1.6	8.0	12.0	Q1
CD4025BM96	SOIC	D	14	2500	330.0	16.4	6.5	9.0	2.1	8.0	16.0	Q1
CD4025BNSR	SOP	NS	14	2000	330.0	16.4	8.1	10.4	2.5	12.0	16.0	Q1

**TAPE AND REEL BOX DIMENSIONS**

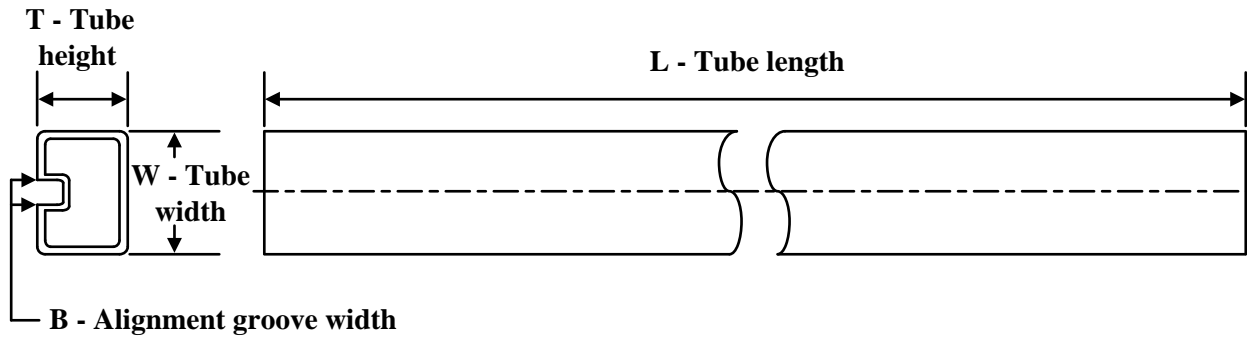

\*All dimensions are nominal

Device	Package Type	Package Drawing	Pins	SPQ	Length (mm)	Width (mm)	Height (mm)
CD4001BM96	SOIC	D	14	2500	353.0	353.0	32.0
CD4001BNSR	SOP	NS	14	2000	353.0	353.0	32.0
CD4001BPWR	TSSOP	PW	14	2000	356.0	356.0	35.0
CD4001BPWRG4	TSSOP	PW	14	2000	356.0	356.0	35.0
CD4002BM96	SOIC	D	14	2500	353.0	353.0	32.0
CD4002BNSR	SOP	NS	14	2000	353.0	353.0	32.0
CD4002BPWR	TSSOP	PW	14	2000	353.0	353.0	32.0
CD4025BM96	SOIC	D	14	2500	353.0	353.0	32.0
CD4025BNSR	SOP	NS	14	2000	353.0	353.0	32.0

**TUBE**

\*All dimensions are nominal

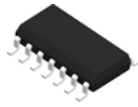
Device	Package Name	Package Type	Pins	SPQ	L (mm)	W (mm)	T (μm)	B (mm)
CD4001BE	N	PDIP	14	25	506	13.97	11230	4.32
CD4001BE.A	N	PDIP	14	25	506	13.97	11230	4.32
CD4001BEE4	N	PDIP	14	25	506	13.97	11230	4.32
CD4001BM	D	SOIC	14	50	506.6	8	3940	4.32
CD4001BM.A	D	SOIC	14	50	506.6	8	3940	4.32
CD4002BE	N	PDIP	14	25	506	13.97	11230	4.32
CD4002BE	N	PDIP	14	25	506	13.97	11230	4.32
CD4002BE.A	N	PDIP	14	25	506	13.97	11230	4.32
CD4002BE.A	N	PDIP	14	25	506	13.97	11230	4.32
CD4025BE	N	PDIP	14	25	506	13.97	11230	4.32
CD4025BE	N	PDIP	14	25	506	13.97	11230	4.32
CD4025BE.A	N	PDIP	14	25	506	13.97	11230	4.32
CD4025BE.A	N	PDIP	14	25	506	13.97	11230	4.32
CD4025BEE4	N	PDIP	14	25	506	13.97	11230	4.32
CD4025BEE4	N	PDIP	14	25	506	13.97	11230	4.32
CD4025BPW	PW	TSSOP	14	90	530	10.2	3600	3.5
CD4025BPW.A	PW	TSSOP	14	90	530	10.2	3600	3.5
CD4025BPWE4	PW	TSSOP	14	90	530	10.2	3600	3.5



# D0014A

# PACKAGE OUTLINE

## SOIC - 1.75 mm max height

SMALL OUTLINE INTEGRATED CIRCUIT



4220718/A 09/2016

### NOTES:

1. All linear dimensions are in millimeters. Dimensions in parenthesis are for reference only. Dimensioning and tolerancing per ASME Y14.5M.
2. This drawing is subject to change without notice.
3. This dimension does not include mold flash, protrusions, or gate burrs. Mold flash, protrusions, or gate burrs shall not exceed 0.15 mm, per side.
4. This dimension does not include interlead flash. Interlead flash shall not exceed 0.43 mm, per side.
5. Reference JEDEC registration MS-012, variation AB.

# EXAMPLE BOARD LAYOUT

D0014A

SOIC - 1.75 mm max height

SMALL OUTLINE INTEGRATED CIRCUIT



LAND PATTERN EXAMPLE  
SCALE:8X



SOLDER MASK DETAILS

4220718/A 09/2016

NOTES: (continued)

6. Publication IPC-7351 may have alternate designs.
7. Solder mask tolerances between and around signal pads can vary based on board fabrication site.

# EXAMPLE STENCIL DESIGN

D0014A

SOIC - 1.75 mm max height

SMALL OUTLINE INTEGRATED CIRCUIT



SOLDER PASTE EXAMPLE  
BASED ON 0.125 mm THICK STENCIL  
SCALE:8X

4220718/A 09/2016

NOTES: (continued)

8. Laser cutting apertures with trapezoidal walls and rounded corners may offer better paste release. IPC-7525 may have alternate design recommendations.
9. Board assembly site may have different recommendations for stencil design.

# MECHANICAL DATA

NS (R-PDSO-G\*\*)

PLASTIC SMALL-OUTLINE PACKAGE

14-PINS SHOWN



- NOTES:
- A. All linear dimensions are in millimeters.
  - B. This drawing is subject to change without notice.
  - C. Body dimensions do not include mold flash or protrusion, not to exceed 0,15.

J 14

**GENERIC PACKAGE VIEW**  
**CDIP - 5.08 mm max height**  
CERAMIC DUAL IN LINE PACKAGE



Images above are just a representation of the package family, actual package may vary.  
Refer to the product data sheet for package details.

4040083-5/G

J0014A



# PACKAGE OUTLINE

CDIP - 5.08 mm max height

CERAMIC DUAL IN LINE PACKAGE



4214771/A 05/2017

NOTES:

1. All controlling linear dimensions are in inches. Dimensions in brackets are in millimeters. Any dimension in brackets or parenthesis are for reference only. Dimensioning and tolerancing per ASME Y14.5M.
2. This drawing is subject to change without notice.
3. This package is hermetically sealed with a ceramic lid using glass frit.
4. Index point is provided on cap for terminal identification only and on press ceramic glass frit seal only.
5. Falls within MIL-STD-1835 and GDIP1-T14.

# EXAMPLE BOARD LAYOUT

J0014A

CDIP - 5.08 mm max height

CERAMIC DUAL IN LINE PACKAGE



LAND PATTERN EXAMPLE  
NON-SOLDER MASK DEFINED  
SCALE: 5X



4214771/A 05/2017

N (R-PDIP-T\*\*)

PLASTIC DUAL-IN-LINE PACKAGE

16 PINS SHOWN



- NOTES:
- A. All linear dimensions are in inches (millimeters).
  - B. This drawing is subject to change without notice.
  - Falls within JEDEC MS-001, except 18 and 20 pin minimum body length (Dim A).
  - The 20 pin end lead shoulder width is a vendor option, either half or full width.



# EXAMPLE BOARD LAYOUT

PW0014A

TSSOP - 1.2 mm max height

SMALL OUTLINE PACKAGE



LAND PATTERN EXAMPLE  
EXPOSED METAL SHOWN  
SCALE: 10X



4220202/B 12/2023

NOTES: (continued)

- 6. Publication IPC-7351 may have alternate designs.
- 7. Solder mask tolerances between and around signal pads can vary based on board fabrication site.

# EXAMPLE STENCIL DESIGN

PW0014A

TSSOP - 1.2 mm max height

SMALL OUTLINE PACKAGE



SOLDER PASTE EXAMPLE  
BASED ON 0.125 mm THICK STENCIL  
SCALE: 10X

4220202/B 12/2023

NOTES: (continued)

8. Laser cutting apertures with trapezoidal walls and rounded corners may offer better paste release. IPC-7525 may have alternate design recommendations.
9. Board assembly site may have different recommendations for stencil design.

## IMPORTANT NOTICE AND DISCLAIMER

TI PROVIDES TECHNICAL AND RELIABILITY DATA (INCLUDING DATASHEETS), DESIGN RESOURCES (INCLUDING REFERENCE DESIGNS), APPLICATION OR OTHER DESIGN ADVICE, WEB TOOLS, SAFETY INFORMATION, AND OTHER RESOURCES "AS IS" AND WITH ALL FAULTS, AND DISCLAIMS ALL WARRANTIES, EXPRESS AND IMPLIED, INCLUDING WITHOUT LIMITATION ANY IMPLIED WARRANTIES OF MERCHANTABILITY, FITNESS FOR A PARTICULAR PURPOSE OR NON-INFRINGEMENT OF THIRD PARTY INTELLECTUAL PROPERTY RIGHTS.

These resources are intended for skilled developers designing with TI products. You are solely responsible for (1) selecting the appropriate TI products for your application, (2) designing, validating and testing your application, and (3) ensuring your application meets applicable standards, and any other safety, security, regulatory or other requirements.

These resources are subject to change without notice. TI grants you permission to use these resources only for development of an application that uses the TI products described in the resource. Other reproduction and display of these resources is prohibited. No license is granted to any other TI intellectual property right or to any third party intellectual property right. TI disclaims responsibility for, and you fully indemnify TI and its representatives against any claims, damages, costs, losses, and liabilities arising out of your use of these resources.

TI's products are provided subject to [TI's Terms of Sale](#), [TI's General Quality Guidelines](#), or other applicable terms available either on [ti.com](http://ti.com) or provided in conjunction with such TI products. TI's provision of these resources does not expand or otherwise alter TI's applicable warranties or warranty disclaimers for TI products. Unless TI explicitly designates a product as custom or customer-specified, TI products are standard, catalog, general purpose devices.

TI objects to and rejects any additional or different terms you may propose.

Copyright © 2026, Texas Instruments Incorporated

Last updated 10/2025