

CSD86330Q3D Synchronous Buck NexFET™ Power Block

1 Features

- Half-Bridge Power Block
- 90% System Efficiency at 15 A
- Up to 20 A Operation
- High Frequency Operation (Up To 1.5 MHz)
- High Density – SON 3.3 mm x 3.3 mm Footprint
- Optimized for 5 V Gate Drive
- Low Switching Losses
- Ultra Low Inductance Package
- RoHS Compliant
- Halogen Free
- Pb-Free Terminal Plating

2 Applications

- Synchronous Buck Converters
 - High Frequency Applications
 - High Current, Low Duty Cycle Applications
- Multiphase Synchronous Buck Converters
- POL DC-DC Converters
- IMVP, VRM, and VRD Applications

3 Description

The CSD86330Q3D NexFET™ power block is an optimized design for synchronous buck applications offering high current, high efficiency, and high frequency capability in a small 3.3 mm x 3.3 mm outline. Optimized for 5 V gate drive applications, this product offers a flexible solution capable of offering a high density power supply when paired with any 5 V gate drive from an external controller/driver.

Top View

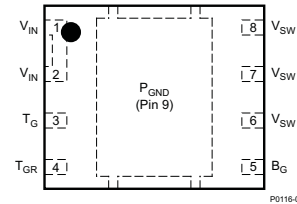

Ordering Information⁽¹⁾

Device	Media	Qty	Package	Ship
CSD86330Q3D	13-Inch Reel	2500	SON 3.3 mm x 3.3 mm Plastic Package	Tape and Reel
CSD86330Q3DT	7-Inch Reel	250		

(1) For all available packages, see the orderable addendum at the end of the data sheet.

R_{DS(on)} vs V_{GS}

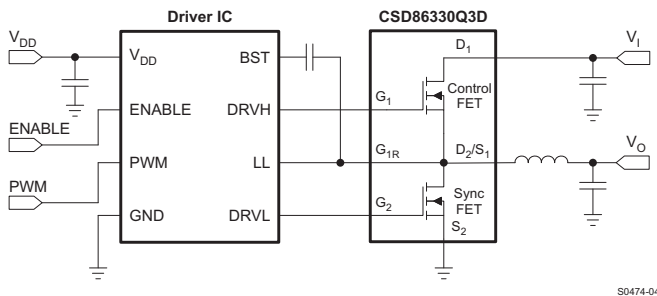

Gate Charge

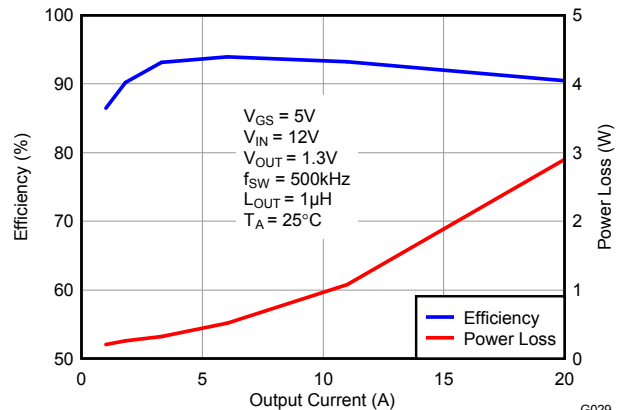

G029



Table of Contents

1 Features	1	6.3 Safe Operating Curves (SOA)	12
2 Applications	1	6.4 Normalized Curves.....	12
3 Description	1	6.5 Calculating Power Loss and SOA	14
4 Revision History	2	7 Recommended PCB Design Overview	15
5 Specifications	3	7.1 Electrical Performance.....	15
5.1 Absolute Maximum Ratings	3	7.2 Thermal Performance	15
5.2 Recommended Operating Conditions.....	3	8 Device and Documentation Support	17
5.3 Thermal Information	3	8.1 Trademarks	17
5.4 Power Block Performance	3	8.2 Electrostatic Discharge Caution.....	17
5.5 Electrical Characteristics.....	4	8.3 Glossary	17
5.6 Typical Power Block Device Characteristics.....	5	9 Mechanical, Packaging, and Orderable Information	18
5.7 Typical Power Block MOSFET Characteristics.....	7	9.1 Q3D Package Dimensions.....	18
6 Application and Implementation	10	9.2 Land Pattern Recommendation	19
6.1 Application Information.....	10	9.3 Stencil Recommendation	19
6.2 Power Loss Curves	12	9.4 Q3D Tape and Reel Information.....	20

4 Revision History

NOTE: Page numbers for previous revisions may differ from page numbers in the current version.

Changes from Revision C (October 2011) to Revision D

Page

- Corrected 125°C line in [Figure 20](#) to agree with data in [Figure 22](#) **8**
- Corrected 125°C line in [Figure 21](#) to agree with data in [Figure 23](#) **8**

Changes from Revision B (September 2011) to Revision C

Page

- Changed "DIM A" Millimeter Max value From: 1.55 To: 1.5 and Inches Max value From: 0.061 To: 0.059 **18**

Changes from Revision A (December 2010) to Revision B

Page

- Change $R_{DS(on)}$ to $Z_{DS(on)}$
 4 |- Added *Equivalent System Performance* section
 10 |- Added Electrical Performance bullet
 15 |

Changes from Original (October 2010) to Revision A

Page

- Changed I_{OUT} Conditions From: 20A To: 15A, and the TYP value From: 2.9W To: 1.9W..... **3**

5 Specifications

5.1 Absolute Maximum Ratings

 $T_A = 25^\circ\text{C}$ (unless otherwise noted)⁽¹⁾

		MIN	MAX	UNIT
Voltage range	V_{IN} to P_{GND}	-0.8	25	V
	T_G to T_{GR}	-8	10	V
	B_G to P_{GND}	-8	10	V
Pulsed Current Rating, I_{DM}			60	A
Power Dissipation, P_D			6	W
Avalanche Energy E_{AS}	Sync FET, $I_D = 65\text{ A}$, $L = 0.1\text{ mH}$		211	mJ
	Control FET, $I_D = 42\text{ A}$, $L = 0.1\text{ mH}$		88	
Operating junction, T_J		-55	150	$^\circ\text{C}$
Storage temperature, T_{stg}		-55	150	$^\circ\text{C}$

(1) Stresses beyond those listed under Absolute Maximum Ratings may cause permanent damage to the device. These are stress ratings only, and functional operation of the device at these or any other conditions beyond those indicated is not implied. Exposure to absolute-maximum-rated conditions for extended periods may affect device reliability.

5.2 Recommended Operating Conditions

 $T_A = 25^\circ$ (unless otherwise noted)

		MIN	MAX	UNIT
Gate drive voltage, V_{GS}		4.5	8	V
Input supply voltage, V_{IN}			22	V
Switching frequency, f_{SW}	$C_{BST} = 0.1\ \mu\text{F}$ (min)	200	1500	kHz
Operating current			20	A
Operating temperature, T_J			125	$^\circ\text{C}$

5.3 Thermal Information

 $T_A = 25^\circ\text{C}$ (unless otherwise stated)

THERMAL METRIC		MIN	TYP	MAX	UNIT
$R_{\theta JA}$	Junction-to-ambient thermal resistance (Min Cu) ⁽¹⁾			135	$^\circ\text{C}/\text{W}$
	Junction-to-ambient thermal resistance (Max Cu) ⁽¹⁾⁽²⁾			73	
$R_{\theta JC}$	Junction-to-case thermal resistance (Top of package) ⁽¹⁾			29	
	Junction-to-case thermal resistance (P_{GND} Pin) ⁽¹⁾			2.5	

(1) $R_{\theta JC}$ is determined with the device mounted on a 1 inch² (6.45 cm²), 2 oz. (0.071 mm thick) Cu pad on a 1.5 inches x 1.5 inches (3.81 cm x 3.81 cm), 0.06 inch (1.52 mm) thick FR4 board. $R_{\theta JC}$ is specified by design while $R_{\theta JA}$ is determined by the user's board design.

(2) Device mounted on FR4 material with 1 inch² (6.45 cm²) Cu.

5.4 Power Block Performance

 $T_A = 25^\circ$ (unless otherwise noted)

PARAMETER	TEST CONDITIONS	MIN	TYP	MAX	UNIT
Power Loss, P_{LOSS} ⁽¹⁾	$V_{IN} = 12\text{ V}$, $V_{GS} = 5\text{ V}$, $V_{OUT} = 1.3\text{ V}$, $I_{OUT} = 15\text{ A}$, $f_{SW} = 500\text{ kHz}$, $L_{OUT} = 1\ \mu\text{H}$, $T_J = 25^\circ\text{C}$		1.9		W
V_{IN} Quiescent Current, I_{QVIN}	T_G to $T_{GR} = 0\text{ V}$ B_G to $P_{GND} = 0\text{ V}$		10		μA

(1) Measurement made with six 10 μF (TDK C3216X5R1C106KT or equivalent) ceramic capacitors placed across V_{IN} to P_{GND} pins and using a high current 5 V driver IC.

5.5 Electrical Characteristics

 $T_A = 25^\circ\text{C}$ (unless otherwise stated)

PARAMETER	TEST CONDITIONS	Q1 Control FET			Q2 Sync FET			UNIT			
		MIN	TYP	MAX	MIN	TYP	MAX				
STATIC CHARACTERISTICS											
BV_{DSS}	Drain-to-Source Voltage	$V_{GS} = 0\text{ V}, I_{DS} = 250\ \mu\text{A}$			25			V			
I_{DSS}	Drain-to-Source Leakage Current	$V_{GS} = 0\text{ V}, V_{DS} = 20\text{ V}$			1			μA			
I_{GSS}	Gate-to-Source Leakage Current	$V_{DS} = 0\text{ V}, V_{GS} = +10 / -8$			100			nA			
$V_{GS(th)}$	Gate-to-Source Threshold Voltage	$V_{DS} = V_{GS}, I_{DS} = 250\ \mu\text{A}$			0.9	1.4	2.1	0.9	1.1	1.6	V
$Z_{DS(on)}$	Effective AC On-Impedance	$V_{IN} = 12\text{ V}, V_{GS} = 5\text{ V}, V_{OUT} = 1.3\text{ V}, I_{OUT} = 15\text{ A}, f_{SW} = 500\text{ kHz}, L_{OUT} = 1\ \mu\text{H}$			8.8			3.3		$\text{m}\Omega$	
g_{fs}	Transconductance	$V_{DS} = 15\text{ V}, I_{DS} = 14\text{ A}$			52			82		S	
DYNAMIC CHARACTERISTICS											
C_{ISS}	Input Capacitance ⁽¹⁾	$V_{GS} = 0\text{ V}, V_{DS} = 12.5\text{ V}, f = 1\text{ MHz}$			710	920	1280		1660	pF	
C_{OSS}	Output Capacitance ⁽¹⁾				350	455	680		880	pF	
C_{RSS}	Reverse Transfer Capacitance ⁽¹⁾				18	23	38		49	pF	
R_G	Series Gate Resistance ⁽¹⁾	$V_{DS} = 12.5\text{ V}, I_{DS} = 14\text{ A}$			1.5	3.0	1.2		2.4	Ω	
Q_g	Gate Charge Total (4.5 V) ⁽¹⁾				4.8	6.2	9.2		12	nC	
Q_{gd}	Gate Charge - Gate-to-Drain				0.9		1.6			nC	
Q_{gs}	Gate Charge - Gate-to-Source				1.6		2.1			nC	
$Q_{g(th)}$	Gate Charge at V_{th}				0.9		1.2			nC	
Q_{OSS}	Output Charge	$V_{DS} = 15.5\text{ V}, V_{GS} = 0\text{ V}$			7.2		13.6		nC		
$t_{d(on)}$	Turn On Delay Time	$V_{DS} = 12.5\text{ V}, V_{GS} = 4.5\text{ V}, I_{DS} = 14\text{ A}, R_G = 2\ \Omega$			4.9		5.3		ns		
t_r	Rise Time				7.5		6.3		ns		
$t_{d(off)}$	Turn Off Delay Time				8.5		15.8		ns		
t_f	Fall Time				1.9		4.2		ns		
DIODE CHARACTERISTICS											
V_{SD}	Diode Forward Voltage	$I_{DS} = 14\text{ A}, V_{GS} = 0\text{ V}$			0.85	1	0.8		1	V	
Q_{rr}	Reverse Recovery Charge	$V_{dd} = 15.5\text{ V}, I_F = 14\text{ A}, di/dt = 300\text{ A}/\mu\text{s}$			3.9		7.3		nC		
t_{rr}	Reverse Recovery Time				13.9		19		ns		

(1) Specified by design

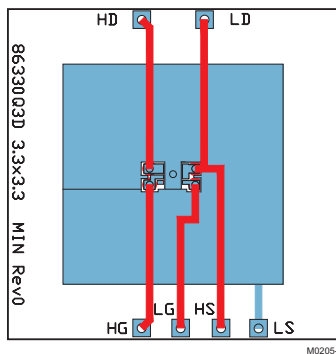

Max $R_{\theta JA} = 76^\circ\text{C}/\text{W}$
 when mounted on
 1 inch² (6.45 cm²) of
 2 oz. (0.071 mm thick)
 Cu.

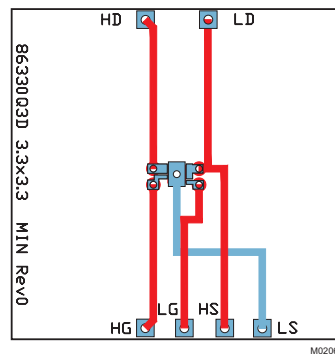

Max $R_{\theta JA} = 140^\circ\text{C}/\text{W}$
 when mounted on
 minimum pad area of
 2 oz. (0.071 mm thick)
 Cu.

5.6 Typical Power Block Device Characteristics

$V_{IN} = 12\text{ V}$, $V_{DD} = 5\text{ V}$, $f_{SW} = 500\text{ kHz}$, $V_{OUT} = 1.2\text{ V}$, $L_{OUT} = 1.0\text{ }\mu\text{H}$, $I_{OUT} = 20\text{ A}$, $T_J = 125^\circ\text{C}$, unless stated otherwise.

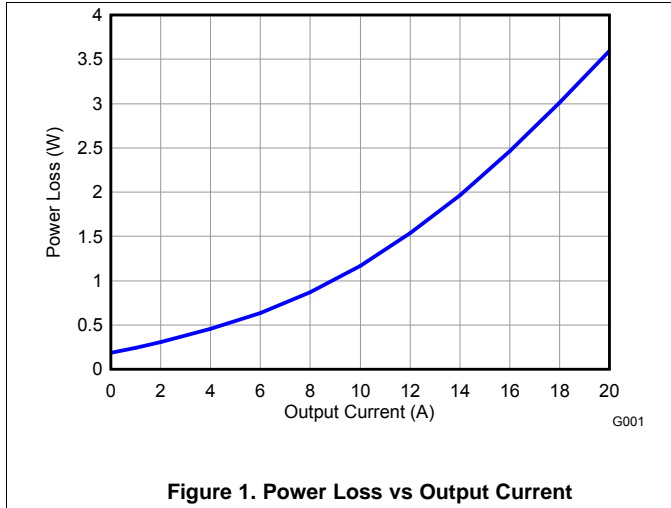

Figure 1. Power Loss vs Output Current

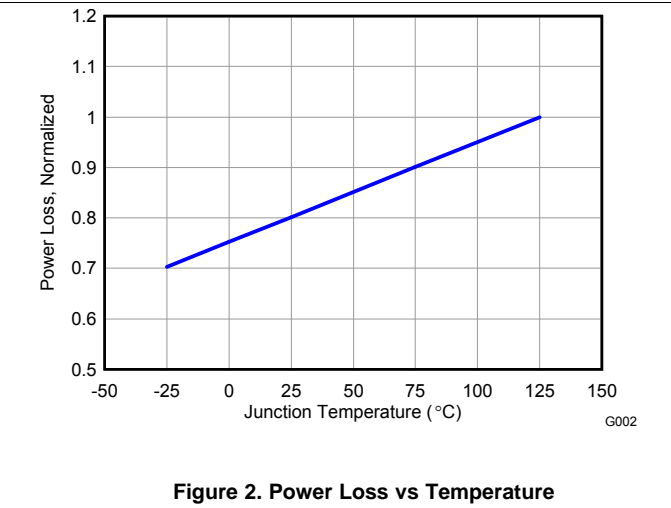

Figure 2. Power Loss vs Temperature

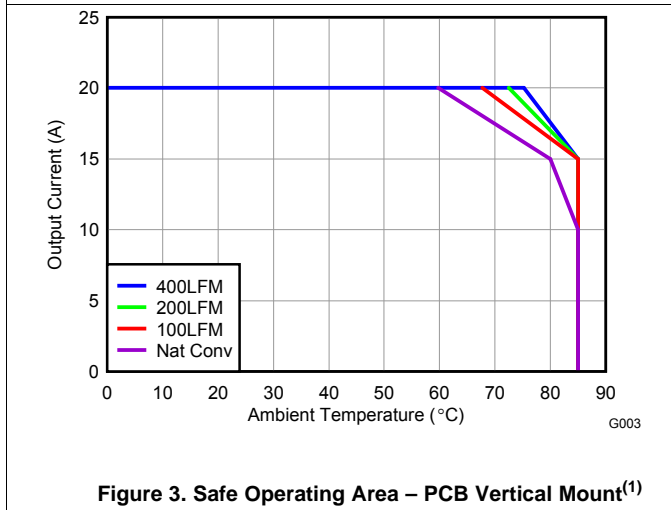

Figure 3. Safe Operating Area – PCB Vertical Mount⁽¹⁾

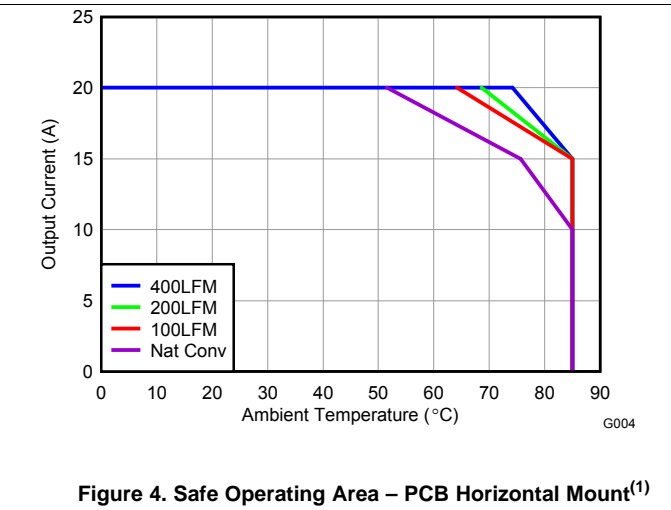

Figure 4. Safe Operating Area – PCB Horizontal Mount⁽¹⁾

(1) The Typical Power Block System Characteristic curves are based on measurements made on a PCB design with dimensions of 4.0" (W) × 3.5" (L) × 0.062" (H) and 6 copper layers of 1 oz. copper thickness. See Application Section for detailed explanation.

Typical Power Block Device Characteristics (continued)

$V_{IN} = 12\text{ V}$, $V_{DD} = 5\text{ V}$, $f_{SW} = 500\text{ kHz}$, $V_{OUT} = 1.2\text{ V}$, $L_{OUT} = 1.0\text{ }\mu\text{H}$, $I_{OUT} = 20\text{ A}$, $T_J = 125^\circ\text{C}$, unless stated otherwise.

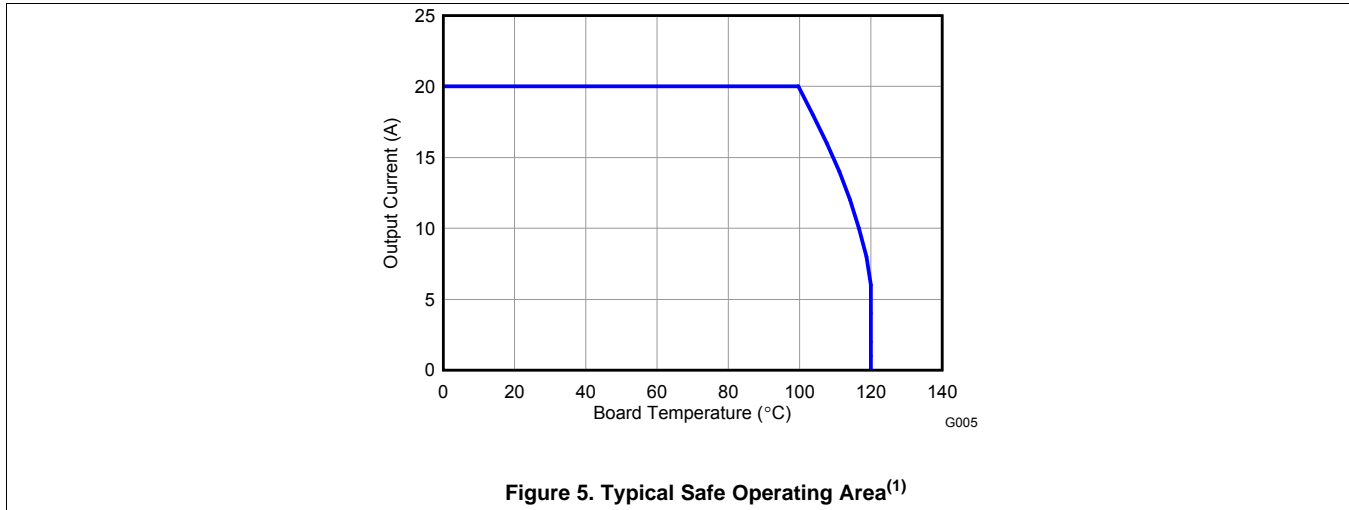

Figure 5. Typical Safe Operating Area⁽¹⁾

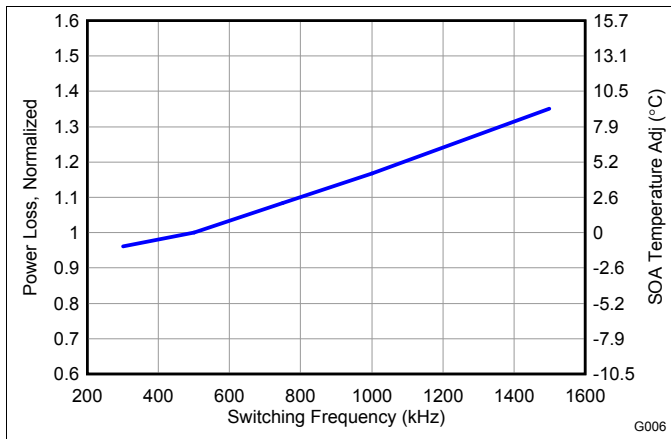

Figure 6. Normalized Power Loss vs Switching Frequency

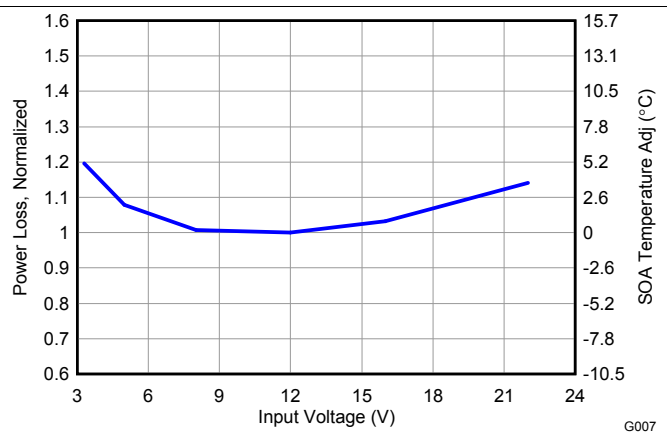

Figure 7. Normalized Power Loss vs Input Voltage

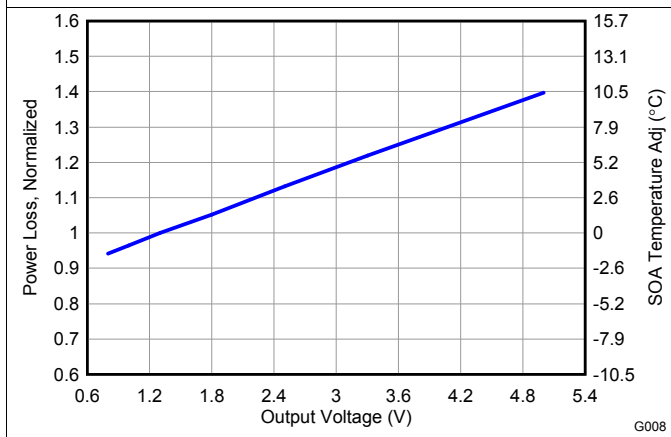

Figure 8. Normalized Power Loss vs Output Voltage

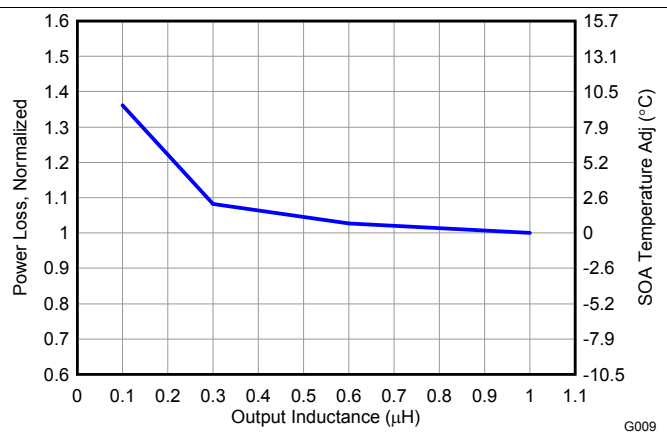
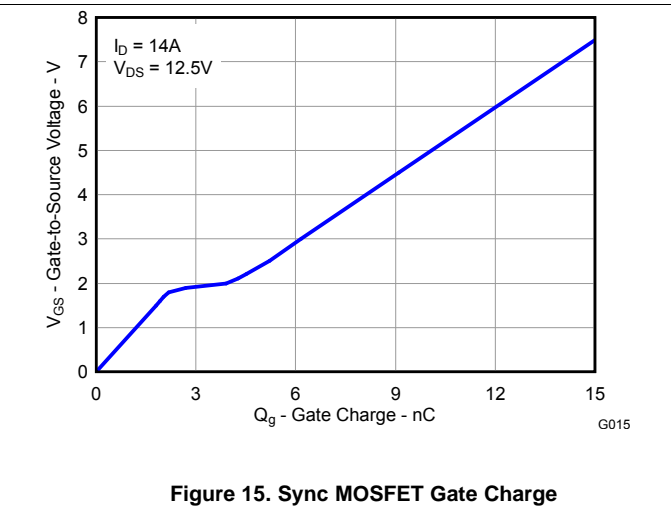
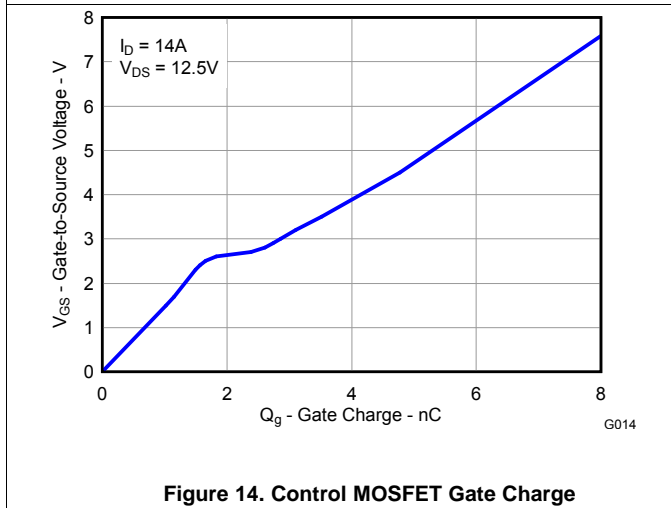
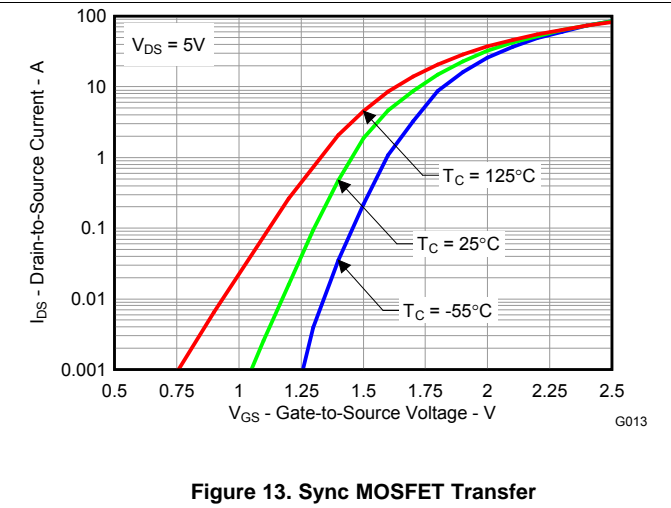
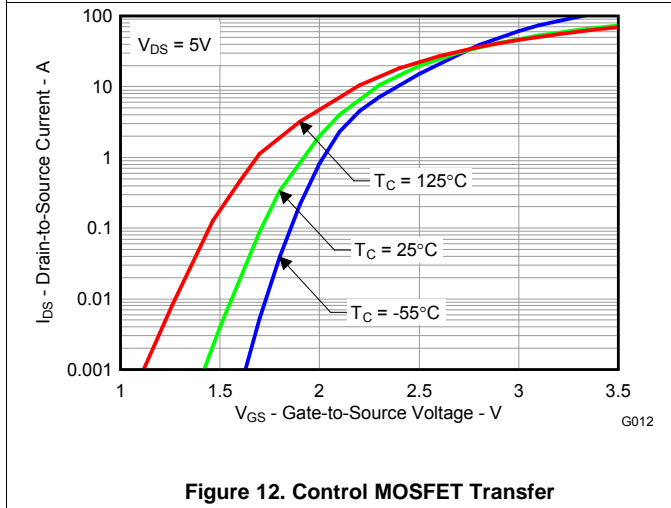
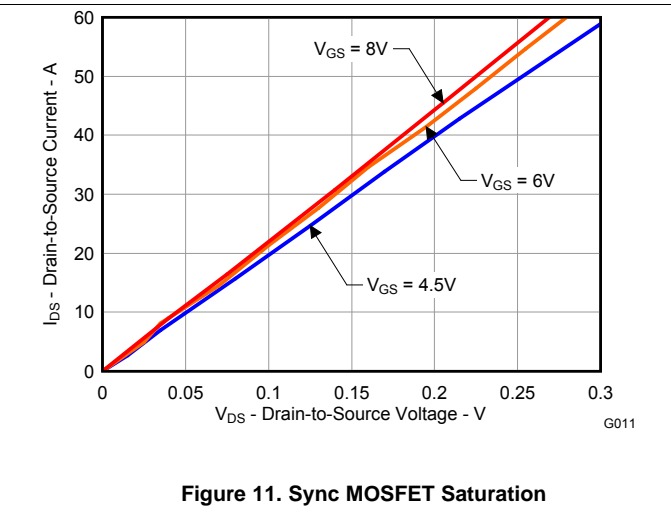
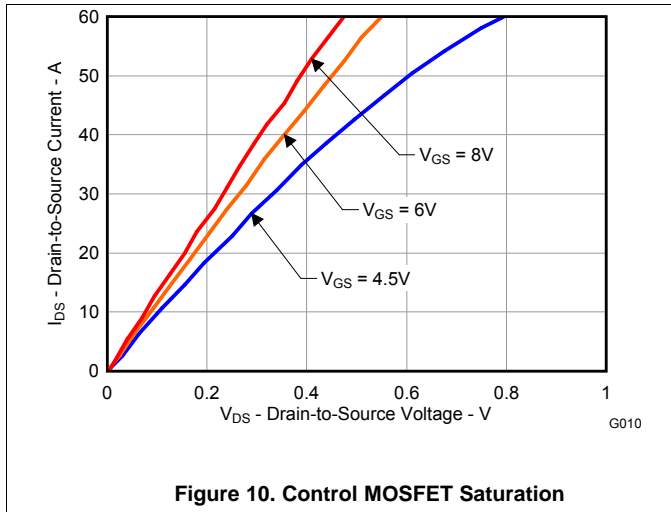

Figure 9. Normalized Power Loss vs Output Inductance

5.7 Typical Power Block MOSFET Characteristics

$T_A = 25^\circ\text{C}$, unless stated otherwise.



Typical Power Block MOSFET Characteristics (continued)

T_A = 25°C, unless stated otherwise.

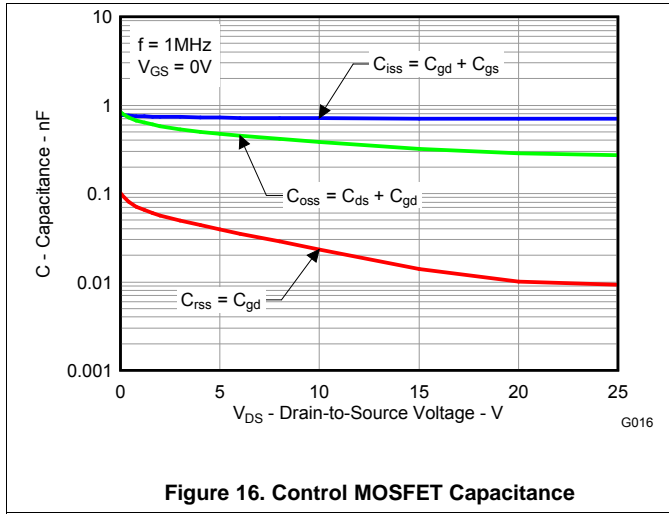

Figure 16. Control MOSFET Capacitance

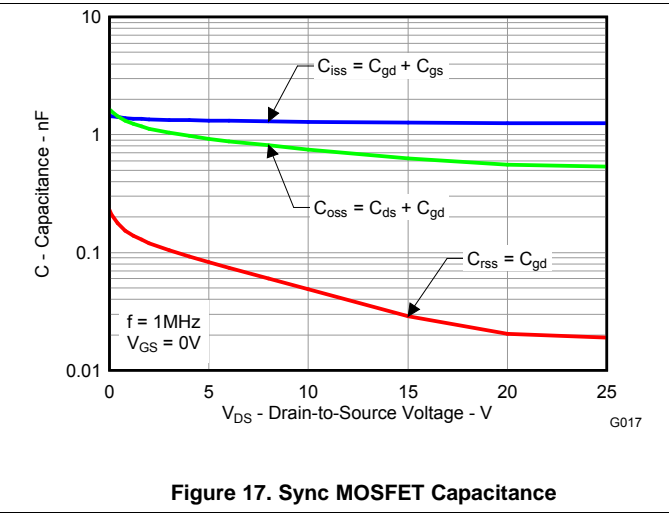

Figure 17. Sync MOSFET Capacitance

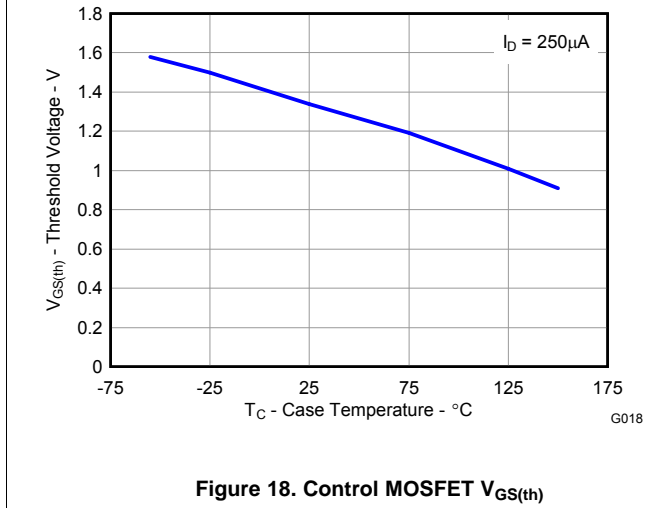

Figure 18. Control MOSFET V_{GS(th)}

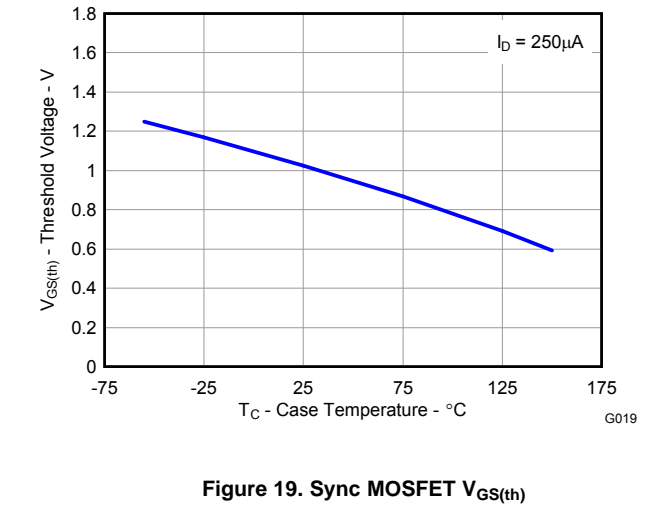

Figure 19. Sync MOSFET V_{GS(th)}

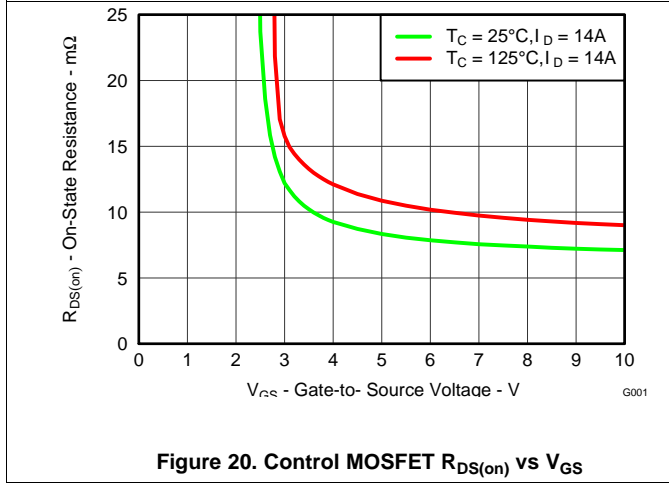

Figure 20. Control MOSFET R_{DS(on)} vs V_{GS}

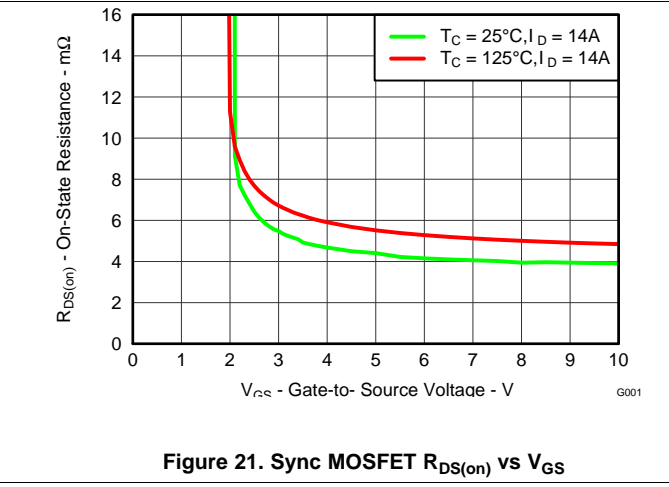
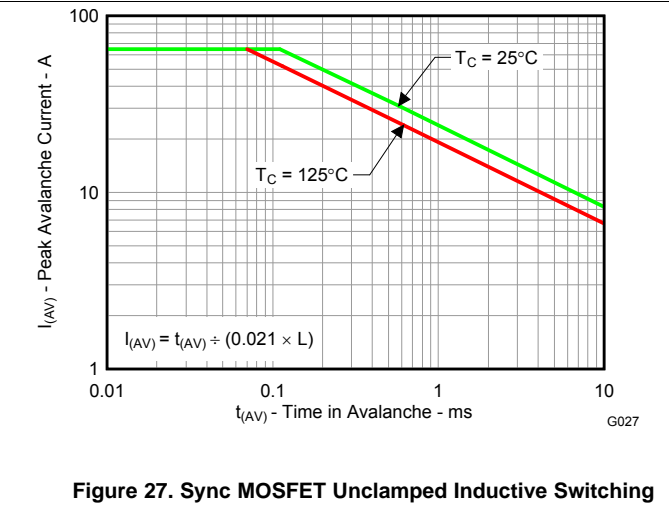
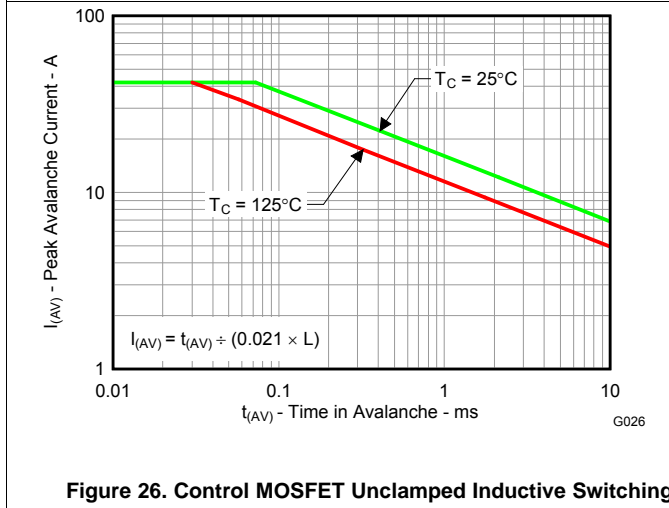
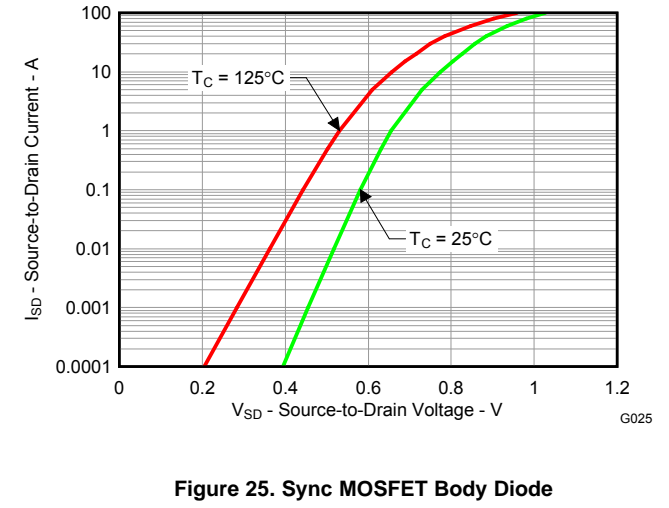
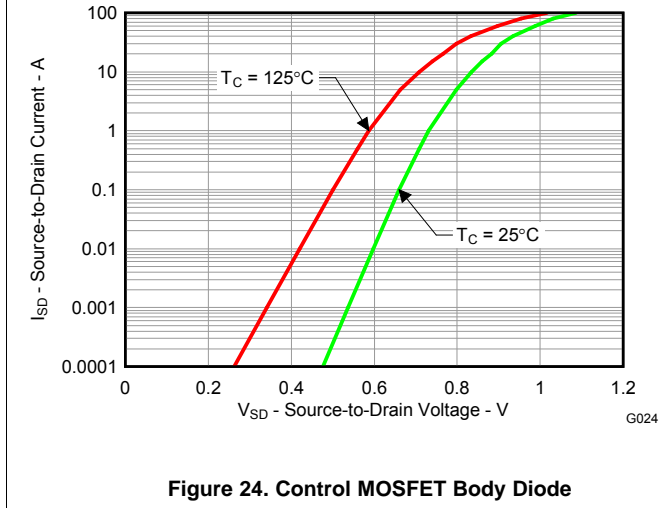
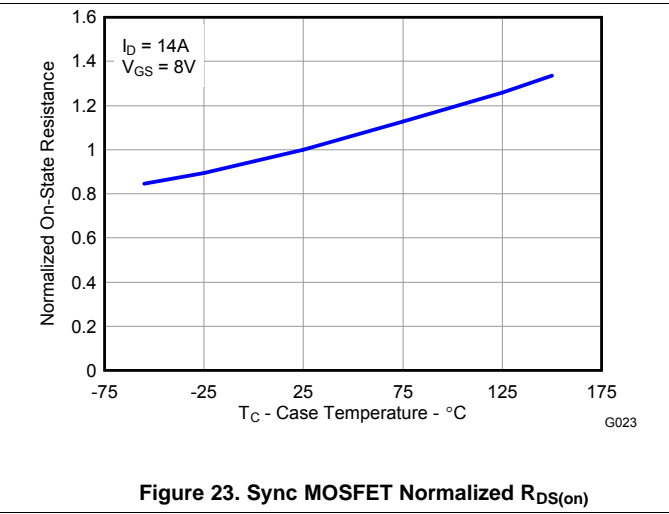
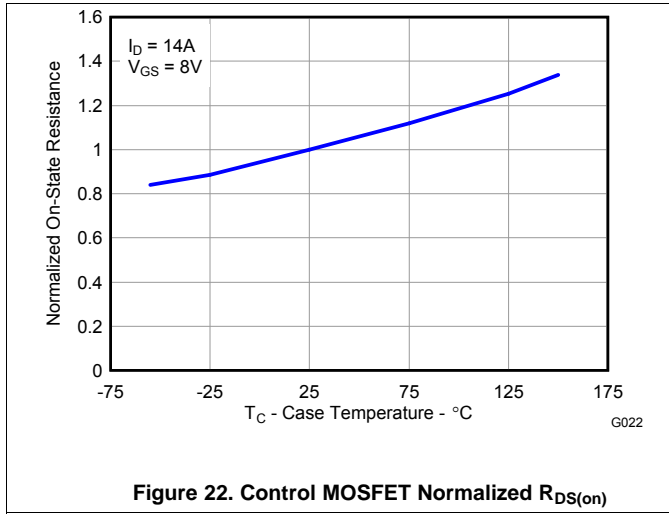

Figure 21. Sync MOSFET R_{DS(on)} vs V_{GS}

Typical Power Block MOSFET Characteristics (continued)

T_A = 25°C, unless stated otherwise.



6 Application and Implementation

NOTE

Information in the following applications sections is not part of the TI component specification, and TI does not warrant its accuracy or completeness. TI's customers are responsible for determining suitability of components for their purposes. Customers should validate and test their design implementation to confirm system functionality.

6.1 Application Information

6.1.1 Equivalent System Performance

Many of today's high performance computing systems require low power consumption in an effort to reduce system operating temperatures and improve overall system efficiency. This has created a major emphasis on improving the conversion efficiency of today's Synchronous Buck Topology. In particular, there has been an emphasis in improving the performance of the critical Power Semiconductor in the Power Stage of this Application (see [Figure 28](#)). As such, optimization of the power semiconductors in these applications, needs to go beyond simply reducing $R_{DS(ON)}$.

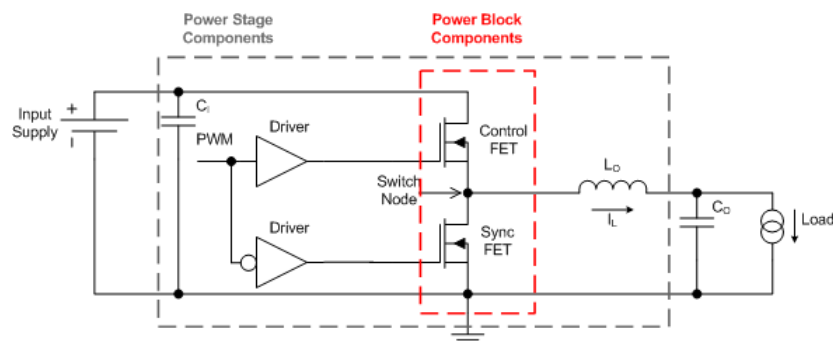

Figure 28.

The CSD86330Q3D is part of TI's Power Block product family which is a highly optimized product for use in a synchronous buck topology requiring high current, high efficiency, and high frequency. It incorporates TI's latest generation silicon which has been optimized for switching performance, as well as minimizing losses associated with Q_{GD} , Q_{GS} , and Q_{RR} . Furthermore, TI's patented packaging technology has minimized losses by nearly eliminating parasitic elements between the Control FET and Sync FET connections (see [Figure 29](#)). A key challenge solved by TI's patented packaging technology is the system level impact of Common Source Inductance (CSI). CSI greatly impedes the switching characteristics of any MOSFET which in turn increases switching losses and reduces system efficiency. As a result, the effects of CSI need to be considered during the MOSFET selection process. In addition, standard MOSFET switching loss equations used to predict system efficiency need to be modified in order to account for the effects of CSI. Further details behind the effects of CSI and modification of switching loss equations are outlined in TI's Application Note [SLPA009](#).

Application Information (continued)

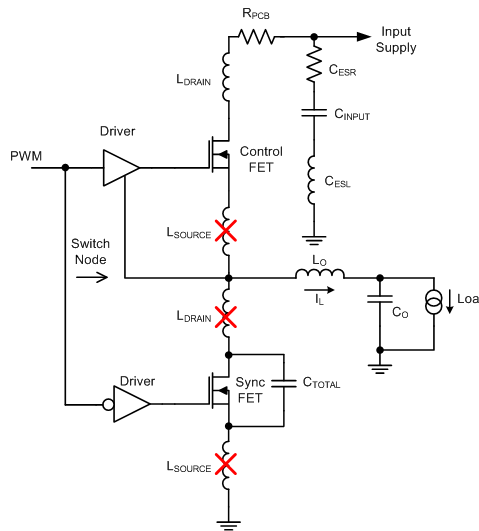

Figure 29.

The combination of TI's latest generation silicon and optimized packaging technology has created a benchmarking solution that outperforms industry standard MOSFET chipsets of similar $R_{DS(ON)}$ and MOSFET chipsets with lower $R_{DS(ON)}$. Figure 30 and Figure 31 compare the efficiency and power loss performance of the CSD86330Q3D versus industry standard MOSFET chipsets commonly used in this type of application. This comparison purely focuses on the efficiency and generated loss of the power semiconductors only. The performance of CSD86330Q3D clearly highlights the importance of considering the Effective AC On-Impedance ($Z_{DS(ON)}$) during the MOSFET selection process of any new design. Simply normalizing to traditional MOSFET $R_{DS(ON)}$ specifications is not an indicator of the actual in-circuit performance when using TI's Power Block technology.

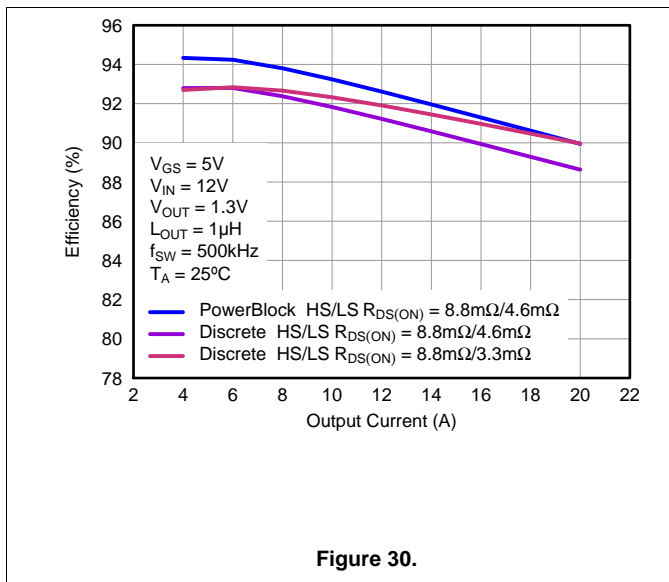

Figure 30.

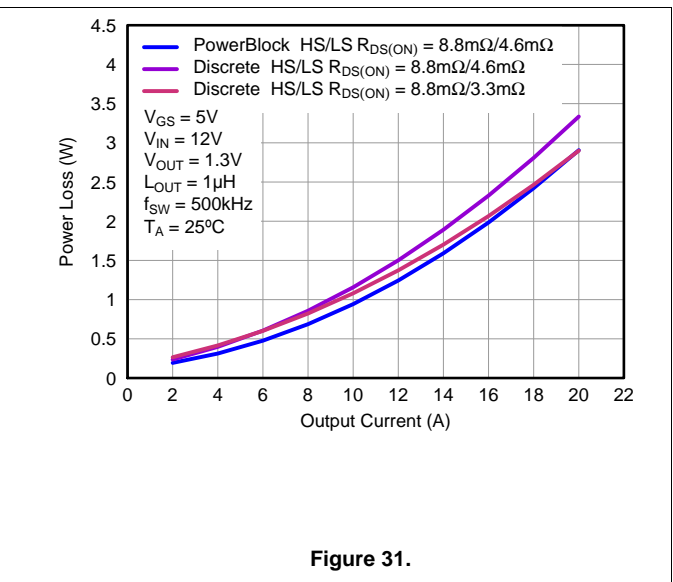

Figure 31.

Application Information (continued)

Table 1 compares the traditional DC measured $R_{DS(ON)}$ of CSD86330Q3D versus its $Z_{DS(ON)}$. This comparison takes into account the improved efficiency associated with TI's patented packaging technology. As such, when comparing TI's Power Block products to individually packaged discrete MOSFETs or dual MOSFETs in a standard package, the in-circuit switching performance of the solution must be considered. In this example, individually packaged discrete MOSFETs or dual MOSFETs in a standard package would need to have DC measured $R_{DS(ON)}$ values that are equivalent to CSD86330Q3D's $Z_{DS(ON)}$ value in order to have the same efficiency performance at full load. Mid to light-load efficiency will still be lower with individually packaged discrete MOSFETs or dual MOSFETs in a standard package.

Table 1. Comparison of $R_{DS(ON)}$ vs $Z_{DS(ON)}$

Parameter	HS		LS	
	Typ	Max	Typ	Max
Effective AC On-Impedance $Z_{DS(ON)}$ ($V_{GS} = 5\text{ V}$)	8.8	-	3.3	-
DC Measured $R_{DS(ON)}$ ($V_{GS} = 4.5\text{ V}$)	8.8	11.5	4.6	6

The CSD86330Q3D NexFET power block is an optimized design for synchronous buck applications using 5 V gate drive. The Control FET and Sync FET silicon are parametrically tuned to yield the lowest power loss and highest system efficiency. As a result, a new rating method is needed which is tailored towards a more systems centric environment. System level performance curves such as Power Loss, Safe Operating Area, and normalized graphs allow engineers to predict the product performance in the actual application.

6.2 Power Loss Curves

MOSFET centric parameters such as $R_{DS(ON)}$ and Q_{gd} are needed to estimate the loss generated by the devices. In an effort to simplify the design process for engineers, Texas Instruments has provided measured power loss performance curves. **Figure 1** plots the power loss of the CSD86330Q3D as a function of load current. This curve is measured by configuring and running the CSD86330Q3D as it would be in the final application (see **Figure 32**). The measured power loss is the CSD86330Q3D loss and consists of both input conversion loss and gate drive loss. **Equation 1** is used to generate the power loss curve.

$$(V_{IN} \times I_{IN}) + (V_{DD} \times I_{DD}) - (V_{SW_AVG} \times I_{OUT}) = \text{Power Loss} \quad (1)$$

The power loss curve in **Figure 1** is measured at the maximum recommended junction temperatures of 125°C under isothermal test conditions.

6.3 Safe Operating Curves (SOA)

The SOA curves in the CSD86330Q3D data sheet provides guidance on the temperature boundaries within an operating system by incorporating the thermal resistance and system power loss. **Figure 3** to **Figure 5** outline the temperature and airflow conditions required for a given load current. The area under the curve dictates the safe operating area. All the curves are based on measurements made on a PCB design with dimensions of 4" (W) × 3.5" (L) × 0.062" (T) and 6 copper layers of 1 oz. copper thickness.

6.4 Normalized Curves

The normalized curves in the CSD86330Q3D data sheet provides guidance on the Power Loss and SOA adjustments based on their application specific needs. These curves show how the power loss and SOA boundaries will adjust for a given set of systems conditions. The primary Y-axis is the normalized change in power loss and the secondary Y-axis is the change in system temperature required in order to comply with the SOA curve. The change in power loss is a multiplier for the Power Loss curve and the change in temperature is subtracted from the SOA curve.

Normalized Curves (continued)

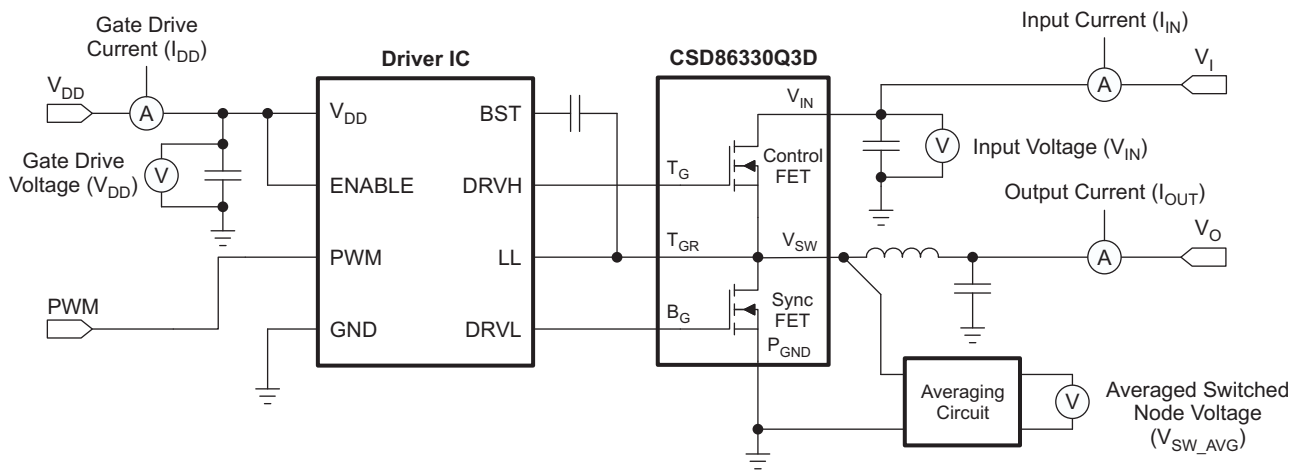

S0475-04

Figure 32. Typical Application

6.5 Calculating Power Loss and SOA

The user can estimate product loss and SOA boundaries by arithmetic means (see [Design Example](#)). Though the Power Loss and SOA curves in this data sheet are taken for a specific set of test conditions, the following procedure will outline the steps the user should take to predict product performance for any set of system conditions.

6.5.1 Design Example

Operating Conditions:

- Output Current = 15 A
- Input Voltage = 12 V
- Output Voltage = 1.2 V
- Switching Frequency = 1000 kHz
- Inductor = 0.4 μ H

6.5.2 Calculating Power Loss

- Power Loss at 15 A = 2.2 W ([Figure 1](#))
- Normalized Power Loss for input voltage ≈ 1.0 ([Figure 7](#))
- Normalized Power Loss for output voltage ≈ 0.98 ([Figure 8](#))
- Normalized Power Loss for switching frequency ≈ 1.17 ([Figure 6](#))
- Normalized Power Loss for output inductor ≈ 1.06 ([Figure 9](#))
- **Final calculated Power Loss = 2.2 W \times 1.0 \times 0.98 \times 1.17 \times 1.06 \approx 2.67 W**

6.5.3 Calculating SOA Adjustments

- SOA adjustment for input voltage $\approx 0^\circ\text{C}$ ([Figure 7](#))
- SOA adjustment for output voltage $\approx -0.29^\circ\text{C}$ ([Figure 8](#))
- SOA adjustment for switching frequency $\approx 4.1^\circ\text{C}$ ([Figure 6](#))
- SOA adjustment for output inductor $\approx 1.5^\circ\text{C}$ ([Figure 9](#))
- **Final calculated SOA adjustment = 0 + (-0.29) + 4.1 + 1.5 \approx 5.3 $^\circ\text{C}$**

In the design example above, the estimated power loss of the CSD86330Q3D would increase to 2.67 W. In addition, the maximum allowable board and/or ambient temperature would have to decrease by 5.3 $^\circ\text{C}$. [Figure 33](#) graphically shows how the SOA curve would be adjusted accordingly.

1. Start by drawing a horizontal line from the application current to the SOA curve.
2. Draw a vertical line from the SOA curve intercept down to the board/ambient temperature.
3. Adjust the SOA board/ambient temperature by subtracting the temperature adjustment value.

In the design example, the SOA temperature adjustment yields a reduction in allowable board/ambient temperature of 5.3 $^\circ\text{C}$. In the event the adjustment value is a negative number, subtracting the negative number would yield an increase in allowable board/ambient temperature.

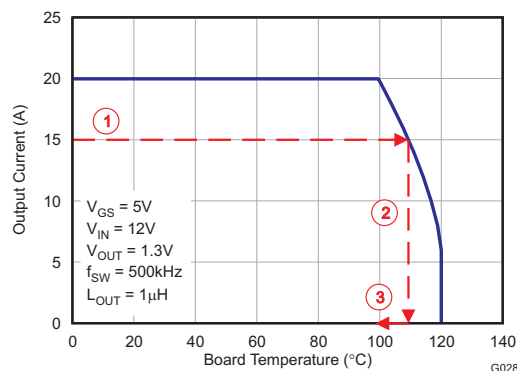

Figure 33. Power Block SOA

7 Recommended PCB Design Overview

There are two key system-level parameters that can be addressed with a proper PCB design: Electrical and Thermal performance. Properly optimizing the PCB layout will yield maximum performance in both areas. A brief description on how to address each parameter is provided.

7.1 Electrical Performance

The Power Block has the ability to switch voltages at rates greater than 10 kV/μs. Special care must be then taken with the PCB layout design and placement of the input capacitors, Driver IC, and output inductor.

- The placement of the input capacitors relative to the Power Block's VIN and PGND pins should have the highest priority during the component placement routine. It is critical to minimize these node lengths. As such, ceramic input capacitors need to be placed as close as possible to the VIN and PGND pins (see [Figure 34](#)). The example in [Figure 34](#) uses 6 × 10 μF ceramic capacitors (TDK part number C3216X5R1C106KT or equivalent). Notice there are ceramic capacitors on both sides of the board with an appropriate amount of vias interconnecting both layers. In terms of priority of placement next to the Power Block, C5, C7, C19, and C8 should follow in order.
- The Driver IC should be placed relatively close to the Power Block Gate pins. T_G and B_G should connect to the outputs of the Driver IC. The T_{GR} pin serves as the return path of the high-side gate drive circuitry and should be connected to the Phase pin of the IC (sometimes called LX, LL, SW, PH, etc.). The bootstrap capacitor for the Driver IC will also connect to this pin.
- The switching node of the output inductor should be placed relatively close to the Power Block VSW pins. Minimizing the node length between these two components will reduce the PCB conduction losses and actually reduce the switching noise level.
- In the event the switch node waveform exhibits ringing that reaches undesirable levels, the use of a Boost Resistor or RC snubber can be an effective way to reduce the peak ring level. The recommended Boost Resistor value will range between 1 Ω to 4.7 Ω depending on the output characteristics of Driver IC used in conjunction with the Power Block. The RC snubber values can range from 0.5 Ω to 2.2 Ω for the R and 330 pF to 2200 pF for the C. Refer to TI App Note [SLUP100](#) for more details on how to properly tune the RC snubber values. The RC snubber should be placed as close as possible to the Vsw node and PGND see [Figure 34](#) ⁽¹⁾

7.2 Thermal Performance

The Power Block has the ability to utilize the GND planes as the primary thermal path. As such, the use of thermal vias is an effective way to pull away heat from the device and into the system board. Concerns of solder voids and manufacturability problems can be addressed by the use of three basic tactics to minimize the amount of solder attach that will wick down the via barrel:

- Intentionally space out the vias from each other to avoid a cluster of holes in a given area.
- Use the smallest drill size allowed in your design. The example in [Figure 34](#) uses vias with a 10 mil drill hole and a 16 mil capture pad.
- Tent the opposite side of the via with solder-mask.

In the end, the number and drill size of the thermal vias should align with the end user's PCB design rules and manufacturing capabilities.

(1) Keong W. Kam, David Pommerenke, "EMI Analysis Methods for Synchronous Buck Converter EMI Root Cause Analysis", University of Missouri – Rolla

Thermal Performance (continued)

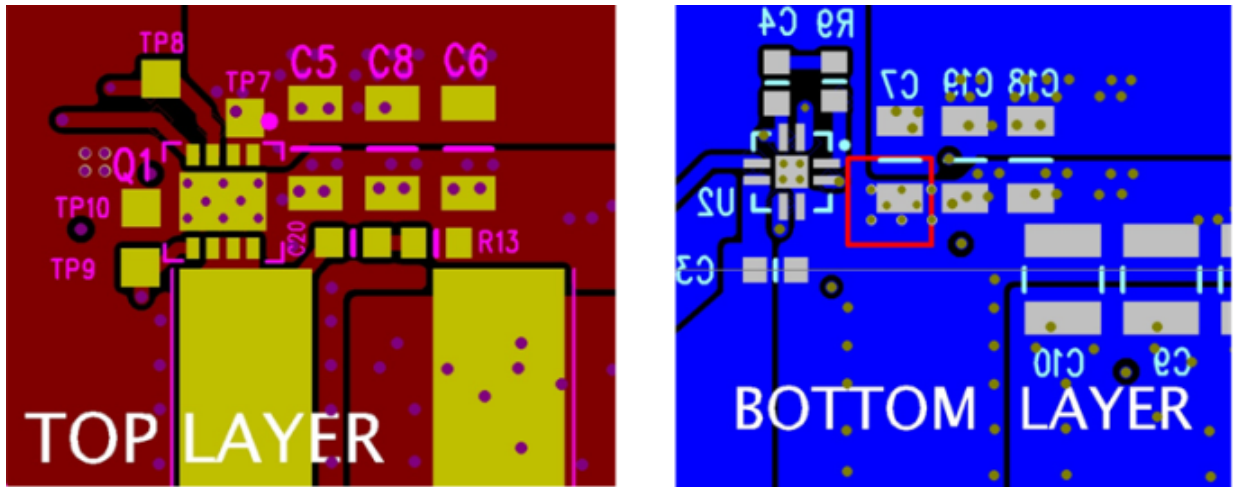

Figure 34. Recommended PCB Layout (Top Down)

8 Device and Documentation Support

8.1 Trademarks

NexFET is a trademark of Texas Instruments.
All other trademarks are the property of their respective owners.

8.2 Electrostatic Discharge Caution



These devices have limited built-in ESD protection. The leads should be shorted together or the device placed in conductive foam during storage or handling to prevent electrostatic damage to the MOS gates.

8.3 Glossary

[SLYZ022](#) — *TI Glossary*.

This glossary lists and explains terms, acronyms, and definitions.

9.2 Land Pattern Recommendation

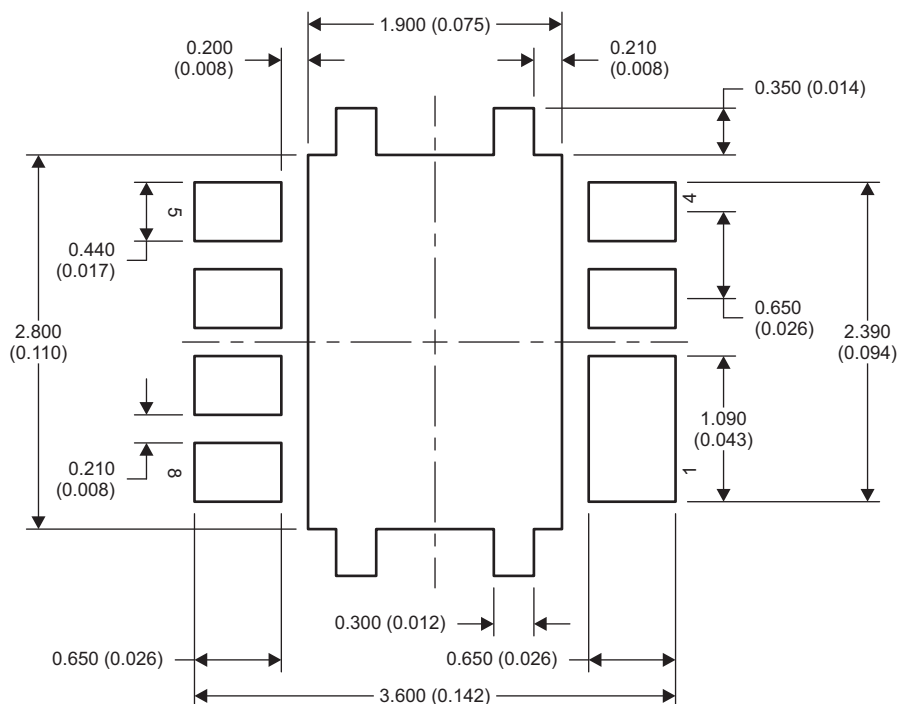

M0193-01

NOTE: Dimensions are in mm (inches).

9.3 Stencil Recommendation

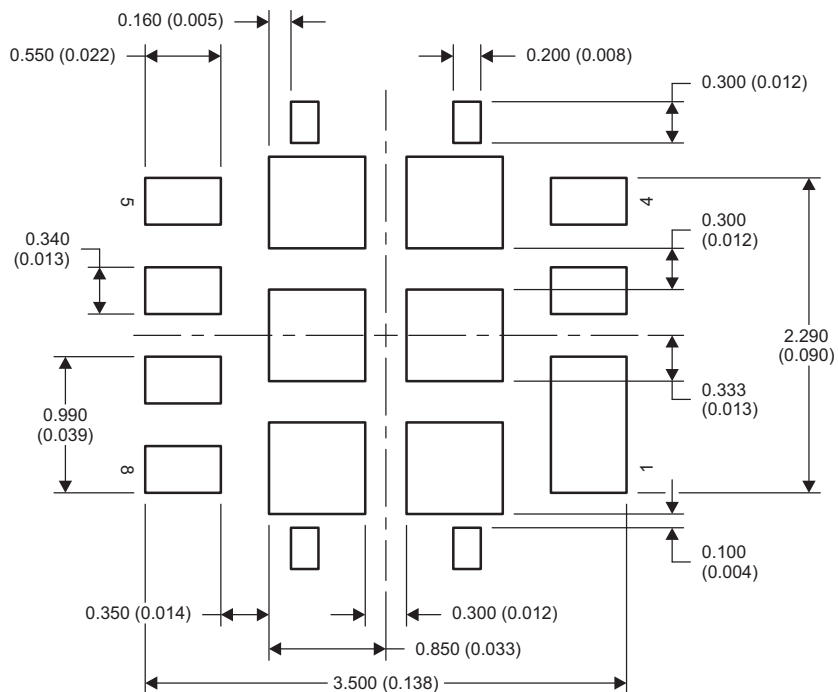

M0207-01

NOTE: Dimensions are in mm (inches).

For recommended circuit layout for PCB designs, see application note [SLPA005 – Reducing Ringing Through PCB Layout Techniques](#).

9.4 Q3D Tape and Reel Information

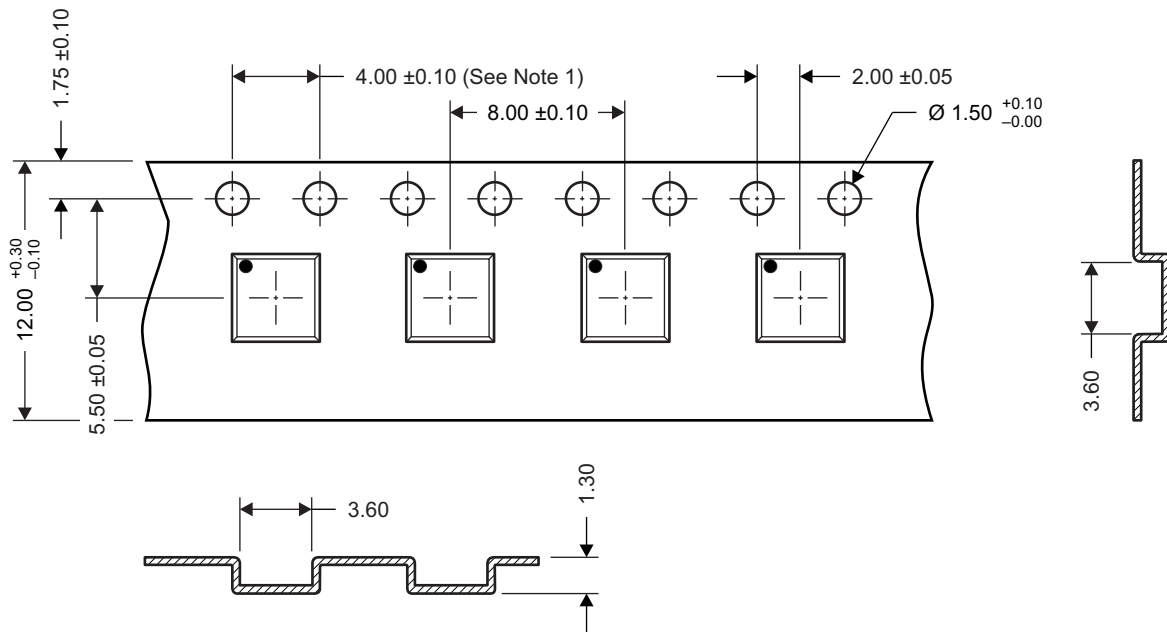

M0144-01

- NOTES:
- 10-sprocket hole-pitch cumulative tolerance ± 0.2
 - Camber not to exceed 1 mm in 100 mm, noncumulative over 250 mm
 - Material: black static-dissipative polystyrene
 - All dimensions are in mm, unless otherwise specified.
 - Thickness: 0.30 ± 0.05 mm
 - MSL1 260°C (IR and convection) PbF reflow compatible

TAPE AND REEL INFORMATION

QUADRANT ASSIGNMENTS FOR PIN 1 ORIENTATION IN TAPE

*All dimensions are nominal

Device	Package Type	Package Drawing	Pins	SPQ	Reel Diameter (mm)	Reel Width W1 (mm)	A0 (mm)	B0 (mm)	K0 (mm)	P1 (mm)	W (mm)	Pin1 Quadrant
CSD86330Q3D	LSON-CLIP	DQZ	8	2500	330.0	12.4	3.55	3.55	1.7	8.0	12.0	Q1

TAPE AND REEL BOX DIMENSIONS

*All dimensions are nominal

Device	Package Type	Package Drawing	Pins	SPQ	Length (mm)	Width (mm)	Height (mm)
CSD86330Q3D	LSON-CLIP	DQZ	8	2500	346.0	346.0	33.0

IMPORTANT NOTICE AND DISCLAIMER

TI PROVIDES TECHNICAL AND RELIABILITY DATA (INCLUDING DATA SHEETS), DESIGN RESOURCES (INCLUDING REFERENCE DESIGNS), APPLICATION OR OTHER DESIGN ADVICE, WEB TOOLS, SAFETY INFORMATION, AND OTHER RESOURCES "AS IS" AND WITH ALL FAULTS, AND DISCLAIMS ALL WARRANTIES, EXPRESS AND IMPLIED, INCLUDING WITHOUT LIMITATION ANY IMPLIED WARRANTIES OF MERCHANTABILITY, FITNESS FOR A PARTICULAR PURPOSE OR NON-INFRINGEMENT OF THIRD PARTY INTELLECTUAL PROPERTY RIGHTS.

These resources are intended for skilled developers designing with TI products. You are solely responsible for (1) selecting the appropriate TI products for your application, (2) designing, validating and testing your application, and (3) ensuring your application meets applicable standards, and any other safety, security, regulatory or other requirements.

These resources are subject to change without notice. TI grants you permission to use these resources only for development of an application that uses the TI products described in the resource. Other reproduction and display of these resources is prohibited. No license is granted to any other TI intellectual property right or to any third party intellectual property right. TI disclaims responsibility for, and you will fully indemnify TI and its representatives against, any claims, damages, costs, losses, and liabilities arising out of your use of these resources.

TI's products are provided subject to [TI's Terms of Sale](#) or other applicable terms available either on [ti.com](https://www.ti.com) or provided in conjunction with such TI products. TI's provision of these resources does not expand or otherwise alter TI's applicable warranties or warranty disclaimers for TI products.

TI objects to and rejects any additional or different terms you may have proposed.

Mailing Address: Texas Instruments, Post Office Box 655303, Dallas, Texas 75265
Copyright © 2023, Texas Instruments Incorporated