

LM3519 High Frequency Boost White LED Driver with High-Speed PWM Brightness Control

Check for Samples: [LM3519](#)

FEATURES

- Drives 2 to 4 LEDs at 20mA
- Up to 30kHz PWM Dimming Control Capability
- >80% Peak Efficiency
- Up to 8MHz Switching Frequency
- Small External Components: 1 μ H - 3.3 μ H(typ.2.2 μ H) Inductor and 1 μ F Output Capacitor
- True Shutdown Isolation
- Over-Voltage Protection
- Wide Input Voltage Range: 2.7V to 5.5V
- Small Footprint SOT-23 Package

APPLICATIONS

- LCD, White LED Backlighting on Mobile Phones
- Digital Still Cameras and PDAs
- General Purpose LED Lighting in Handheld Devices

Typical Application

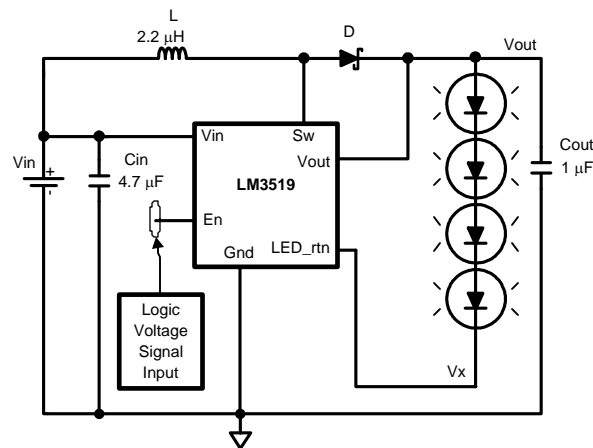
Figure 1. Typical Application Circuit

DESCRIPTION

The LM3519 drives up to 4 white LEDs with constant current to provide LCD backlighting in handheld devices. The LED current is internally set to 20mA. The series connection allows the LED current to be identical for uniform brightness and minimizes the number of traces to the LEDs. Brightness control is achieved by applying a PWM signal on enable with frequencies up to 30kHz.

The LM3519 features a proprietary PFM regulation architecture with switching frequencies between 2MHz to 8MHz, minimizing inductor size.

Over-voltage protection circuitry and high frequency operation permit the use of low-cost small output capacitors. During shutdown, the output is disconnected from the input in order to avoid leakage current path through the LEDs to ground.

The LM3519 is available in a tiny 6-pin SOT-23 package.



Please be aware that an important notice concerning availability, standard warranty, and use in critical applications of Texas Instruments semiconductor products and disclaimers thereto appears at the end of this data sheet.

All trademarks are the property of their respective owners.

Connection Diagram

6-Lead SOT-23 Package

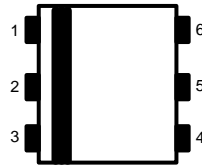

Top View

PIN DESCRIPTIONS

Pin #	Name	Description
1	En	Device Enable Connection
2	Gnd	Ground Connection
3	V _{OUT}	Output Voltage Connection
4	LED_rtn	White LED Current Sensing Input Connection
5	S _W	Drain Connection of the Internal Power Field Effect Transistor (FET) Switch
6	V _{IN}	Input or Supply Voltage Connection



These devices have limited built-in ESD protection. The leads should be shorted together or the device placed in conductive foam during storage or handling to prevent electrostatic damage to the MOS gates.

Absolute Maximum Ratings⁽¹⁾

V _{IN} , En, & LED_rtn Pin	-0.3V to +6.5V
V _{OUT} , Sw Pin	-0.3V to +21V
Maximum Junction Temperature, (T _{J-MAX})	+150°C
Storage Temperature Range	-65°C to +150°C
ESD Rating ⁽²⁾	
Human Body Model:	2kV
Machine Model:	200V

- (1) [Absolute maximum ratings](#) indicate limits beyond which damage to the device may occur. [Operating Ratings](#) are conditions under which operation of the device is ensured. Operating Ratings do not imply ensured limits. For ensured performance limits and associated test conditions, see the [Electrical Characteristics](#) table.
- (2) The human body model is a 100pF capacitor discharged through a 1.5kΩ resistor into each pin. The machine model is a 200pF capacitor discharged directly into each pin.

Operating Ratings⁽¹⁾

Junction Temperature (T _J) Range	-40°C to +125°C
Ambient Temperature (T _A) Range	-40°C to +85°C
Input Voltage Range	2.7V to 5.5V

- (1) [Absolute maximum ratings](#) indicate limits beyond which damage to the device may occur. [Operating Ratings](#) are conditions under which operation of the device is ensured. Operating Ratings do not imply ensured limits. For ensured performance limits and associated test conditions, see the [Electrical Characteristics](#) table.

Thermal Properties⁽¹⁾

Junction-to-Ambient Thermal Resistance (θ _{JA})	220°C/W
-----------------------------------------------------------	---------

- (1) The maximum allowable power dissipation is a function of the maximum junction temperature, T_{J(MAX)}, the junction-to-ambient thermal resistance, θ_{JA}, and the ambient temperature, T_A. See [Thermal Properties](#) for the thermal resistance. The maximum allowable power dissipation at any ambient temperature is calculated using: P_{D(MAX)} = (T_{J(MAX)} - T_A)/θ_{JA}. Exceeding the maximum allowable power dissipation will cause excessive die temperature.

Electrical Characteristics ⁽¹⁾⁽²⁾

Limits in standard typeface are for $T_J = +25^\circ\text{C}$. Limits in **bold typeface** apply over the full operating junction temperature range ($-40^\circ\text{C} \leq T_J \leq +125^\circ\text{C}$). $V_{IN} = 3.6\text{V}$, unless otherwise stated.

Symbol	Parameter	Conditions	Min	Typ	Max	Units
I_Q	Supply Current	Shutdown: $V_{EN} = 0\text{V}$		0.1		μA
		Not Switching: $V_{EN} = 1.8\text{V}$		360	500	
		Switching: $V_{EN} = 1.8\text{V}$, LED_rtn current = 30mA		550	900	
$I_{LED(TOL)}$	LED Current Tolerance/Variation	$V_{IN} = 3.6\text{V}$, 2.2 μH , 4LEDs	-10	5.5	10	%
OVP	Over-Voltage Protection Threshold	OVP ON OVP OFF	18 17.8	18.9 18.6	20 19.8	V
I_{LIM}	Switch Current Limit	$L = 2.2\mu\text{H}$		750		mA
$R_{DS(ON)}$	Power NMOS Switch ON Resistance			455		m Ω
$I_{LEAKAGE}$	Switch Leakage	$V_{SW} = 3.6\text{V}$, $V_{EN} = 0\text{V}$		0.1	2	μA
$R_{LED_rtn(ON)}$	LED_rtn NMOS Switch ON Resistance			8.0		Ω
F_S	Switching Frequency	$I_{LED} = 20\text{ mA}$, $L = 1\mu\text{H}$ 4LEDs		5.4		MHz
I_{EN}	Enable Pin Bias Current ⁽³⁾	$V_{EN} = 0\text{V}$ $V_{EN} = 1.8\text{V}$		0.1 1.1	2	μA
En	Enable Threshold	Device On Device Off	0.9		0.3	V

- (1) [Absolute maximum ratings](#) indicate limits beyond which damage to the device may occur. [Operating Ratings](#) are conditions under which operation of the device is ensured. Operating Ratings do not imply ensured limits. For ensured performance limits and associated test conditions, see the [Electrical Characteristics](#) table.
- (2) Min and max limits are ensured by design, test, or statistical analysis. Typical numbers are not ensured, but do represent the most likely norm.
- (3) Current flows into the pin.

BLOCK DIAGRAM

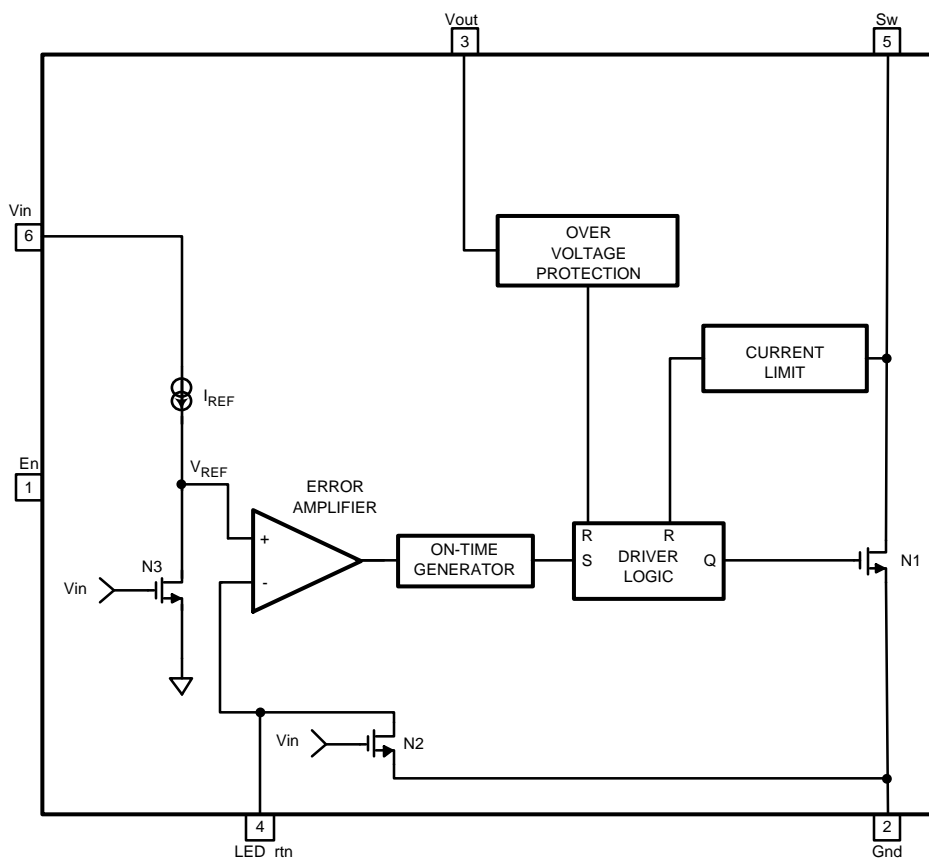

Figure 2. Block Diagram

Circuit Description

The LM3519 is a step-up converter for white LED applications that uses a unique and proprietary pulse frequency modulation (PFM) architecture to optimize high efficiency at high frequency operation. Unlike most PFM architecture implementations, the LM3519's unique architectural implementation results in non-pulse skipping variable frequency operation. The regulator is forced to operate at the edge of Continuous Conduction Mode (CCM). The error amplifier will set the end of the on-time (I_{PEAK} of inductor) based on the load (LEDs) current. During this operation, the inductor current ramps up and reaches a peak current at end of the on-time. At this point, the internal power switch is turned off until the inductor current reaches zero, and the cycle repeats again. The switching frequency is set based on the charge (on-time) and discharge(off-time) of the inductor current. The frequency can range between 2MHz to 8MHz over the operating input range.

The LM3519 operation can be best understood through an examination of the block diagram in [Figure 2](#). When LED current is out of regulation, the LED_rtn voltage falls below or rises above the internal reference voltage (V_{REF}). The error amplifier will output a signal to increase or decrease the proper on-time duration of N1 power FET. This correction allows the inductor's stored energy to increase or decrease to a sufficient level that when transferred to the load will bring the LED_rtn current back into regulation.

During steady-state operation for a typical switching cycle, the oscillator sets the driver logic and turns on N1 power device. N1 conducts current through the inductor and reverse biases the external diode. The LED current is supplied by the output capacitor when N1 is conducting. Once N1 on-time period is concluded, the internal power device is turned off and the external diode is forward biased. The inductor current then flows through the diode to the LED load to replenish the output capacitor and keep the LED current regulated at the trimmed target.

Typical Performance Characteristics

(See Figure 1: $V_{IN} = 3.6V$, $C_{IN} = 4.7\mu F$ and $C_{OUT} = 1\mu F$, $L = 2.2\mu H$ and 4 LEDs. $T_A = +25^\circ C$, unless otherwise stated.)

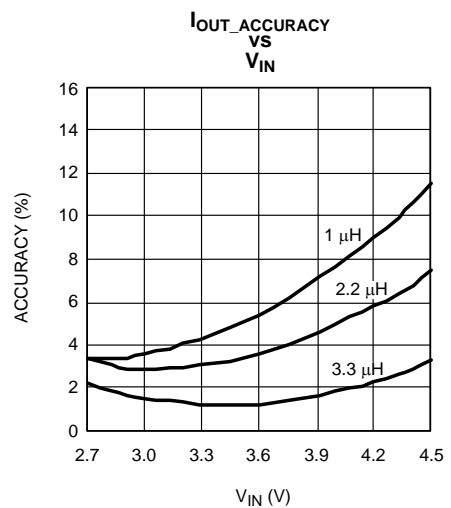
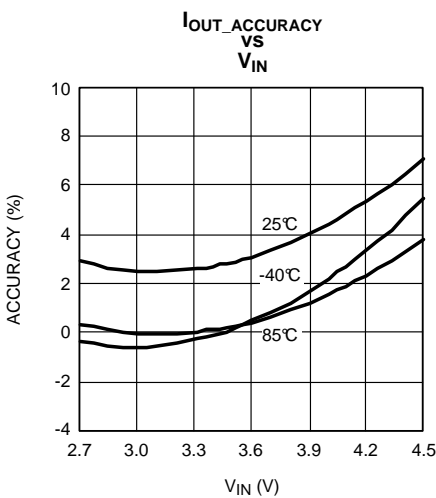
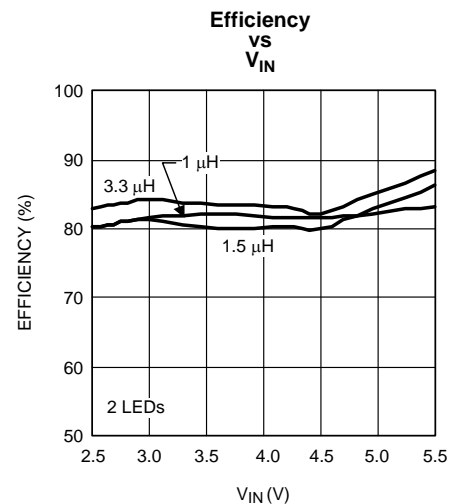
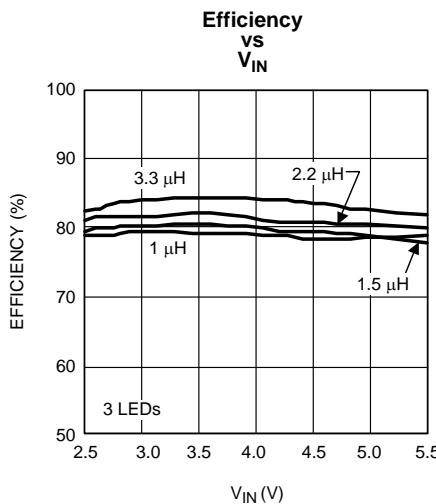
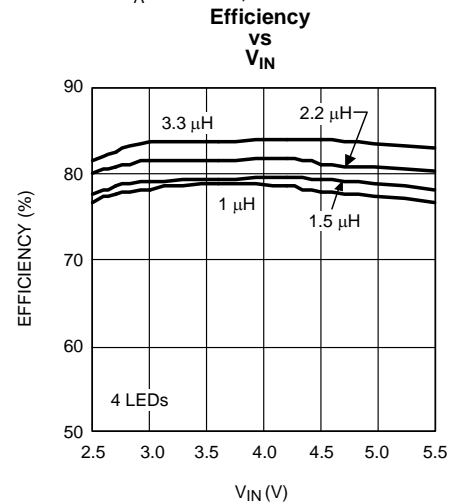
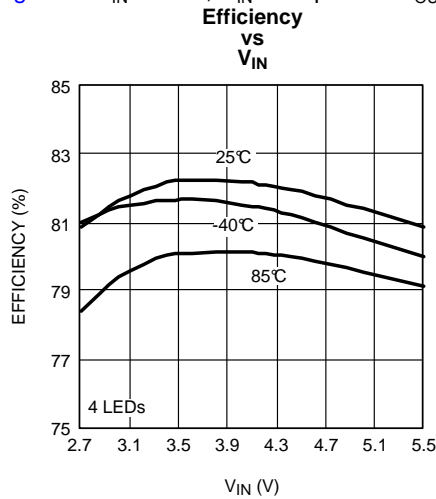

Typical Performance Characteristics (continued)

(See Figure 1: $V_{IN} = 3.6V$, $C_{IN} = 4.7\mu F$ and $C_{OUT} = 1\mu F$, $L = 2.2\mu H$ and 4 LEDs. $T_A = +25^\circ C$, unless otherwise stated.)

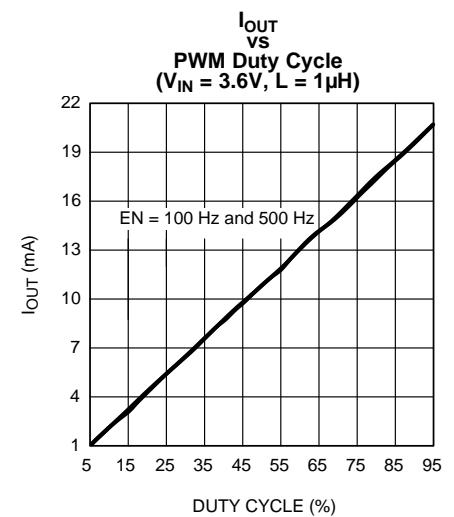
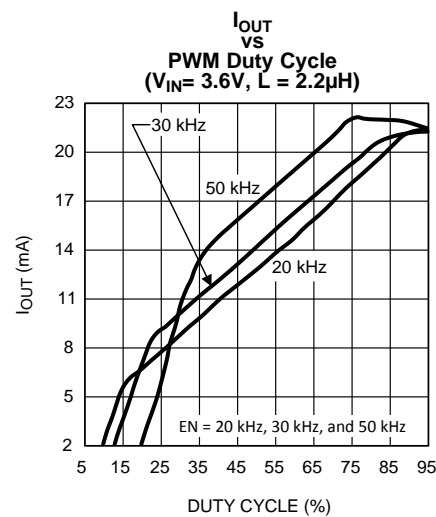
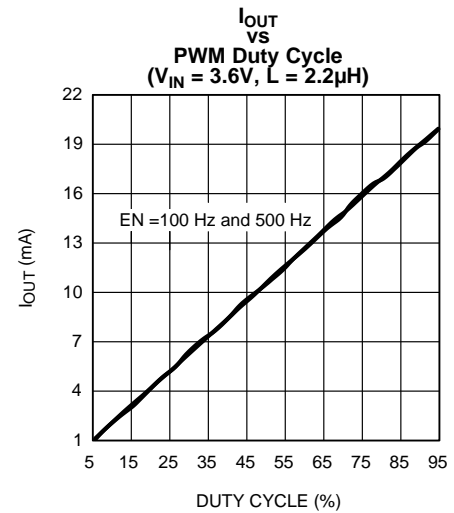
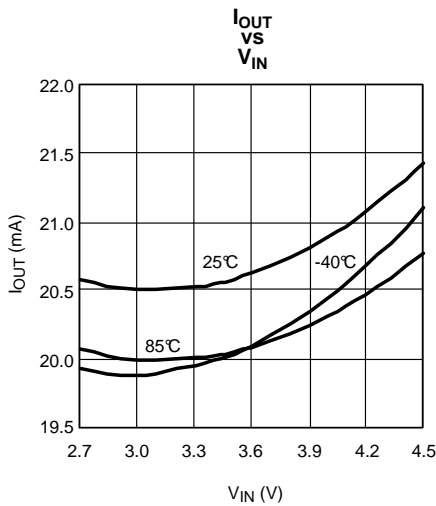
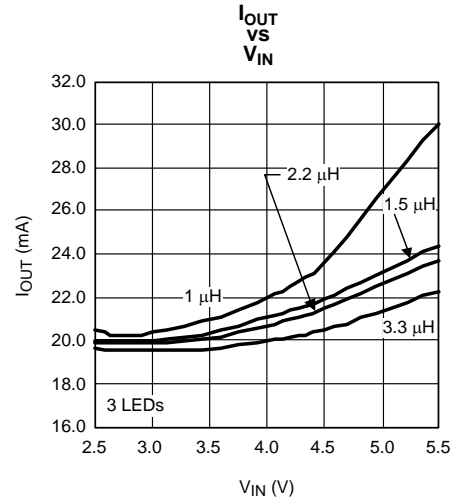
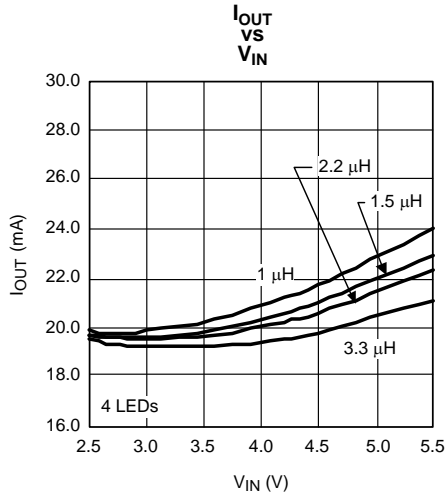

Typical Performance Characteristics (continued)

(See Figure 1: $V_{IN} = 3.6V$, $C_{IN} = 4.7\mu F$ and $C_{OUT} = 1\mu F$, $L = 2.2\mu H$ and 4 LEDs. $T_A = +25^\circ C$, unless otherwise stated.)

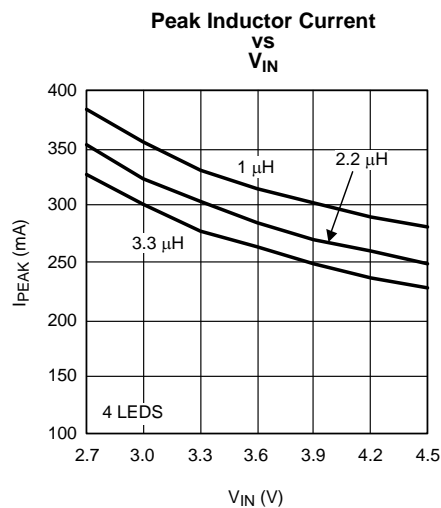
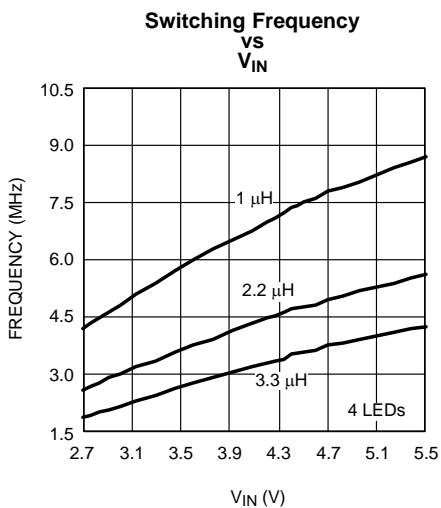
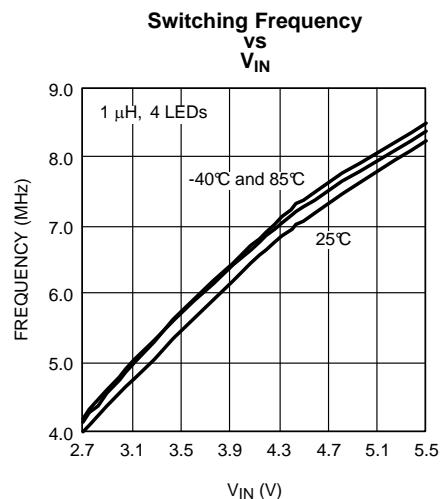
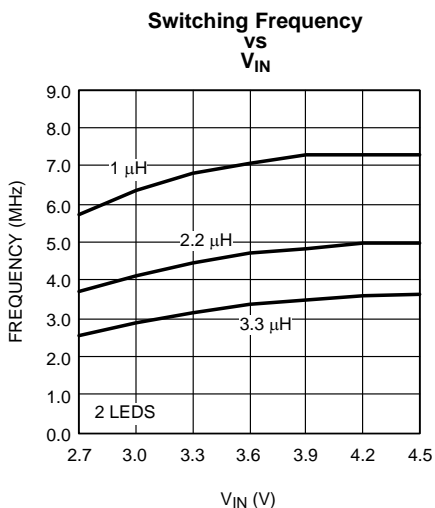
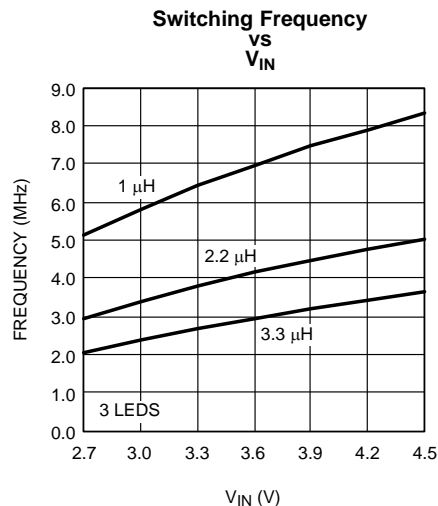
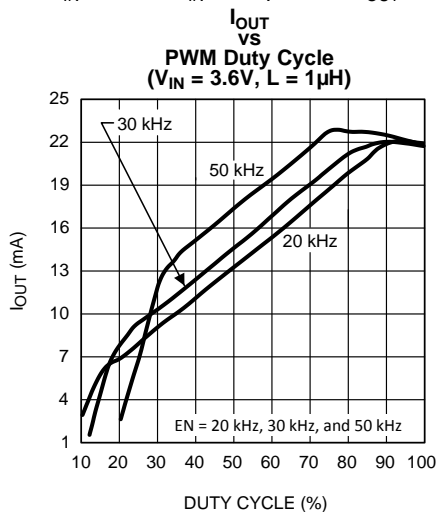

Typical Performance Characteristics (continued)

(See Figure 1: $V_{IN} = 3.6V$, $C_{IN} = 4.7\mu F$ and $C_{OUT} = 1\mu F$, $L = 2.2\mu H$ and 4 LEDs. $T_A = +25^\circ C$, unless otherwise stated.)

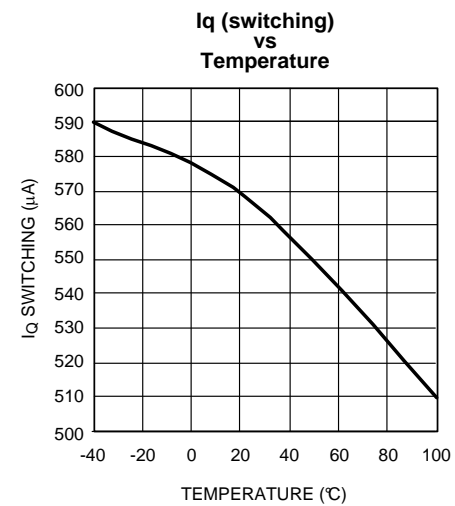
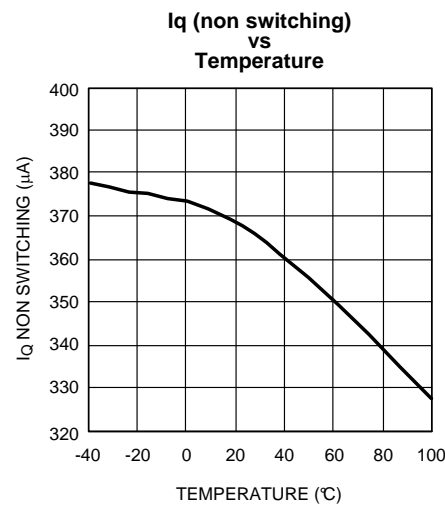
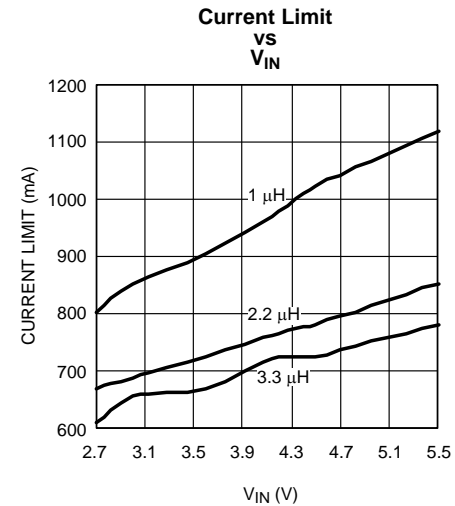
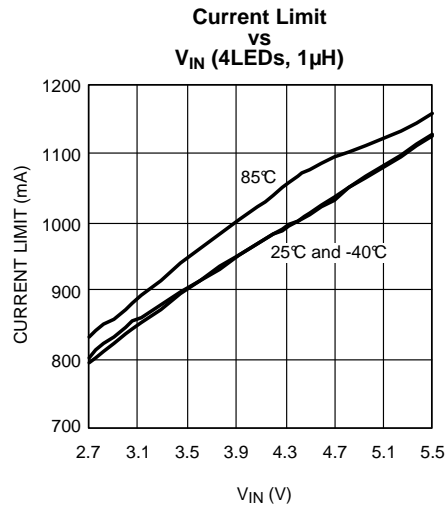
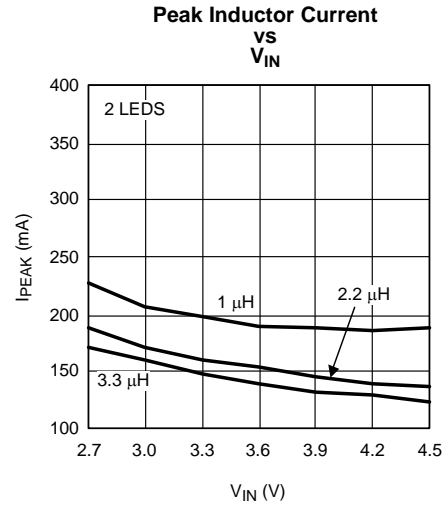
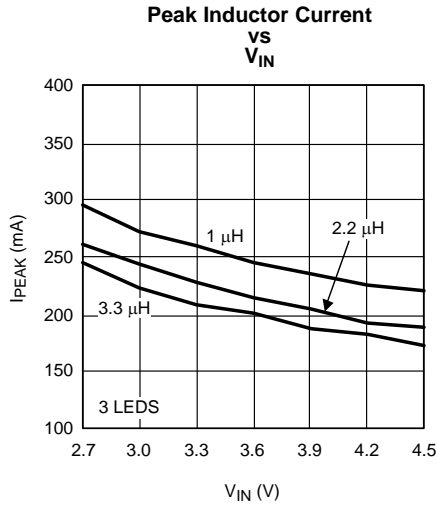

Typical Performance Characteristics (continued)

(See Figure 1: $V_{IN} = 3.6V$, $C_{IN} = 4.7\mu F$ and $C_{OUT} = 1\mu F$, $L = 2.2\mu H$ and 4 LEDs. $T_A = +25^\circ C$, unless otherwise stated.)

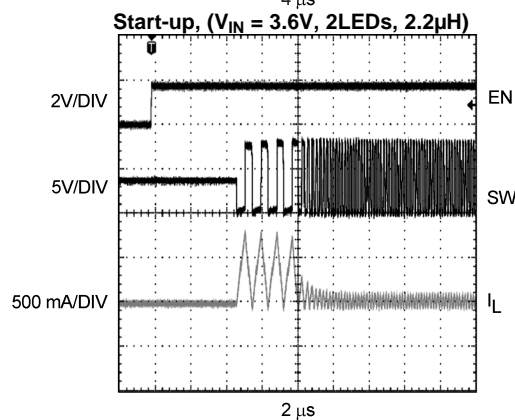
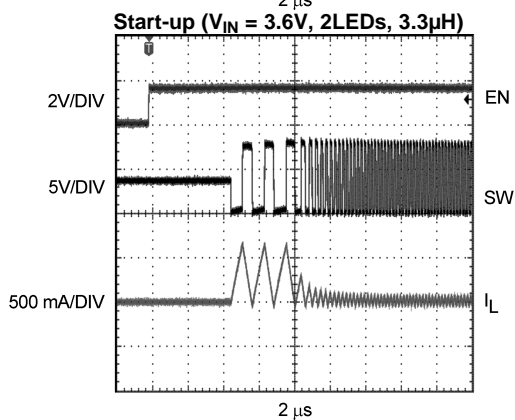
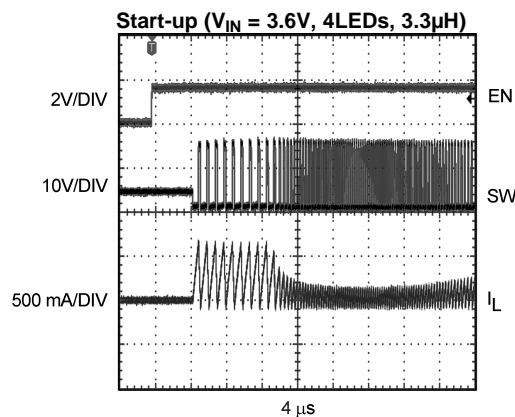
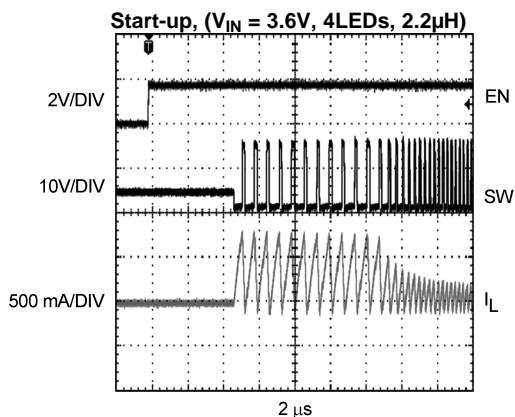
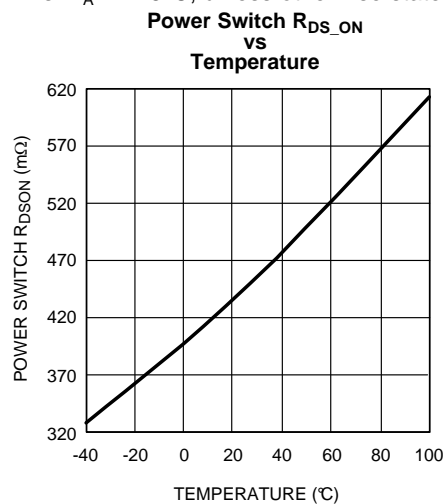
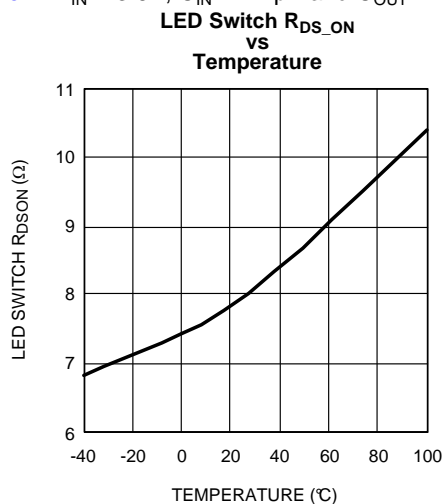

Typical Performance Characteristics (continued)

(See Figure 1: $V_{IN} = 3.6V$, $C_{IN} = 4.7\mu F$ and $C_{OUT} = 1\mu F$, $L = 2.2\mu H$ and 4 LEDs. $T_A = +25^\circ C$, unless otherwise stated.)

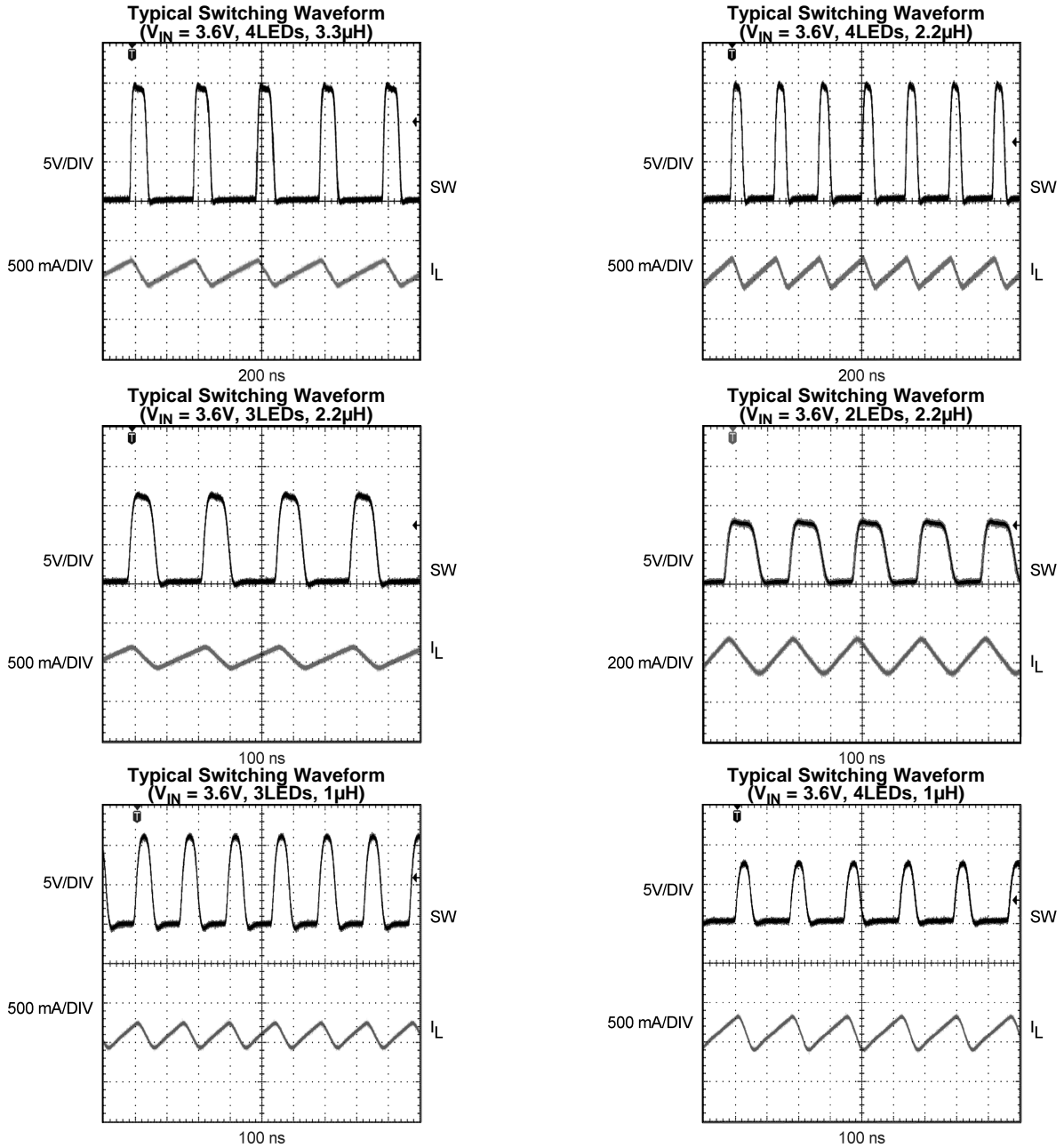

APPLICATION INFORMATION

Capacitor Selection

To minimize output and input voltage ripple, low equivalent series resistance (ESR) ceramic capacitors are the best choice to use for the input and output filters. For most display applications, a 4.7 μ F capacitor is recommended for C_{IN} and 1 μ F for C_{OUT} .

Larger output capacitors can be used to reduce ripple voltage. To ensure good performance, a minimum of 0.47 μ F C_{OUT} is required to trade off for large ripple voltage. Care must be taken to account for the true capacitance of a multilayer ceramic capacitor. Smaller case size capacitors typically have less capacitance for a given bias voltage as compared to a larger case size capacitor with the same bias voltage. Please confirm with capacitor manufacturer data before selecting the capacitor.

Recommended capacitor manufacturers include but are not limited to:

Table 1.

Manufacturer	Description	Case Size
AVX	06033D105MAT-25V	0603
	06036D475MAT-6.3V	0603
TDK	C2012X5R1A475M-10V	0805
Taiyo Yuden	TMK212BJ105KG-J	0805
	EM212BJ475MG-16V	0805
muRata	GRM40-034B105K25	0805
	GRM39X5R475K6.3	0603

Inductor Selection

In order to maintain sufficient inductance, the saturation current rating of the inductor used with the LM3519 should be higher than the peak inductor current in the target application. Inductors with low DCR values have less power loss and higher efficiency. Larger inductor values such as 2.2 μ H and 3.3 μ H can be used to optimize efficiency, frequency and peak current. If 1 μ H is used, the peak inductor current, frequency will be higher and the efficiency will be lower. Note that the switching frequency ranges will be higher at lower inductance. Typical frequency range is between 4 to 8MHz for 1 μ H, 2 to 5MHz for 2.2 μ H and 2 to 4MHz for 3.3 μ H over the input range. Below is a sample list of low profile inductors.

Some recommended inductor manufacturers include but are not limited to:

Manufacturer	L	Case Size	I _{SAT}
CoilCraft: DO3314-102	1 μ H	3.3x3.3x1.4mm	2.1A
	2.2 μ H		1.6A
	3.3 μ H		1.4A
Coilcraft: LPO3310-102ML	1 μ H	3.3x3.3x1.0 mm	1.6A
	2.2 μ H		1.1A
	3.3 μ H		0.95A
Cooper: SD31121R0	1 μ H	3.1x3.1x1.4 mm	2.07A
	2.2 μ H		1.48A
	3.3 μ H		1.15A
Taiyo Yuden: NR3015T1R0N	1 μ H	3.0x3.0x1.5 mm	2.1A
	2.2 μ H		1.48A
	3.3 μ H		1.21A

Diode Selection

Diodes with low forward voltage ratings (V_F) and low junction capacitance magnitudes (C_J or C_T or C_D) are conducive to high efficiency. The chosen diode must have a reverse breakdown voltage rating (V_R and/or V_{RRM}) that is larger than the output voltage. The following criteria should be followed when choosing a diode:

1. V_R (Diode Blocking Voltage Range) and V_{RRM} (Diode Peak Repetitive Reverse Voltage Rating) $> V_{OUT}$ (Output Voltage)
2. I_F or I_O (Diode Average Forward Current Rating) $\geq I_{LOAD}$ (Load Current)
3. I_{FRM} (Diode Peak Repetitive Forward Current Rating) $\geq I_{Lpeak}$ (Peak Inductor Current)

Some recommended diode manufacturers include but are not limited to:

Manufacturer	Description
Vishay	SS12(1A/20V)
	SS14(1A/40V)
	SS16(1A/60V)
Central Semiconductor	CMSH1- 40M(1A/40V)
ONSem	MBRS1540T3(1.5A/40V)

PWM DIMMING

The LED current is set internally by the LM3519 to 20mA (typical); dimming control may be realized by applying a pulse width modulated (PWM) signal to the En pin. For example, a 50% duty cycle waveform will produce an average current of 10mA. A control signal frequency between 17kHz and 30kHz is suitable for dimming.

Although the LM3519 is capable of operation outside this frequency range, it is not recommended to operate below 17kHz for the following reasons: 1) frequency below 100Hz is likely to cause visible flicker in the light emitted by the LED string, 2) frequency below 17kHz may induce audible noise due to combinations of some capacitance/PCB. A PWM frequency above 30kHz is possible but the current linearity vs duty cycle will be affected.

If it is not possible to operate the dimming control above 17kHz, audible noise emission may be minimized by using capacitors with low susceptibility to piezoelectric induced stresses, such as poly film designs. Minimum audible noise is most likely to occur when the PWM frequency is less than 2kHz. It is recommended that any application using a PWM control signal below 17kHz be thoroughly evaluated for undesirable audible or visible noise.

DRIVING 2 LEDs

The LM3519 is optimized to drive up to 4LEDs. When driving 2LEDs, a minimum inductance of 2.2 μ H is required to maintain good loop regulation and current accuracy. If a smaller inductor is used, the LED current will have more variation with input voltage than a typical application. The following curve illustrates the behavior.

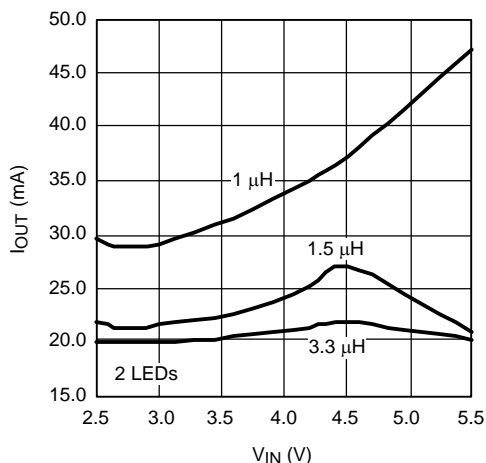

Figure 3. I_{OUT} vs V_{IN}

LAYOUT GUIDELINES

The input capacitor, C_{IN}, must be placed close to the LM3519. Placing C_{IN} close to the device will reduce the metal trace resistance effect on input voltage ripple. Metal trace connections for the C_{OUT} capacitor can increase the effective series resistance, which affects output voltage ripple and efficiency. Trace connections to the inductor should be short and wide to reduce power dissipation, increase overall efficiency and reduce EMI radiation. The diode, like the inductor, should have trace connections that are short and wide to reduce power dissipation and increase overall efficiency. For more details regarding layout guidelines for switching regulators, refer to Application Note AN1149 [SNVA021](#).

REVISION HISTORY

Changes from Revision A (May 2013) to Revision B	Page
• Changed layout of National Data Sheet to TI format	13

PACKAGING INFORMATION

Orderable part number	Status (1)	Material type (2)	Package Pins	Package qty Carrier	RoHS (3)	Lead finish/ Ball material (4)	MSL rating/ Peak reflow (5)	Op temp (°C)	Part marking (6)
LM3519MK-20/NOPB	NRND	Production	SOT-23-THIN (DDC) 6	1000 LARGE T&R	Yes	SN	Level-1-260C-UNLIM	-40 to 85	D52B
LM3519MK-20/NOPB.B	NRND	Production	SOT-23-THIN (DDC) 6	1000 LARGE T&R	Yes	SN	Level-1-260C-UNLIM	-40 to 85	D52B

(1) **Status:** For more details on status, see our [product life cycle](#).

(2) **Material type:** When designated, preproduction parts are prototypes/experimental devices, and are not yet approved or released for full production. Testing and final process, including without limitation quality assurance, reliability performance testing, and/or process qualification, may not yet be complete, and this item is subject to further changes or possible discontinuation. If available for ordering, purchases will be subject to an additional waiver at checkout, and are intended for early internal evaluation purposes only. These items are sold without warranties of any kind.

(3) **RoHS values:** Yes, No, RoHS Exempt. See the [TI RoHS Statement](#) for additional information and value definition.

(4) **Lead finish/Ball material:** Parts may have multiple material finish options. Finish options are separated by a vertical ruled line. Lead finish/Ball material values may wrap to two lines if the finish value exceeds the maximum column width.

(5) **MSL rating/Peak reflow:** The moisture sensitivity level ratings and peak solder (reflow) temperatures. In the event that a part has multiple moisture sensitivity ratings, only the lowest level per JEDEC standards is shown. Refer to the shipping label for the actual reflow temperature that will be used to mount the part to the printed circuit board.

(6) **Part marking:** There may be an additional marking, which relates to the logo, the lot trace code information, or the environmental category of the part.

Multiple part markings will be inside parentheses. Only one part marking contained in parentheses and separated by a "-" will appear on a part. If a line is indented then it is a continuation of the previous line and the two combined represent the entire part marking for that device.

Important Information and Disclaimer: The information provided on this page represents TI's knowledge and belief as of the date that it is provided. TI bases its knowledge and belief on information provided by third parties, and makes no representation or warranty as to the accuracy of such information. Efforts are underway to better integrate information from third parties. TI has taken and continues to take reasonable steps to provide representative and accurate information but may not have conducted destructive testing or chemical analysis on incoming materials and chemicals. TI and TI suppliers consider certain information to be proprietary, and thus CAS numbers and other limited information may not be available for release.

In no event shall TI's liability arising out of such information exceed the total purchase price of the TI part(s) at issue in this document sold by TI to Customer on an annual basis.

TAPE AND REEL INFORMATION

QUADRANT ASSIGNMENTS FOR PIN 1 ORIENTATION IN TAPE



*All dimensions are nominal

Device	Package Type	Package Drawing	Pins	SPQ	Reel Diameter (mm)	Reel Width W1 (mm)	A0 (mm)	B0 (mm)	K0 (mm)	P1 (mm)	W (mm)	Pin1 Quadrant
LM3519MK-20/NOPB	SOT-23-THIN	DDC	6	1000	178.0	8.4	3.2	3.2	1.4	4.0	8.0	Q3

TAPE AND REEL BOX DIMENSIONS

*All dimensions are nominal

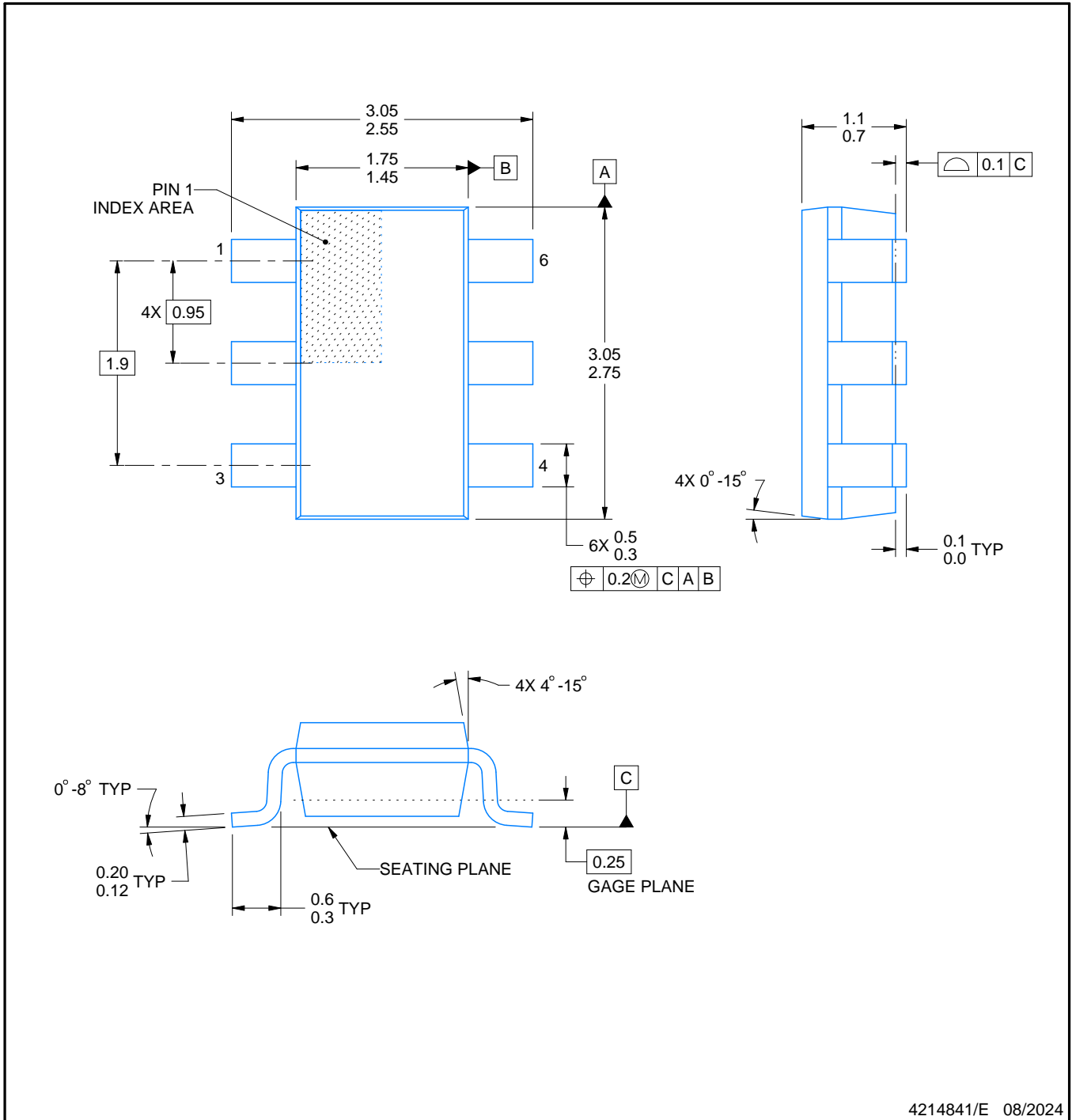
Device	Package Type	Package Drawing	Pins	SPQ	Length (mm)	Width (mm)	Height (mm)
LM3519MK-20/NOPB	SOT-23-THIN	DDC	6	1000	208.0	191.0	35.0



4214841/E 08/2024

NOTES:

1. All linear dimensions are in millimeters. Any dimensions in parenthesis are for reference only. Dimensioning and tolerancing per ASME Y14.5M.
2. This drawing is subject to change without notice.
3. Reference JEDEC MO-193.

EXAMPLE BOARD LAYOUT

DDC0006A

SOT-23 - 1.1 max height

SMALL OUTLINE TRANSISTOR

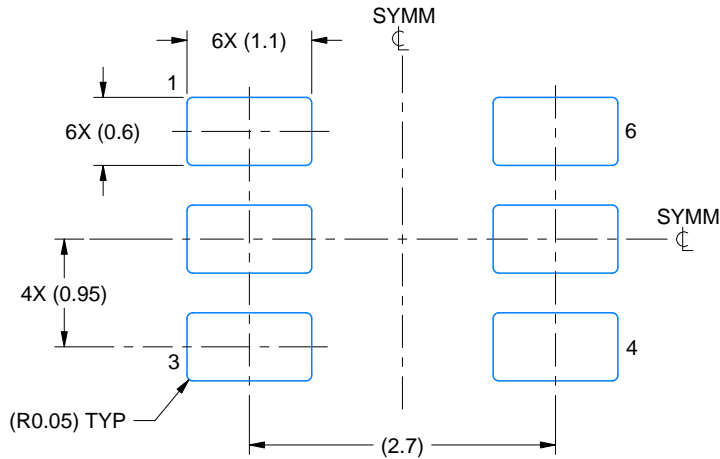

LAND PATTERN EXAMPLE
EXPLODED METAL SHOWN
SCALE:15X

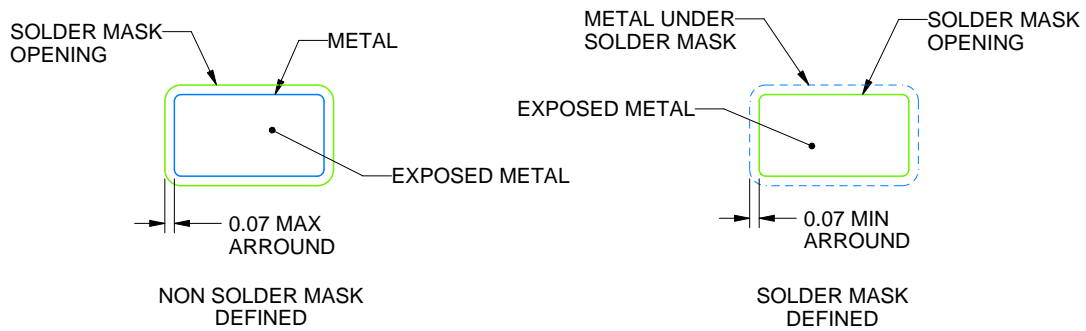

SOLDERMASK DETAILS

4214841/E 08/2024

NOTES: (continued)

- 4. Publication IPC-7351 may have alternate designs.
- 5. Solder mask tolerances between and around signal pads can vary based on board fabrication site.

EXAMPLE STENCIL DESIGN

DDC0006A

SOT-23 - 1.1 max height

SMALL OUTLINE TRANSISTOR

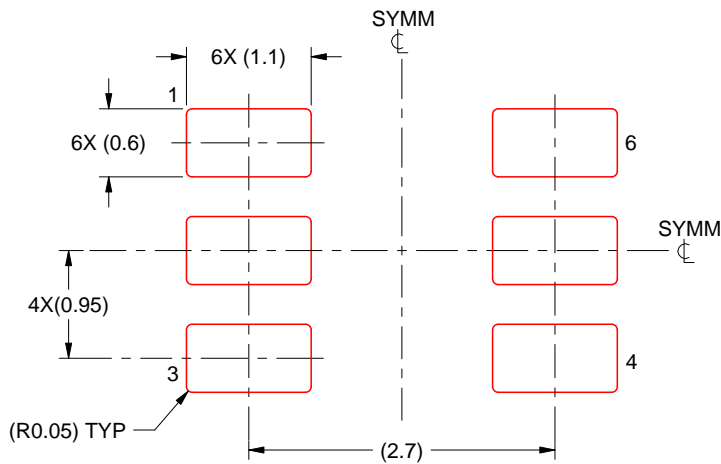

SOLDER PASTE EXAMPLE
BASED ON 0.125 THICK STENCIL
SCALE:15X

4214841/E 08/2024

NOTES: (continued)

6. Laser cutting apertures with trapezoidal walls and rounded corners may offer better paste release. IPC-7525 may have alternate design recommendations.
7. Board assembly site may have different recommendations for stencil design.

IMPORTANT NOTICE AND DISCLAIMER

TI PROVIDES TECHNICAL AND RELIABILITY DATA (INCLUDING DATASHEETS), DESIGN RESOURCES (INCLUDING REFERENCE DESIGNS), APPLICATION OR OTHER DESIGN ADVICE, WEB TOOLS, SAFETY INFORMATION, AND OTHER RESOURCES "AS IS" AND WITH ALL FAULTS, AND DISCLAIMS ALL WARRANTIES, EXPRESS AND IMPLIED, INCLUDING WITHOUT LIMITATION ANY IMPLIED WARRANTIES OF MERCHANTABILITY, FITNESS FOR A PARTICULAR PURPOSE OR NON-INFRINGEMENT OF THIRD PARTY INTELLECTUAL PROPERTY RIGHTS.

These resources are intended for skilled developers designing with TI products. You are solely responsible for (1) selecting the appropriate TI products for your application, (2) designing, validating and testing your application, and (3) ensuring your application meets applicable standards, and any other safety, security, regulatory or other requirements.

These resources are subject to change without notice. TI grants you permission to use these resources only for development of an application that uses the TI products described in the resource. Other reproduction and display of these resources is prohibited. No license is granted to any other TI intellectual property right or to any third party intellectual property right. TI disclaims responsibility for, and you fully indemnify TI and its representatives against any claims, damages, costs, losses, and liabilities arising out of your use of these resources.

TI's products are provided subject to [TI's Terms of Sale](#), [TI's General Quality Guidelines](#), or other applicable terms available either on ti.com or provided in conjunction with such TI products. TI's provision of these resources does not expand or otherwise alter TI's applicable warranties or warranty disclaimers for TI products. Unless TI explicitly designates a product as custom or customer-specified, TI products are standard, catalog, general purpose devices.

TI objects to and rejects any additional or different terms you may propose.

Copyright © 2026, Texas Instruments Incorporated

Last updated 10/2025