

LMV34x-N シングル、レール・ツー・レール出力、CMOS動作アンプ、シャットダウン機能付き

1 特長

- (特記のない限り電源電圧2.7V時の標準値)
- 2.7Vおよび5Vの定格
- 10kHzにおける入力換算電圧ノイズ:
 $29\text{nV}/\sqrt{\text{Hz}}$
- 消費電流(アンプごとに): 100 μA
- ゲイン帯域幅積: 1MHz
- スルーレート: 1V/ μs
- シャットダウン電流(LMV341-N): 45pA
- シャットダウンからのターンオン時間(LMV341-N): 5 μs
- 入力バイアス電流: 20fA

2 アプリケーション

- コードレスまたは携帯電話
- ノート PC
- 携帯情報端末
- PCMCIAまたはオーディオ
- 携帯用またはバッテリー駆動の電子機器
- 消費電流の監視
- バッテリ監視
- バッファ
- フィルタ
- ドライバ

サンプル/ホールド回路

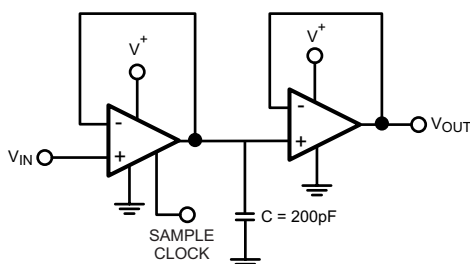

Copyright © 2016, Texas Instruments Incorporated

3 概要

LMV34x-N デバイスは、シングル/デュアル/クワッドの低電圧、低消費電力のオペアンプです。低電圧のポータブルアプリケーションに特化して設計されています。この製品には、低い入力バイアス電流、レール・ツー・レール出力、広い温度範囲など重要な特長があります。

特許を取得したクラスABターンアラウンド段により、消費電力とオフセット電圧、および高い周波数でのノイズが大幅に低減されています。PMOS入力段により、20fA (標準値) という非常に低い入力バイアス電流と、高い入力インピーダンスを実現しています。

LMV34x-N は拡張工業用温度範囲である -40°C ~ 125°C で動作するため、広範な拡張環境アプリケーションに対応できます。LMV341-N は、サイズ、動作速度、省電力の点で、テキサス・インスツルメンツのSilicon Dustアンプのポートフォリオを拡張する製品です。LMV34x-N デバイスは、2.7V~5.5Vの電圧範囲で動作する定格で、すべての製品がレール・ツー・レール出力を備えています。

LMV341-Nにはシャットダウン・ピンがあり、デバイスをディセーブルするために使用できます。シャットダウン・モードでは、消費電流が45pA (標準値) に低下します。

LMV34x-N デバイスは10kHzで電圧ノイズが29nV、GBWが1MHz、スルーレートが1V/ μs 、0.25 mVos、シャットダウン電流が0.1 μA です(LMV341-N)。

LMV341-Nは小型6ピンSC70パッケージで、LMV342-Nは省スペースの8ピンVSSOPおよびSOICパッケージで、LMV344-Nは14ピンTSSOPおよびSOICパッケージで供給されます。これらの小型パッケージのアンプは、PCB占有面積をできるだけ抑えたいアプリケーションに理想的なソリューションです。PCBの面積が限られているアプリケーションの例として、携帯電話やPDAなどの携帯用電子機器が挙げられます。

製品情報⁽¹⁾

型番	パッケージ	本体サイズ(公称)
LMV341-N	SC70 (6)	2.00mm×1.25mm
LMV342-N	VSSOP (8)	3.00mm×3.00mm
	SOIC (8)	4.90mm×3.91mm
LMV344-N	TSSOP (14)	5.00mm×4.40mm
	SOIC (14)	8.64mm×3.91mm

(1) 提供されているすべてのパッケージについては、巻末の注文情報を参照してください。

目次

1	特長	1	7.4	Device Functional Modes	16
2	アプリケーション	1	8	Application and Implementation	18
3	概要	1	8.1	Application Information	18
4	改訂履歴	2	8.2	Typical Application	18
5	Pin Configuration and Functions	3	9	Power Supply Recommendations	19
6	Specifications	5	10	Layout	20
6.1	Absolute Maximum Ratings	5	10.1	Layout Guidelines	20
6.2	ESD Ratings	5	10.2	Layout Example	20
6.3	Recommended Operating Conditions	5	11	デバイスおよびドキュメントのサポート	21
6.4	Thermal Information	5	11.1	デバイス・サポート	21
6.5	Electrical Characteristics – 2.7 V (DC)	6	11.2	ドキュメントのサポート	21
6.6	Electrical Characteristics – 2.7 V (AC)	7	11.3	関連リンク	21
6.7	Electrical Characteristics – 5 V (DC)	7	11.4	ドキュメントの更新通知を受け取る方法	21
6.8	Electrical Characteristics – 5 V (AC)	8	11.5	コミュニティ・リソース	21
6.9	Typical Characteristics	9	11.6	商標	21
7	Detailed Description	16	11.7	静電気放電に関する注意事項	21
7.1	Overview	16	11.8	Glossary	22
7.2	Functional Block Diagram	16	12	メカニカル、パッケージ、および注文情報	22
7.3	Feature Description	16			

4 改訂履歴

資料番号末尾の英字は改訂を表しています。その改訂履歴は英語版に準じています。

	Page
Revision G (March 2013) から Revision H に変更	
• 「ESD定格」の表、「機能概要」セクション、「デバイスの機能モード」セクション、「アプリケーションと実装」セクション、「電源に関する推奨事項」セクション、「レイアウト」セクション、「デバイスおよびドキュメントのサポート」セクション、「メカニカル、パッケージ、および注文情報」セクションを追加	1
• Changed <i>Thermal Information</i> table	5

	Page
Revision F (March 2012) から Revision G に変更	
• ナショナル・セミコンダクターのデータシートのレイアウトをTIフォーマットへ 変更	1

5 Pin Configuration and Functions

**DCK Package
6-Pin SC70
Top View**

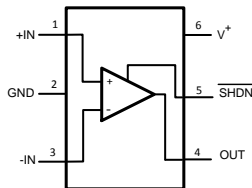

Pin Functions – LMV341-N

PIN		TYPE ⁽¹⁾	DESCRIPTION
NAME	NO.		
+IN	1	I	Noninverting input
-IN	3	I	Inverting input
GND	2	P	Negative supply input
OUT	4	O	Output
V ⁺	6	P	Positive supply input
SHDN	5	I	Active low enable input

(1) I = Input, O = Output, and P = Power

**DGK or D Package
8-Pin VSSOP or SOIC
Top View**

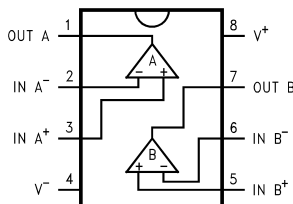

Pin Functions – LMV342-N

PIN		TYPE ⁽¹⁾	DESCRIPTION
NAME	NO.		
IN A ⁺	3	I	Noninverting input, channel A
IN A ⁻	2	I	Inverting input, channel A
IN B ⁺	5	I	Noninverting input, channel B
IN B ⁻	6	I	Inverting input, channel B
OUT A	1	O	Output, channel A
OUT B	7	O	Output, channel B
V ⁺	8	P	Positive (highest) power supply
V ⁻	4	P	Negative (lowest) power supply

(1) I = Input, O = Output, and P = Power

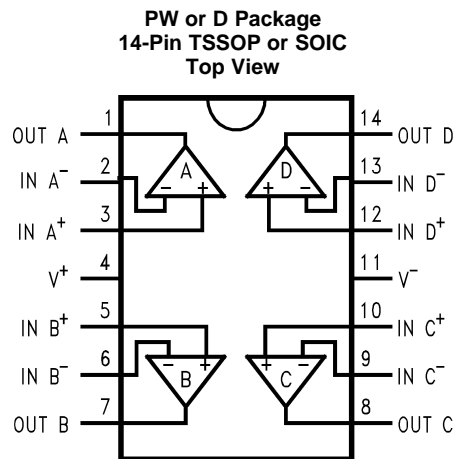
Pin Functions – LMV344-N

PIN		TYPE ⁽¹⁾	DESCRIPTION
NAME	NO.		
IN A ⁺	3	I	Noninverting input, channel A
IN A ⁻	2	I	Inverting input, channel A
IN B ⁺	5	I	Noninverting input, channel B
IN B ⁻	6	I	Inverting input, channel B
IN C ⁺	10	I	Noninverting input, channel C
IN C ⁻	9	I	Inverting input, channel C
IN D ⁺	12	I	Noninverting input, channel D
IN D ⁻	13	I	Inverting input, channel D
OUT A	1	O	Output, channel A
OUT B	7	O	Output, channel B
OUT C	8	O	Output, channel C
OUT D	14	O	Output, channel D
V ⁺	4	P	Positive (highest) power supply
V ⁻	11	P	Negative (lowest) power supply

(1) I = Input, O = Output, and P = Power

6 Specifications

6.1 Absolute Maximum Ratings

over operating free-air temperature range (unless otherwise noted)⁽¹⁾⁽²⁾

		MIN	MAX	UNIT
Differential input voltage		±Supply voltage		
Supply voltage ($V^+ - V^-$)		6		V
Output short circuit to V^+		See ⁽³⁾		
Output short circuit to V^-		See ⁽⁴⁾		
Lead temperature	Infrared or convection reflow (20 s)	235		°C
	Wave soldering (10 s)	260		
Junction temperature, T_J ⁽⁵⁾		150		°C
Storage temperature, T_{stg}		-65	150	°C

- Stresses beyond those listed under *Absolute Maximum Ratings* may cause permanent damage to the device. These are stress ratings only, which do not imply functional operation of the device at these or any other conditions beyond those indicated under *Recommended Operating Conditions*. Exposure to absolute-maximum-rated conditions for extended periods may affect device reliability.
- If Military/Aerospace specified devices are required, please contact the Texas Instruments Sales Office/Distributors for availability and specifications.
- Shorting output to V^+ will adversely affect reliability.
- Shorting output to V^- will adversely affect reliability.
- The maximum power dissipation is a function of $T_{J(MAX)}$, $R_{\theta JA}$. The maximum allowable power dissipation at any ambient temperature is $P_D = (T_{J(MAX)} - T_A) / R_{\theta JA}$. All numbers apply for packages soldered directly onto a PCB.

6.2 ESD Ratings

		VALUE	UNIT
$V_{(ESD)}$ Electrostatic discharge	Human-body model (HBM) ⁽¹⁾	±2000	V
	Machine model (MM) ⁽²⁾	±200	

- Human Body Model, applicable std. MIL-STD-883, Method 3015.7.
- Machine Model, applicable std. JESD22-A115-A (ESD MM std. of JEDEC) Field-Induced Charge-Device Model, applicable std. JESD22-C101-C (ESD FICDM std. of JEDEC).

6.3 Recommended Operating Conditions

over operating free-air temperature range (unless otherwise noted)

		MIN	MAX	UNIT
Supply voltage		2.7	5.5	V
Temperature		-40	125	°C

6.4 Thermal Information

THERMAL METRIC ⁽¹⁾		LMV341-N	LMV342-N		LMV344-N		UNIT
		DCK (SC70)	D (SOIC)	DGK (VSSOP)	D (SOIC)	PW (TSSOP)	
		6 PINS	8 PINS	8 PINS	14 PINS	14 PINS	
$R_{\theta JA}$	Junction-to-ambient thermal resistance	414	190	235	145	155	°C/W
$R_{\theta JC(top)}$	Junction-to-case (top) thermal resistance	116.1	65.2	68.4	45.9	50.5	°C/W
$R_{\theta JB}$	Junction-to-board thermal resistance	53.3	61.4	98.8	44.1	66.2	°C/W
Ψ_{JT}	Junction-to-top characterization parameter	8.8	16.1	9.8	10.2	6.3	°C/W
Ψ_{JB}	Junction-to-board characterization parameter	52.7	60.8	97.3	43.7	65.6	°C/W
$R_{\theta JC(bot)}$	Junction-to-case (bottom) thermal resistance	—	—	—	—	—	°C/W

- For more information about traditional and new thermal metrics, see the [Semiconductor and IC Package Thermal Metrics](#) application report.

6.5 Electrical Characteristics – 2.7 V (DC)

 $T_J = 25^\circ\text{C}$, $V^+ = 2.7\text{ V}$, $V^- = 0\text{ V}$, $V_{CM} = V^+/2$, $V_O = V^+/2$, and $R_L > 1\text{ M}\Omega$ (unless otherwise noted)⁽¹⁾

PARAMETER		TEST CONDITIONS		MIN ⁽²⁾	TYP ⁽³⁾	MAX ⁽²⁾	UNIT
V_{OS}	Input offset voltage	LMV341-N	$T_J = 25^\circ\text{C}$		0.25	4	mV
			$-40^\circ\text{C} \leq T_J \leq 125^\circ\text{C}$			4.5	
		LMV342-N and LMV344-N	$T_J = 25^\circ\text{C}$		0.55	5	
			$-40^\circ\text{C} \leq T_J \leq 125^\circ\text{C}$			5.5	
TCV_{OS}	Input offset voltage average drift			1.7		$\mu\text{V}/^\circ\text{C}$	
I_B	Input bias current	$T_J = 25^\circ\text{C}$			0.02	120	μA
		$-40^\circ\text{C} \leq T_J \leq 150^\circ\text{C}$				250	
I_{OS}	Input offset current				6.6		fA
I_S	Supply current	Per amplifier	$T_J = 25^\circ\text{C}$		100	170	μA
			$-40^\circ\text{C} \leq T_J \leq 125^\circ\text{C}$			230	
		Shutdown mode, $V_{SD} = 0\text{ V}$, LMV341-N	$T_J = 25^\circ\text{C}$		4.5×10^{-5}	1	
			$-40^\circ\text{C} \leq T_J \leq 125^\circ\text{C}$			1.5	
CMRR	Common-mode rejection ratio	$0\text{ V} \leq V_{CM} \leq 1.7\text{ V}$, $0\text{ V} \leq V_{CM} \leq 1.6\text{ V}$	$T_J = 25^\circ\text{C}$	56	80	dB	
			$-40^\circ\text{C} \leq T_J \leq 125^\circ\text{C}$	50			
PSRR	Power supply rejection ratio	$2.7\text{ V} \leq V^+ \leq 5\text{ V}$	$T_J = 25^\circ\text{C}$	65	82	dB	
			$-40^\circ\text{C} \leq T_J \leq 125^\circ\text{C}$	60			
V_{CM}	Input common-mode voltage	For CMRR $\geq 50\text{ dB}$	V+		1.9	1.7	V
			V-		0	-0.2	
A_V	Large signal voltage gain	$R_L = 10\text{ k}\Omega$ to 1.35 V	$T_J = 25^\circ\text{C}$	78	113	dB	
			$-40^\circ\text{C} \leq T_J \leq 125^\circ\text{C}$	70			
		$R_L = 2\text{ k}\Omega$ to 1.35 V	$T_J = 25^\circ\text{C}$	72	103		
			$-40^\circ\text{C} \leq T_J \leq 125^\circ\text{C}$	64			
V_O	Output swing	$R_L = 2\text{ k}\Omega$ to 1.35 V	$T_J = 25^\circ\text{C}$		24	60	mV
			$-40^\circ\text{C} \leq T_J \leq 125^\circ\text{C}$			95	
			$T_J = 25^\circ\text{C}$	60	26		
			$-40^\circ\text{C} \leq T_J \leq 125^\circ\text{C}$	95			
		$R_L = 10\text{ k}\Omega$ to 1.35 V	$T_J = 25^\circ\text{C}$		5	30	
			$-40^\circ\text{C} \leq T_J \leq 125^\circ\text{C}$			40	
I_O	Output short-circuit current	Sourcing, LMV341-N and LMV342-N		20	32	mA	
		Sourcing, LMV344-N		18	24		
		Sinking		15	24		
t_{on}	Turnon time from shutdown	LMV341-N			5	μs	
V_{SD}	Shutdown pin voltage	ON mode, LMV341-N		2.4	1.7	2.7	V
		Shutdown mode, LMV341-N		0	1	0.8	

- Electrical characteristic values apply only for factory testing conditions at the temperature indicated. Factory testing conditions result in very limited self-heating of the device such that $T_J = T_A$. No specification of parametric performance is indicated in the electrical tables under conditions of internal self heating where $T_J > T_A$.
- All limits are specified by testing or statistical analysis.
- Typical values represent the most likely parametric norm as determined at the time of characterization. Actual typical values may vary over time and also depends on the application and configuration. The typical values are not tested and are not ensured on shipped production material.

6.6 Electrical Characteristics – 2.7 V (AC)

 $T_J = 25^\circ\text{C}$, $V^+ = 2.7\text{V}$, $V^- = 0\text{V}$, $V_{CM} = V^+ / 2$, $V_O = V^+ / 2$, and $R_L > 1\text{M}\Omega$ (unless otherwise noted)⁽¹⁾

PARAMETER		TEST CONDITIONS	MIN ⁽²⁾	TYP ⁽³⁾	MAX ⁽²⁾	UNIT
SR	Slew rate	$R_L = 10\text{ k}\Omega$ ⁽⁴⁾		1		V/ μs
GBW	Gain bandwidth product	$R_L = 100\text{ k}\Omega$, $C_L = 200\text{ pF}$		1		MHz
Φ_m	Phase margin	$R_L = 100\text{ k}\Omega$		72		°
G_m	Gain margin	$R_L = 100\text{ k}\Omega$		20		dB
e_n	Input-referred voltage noise	$f = 1\text{ kHz}$		40		nV/ $\sqrt{\text{Hz}}$
i_n	Input-referred current noise	$f = 1\text{ kHz}$		0.001		pA/ $\sqrt{\text{Hz}}$
THD	Total harmonic distortion	$f = 1\text{ kHz}$, $A_V = +1$, $R_L = 600\ \Omega$, $V_{IN} = 1V_{PP}$		0.017%		

- (1) Electrical characteristic values apply only for factory testing conditions at the temperature indicated. Factory testing conditions result in very limited self-heating of the device such that $T_J = T_A$. No specification of parametric performance is indicated in the electrical tables under conditions of internal self heating where $T_J > T_A$.
- (2) All limits are specified by testing or statistical analysis.
- (3) Typical values represent the most likely parametric norm as determined at the time of characterization. Actual typical values may vary over time and also depends on the application and configuration. The typical values are not tested and are not ensured on shipped production material.
- (4) Connected as voltage follower with 2- V_{PP} step input. Number specified is the slower of the positive and negative slew rates.

6.7 Electrical Characteristics – 5 V (DC)

 $T_J = 25^\circ\text{C}$, $V^+ = 5\text{ V}$, $V^- = 0\text{ V}$, $V_{CM} = V^+ / 2$, $V_O = V^+ / 2$, and $R_L > 1\text{M}\Omega$ (unless otherwise noted)⁽¹⁾

PARAMETER		TEST CONDITIONS	MIN ⁽²⁾	TYP ⁽³⁾	MAX ⁽²⁾	UNIT
V_{OS}	Input offset voltage	LMV341-N	$T_J = 25^\circ\text{C}$	0.025	4	mV
			$-40^\circ\text{C} \leq T_J \leq 125^\circ\text{C}$		4.5	
		LMV342-N and LMV344-N	$T_J = 25^\circ\text{C}$	0.7	5	
			$-40^\circ\text{C} \leq T_J \leq 125^\circ\text{C}$		5.5	
TCV_{OS}	Input offset voltage average drift		1.9		$\mu\text{V}/^\circ\text{C}$	
I_B	Input bias current	$T_J = 25^\circ\text{C}$		0.02	200	pA
		$-40^\circ\text{C} \leq T_J \leq 125^\circ\text{C}$			375	
I_{OS}	Input offset current			6.6		fA
I_S	Supply current	Per amplifier	$T_J = 25^\circ\text{C}$	107	200	μA
			$-40^\circ\text{C} \leq T_J \leq 125^\circ\text{C}$		260	
		Shutdown mode, $V_{SD} = 0\text{ V}$, LMV341-N	$T_J = 25^\circ\text{C}$	0.033	1	
			$-40^\circ\text{C} \leq T_J \leq 125^\circ\text{C}$		1.5	
CMRR	Common-mode rejection ratio	$0\text{ V} \leq V_{CM} \leq 4\text{ V}$, $0\text{ V} \leq V_{CM} \leq 3.9\text{ V}$	$T_J = 25^\circ\text{C}$	56	86	dB
			$-40^\circ\text{C} \leq T_J \leq 125^\circ\text{C}$	50		
PSRR	Power supply rejection ratio	$2.7\text{ V} \leq V^+ \leq 5\text{ V}$	$T_J = 25^\circ\text{C}$	65	82	dB
			$-40^\circ\text{C} \leq T_J \leq 125^\circ\text{C}$	60		
V_{CM}	Input common-mode voltage	For CMRR $\geq 50\text{ dB}$	V+	4.2	4	V
			V-	0	-0.2	
A_V	Large signal voltage gain ⁽⁴⁾	$R_L = 10\text{ k}\Omega$ to 2.5 V	$T_J = 25^\circ\text{C}$	78	116	dB
			$-40^\circ\text{C} \leq T_J \leq 125^\circ\text{C}$	70		
		$R_L = 2\text{ k}\Omega$ to 2.5 V	$T_J = 25^\circ\text{C}$	72	107	
			$-40^\circ\text{C} \leq T_J \leq 125^\circ\text{C}$	64		

- (1) Electrical characteristic values apply only for factory testing conditions at the temperature indicated. Factory testing conditions result in very limited self-heating of the device such that $T_J = T_A$. No specification of parametric performance is indicated in the electrical tables under conditions of internal self heating where $T_J > T_A$.
- (2) All limits are specified by testing or statistical analysis.
- (3) Typical values represent the most likely parametric norm as determined at the time of characterization. Actual typical values may vary over time and also depends on the application and configuration. The typical values are not tested and are not ensured on shipped production material.
- (4) R_L is connected to mid-supply. The output voltage is $\text{GND} + 0.2\text{ V} \leq V_O \leq V^+ - 0.2\text{ V}$

Electrical Characteristics – 5 V (DC) (continued)

 $T_J = 25^\circ\text{C}$, $V^+ = 5\text{ V}$, $V^- = 0\text{ V}$, $V_{\text{CM}} = V^+ / 2$, $V_O = V^+ / 2$, and $R_L > 1\text{ M}\Omega$ (unless otherwise noted)⁽¹⁾

PARAMETER		TEST CONDITIONS	MIN ⁽²⁾	TYP ⁽³⁾	MAX ⁽²⁾	UNIT
V_O	Output swing	$R_L = 2\text{ k}\Omega$ to 2.5 V	$T_J = 25^\circ\text{C}$	32	60	mV
			$-40^\circ\text{C} \leq T_J \leq 125^\circ\text{C}$		95	
		$R_L = 10\text{ k}\Omega$ to 2.5 V	$T_J = 25^\circ\text{C}$	60	34	
			$-40^\circ\text{C} \leq T_J \leq 125^\circ\text{C}$	95		
			$T_J = 25^\circ\text{C}$	30	7	
			$-40^\circ\text{C} \leq T_J \leq 125^\circ\text{C}$	40		
I_O	Output short-circuit current	Sourcing	85	113	mA	
		Sinking	50	75		
t_{on}	Turnon time from shutdown	LMV341-N		5	μs	
V_{SD}	Shutdown pin voltage	ON mode, LMV341-N	4.5	3.1	5	V
		Shutdown mode, LMV341-N	0	1	0.8	

6.8 Electrical Characteristics – 5 V (AC)

 $T_J = 25^\circ\text{C}$, $V^+ = 5\text{ V}$, $V^- = 0\text{ V}$, $V_{\text{CM}} = V^+ / 2$, $V_O = V^+ / 2$ and $R_L > 1\text{ M}\Omega$ (unless otherwise noted)⁽¹⁾

PARAMETER		CONDITIONS	MIN ⁽²⁾	TYP ⁽³⁾	MAX ⁽²⁾	UNIT
SR	Slew rate	$R_L = 10\text{ k}\Omega$ ⁽⁴⁾		1		$\text{V}/\mu\text{s}$
GBW	Gain-bandwidth product	$R_L = 10\text{ k}\Omega$, $C_L = 200\text{ pF}$		1		MHz
Φ_m	Phase margin	$R_L = 100\text{ k}\Omega$		70		deg
G_m	Gain margin	$R_L = 100\text{ k}\Omega$		20		dB
e_n	Input-referred voltage noise	$f = 1\text{ kHz}$		39		$\text{nV}/\sqrt{\text{Hz}}$
i_n	Input-referred current noise	$f = 1\text{ kHz}$		0.001		$\text{pA}/\sqrt{\text{Hz}}$
THD	Total harmonic distortion	$f = 1\text{ kHz}$, $A_V = +1$, $R_L = 600\ \Omega$, $V_{\text{IN}} = 1V_{\text{PP}}$		0.012%		

- (1) Electrical characteristic values apply only for factory testing conditions at the temperature indicated. Factory testing conditions result in very limited self-heating of the device such that $T_J = T_A$. No specification of parametric performance is indicated in the electrical tables under conditions of internal self heating where $T_J > T_A$.
- (2) All limits are specified by testing or statistical analysis.
- (3) Typical values represent the most likely parametric norm as determined at the time of characterization. Actual typical values may vary over time and also depends on the application and configuration. The typical values are not tested and are not ensured on shipped production material.
- (4) Connected as voltage follower with $2 \cdot V_{\text{PP}}$ step input. Number specified is the slower of the positive and negative slew rates.

6.9 Typical Characteristics

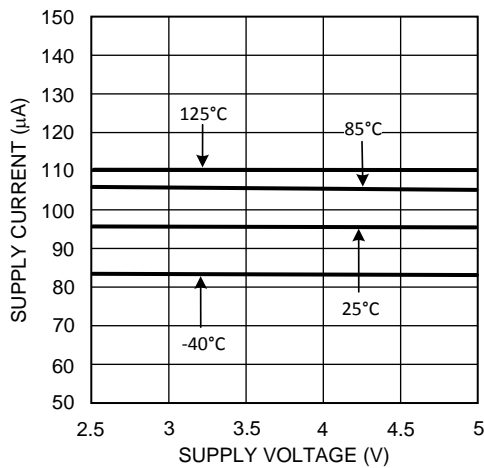

Figure 1. Supply Current vs Supply Voltage (LMV341-N)

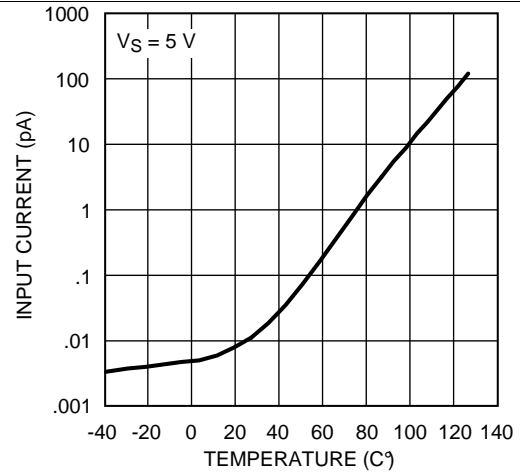

Figure 2. Input Current vs Temperature

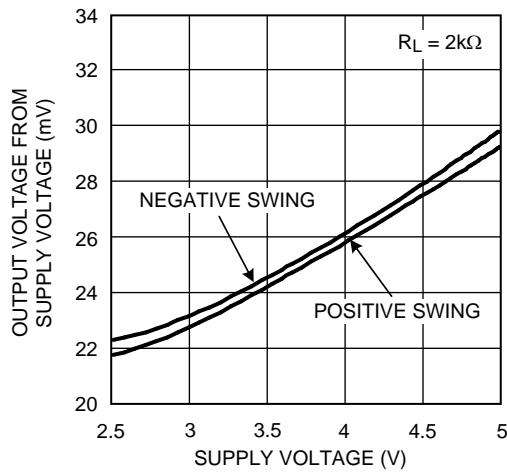

Figure 3. Output Voltage Swing vs Supply Voltage

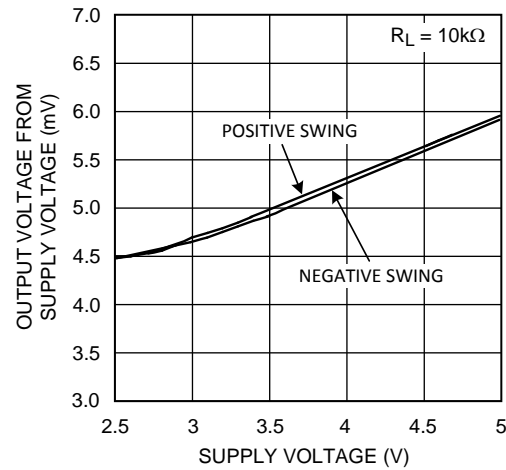

Figure 4. Output Voltage Swing vs Supply Voltage

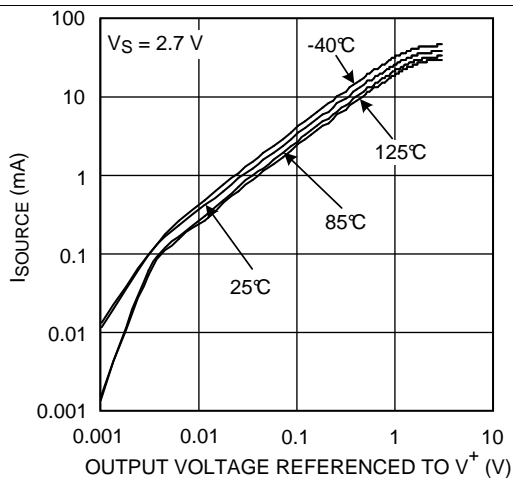

Figure 5. I_{SOURCE} vs V_{OUT}

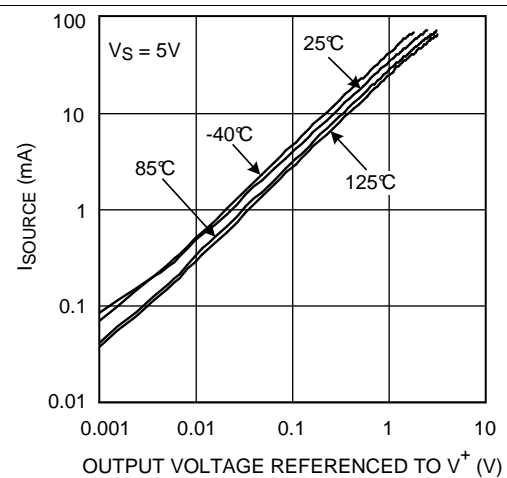

Figure 6. I_{SOURCE} vs V_{OUT}

Typical Characteristics (continued)

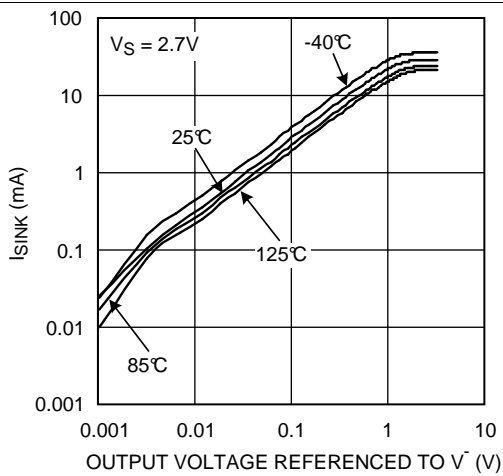

Figure 7. I_{SINK} vs V_{OUT}

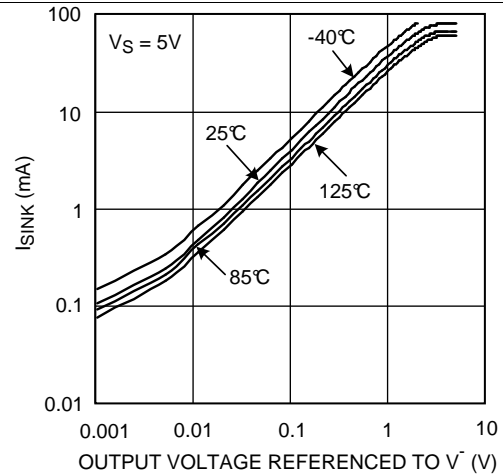

Figure 8. I_{SINK} vs V_{OUT}

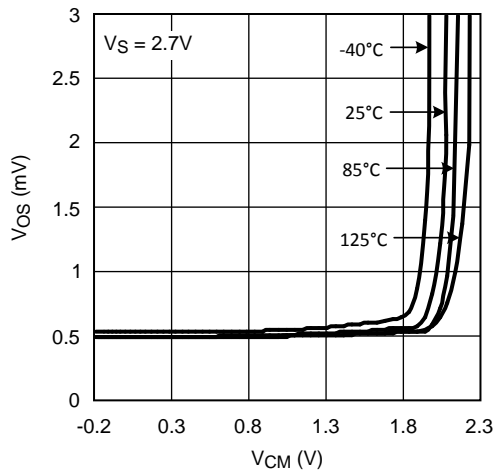

Figure 9. V_{OS} vs V_{CM}

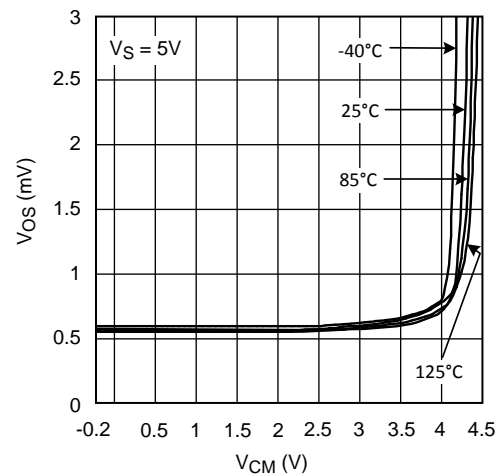

Figure 10. V_{OS} vs V_{CM}

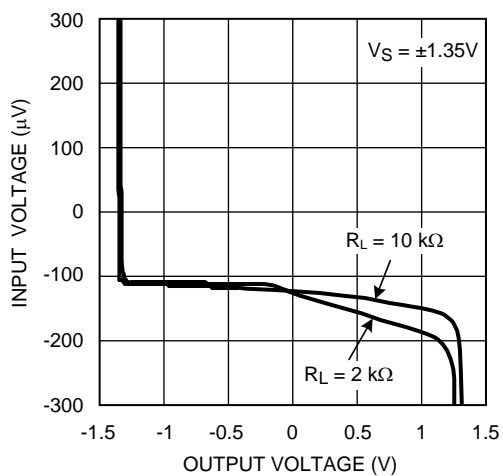

Figure 11. V_{IN} vs V_{OUT}

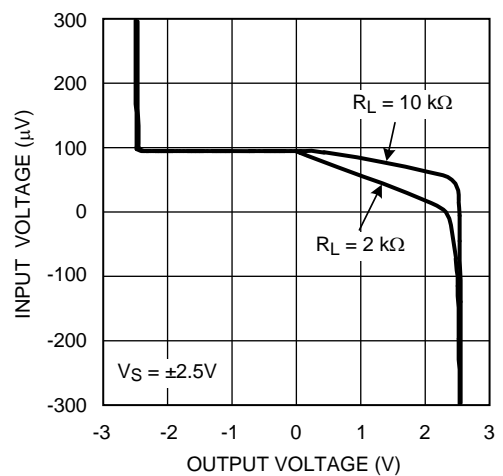

Figure 12. V_{IN} vs V_{OUT}

Typical Characteristics (continued)

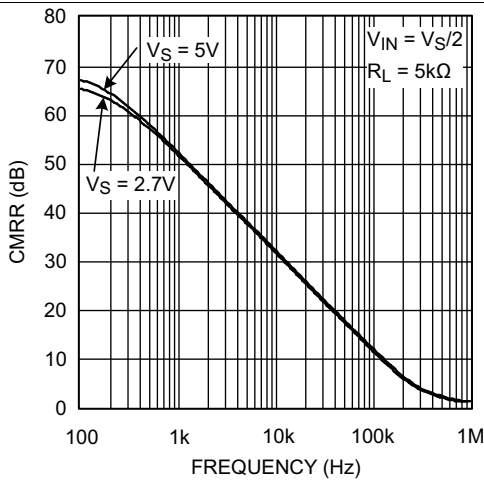

Figure 13. CMRR vs Frequency

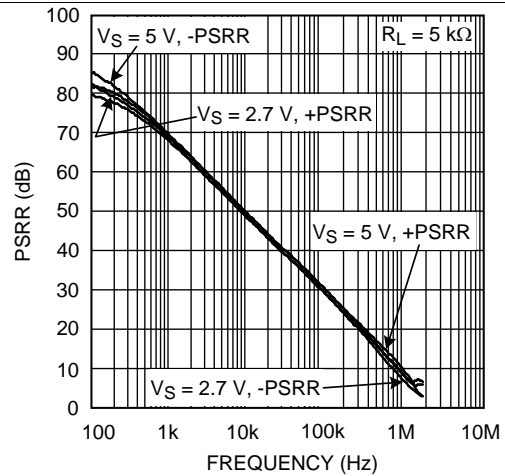

Figure 14. PSRR vs Frequency

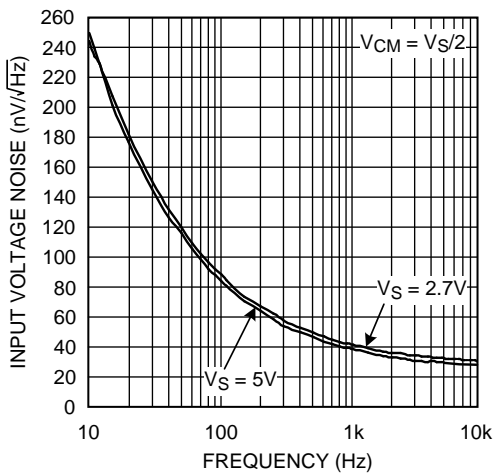

Figure 15. Input Voltage Noise vs Frequency

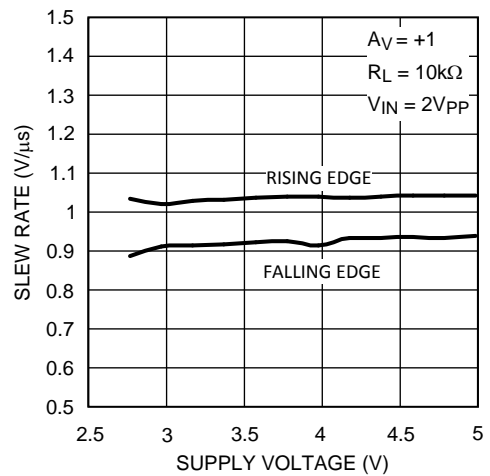

Figure 16. Slew Rate vs VSUPPLY

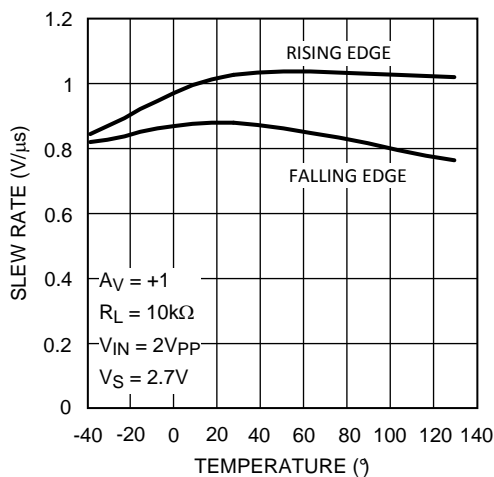

Figure 17. Slew Rate vs Temperature

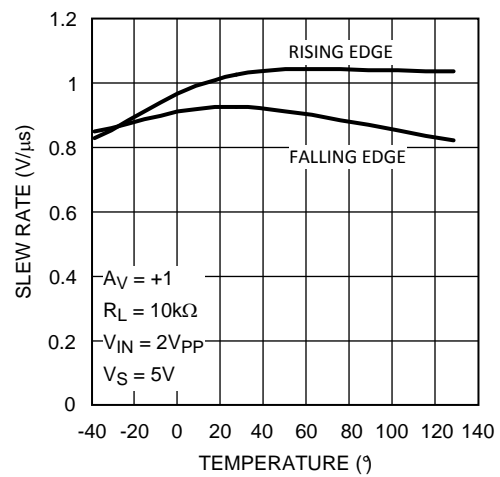
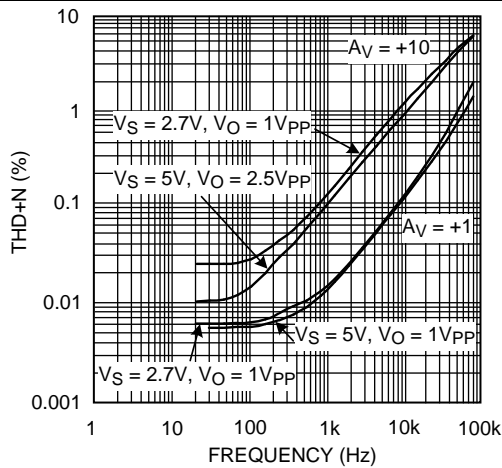
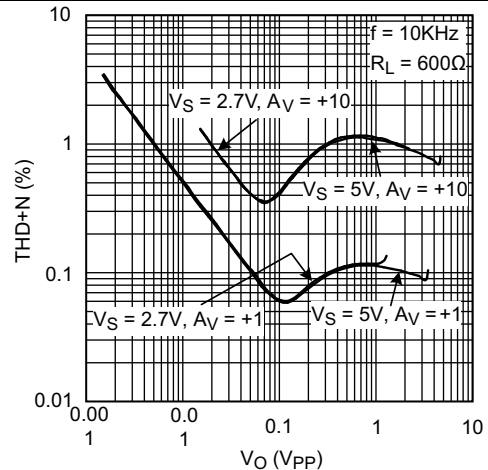
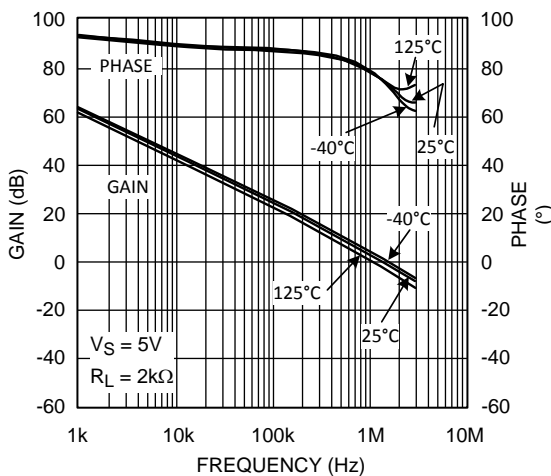
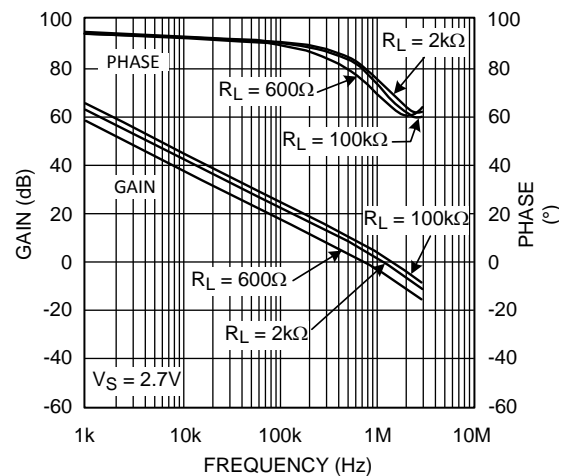
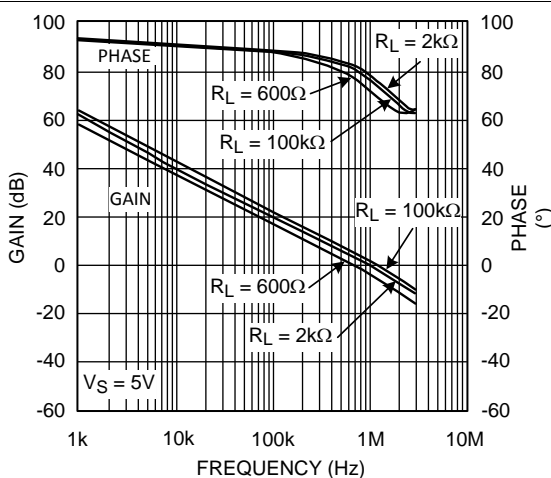
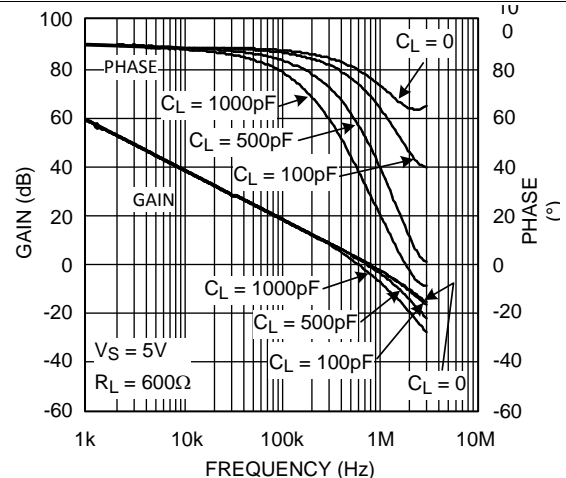

Figure 18. Slew Rate vs Temperature

Typical Characteristics (continued)

Figure 19. THD+N vs Frequency

Figure 20. THD+N vs V_{OUT}

Figure 21. Open-Loop Frequency Over Temperature

Figure 22. Open-Loop Frequency Response

Figure 23. Open-Loop Frequency Response

Figure 24. Gain and Phase vs C_L

Typical Characteristics (continued)

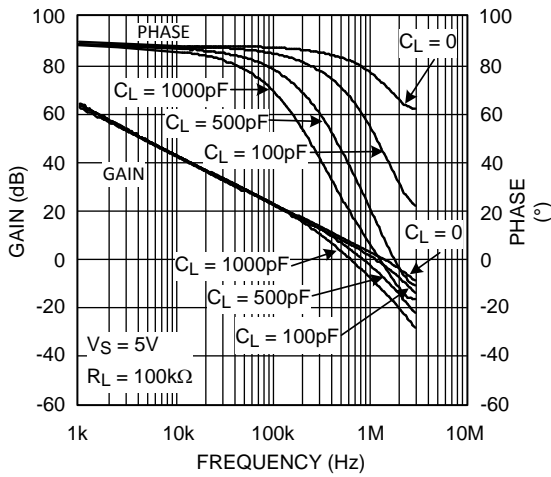

Figure 25. Gain and Phase vs C_L

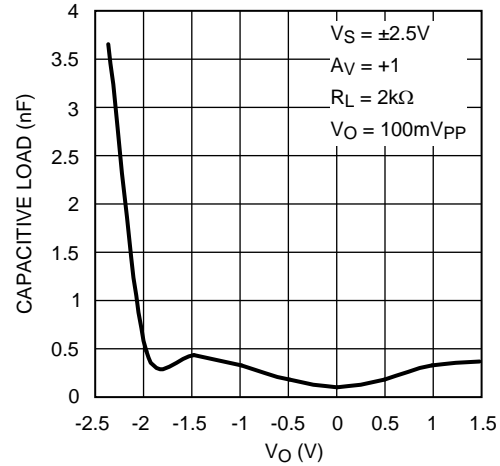

Figure 26. Stability vs Capacitive Load

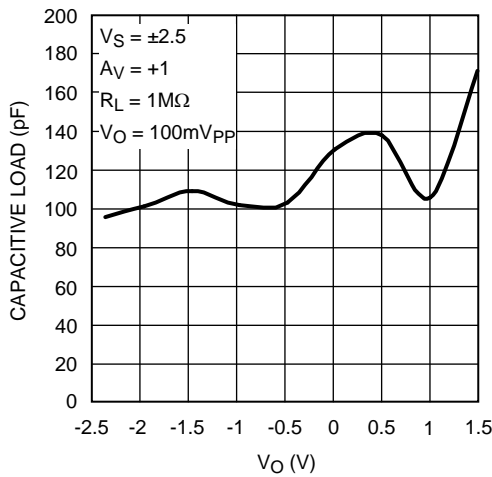

Figure 27. Stability vs Capacitive Load

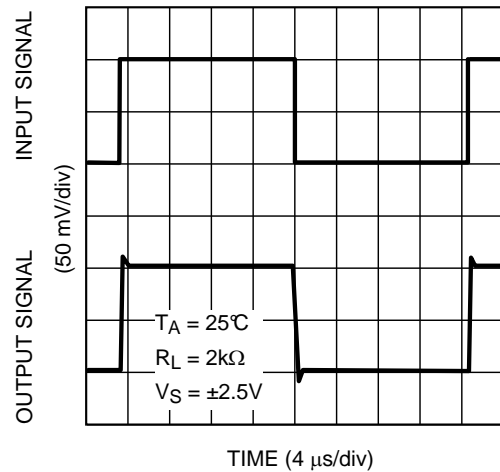

Figure 28. Noninverting Small Signal Pulse Response

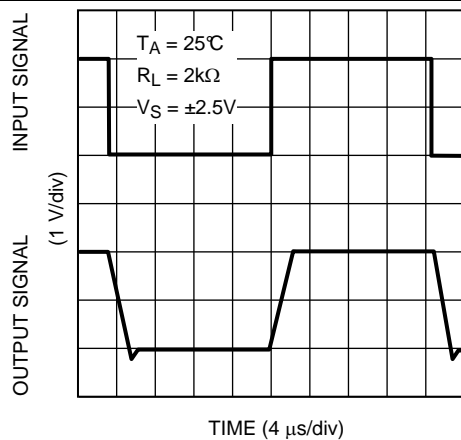

Figure 29. Noninverting Large Signal Pulse Response

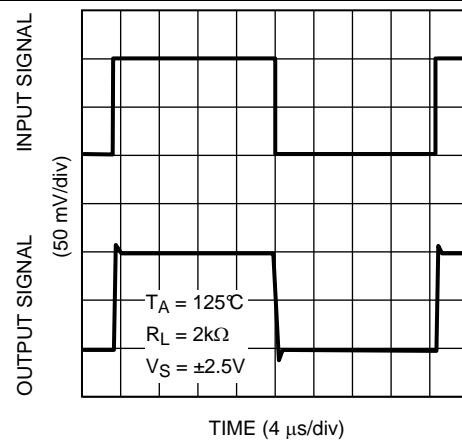
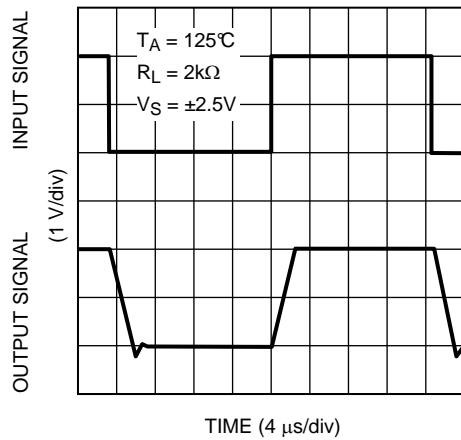
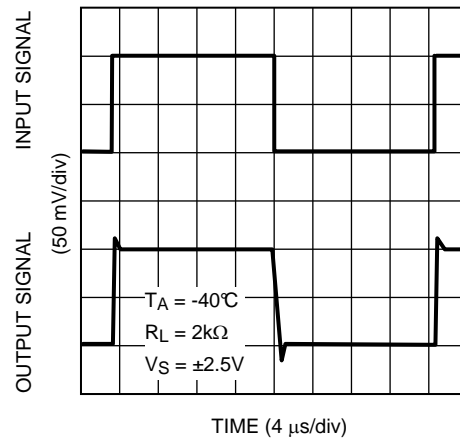
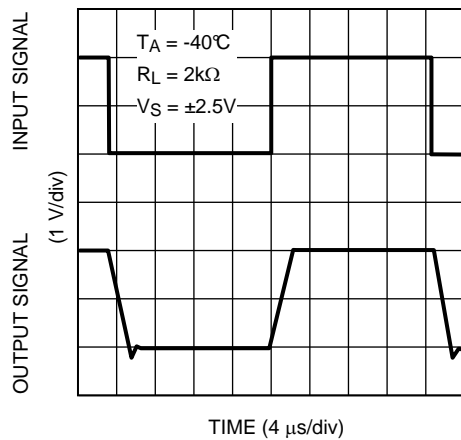
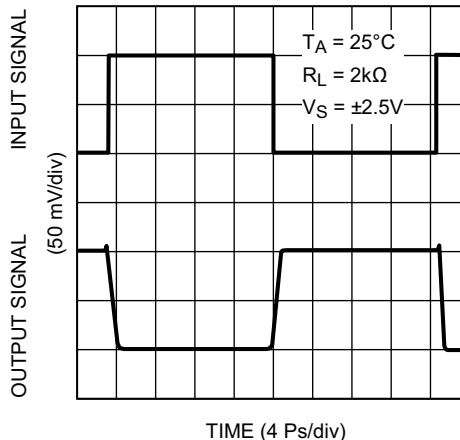
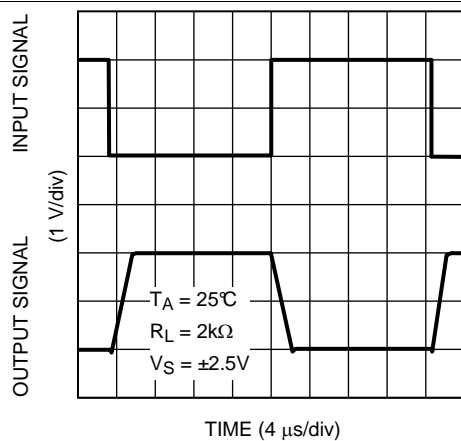
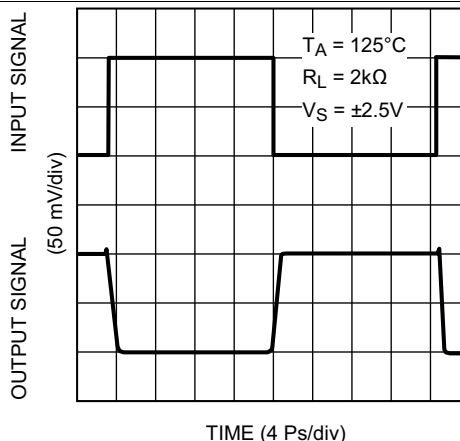

Figure 30. Noninverting Small Signal Pulse Response

Typical Characteristics (continued)

Figure 31. Noninverting Large Signal Pulse Response

Figure 32. Noninverting Small Signal Pulse Response

Figure 33. Noninverting Large Signal Pulse Response

Figure 34. Inverting Small Signal Pulse Response

Figure 35. Inverting Large Signal Pulse Response

Figure 36. Inverting Small Signal Pulse Response

Typical Characteristics (continued)

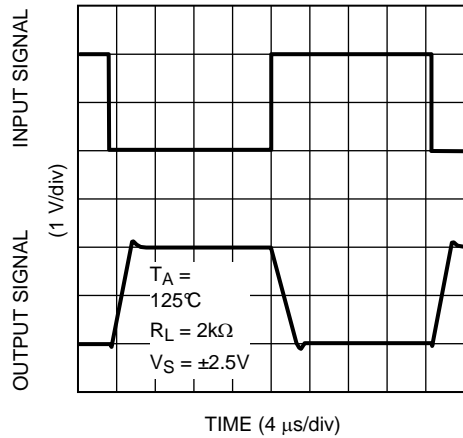

Figure 37. Inverting Large Signal Pulse Response

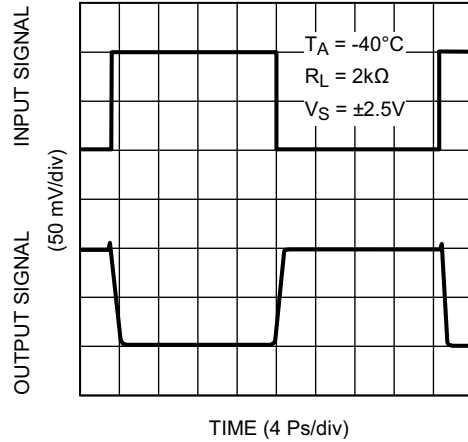

Figure 38. Inverting Small Signal Pulse Response

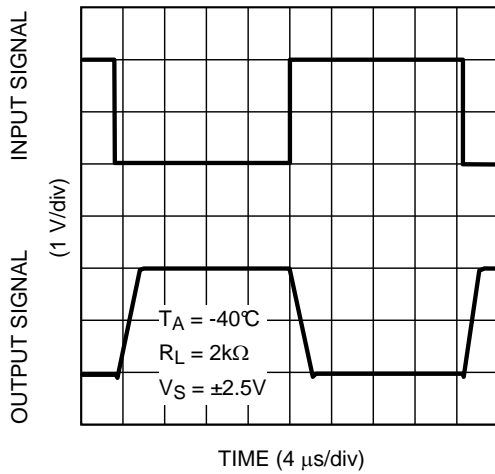

Figure 39. Inverting Large Signal Pulse Response

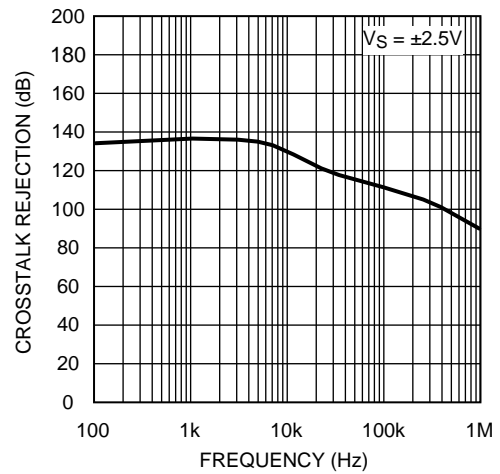

Figure 40. Crosstalk Rejection vs Frequency

7 Detailed Description

7.1 Overview

TI's LMV34x-N family of amplifiers have 1-MHz bandwidth, 1-V/ μ s slew rate, a rail-to-rail output stage, and consume only 100 μ A of current per amplifier while active. When in shutdown mode it only consumes 45-pA supply consumption with only 20 fA of input bias current. Lastly, these operational amplifiers provide an input-referred voltage noise 29 nV/ $\sqrt{\text{Hz}}$ (at 10 kHz).

7.2 Functional Block Diagram

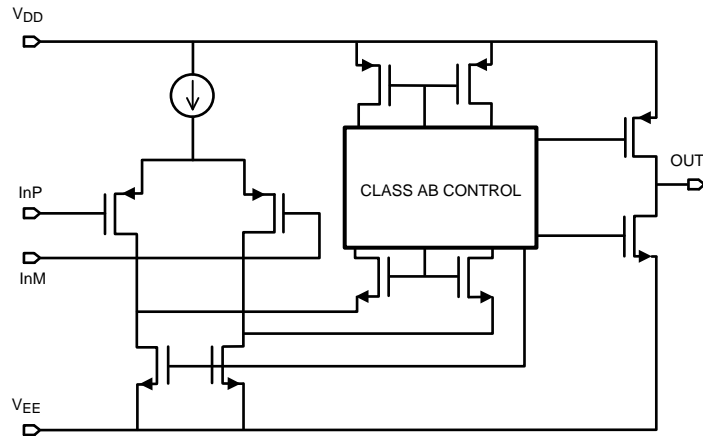

Copyright © 2016, Texas Instruments Incorporated

7.3 Feature Description

7.3.1 Class AB Turnaround Stage Amplifier

This patented folded cascode stage has a combined class AB amplifier stage, which replaces the conventional folded cascode stage. Therefore, the class AB folded cascode stage runs at a much lower quiescent current compared to conventional-folded cascode stages. This results in significantly smaller offset and noise contributions. The reduced offset and noise contributions in turn reduce the offset voltage level and the voltage noise level at the input of LMV34x-N. Also the lower quiescent current results in a high open-loop gain for the amplifier. The lower quiescent current does not affect the slew rate of the amplifier nor its ability to handle the total current swing coming from the input stage.

The input voltage noise of the device at low frequencies, below 1 kHz, is slightly higher than devices with a BJT input stage; however, the PMOS input stage results in a much lower input bias current and the input voltage noise drops at frequencies above 1 kHz.

7.4 Device Functional Modes

7.4.1 Shutdown Feature

The LMV341-N is capable of being turned off to conserve power and increase battery life in portable devices. Once in shutdown mode the supply current is drastically reduced, 1- μ A maximum, and the output is *tri-stated*.

The device is disabled when the shutdown pin voltage is pulled low. The shutdown pin must never be left unconnected. Leaving the pin floating results in an undefined operation mode and the device may oscillate between shutdown and active modes.

The LMV341-N typically turns on 2.8 μ s after the shutdown voltage is pulled high. The device turns off in less than 400 ns after shutdown voltage is pulled low. [Figure 41](#) and [Figure 42](#) show the turnon and turnoff time of the LMV341-N, respectively. To reduce the effect of the capacitance added to the circuit by the scope probe, in the turnoff time circuit a resistive load of 600 Ω is added. [Figure 43](#) and [Figure 44](#) show the test circuits used to obtain the two plots.

Device Functional Modes (continued)

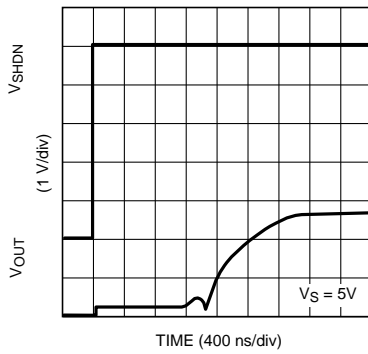

Figure 41. Turnon Time Plot

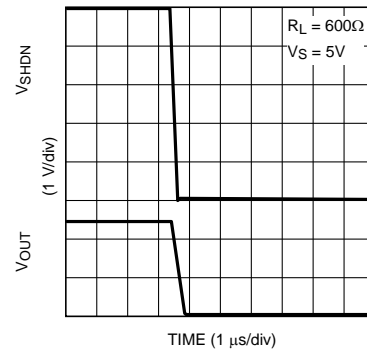

Figure 42. Turnoff Time Plot

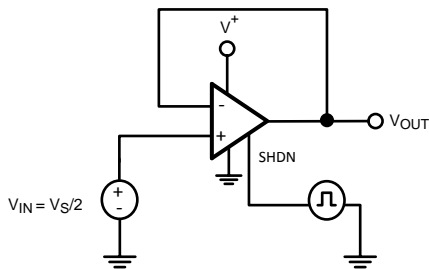

Figure 43. Turnon Time Circuit

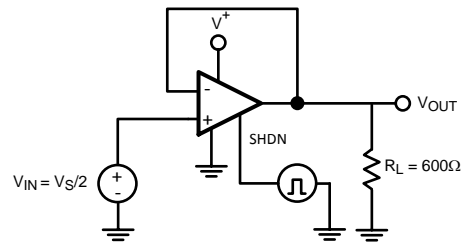

Figure 44. Turnoff Time Circuit

7.4.2 Low Input Bias Current

LMV34x-N amplifiers have a PMOS input stage. As a result, they have a much lower input bias current than devices with BJT input stages. This feature makes these devices ideal for sensor circuits. A typical curve of the input bias current of the LMV341-N is shown in Figure 45.

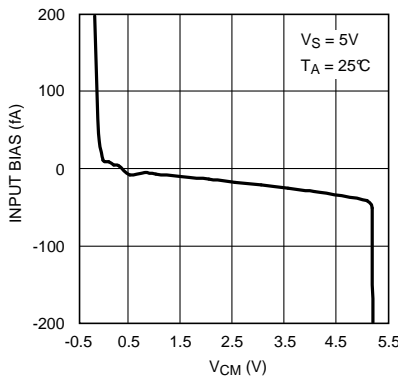

Figure 45. Input Bias Current vs V_{CM}

8 Application and Implementation

NOTE

Information in the following applications sections is not part of the TI component specification, and TI does not warrant its accuracy or completeness. TI's customers are responsible for determining suitability of components for their purposes. Customers should validate and test their design implementation to confirm system functionality.

8.1 Application Information

The LMV34x-N amplifier family features low voltage, low power, rail-to-rail output as well as a shutdown capability, making it well suited for low voltage portable applications.

8.2 Typical Application

8.2.1 Sample and Hold Circuit

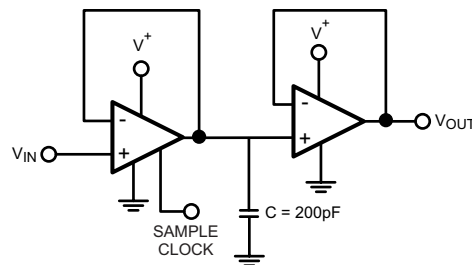

Copyright © 2016, Texas Instruments Incorporated

Figure 46. Sample and Hold Circuit

8.2.1.1 Design Requirements

The lower input bias current of the LMV341-N results in a very high input impedance. The output impedance when the device is in shutdown mode is quite high. These high impedances, along with the ability of the shutdown pin to be derived from a separate power source, make LMV341-N a good choice for sample and hold circuits. The sample clock must be connected to the shutdown pin of the amplifier to rapidly turn the device on or off.

8.2.1.2 Detailed Design Procedure

Figure 46 shows the schematic of a simple sample and hold circuit. When the sample clock is high the first amplifier is in normal operation mode and the second amplifier acts as a buffer. The capacitor, which appears as a load on the first amplifier, is charging at this time. The voltage across the capacitor is that of the noninverting input of the first amplifier because it is connected as a voltage-follower. When the sample clock is low the first amplifier is shut off, bringing the output impedance to a high value. The high impedance of this output, along with the very high impedance on the input of the second amplifier, prevents the capacitor from discharging. There is very little voltage droop while the first amplifier is in shutdown mode. The second amplifier, which is still in normal operation mode and is connected as a voltage follower, also provides the voltage sampled on the capacitor at its output.

Typical Application (continued)

8.2.1.3 Application Curve

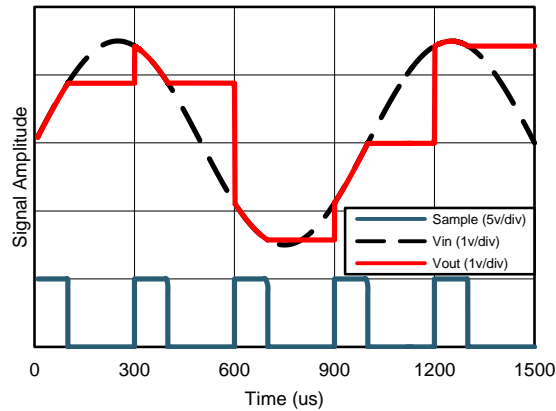

Figure 47. Sample and Hold Circuit Results

9 Power Supply Recommendations

For proper operation, the power supplies must be properly decoupled. For decoupling the supply lines, TI recommends that 10-nF capacitors be placed as close as possible to the op amp power supply pins. For single-supply, place a capacitor between V^+ and V^- supply leads. For dual supplies, place one capacitor between V^+ and ground, and one capacitor between V^- and ground.

10 Layout

10.1 Layout Guidelines

To properly bypass the power supply, several locations on a printed-circuit board need to be considered. A 6.8- μF or greater tantalum capacitor must be placed at the point where the power supply for the amplifier is introduced onto the board. Another 0.1- μF ceramic capacitor must be placed as close as possible to the power supply pin of the amplifier. If the amplifier is operated in a single power supply, only the V^+ pin needs to be bypassed with a 0.1- μF capacitor. If the amplifier is operated in a dual power supply, both V^+ and V^- pins need to be bypassed.

It is good practice to use a ground plane on a printed-circuit board to provide all components with a low inductive ground connection.

Surface-mount components in 0805 size or smaller are recommended in the LMV341-N application circuits. Designers can take advantage of the VSSOP miniature sizes to condense board layout to save space and reduce stray capacitance.

10.2 Layout Example

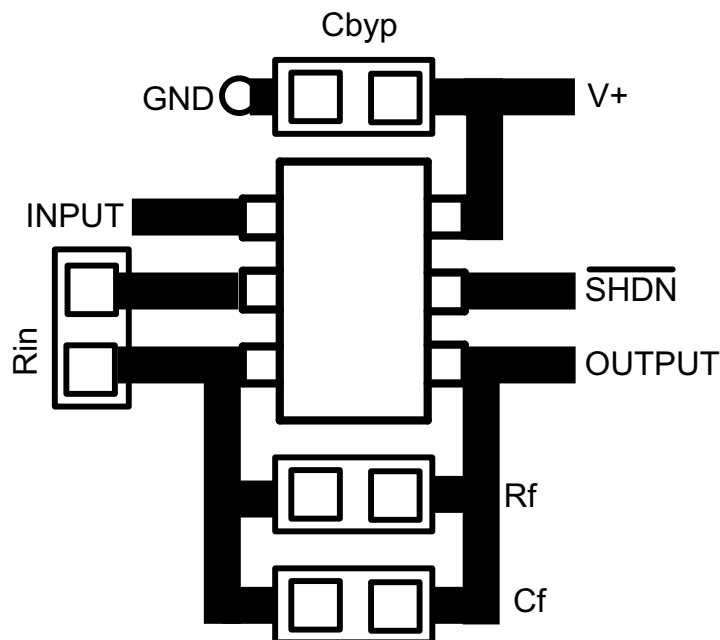

Figure 48. PCB Layout Example

11 デバイスおよびドキュメントのサポート

11.1 デバイス・サポート

11.1.1 開発サポート

開発サポートについては、以下を参照してください。

- [LMV341-N PSPICEモデル](#)(LMV342およびLMV344にも適用可能です)
- [TINA-TI SPICEベースのアナログ・シミュレーション・プログラム](#)
- [DIP アダプタ評価モジュール](#)
- [TIユニバーサル・オペアンプ評価モジュール](#)
- [TI Filterproソフトウェア](#)

11.2 ドキュメントのサポート

11.2.1 関連資料

関連資料については、以下を参照してください。

[『AN-31オペアンプ回路コレクション』\(SNLA140\)](#)

11.3 関連リンク

次の表に、クイック・アクセス・リンクを示します。カテゴリには、技術資料、サポートおよびコミュニティ・リソース、ツールとソフトウェア、およびサンプル注文またはご購入へのクイック・アクセスが含まれます。

表 1. 関連リンク

製品	プロダクト・フォルダ	サンプルとご購入	技術資料	ツールとソフトウェア	サポートとコミュニティ
LMV341-N	ここをクリック	ここをクリック	ここをクリック	ここをクリック	ここをクリック
LMV342-N	ここをクリック	ここをクリック	ここをクリック	ここをクリック	ここをクリック
LMV344-N	ここをクリック	ここをクリック	ここをクリック	ここをクリック	ここをクリック

11.4 ドキュメントの更新通知を受け取る方法

ドキュメントの更新についての通知を受け取るには、[ti.com](#)のデバイス製品フォルダを開いてください。右上の隅にある「通知を受け取る」をクリックして登録すると、変更されたすべての製品情報に関するダイジェストを毎週受け取れます。変更の詳細については、修正されたドキュメントに含まれている改訂履歴をご覧ください。

11.5 コミュニティ・リソース

The following links connect to TI community resources. Linked contents are provided "AS IS" by the respective contributors. They do not constitute TI specifications and do not necessarily reflect TI's views; see TI's [Terms of Use](#).

TI E2E™ Online Community *TI's Engineer-to-Engineer (E2E) Community*. Created to foster collaboration among engineers. At e2e.ti.com, you can ask questions, share knowledge, explore ideas and help solve problems with fellow engineers.

Design Support *TI's Design Support* Quickly find helpful E2E forums along with design support tools and contact information for technical support.

11.6 商標

E2E is a trademark of Texas Instruments.
All other trademarks are the property of their respective owners.

11.7 静電気放電に関する注意事項



これらのデバイスは、限定的なESD(静電破壊)保護機能を内蔵しています。保存時または取り扱い時は、MOSゲートに対する静電破壊を防止するために、リード線同士をショートさせておくか、デバイスを導電フォームに入れる必要があります。

11.8 Glossary

[SLYZ022](#) — *TI Glossary*.

This glossary lists and explains terms, acronyms, and definitions.

12 メカニカル、パッケージ、および注文情報

以降のページには、メカニカル、パッケージ、および注文に関する情報が記載されています。これらの情報は、指定のデバイスに対して提供されている最新のデータです。このデータは予告なく変更されることがあり、ドキュメントが改訂される場合もあります。本データシートのブラウザ版を使用されている場合は、画面左側の説明をご覧ください。

PACKAGING INFORMATION

Orderable part number	Status (1)	Material type (2)	Package Pins	Package qty Carrier	RoHS (3)	Lead finish/ Ball material (4)	MSL rating/ Peak reflow (5)	Op temp (°C)	Part marking (6)
LMV341MG/NOPB	Active	Production	SC70 (DCK) 6	1000 SMALL T&R	Yes	SN	Level-1-260C-UNLIM	-40 to 125	A78
LMV341MG/NOPB.A	Active	Production	SC70 (DCK) 6	1000 SMALL T&R	Yes	SN	Level-1-260C-UNLIM	-40 to 125	A78
LMV341MGX/NOPB	Active	Production	SC70 (DCK) 6	3000 LARGE T&R	Yes	SN	Level-1-260C-UNLIM	-40 to 125	A78
LMV341MGX/NOPB.A	Active	Production	SC70 (DCK) 6	3000 LARGE T&R	Yes	SN	Level-1-260C-UNLIM	-40 to 125	A78
LMV342MA/NOPB	Active	Production	SOIC (D) 8	95 TUBE	Yes	SN	Level-1-260C-UNLIM	-40 to 125	LMV34 2MA
LMV342MA/NOPB.A	Active	Production	SOIC (D) 8	95 TUBE	Yes	SN	Level-1-260C-UNLIM	-40 to 125	LMV34 2MA
LMV342MAX/NOPB	Active	Production	SOIC (D) 8	2500 LARGE T&R	Yes	SN	Level-1-260C-UNLIM	-40 to 125	LMV34 2MA
LMV342MAX/NOPB.A	Active	Production	SOIC (D) 8	2500 LARGE T&R	Yes	SN	Level-1-260C-UNLIM	-40 to 125	LMV34 2MA
LMV342MM/NOPB	Active	Production	VSSOP (DGK) 8	1000 SMALL T&R	Yes	SN	Level-1-260C-UNLIM	-40 to 125	A82A
LMV342MM/NOPB.A	Active	Production	VSSOP (DGK) 8	1000 SMALL T&R	Yes	SN	Level-1-260C-UNLIM	-40 to 125	A82A
LMV342MMX/NOPB	Active	Production	VSSOP (DGK) 8	3500 LARGE T&R	Yes	SN	Level-1-260C-UNLIM	-40 to 125	A82A
LMV342MMX/NOPB.A	Active	Production	VSSOP (DGK) 8	3500 LARGE T&R	Yes	SN	Level-1-260C-UNLIM	-40 to 125	A82A
LMV344MA/NOPB	Active	Production	SOIC (D) 14	55 TUBE	Yes	SN	Level-1-260C-UNLIM	-40 to 125	LMV344MA
LMV344MA/NOPB.A	Active	Production	SOIC (D) 14	55 TUBE	Yes	SN	Level-1-260C-UNLIM	-40 to 125	LMV344MA
LMV344MAX/NOPB	Active	Production	SOIC (D) 14	2500 LARGE T&R	Yes	SN	Level-1-260C-UNLIM	-40 to 125	LMV344MA
LMV344MAX/NOPB.A	Active	Production	SOIC (D) 14	2500 LARGE T&R	Yes	SN	Level-1-260C-UNLIM	-40 to 125	LMV344MA
LMV344MT/NOPB	Active	Production	TSSOP (PW) 14	94 TUBE	Yes	NIPDAU SN	Level-1-260C-UNLIM	-40 to 125	LMV34 4MT
LMV344MT/NOPB.A	Active	Production	TSSOP (PW) 14	94 TUBE	Yes	NIPDAU	Level-1-260C-UNLIM	-40 to 125	LMV34 4MT
LMV344MTX/NOPB	Active	Production	TSSOP (PW) 14	2500 LARGE T&R	Yes	NIPDAU SN	Level-1-260C-UNLIM	-40 to 125	LMV34 4MT
LMV344MTX/NOPB.A	Active	Production	TSSOP (PW) 14	2500 LARGE T&R	Yes	NIPDAU	Level-1-260C-UNLIM	-40 to 125	LMV34 4MT

⁽¹⁾ **Status:** For more details on status, see our [product life cycle](#).

(2) **Material type:** When designated, preproduction parts are prototypes/experimental devices, and are not yet approved or released for full production. Testing and final process, including without limitation quality assurance, reliability performance testing, and/or process qualification, may not yet be complete, and this item is subject to further changes or possible discontinuation. If available for ordering, purchases will be subject to an additional waiver at checkout, and are intended for early internal evaluation purposes only. These items are sold without warranties of any kind.

(3) **RoHS values:** Yes, No, RoHS Exempt. See the [TI RoHS Statement](#) for additional information and value definition.

(4) **Lead finish/Ball material:** Parts may have multiple material finish options. Finish options are separated by a vertical ruled line. Lead finish/Ball material values may wrap to two lines if the finish value exceeds the maximum column width.

(5) **MSL rating/Peak reflow:** The moisture sensitivity level ratings and peak solder (reflow) temperatures. In the event that a part has multiple moisture sensitivity ratings, only the lowest level per JEDEC standards is shown. Refer to the shipping label for the actual reflow temperature that will be used to mount the part to the printed circuit board.

(6) **Part marking:** There may be an additional marking, which relates to the logo, the lot trace code information, or the environmental category of the part.

Multiple part markings will be inside parentheses. Only one part marking contained in parentheses and separated by a "~" will appear on a part. If a line is indented then it is a continuation of the previous line and the two combined represent the entire part marking for that device.

Important Information and Disclaimer: The information provided on this page represents TI's knowledge and belief as of the date that it is provided. TI bases its knowledge and belief on information provided by third parties, and makes no representation or warranty as to the accuracy of such information. Efforts are underway to better integrate information from third parties. TI has taken and continues to take reasonable steps to provide representative and accurate information but may not have conducted destructive testing or chemical analysis on incoming materials and chemicals. TI and TI suppliers consider certain information to be proprietary, and thus CAS numbers and other limited information may not be available for release.

In no event shall TI's liability arising out of such information exceed the total purchase price of the TI part(s) at issue in this document sold by TI to Customer on an annual basis.

OTHER QUALIFIED VERSIONS OF LMV341-N, LMV344-N :

- Automotive : [LMV341-Q1](#), [LMV344-Q1](#)

NOTE: Qualified Version Definitions:

- Automotive - Q100 devices qualified for high-reliability automotive applications targeting zero defects

TAPE AND REEL INFORMATION

QUADRANT ASSIGNMENTS FOR PIN 1 ORIENTATION IN TAPE

*All dimensions are nominal

Device	Package Type	Package Drawing	Pins	SPQ	Reel Diameter (mm)	Reel Width W1 (mm)	A0 (mm)	B0 (mm)	K0 (mm)	P1 (mm)	W (mm)	Pin1 Quadrant
LMV341MG/NOPB	SC70	DCK	6	1000	178.0	8.4	2.25	2.45	1.2	4.0	8.0	Q3
LMV341MGX/NOPB	SC70	DCK	6	3000	178.0	8.4	2.25	2.45	1.2	4.0	8.0	Q3
LMV342MAX/NOPB	SOIC	D	8	2500	330.0	12.4	6.5	5.4	2.0	8.0	12.0	Q1
LMV342MM/NOPB	VSSOP	DGK	8	1000	177.8	12.4	5.3	3.4	1.4	8.0	12.0	Q1
LMV342MMX/NOPB	VSSOP	DGK	8	3500	330.0	12.4	5.3	3.4	1.4	8.0	12.0	Q1
LMV344MAX/NOPB	SOIC	D	14	2500	330.0	16.4	6.5	9.35	2.3	8.0	16.0	Q1
LMV344MTX/NOPB	TSSOP	PW	14	2500	330.0	12.4	6.95	5.6	1.6	8.0	12.0	Q1
LMV344MTX/NOPB	TSSOP	PW	14	2500	330.0	12.4	6.9	5.6	1.6	8.0	12.0	Q1

TAPE AND REEL BOX DIMENSIONS

*All dimensions are nominal

Device	Package Type	Package Drawing	Pins	SPQ	Length (mm)	Width (mm)	Height (mm)
LMV341MG/NOPB	SC70	DCK	6	1000	208.0	191.0	35.0
LMV341MGX/NOPB	SC70	DCK	6	3000	208.0	191.0	35.0
LMV342MAX/NOPB	SOIC	D	8	2500	367.0	367.0	35.0
LMV342MM/NOPB	VSSOP	DGK	8	1000	208.0	191.0	35.0
LMV342MMX/NOPB	VSSOP	DGK	8	3500	367.0	367.0	35.0
LMV344MAX/NOPB	SOIC	D	14	2500	356.0	356.0	35.0
LMV344MTX/NOPB	TSSOP	PW	14	2500	367.0	367.0	35.0
LMV344MTX/NOPB	TSSOP	PW	14	2500	353.0	353.0	32.0

TUBE

*All dimensions are nominal

Device	Package Name	Package Type	Pins	SPQ	L (mm)	W (mm)	T (μm)	B (mm)
LMV342MA/NOPB	D	SOIC	8	95	495	8	4064	3.05
LMV342MA/NOPB.A	D	SOIC	8	95	495	8	4064	3.05
LMV344MA/NOPB	D	SOIC	14	55	495	8	4064	3.05
LMV344MA/NOPB.A	D	SOIC	14	55	495	8	4064	3.05
LMV344MT/NOPB	PW	TSSOP	14	94	495	8	2514.6	4.06
LMV344MT/NOPB	PW	TSSOP	14	94	530	10.2	3600	3.5
LMV344MT/NOPB.A	PW	TSSOP	14	94	495	8	2514.6	4.06
LMV344MT/NOPB.A	PW	TSSOP	14	94	530	10.2	3600	3.5



D0014A

PACKAGE OUTLINE

SOIC - 1.75 mm max height

SMALL OUTLINE INTEGRATED CIRCUIT



4220718/A 09/2016

NOTES:

1. All linear dimensions are in millimeters. Dimensions in parenthesis are for reference only. Dimensioning and tolerancing per ASME Y14.5M.
2. This drawing is subject to change without notice.
3. This dimension does not include mold flash, protrusions, or gate burrs. Mold flash, protrusions, or gate burrs shall not exceed 0.15 mm, per side.
4. This dimension does not include interlead flash. Interlead flash shall not exceed 0.43 mm, per side.
5. Reference JEDEC registration MS-012, variation AB.

EXAMPLE BOARD LAYOUT

D0014A

SOIC - 1.75 mm max height

SMALL OUTLINE INTEGRATED CIRCUIT



LAND PATTERN EXAMPLE
SCALE:8X



SOLDER MASK DETAILS

4220718/A 09/2016

NOTES: (continued)

- 6. Publication IPC-7351 may have alternate designs.
- 7. Solder mask tolerances between and around signal pads can vary based on board fabrication site.

EXAMPLE STENCIL DESIGN

D0014A

SOIC - 1.75 mm max height

SMALL OUTLINE INTEGRATED CIRCUIT



SOLDER PASTE EXAMPLE
BASED ON 0.125 mm THICK STENCIL
SCALE:8X

4220718/A 09/2016

NOTES: (continued)

8. Laser cutting apertures with trapezoidal walls and rounded corners may offer better paste release. IPC-7525 may have alternate design recommendations.
9. Board assembly site may have different recommendations for stencil design.



D0008A

PACKAGE OUTLINE

SOIC - 1.75 mm max height

SMALL OUTLINE INTEGRATED CIRCUIT



4214825/C 02/2019

NOTES:

1. Linear dimensions are in inches [millimeters]. Dimensions in parenthesis are for reference only. Controlling dimensions are in inches. Dimensioning and tolerancing per ASME Y14.5M.
2. This drawing is subject to change without notice.
3. This dimension does not include mold flash, protrusions, or gate burrs. Mold flash, protrusions, or gate burrs shall not exceed $.006$ [0.15] per side.
4. This dimension does not include interlead flash.
5. Reference JEDEC registration MS-012, variation AA.

EXAMPLE BOARD LAYOUT

D0008A

SOIC - 1.75 mm max height

SMALL OUTLINE INTEGRATED CIRCUIT



LAND PATTERN EXAMPLE
 EXPOSED METAL SHOWN
 SCALE:8X



SOLDER MASK DETAILS

4214825/C 02/2019

NOTES: (continued)

- 6. Publication IPC-7351 may have alternate designs.
- 7. Solder mask tolerances between and around signal pads can vary based on board fabrication site.

EXAMPLE STENCIL DESIGN

D0008A

SOIC - 1.75 mm max height

SMALL OUTLINE INTEGRATED CIRCUIT



SOLDER PASTE EXAMPLE
BASED ON .005 INCH [0.125 MM] THICK STENCIL
SCALE:8X

4214825/C 02/2019

NOTES: (continued)

8. Laser cutting apertures with trapezoidal walls and rounded corners may offer better paste release. IPC-7525 may have alternate design recommendations.
9. Board assembly site may have different recommendations for stencil design.

PW0014A



PACKAGE OUTLINE
TSSOP - 1.2 mm max height

SMALL OUTLINE PACKAGE



4220202/B 12/2023

NOTES:

1. All linear dimensions are in millimeters. Any dimensions in parenthesis are for reference only. Dimensioning and tolerancing per ASME Y14.5M.
2. This drawing is subject to change without notice.
3. This dimension does not include mold flash, protrusions, or gate burrs. Mold flash, protrusions, or gate burrs shall not exceed 0.15 mm per side.
4. This dimension does not include interlead flash. Interlead flash shall not exceed 0.25 mm per side.
5. Reference JEDEC registration MO-153.

EXAMPLE BOARD LAYOUT

PW0014A

TSSOP - 1.2 mm max height

SMALL OUTLINE PACKAGE



LAND PATTERN EXAMPLE
EXPOSED METAL SHOWN
SCALE: 10X



4220202/B 12/2023

NOTES: (continued)

- 6. Publication IPC-7351 may have alternate designs.
- 7. Solder mask tolerances between and around signal pads can vary based on board fabrication site.

EXAMPLE STENCIL DESIGN

PW0014A

TSSOP - 1.2 mm max height

SMALL OUTLINE PACKAGE



SOLDER PASTE EXAMPLE
BASED ON 0.125 mm THICK STENCIL
SCALE: 10X

4220202/B 12/2023

NOTES: (continued)

8. Laser cutting apertures with trapezoidal walls and rounded corners may offer better paste release. IPC-7525 may have alternate design recommendations.
9. Board assembly site may have different recommendations for stencil design.

DGK0008A



PACKAGE OUTLINE

VSSOP - 1.1 mm max height

SMALL OUTLINE PACKAGE



NOTES:

PowerPAD is a trademark of Texas Instruments.

1. All linear dimensions are in millimeters. Any dimensions in parenthesis are for reference only. Dimensioning and tolerancing per ASME Y14.5M.
2. This drawing is subject to change without notice.
3. This dimension does not include mold flash, protrusions, or gate burrs. Mold flash, protrusions, or gate burrs shall not exceed 0.15 mm per side.
4. This dimension does not include interlead flash. Interlead flash shall not exceed 0.25 mm per side.
5. Reference JEDEC registration MO-187.

EXAMPLE BOARD LAYOUT

DGK0008A

™ VSSOP - 1.1 mm max height

SMALL OUTLINE PACKAGE



LAND PATTERN EXAMPLE
EXPOSED METAL SHOWN
SCALE: 15X



SOLDER MASK DETAILS

4214862/A 04/2023

NOTES: (continued)

6. Publication IPC-7351 may have alternate designs.
7. Solder mask tolerances between and around signal pads can vary based on board fabrication site.
8. Vias are optional depending on application, refer to device data sheet. If any vias are implemented, refer to their locations shown on this view. It is recommended that vias under paste be filled, plugged or tented.
9. Size of metal pad may vary due to creepage requirement.

EXAMPLE STENCIL DESIGN

DGK0008A

™ VSSOP - 1.1 mm max height

SMALL OUTLINE PACKAGE



SOLDER PASTE EXAMPLE
SCALE: 15X

4214862/A 04/2023

NOTES: (continued)

11. Laser cutting apertures with trapezoidal walls and rounded corners may offer better paste release. IPC-7525 may have alternate design recommendations.
12. Board assembly site may have different recommendations for stencil design.

DCK0006A



PACKAGE OUTLINE

SOT - 1.1 max height

SMALL OUTLINE TRANSISTOR

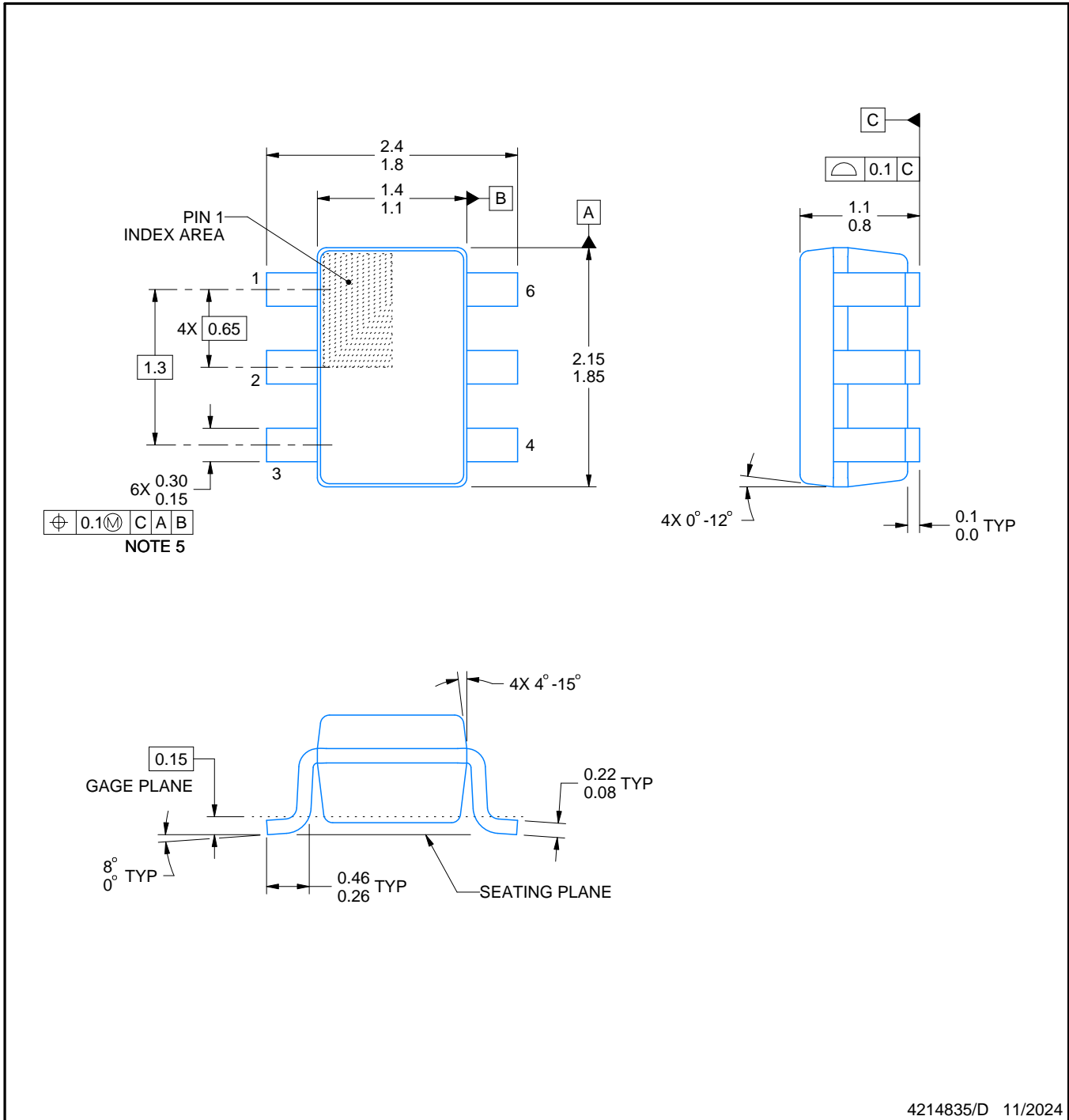

4214835/D 11/2024

NOTES:

1. All linear dimensions are in millimeters. Any dimensions in parenthesis are for reference only. Dimensioning and tolerancing per ASME Y14.5M.
2. This drawing is subject to change without notice.
3. Body dimensions do not include mold flash or protrusion. Mold flash and protrusion shall not exceed 0.15 per side.
4. Falls within JEDEC MO-203 variation AB.

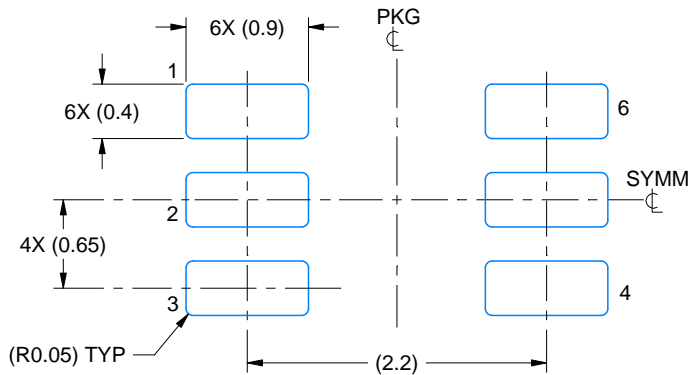

LAND PATTERN EXAMPLE
EXPOSED METAL SHOWN
SCALE:18X

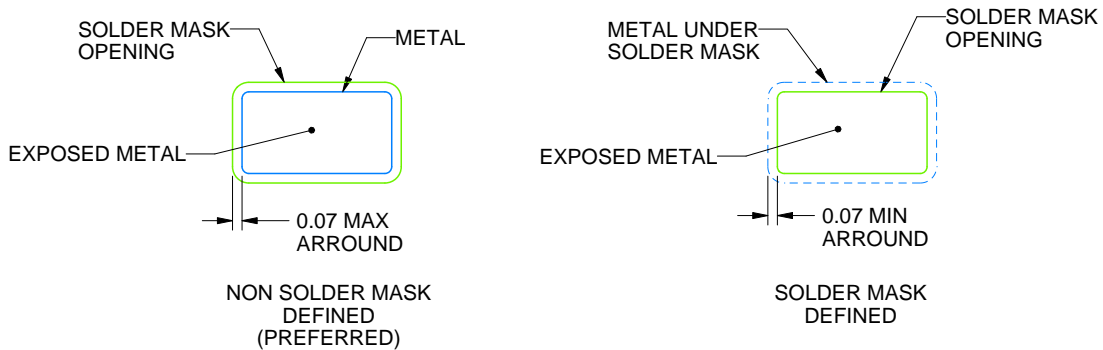

SOLDER MASK DETAILS

4214835/D 11/2024

NOTES: (continued)

5. Publication IPC-7351 may have alternate designs.
6. Solder mask tolerances between and around signal pads can vary based on board fabrication site.

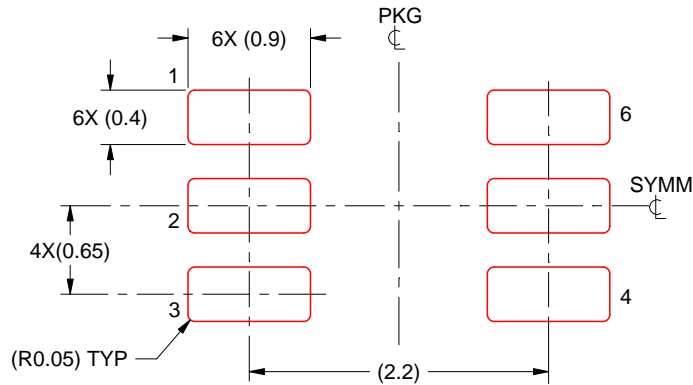

SOLDER PASTE EXAMPLE
BASED ON 0.125 THICK STENCIL
SCALE:18X

4214835/D 11/2024

NOTES: (continued)

7. Laser cutting apertures with trapezoidal walls and rounded corners may offer better paste release. IPC-7525 may have alternate design recommendations.
8. Board assembly site may have different recommendations for stencil design.

重要なお知らせと免責事項

TI は、技術データと信頼性データ (データシートを含みます)、設計リソース (リファレンス デザインを含みます)、アプリケーションや設計に関する各種アドバイス、Web ツール、安全性情報、その他のリソースを、欠陥が存在する可能性のある「現状のまま」提供しており、商品性および特定目的に対する適合性の黙示保証、第三者の知的財産権の非侵害保証を含むいかなる保証も、明示的または黙示的にかかわらず拒否します。

これらのリソースは、TI 製品を使用する設計の経験を積んだ開発者への提供を意図したものです。(1) お客様のアプリケーションに適した TI 製品の選定、(2) お客様のアプリケーションの設計、検証、試験、(3) お客様のアプリケーションに該当する各種規格や、その他のあらゆる安全性、セキュリティ、規制、または他の要件への確実な適合に関する責任を、お客様のみが単独で負うものとし、

上記の各種リソースは、予告なく変更される可能性があります。これらのリソースは、リソースで説明されている TI 製品を使用するアプリケーションの開発の目的でのみ、TI はその使用をお客様に許諾します。これらのリソースに関して、他の目的で複製することや掲載することは禁止されています。TI や第三者の知的財産権のライセンスが付与されている訳ではありません。お客様は、これらのリソースを自身で使用した結果発生するあらゆる申し立て、損害、費用、損失、責任について、TI およびその代理人を完全に補償するものとし、TI は一切の責任を拒否します。

TI の製品は、[TI の販売条件](#)、[TI の総合的な品質ガイドライン](#)、[ti.com](#) または TI 製品などに関連して提供される他の適用条件に従い提供されます。TI がこれらのリソースを提供することは、適用される TI の保証または他の保証の放棄の拡大や変更を意味するものではありません。TI がカスタム、またはカスタマー仕様として明示的に指定していない限り、TI の製品は標準的なカタログに掲載される汎用機器です。

お客様がいかなる追加条項または代替条項を提案する場合も、TI はそれらに異議を唱え、拒否します。

Copyright © 2026, Texas Instruments Incorporated

最終更新日 : 2025 年 10 月