

OPAx376-Q1 低ノイズ、低静止電流、 高精度の e-trim™ オペアンプ

1 特長

- 車載アプリケーション用に AEC-Q100 認定済み:
 - 温度グレード 1: -40°C ~ +125°C, T_A
- 機能安全に対応
 - 機能安全システムの設計に役立つ資料を利用可能 (OPA376-Q1 および OPA2376-Q1)
- 低ノイズ: 1kHz において 7.5nV/√Hz
- 0.1Hz ~ 10Hz のノイズ: 0.8μV_{PP}
- 静止電流: 760μA (標準値)
- 低いオフセット電圧: 5μV (標準値)
- ゲイン帯域幅積: 5.5MHz
- レール・ツー・レール入出力
- 単一電源動作
- 電源電圧: 2.2V ~ 5.5V
- 省スペースのパッケージ:
 - SC70, SOT-23, VSSOP, TSSOP

2 アプリケーション

- オンボード・チャージャ (OBC) とワイヤレス・チャージャ
- インバータおよびモーター制御
- DC/DC コンバータ
- バッテリー管理システム (BMS)

3 概要

OPAx376-Q1 ファミリーは、新世代の低ノイズ e-trim™ オペアンプであり、優れた DC 精度と AC 性能を実現します。レール・ツー・レール出力、低オフセット (最大 25μV)、低ノイズ (7.5nV/√Hz)、静止電流 950μA (最大値)、5.5MHz 帯域幅により、このデバイスは高精度で携帯性の高いさまざまなアプリケーションに非常に魅力的です。さらに、これらのデバイスは電源範囲が広く、PSRR が非常に優れているため、OPA376-Q1 は、バッテリーから直接レギュレーションなしで動作するアプリケーションにも理想的です。

OPA376-Q1 (シングル・バージョン) は MicroSIZE SC70-5、SOT23-5、SOIC-8 パッケージで供給されます。OPA2376-Q1 (デュアル) は、SOIC-8 および VSSOP-8 パッケージで供給されます。OPA4376-Q1 (クワッド) は、TSSOP-14 パッケージで供給されます。どのバージョンも、-40°C ~ +125°C での動作が規定されています。

デバイス情報

部品番号	パッケージ ⁽¹⁾	本体サイズ (公称)
OPA376-Q1	SC70 (5)	2.00mm × 1.25mm
	SOT-23 (5)	2.90mm × 1.60mm
	SOIC (8)	4.90mm × 3.91mm
OPA2376-Q1	SOIC (8)	4.90mm × 3.91mm
	VSSOP (8)	3.00mm × 3.00mm
OPA4376-Q1	TSSOP (14)	5.00mm × 4.40mm

- (1) 利用可能なすべてのパッケージについては、データシートの末尾にある注文情報を参照してください。

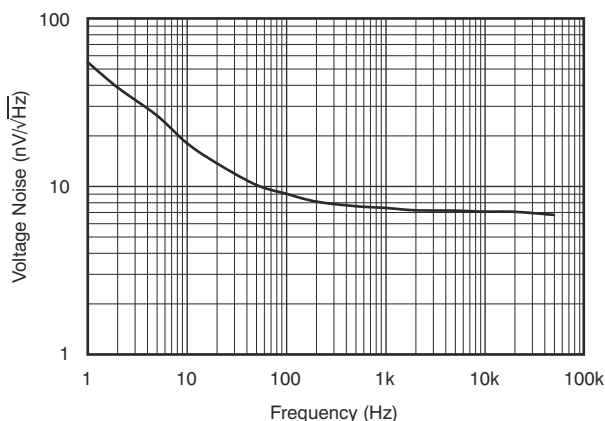

入力電圧ノイズ・スペクトル密度

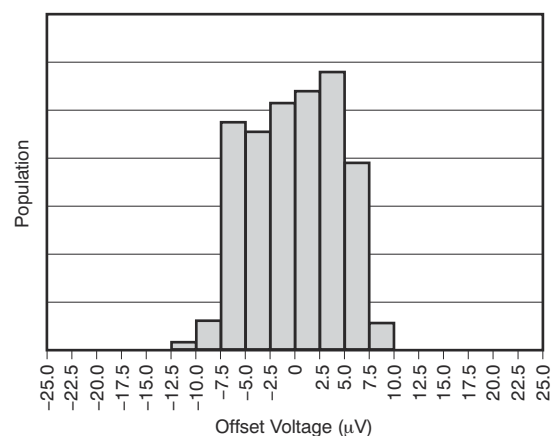

オフセット電圧の製品分布



Table of Contents

1 特長.....	1	7.4 Device Functional Modes.....	15
2 アプリケーション.....	1	8 Application and Implementation.....	16
3 概要.....	1	8.1 Application Information.....	16
4 Revision History.....	2	8.2 Typical Application.....	19
5 Pin Configuration and Functions.....	3	9 Power Supply Recommendations.....	20
6 Specifications.....	6	10 Layout.....	21
6.1 Absolute Maximum Ratings.....	6	10.1 Layout Guidelines.....	21
6.2 ESD Ratings.....	6	10.2 Layout Example.....	21
6.3 Recommended Operating Conditions.....	6	11 Device and Documentation Support.....	22
6.4 Thermal Information: OPA376-Q1.....	7	11.1 Device Support.....	22
6.5 Thermal Information: OPA2376-Q1.....	7	11.2 Documentation Support.....	22
6.6 Thermal Information: OPA4376-Q1.....	7	11.3 ドキュメントの更新通知を受け取る方法.....	22
6.7 Electrical Characteristics.....	8	11.4 サポート・リソース.....	23
6.8 Typical Characteristics.....	9	11.5 Trademarks.....	23
7 Detailed Description.....	13	11.6 静電気放電に関する注意事項.....	23
7.1 Overview.....	13	11.7 用語集.....	23
7.2 Functional Block Diagram.....	13	12 Mechanical, Packaging, and Orderable Information.....	23
7.3 Feature Description.....	13		

4 Revision History

資料番号末尾の英字は改訂を表しています。その改訂履歴は英語版に準じています。

Changes from Revision B (May 2016) to Revision C (March 2021)	Page
• 文書全体にわたって表、図、相互参照の採番方法を更新.....	1
• 「特長」から HBM および CDM の分類レベルを削除し、ESD 定格に移動.....	1
• 「特長」に機能安全のリンクを追加.....	1
• 「アプリケーション」の箇条書きを変更.....	1
• Changed <i>ESD Ratings</i> to show HBM and CDM classification levels.....	6
• Added Figure 6-8, <i>Common-Mode Voltage vs Temperature</i>	9
• Added Figure 6-9, <i>Offset Voltage vs Common-Mode Voltage</i>	9
Changes from Revision A (January 2016) to Revision B (May 2016)	Page
• 「アプリケーション」例を更新.....	1
• Updated the <i>Pin Functions Table</i> for OPA4376-Q1.....	3
• Updated <i>HBM ESD Rating</i>	6
• Changed units on <i>Channel Separation</i>	8
• Deleted the temperature range parameters from the <i>Electrical Characteristics</i> table.....	8
• Removed section regarding <i>WCSP photosensitivity</i>	21
Changes from Revision * (April 2011) to Revision A (January 2016)	Page
• 「ピン機能」表、「ESD 定格」表、「推奨動作条件」表、「熱に関する情報」表、「機能説明」セクション、「デバイスの機能モード」、「アプリケーションと実装」セクション、「電源に関する推奨事項」セクション、「レイアウト」セクション、「デバイスおよびドキュメントのサポート」セクション、「メカニカル、パッケージ、および注文情報」セクションを追加.....	1
• OPA2376-Q1 デバイスを「量産データ」としてリリース.....	1
• Added the <i>Input Offset Voltage and Input Offset Voltage Drift</i> section to the <i>Feature Description</i>	13

5 Pin Configuration and Functions



图 5-1. OPA376-Q1: DBV (5-Pin SOT-23) Package, Top View



图 5-2. OPA376-Q1: DCK (5-Pin SC70) Package, Top View

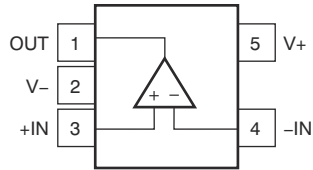

(1) NC denotes no internal connection.

图 5-3. OPA376-Q1: D (8-Pin SOIC) Package, Top View

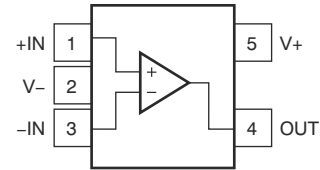
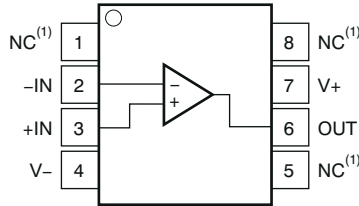
表 5-1. Pin Functions: OPA376-Q1

NAME	PIN NO.			I/O	DESCRIPTION
	SOT-23	SC70	SOIC		
+IN	3	1	3	I	Noninverting input ⁺
-IN	4	3	2	I	Inverting input ⁻
NC	—	—	1, 5, 8	—	No internal connection
OUT	1	4	6	O	Output
V+	5	5	7	—	Positive (highest) power supply ⁺
V-	2	2	4	—	Negative (lowest) power supply ⁻



图 5-4. OPA2376-Q1: D (8-Pin SOIC) and DGK (8-Pin VSSOP) Packages, Top View

表 5-2. Pin Functions: OPA2376-Q1

PIN		I/O	DESCRIPTION
NAME	NO.		
+IN A	3	I	Noninverting input, channel A ⁺
-IN A	2	I	Inverting input, channel A ⁻
+IN B	5	I	Noninverting input, channel B ⁺
-IN B	6	I	Inverting input, channel B ⁻
OUT A	1	O	Output, channel A
OUT B	7	O	Output, channel B
V-	4	—	Negative (lowest) power supply
V+	8	—	Positive (highest) power supply

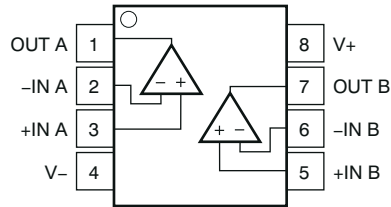

图 5-5. OPA4376-Q1: PW (14-Pin TSSOP) Package, Top View

表 5-3. Pin Functions: OPA4376-Q1

PIN		I/O	DESCRIPTION
NAME	NO.		
+IN A	3	I	Noninverting input, channel A ⁺
-IN A	2	I	Inverting input, channel A ⁻
+IN B	5	I	Noninverting input, channel B ⁺
-IN B	6	I	Inverting input, channel B ⁻
+IN C	10	I	Noninverting input, channel C ⁺
-IN C	9	I	Inverting input, channel C ⁻
+IN D	12	I	Noninverting input, channel D ⁺
-IN D	13	I	Inverting input, channel D ⁻
OUT A	1	O	Output, channel A
OUT B	7	O	Output, channel B
OUT C	8	O	Output, channel C
OUT D	14	O	Output, channel D
V+	4	—	Positive (highest) power supply
V-	11	—	Negative (lowest) power supply

6 Specifications

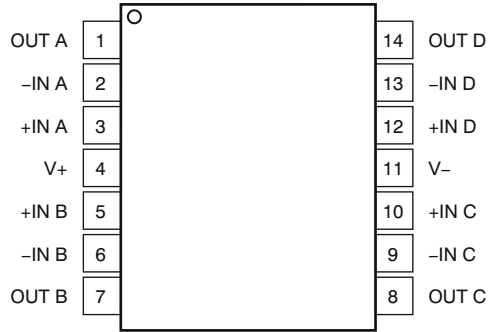
6.1 Absolute Maximum Ratings

over operating free-air temperature range (unless otherwise noted)⁽¹⁾

		MIN	MAX	UNIT
$V_S = (V+) - (V-)$	Supply voltage		7	V
	Signal input pin voltage ⁽²⁾	$(V-) - 0.5$	$(V+) + 0.5$	V
	Signal input pin current ⁽²⁾	-10	10	mA
	Output short-circuit current ⁽³⁾	Continuous		
T_A	Operating temperature	-40	125	°C
T_J	Junction temperature		150	°C
T_{stg}	Storage temperature	-65	150	°C

- (1) Stresses beyond those listed under *Absolute Maximum Ratings* may cause permanent damage to the device. These are stress ratings only, which do not imply functional operation of the device at these or any other conditions beyond those indicated under *Recommended Operating Conditions*. Exposure to absolute-maximum-rated conditions for extended periods may affect device reliability.
- (2) Input terminals are diode-clamped to the power-supply rails. Input signals that can swing more than 0.5 V beyond the supply rails must be current limited to 10 mA or less.
- (3) Short-circuit to ground, one amplifier per package.

6.2 ESD Ratings

			VALUE	UNIT
$V_{(ESD)}$	Electrostatic discharge	Human-body model (HBM), per AEC Q100-002 ⁽¹⁾ HBM ESD classification level 3A	±4000	V
		Charged-device model (CDM), per AEC Q100-011 CDM ESD classification level C6	±1000	

- (1) AEC Q100-002 indicates that HBM stressing shall be in accordance with the ANSI/ESDA/JEDEC JS-001 specification.

6.3 Recommended Operating Conditions

over operating free-air temperature range (unless otherwise noted)

		MIN	MAX	UNIT
$V_S = (V+) - (V-)$	Supply voltage	2.2 (±1.1)	5.5 (±2.75)	V
T_A	Operating temperature	-40	150	°C

6.4 Thermal Information: OPA376-Q1

THERMAL METRIC ⁽¹⁾		OPA376-Q1			UNIT
		DCK (SC70)	DBV (SOT-23)	D (SOIC)	
		5 PINS	5 PINS	8 PINS	
R _{θJA}	Junction-to-ambient thermal resistance	267	273.8	100.1	°C/W
R _{θJC(top)}	Junction-to-case (top) thermal resistance	80.9	126.8	42.4	°C/W
R _{θJB}	Junction-to-board thermal resistance	54.8	85.9	41	°C/W
ψ _{JT}	Junction-to-top characterization parameter	1.2	10.9	4.8	°C/W
ψ _{JB}	Junction-to-board characterization parameter	54.1	84.9	40.3	°C/W
R _{θJC(bot)}	Junction-to-case (bottom) thermal resistance	n/a	n/a	n/a	°C/W

(1) For more information about traditional and new thermal metrics, see the [Semiconductor and IC Package Thermal Metrics application report](#).

6.5 Thermal Information: OPA2376-Q1

THERMAL METRIC ⁽¹⁾		OPA2376-Q1		UNIT
		D (SOIC)	DGK (VSSOP)	
		8 PINS	8 PINS	
R _{θJA}	Junction-to-ambient thermal resistance	111.1	171.2	°C/W
R _{θJC(top)}	Junction-to-case (top) thermal resistance	54.7	63.9	°C/W
R _{θJB}	Junction-to-board thermal resistance	51.7	92.8	°C/W
ψ _{JT}	Junction-to-top characterization parameter	10.5	9.2	°C/W
ψ _{JB}	Junction-to-board characterization parameter	51.2	91.2	°C/W
R _{θJC(bot)}	Junction-to-case (bottom) thermal resistance	n/a	n/a	°C/W

(1) For more information about traditional and new thermal metrics, see the [Semiconductor and IC Package Thermal Metrics application report](#).

6.6 Thermal Information: OPA4376-Q1

THERMAL METRIC ⁽¹⁾		OPA4376-Q1	UNIT
		PW (TSSOP)	
		14 PINS	
R _{θJA}	Junction-to-ambient thermal resistance	107.8	°C/W
R _{θJC(top)}	Junction-to-case (top) thermal resistance	29.6	°C/W
R _{θJB}	Junction-to-board thermal resistance	52.6	°C/W
ψ _{JT}	Junction-to-top characterization parameter	1.5	°C/W
ψ _{JB}	Junction-to-board characterization parameter	51.6	°C/W
R _{θJC(bot)}	Junction-to-case (bottom) thermal resistance	n/a	°C/W

(1) For more information about traditional and new thermal metrics, see the [Semiconductor and IC Package Thermal Metrics application report](#).

6.7 Electrical Characteristics

at $T_A = 25^\circ\text{C}$, $R_L = 10\text{ k}\Omega$ connected to $V_S / 2$, $V_{CM} = V_S / 2$, and $V_{OUT} = V_S / 2$ (unless otherwise noted)

PARAMETER		TEST CONDITIONS		MIN	TYP	MAX	UNIT
OFFSET VOLTAGE							
V_{OS}	Input offset voltage				5	25	μV
dV_{OS}/dT	Input offset voltage versus temperature	$T_A = -40^\circ\text{C}$ to $+85^\circ\text{C}$			0.26	1	$\mu\text{V}/^\circ\text{C}$
		$T_A = -40^\circ\text{C}$ to $+125^\circ\text{C}$			0.32	2	$\mu\text{V}/^\circ\text{C}$
PSRR	Input offset voltage versus power supply	$V_S = 2.2\text{ V}$ to 5.5 V , $V_{CM} < (V+) - 1.3\text{ V}$	$T_A = 25^\circ\text{C}$		5	20	$\mu\text{V}/\text{V}$
			$T_A = -40^\circ\text{C}$ to $+125^\circ\text{C}$		5		$\mu\text{V}/\text{V}$
	Channel separation, dc (dual, quad)				0.5		$\mu\text{V}/\text{V}$
INPUT BIAS CURRENT							
I_B	Input bias current	$T_A = 25^\circ\text{C}$			0.2	10	pA
		$T_A = -40^\circ\text{C}$ to $+125^\circ\text{C}$			See セクション 6.8		pA
I_{OS}	Input offset current				0.2	10	pA
NOISE							
	Input voltage noise	$f = 0.1\text{ Hz}$ to 10 Hz			0.8		μV_{PP}
e_n	Input voltage noise density	$f = 1\text{ kHz}$			7.5		$\text{nV}/\sqrt{\text{Hz}}$
i_n	Input current noise	$f = 1\text{ kHz}$			2		$\text{fA}/\sqrt{\text{Hz}}$
INPUT VOLTAGE							
V_{CM}	Common-mode voltage	See 図 6-8		$(V-) - 0.1$		$(V+) + 0.1$	V
CMRR	Common-mode rejection ratio	$(V-) < V_{CM} < (V+) - 1.3\text{ V}$		76	90		dB
INPUT CAPACITANCE							
	Differential				6.5		pF
	Common-mode				13		pF
OPEN-LOOP GAIN							
A_{OL}	Open-loop voltage gain	$50\text{ mV} < V_O < (V+) - 50\text{ mV}$, $R_L = 10\text{ k}\Omega$		120	134		dB
		$100\text{ mV} < V_O < (V+) - 100\text{ mV}$, $R_L = 2\text{ k}\Omega$		120	126		dB
FREQUENCY RESPONSE							
GBW	Gain-bandwidth product	$C_L = 100\text{ pF}$, $V_S = 5.5\text{ V}$			5.5		MHz
SR	Slew rate	$G = 1$, $C_L = 100\text{ pF}$, $V_S = 5.5\text{ V}$			2		$\text{V}/\mu\text{s}$
t_s	Settling time	0.1%, 2-V Step, $G = 1$, $C_L = 100\text{ pF}$, $V_S = 5.5\text{ V}$			1.6		μs
		0.01%, 2-V Step, $G = 1$, $C_L = 100\text{ pF}$, $V_S = 5.5\text{ V}$			2		μs
	Overload recovery time	$V_{IN} \times \text{Gain} > V_S$			0.33		μs
THD+N	THD + noise	$V_O = 1\text{ V}_{RMS}$, $G = 1$, $f = 1\text{ kHz}$, $R_L = 10\text{ k}\Omega$			0.00027%		
OUTPUT							
	Voltage output swing from rail	$R_L = 10\text{ k}\Omega$	$T_A = 25^\circ\text{C}$		10	20	mV
			$T_A = -40^\circ\text{C}$ to $+125^\circ\text{C}$			40	mV
		$R_L = 2\text{ k}\Omega$	$T_A = 25^\circ\text{C}$		40	50	mV
			$T_A = -40^\circ\text{C}$ to $+125^\circ\text{C}$			80	mV
I_{SC}	Short-circuit current				30 / -50	mA	
C_{LOAD}	Capacitive load drive				See セクション 6.8		
R_O	Open-loop output impedance				150		Ω
POWER SUPPLY							
V_S	Specified voltage			2.2		5.5	V
	Operating voltage				2 to 5.5		V
I_Q	Quiescent current per amplifier	$I_O = 0$, $V_S = 5.5\text{ V}$, $V_{CM} < (V+) - 1.3\text{ V}$	$T_A = 25^\circ\text{C}$		760	950	μA
			$T_A = -40^\circ\text{C}$ to $+125^\circ\text{C}$			1	mA

6.8 Typical Characteristics

at $T_A = 25^\circ\text{C}$, $V_S = 5\text{ V}$, $R_L = 10\text{ k}\Omega$ connected to $V_S / 2$, $V_{CM} = V_S / 2$, and $V_{OUT} = V_S / 2$ (unless otherwise noted)

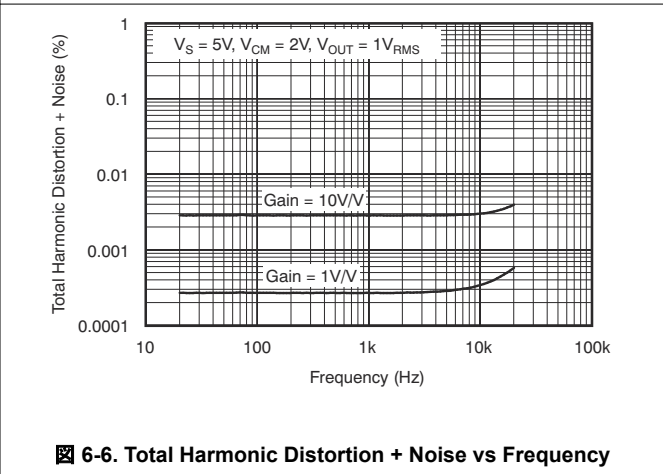
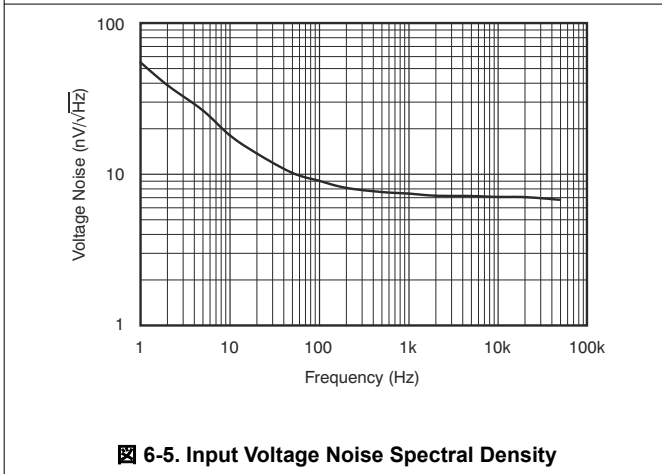
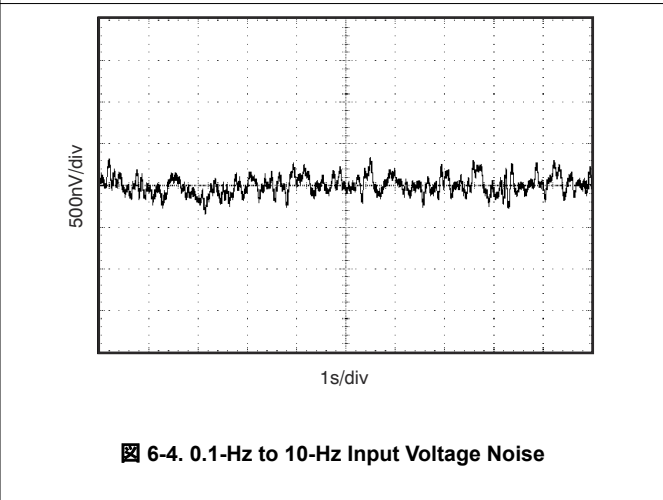
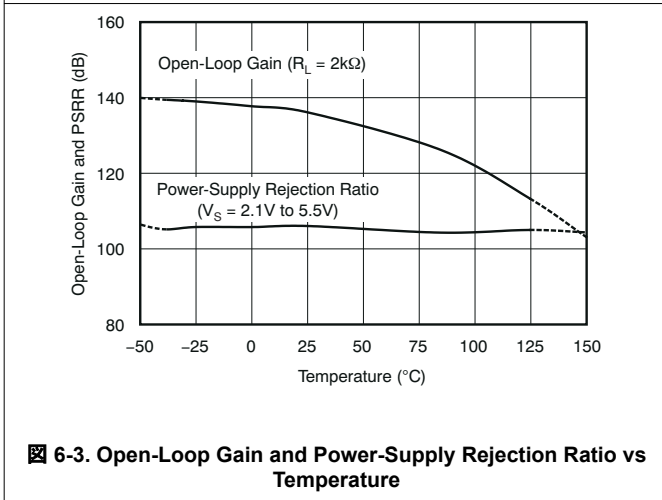
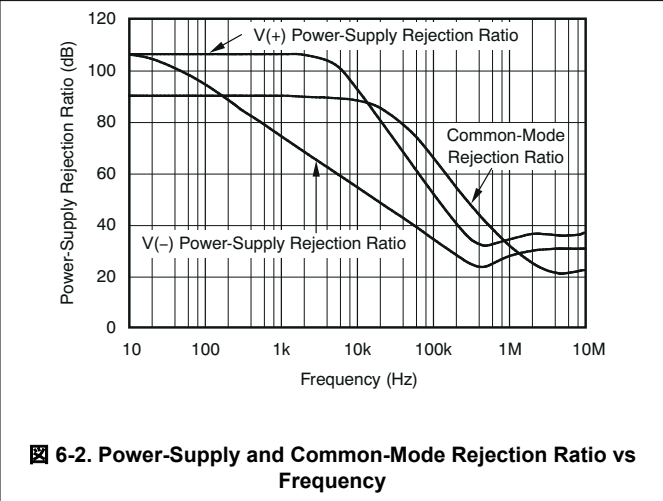
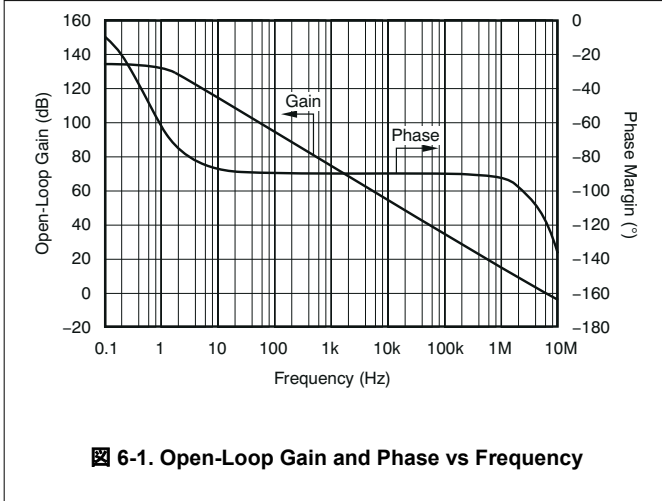

6.8 Typical Characteristics (continued)

at $T_A = 25^\circ\text{C}$, $V_S = 5\text{ V}$, $R_L = 10\text{ k}\Omega$ connected to $V_S / 2$, $V_{CM} = V_S / 2$, and $V_{OUT} = V_S / 2$ (unless otherwise noted)

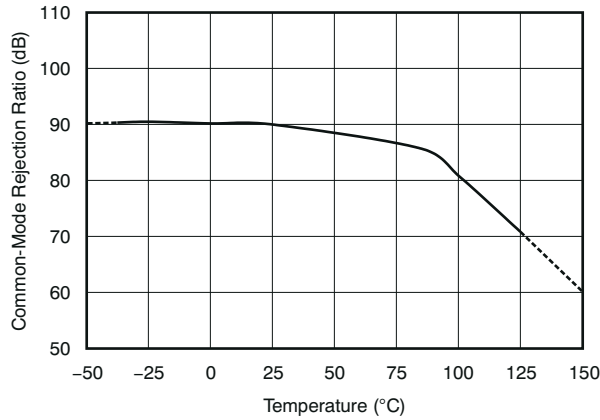

6-7. Common-Mode Rejection Ratio vs Temperature

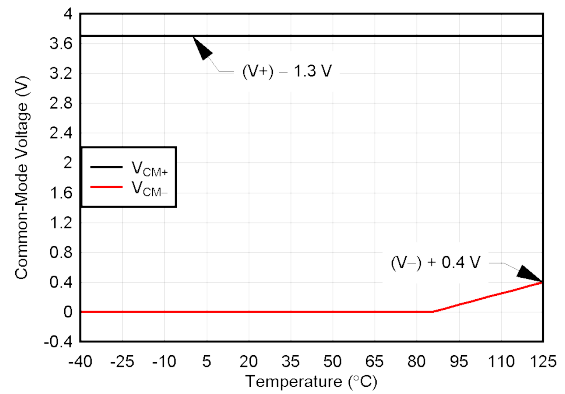

V_{CM} range for typical CMRR = 90 dB

6-8. Common-Mode Voltage vs Temperature

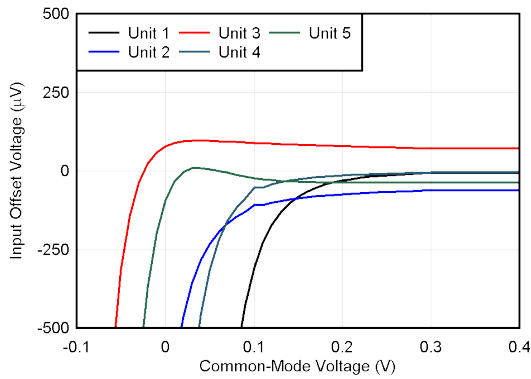

$(V_-) = 0\text{ V}$ $T_A = 125^\circ\text{C}$

6-9. Offset Voltage vs Common-Mode Voltage

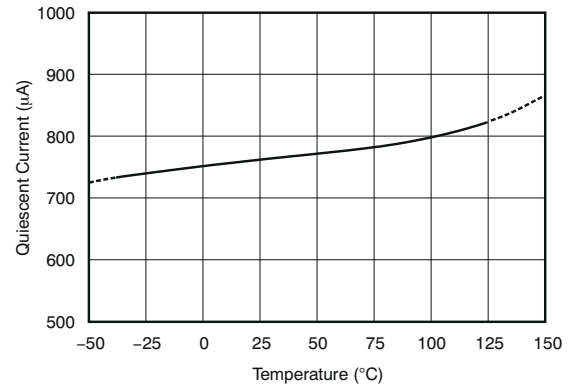

6-10. Quiescent Current vs Temperature

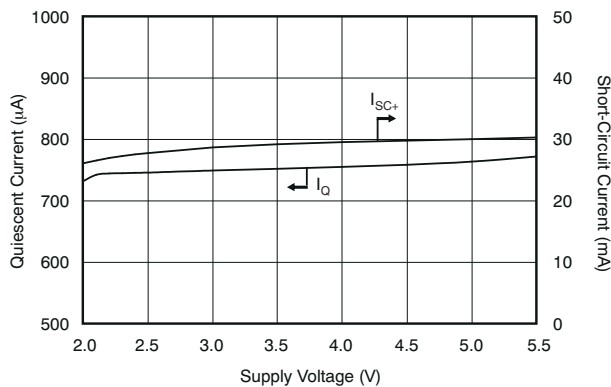

6-11. Quiescent and Short-Circuit Current vs Supply Voltage

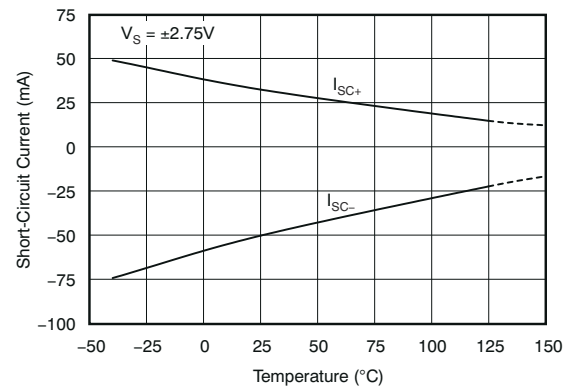

6-12. Short-Circuit Current vs Temperature

6.8 Typical Characteristics (continued)

at $T_A = 25^\circ\text{C}$, $V_S = 5\text{ V}$, $R_L = 10\text{ k}\Omega$ connected to $V_S / 2$, $V_{CM} = V_S / 2$, and $V_{OUT} = V_S / 2$ (unless otherwise noted)

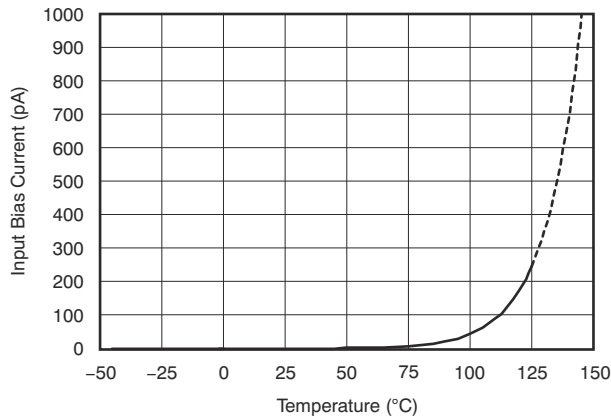

6-13. Input Bias Current vs Temperature

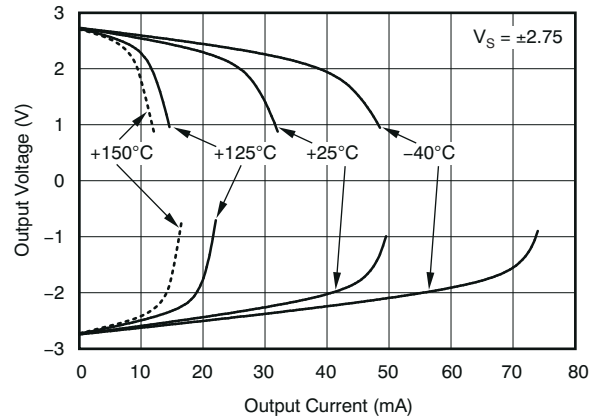

6-14. Output Voltage vs Output Current

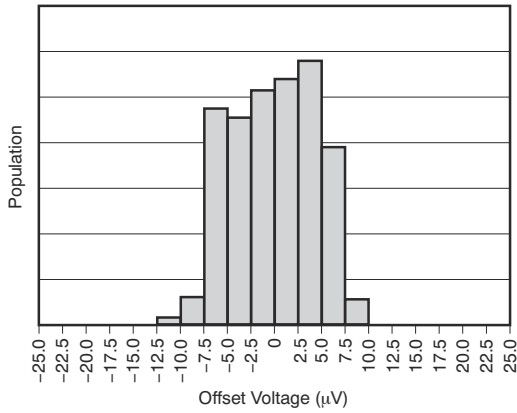

6-15. Offset Voltage Production Distribution

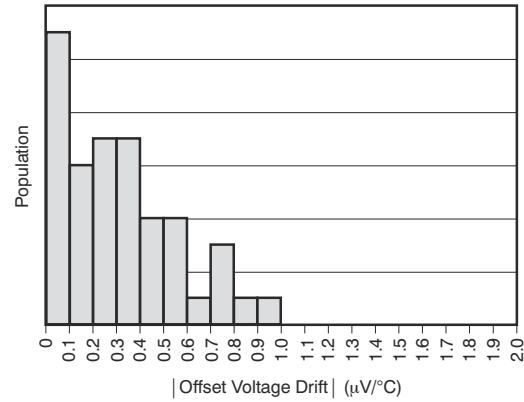

6-16. Offset Voltage Drift Production Distribution (-40°C to +125°C)

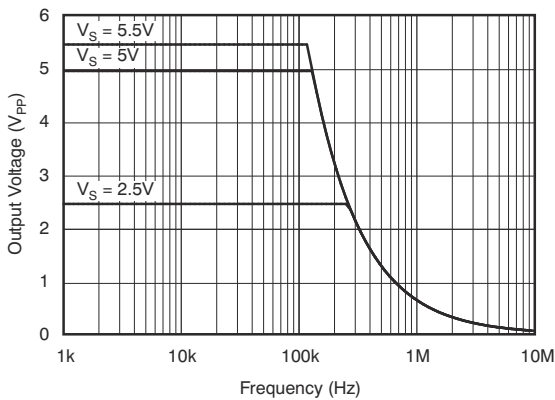

6-17. Maximum Output Voltage vs Frequency

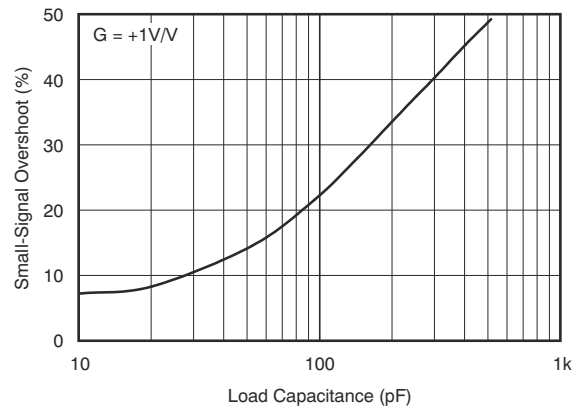

6-18. Small-Signal Overshoot vs Load Capacitance

6.8 Typical Characteristics (continued)

at $T_A = 25^\circ\text{C}$, $V_S = 5\text{ V}$, $R_L = 10\text{ k}\Omega$ connected to $V_S / 2$, $V_{CM} = V_S / 2$, and $V_{OUT} = V_S / 2$ (unless otherwise noted)

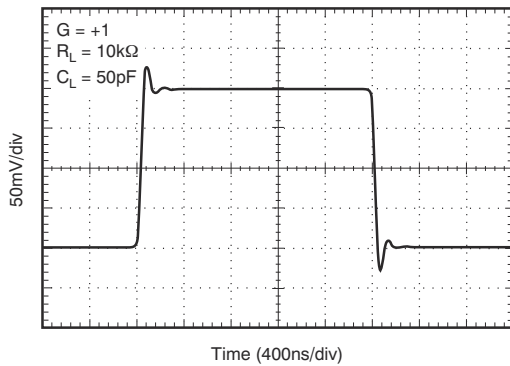

6-19. Small-Signal Pulse Response

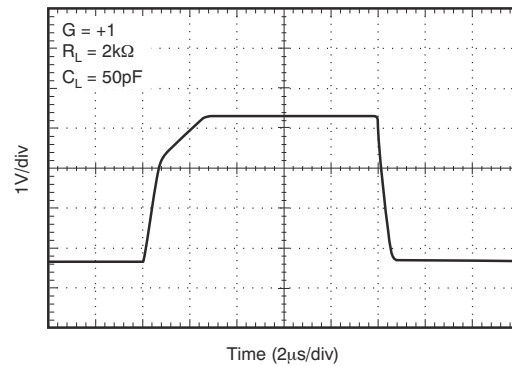

6-20. Large-Signal Pulse Response

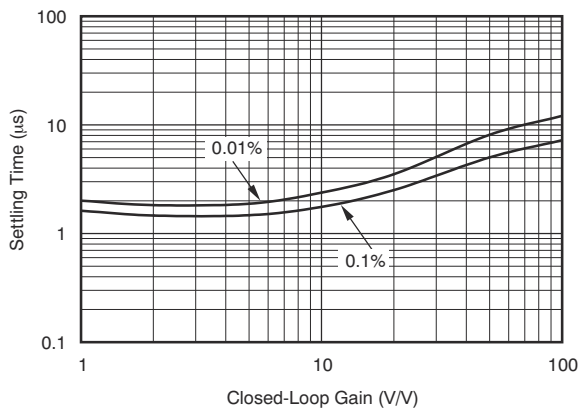

6-21. Settling Time vs Closed-Loop Gain

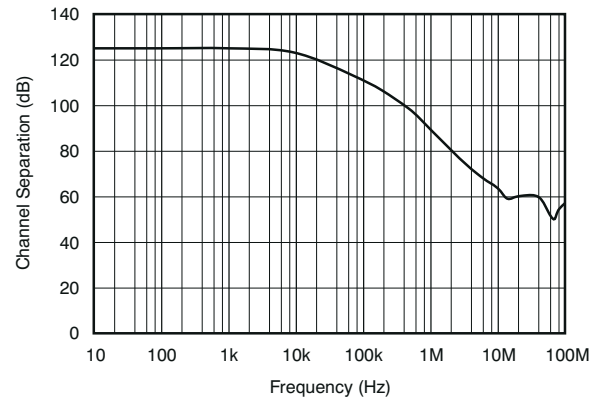

6-22. Channel Separation vs Frequency

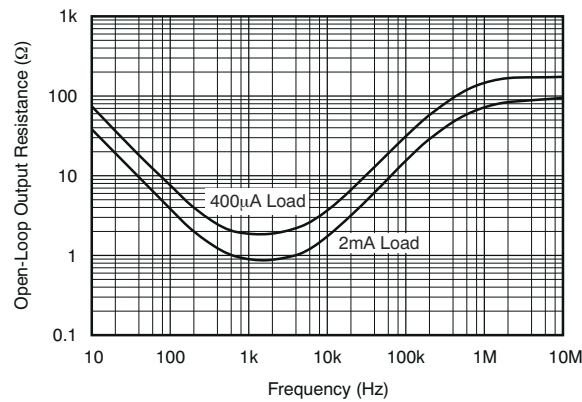

6-23. Open-Loop Output Resistance vs Frequency

7 Detailed Description

7.1 Overview

The OPAx376-Q1 family belongs to a new generation of low-noise e-trim operational amplifiers, giving customers outstanding dc precision and ac performance. Low noise, rail-to-rail input and output, low offset, and drawing a low quiescent current, make these devices an excellent choice for a variety of precision and portable applications. In addition, these devices have a wide supply range with excellent PSRR, making the OPAx376-Q1 a great option for applications that are battery powered without regulation.

7.2 Functional Block Diagram

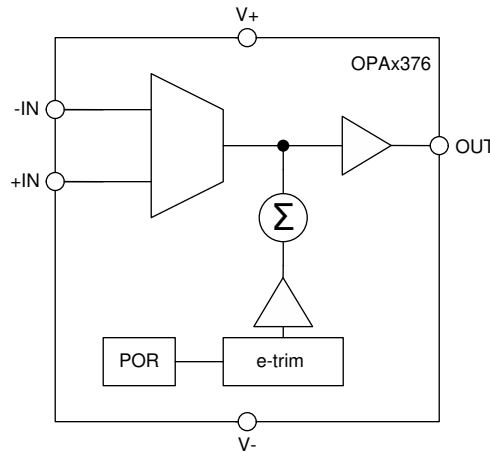

7.3 Feature Description

The OPAx376-Q1 family of precision amplifiers offers excellent dc performance as well as excellent ac performance. Operating from a single power-supply the OPAx376-Q1 is capable of driving large capacitive loads, has a wide input common-mode voltage range, and is well-suited to drive the inputs of successive-approximation response (SAR) analog-to-digital converters (ADCs) as well as 24-bit and higher resolution converters. Including internal ESD protection, the OPAx376-Q1 family is offered in a variety of industry-standard packages, including a wafer chip-scale package for applications that require space savings.

7.3.1 Operating Voltage

The OPAx376-Q1 family of amplifiers operate over a power-supply range of 2.2 V to 5.5 V (± 1.1 V to ± 2.75 V). Many of the specifications apply from -40°C to $+125^{\circ}\text{C}$. Parameters that can exhibit significant variance with regard to operating voltage or temperature are presented in [セクション 6.8](#).

7.3.2 Input Offset Voltage and Input Offset Voltage Drift

The OPAx376-Q1 family of e-trim operational amplifiers is manufactured using TI's proprietary trim technology, a method of trimming internal device parameters during either wafer probing or final testing. Each amplifier is trimmed in production, thereby minimizing errors associated with input offset voltage and input offset voltage drift.

7.3.3 Capacitive Load and Stability

The OPAx376-Q1 series of amplifiers may be used in applications where driving a capacitive load is required. As with all op amps, there may be specific instances where the OPAx376-Q1 can become unstable, leading to oscillation. The particular op amp circuit configuration, layout, gain, and output loading are some of the factors to consider when establishing whether an amplifier is be stable in operation. An op amp in the unity-gain (1 V/V) buffer configuration and driving a capacitive load exhibits a greater tendency to be unstable than an amplifier operated at a higher noise gain. The capacitive load, in conjunction with the op amp output resistance, creates a pole within the feedback loop that degrades the phase margin. The degradation of the phase margin increases as the capacitive loading increases.

The OPAx376 in a unity-gain configuration can directly drive up to 250 pF of pure capacitive load. Increasing the gain enhances the ability of the amplifier to drive greater capacitive loads; see the typical characteristic plot [Figure 6-18, Small-Signal Overshoot vs Load Capacitance](#). In unity-gain configurations, capacitive load drive can be improved by inserting a small (10-Ω to 20-Ω) resistor, R_S , in series with the output, as shown in [Figure 7-1](#). This resistor significantly reduces ringing while maintaining dc performance for purely capacitive loads. However, if there is a resistive load in parallel with the capacitive load, a voltage divider is created, introducing a gain error at the output and slightly reducing the output swing. The error introduced is proportional to the ratio R_S / R_L , and is generally negligible at low output current levels.

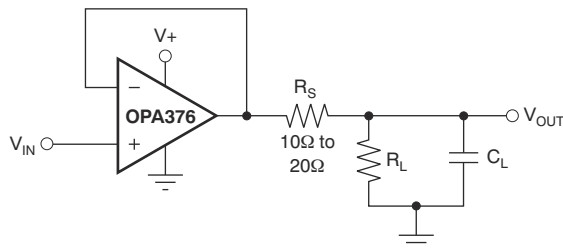

Figure 7-1. Improving Capacitive Load Drive

7.3.4 Common-Mode Voltage Range

The input common-mode voltage range of the OPAx376-Q1 series extends 100 mV beyond the supply rails. The offset voltage of the amplifier is very low, from approximately $(V-)$ to $(V+) - 1$ V, as shown in [Figure 7-2](#). The offset voltage increases as common-mode voltage exceeds $(V+) - 1$ V. Common-mode rejection is specified from $(V-)$ to $(V+) - 1.3$ V.

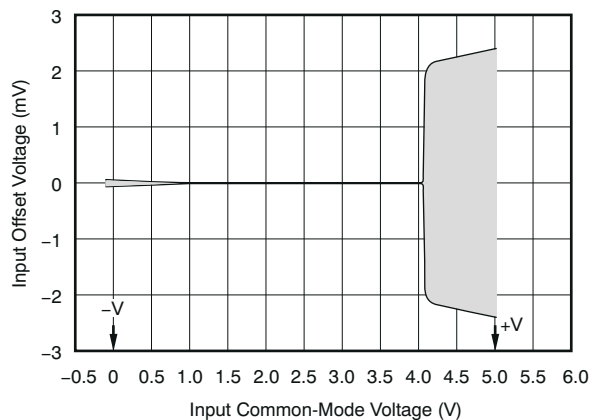
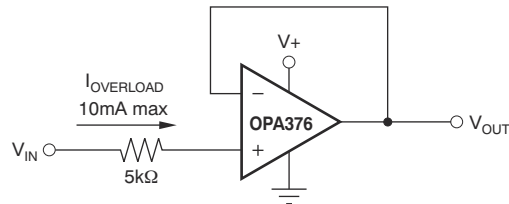

Figure 7-2. Offset and Common-Mode Voltage

7.3.5 Input and ESD Protection

The OPAx376-Q1 family incorporates internal electrostatic discharge (ESD) protection circuits on all pins. In the case of input and output pins, this protection primarily consists of current steering diodes connected between the input and power-supply pins. These ESD protection diodes also provide in-circuit, input overdrive protection, as long as the current is limited to 10 mA as stated in [セクション 6.1](#).

☒ **7-3** shows how a series input resistor may be added to the driven input to limit the input current. The added resistor contributes thermal noise at the amplifier input and its value must be kept to a minimum in noise-sensitive applications.



☒ **7-3. Input Current Protection**

7.4 Device Functional Modes

The OPAx376-Q1 has a single functional mode and is operational when the power-supply voltage is greater than 2.2 V (± 1.1 V). The maximum power supply voltage for the OPAx376-Q1 is 5.5 V (± 2.75 V).

8 Application and Implementation

注

以下のアプリケーション情報は、TI の製品仕様に含まれるものではなく、TI ではその正確性または完全性を保証いたしません。個々の目的に対する製品の適合性については、お客様の責任で判断していただくこととなります。また、お客様は自身の設計実装を検証しテストすることで、システムの機能を確認する必要があります。

8.1 Application Information

The OPAx376-Q1 family of e-trim operational amplifiers is built using a proprietary technique in which offset voltage is adjusted during the final steps of manufacturing. This technique compensates for performance shifts that can occur during the molding process. Through *e-trim* operational amplifier technology, the OPAx376-Q1 family delivers excellent offset voltage (5 μV , typical). Additionally, the amplifier boasts a fast slew rate, low drift, low noise, and excellent PSRR and A_{OL} . These 5.5-MHz CMOS op amps operate on 760 μA (typical) quiescent current.

8.1.1 Basic Amplifier Configurations

The OPAx376-Q1 family is unity-gain stable. It does not exhibit output phase inversion when the input is overdriven. A typical single-supply connection is shown in [Figure 8-1](#). The OPA376-Q1 is configured as a basic inverting amplifier with a gain of -10 V/V . This single-supply connection has an output centered on the common-mode voltage, V_{CM} . For the circuit shown in [Figure 8-1](#), this voltage is 2.5 V, but may be any value within the common-mode input voltage range.

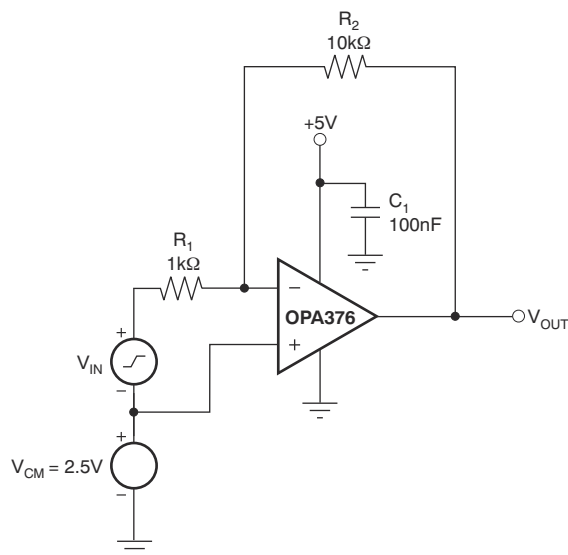

Figure 8-1. Basic Single-Supply Connection

8.1.2 Active Filtering

The OPA376-Q1 series is well-suited for filter applications requiring a wide bandwidth, fast slew rate, low-noise, single-supply operational amplifier. [Figure 8-2](#) shows a 50-kHz, second-order, low-pass filter. The components have been selected to provide a maximally-flat Butterworth response. Beyond the cutoff frequency, roll-off is -40 dB/dec. The Butterworth response is ideal for applications requiring predictable gain characteristics such as the anti-aliasing filter used ahead of an ADC.

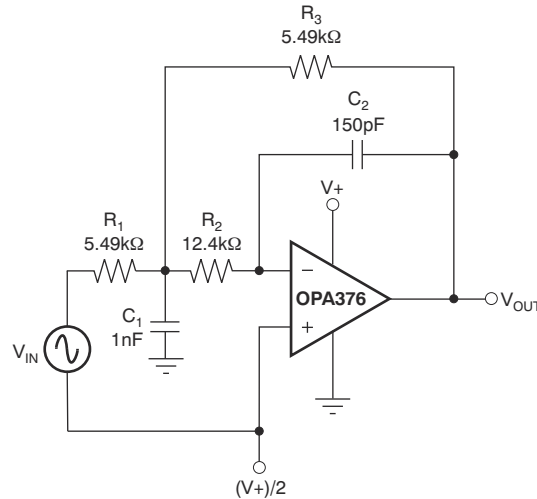
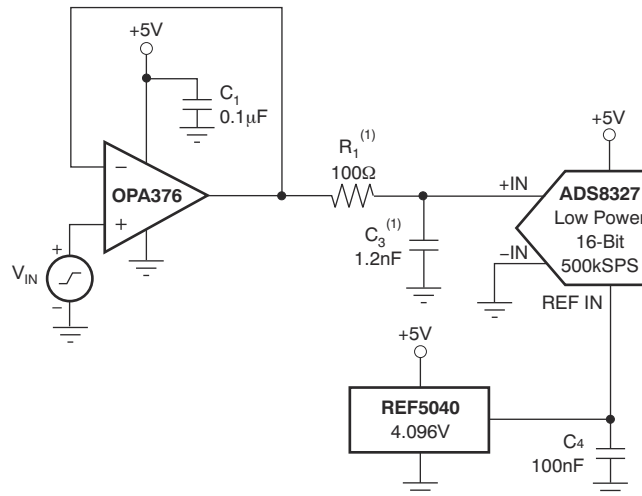

Figure 8-2. Second-Order Butterworth, 50-kHz Low-Pass Filter

8.1.3 Driving an Analog-to-Digital Converter

The low noise and wide gain bandwidth of the OPA376-Q1 family make it an ideal driver for ADCs. [Figure 8-3](#) illustrates the OPA376-Q1 driving an [ADS8327](#), 16-bit, 250-kSPS converter. The amplifier is connected as a unity-gain, noninverting buffer.



(1) Suggested value; may require adjustment based on specific application.

Figure 8-3. Driving an ADS8327

8.1.4 Phantom-Powered Microphone

The circuit shown in [Figure 8-4](#) depicts how a remote microphone amplifier can be powered by a phantom source on the output side of the signal cable. The cable serves double duty, carrying both the differential output signal from and dc power to the microphone amplifier stage.

An OPA2376-Q1 serves as a single-ended input to a differential output amplifier with a 6-dB gain. Common-mode bias for the two op amps is provided by the dc voltage developed across the electret microphone element. A 48-V phantom supply is reduced to 5.1 V by the series 6.8-k Ω resistors on the output side of the cable, and the 4.7-k Ω resistors and zener diode on the input side of the cable. AC coupling blocks the different dc voltage levels from each other on each end of the cable.

An INA163 instrumentation amplifier provides differential inputs and receives the balanced audio signals from the cable.

The INA163 gain may be set from 0 dB to 80 dB by selecting the R_G value. The INA163 circuit is typical of the input circuitry used in mixing consoles.

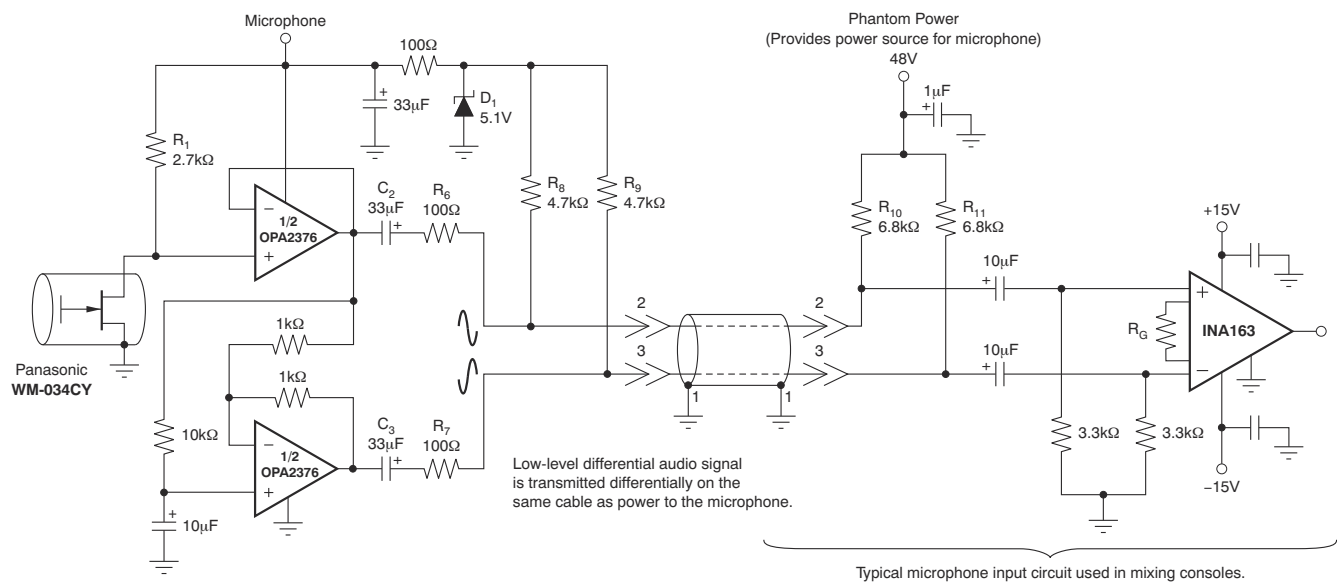
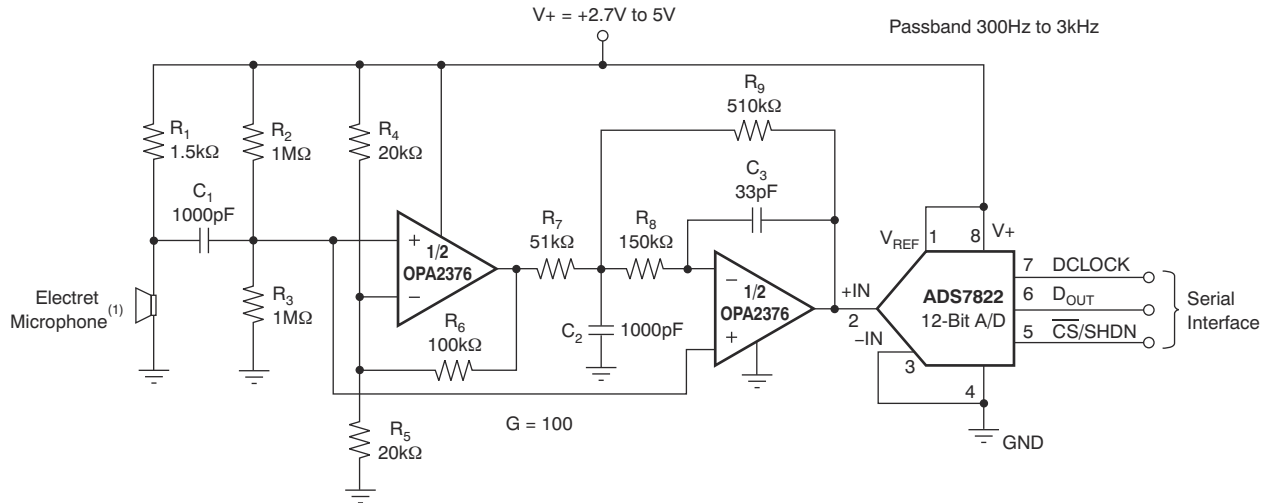

Figure 8-4. Phantom-Powered Electret Microphone

8.1.5 Speech Bandpass-Filtered Data Acquisition System

 8-5 illustrates the OPA2376-Q1 driving a speech bandpass-filtered data acquisition system.



(1) Electret microphone powered by R_1 .

8-5. OPA2376-Q1 as a Speech Bandpass-Filtered Data Acquisition System

8.2 Typical Application

Low-pass filters are commonly employed in signal processing applications to reduce noise and prevent aliasing. The OPA376-Q1 is ideally suited to construct high-speed, high-precision active filters.  8-6 shows a second-order, low-pass filter commonly encountered in signal processing applications.

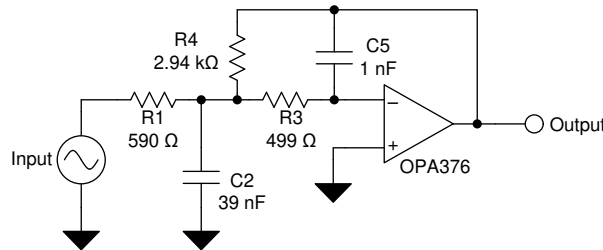

8-6. Typical Application Schematic

8.2.1 Design Requirements

Use the following parameters for this design example:

- Gain = 5 V/V (inverting gain)
- Low-pass cutoff frequency = 25 kHz
- Second-order Chebyshev filter response with 3-dB gain peaking in the passband

8.2.2 Detailed Design Procedure

The infinite-gain multiple-feedback circuit for a low-pass network function is shown in [Figure 8-6](#). Use [Equation 1](#) to calculate the voltage transfer function.

$$\frac{\text{Output}}{\text{Input}}(s) = \frac{-1/R_1 R_3 C_2 C_5}{s^2 + (s/C_2)(1/R_1 + 1/R_3 + 1/R_4) + 1/R_3 R_4 C_2 C_5} \quad (1)$$

This circuit produces a signal inversion. For this circuit, the gain at dc and the low-pass cutoff frequency are calculated by [Equation 2](#):

$$\text{Gain} = \frac{R_4}{R_1}$$

$$f_c = \frac{1}{2\pi} \sqrt{(1/R_3 R_4 C_2 C_5)} \quad (2)$$

Software tools are readily available to simplify filter design. [WEBENCH® Filter Designer](#) is a simple, powerful, and easy-to-use active filter design program. The WEBENCH Filter Designer lets you create optimized filter designs using a selection of TI operational amplifiers and passive components from TI's vendor partners.

Available as a web-based tool from the WEBENCH® Design Center, [WEBENCH® Filter Designer](#) allows you to design, optimize, and simulate complete multi-stage active filter solutions within minutes.

8.2.3 Application Curve

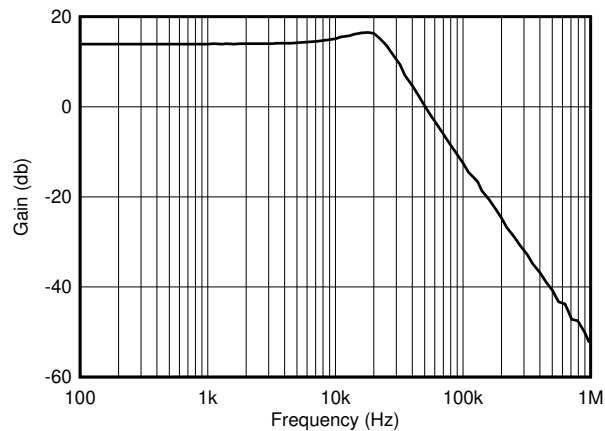

Figure 8-7. Low-Pass Filter Transfer Function

9 Power Supply Recommendations

The OPAx376-Q1 family of devices is specified for operation from 2.2 V to 5.5 V (± 1.1 V to ± 2.75 V); many specifications apply from -40°C to $+125^\circ\text{C}$. Parameters that can exhibit significant variance with regard to operating voltage or temperature are presented in [Section 6.8](#).

10 Layout

10.1 Layout Guidelines

For best operational performance of the device, use good printed circuit board (PCB) layout practices, including:

- Noise can propagate into analog circuitry through the power pins of the circuit as a whole and op amp itself. Bypass capacitors are used to reduce the coupled noise by providing low-impedance power sources local to the analog circuitry.
 - Connect low-ESR, 0.1- μ F ceramic bypass capacitors between each supply pin and ground, placed as close to the device as possible. A single bypass capacitor from V+ to ground is applicable for single-supply applications.
- Separate grounding for analog and digital portions of circuitry is one of the simplest and most-effective methods of noise suppression. One or more layers on multilayer PCBs are usually devoted to ground planes. A ground plane helps distribute heat and reduces EMI noise pickup. Make sure to physically separate digital and analog grounds paying attention to the flow of the ground current. For more detailed information refer to the [Circuit Board Layout Techniques application report](#).
- In order to reduce parasitic coupling, run the input traces as far away from the supply or output traces as possible. If these traces cannot be kept separate, crossing the sensitive trace perpendicular is much better as opposed to in parallel with the noisy trace.
- Place the external components as close to the device as possible. As shown in [Figure 10-1](#), keeping RF and RG close to the inverting input minimizes parasitic capacitance.
- Keep the length of input traces as short as possible. Always remember that the input traces are the most sensitive part of the circuit.
- Consider a driven, low-impedance guard ring around the critical traces. A guard ring can significantly reduce leakage currents from nearby traces that are at different potentials.
- Cleaning the PCB following board assembly is recommended for best performance.
- Any precision integrated circuit may experience performance shifts due to moisture ingress into the plastic package. Following any aqueous PCB cleaning process, baking the PCB assembly is recommended to remove moisture introduced into the device packaging during the cleaning process. A low-temperature, post-cleaning bake at 85°C for 30 minutes is sufficient for most circumstances.

10.2 Layout Example

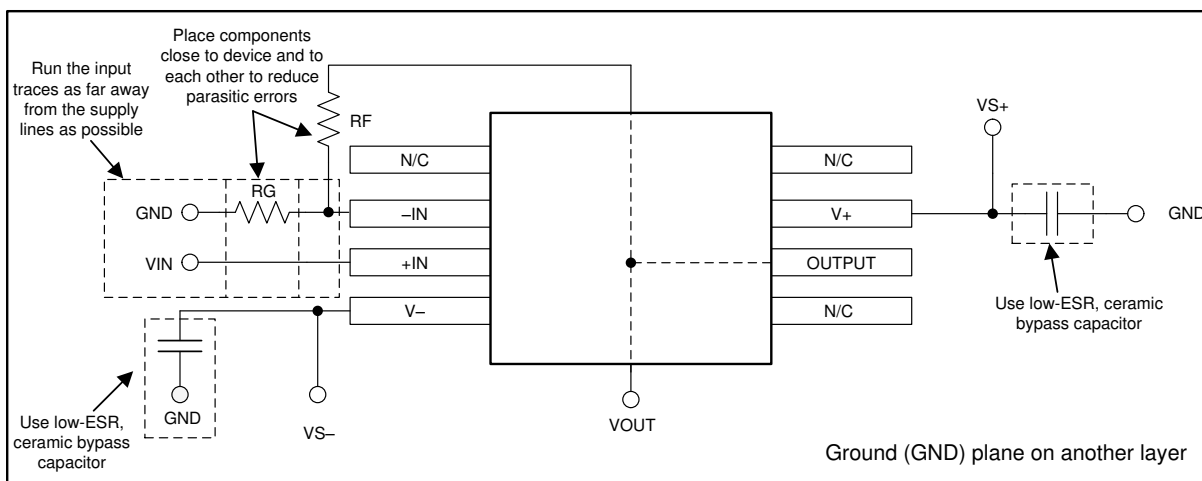
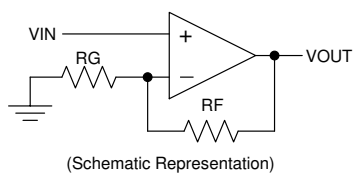

Figure 10-1. Layout Example

11 Device and Documentation Support

11.1 Device Support

11.1.1 Development Support

11.1.1.1 TINA-TI™ Simulation Software (Free Download)

TINA™ is a simple, powerful, and easy-to-use circuit simulation program based on a SPICE engine. TINA-TI™ simulation software is a free, fully-functional version of the TINA software, preloaded with a library of macro models in addition to a range of both passive and active models. TINA-TI simulation software provides all the conventional dc, transient, and frequency domain analysis of SPICE, as well as additional design capabilities.

Available as a [free download](#) from the Analog eLab Design Center, TINA-TI simulation software offers extensive post-processing capability that allows users to format results in a variety of ways. Virtual instruments offer the ability to select input waveforms and probe circuit nodes, voltages, and waveforms, creating a dynamic quick-start tool.

注

These files require that either the TINA software (from DesignSoft™) or TINA-TI software be installed. Download the free TINA-TI software from the [TINA-TI folder](#).

11.1.1.2 TI Precision Designs

TI Precision Designs are analog solutions created by TI's precision analog applications experts and offer the theory of operation, component selection, simulation, complete PCB schematic and layout, bill of materials, and measured performance of many useful circuits. TI Precision Designs are available online at <http://www.ti.com/ww/en/analog/precision-designs/>.

11.1.1.3 WEBENCH® Filter Designer

WEBENCH® Filter Designer is a simple, powerful, and easy-to-use active filter design program. The WEBENCH® Filter Designer lets you create optimized filter designs using a selection of TI operational amplifiers and passive components from TI's vendor partners.

Available as a web-based tool from the WEBENCH® Design Center, [WEBENCH® Filter Designer](#) allows you to design, optimize, and simulate complete multistage active filter solutions within minutes.

11.2 Documentation Support

11.2.1 Related Documentation

For related documentation see the following:

- Texas Instruments, [INA163 Low-Noise, Low-Distortion Instrumentation Amplifier data sheet](#)
- Texas Instruments, [Operational Amplifier Gain stability, Part 3: AC Gain-Error Analysis](#)
- Texas Instruments, [Operational Amplifier Gain Stability, Part 2: DC Gain-Error Analysis](#)
- Texas Instruments, [Op Amp Performance Analysis](#)
- Texas Instruments, [Shelf-Life Evaluation of Lead-Free Component Finishes](#)
- Texas Instruments, [Single-Supply Operation of Operational Amplifiers](#)
- Texas Instruments, [Tuning in Amplifiers](#)
- Texas Instruments, [Using Infinite-Gain, MFB Filter Topology in Fully Differential Active Filters](#)

11.3 ドキュメントの更新通知を受け取る方法

ドキュメントの更新についての通知を受け取るには、ti.com のデバイス製品フォルダを開いてください。「更新の通知を受け取る」をクリックして登録すると、変更されたすべての製品情報に関するダイジェストを毎週受け取れます。変更の詳細については、修正されたドキュメントに含まれている改訂履歴をご覧ください。

11.4 サポート・リソース

TI E2E™ サポート・フォーラムは、エンジニアが検証済みの回答と設計に関するヒントをエキスパートから迅速かつ直接得ることができる場所です。既存の回答を検索したり、独自の質問をしたりすることで、設計に必要な支援を迅速に得ることができます。

リンクされているコンテンツは、該当する貢献者により、現状のまま提供されるものです。これらは TI の仕様を構成するものではなく、必ずしも TI の見解を反映したものではありません。TI の [使用条件](#) を参照してください。

11.5 Trademarks

e-trim™, TINA-TI™, and TI E2E™ are trademarks of Texas Instruments.

TINA™ and DesignSoft™ are trademarks of DesignSoft, Inc.

WEBENCH® is a registered trademark of Texas Instruments.

すべての商標は、それぞれの所有者に帰属します。

11.6 静電気放電に関する注意事項



この IC は、ESD によって破損する可能性があります。テキサス・インスツルメンツは、IC を取り扱う際には常に適切な注意を払うことを推奨します。正しい ESD 対策をとらないと、デバイスを破損するおそれがあります。

ESD による破損は、わずかな性能低下からデバイスの完全な故障まで多岐にわたります。精密な IC の場合、パラメータがわずかに変化するだけで公表されている仕様から外れる可能性があるため、破損が発生しやすくなっています。

11.7 用語集

TI 用語集 この用語集には、用語や略語の一覧および定義が記載されています。

12 Mechanical, Packaging, and Orderable Information

The following pages include mechanical, packaging, and orderable information. This information is the most current data available for the designated devices. This data is subject to change without notice and revision of this document. For browser-based versions of this data sheet, refer to the left-hand navigation.

PACKAGING INFORMATION

Orderable part number	Status (1)	Material type (2)	Package Pins	Package qty Carrier	RoHS (3)	Lead finish/ Ball material (4)	MSL rating/ Peak reflow (5)	Op temp (°C)	Part marking (6)
OPA2376AQDRQ1	Active	Production	SOIC (D) 8	2500 LARGE T&R	Yes	NIPDAU	Level-2-260C-1 YEAR	-40 to 125	2376Q1
OPA2376AQDRQ1.A	Active	Production	SOIC (D) 8	2500 LARGE T&R	Yes	NIPDAU	Level-2-260C-1 YEAR	-40 to 125	2376Q1
OPA2376AQDRQ1.B	Active	Production	SOIC (D) 8	2500 LARGE T&R	Yes	NIPDAU	Level-2-260C-1 YEAR	-40 to 125	2376Q1
OPA2376QDGKRQ1	Active	Production	VSSOP (DGK) 8	2500 LARGE T&R	Yes	NIPDAU NIPDAUAG	Level-2-260C-1 YEAR	-40 to 125	2376
OPA2376QDGKRQ1.A	Active	Production	VSSOP (DGK) 8	2500 LARGE T&R	Yes	NIPDAUAG	Level-2-260C-1 YEAR	-40 to 125	2376
OPA2376QDGKRQ1.B	Active	Production	VSSOP (DGK) 8	2500 LARGE T&R	Yes	NIPDAUAG	Level-2-260C-1 YEAR	-40 to 125	2376
OPA376AQDBVRQ1	Active	Production	SOT-23 (DBV) 5	3000 LARGE T&R	Yes	NIPDAU	Level-2-260C-1 YEAR	-40 to 125	OUHQ
OPA376AQDBVRQ1.A	Active	Production	SOT-23 (DBV) 5	3000 LARGE T&R	Yes	NIPDAU	Level-2-260C-1 YEAR	-40 to 125	OUHQ
OPA376AQDBVRQ1G4	Active	Production	SOT-23 (DBV) 5	3000 LARGE T&R	Yes	NIPDAU	Level-2-260C-1 YEAR	-40 to 125	OUHQ
OPA376AQDBVRQ1G4.A	Active	Production	SOT-23 (DBV) 5	3000 LARGE T&R	Yes	NIPDAU	Level-2-260C-1 YEAR	-40 to 125	OUHQ
OPA4376AQPWRQ1	Active	Production	TSSOP (PW) 14	2000 LARGE T&R	Yes	NIPDAU	Level-2-260C-1 YEAR	-40 to 125	4376Q1
OPA4376AQPWRQ1.B	Active	Production	TSSOP (PW) 14	2000 LARGE T&R	Yes	NIPDAU	Level-2-260C-1 YEAR	-40 to 125	4376Q1

(1) **Status:** For more details on status, see our [product life cycle](#).

(2) **Material type:** When designated, preproduction parts are prototypes/experimental devices, and are not yet approved or released for full production. Testing and final process, including without limitation quality assurance, reliability performance testing, and/or process qualification, may not yet be complete, and this item is subject to further changes or possible discontinuation. If available for ordering, purchases will be subject to an additional waiver at checkout, and are intended for early internal evaluation purposes only. These items are sold without warranties of any kind.

(3) **RoHS values:** Yes, No, RoHS Exempt. See the [TI RoHS Statement](#) for additional information and value definition.

(4) **Lead finish/Ball material:** Parts may have multiple material finish options. Finish options are separated by a vertical ruled line. Lead finish/Ball material values may wrap to two lines if the finish value exceeds the maximum column width.

(5) **MSL rating/Peak reflow:** The moisture sensitivity level ratings and peak solder (reflow) temperatures. In the event that a part has multiple moisture sensitivity ratings, only the lowest level per JEDEC standards is shown. Refer to the shipping label for the actual reflow temperature that will be used to mount the part to the printed circuit board.

(6) **Part marking:** There may be an additional marking, which relates to the logo, the lot trace code information, or the environmental category of the part.

Multiple part markings will be inside parentheses. Only one part marking contained in parentheses and separated by a "-" will appear on a part. If a line is indented then it is a continuation of the previous line and the two combined represent the entire part marking for that device.

Important Information and Disclaimer:The information provided on this page represents TI's knowledge and belief as of the date that it is provided. TI bases its knowledge and belief on information provided by third parties, and makes no representation or warranty as to the accuracy of such information. Efforts are underway to better integrate information from third parties. TI has taken and continues to take reasonable steps to provide representative and accurate information but may not have conducted destructive testing or chemical analysis on incoming materials and chemicals. TI and TI suppliers consider certain information to be proprietary, and thus CAS numbers and other limited information may not be available for release.

In no event shall TI's liability arising out of such information exceed the total purchase price of the TI part(s) at issue in this document sold by TI to Customer on an annual basis.

OTHER QUALIFIED VERSIONS OF OPA2376-Q1, OPA376-Q1, OPA4376-Q1 :

- Catalog : [OPA2376](#), [OPA376](#), [OPA4376](#)

NOTE: Qualified Version Definitions:

- Catalog - TI's standard catalog product

TAPE AND REEL INFORMATION

QUADRANT ASSIGNMENTS FOR PIN 1 ORIENTATION IN TAPE

*All dimensions are nominal

Device	Package Type	Package Drawing	Pins	SPQ	Reel Diameter (mm)	Reel Width W1 (mm)	A0 (mm)	B0 (mm)	K0 (mm)	P1 (mm)	W (mm)	Pin1 Quadrant
OPA2376AQDRQ1	SOIC	D	8	2500	330.0	12.4	6.4	5.2	2.1	8.0	12.0	Q1
OPA2376QDGKRQ1	VSSOP	DGK	8	2500	330.0	12.4	5.3	3.4	1.4	8.0	12.0	Q1
OPA2376QDGKRQ1	VSSOP	DGK	8	2500	330.0	12.4	5.3	3.4	1.4	8.0	12.0	Q1
OPA376AQDBVRQ1	SOT-23	DBV	5	3000	179.0	8.4	3.2	3.2	1.4	4.0	8.0	Q3
OPA376AQDBVRQ1G4	SOT-23	DBV	5	3000	179.0	8.4	3.2	3.2	1.4	4.0	8.0	Q3
OPA4376AQPWRQ1	TSSOP	PW	14	2000	330.0	12.4	6.9	5.6	1.6	8.0	12.0	Q1

TAPE AND REEL BOX DIMENSIONS

*All dimensions are nominal

Device	Package Type	Package Drawing	Pins	SPQ	Length (mm)	Width (mm)	Height (mm)
OPA2376AQDRQ1	SOIC	D	8	2500	353.0	353.0	32.0
OPA2376QDGKRQ1	VSSOP	DGK	8	2500	353.0	353.0	32.0
OPA2376QDGKRQ1	VSSOP	DGK	8	2500	366.0	364.0	50.0
OPA376AQDBVRQ1	SOT-23	DBV	5	3000	213.0	191.0	35.0
OPA376AQDBVRQ1G4	SOT-23	DBV	5	3000	213.0	191.0	35.0
OPA4376AQPWRQ1	TSSOP	PW	14	2000	353.0	353.0	32.0

EXAMPLE BOARD LAYOUT

DBV0005A

SOT-23 - 1.45 mm max height

SMALL OUTLINE TRANSISTOR



LAND PATTERN EXAMPLE
EXPOSED METAL SHOWN
SCALE:15X



SOLDER MASK DETAILS

4214839/K 08/2024

NOTES: (continued)

- 6. Publication IPC-7351 may have alternate designs.
- 7. Solder mask tolerances between and around signal pads can vary based on board fabrication site.

EXAMPLE STENCIL DESIGN

DBV0005A

SOT-23 - 1.45 mm max height

SMALL OUTLINE TRANSISTOR



SOLDER PASTE EXAMPLE
BASED ON 0.125 mm THICK STENCIL
SCALE:15X

4214839/K 08/2024

NOTES: (continued)

8. Laser cutting apertures with trapezoidal walls and rounded corners may offer better paste release. IPC-7525 may have alternate design recommendations.
9. Board assembly site may have different recommendations for stencil design.

DGK0008A

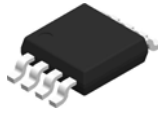

PACKAGE OUTLINE

VSSOP - 1.1 mm max height

SMALL OUTLINE PACKAGE



NOTES:

PowerPAD is a trademark of Texas Instruments.

1. All linear dimensions are in millimeters. Any dimensions in parenthesis are for reference only. Dimensioning and tolerancing per ASME Y14.5M.
2. This drawing is subject to change without notice.
3. This dimension does not include mold flash, protrusions, or gate burrs. Mold flash, protrusions, or gate burrs shall not exceed 0.15 mm per side.
4. This dimension does not include interlead flash. Interlead flash shall not exceed 0.25 mm per side.
5. Reference JEDEC registration MO-187.

EXAMPLE BOARD LAYOUT

DGK0008A

™ VSSOP - 1.1 mm max height

SMALL OUTLINE PACKAGE



LAND PATTERN EXAMPLE
EXPOSED METAL SHOWN
SCALE: 15X



SOLDER MASK DETAILS

4214862/A 04/2023

NOTES: (continued)

6. Publication IPC-7351 may have alternate designs.
7. Solder mask tolerances between and around signal pads can vary based on board fabrication site.
8. Vias are optional depending on application, refer to device data sheet. If any vias are implemented, refer to their locations shown on this view. It is recommended that vias under paste be filled, plugged or tented.
9. Size of metal pad may vary due to creepage requirement.

EXAMPLE STENCIL DESIGN

DGK0008A

™ VSSOP - 1.1 mm max height

SMALL OUTLINE PACKAGE



SOLDER PASTE EXAMPLE
SCALE: 15X

4214862/A 04/2023

NOTES: (continued)

11. Laser cutting apertures with trapezoidal walls and rounded corners may offer better paste release. IPC-7525 may have alternate design recommendations.
12. Board assembly site may have different recommendations for stencil design.



D0008A

PACKAGE OUTLINE

SOIC - 1.75 mm max height

SMALL OUTLINE INTEGRATED CIRCUIT



4214825/C 02/2019

NOTES:

- Linear dimensions are in inches [millimeters]. Dimensions in parenthesis are for reference only. Controlling dimensions are in inches. Dimensioning and tolerancing per ASME Y14.5M.
- This drawing is subject to change without notice.
- This dimension does not include mold flash, protrusions, or gate burrs. Mold flash, protrusions, or gate burrs shall not exceed .006 [0.15] per side.
- This dimension does not include interlead flash.
- Reference JEDEC registration MS-012, variation AA.

EXAMPLE BOARD LAYOUT

D0008A

SOIC - 1.75 mm max height

SMALL OUTLINE INTEGRATED CIRCUIT



LAND PATTERN EXAMPLE
 EXPOSED METAL SHOWN
 SCALE:8X



SOLDER MASK DETAILS

4214825/C 02/2019

NOTES: (continued)

- 6. Publication IPC-7351 may have alternate designs.
- 7. Solder mask tolerances between and around signal pads can vary based on board fabrication site.

EXAMPLE STENCIL DESIGN

D0008A

SOIC - 1.75 mm max height

SMALL OUTLINE INTEGRATED CIRCUIT



SOLDER PASTE EXAMPLE
BASED ON .005 INCH [0.125 MM] THICK STENCIL
SCALE:8X

4214825/C 02/2019

NOTES: (continued)

8. Laser cutting apertures with trapezoidal walls and rounded corners may offer better paste release. IPC-7525 may have alternate design recommendations.
9. Board assembly site may have different recommendations for stencil design.

PW0014A



PACKAGE OUTLINE
TSSOP - 1.2 mm max height

SMALL OUTLINE PACKAGE



NOTES:

1. All linear dimensions are in millimeters. Any dimensions in parenthesis are for reference only. Dimensioning and tolerancing per ASME Y14.5M.
2. This drawing is subject to change without notice.
3. This dimension does not include mold flash, protrusions, or gate burrs. Mold flash, protrusions, or gate burrs shall not exceed 0.15 mm per side.
4. This dimension does not include interlead flash. Interlead flash shall not exceed 0.25 mm per side.
5. Reference JEDEC registration MO-153.

EXAMPLE BOARD LAYOUT

PW0014A

TSSOP - 1.2 mm max height

SMALL OUTLINE PACKAGE

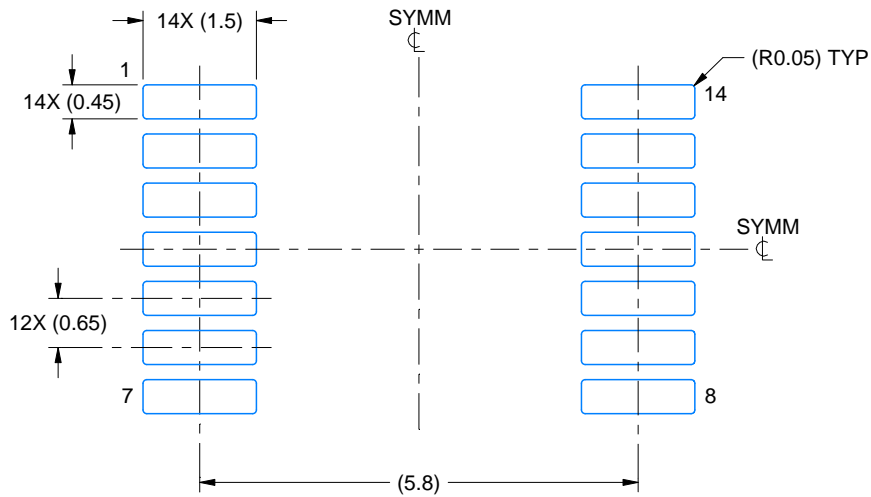

LAND PATTERN EXAMPLE
EXPOSED METAL SHOWN
SCALE: 10X

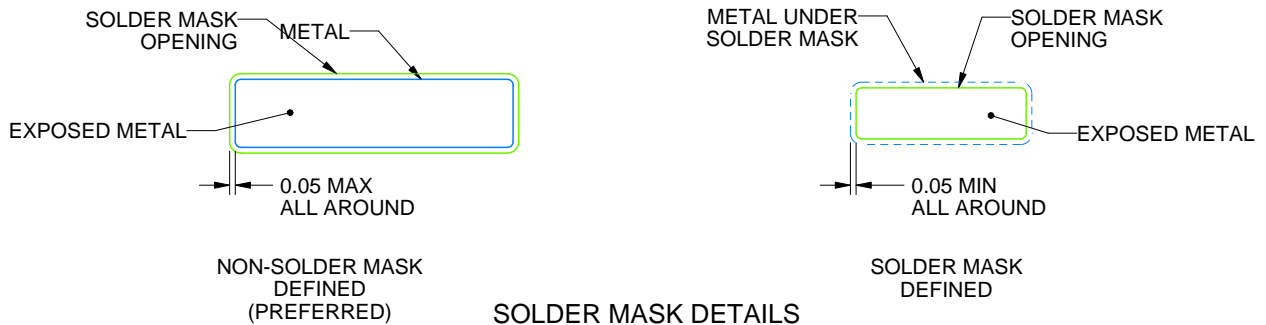

4220202/B 12/2023

NOTES: (continued)

- 6. Publication IPC-7351 may have alternate designs.
- 7. Solder mask tolerances between and around signal pads can vary based on board fabrication site.

EXAMPLE STENCIL DESIGN

PW0014A

TSSOP - 1.2 mm max height

SMALL OUTLINE PACKAGE



SOLDER PASTE EXAMPLE
BASED ON 0.125 mm THICK STENCIL
SCALE: 10X

4220202/B 12/2023

NOTES: (continued)

8. Laser cutting apertures with trapezoidal walls and rounded corners may offer better paste release. IPC-7525 may have alternate design recommendations.
9. Board assembly site may have different recommendations for stencil design.

重要なお知らせと免責事項

TI は、技術データと信頼性データ (データシートを含みます)、設計リソース (リファレンス デザインを含みます)、アプリケーションや設計に関する各種アドバイス、Web ツール、安全性情報、その他のリソースを、欠陥が存在する可能性のある「現状のまま」提供しており、商品性および特定目的に対する適合性の黙示保証、第三者の知的財産権の非侵害保証を含むいかなる保証も、明示的または黙示的にかかわらず拒否します。

これらのリソースは、TI 製品を使用する設計の経験を積んだ開発者への提供を意図したものです。(1) お客様のアプリケーションに適した TI 製品の選定、(2) お客様のアプリケーションの設計、検証、試験、(3) お客様のアプリケーションに該当する各種規格や、その他のあらゆる安全性、セキュリティ、規制、または他の要件への確実な適合に関する責任を、お客様のみが単独で負うものとし、

上記の各種リソースは、予告なく変更される可能性があります。これらのリソースは、リソースで説明されている TI 製品を使用するアプリケーションの開発の目的でのみ、TI はその使用をお客様に許諾します。これらのリソースに関して、他の目的で複製することや掲載することは禁止されています。TI や第三者の知的財産権のライセンスが付与されている訳ではありません。お客様は、これらのリソースを自身で使用した結果発生するあらゆる申し立て、損害、費用、損失、責任について、TI およびその代理人を完全に補償するものとし、TI は一切の責任を拒否します。

TI の製品は、[TI の販売条件](#)、[TI の総合的な品質ガイドライン](#)、[ti.com](#) または TI 製品などに関連して提供される他の適用条件に従い提供されます。TI がこれらのリソースを提供することは、適用される TI の保証または他の保証の放棄の拡大や変更を意味するものではありません。TI がカスタム、またはカスタマー仕様として明示的に指定していない限り、TI の製品は標準的なカタログに掲載される汎用機器です。

お客様がいかなる追加条項または代替条項を提案する場合も、TI はそれらに異議を唱え、拒否します。

Copyright © 2026, Texas Instruments Incorporated

最終更新日 : 2025 年 10 月