

REF19xx Low-Drift, Low-Power, Dual-Output, V_{REF} and $V_{REF} / 2$ Voltage References

1 Features

- Two Outputs, V_{REF} and $V_{REF} / 2$, for Convenient Use in Single-Supply Systems
- Excellent Temperature Drift Performance:
 - 25 ppm/°C (max) from –40°C to 125°C
- High Initial Accuracy: $\pm 0.1\%$ (max)
- V_{REF} and V_{BIAS} Tracking over Temperature:
 - 6 ppm/°C (max) from –40°C to 85°C
 - 7 ppm/°C (max) from –40°C to 125°C
- Microsize Package: SOT23-5
- Low Dropout Voltage: 10 mV
- High Output Current: ± 20 mA
- Low Quiescent Current: 360 μ A
- Line Regulation: 3 ppm/V
- Load Regulation: 8 ppm/mA

2 Applications

- Digital Signal Processing:
 - Power Inverters
 - Motor Controls
- Current Sensing
- Industrial Process Controls
- Medical Equipment
- Data Acquisition Systems
- Single-Supply Systems

3 Description

Applications with only a positive supply voltage often require an additional stable voltage in the middle of the analog-to-digital converter (ADC) input range to bias input bipolar signals. The REF19xx provides a reference voltage (V_{REF}) for the ADC and a second highly-accurate voltage (V_{BIAS}) that can be used to bias the input bipolar signals.

The REF19xx offers excellent temperature drift (25 ppm/°C, max) and initial accuracy (0.1%) on both the V_{REF} and V_{BIAS} outputs while operating at a quiescent current less than 430 μ A. In addition, the V_{REF} and V_{BIAS} outputs track each other with a precision of 6 ppm/°C (max) across the temperature range of –40°C to 85°C. All these features increase the precision of the signal chain and decrease board space, while reducing the cost of the system as compared to a discrete solution. Extremely low dropout voltage of only 10 mV allows operation from very low input voltages, which can be very useful in battery-operated systems.

Both the V_{REF} and V_{BIAS} voltages have the same excellent specifications and can sink and source current equally well. Very good long-term stability and low noise levels make these devices ideally-suited for high-precision industrial applications.

Device Information⁽¹⁾

PART NAME	PACKAGE	BODY SIZE (NOM)
REF19xx	SOT (5)	2.90 mm x 1.60 mm

(1) For all available packages, see the orderable addendum at the end of the datasheet.

Application Example

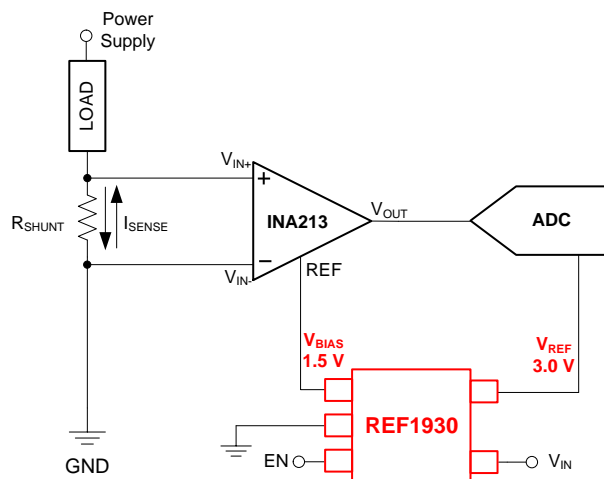

V_{REF} and V_{BIAS} vs Temperature

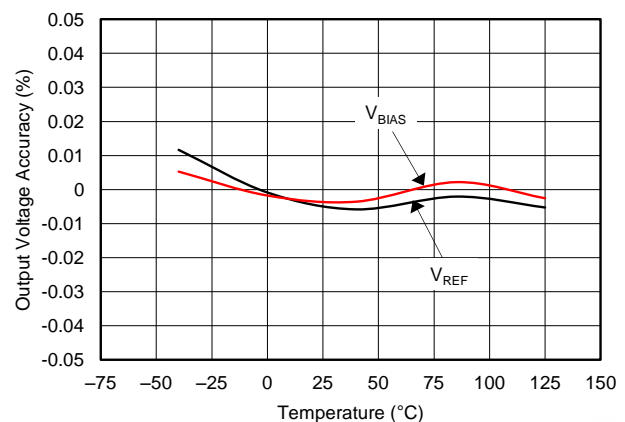

Table of Contents

1 Features	1	9.2 Functional Block Diagram	15
2 Applications	1	9.3 Feature Description	15
3 Description	1	9.4 Device Functional Modes	16
4 Revision History	2	10 Applications and Implementation	17
5 Device Comparison Table	3	10.1 Application Information	17
6 Pin Configuration and Functions	3	10.2 Typical Application	17
7 Specifications	4	11 Power-Supply Recommendations	22
7.1 Absolute Maximum Ratings	4	12 Layout	23
7.2 ESD Ratings	4	12.1 Layout Guidelines	23
7.3 Recommended Operating Conditions	4	12.2 Layout Example	23
7.4 Thermal Information	4	13 Device and Documentation Support	24
7.5 Electrical Characteristics	5	13.1 Documentation Support	24
7.6 Typical Characteristics	6	13.2 Related Links	24
8 Parameter Measurement Information	12	13.3 Receiving Notification of Documentation Updates	24
8.1 Solder Heat Shift	12	13.4 Community Resources	24
8.2 Thermal Hysteresis	13	13.5 Trademarks	24
8.3 Noise Performance	14	13.6 Electrostatic Discharge Caution	24
9 Detailed Description	15	13.7 Glossary	24
9.1 Overview	15	14 Mechanical, Packaging, and Orderable Information	25

4 Revision History

NOTE: Page numbers for previous revisions may differ from page numbers in the current version.

Changes from Original (September 2014) to Revision A	Page
• Changed <i>Input</i> to <i>Output</i> in I/O column of pin 1 row in <i>Pin Functions</i> table	3
• Added <i>Storage temperature</i> parameter to <i>Absolute Maximum Ratings</i> table (moved from <i>ESD Ratings</i> table)	4
• Changed <i>ESD Ratings</i> table: changed title and updated table format	4

5 Device Comparison Table

PRODUCT	V_{REF}	V_{BIAS}
REF1925	2.5 V	1.25 V
REF1930	3.0 V	1.5 V
REF1933	3.3 V	1.65 V
REF1941	4.096 V	2.048 V

6 Pin Configuration and Functions

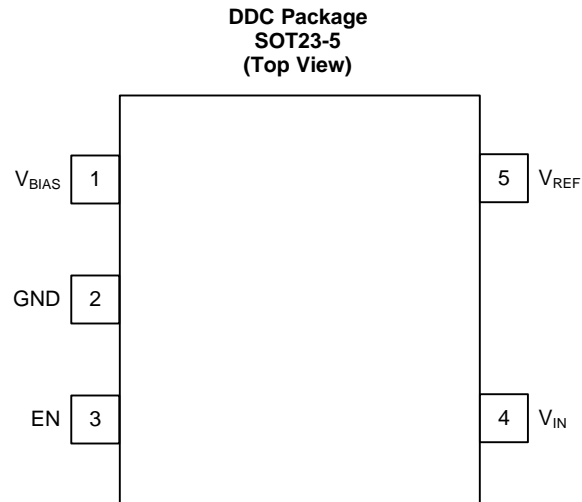

Pin Functions

PIN		I/O	DESCRIPTION
NO.	NAME		
1	V_{BIAS}	Output	Bias voltage output ($V_{REF} / 2$)
2	GND	—	Ground
3	EN	Input	Enable ($EN \geq V_{IN} - 0.7\text{ V}$, device enabled)
4	V_{IN}	Input	Input supply voltage
5	V_{REF}	Output	Reference voltage output (V_{REF})

7 Specifications

7.1 Absolute Maximum Ratings

over operating free-air temperature range (unless otherwise noted)⁽¹⁾

		MIN	MAX	UNIT
Input voltage	V _{IN}	-0.3	6	V
	EN	-0.3	V _{IN} + 0.3	
Temperature	Operating	-55	150	°C
	Junction, T _J		150	
	Storage, T _{stg}	-65	170	

(1) Stresses beyond those listed under *Absolute Maximum Ratings* may cause permanent damage to the device. These are stress ratings only, which do not imply functional operation of the device at these or any other conditions beyond those indicated under *Recommended Operating Conditions*. Exposure to absolute-maximum-rated conditions for extended periods may affect device reliability.

7.2 ESD Ratings

		VALUE	UNIT
V _(ESD) Electrostatic discharge	Human-body model (HBM), per ANSI/ESDA/JEDEC JS-001 ⁽¹⁾	±4000	V
	Charged-device model (CDM), per JEDEC specification JESD22-C101 ⁽²⁾	±1500	

(1) JEDEC document JEP155 states that 500-V HBM allows safe manufacturing with a standard ESD control process.

(2) JEDEC document JEP157 states that 250-V CDM allows safe manufacturing with a standard ESD control process.

7.3 Recommended Operating Conditions

over operating free-air temperature range (unless otherwise noted)

		MIN	NOM	MAX	UNIT
V _{IN}	Supply input voltage range (I _L = 0 mA, T _A = 25°C)	V _{REF} + 0.02 ⁽¹⁾		5.5	V

(1) See [Figure 24](#) in the *Typical Characteristics* section for the minimum input voltage at different load currents and temperature.

7.4 Thermal Information

THERMAL METRIC ⁽¹⁾		REF19xx	UNIT
		DDC (SOT23)	
		5 PINS	
R _{θJA}	Junction-to-ambient thermal resistance	193.6	°C/W
R _{θJC(top)}	Junction-to-case (top) thermal resistance	40.2	°C/W
R _{θJB}	Junction-to-board thermal resistance	34.5	°C/W
ψ _{JT}	Junction-to-top characterization parameter	0.9	°C/W
ψ _{JB}	Junction-to-board characterization parameter	34.3	°C/W
R _{θJC(bot)}	Junction-to-case (bottom) thermal resistance	N/A	°C/W

(1) For more information about traditional and new thermal metrics, see the *Semiconductor and IC Package Thermal Metrics* application report.

7.5 Electrical Characteristics

At $T_A = 25^\circ\text{C}$, $I_L = 0\text{ mA}$, and $V_{IN} = 5\text{ V}$, unless otherwise noted. Both V_{REF} and V_{BIAS} have the same specifications.

PARAMETER		TEST CONDITIONS	MIN	TYP	MAX	UNIT
ACCURACY AND DRIFT						
Output voltage accuracy			-0.1%		0.1%	
Output voltage temperature coefficient ⁽¹⁾		$-40^\circ\text{C} \leq T_A \leq 125^\circ\text{C}$		± 10	± 25	ppm/ $^\circ\text{C}$
V_{REF} and V_{BIAS} tracking over temperature ⁽²⁾		$-40^\circ\text{C} \leq T_A \leq 85^\circ\text{C}$		± 1.5	± 6	ppm/ $^\circ\text{C}$
		$-40^\circ\text{C} \leq T_A \leq 125^\circ\text{C}$		± 2	± 7	
LINE AND LOAD REGULATION						
$\Delta V_{O(\Delta V_I)}$	Line regulation	$V_{REF} + 0.02\text{ V} \leq V_{IN} \leq 5.5\text{ V}$		3	35	ppm/V
$\Delta V_{O(\Delta I_L)}$	Load regulation	Sourcing $0\text{ mA} \leq I_L \leq 20\text{ mA}$, $V_{REF} + 0.6\text{ V} \leq V_{IN} \leq 5.5\text{ V}$		8	20	ppm/mA
		Sinking $0\text{ mA} \leq I_L \leq -20\text{ mA}$, $V_{REF} + 0.02\text{ V} \leq V_{IN} \leq 5.5\text{ V}$		8	20	
POWER SUPPLY						
I_{CC}	Supply current	Active mode $-40^\circ\text{C} \leq T_A \leq 125^\circ\text{C}$		360	430	μA
					460	
Shutdown mode $-40^\circ\text{C} \leq T_A \leq 125^\circ\text{C}$		3.3	5			
			9			
Enable voltage		Device in shutdown mode ($EN = 0$)	0		0.7	V
		Device in active mode ($EN = 1$)	$V_{IN} - 0.7$		V_{IN}	
Dropout voltage		$I_L = 20\text{ mA}$		10	20	mV
I_{SC}	Short-circuit current			50		mA
t_{on}	Turn-on time	0.1% settling, $C_L = 1\text{ }\mu\text{F}$		500		μs
NOISE						
Low-frequency noise ⁽³⁾		$0.1\text{ Hz} \leq f \leq 10\text{ Hz}$		12		ppm _{PP}
Output voltage noise density		$f = 100\text{ Hz}$		0.25		ppm/ $\sqrt{\text{Hz}}$
CAPACITIVE LOAD						
Stable output capacitor range				0	10	μF
HYSTERESIS AND LONG-TERM STABILITY						
Long-term stability		0 to 1000 hours		60		ppm
Output voltage hysteresis ⁽⁴⁾		25°C , -40°C , 125°C , 25°C	Cycle 1	60		ppm
			Cycle 2	35		

(1) Temperature drift is specified according to the box method. See the [Feature Description](#) section for more details.

(2) The V_{REF} and V_{BIAS} tracking over temperature specification is explained in more detail in the [Feature Description](#) section.

(3) The peak-to-peak noise measurement procedure is explained in more detail in the [Noise Performance](#) section.

(4) The thermal hysteresis measurement procedure is explained in more detail in the [Thermal Hysteresis](#) section.

7.6 Typical Characteristics

At $T_A = 25^\circ\text{C}$, $I_L = 0\text{ mA}$, $V_{IN} = 5\text{-V}$ power supply, $C_L = 0\text{ }\mu\text{F}$, and 2.5-V output, unless otherwise noted.

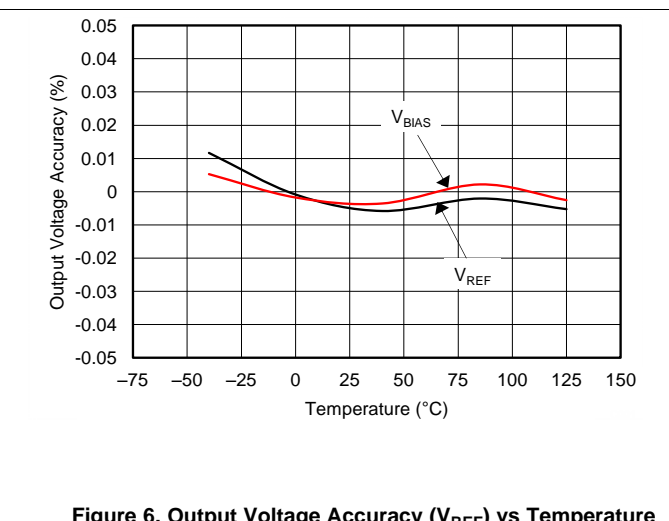
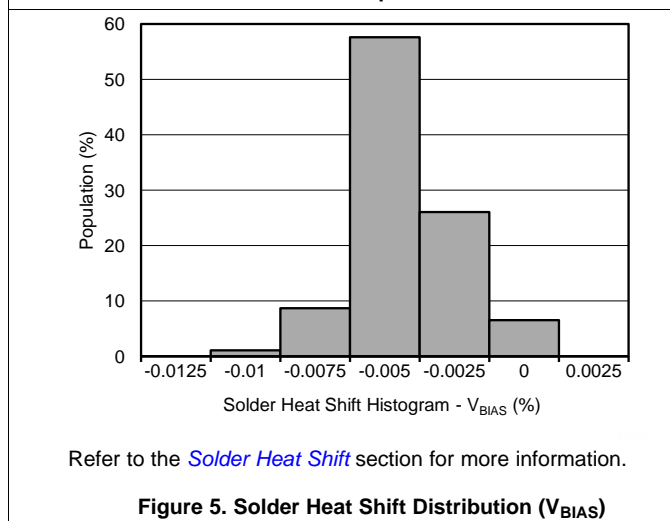
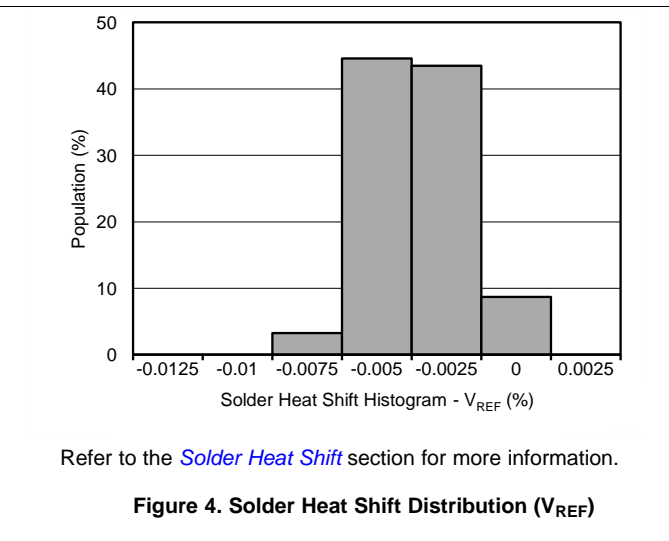
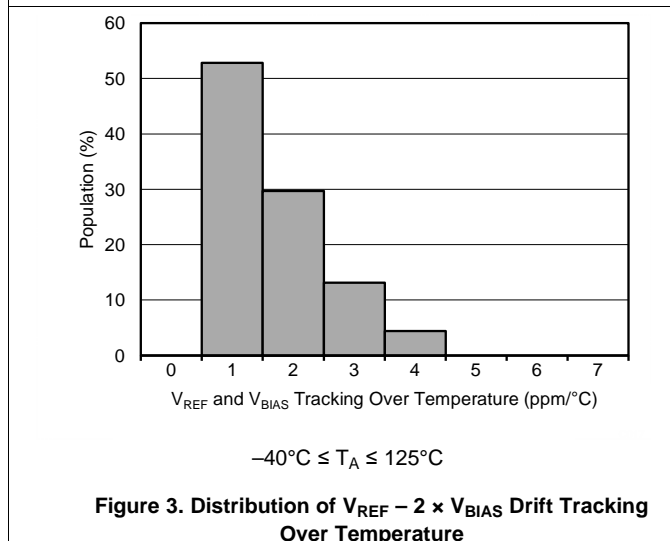
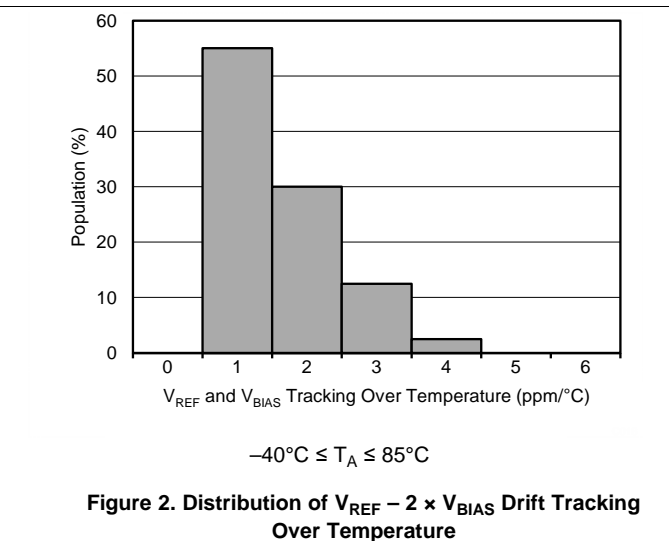
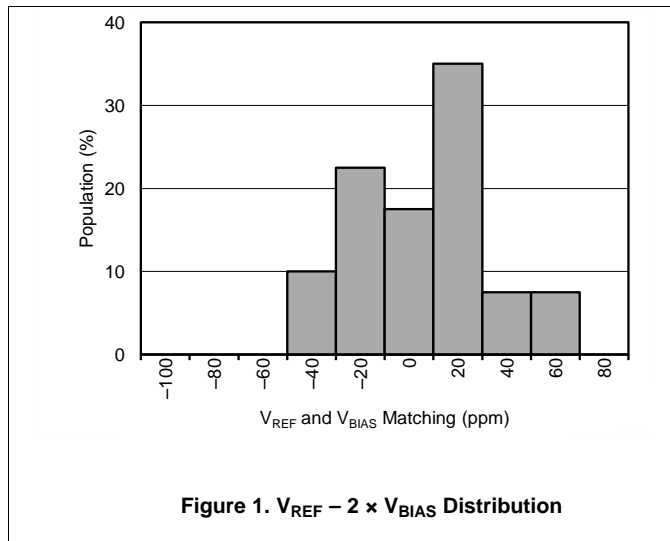

Typical Characteristics (continued)

At $T_A = 25^\circ\text{C}$, $I_L = 0\text{ mA}$, $V_{IN} = 5\text{-V}$ power supply, $C_L = 0\text{ }\mu\text{F}$, and 2.5-V output, unless otherwise noted.

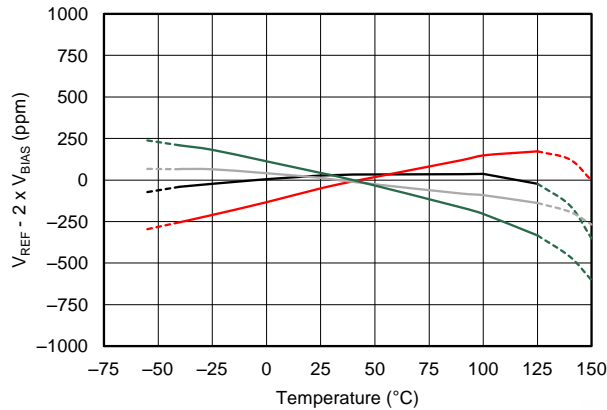

Figure 7. $V_{REF} - 2 \times V_{BIAS}$ Tracking vs Temperature

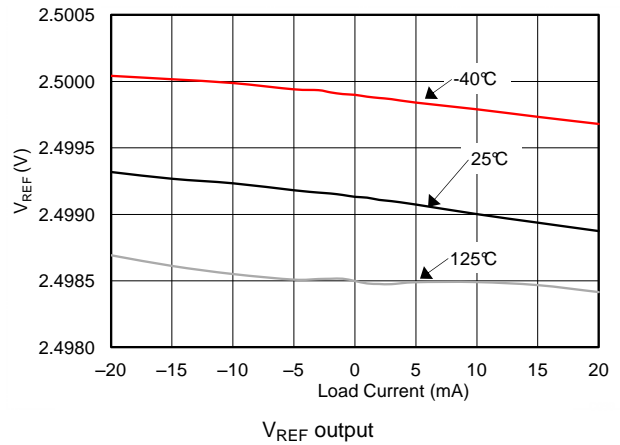

Figure 8. Output Voltage Change vs Load Current (V_{REF})

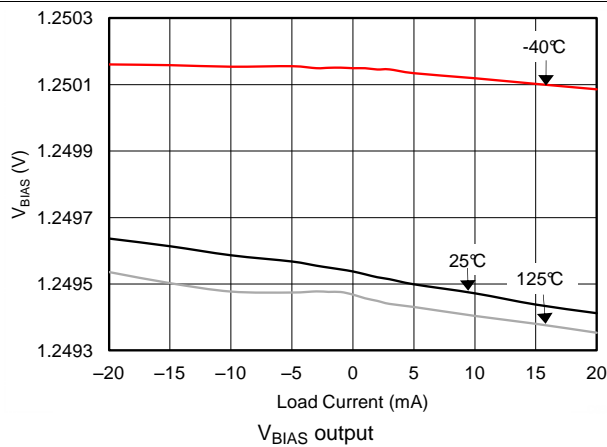

Figure 9. Output Voltage Change vs Load Current (V_{BIAS})

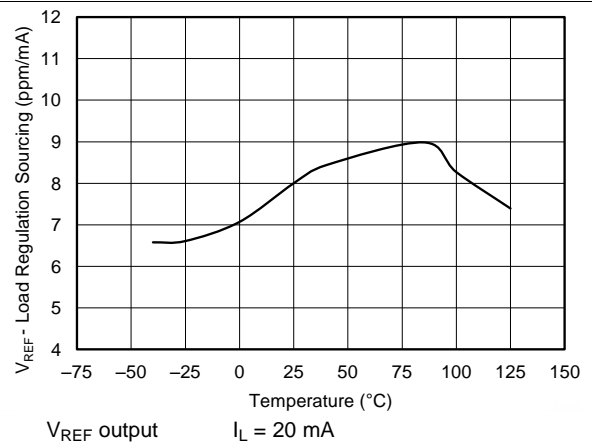

Figure 10. Load Regulation Sourcing vs Temperature (V_{REF})

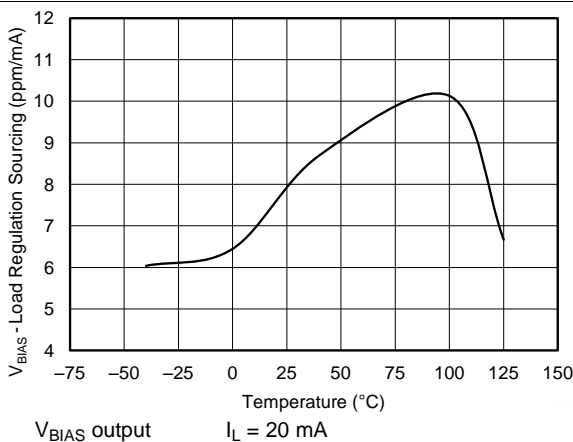

Figure 11. Load Regulation Sourcing vs Temperature (V_{BIAS})

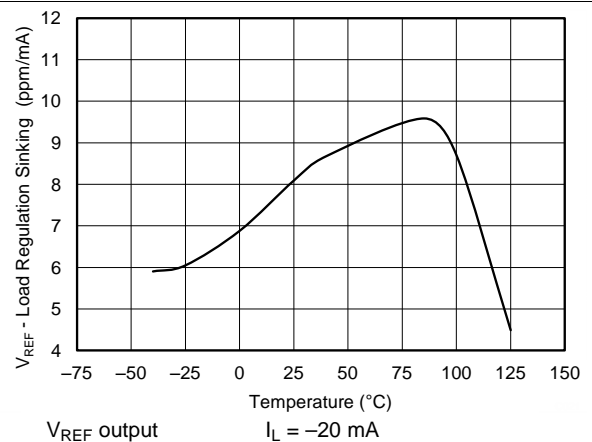

Figure 12. Load Regulation Sinking vs Temperature (V_{REF})

Typical Characteristics (continued)

At $T_A = 25^\circ\text{C}$, $I_L = 0\text{ mA}$, $V_{IN} = 5\text{-V}$ power supply, $C_L = 0\text{ }\mu\text{F}$, and 2.5-V output, unless otherwise noted.

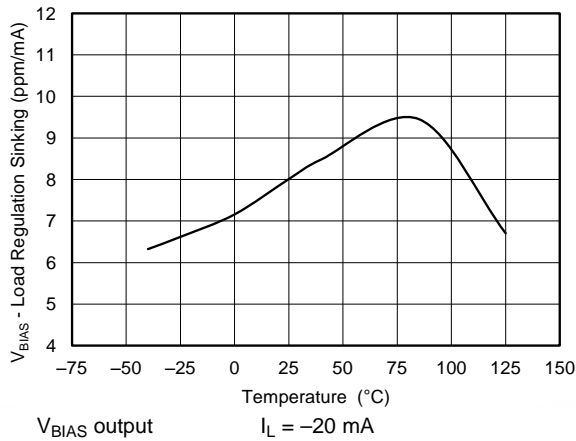

Figure 13. Load Regulation Sinking vs Temperature (V_{BIAS})

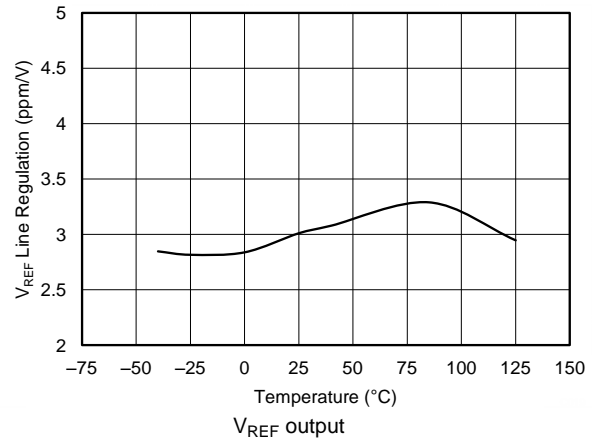

Figure 14. Line Regulation vs Temperature (V_{REF})

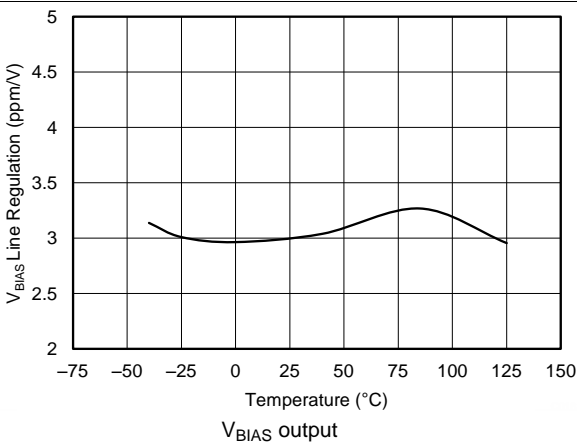

Figure 15. Line Regulation vs Temperature (V_{BIAS})

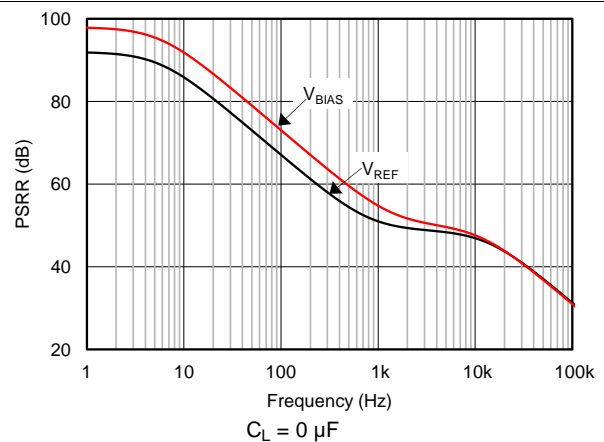

Figure 16. Power-Supply Rejection Ratio vs Frequency

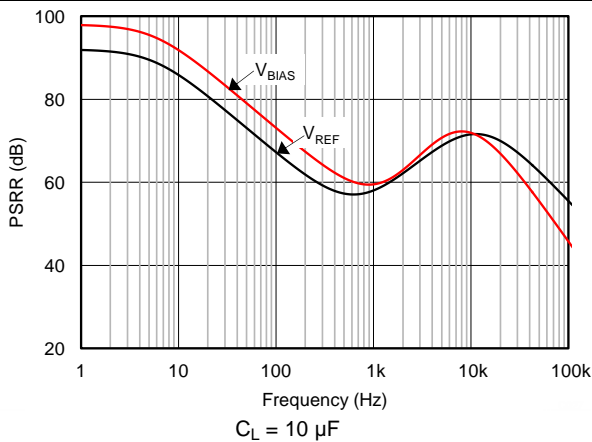

Figure 17. Power-Supply Rejection Ratio vs Frequency

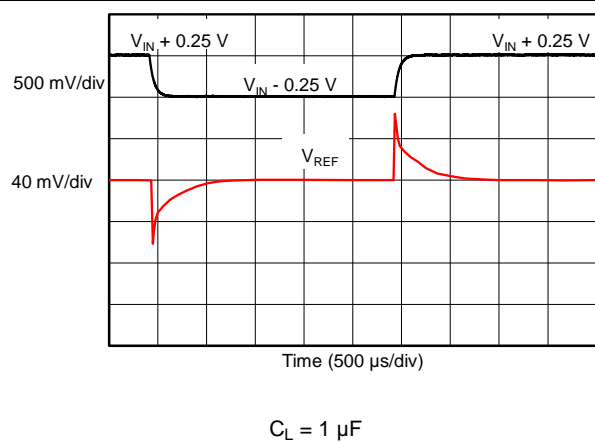
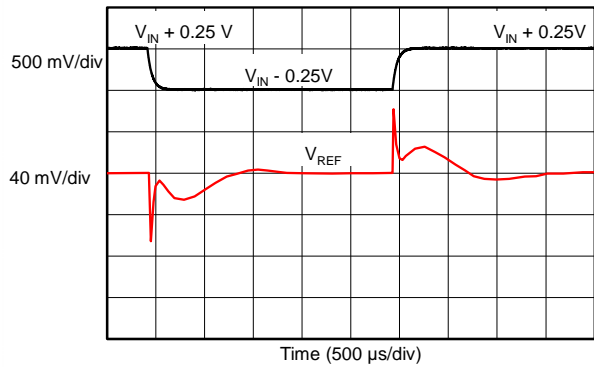

Figure 18. Line Transient Response

Typical Characteristics (continued)

At $T_A = 25^\circ\text{C}$, $I_L = 0\text{ mA}$, $V_{IN} = 5\text{-V power supply}$, $C_L = 0\text{ }\mu\text{F}$, and 2.5-V output , unless otherwise noted.



$C_L = 10\text{ }\mu\text{F}$

Figure 19. Line Transient Response

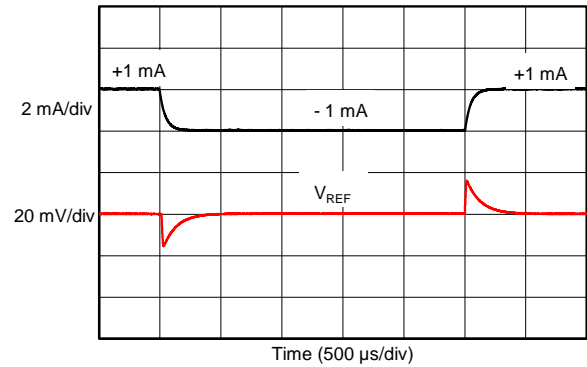

$C_L = 1\text{ }\mu\text{F}$ $I_L = \pm 1\text{-mA step}$

Figure 20. Load Transient Response

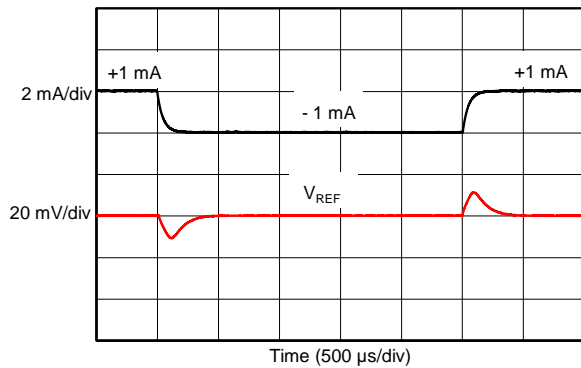

$C_L = 10\text{ }\mu\text{F}$ $I_L = \pm 1\text{-mA step}$

Figure 21. Load Transient Response

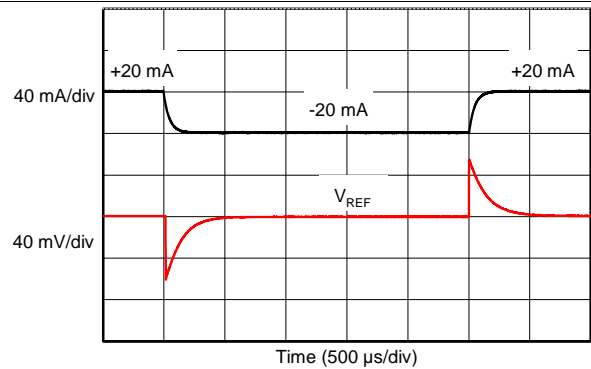

$C_L = 1\text{ }\mu\text{F}$ $I_L = \pm 20\text{-mA step}$

Figure 22. Load Transient Response

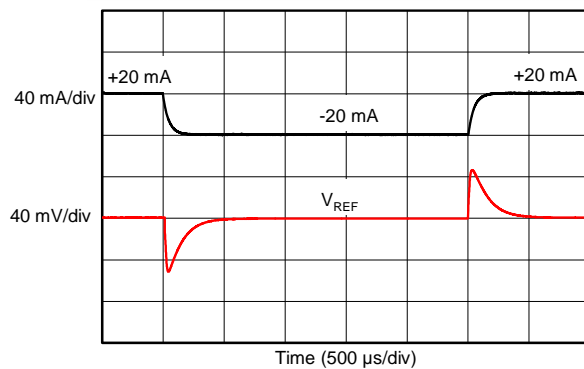

$C_L = 10\text{ }\mu\text{F}$ $I_L = \pm 20\text{-mA step}$

Figure 23. Load Transient Response

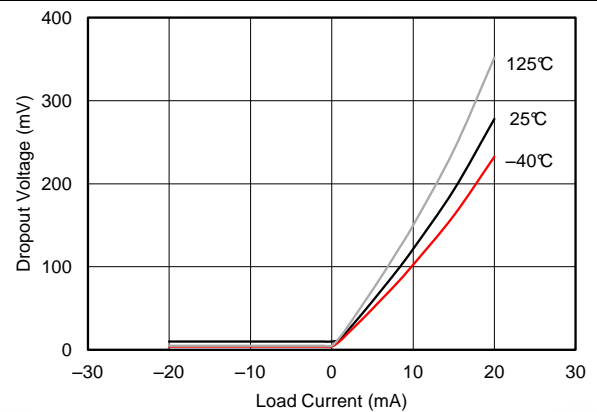
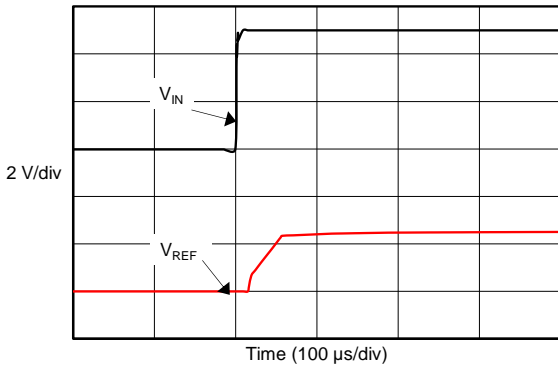

Figure 24. Minimum Dropout Voltage vs Load Current

Typical Characteristics (continued)

At $T_A = 25^\circ\text{C}$, $I_L = 0\text{ mA}$, $V_{IN} = 5\text{-V}$ power supply, $C_L = 0\text{ }\mu\text{F}$, and 2.5-V output, unless otherwise noted.



$C_L = 1\text{ }\mu\text{F}$

Figure 25. Turn-On Settling Time

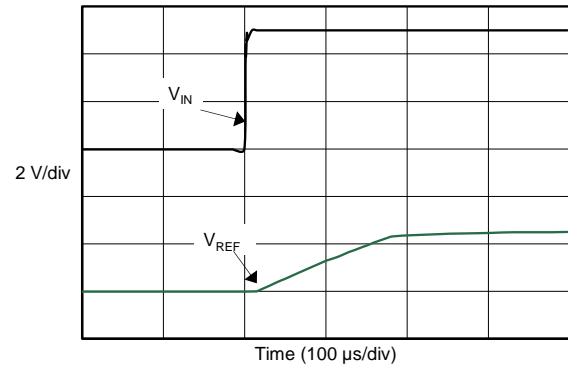

$C_L = 10\text{ }\mu\text{F}$

Figure 26. Turn-On Settling Time

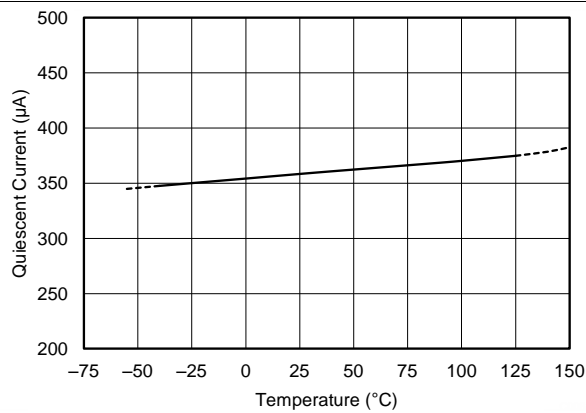

Figure 27. Quiescent Current vs Temperature

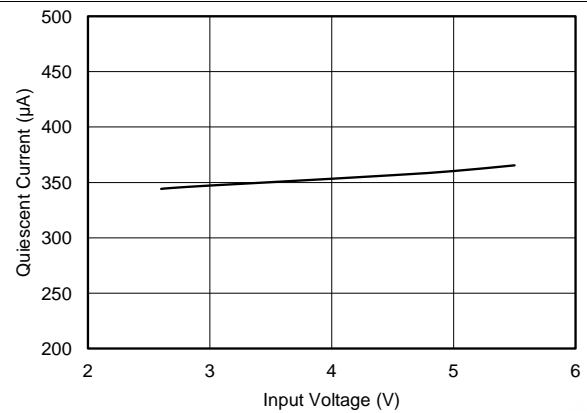
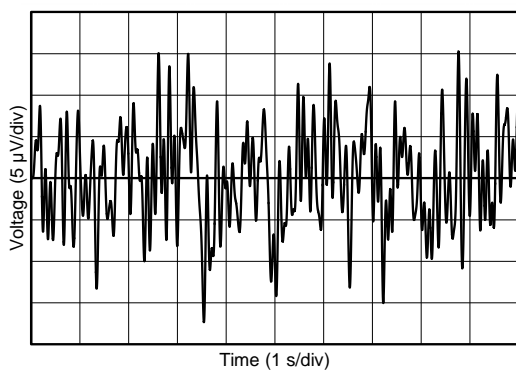
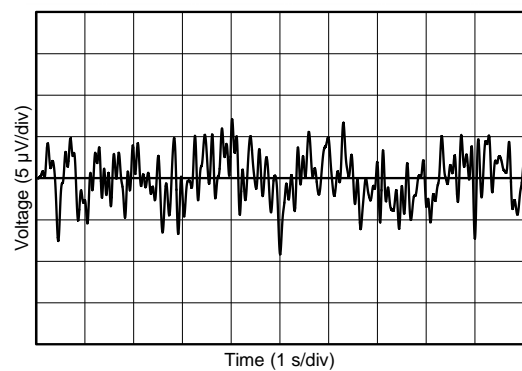

Figure 28. Quiescent Current vs Input Voltage



V_{REF} output

Figure 29. 0.1-Hz to 10-Hz Noise (V_{REF})



V_{BIAS} output

Figure 30. 0.1-Hz to 10-Hz Noise (V_{BIAS})

Typical Characteristics (continued)

At $T_A = 25^\circ\text{C}$, $I_L = 0\text{ mA}$, $V_{IN} = 5\text{-V}$ power supply, $C_L = 0\ \mu\text{F}$, and 2.5-V output, unless otherwise noted.

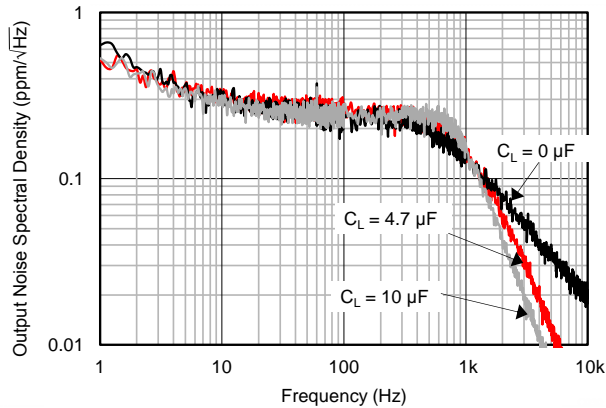

Figure 31. Output Voltage Noise Spectrum

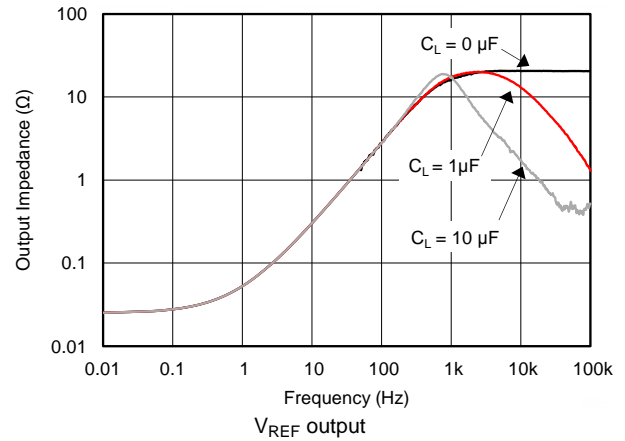

Figure 32. Output Impedance vs Frequency (V_{REF})

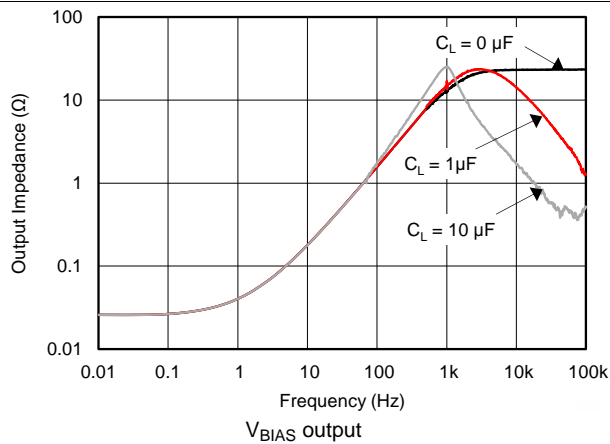

Figure 33. Output Impedance vs Frequency (V_{BIAS})

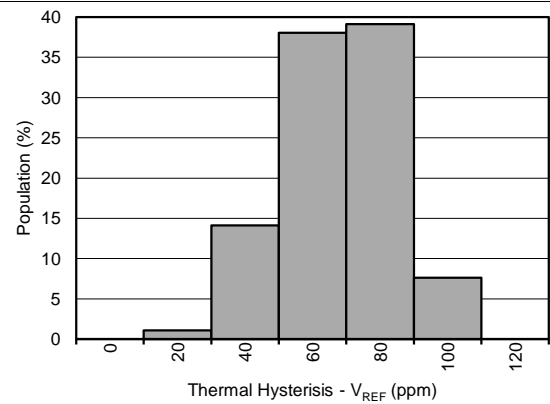

Figure 34. Thermal Hysteresis Distribution (V_{REF})

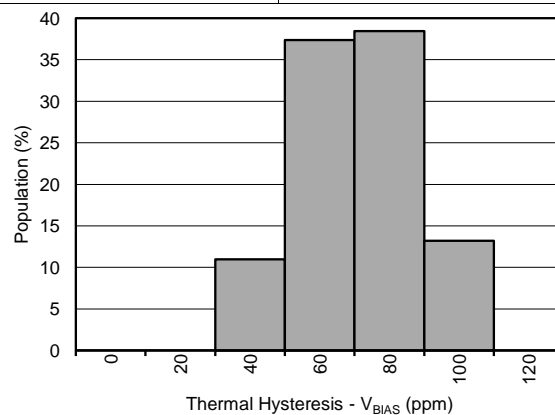

Figure 35. Thermal Hysteresis Distribution (V_{BIAS})

8 Parameter Measurement Information

8.1 Solder Heat Shift

The materials used in the manufacture of the REF19xx have differing coefficients of thermal expansion, resulting in stress on the device die when the device is heated. Mechanical and thermal stress on the device die can cause the output voltages to shift, degrading the initial accuracy specifications of the product. Reflow soldering is a common cause of this error.

In order to illustrate this effect, a total of 92 devices were soldered on four printed circuit boards [23 devices on each printed circuit board (PCB)] using lead-free solder paste and the paste manufacturer suggested reflow profile. The reflow profile is as shown in Figure 36. The PCB is comprised of FR4 material. The board thickness is 1.57 mm and the area is 171.54 mm × 165.1 mm.

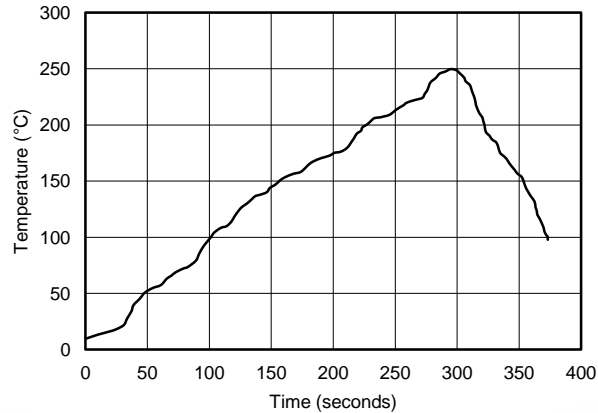

Figure 36. Reflow Profile

The reference and bias output voltages are measured before and after the reflow process; the typical shift is displayed in Figure 37 and Figure 38. Although all tested units exhibit very low shifts (< 0.01%), higher shifts are also possible depending on the size, thickness, and material of the PCB. An important note is that the histograms display the typical shift for exposure to a single reflow profile. Exposure to multiple reflows, which is common on PCBs with surface-mount components on both sides, causes additional shifts in the output bias voltage. If the PCB is exposed to multiple reflows, solder the device in the second pass to minimize device exposure to thermal stress.

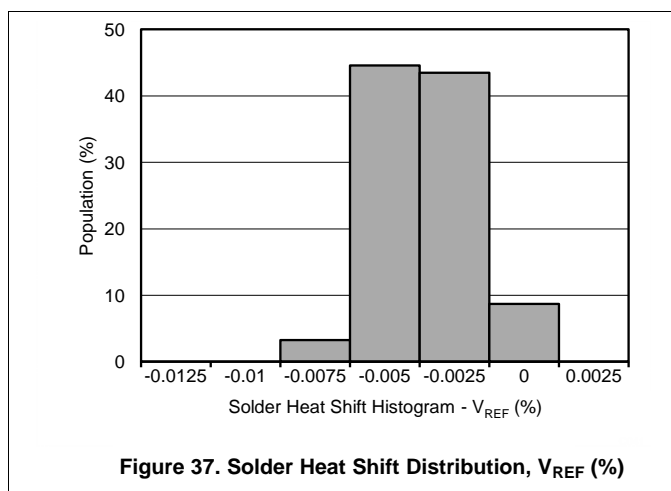

Figure 37. Solder Heat Shift Distribution, V_{REF} (%)

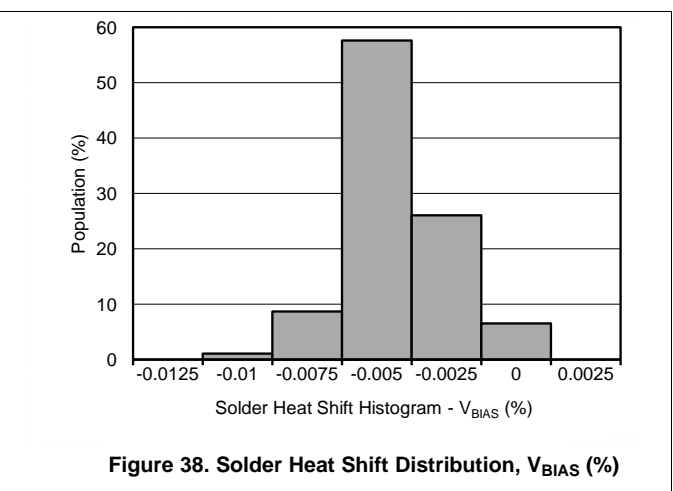

Figure 38. Solder Heat Shift Distribution, V_{BIAS} (%)

8.2 Thermal Hysteresis

Thermal hysteresis is measured with the REF19xx soldered to a PCB, similar to a real-world application. Thermal hysteresis for the device is defined as the change in output voltage after operating the device at 25°C, cycling the device through the specified temperature range, and returning to 25°C. Hysteresis can be expressed by Equation 1:

$$V_{\text{HYST}} = \left(\frac{|V_{\text{PRE}} - V_{\text{POST}}|}{V_{\text{NOM}}} \right) \cdot 10^6 \text{ (ppm)}$$

where

- V_{HYST} = thermal hysteresis (in units of ppm),
 - V_{NOM} = the specified output voltage,
 - V_{PRE} = output voltage measured at 25°C pre-temperature cycling, and
 - V_{POST} = output voltage measured after the device has cycled from 25°C through the specified temperature range of –40°C to 125°C and returns to 25°C.
- (1)

Typical thermal hysteresis distribution is as shown in Figure 39 and Figure 40.

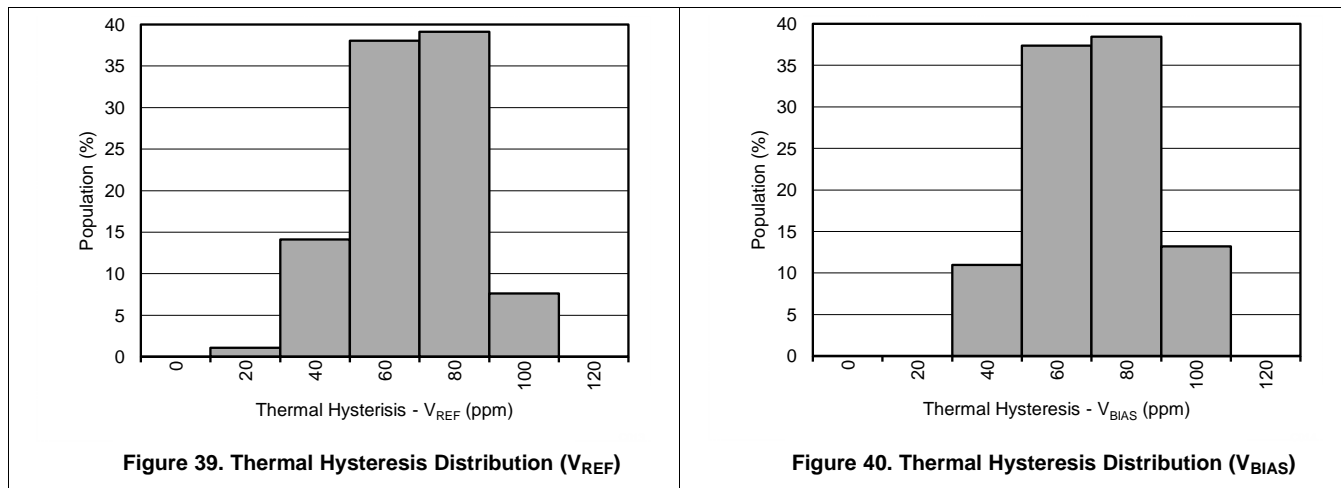

8.3 Noise Performance

Typical 0.1-Hz to 10-Hz voltage noise is shown in [Figure 41](#) and [Figure 42](#). Device noise increases with output voltage and operating temperature. Additional filtering can be used to improve output noise levels, although care must be taken to ensure the output impedance does not degrade ac performance. Peak-to-peak noise measurement setup is shown in [Figure 43](#).

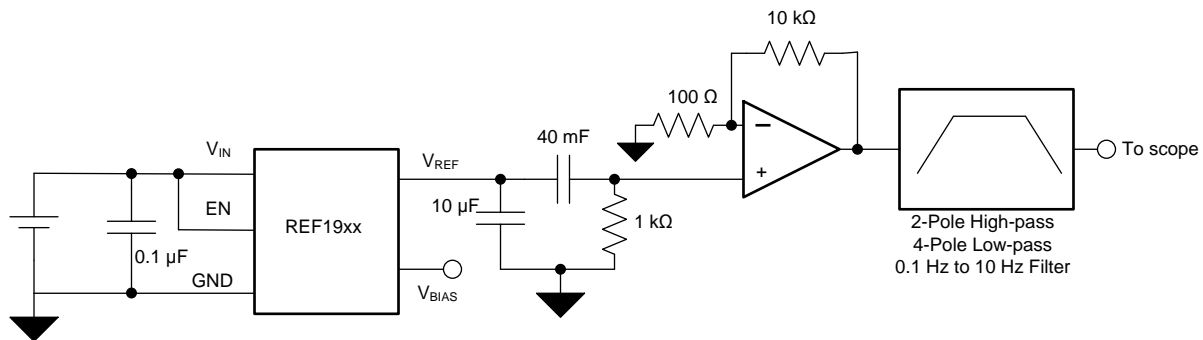
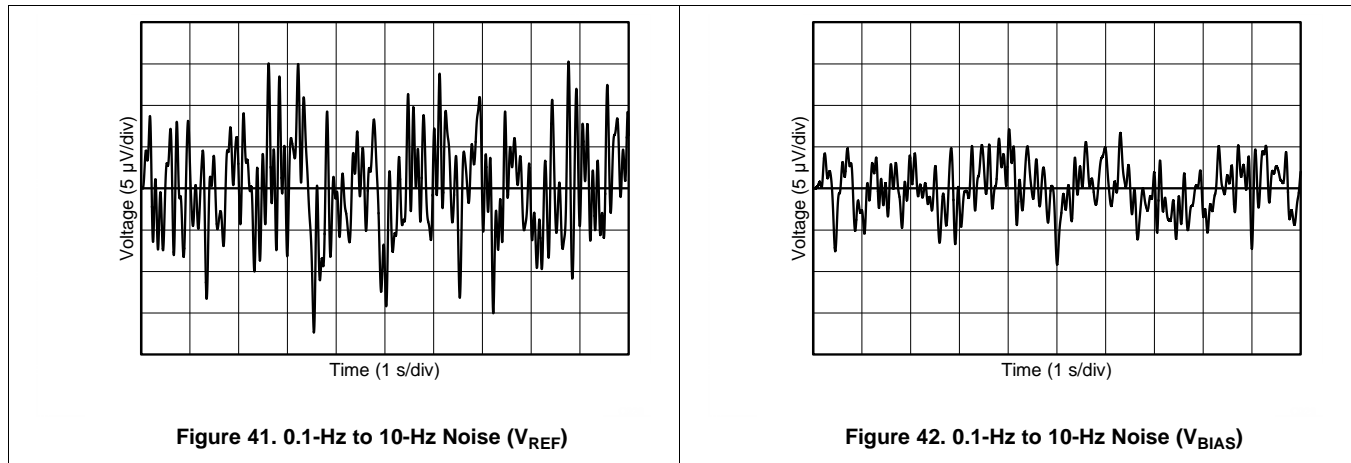

Figure 43. 0.1-Hz to 10-Hz Noise Measurement Setup

9 Detailed Description

9.1 Overview

The REF19xx is a family of dual-output, V_{REF} and V_{BIAS} ($V_{REF} / 2$) band-gap voltage references. The [Functional Block Diagram](#) section provides a block diagram of the basic band-gap topology and the two buffers used to derive the V_{REF} and V_{BIAS} outputs. Transistors Q_1 and Q_2 are biased such that the current density of Q_1 is greater than that of Q_2 . The difference of the two base emitter voltages ($V_{BE1} - V_{BE2}$) has a positive temperature coefficient and is forced across resistor R_5 . The voltage is amplified and added to the base emitter voltage of Q_2 , which has a negative temperature coefficient. The resulting band-gap output voltage is almost independent of temperature. Two independent buffers are used to generate V_{REF} and V_{BIAS} from the band-gap voltage. The resistors R_1 , R_2 and R_3 , R_4 are sized such that $V_{BIAS} = V_{REF} / 2$.

e-Trim™ is a method of package-level trim for the initial accuracy and temperature coefficient of V_{REF} and V_{BIAS} , implemented during the final steps of manufacturing after the plastic molding process. This method minimizes the influence of inherent transistor mismatch, as well as errors induced during package molding. e-Trim is implemented in the REF19xx to minimize the temperature drift and maximize the initial accuracy of both the V_{REF} and V_{BIAS} outputs.

9.2 Functional Block Diagram

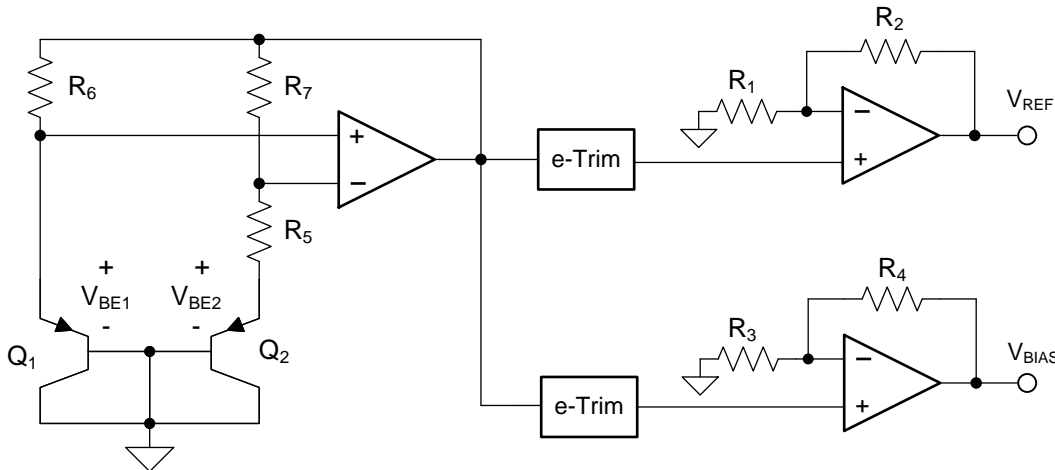

9.3 Feature Description

9.3.1 V_{REF} and V_{BIAS} Tracking

Most single-supply systems require an additional stable voltage in the middle of the analog-to-digital converter (ADC) input range to bias input bipolar signals. The V_{REF} and V_{BIAS} outputs of the REF19xx are generated from the same band-gap voltage as shown in the [Functional Block Diagram](#) section. Hence, both outputs track each other over the full temperature range of -40°C to 125°C with an accuracy of 7 ppm/ $^{\circ}\text{C}$ (max). The tracking accuracy increases to 6 ppm/ $^{\circ}\text{C}$ (max) when the temperature range is limited to -40°C to 85°C . The tracking error is calculated using the box method, as described by [Equation 2](#):

$$\text{Tracking Error} = \left(\frac{V_{\text{DIFF(MAX)}} - V_{\text{DIFF(MIN)}}}{V_{\text{REF}} \cdot \text{Temperature Range}} \right) \cdot 10^6 \quad (\text{ppm})$$

where

$$\bullet \quad V_{\text{DIFF}} = V_{\text{REF}} - 2 \cdot V_{\text{BIAS}} \quad (2)$$

Feature Description (continued)

The tracking accuracy is as shown in [Figure 44](#).

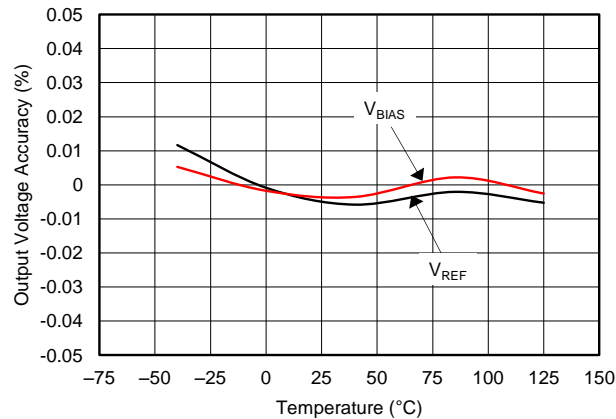

Figure 44. V_{REF} and V_{BIAS} Tracking vs Temperature

9.3.2 Low Temperature Drift

The REF19xx is designed for minimal drift error, which is defined as the change in output voltage over temperature. The drift is calculated using the box method, as described by [Equation 3](#):

$$\text{Drift} = \left(\frac{V_{\text{REF(MAX)}} - V_{\text{REF(MIN)}}}{V_{\text{REF}} \cdot \text{Temperature Range}} \right) \cdot 10^6 \quad (\text{ppm}) \quad (3)$$

9.3.3 Load Current

The REF19xx family is specified to deliver a current load of ± 20 mA per output. Both the V_{REF} and V_{BIAS} outputs of the device are protected from short circuits by limiting the output short-circuit current to 50 mA. The device temperature increases according to [Equation 4](#):

$$T_J = T_A + P_D \cdot R_{\theta JA}$$

where

- T_J = junction temperature (°C),
 - T_A = ambient temperature (°C),
 - P_D = power dissipated (W), and
 - R_{θJA} = junction-to-ambient thermal resistance (°C/W).
- (4)

The REF19xx maximum junction temperature must not exceed the absolute maximum rating of 150°C.

9.4 Device Functional Modes

When the EN pin of the REF19xx is pulled high, the device is in active mode. The device must be in active mode for normal operation. The REF19xx can be placed in a low-power mode by pulling the ENABLE pin low. When in shutdown mode, the output of the device becomes high impedance and the quiescent current of the device reduces to 5 μA in shutdown mode. See the [Electrical Characteristics](#) for logic high and logic low voltage levels.

10 Applications and Implementation

NOTE

Information in the following applications and implementation sections is not part of the TI component specification, and TI does not warrant its accuracy or completeness. TI's customers are responsible for determining suitability of components for their purposes. Customers should validate and test their design implementation to confirm system functionality.

10.1 Application Information

The low-drift, bidirectional, single-supply, low-side, current-sensing solution described in this section can accurately detect load currents from -2.5 A to 2.5 A . The linear range of the output is from 250 mV to 2.75 V . Positive current is represented by output voltages from 1.5 V to 2.75 V , whereas negative current is represented by output voltages from 250 mV to 1.5 V . The difference amplifier is the [INA213](#) current-shunt monitor, whose supply and reference voltages are supplied by the low-drift REF1930.

10.2 Typical Application

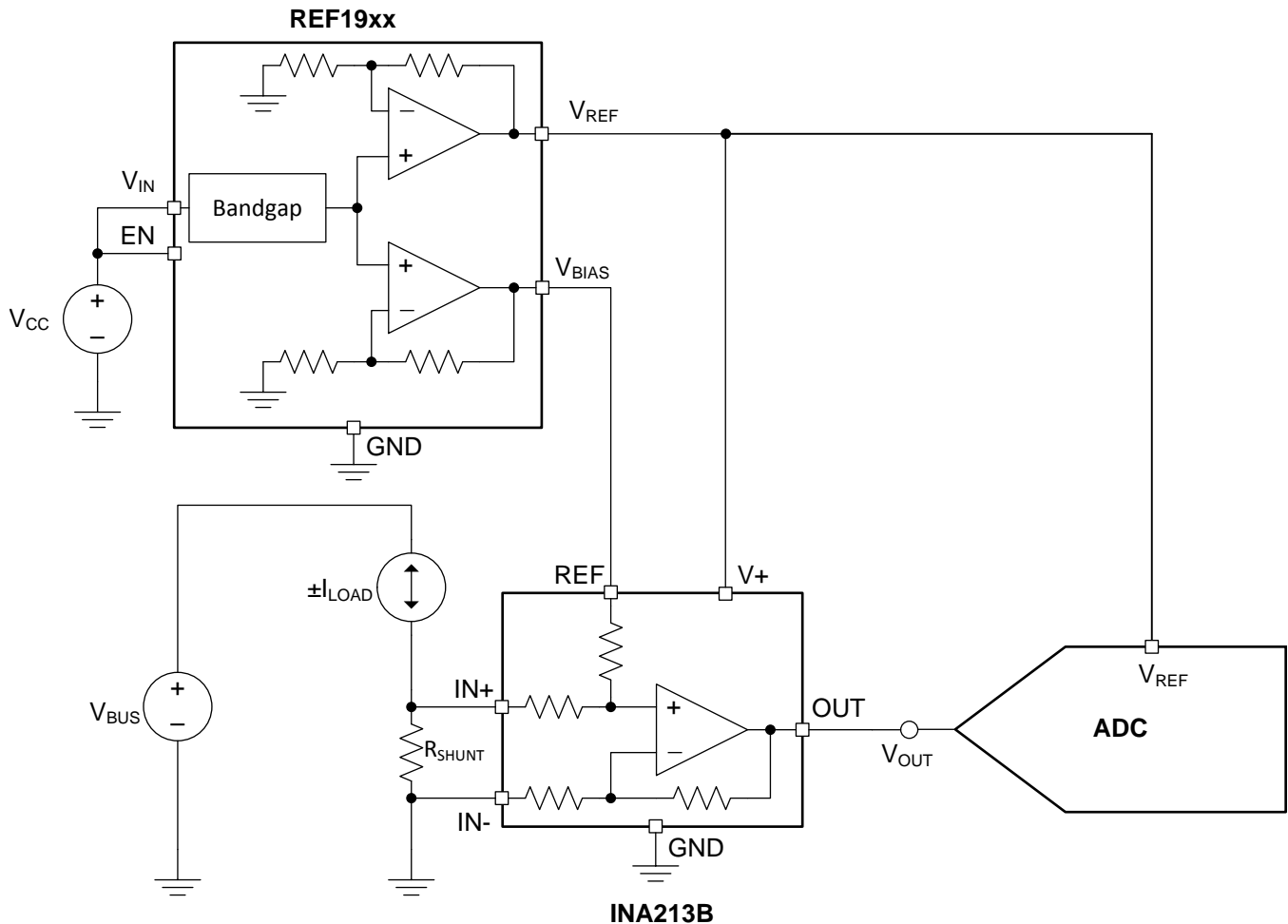

Figure 45. Low-Side, Current-Sensing Application

Typical Application (continued)

10.2.1 Design Requirements

The design requirements are as follows:

1. Supply voltage: 5.0 V
2. Load current: ± 2.5 A
3. Output: 250 mV to 2.75 V
4. Maximum shunt voltage: ± 25 mV

10.2.2 Detailed Design Procedure

Low-side current sensing is desirable because the common-mode voltage is near ground. Therefore, the current-sensing solution is independent of the bus voltage, V_{BUS} . When sensing bidirectional currents, use a differential amplifier with a reference pin. This procedure allows for the differentiation between positive and negative currents by biasing the output stage such that it can respond to negative input voltages. There are a variety of methods for supplying power ($V+$) and the reference voltage (V_{REF} , or V_{BIAS}) to the differential amplifier. For a low-drift solution, use a monolithic reference that supplies both power and the reference voltage. [Figure 46](#) shows the general circuit topology for a low-drift, low-side, bidirectional, current-sensing solution. This topology is particularly useful when interfacing with an ADC; see [Figure 45](#). Not only do V_{REF} and V_{BIAS} track over temperature, but their matching is much better than alternate topologies. For a more detailed version of the design procedure, refer to [TIDU357](#).

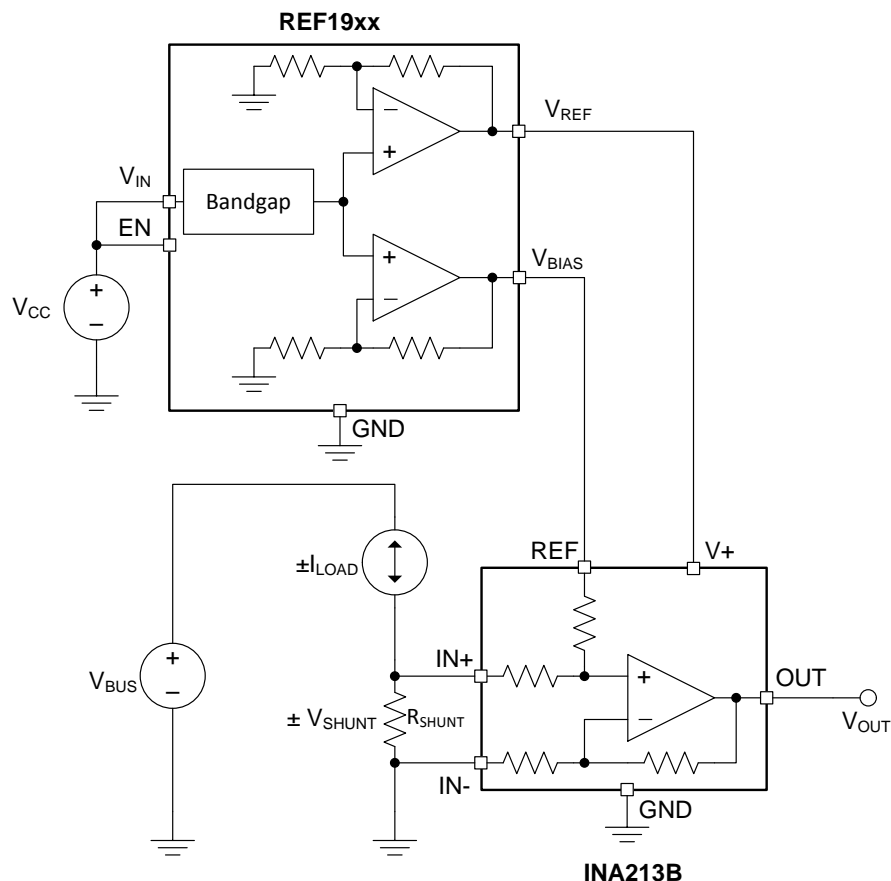

Figure 46. Low-Drift, Low-side, Bidirectional, Current-Sensing Circuit Topology

The transfer function for the circuit given in [Figure 46](#) is as shown in [Equation 5](#):

$$\begin{aligned}
 V_{OUT} &= G \cdot (\pm V_{SHUNT}) + V_{BIAS} \\
 &= G \cdot (\pm I_{LOAD} \cdot R_{SHUNT}) + V_{BIAS}
 \end{aligned}
 \tag{5}$$

Typical Application (continued)

10.2.2.1 Shunt Resistor

As illustrated in [Figure 46](#), the value of V_{SHUNT} is the ground potential for the system load. If the value of V_{SHUNT} is too large, issues may arise when interfacing with systems whose ground potential is actually 0 V. Also, a value of V_{SHUNT} that is too negative may violate the input common-mode voltage of the differential amplifier in addition to potential interfacing issues. Therefore, limiting the voltage across the shunt resistor is important. [Equation 6](#) can be used to calculate the maximum value of R_{SHUNT} .

$$R_{SHUNT(max)} = \frac{V_{SHUNT(max)}}{I_{LOAD(max)}} \tag{6}$$

Given that the maximum shunt voltage is ± 25 mV and the load current range is ± 2.5 A, the maximum shunt resistance is calculated as shown in [Equation 7](#).

$$R_{SHUNT(max)} = \frac{V_{SHUNT(max)}}{I_{LOAD(max)}} = \frac{25mV}{2.5A} = 10m\Omega \tag{7}$$

To minimize errors over temperature, select a low-drift shunt resistor. To minimize offset error, select a shunt resistor with the lowest tolerance. For this design, the Y14870R01000B9W resistor is used.

10.2.2.2 Differential Amplifier

The differential amplifier used for this design must have the following features:

1. Single supply (3 V),
2. Reference voltage input,
3. Low initial input offset voltage (V_{OS}),
4. Low-drift,
5. Fixed gain, and
6. Low-side sensing (input common-mode range below ground).

For this design, a current-shunt monitor (INA213) is used. The INA21x family topology is shown in [Figure 47](#). The INA213B specifications can be found in the [INA213 product data sheet](#).

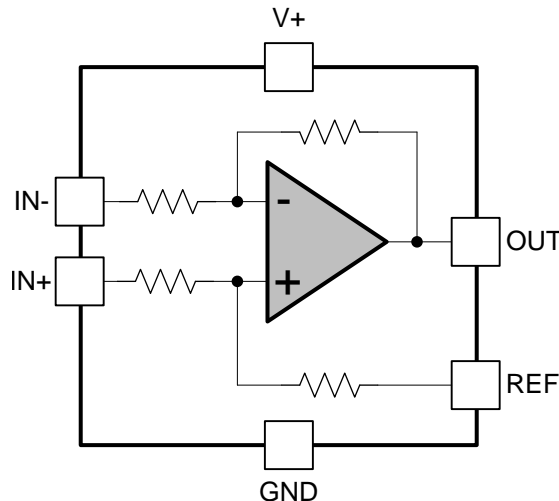

Figure 47. INA21x Current-Shunt Monitor Topology

The INA213B is an excellent choice for this application because all the required features are included. In general, instrumentation amplifiers (INAs) do not have the input common-mode swing to ground that is essential for this application. In addition, INAs require external resistors to set their gain, which is not desirable for low-drift applications. Difference amplifiers typically have larger input bias currents, which reduce solution accuracy at small load currents. Difference amplifiers typically have a gain of 1 V/V. When the gain is adjustable, these amplifiers use external resistors that are not conducive to low-drift applications.

Typical Application (continued)

10.2.2.3 Voltage Reference

The voltage reference for this application must have the following features:

1. Dual output (3.0 V and 1.5 V),
2. Low drift, and
3. Low tracking errors between the two outputs.

For this design, the REF1930 is used. The REF19xx topology is as shown in the [Functional Block Diagram](#) section.

The REF1930 is an excellent choice for this application because of its dual output. The temperature drift of 25 ppm/°C and initial accuracy of 0.1% make the errors resulting from the voltage reference minimal in this application. In addition, there is minimal mismatch between the two outputs and both outputs track very well across temperature, as shown in [Figure 48](#) and [Figure 49](#).

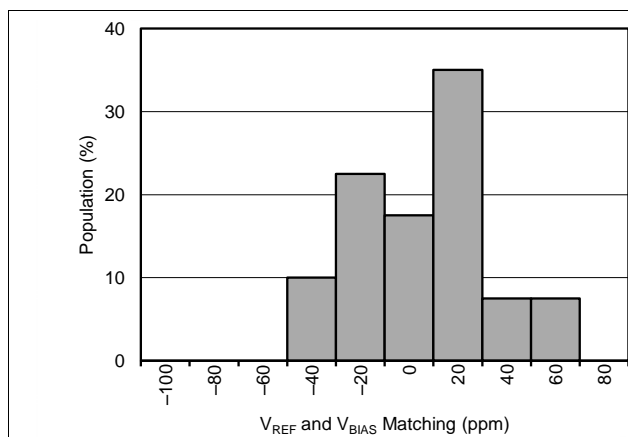

Figure 48. V_{REF} - 2 × V_{BIAS} Distribution (At T_A = 25°C)

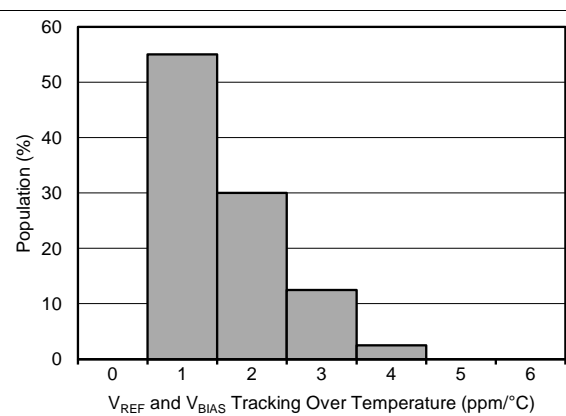

Figure 49. Distribution of V_{REF} - 2 × V_{BIAS} Drift Tracking Over Temperature

10.2.2.4 Results

Table 1 summarizes the measured results.

Table 1. Measured Results

ERROR	UNCALIBRATED (%)	CALIBRATED (%)
Error across the full load current range (25°C)	±0.0355	±0.004
Error across the full load current range (-40°C to 125°C)	±0.0522	±0.0606

10.2.3 Application Curves

Performing a two-point calibration at 25°C removes the errors associated with offset voltage, gain error, and so forth. [Figure 50](#) to [Figure 52](#) show the measured error at different conditions. For a more detailed description on measurement procedure, calibration, and calculations, please refer to [TIDU357](#).

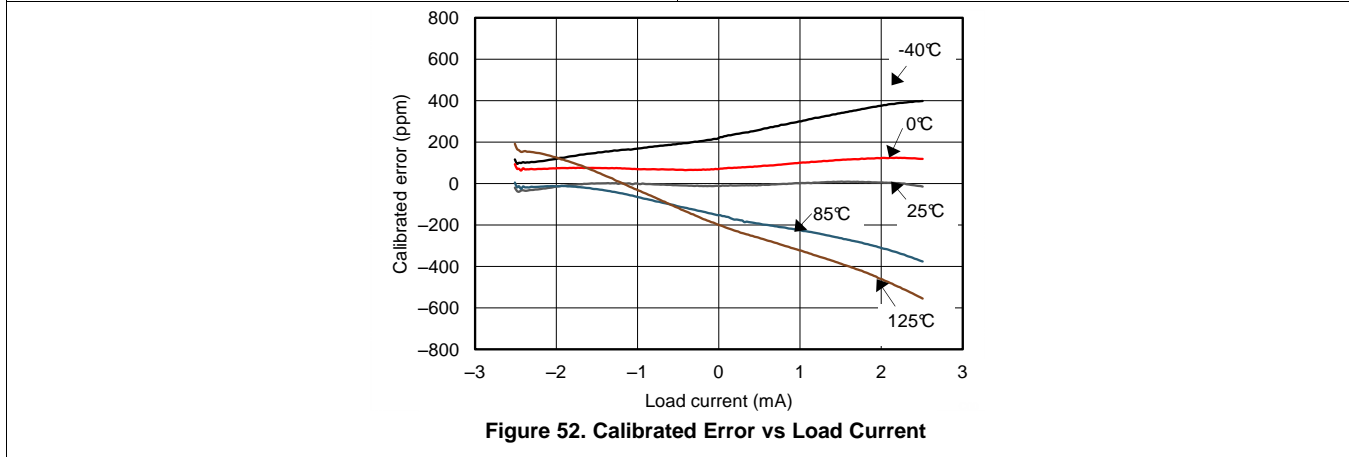
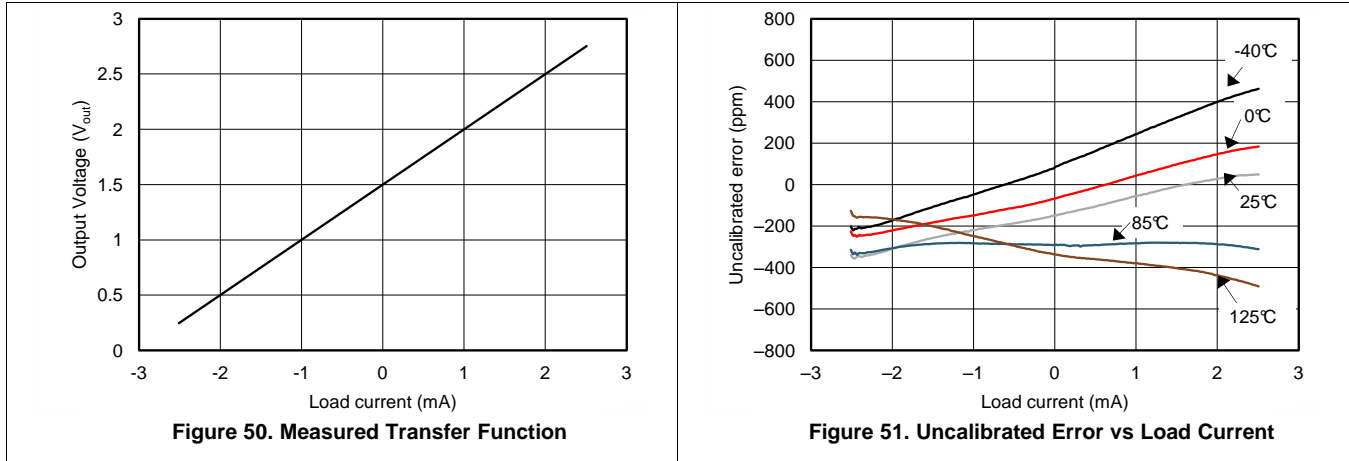

11 Power-Supply Recommendations

The REF19xx family of references feature an extremely low-dropout voltage. These references can be operated with a supply of only 20 mV above the output voltage. For loaded reference conditions, a typical dropout voltage versus load is shown in [Figure 53](#). A supply bypass capacitor ranging between 0.1 μF to 10 μF is recommended.

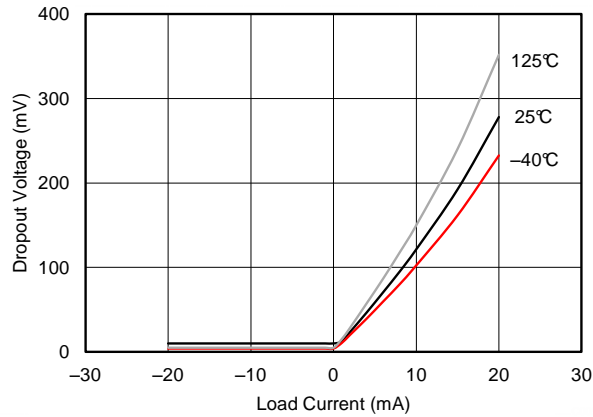

Figure 53. Dropout Voltage vs Load Current

12 Layout

12.1 Layout Guidelines

Figure 54 shows an example of a PCB layout for a data acquisition system using the REF1930. Some key considerations are:

- Connect low-ESR, 0.1- μ F ceramic bypass capacitors at V_{IN} , V_{REF} , and V_{BIAS} of the REF1930.
- Decouple other active devices in the system per the device specifications.
- Using a solid ground plane helps distribute heat and reduces electromagnetic interference (EMI) noise pickup.
- Place the external components as close to the device as possible. This configuration prevents parasitic errors (such as the Seebeck effect) from occurring.
- Minimize trace length between the reference and bias connections to the INA and ADC to reduce noise pickup.
- Do not run sensitive analog traces in parallel with digital traces. Avoid crossing digital and analog traces if possible and only make perpendicular crossings when absolutely necessary.

12.2 Layout Example

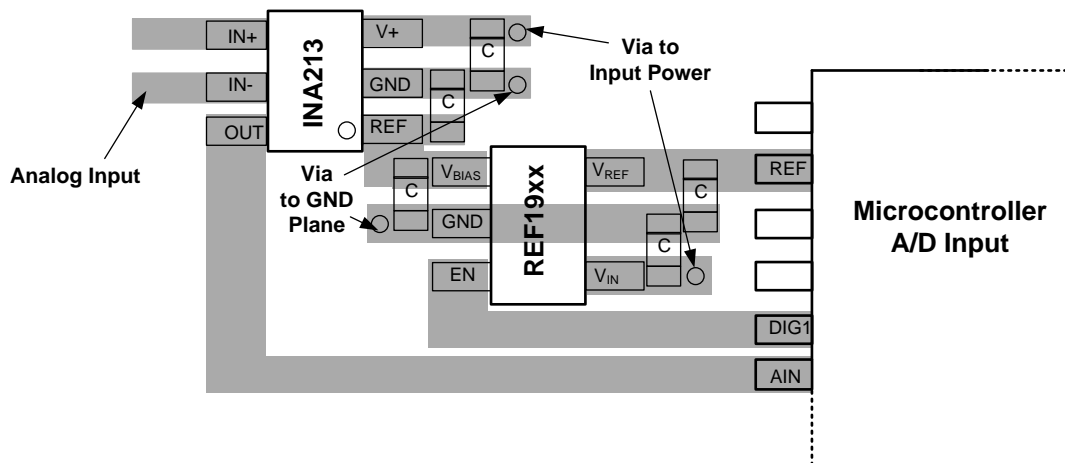

Figure 54. Layout Example

13 Device and Documentation Support

13.1 Documentation Support

13.1.1 Related Documentation

For related documentation see the following:

- [INA21x Voltage Output, Low- or High-Side Measurement, Bidirectional, Zero-Drift Series, Current-Shunt Monitors](#) (SBOS437)
- [Low-Drift Bidirectional Single-Supply Low-Side Current Sensing Reference Design](#) (TIDU357)

13.2 Related Links

The table below lists quick access links. Categories include technical documents, support and community resources, tools and software, and quick access to sample or buy.

Table 2. Related Links

PARTS	PRODUCT FOLDER	SAMPLE & BUY	TECHNICAL DOCUMENTS	TOOLS & SOFTWARE	SUPPORT & COMMUNITY
REF1925	Click here	Click here	Click here	Click here	Click here
REF1930	Click here	Click here	Click here	Click here	Click here
REF1933	Click here	Click here	Click here	Click here	Click here
REF1941	Click here	Click here	Click here	Click here	Click here

13.3 Receiving Notification of Documentation Updates

To receive notification of documentation updates, navigate to the device product folder on ti.com. In the upper right corner, click on *Alert me* to register and receive a weekly digest of any product information that has changed. For change details, review the revision history included in any revised document.

13.4 Community Resources

The following links connect to TI community resources. Linked contents are provided "AS IS" by the respective contributors. They do not constitute TI specifications and do not necessarily reflect TI's views; see TI's [Terms of Use](#).

TI E2E™ Online Community *TI's Engineer-to-Engineer (E2E) Community*. Created to foster collaboration among engineers. At e2e.ti.com, you can ask questions, share knowledge, explore ideas and help solve problems with fellow engineers.

Design Support *TI's Design Support* Quickly find helpful E2E forums along with design support tools and contact information for technical support.

13.5 Trademarks

E2E is a trademark of Texas Instruments.

e-Trim is a trademark of Texas Instruments, Inc.

All other trademarks are the property of their respective owners.

13.6 Electrostatic Discharge Caution



This integrated circuit can be damaged by ESD. Texas Instruments recommends that all integrated circuits be handled with appropriate precautions. Failure to observe proper handling and installation procedures can cause damage.

ESD damage can range from subtle performance degradation to complete device failure. Precision integrated circuits may be more susceptible to damage because very small parametric changes could cause the device not to meet its published specifications.

13.7 Glossary

SLYZ022 — *TI Glossary*.

This glossary lists and explains terms, acronyms, and definitions.

14 Mechanical, Packaging, and Orderable Information

The following pages include mechanical packaging and orderable information. This information is the most current data available for the designated devices. This data is subject to change without notice and revision of this document. For browser-based versions of this data sheet, refer to the left-hand navigation.

PACKAGING INFORMATION

Orderable part number	Status (1)	Material type (2)	Package Pins	Package qty Carrier	RoHS (3)	Lead finish/ Ball material (4)	MSL rating/ Peak reflow (5)	Op temp (°C)	Part marking (6)
REF1925AIDDCR	Active	Production	SOT-23-THIN (DDC) 5	3000 LARGE T&R	Yes	NIPDAU	Level-2-260C-1 YEAR	-40 to 125	GAGM
REF1925AIDDCR.B	Active	Production	SOT-23-THIN (DDC) 5	3000 LARGE T&R	Yes	NIPDAU	Level-2-260C-1 YEAR	-40 to 125	GAGM
REF1925AIDDCCT	Active	Production	SOT-23-THIN (DDC) 5	250 SMALL T&R	Yes	NIPDAU	Level-2-260C-1 YEAR	-40 to 125	GAGM
REF1925AIDDCCT.B	Active	Production	SOT-23-THIN (DDC) 5	250 SMALL T&R	Yes	NIPDAU	Level-2-260C-1 YEAR	-40 to 125	GAGM
REF1925AIDDCCTG4	Active	Production	SOT-23-THIN (DDC) 5	250 SMALL T&R	Yes	NIPDAU	Level-2-260C-1 YEAR	-40 to 125	GAGM
REF1925AIDDCCTG4.B	Active	Production	SOT-23-THIN (DDC) 5	250 SMALL T&R	Yes	NIPDAU	Level-2-260C-1 YEAR	-40 to 125	GAGM
REF1930AIDDCR	Active	Production	SOT-23-THIN (DDC) 5	3000 LARGE T&R	Yes	NIPDAU	Level-2-260C-1 YEAR	-40 to 125	GAHM
REF1930AIDDCR.B	Active	Production	SOT-23-THIN (DDC) 5	3000 LARGE T&R	Yes	NIPDAU	Level-2-260C-1 YEAR	-40 to 125	GAHM
REF1930AIDDCCT	Active	Production	SOT-23-THIN (DDC) 5	250 SMALL T&R	Yes	NIPDAU	Level-2-260C-1 YEAR	-40 to 125	GAHM
REF1930AIDDCCT.B	Active	Production	SOT-23-THIN (DDC) 5	250 SMALL T&R	Yes	NIPDAU	Level-2-260C-1 YEAR	-40 to 125	GAHM
REF1930AIDDCCTG4	Active	Production	SOT-23-THIN (DDC) 5	250 SMALL T&R	Yes	NIPDAU	Level-2-260C-1 YEAR	-40 to 125	GAHM
REF1930AIDDCCTG4.B	Active	Production	SOT-23-THIN (DDC) 5	250 SMALL T&R	Yes	NIPDAU	Level-2-260C-1 YEAR	-40 to 125	GAHM
REF1933AIDDCR	Active	Production	SOT-23-THIN (DDC) 5	3000 LARGE T&R	Yes	NIPDAU	Level-2-260C-1 YEAR	-40 to 125	GAIM
REF1933AIDDCR.B	Active	Production	SOT-23-THIN (DDC) 5	3000 LARGE T&R	Yes	NIPDAU	Level-2-260C-1 YEAR	-40 to 125	GAIM
REF1933AIDDCCT	Active	Production	SOT-23-THIN (DDC) 5	250 SMALL T&R	Yes	NIPDAU	Level-2-260C-1 YEAR	-40 to 125	GAIM
REF1933AIDDCCT.B	Active	Production	SOT-23-THIN (DDC) 5	250 SMALL T&R	Yes	NIPDAU	Level-2-260C-1 YEAR	-40 to 125	GAIM

Orderable part number	Status (1)	Material type (2)	Package Pins	Package qty Carrier	RoHS (3)	Lead finish/ Ball material (4)	MSL rating/ Peak reflow (5)	Op temp (°C)	Part marking (6)
REF1933AIDDCTG4	Active	Production	SOT-23-THIN (DDC) 5	250 SMALL T&R	Yes	NIPDAU	Level-2-260C-1 YEAR	-40 to 125	GAJM
REF1933AIDDCTG4.B	Active	Production	SOT-23-THIN (DDC) 5	250 SMALL T&R	Yes	NIPDAU	Level-2-260C-1 YEAR	-40 to 125	GAJM
REF1941AIDDCR	Active	Production	SOT-23-THIN (DDC) 5	3000 LARGE T&R	Yes	NIPDAU	Level-2-260C-1 YEAR	-40 to 125	GAJM
REF1941AIDDCR.B	Active	Production	SOT-23-THIN (DDC) 5	3000 LARGE T&R	Yes	NIPDAU	Level-2-260C-1 YEAR	-40 to 125	GAJM
REF1941AIDDCT	Active	Production	SOT-23-THIN (DDC) 5	250 SMALL T&R	Yes	NIPDAU	Level-2-260C-1 YEAR	-40 to 125	GAJM
REF1941AIDDCT.B	Active	Production	SOT-23-THIN (DDC) 5	250 SMALL T&R	Yes	NIPDAU	Level-2-260C-1 YEAR	-40 to 125	GAJM

(1) **Status:** For more details on status, see our [product life cycle](#).

(2) **Material type:** When designated, preproduction parts are prototypes/experimental devices, and are not yet approved or released for full production. Testing and final process, including without limitation quality assurance, reliability performance testing, and/or process qualification, may not yet be complete, and this item is subject to further changes or possible discontinuation. If available for ordering, purchases will be subject to an additional waiver at checkout, and are intended for early internal evaluation purposes only. These items are sold without warranties of any kind.

(3) **RoHS values:** Yes, No, RoHS Exempt. See the [TI RoHS Statement](#) for additional information and value definition.

(4) **Lead finish/Ball material:** Parts may have multiple material finish options. Finish options are separated by a vertical ruled line. Lead finish/Ball material values may wrap to two lines if the finish value exceeds the maximum column width.

(5) **MSL rating/Peak reflow:** The moisture sensitivity level ratings and peak solder (reflow) temperatures. In the event that a part has multiple moisture sensitivity ratings, only the lowest level per JEDEC standards is shown. Refer to the shipping label for the actual reflow temperature that will be used to mount the part to the printed circuit board.

(6) **Part marking:** There may be an additional marking, which relates to the logo, the lot trace code information, or the environmental category of the part.

Multiple part markings will be inside parentheses. Only one part marking contained in parentheses and separated by a "-" will appear on a part. If a line is indented then it is a continuation of the previous line and the two combined represent the entire part marking for that device.

Important Information and Disclaimer: The information provided on this page represents TI's knowledge and belief as of the date that it is provided. TI bases its knowledge and belief on information provided by third parties, and makes no representation or warranty as to the accuracy of such information. Efforts are underway to better integrate information from third parties. TI has taken and continues to take reasonable steps to provide representative

and accurate information but may not have conducted destructive testing or chemical analysis on incoming materials and chemicals. TI and TI suppliers consider certain information to be proprietary, and thus CAS numbers and other limited information may not be available for release.

In no event shall TI's liability arising out of such information exceed the total purchase price of the TI part(s) at issue in this document sold by TI to Customer on an annual basis.

TAPE AND REEL INFORMATION

QUADRANT ASSIGNMENTS FOR PIN 1 ORIENTATION IN TAPE

*All dimensions are nominal

Device	Package Type	Package Drawing	Pins	SPQ	Reel Diameter (mm)	Reel Width W1 (mm)	A0 (mm)	B0 (mm)	K0 (mm)	P1 (mm)	W (mm)	Pin1 Quadrant
REF1925AIDDCR	SOT-23-THIN	DDC	5	3000	179.0	8.4	3.2	3.2	1.4	4.0	8.0	Q3
REF1925AIDDCT	SOT-23-THIN	DDC	5	250	179.0	8.4	3.2	3.2	1.4	4.0	8.0	Q3
REF1925AIDDCTG4	SOT-23-THIN	DDC	5	250	179.0	8.4	3.2	3.2	1.4	4.0	8.0	Q3
REF1930AIDDCR	SOT-23-THIN	DDC	5	3000	179.0	8.4	3.2	3.2	1.4	4.0	8.0	Q3
REF1930AIDDCT	SOT-23-THIN	DDC	5	250	179.0	8.4	3.2	3.2	1.4	4.0	8.0	Q3
REF1930AIDDCTG4	SOT-23-THIN	DDC	5	250	179.0	8.4	3.2	3.2	1.4	4.0	8.0	Q3
REF1933AIDDCR	SOT-23-THIN	DDC	5	3000	179.0	8.4	3.2	3.2	1.4	4.0	8.0	Q3
REF1933AIDDCT	SOT-23-THIN	DDC	5	250	179.0	8.4	3.2	3.2	1.4	4.0	8.0	Q3
REF1933AIDDCTG4	SOT-23-THIN	DDC	5	250	179.0	8.4	3.2	3.2	1.4	4.0	8.0	Q3

Device	Package Type	Package Drawing	Pins	SPQ	Reel Diameter (mm)	Reel Width W1 (mm)	A0 (mm)	B0 (mm)	K0 (mm)	P1 (mm)	W (mm)	Pin1 Quadrant
REF1941AIDDCR	SOT-23-THIN	DDC	5	3000	179.0	8.4	3.2	3.2	1.4	4.0	8.0	Q3
REF1941AIDDCT	SOT-23-THIN	DDC	5	250	179.0	8.4	3.2	3.2	1.4	4.0	8.0	Q3

TAPE AND REEL BOX DIMENSIONS

*All dimensions are nominal

Device	Package Type	Package Drawing	Pins	SPQ	Length (mm)	Width (mm)	Height (mm)
REF1925AIDDCR	SOT-23-THIN	DDC	5	3000	213.0	191.0	35.0
REF1925AIDDCT	SOT-23-THIN	DDC	5	250	213.0	191.0	35.0
REF1925AIDDCTG4	SOT-23-THIN	DDC	5	250	213.0	191.0	35.0
REF1930AIDDCR	SOT-23-THIN	DDC	5	3000	213.0	191.0	35.0
REF1930AIDDCT	SOT-23-THIN	DDC	5	250	213.0	191.0	35.0
REF1930AIDDCTG4	SOT-23-THIN	DDC	5	250	213.0	191.0	35.0
REF1933AIDDCR	SOT-23-THIN	DDC	5	3000	213.0	191.0	35.0
REF1933AIDDCT	SOT-23-THIN	DDC	5	250	213.0	191.0	35.0
REF1933AIDDCTG4	SOT-23-THIN	DDC	5	250	213.0	191.0	35.0
REF1941AIDDCR	SOT-23-THIN	DDC	5	3000	213.0	191.0	35.0
REF1941AIDDCT	SOT-23-THIN	DDC	5	250	213.0	191.0	35.0

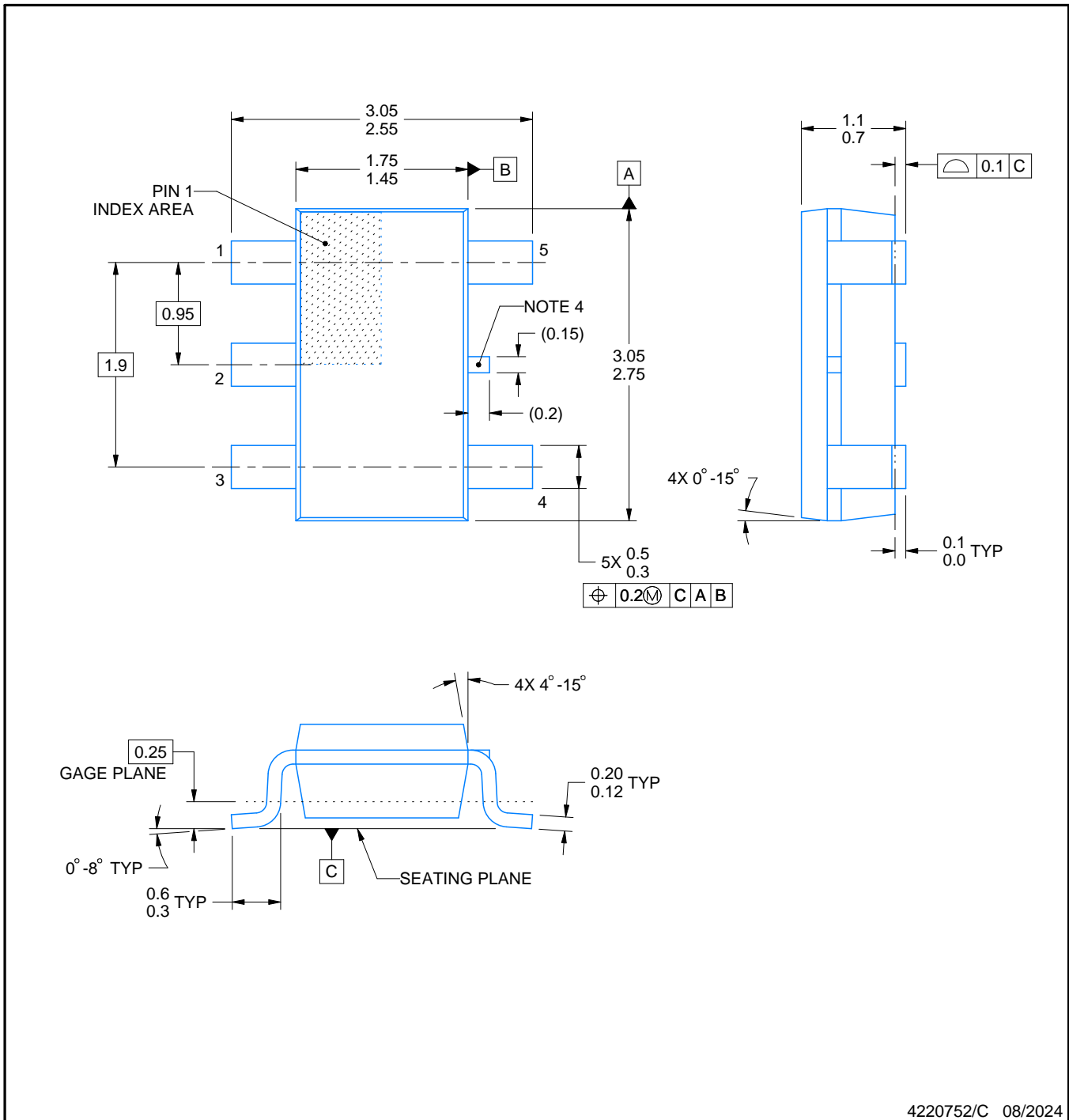

4220752/C 08/2024

NOTES:

1. All linear dimensions are in millimeters. Any dimensions in parenthesis are for reference only. Dimensioning and tolerancing per ASME Y14.5M.
2. This drawing is subject to change without notice.
3. Reference JEDEC MO-193.
4. Support pin may differ or may not be present.

EXAMPLE BOARD LAYOUT

DDC0005A

SOT-23 - 1.1 max height

SMALL OUTLINE TRANSISTOR

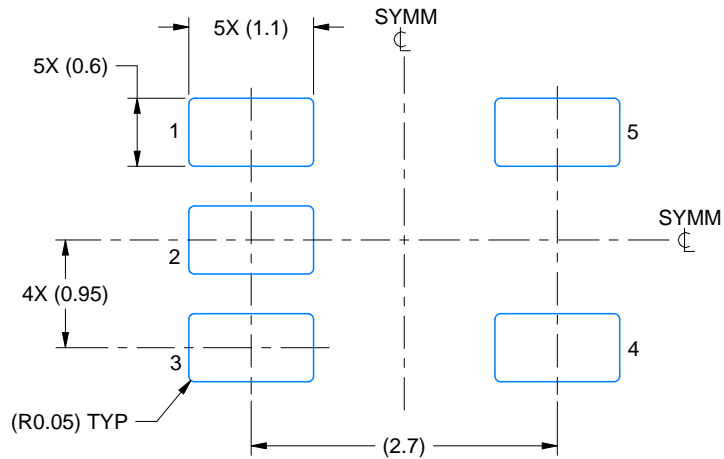

LAND PATTERN EXAMPLE
EXPLODED METAL SHOWN
SCALE:15X



SOLDERMASK DETAILS

4220752/C 08/2024

NOTES: (continued)

- Publication IPC-7351 may have alternate designs.
- Solder mask tolerances between and around signal pads can vary based on board fabrication site.

EXAMPLE STENCIL DESIGN

DDC0005A

SOT-23 - 1.1 max height

SMALL OUTLINE TRANSISTOR

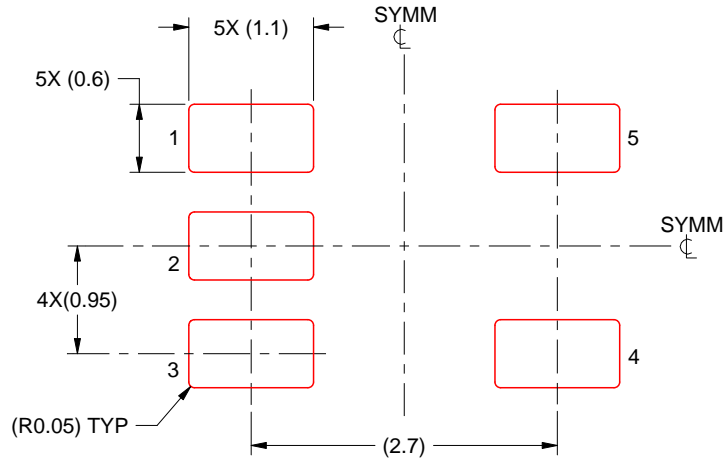

SOLDER PASTE EXAMPLE
BASED ON 0.125 THICK STENCIL
SCALE:15X

4220752/C 08/2024

NOTES: (continued)

6. Laser cutting apertures with trapezoidal walls and rounded corners may offer better paste release. IPC-7525 may have alternate design recommendations.
7. Board assembly site may have different recommendations for stencil design.

IMPORTANT NOTICE AND DISCLAIMER

TI PROVIDES TECHNICAL AND RELIABILITY DATA (INCLUDING DATASHEETS), DESIGN RESOURCES (INCLUDING REFERENCE DESIGNS), APPLICATION OR OTHER DESIGN ADVICE, WEB TOOLS, SAFETY INFORMATION, AND OTHER RESOURCES "AS IS" AND WITH ALL FAULTS, AND DISCLAIMS ALL WARRANTIES, EXPRESS AND IMPLIED, INCLUDING WITHOUT LIMITATION ANY IMPLIED WARRANTIES OF MERCHANTABILITY, FITNESS FOR A PARTICULAR PURPOSE OR NON-INFRINGEMENT OF THIRD PARTY INTELLECTUAL PROPERTY RIGHTS.

These resources are intended for skilled developers designing with TI products. You are solely responsible for (1) selecting the appropriate TI products for your application, (2) designing, validating and testing your application, and (3) ensuring your application meets applicable standards, and any other safety, security, regulatory or other requirements.

These resources are subject to change without notice. TI grants you permission to use these resources only for development of an application that uses the TI products described in the resource. Other reproduction and display of these resources is prohibited. No license is granted to any other TI intellectual property right or to any third party intellectual property right. TI disclaims responsibility for, and you fully indemnify TI and its representatives against any claims, damages, costs, losses, and liabilities arising out of your use of these resources.

TI's products are provided subject to [TI's Terms of Sale](#), [TI's General Quality Guidelines](#), or other applicable terms available either on [ti.com](#) or provided in conjunction with such TI products. TI's provision of these resources does not expand or otherwise alter TI's applicable warranties or warranty disclaimers for TI products. Unless TI explicitly designates a product as custom or customer-specified, TI products are standard, catalog, general purpose devices.

TI objects to and rejects any additional or different terms you may propose.

Copyright © 2025, Texas Instruments Incorporated

Last updated 10/2025