

TLV3011-EP および TLV3012-EP エンハンスド製品、低消費電力コンパレータ、1.24V 基準電圧内蔵

1 特長

- VID V62/07604-01XE (TLV3011-EP)
- VID V62/23603-01XE (TLV3012-EP)
- 管理されたベースライン
 - 単一のアセンブリ - テスト施設
 - 単一の製造施設
 - 長い製品ライフ・サイクル
- 拡張 DMS (Diminishing Manufacturing Sources) サポート
- $-55^{\circ}\text{C} \sim 125^{\circ}\text{C}$ の拡張温度範囲
- 低静止電流: $3.1\mu\text{A}$ (最大値)
- シリーズ基準電圧内蔵: 1.242V
- 入力同相範囲: レールの 200mV 外まで
- 基準電圧の初期精度: 1%
- オープン・ドレイン出力 (TLV3011-EP)
- プッシュプル出力 (TLV3012-EP)
- 相互ヒステリシス (TLV3012-EP のみ)
- フェイルセーフ入力 (TLV3012-EP のみ)
- パワーオン・リセット (TLV3012-EP のみ)
- 電源電圧範囲: $1.65\text{V} \sim 5.5\text{V}$ (TLV3012-EP のみ)
- 迅速な応答時間: $2\mu\text{s}$
- 超小型パッケージ: SOT-23-6

2 アプリケーション

- バッテリ駆動の液面検出
- データ・アクイジション
- システム監視
- 発振器
- センサ・システム

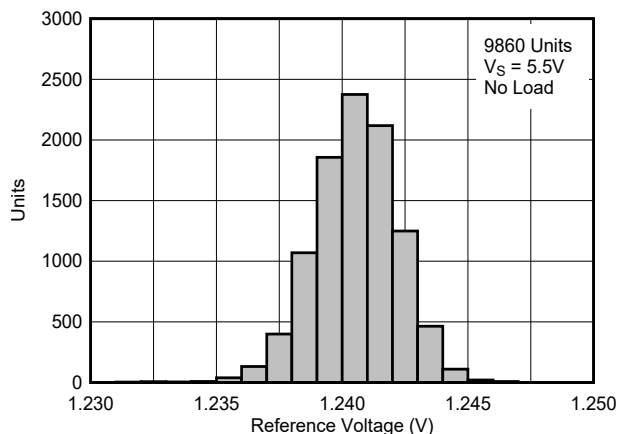

TLV3012-EP 基準電圧の分布

3 概要

TLV3011-EP は低消費電力オープン・ドレイン出力のコンパレータです。TLV3012-EP はプッシュプル出力のコンパレータです。どちらのデバイスも、不確定なオンチップ基準電圧を採用しており、静止電流が $3.1\mu\text{A}$ (最大値)、電源レールを上回る 200mV 入力同相範囲、 $1.65\text{V} \sim 5.5\text{V}$ の単一電源で動作します。

内蔵 1.242V シリーズ基準電圧は、 $100\text{ppm}/^{\circ}\text{C}$ (最大値) の低ドリフトを実現し、最大 10nF の容量性負荷で安定しており、最大 0.5mA (標準値) の出力電流をシンクまたはソースできるため、外部回路を駆動できます。

TLV3011-EP および TLV3012-EP は、スペースに制約のある設計向けの小型 SOT-23-6 パッケージで供給されます。これらのデバイスは、 $-55^{\circ}\text{C} \sim 125^{\circ}\text{C}$ の拡張温度範囲で動作が規定されています。

表 3-1. 製品情報

部品番号	パッケージ (1)	本体サイズ (公称)
TLV3011-EP、 TLV3012-EP	SOT-23 (6)	2.90mm × 1.60mm

- (1) 利用可能なパッケージについては、このデータシートの末尾にある注文情報を参照してください。

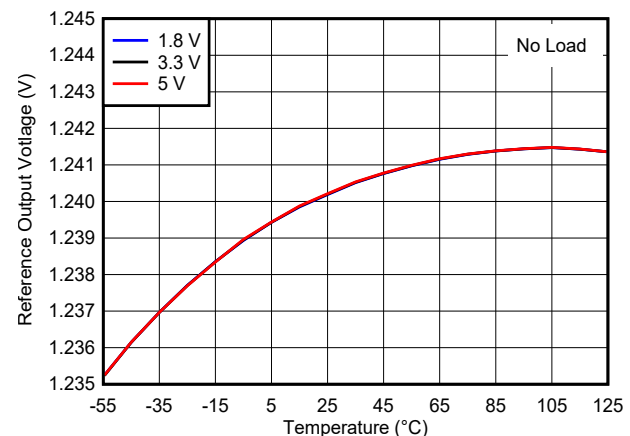

TLV3012-EP 基準電圧と温度との関係



Table of Contents

1 特長	1	7 Detailed Description	18
2 アプリケーション	1	7.1 Overview.....	18
3 概要	1	7.2 Functional Block Diagram.....	18
4 Revision History	2	7.3 Feature Description.....	18
5 Pin Configuration and Functions	3	7.4 Device Functional Modes.....	18
6 Specifications	4	8 Application and Implementation	20
6.1 Absolute Maximum Ratings - TLV3011-EP.....	4	8.1 Application Information.....	20
6.2 Absolute Maximum Ratings - TLV3012-EP.....	4	8.2 Typical Application.....	21
6.3 ESD Ratings.....	4	8.3 Power Supply Recommendations.....	23
6.4 Thermal Resistance Characteristics.....	5	8.4 Layout.....	23
6.5 Recommended Operating Conditions - TLV3011-EP.....	5	9 Device and Documentation Support	24
6.6 Recommended Operating Conditions - TLV3012-EP.....	5	9.1 ドキュメントの更新通知を受け取る方法.....	24
6.7 Electrical Characteristics - TLV3011-EP.....	6	9.2 サポート・リソース.....	24
6.8 Electrical Characteristics - TLV3012-EP.....	7	9.3 Trademarks.....	24
6.9 Switching Characteristics - TLV3012-EP.....	8	9.4 静電気放電に関する注意事項.....	24
6.10 Typical Characteristics - TLV3011-EP.....	9	9.5 用語集.....	24
6.11 Typical Characteristics - TLV3012-EP.....	12	10 Mechanical, Packaging, and Orderable Information	25

4 Revision History

資料番号末尾の英字は改訂を表しています。その改訂履歴は英語版に準じています。

Changes from Revision * (October 2006) to Revision A (May 2023)	Page
• ドキュメント全体にわたって表、図、相互参照の採番方法を更新.....	1
• TLV3012-EP デバイスを追加.....	1
• 新しいデバイスの「特長」、「概要」、「製品情報」表を更新.....	1
• Added TLV3012-EP <i>Electirical Characteristics</i> Tables.....	4
• Added TLV3012-EP <i>Typical Characteristics</i> graphs.....	12
• Updated <i>Detailed Description</i> section.....	18

5 Pin Configuration and Functions



表 5-1. Pin Functions

PIN		TYPE ⁽¹⁾	DESCRIPTION
NAME	NO.		
OUT	1	O	Comparator Output
V-	2	P	Negative Supply Voltage
IN+	3	I	Non-Inverting (Positive) Input
IN-	4	I	Inverting (Negative) Input
REF	5	O	Reference Voltage Output
V+	6	P	Positive Supply Voltage

6 Specifications

6.1 Absolute Maximum Ratings - TLV3011-EP

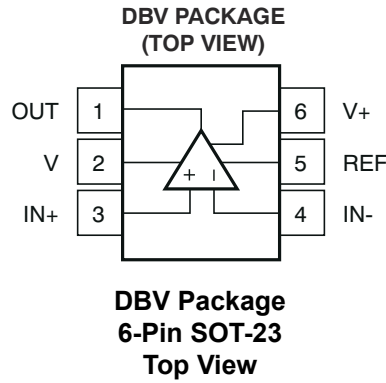
over operating free-air temperature range (unless otherwise noted)⁽¹⁾

		MIN	MAX	UNIT	
	Supply voltage		7	V	
	Signal input terminals	Voltage ⁽²⁾	-0.5	(V+) +0.5	V
		Current ⁽²⁾		±10	mA
	Output short circuit ⁽³⁾		Continuous		
	Operating temperature range	-55	125	°C	
T _{stg}	Storage temperature range	-65	150	°C	
T _J	Junction temperature		150	°C	

- (1) Stresses beyond those listed under "absolute maximum ratings" may cause permanent damage to the device. These are stress ratings only, and functional operation of the device at these or any other conditions beyond those indicated under "recommended operating conditions" is not implied. Exposure to absolute-maximum-rated conditions for extended periods may affect device reliability.
- (2) All voltage values are with respect to the network ground terminal.
- (3) Short circuit to ground

6.2 Absolute Maximum Ratings - TLV3012-EP

over operating free-air temperature range (unless otherwise noted)⁽¹⁾

		MIN	MAX	UNIT
Supply voltage: V _S = (V+) – (V–)		-0.5	7	V
Input pins (IN+, IN–) from (V–) ⁽²⁾		-0.5	7	V
Output (OUT) (Push-Pull) from (V–)		-0.5	(V+) + 0.5	V
Output short circuit current ⁽³⁾			10	mA
Junction temperature, T _J			150	°C
Storage temperature, T _{stg}		-65	150	°C

- (1) Operation outside the Absolute Maximum Ratings may cause permanent device damage. Absolute Maximum Ratings do not imply functional operation of the device at these or any other conditions beyond those listed under Recommended Operating Conditions. If used outside the Recommended Operating Conditions but within the Absolute Maximum Ratings, the device may not be fully functional, and this may affect device reliability, functionality, performance, and shorten the device lifetime.
- (2) Input pins are diode-clamped to (V–). Inputs (IN+, IN–) can be greater than (V+) as long as within the –0.5 V to 7 V range. Inputs beyond –0.3 V must be current-limited to less than –10 mA, while inputs beyond 7 V must be externally voltage clamped.
- (3) Short-circuit to (V–) or (V+).

6.3 ESD Ratings

		VALUE	UNIT
V _(ESD)	Electrostatic discharge	Human-body model (HBM), per ANSI/ESDA/JEDEC JS-001 ⁽¹⁾	±2000
		Charged-device model (CDM), per ANSI/ESDA/JEDEC JS-002 ⁽²⁾ (TLV3012-EP Only)	±1000

- (1) JEDEC document JEP155 states that 500 V HBM allows safe manufacturing with a standard ESD control process.
- (2) JEDEC document JEP157 states that 250 V CDM allows safe manufacturing with a standard ESD control process.

6.4 Thermal Resistance Characteristics

THERMAL METRIC ¹		TLV3011-EP	TLV3012-EP	UNIT
		DBV (SOT-23)	DBV (SOT-23)	
		6 PINS	6 PINS	
$R_{\theta JA}$	Junction-to-ambient thermal resistance	191.9	162.5	°C/W
$R_{\theta JC(top)}$	Junction-to-case (top) thermal resistance	123.9	78.8	°C/W
$R_{\theta JB}$	Junction-to-board thermal resistance	38.7	42.1	°C/W
Ψ_{JT}	Junction-to-top characterization parameter	21.2	21.2	°C/W
Ψ_{JB}	Junction-to-board characterization parameter	38.2	41.9	°C/W

(1) For more information about traditional and new thermal metrics, see the [Semiconductor and IC package thermal metrics](#) report.

6.5 Recommended Operating Conditions - TLV3011-EP

over operating free-air temperature range (unless otherwise noted)

	MIN	MAX	UNIT
Supply voltage: $V_S = (V+) - (V-)$	1.8	5.5	V
Input voltage range from (V-)	-0.2	(V+) + 0.2	V
Output voltage range from (V-)	-0.2	≤ V+	V
Ambient temperature, T_A	-55	125	°C

6.6 Recommended Operating Conditions - TLV3012-EP

over operating free-air temperature range (unless otherwise noted)

	MIN	MAX	UNIT
Supply voltage: $V_S = (V+) - (V-)$	1.65	5.5	V
Input voltage range from (V-)	-0.2	(V+) + 0.2	V
Ambient temperature, T_A	-55	125	°C

6.7 Electrical Characteristics - TLV3011-EP

over operating free-air temperature range (unless otherwise noted)

PARAMETER		TEST CONDITIONS	MIN	TYP	MAX	UNIT
Offset Voltage						
V_{OS}	Input offset voltage	$V_{CM} = 0\text{ V}, I_O = 0\text{ V}$		0.5	15	mV
dV_{OS}/dT	Input offset voltage vs temperature	$T_A = -55^\circ\text{C}$ to 125°C		± 12		$\mu\text{V}/^\circ\text{C}$
PSRR	Power supply rejection ratio	$V_S = 1.8\text{ V}$ to 5.5 V		100	1000	$\mu\text{V}/\text{V}$
Input Bias Current						
I_S	Input bias current	$V_{CM} = V_S/2$		± 10		pA
I_{OS}	Input offset current	$V_{CM} = V_S/2$		± 10		pA
Input Voltage Range						
V_{CM}	Common-mode voltage range		$(V-) - 0.2$		$(V+) + 0.2$	V
CMRR	Common-mode rejection ratio	$V_{CM} = -0.2\text{ V}$ to $(V+) - 1.5\text{ V}$	60	74		dB
		$V_{CM} = -0.2\text{ V}$ to $(V+) + 0.2\text{ V}$	54	62		
Input Impedance						
	Common mode			$10^{13} \parallel 2$		$\Omega \parallel \text{pF}$
	Differential			$10^{13} \parallel 4$		$\Omega \parallel \text{pF}$
Switching Characteristics						
t_{pd}	Propagation delay time	Low to high	$f = 10\text{ kHz}, V_{STEP} = 1\text{ V},$ input overdrive = 10 mV		12	μs
			$f = 10\text{ kHz}, V_{STEP} = 1\text{ V},$ input overdrive = 100 mV		6	
		High to low	$f = 10\text{ kHz}, V_{STEP} = 1\text{ V},$ input overdrive = 10 mV		13.5	
			$f = 10\text{ kHz}, V_{STEP} = 1\text{ V},$ input overdrive = 100 mV		6.5	
t_r	Rise time	$C_L = 10\text{ pF}$		(1)		
t_f	Fall time	$C_L = 10\text{ pF}$		100		ns
Output						
V_{OL}	Voltage output low from rail	$V_S = 5\text{ V}$		160	200	mV
Voltage Reference						
V_{OUT}	Output voltage		1.208	1.242	1.276	V
	Initial accuracy				$\pm 1\%$	
dV_{OUT}/dT	Temperature drift	$-55^\circ\text{C} \leq T_A \leq 125^\circ\text{C}$		40	100	ppm/ $^\circ\text{C}$
dV_{OUT}/dI_{LOAD}	Load regulation	Sourcing	$0\text{ mA} < I_{SOURCE} \leq 0.5\text{ mA}$	0.36	1	mV/mA
		Sinking	$0\text{ mA} < I_{SINK} \leq 0.5\text{ mA}$	6.6		
I_{LOAD}	Output current			0.5		mA
dV_{OUT}/dV_{IN}	Line regulation	$1.8\text{ V} \leq V_{IN} \leq 5.5\text{ V}$		10	100	$\mu\text{V}/\text{V}$
Noise						
	Reference voltage noise	$f = 0.1\text{ Hz}$ to 10 Hz		0.2		mV _{PP}
Power Supply						
V_S	Specified voltage		1.8		5.5	V
	Operating voltage range		1.8		5.5	V
I_Q	Quiescent current	$V_S = 5\text{ V}, V_O = \text{High}$		2.8	5	μA

 (1) t_r dependent on R_{PULLUP} and C_{LOAD} .

6.8 Electrical Characteristics - TLV3012-EP

For V_S (TOTAL SUPPLY VOLTAGE) = $(V+) - (V-) = 1.8V$ and $5.5V$, $V_{CM} = V_S/2$ at $T_A = 25^\circ C$ (Unless otherwise noted)

PARAMETER		TEST CONDITIONS	MIN	TYP	MAX	UNIT
OFFSET VOLTAGE						
V_{OS}	Input offset voltage	$V_{CM} = (V-)$	-6	±0.3	6	mV
V_{OS}	Input offset voltage	$V_{CM} = (V-)$ $T_A = -55^\circ C$ to $+125^\circ C$	-9		9	mV
dV_{IO}/dT	Input offset voltage drift	$V_{CM} = (V-)$ $T_A = -55^\circ C$ to $+125^\circ C$		±12		$\mu V/^\circ C$
PSRR	power supply rejection ratio	$V_{CM} = (V-)$ $V_S = 1.65 V$ to $5.5 V$ $T_A = -55^\circ C$ to $+125^\circ C$		100	1000	$\mu V/V$
V_{HYS}	Input hysteresis voltage	$T_A = -55^\circ C$ to $+125^\circ C$	2	6	8	mV
INPUT BIAS CURRENT						
I_B	Input bias current	$V_{CM} = V_S/2$	-10 ⁽¹⁾	±4.5	10 ⁽¹⁾	pA
I_{OS}	Input offset current	$V_{CM} = V_S/2$	-10 ⁽¹⁾	±1	10 ⁽¹⁾	pA
INPUT COMMON MODE RANGE						
V_{CM} -Range	Common-mode voltage range	$V_S = 1.8 V$ to $5.5 V$ $T_A = -55^\circ C$ to $+125^\circ C$	$(V-) - 0.2$		$(V+) + 0.2$	V
CMRR	Common mode rejection ratio	$V_{CM} = (V-) + 1.5V$ to $(V+) + 0.2V$ $T_A = -55^\circ C$ to $+125^\circ C$	60	74		dB
CMRR	Common mode rejection ratio	$V_{CM} = (V-) - 0.2V$ to $(V+) + 0.2V$ $T_A = -55^\circ C$ to $+125^\circ C$	54	62		dB
R_{CM}	Input Common Mode Resistance			10^{13}		Ω
C_{IC}	Input Common Mode Capacitance			2		pF
INPUT IMPEDANCE						
R_{DM}	Input Differential Mode Resistance			10^{13}		Ω
C_{ID}	Input Differential Mode Capacitance			4		pF
OUTPUT						
V_{OL}	Voltage swing from $(V-)$	$V_S = 5 V$ $I_{SINK} = 5 mA$ $T_A = -55^\circ C$ to $+125^\circ C$		160	200	mV
V_{OH}	Voltage swing from $(V+)$	$V_S = 5 V$ $I_{SOURCE} = 5 mA$ $T_A = -55^\circ C$ to $+125^\circ C$		90	200	mV
VOLTAGE REFERENCE						
V_{OUT}	Reference Voltage		1.223	1.242	1.260	V
	Accuracy			±0.25%	±1.5%	
dV_{OUT}/dT	Temperature Drift	$T_A = -55^\circ C$ to $+125^\circ C$		40	100	ppm/ $^\circ C$
dV_{OUT}/dI_{LOAD}	Load Regulation, Sourcing	$0 mA < I_{SOURCE} \leq 0.5 mA$		0.36	1 ⁽¹⁾	mV/mA
	Load Regulation, Sinking	$0 mA < I_{SINK} \leq 0.5 mA$		6.6		mV/mA
I_{LOAD}	Output Current			0.5		mA
dV_{OUT}/dV_S	Line Regulation	$1.65 V \leq V_S \leq 5.5 V$		10	100 ⁽¹⁾	$\mu V/V$
V_{noise}	Noise	$f = 0.1 Hz$ to $10 Hz$		0.2		mV _{PP}

6.8 Electrical Characteristics - TLV3012-EP (continued)

For V_S (TOTAL SUPPLY VOLTAGE) = $(V+) - (V-) = 1.8V$ and $5.5V$, $V_{CM} = V_S / 2$ at $T_A = 25^\circ C$ (Unless otherwise noted)

PARAMETER		TEST CONDITIONS	MIN	TYP	MAX	UNIT
POWER SUPPLY						
I_Q	Quiescent current per comparator	Output is logic high		2.4	3.1	μA
I_Q	Quiescent current per comparator	Output is logic high $T_A = -55^\circ C$ to $+125^\circ C$			3.6	μA

(1) Ensured by characterization

6.9 Switching Characteristics - TLV3012-EP

For V_S (TOTAL SUPPLY VOLTAGE) = $(V+) - (V-) = 1.8 V$ and $5.5 V$, $V_{CM} = V_S / 2$ at $T_A = 25^\circ C$ (Unless otherwise noted)

PARAMETER		TEST CONDITIONS	MIN	TYP	MAX	UNIT
OUTPUT						
T_{PD-LH}	Propagation delay time, low-to-high (push-pull output)	$f = 10 \text{ kHz}$, $V_{STEP} = 200\text{mV}$, $V_{OD} = 100 \text{ mV}$, $C_L = 10 \text{ pF}$		2	4	μs
T_{PD-HL}	Propagation delay time, high-to-low	$f = 10 \text{ kHz}$, $V_{STEP} = 200\text{mV}$, $V_{OD} = 100 \text{ mV}$, $C_L = 10 \text{ pF}$		2	4	μs
T_{RISE}	Output Rise Time, 20% to 80%, push-pull output	$C_L = 10 \text{ pF}$		10		ns
T_{FALL}	Output Fall Time, 80% to 20%	$C_L = 10 \text{ pF}$		10		ns
T_{FALL}	Output Fall Time, 80% to 20%, open-drain output	$R_L = 10 \text{ k}\Omega$, $C_L = 10 \text{ pF}$		10		ns
t_{ON}	Power on-time			1.9		ms

6.10 Typical Characteristics - TLV3011-EP

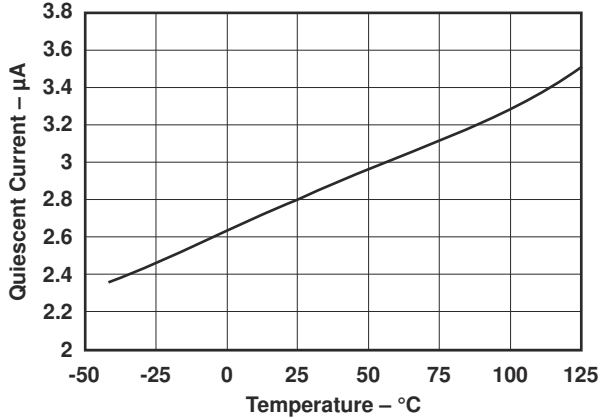

6-1. QUIESCENT CURRENT vs TEMPERATURE

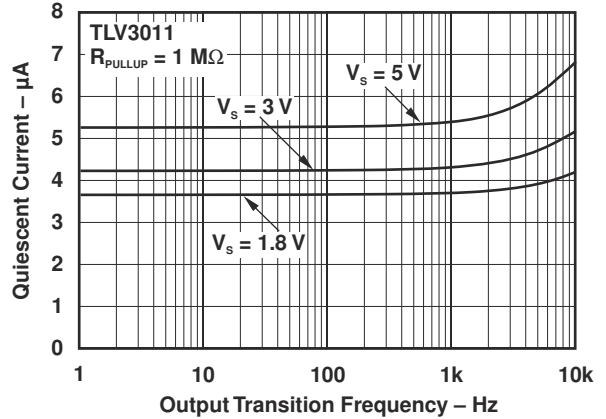

6-2. QUIESCENT CURRENT vs OUTPUT SWITCHING FREQUENCY

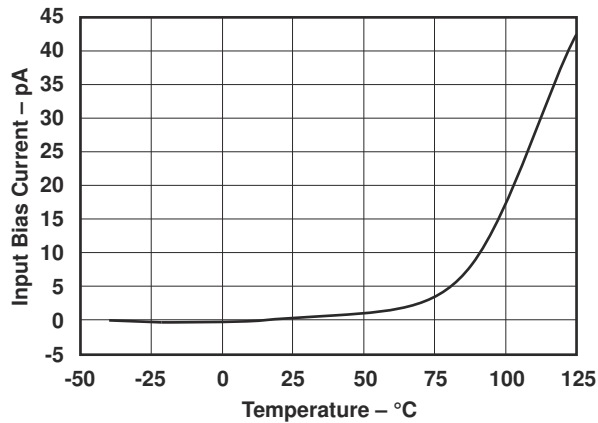

6-3. INPUT BIAS CURRENT vs TEMPERATURE

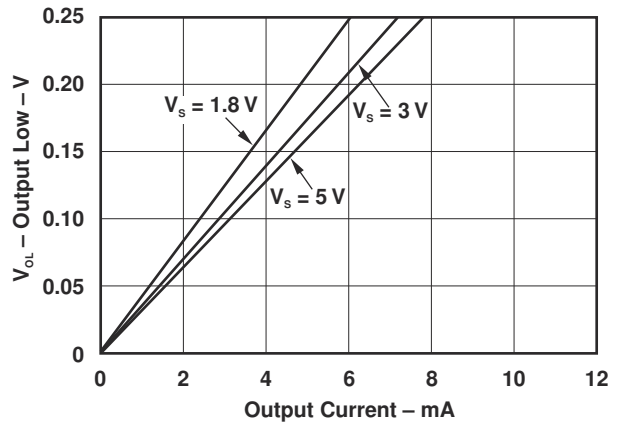

6-4. OUTPUT LOW vs OUTPUT CURRENT

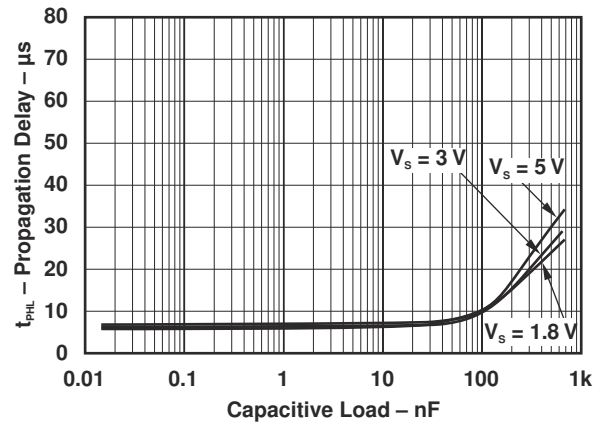

6-5. PROPAGATION DELAY (t_{PLH}) vs CAPACITIVE LOAD

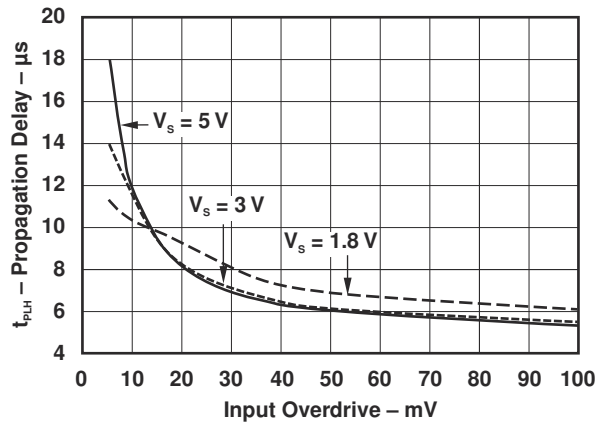

6-6. PROPAGATION DELAY (t_{PLH}) vs INPUT OVERDRIVE

6.10 Typical Characteristics - TLV3011-EP (continued)

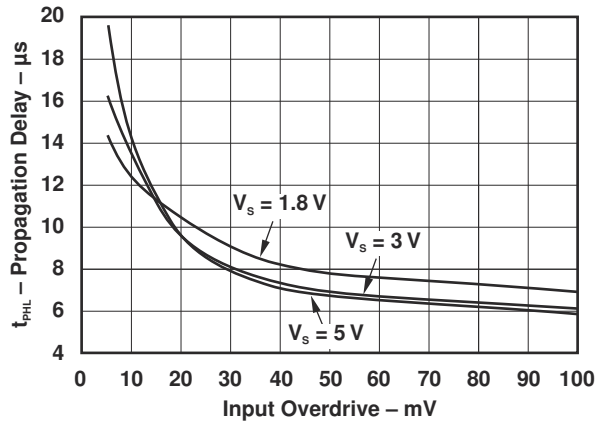

6-7. PROPAGATION DELAY (t_{pHL}) vs INPUT OVERDRIVE

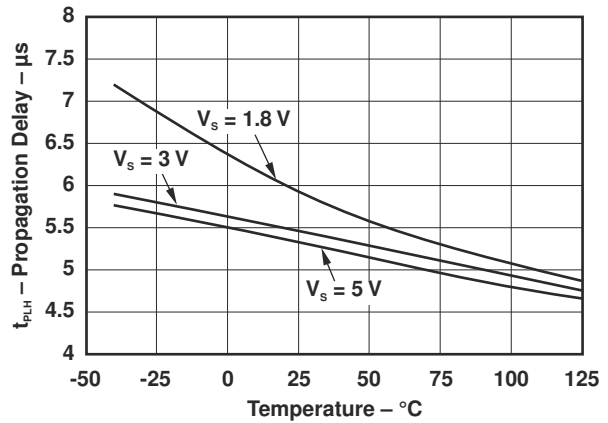

6-8. PROPAGATION DELAY (t_{pLH}) vs TEMPERATURE

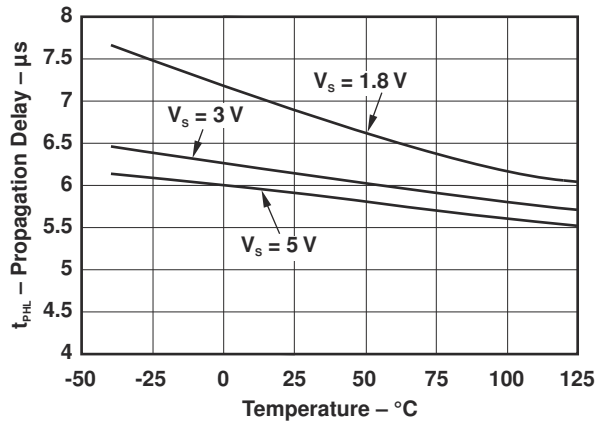

6-9. PROPAGATION DELAY (t_{pHL}) vs TEMPERATURE

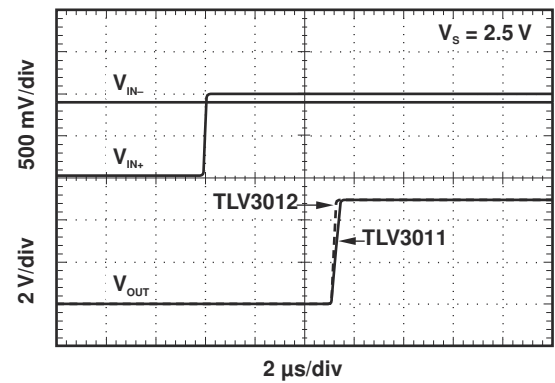

6-10. PROPAGATION DELAY (t_{pLH})

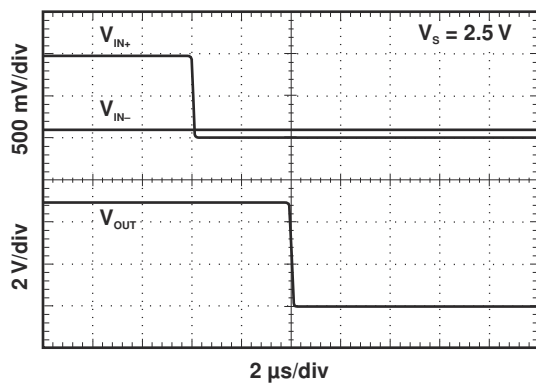

6-11. PROPAGATION DELAY (t_{pHL})

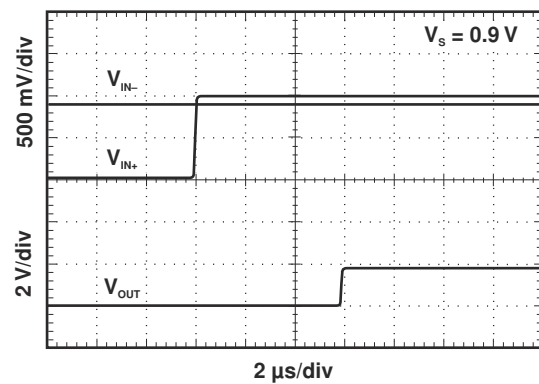

6-12. PROPAGATION DELAY (t_{pLH})

6.10 Typical Characteristics - TLV3011-EP (continued)

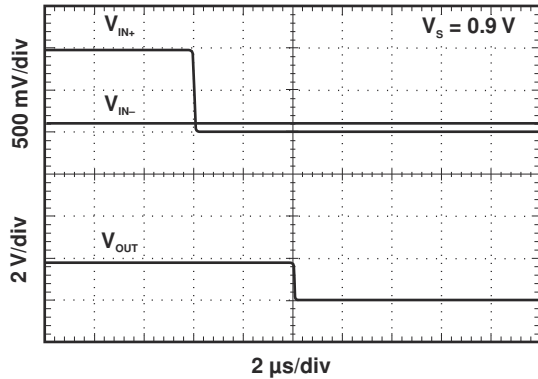

6-13. PROPAGATION DELAY (t_{PHL})

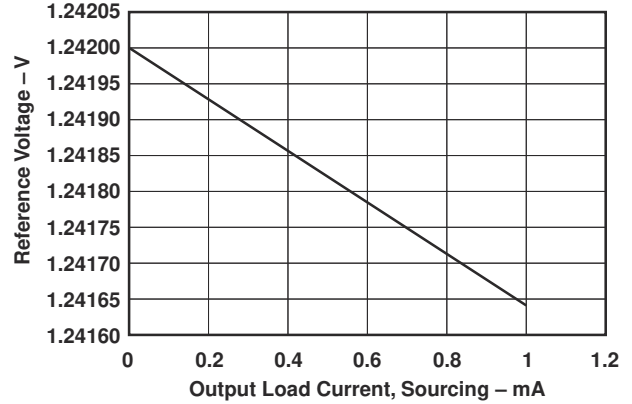

6-14. REFERENCE VOLTAGE vs OUTPUT LOAD CURRENT (SOURCING)

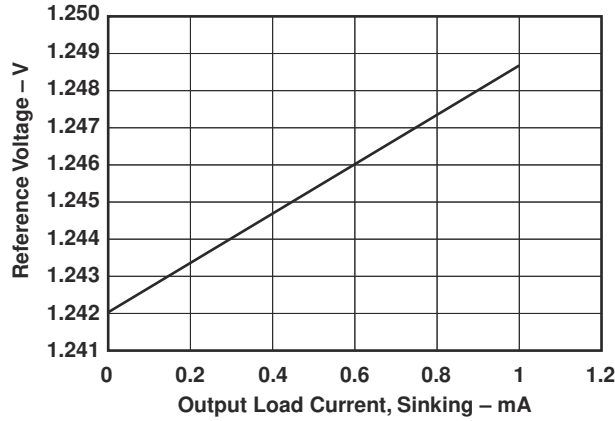

6-15. REFERENCE VOLTAGE vs OUTPUT LOAD CURRENT (SINKING)

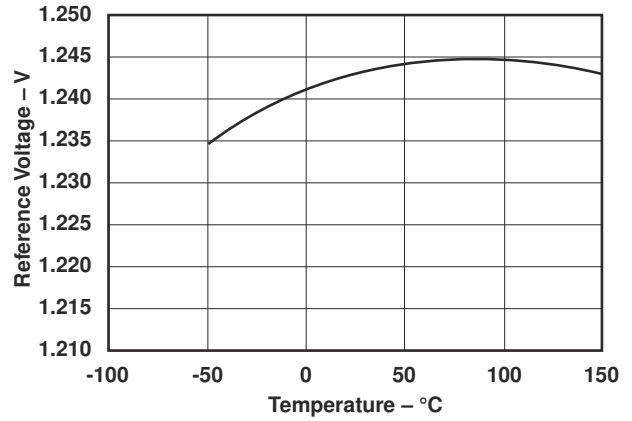

6-16. REFERENCE VOLTAGE vs TEMPERATURE

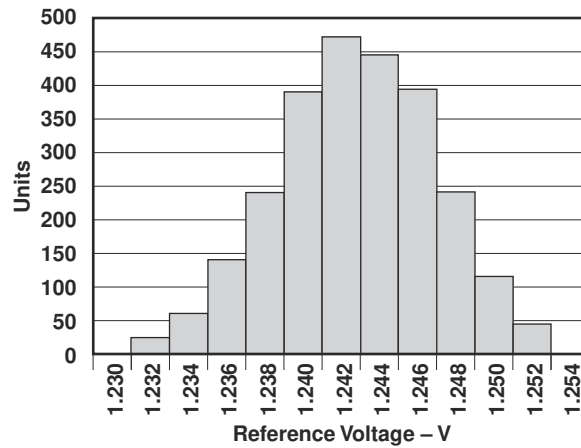

6-17. REFERENCE VOLTAGE DISTRIBUTION

6.11 Typical Characteristics - TLV3012-EP

For V_S (Total Supply Voltage) = $(V+) - (V-) = +5V$, $V_{CM} = V_S / 2$ at $T_A = 25^\circ C$, $R_{PULLUP} = 1M\Omega$ to $V+$, $C_L = 15pF$, $V_{OD} = 100mV$ unless otherwise noted.

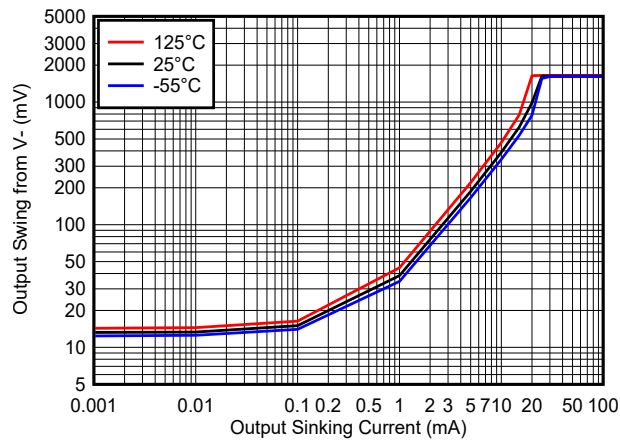

6-18. Output Swing vs. Output Sinking Current - 1.8V

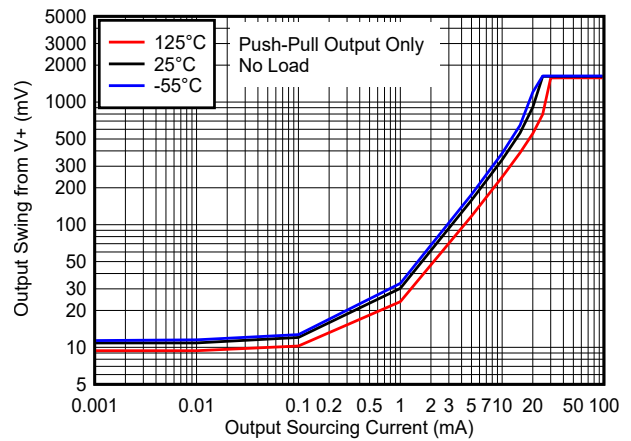

6-19. Output Swing vs. Output Sourcing Current - 1.8V

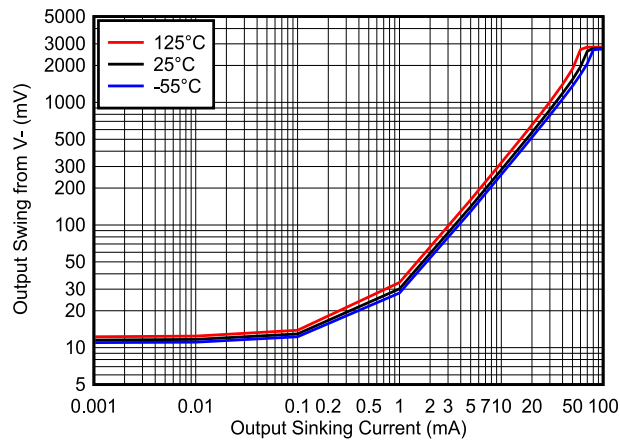

6-20. Output Swing vs. Output Sinking Current - 3.3V

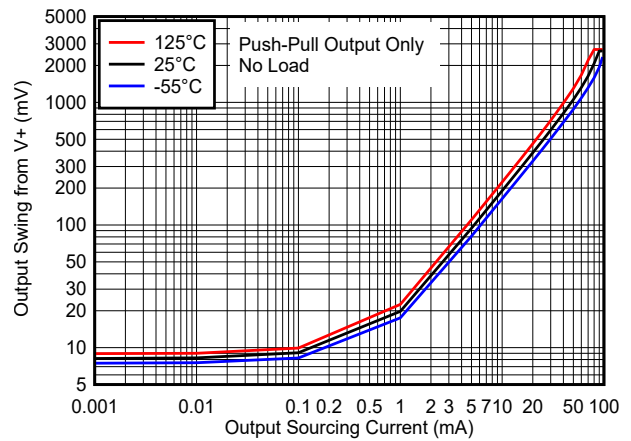

6-21. Output Swing vs. Output Sourcing Current - 3.3V

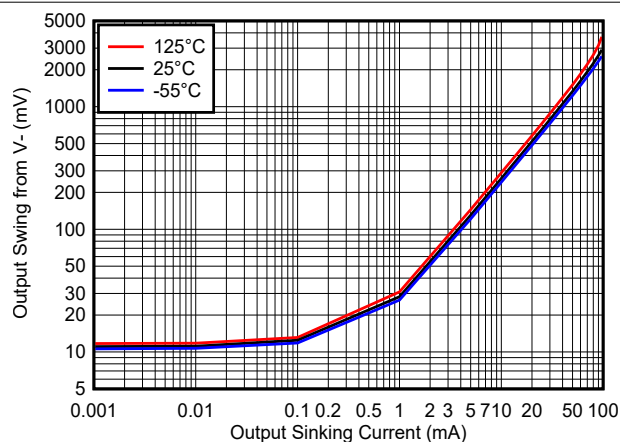

6-22. Output Swing vs. Output Sinking Current - 5V

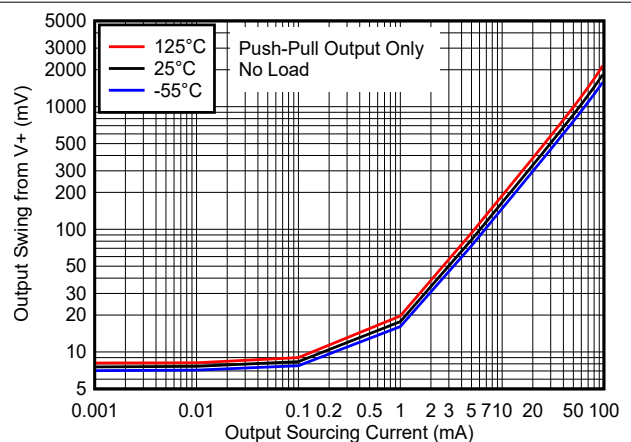

6-23. Output Swing vs. Output Sourcing Current - 5V

6.11 Typical Characteristics - TLV3012-EP (continued)

For V_S (Total Supply Voltage) = $(V+) - (V-) = +5V$, $V_{CM} = V_S / 2$ at $T_A = 25^\circ C$, $R_{PULLUP} = 1M\Omega$ to $V+$, $C_L = 15pF$, $V_{OD} = 100mV$ unless otherwise noted.

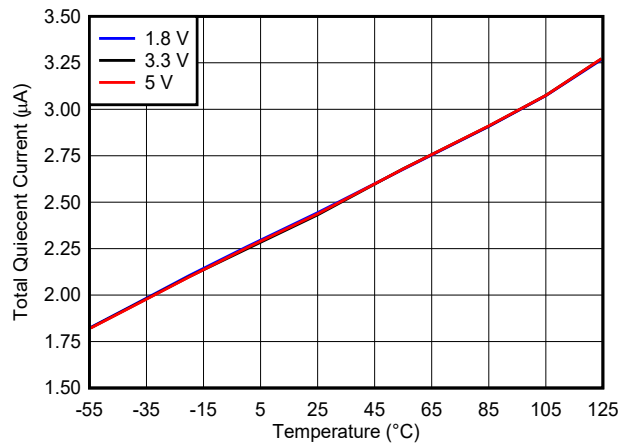

6-24. Supply Current vs. Temperature

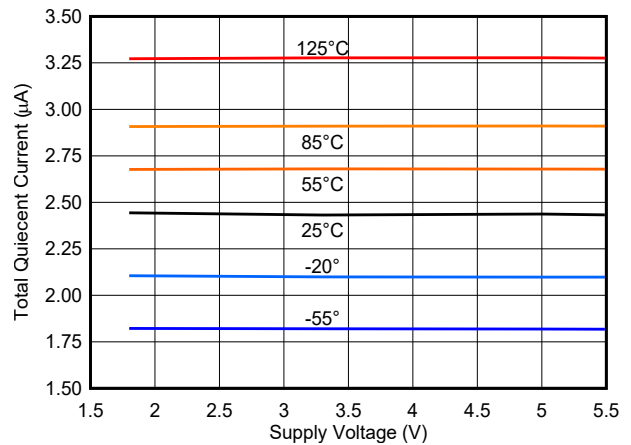

6-25. Supply Current vs. Supply Voltage

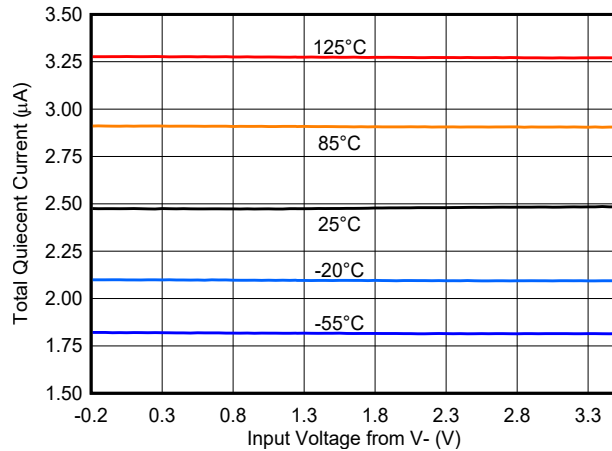

6-26. Supply Current vs. Common Mode - 3.3V

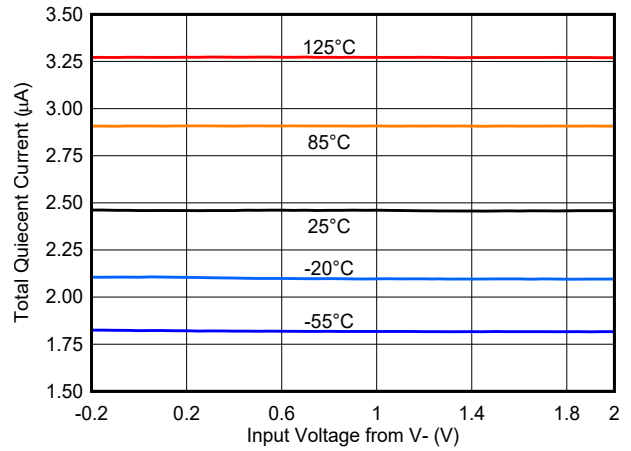

6-27. Supply Current vs. Common Mode - 1.8V

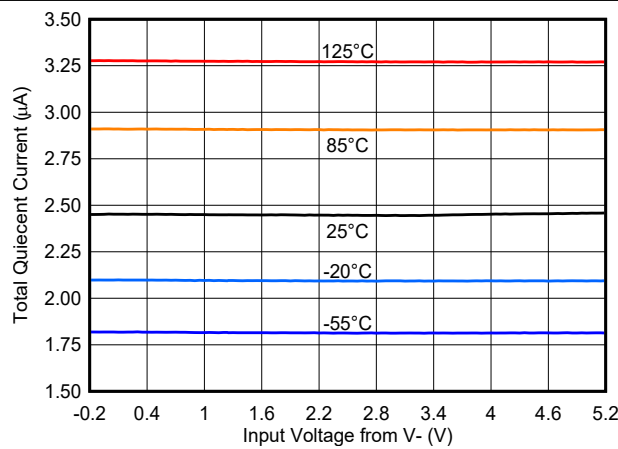

6-28. Supply Current vs. Common Mode - 5V

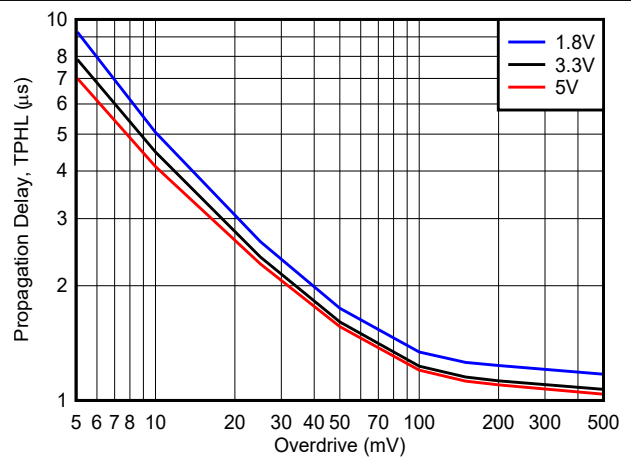

6-29. High to Low Propagation Delay vs. Overdrive

6.11 Typical Characteristics - TLV3012-EP (continued)

For V_S (Total Supply Voltage) = $(V+) - (V-) = +5V$, $V_{CM} = V_S / 2$ at $T_A = 25^\circ C$, $R_{PULLUP} = 1M\Omega$ to $V+$, $C_L = 15pF$, $V_{OD} = 100mV$ unless otherwise noted.

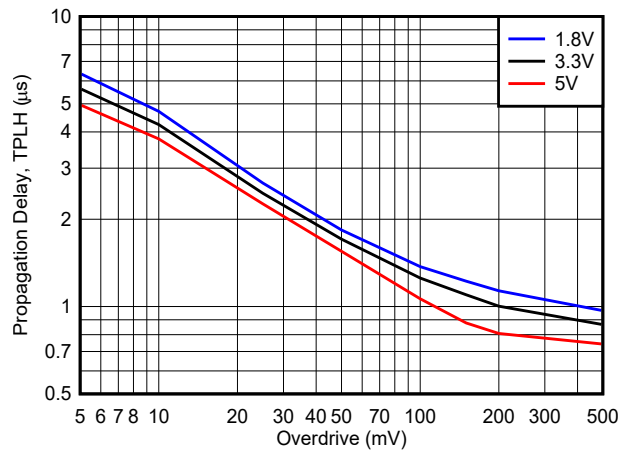

6-30. Low to High Propagation Delay vs. Overdrive

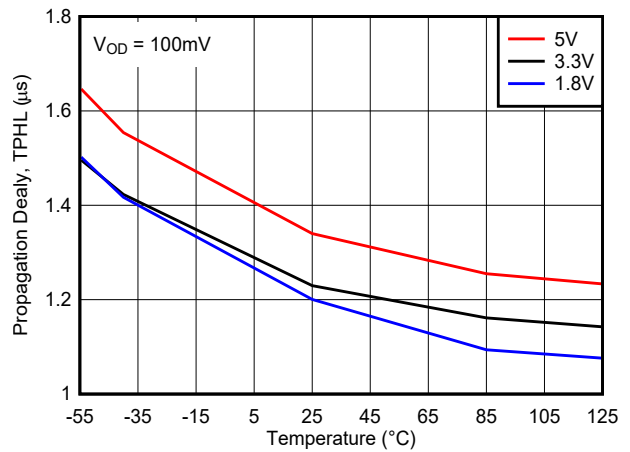

6-31. High to Low Propagation Delay vs. Temperature

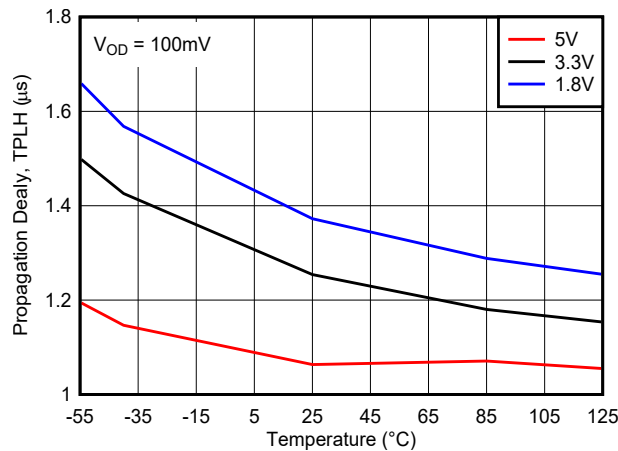

6-32. Low to High Propagation Delay vs. Temperature

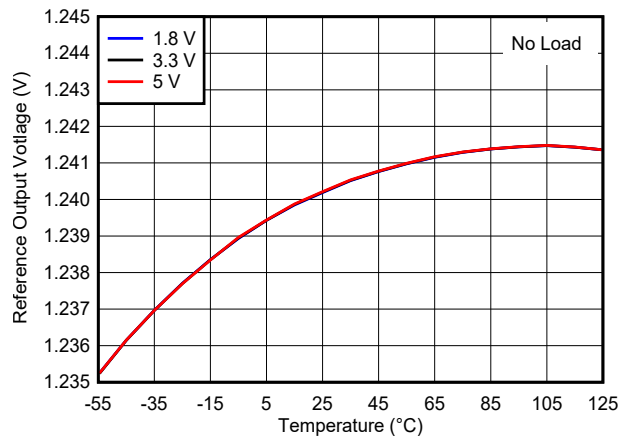

6-33. Reference Voltage vs. Temperature

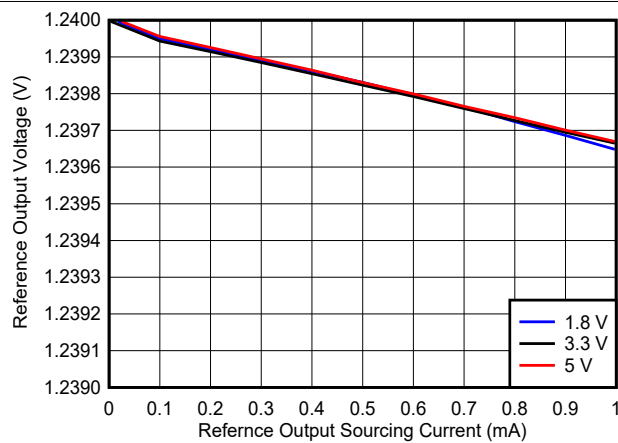

6-34. Reference Voltage vs. Reference Output Sourcing Current

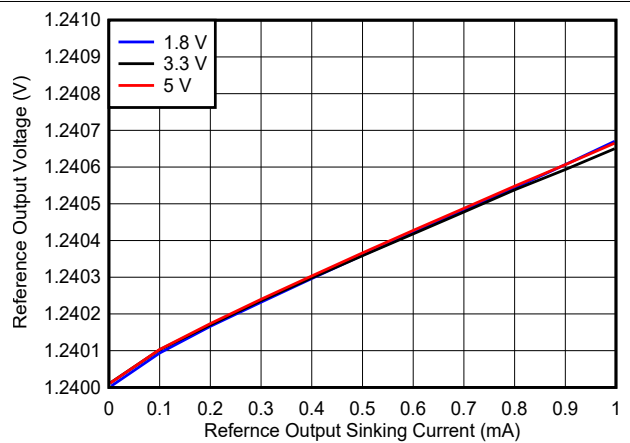

6-35. Reference Voltage vs. Reference Output Sinking Current

6.11 Typical Characteristics - TLV3012-EP (continued)

For V_S (Total Supply Voltage) = $(V+) - (V-) = +5V$, $V_{CM} = V_S / 2$ at $T_A = 25^\circ C$, $R_{PULLUP} = 1M\Omega$ to $V+$, $C_L = 15pF$, $V_{OD} = 100mV$ unless otherwise noted.

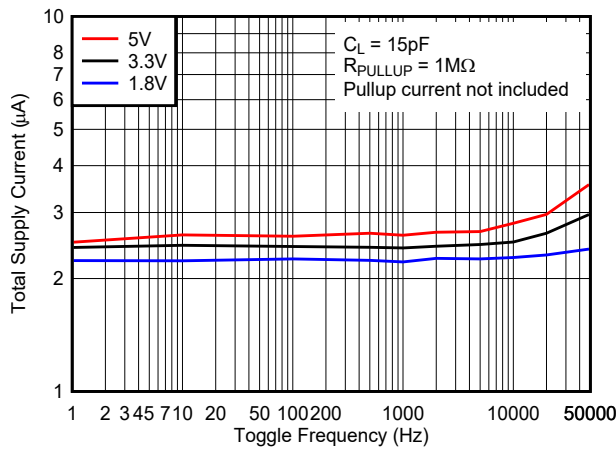

6-36. Supply Current vs. Toggle Frequency - Open Drain Output

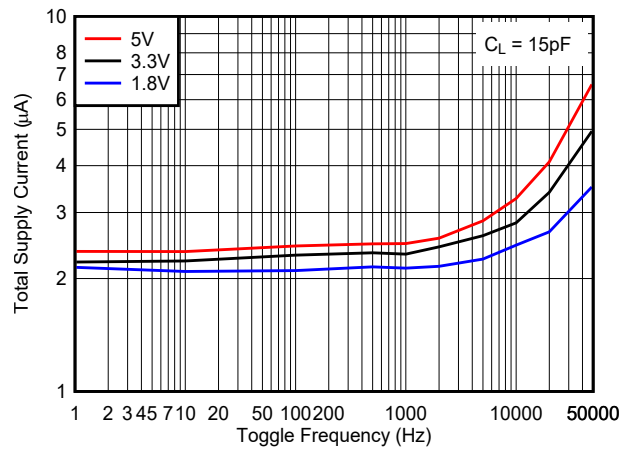

6-37. Supply Current vs. Toggle Frequency - Push-Pull Output

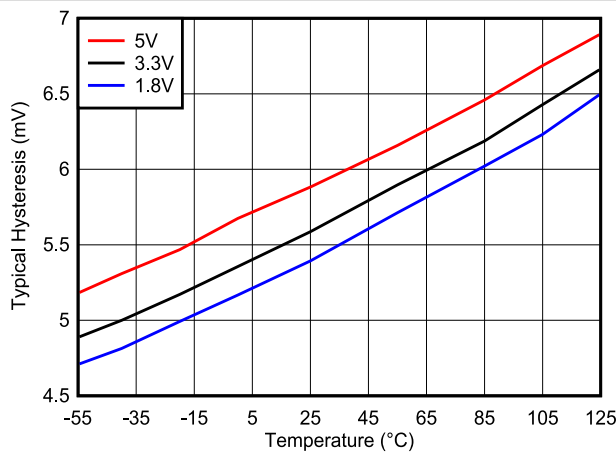

6-38. Hysteresis Voltage vs. Temperature

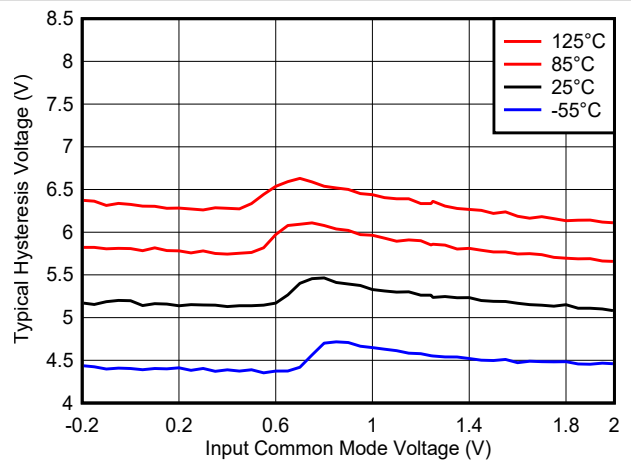

6-39. Hysteresis Voltage vs. Common Mode, 1.8V

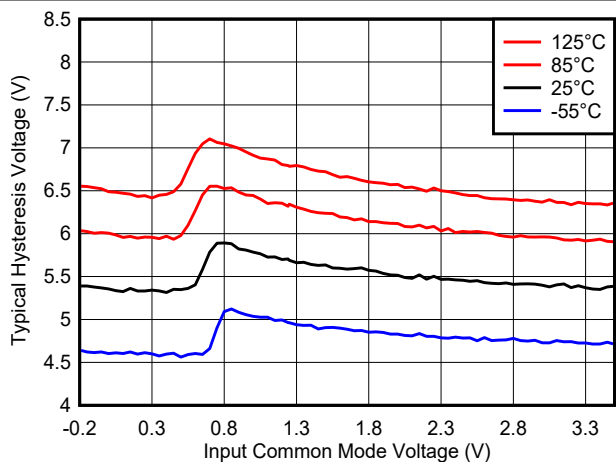

6-40. Hysteresis Voltage vs. Common Mode, 3.3V

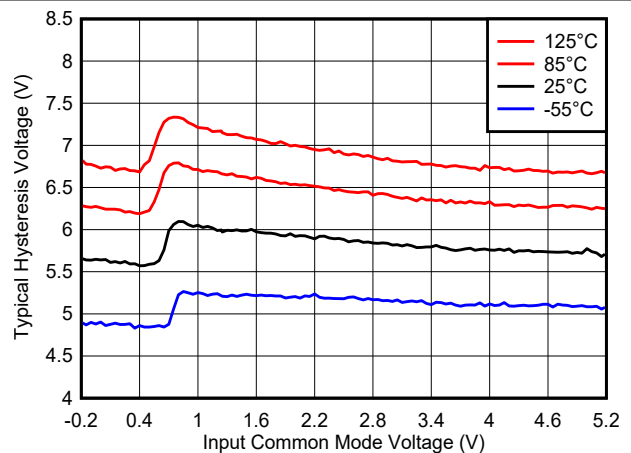

6-41. Hysteresis Voltage vs. Common Mode, 5V

6.11 Typical Characteristics - TLV3012-EP (continued)

For V_S (Total Supply Voltage) = $(V+) - (V-) = +5V$, $V_{CM} = V_S / 2$ at $T_A = 25^\circ C$, $R_{PULLUP} = 1M\Omega$ to $V+$, $C_L = 15pF$, $V_{OD} = 100mV$ unless otherwise noted.

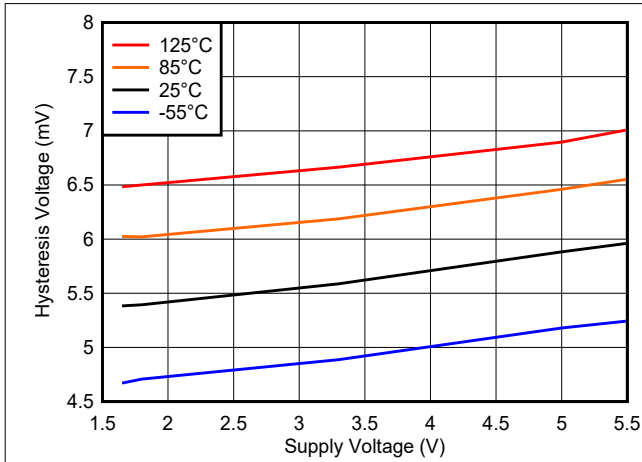

6-42. Hysteresis Voltage vs. Supply Voltage

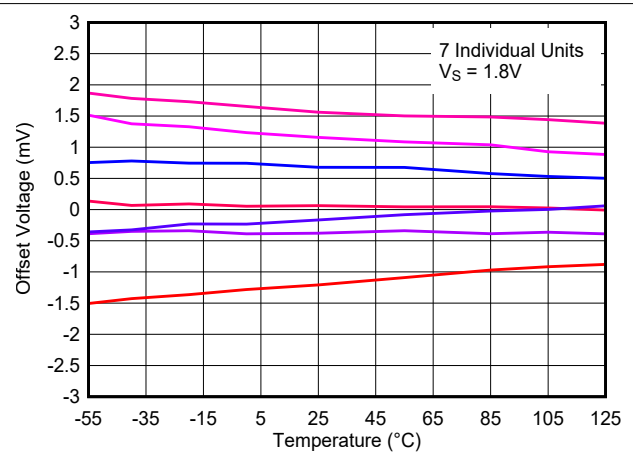

6-43. Offset Voltage vs. Temperature, 1.8 V

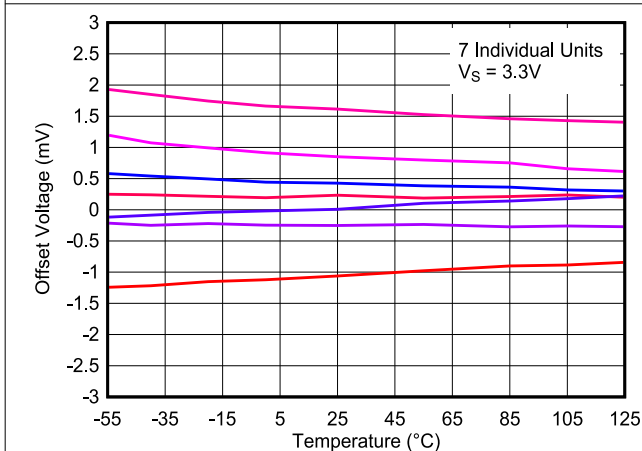

6-44. Offset Voltage vs. Temperature, 3.3 V

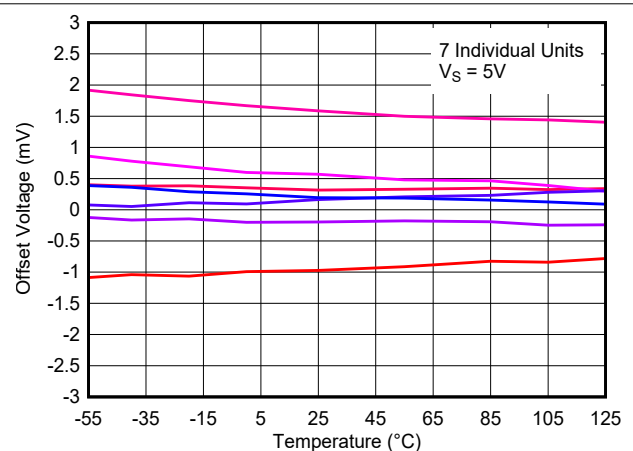

6-45. Offset Voltage vs. Temperature, 5 V

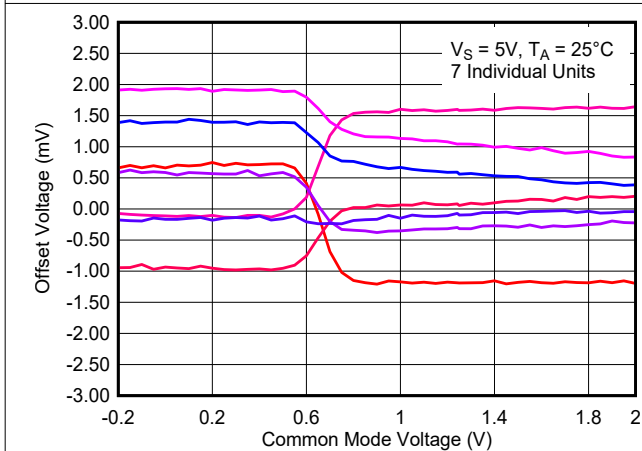

6-46. Offset Voltage vs. Common Mode Voltage, 1.8 V

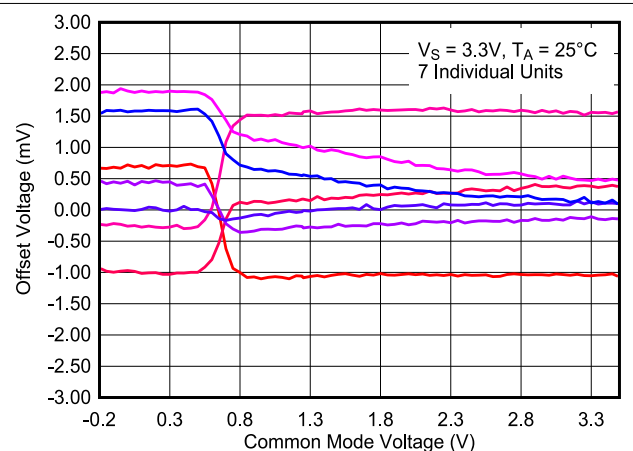

6-47. Offset Voltage vs. Common Mode Voltage, 3.3 V

6.11 Typical Characteristics - TLV3012-EP (continued)

For V_S (Total Supply Voltage) = $(V+) - (V-) = +5V$, $V_{CM} = V_S / 2$ at $T_A = 25^\circ C$, $R_{PULLUP} = 1M\Omega$ to $V+$, $C_L = 15pF$, $V_{OD} = 100mV$ unless otherwise noted.

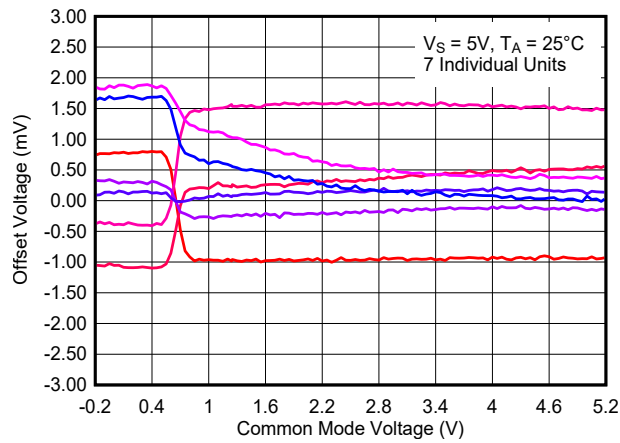

6-48. Offset Voltage vs. Common Mode Voltage, 5 V

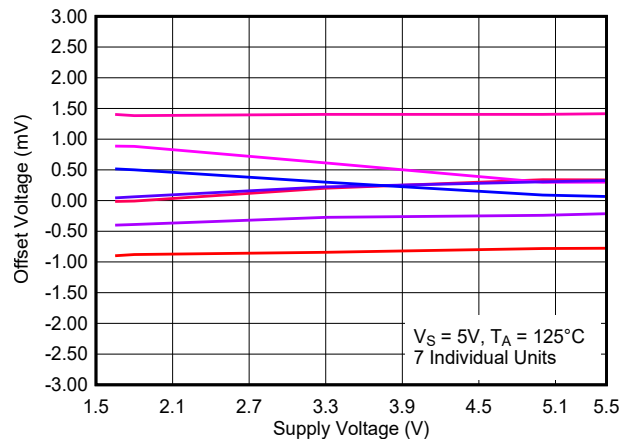

6-49. Offset Voltage vs. Supply Voltage, 125°C

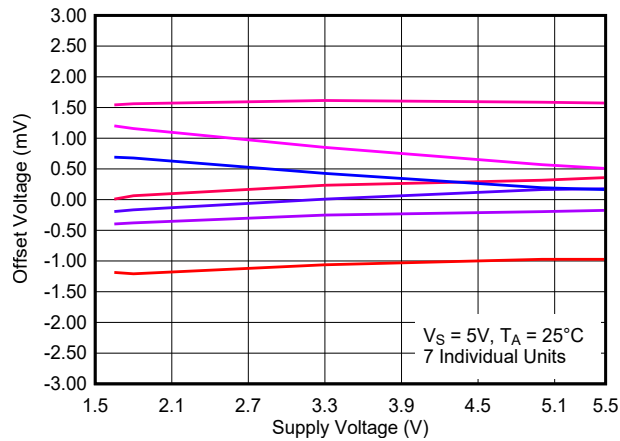

6-50. Offset Voltage vs. Supply Voltage, 25°C

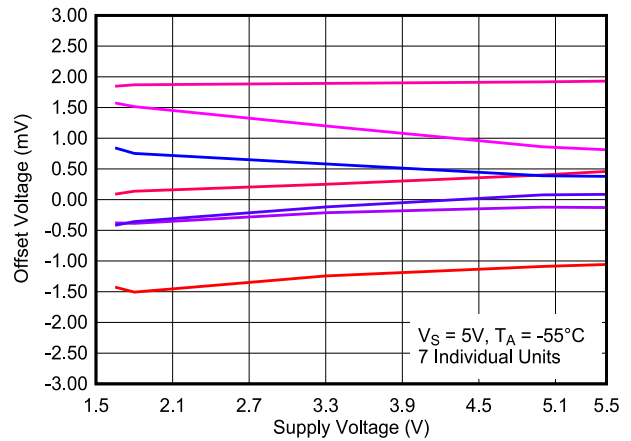

6-51. Offset Voltage vs. Supply Voltage, -55°C

7 Detailed Description

7.1 Overview

The TLV301x-EP is a MicroPower comparator with an integrated reference that is well suited for compact, low-current, precision voltage detection applications. With a high-accuracy, internal reference of 1.242 V and 5 μ A of quiescent current, the TLV301x-EP enables power conscious systems to monitor and respond quickly to fault conditions.

7.2 Functional Block Diagram

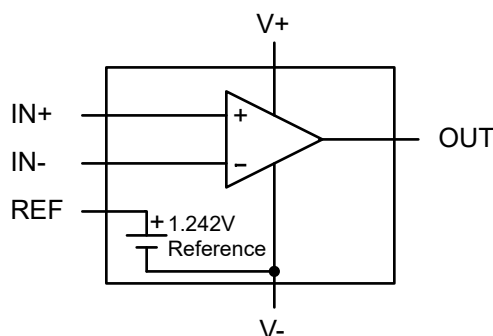

7.3 Feature Description

The TLV301x-EP is comprised of a rail-to-rail input comparator with open-drain or push-pull output options and a voltage reference that is externally available.

7.4 Device Functional Modes

The TLV3011-EP requires an operating voltage between 1.8 V and 5.5 V for the comparator output to reflect the voltage applied to the inputs. Similarly, the reference output (REF) will also be valid over the same operating voltage range.

7.4.1 Open Drain Output (TLV3011-EP)

The TLV3011-EP features an Open-Drain (sinking only) output that allows multiple devices to be driven by a single pull-up resistor to accomplish an OR function, making the TLV3011-EP useful for logic applications. The value of the pull-up resistor and supply voltage used will affect current consumption due to additional current drawn when the output is in a low state. This effect can be seen in the typical curve Quiescent Current vs Output Switching Frequency.

The pull-up voltage should NOT exceed the V+ supply.

7.4.2 Push Pull Output (TLV3012-EP)

The TLV3012-EP has a "Push-Pull" output capable of both sinking and sourcing current. The push-pull output stage is optimal for reduced power budget applications by eliminating the need for a pull-up resistor and features no shoot-through current.

Do not tie push-pull outputs together.

7.4.3 Voltage Reference

The TLV301x-EP requires an operating voltage between 1.8 V and 5.5 V for the comparator output to reflect the voltage applied to the inputs. Similarly, the reference output (REF) will also be valid over the same operating voltage range.

The integrated 1.242-V voltage reference offers low 100-ppm/ $^{\circ}$ C (maximum) drift provided on a separate output pin that allows use of external dividers or to provide a reference voltage for other external circuitry. The reference is stable with up to a 10-nF capacitive load and can sink or source up to 500 μ A (typical) of output current.

7.4.4 Fail-Safe Input (TLV3012-EP Only)

This section does **NOT** apply to the open drain output TLV3011-EP.

The TLV3012-EP inputs are Fail-Safe up to 5.5V independent of V+ voltage. Fail-Safe is defined as maintaining the same high input impedance when V+ is unpowered or within the recommended operating ranges.

The Fail-Safe inputs can be any value between 0 V and 5.5 V, even while V+ is zero or ramping up or down. This feature avoids power sequencing issues as long as the input voltage range and supply voltage are within the specified ranges.

This is possible since the inputs are not clamped to V+ and the input current maintains its value even when a higher voltage is applied to the inputs.

As long as one of the input pins remains within the valid input range, and the supply voltage is valid and not in POR, the output state will be correct. The specified input voltage range is -0.2 V to (V+) + 0.2 V.

The following is a summary of the TLV3012-EP device input voltage excursions and their outcomes:

1. When both IN- and IN+ are within the specified input voltage range:
 - a. If IN- is higher than IN+ and the offset voltage, the output is low.
 - b. If IN- is lower than IN+ and the offset voltage, the output is high.
2. When IN- is higher than the specified input voltage range and IN+ is within the specified voltage range, the output is low.
3. When IN+ is higher than the specified input voltage range and IN- is within the specified input voltage range, the output is high
4. When IN- and IN+ are both outside the specified input voltage range, the output state is **indeterminate** (random). *Do not* operate in this region.

Because the inputs do not have upper ESD diode clamps to V+, input voltages must be externally clamped to below 5.5 V if the source could possibly exceed 5.5 V. A current limiting resistor in series with the input is also recommend in case of input transients.

7.4.5 Power-On Reset (POR) (TLV3012-EP Only)

This section does **NOT** apply to the open-drain output TLV3011-EP.

The TLV3012-EP has an internal Power-on-Reset (POR) circuit for known start-up or power-down conditions. While the power supply (V+) is ramping up or ramping down, the POR circuitry will be activated for up to 1.9ms after the minimum supply voltage threshold is crossed, or immediately when the supply voltage drops below minimum supply. When the supply voltage is equal to or greater than the minimum supply voltage, and after the delay period, the comparator output reflects the state of the differential input (V_{ID}). This delay is long enough to allow the reference output to stabilize with up to a 10nF capacitive load.

During the POR period (t_{on}), the outputs will be low (sinking)

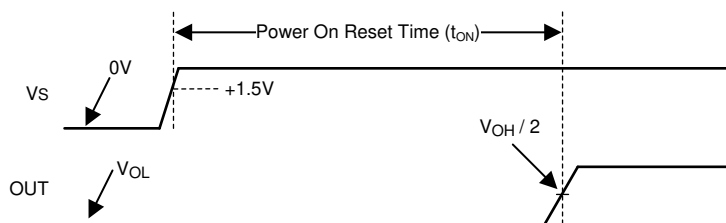

7-1. Power-On Reset Example Timing Diagram for TLV3012-EP

8 Application and Implementation

注

以下のアプリケーション情報は、TI の製品仕様に含まれるものではなく、TI ではその正確性または完全性を保証いたしません。個々の目的に対する製品の適合性については、お客様の責任で判断していただくこととなります。お客様は自身の設計実装を検証しテストすることで、システムの機能を確認する必要があります。

8.1 Application Information

The TLV301x-EP comparator family with on-chip 1.242-V series reference with the choice of either open-drain or push-pull output stages.

A typical supply current of 2.8 μA and small packaging combine with 1.8-V supply requirements to make the TLV301x-EP devices optimal for battery and portable designs.

図 8-1 shows the typical connections for the TLV301x-EP device.

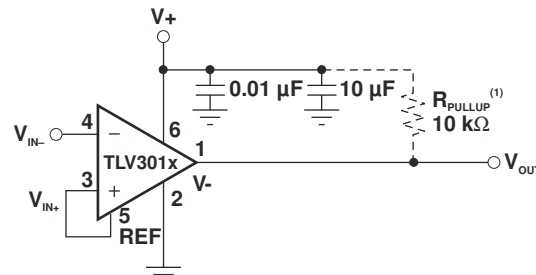

(1) Use R_{PULLUP} with the TLV3011 only.

図 8-1. Basic Connections of the TLV301x-EP

8.1.1 External Hysteresis

Comparator inputs have no noise immunity within the range of specified offset voltage (± 12 mV). For noisy input signals, the comparator output may display multiple switching as input signals move through the switching threshold. The typical comparator threshold of the TLV301x-EP is ± 0.5 mV. To prevent multiple switching within the comparason threshold of the comparator, external hysteresis may be added by connecting a small amount of feedback to the positive input. 図 8-2 shows a typical topology used to introduce hysteresis, described by this equation:

$$V_{\text{HYST}} = \frac{V+ \times R1}{R1 + R2}$$

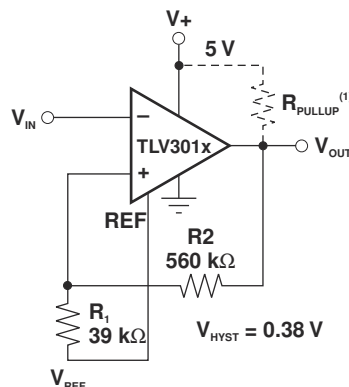

(1) Use R_{PULLUP} with the TLV3011 only.

図 8-2. Adding Hysteresis

V_{HYST} sets the value of the transition voltage required to switch the comparator output by increasing the threshold region, thereby reducing sensitivity to noise.

8.2 Typical Application

8.2.1 Under Voltage Detection

Under-voltage detection is frequently required to alert the system that a battery voltage has dropped below the usable voltage level. [Figure 8-3](#) shows a simple under-voltage detection circuit using the TLV3012-EP which is configured as a non-inverting comparator with the integrated 1.242 V reference is externally connected to the inverting input pin (IN-).

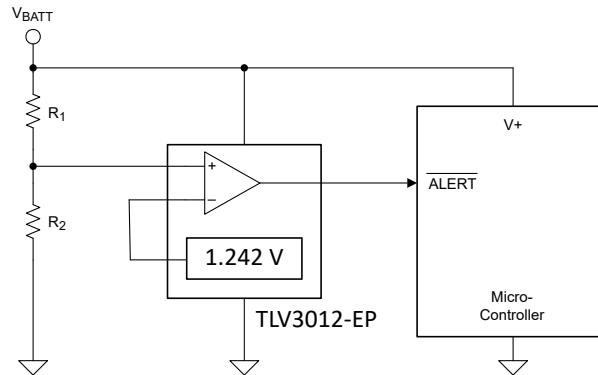

Figure 8-3. Under-Voltage Detection

8.2.1.1 Design Requirements

For this design, follow these design requirements:

- Operate from power supply that powers the microcontroller.
- Under-voltage alert is active low.
- Logic low output when V_{BAT} is less than 2.0V.

8.2.1.2 Detailed Design Procedure

Configure the circuit as shown in [Figure 8-3](#). Connect (V+) to V_{BAT} which also powers the microcontroller. Resistors R_1 and R_2 create the under-voltage alert level of 2.0 V. When the battery voltage sags down to 2.0 V, the resistor divider voltage crosses V_{REF} , the 1.242 V reference threshold of the TLV3012-EP. This causes the comparator output to transition from a logic high to a logic low. The push-pull output of the TLV3012-EP is selected since the comparator operating voltage is shared with the microcontroller which is receiving the under-voltage alert signal.

[Equation 1](#) is derived from the analysis of [Figure 8-3](#).

$$V_{REF} = \frac{R_2}{R_1 + R_2} \times V_{BAT} \tag{1}$$

where

- R_1 and R_2 are the resistor values for the resistor divider connected to IN+
- V_{BAT} is the voltage source that is being monitored for an undervoltage condition.
- V_{REF} is the falling edge threshold where the comparator output changes state from high to low

Rearranging [Equation 1](#) and solving for R_1 yields [Equation 2](#).

$$R_1 = \frac{(V_{BAT} - V_{REF})}{V_{REF}} \times R_2 \tag{2}$$

For the specific undervoltage detection of 2.0 V using the TLV3012-Q1, the following results are calculated.

$$R_1 = \frac{(2.0 - 1.242)}{1.242} \times 1M = 610 \text{ k}\Omega \tag{3}$$

where:

- R₂ is set to 1 MΩ
- V_{BAT} is set to 2.0 V
- V_{REF} is set to 1.242 V

Choose R_{TOTAL} (R₁ + R₂) such that the current through the divider is at least 100 times higher than the input bias current (I_{BIAS}). The resistors can have high values to minimize current consumption in the circuit without adding significant error to the resistive divider.

8.2.1.3 Application Performance Plots

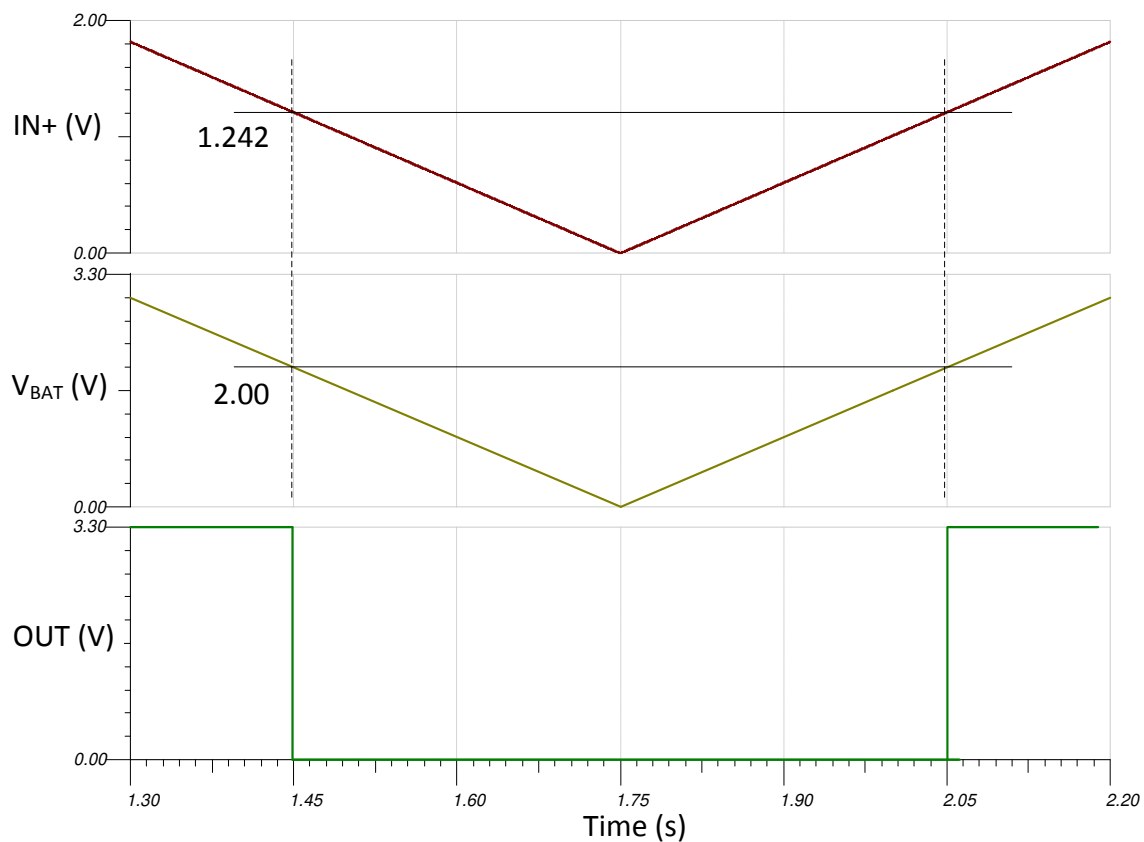

8-4.

8.3 Power Supply Recommendations

The TLV3012x-EP has a recommended operating voltage range (V_S) of 1.8 V to 5.5 V. V_S is defined as $(V+) - (V-)$.

Therefore, the supply voltages used to create V_S can be single-ended or bipolar. For example, single-ended supply voltages of 5 V and 0 V and bipolar supply voltages of +2.5 V and –2.5 V create comparable operating voltages for V_S .

However, when bipolar supply voltages are used, it is important to realize that the reference (REF) and logic low level of the comparator output is referenced to $(V-)$. Output capacitive loading and output toggle rate will cause the average supply current to rise over the quiescent current in the EC Table.

8.4 Layout

8.4.1 Layout Guidelines

To minimize supply noise, power supplies should be capacitively decoupled by a 0.1- μ F ceramic capacitor. Comparators are sensitive to input noise and precautions such as proper grounding (use of ground plane), supply bypassing, and guarding of high-impedance nodes minimize the effects of noise and help to ensure specified performance.

8.4.2 Layout Example



图 8-5. Layout Example

9 Device and Documentation Support

TI offers an extensive line of development tools. Tools and software to evaluate the performance of the device, generate code, and develop solutions are listed below.

9.1 ドキュメントの更新通知を受け取る方法

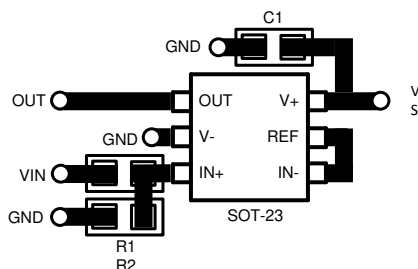
ドキュメントの更新についての通知を受け取るには、ti.com のデバイス製品フォルダを開いてください。「更新の通知を受け取る」をクリックして登録すると、変更されたすべての製品情報に関するダイジェストを毎週受け取れます。変更の詳細については、修正されたドキュメントに含まれている改訂履歴をご覧ください。

9.2 サポート・リソース

[TI E2E™ サポート・フォーラム](#)は、エンジニアが検証済みの回答と設計に関するヒントをエキスパートから迅速かつ直接得ることができる場所です。既存の回答を検索したり、独自の質問をしたりすることで、設計に必要な支援を迅速に得ることができます。

リンクされているコンテンツは、該当する貢献者により、現状のまま提供されるものです。これらは TI の仕様を構成するものではなく、必ずしも TI の見解を反映したものではありません。TI の[使用条件](#)を参照してください。

9.3 Trademarks

TI E2E™ is a trademark of Texas Instruments.

すべての商標は、それぞれの所有者に帰属します。

9.4 静電気放電に関する注意事項



この IC は、ESD によって破損する可能性があります。テキサス・インスツルメンツは、IC を取り扱う際には常に適切な注意を払うことを推奨します。正しい取り扱いおよび設置手順に従わない場合、デバイスを破損するおそれがあります。

ESD による破損は、わずかな性能低下からデバイスの完全な故障まで多岐にわたります。精密な IC の場合、パラメータがわずかに変化するだけで公表されている仕様から外れる可能性があるため、破損が発生しやすくなっています。

9.5 用語集

[テキサス・インスツルメンツ用語集](#)

この用語集には、用語や略語の一覧および定義が記載されています。

10 Mechanical, Packaging, and Orderable Information

The following pages include mechanical, packaging, and orderable information. This information is the most current data available for the designated devices. This data is subject to change without notice and revision of this document. For browser-based versions of this data sheet, refer to the left-hand navigation.

PACKAGING INFORMATION

Orderable part number	Status (1)	Material type (2)	Package Pins	Package qty Carrier	RoHS (3)	Lead finish/ Ball material (4)	MSL rating/ Peak reflow (5)	Op temp (°C)	Part marking (6)
TLV3011AMDBVREP	Active	Production	SOT-23 (DBV) 6	3000 LARGE T&R	Yes	NIPDAU	Level-1-260C-UNLIM	-55 to 125	BTV
TLV3011AMDBVREP.A	Active	Production	SOT-23 (DBV) 6	3000 LARGE T&R	Yes	NIPDAU	Level-1-260C-UNLIM	-55 to 125	BTV
TLV3012AMDBVREP	Active	Production	SOT-23 (DBV) 6	3000 LARGE T&R	Yes	NIPDAU	Level-1-260C-UNLIM	-55 to 125	2QDF
TLV3012AMDBVREP.A	Active	Production	SOT-23 (DBV) 6	3000 LARGE T&R	Yes	NIPDAU	Level-1-260C-UNLIM	-55 to 125	2QDF
V62/07604-01XE	Active	Production	SOT-23 (DBV) 6	3000 LARGE T&R	Yes	NIPDAU	Level-1-260C-UNLIM	-55 to 125	BTV
V62/23603-01XE	Active	Production	SOT-23 (DBV) 6	3000 LARGE T&R	Yes	NIPDAU	Level-1-260C-UNLIM	-55 to 125	2QDF

(1) **Status:** For more details on status, see our [product life cycle](#).

(2) **Material type:** When designated, preproduction parts are prototypes/experimental devices, and are not yet approved or released for full production. Testing and final process, including without limitation quality assurance, reliability performance testing, and/or process qualification, may not yet be complete, and this item is subject to further changes or possible discontinuation. If available for ordering, purchases will be subject to an additional waiver at checkout, and are intended for early internal evaluation purposes only. These items are sold without warranties of any kind.

(3) **RoHS values:** Yes, No, RoHS Exempt. See the [TI RoHS Statement](#) for additional information and value definition.

(4) **Lead finish/Ball material:** Parts may have multiple material finish options. Finish options are separated by a vertical ruled line. Lead finish/Ball material values may wrap to two lines if the finish value exceeds the maximum column width.

(5) **MSL rating/Peak reflow:** The moisture sensitivity level ratings and peak solder (reflow) temperatures. In the event that a part has multiple moisture sensitivity ratings, only the lowest level per JEDEC standards is shown. Refer to the shipping label for the actual reflow temperature that will be used to mount the part to the printed circuit board.

(6) **Part marking:** There may be an additional marking, which relates to the logo, the lot trace code information, or the environmental category of the part.

Multiple part markings will be inside parentheses. Only one part marking contained in parentheses and separated by a "~" will appear on a part. If a line is indented then it is a continuation of the previous line and the two combined represent the entire part marking for that device.

Important Information and Disclaimer: The information provided on this page represents TI's knowledge and belief as of the date that it is provided. TI bases its knowledge and belief on information provided by third parties, and makes no representation or warranty as to the accuracy of such information. Efforts are underway to better integrate information from third parties. TI has taken and continues to take reasonable steps to provide representative and accurate information but may not have conducted destructive testing or chemical analysis on incoming materials and chemicals. TI and TI suppliers consider certain information to be proprietary, and thus CAS numbers and other limited information may not be available for release.

In no event shall TI's liability arising out of such information exceed the total purchase price of the TI part(s) at issue in this document sold by TI to Customer on an annual basis.

OTHER QUALIFIED VERSIONS OF TLV3011-EP, TLV3012-EP :

- Catalog : [TLV3011](#), [TLV3012](#)
- Automotive : [TLV3011-Q1](#), [TLV3012-Q1](#)

NOTE: Qualified Version Definitions:

- Catalog - TI's standard catalog product
- Automotive - Q100 devices qualified for high-reliability automotive applications targeting zero defects

TAPE AND REEL INFORMATION

QUADRANT ASSIGNMENTS FOR PIN 1 ORIENTATION IN TAPE

*All dimensions are nominal

Device	Package Type	Package Drawing	Pins	SPQ	Reel Diameter (mm)	Reel Width W1 (mm)	A0 (mm)	B0 (mm)	K0 (mm)	P1 (mm)	W (mm)	Pin1 Quadrant
TLV3011AMDBVREP	SOT-23	DBV	6	3000	180.0	8.4	3.2	3.2	1.4	4.0	8.0	Q3
TLV3012AMDBVREP	SOT-23	DBV	6	3000	180.0	8.4	3.2	3.2	1.4	4.0	8.0	Q3

TAPE AND REEL BOX DIMENSIONS

*All dimensions are nominal

Device	Package Type	Package Drawing	Pins	SPQ	Length (mm)	Width (mm)	Height (mm)
TLV3011AMDBVREP	SOT-23	DBV	6	3000	210.0	185.0	35.0
TLV3012AMDBVREP	SOT-23	DBV	6	3000	210.0	185.0	35.0

DBV0006A



PACKAGE OUTLINE

SOT-23 - 1.45 mm max height

SMALL OUTLINE TRANSISTOR



4214840/G 08/2024

NOTES:

1. All linear dimensions are in millimeters. Any dimensions in parenthesis are for reference only. Dimensioning and tolerancing per ASME Y14.5M.
2. This drawing is subject to change without notice.
3. Body dimensions do not include mold flash or protrusion. Mold flash and protrusion shall not exceed 0.25 per side.
4. Leads 1,2,3 may be wider than leads 4,5,6 for package orientation.
5. Reference JEDEC MO-178.

EXAMPLE BOARD LAYOUT

DBV0006A

SOT-23 - 1.45 mm max height

SMALL OUTLINE TRANSISTOR



LAND PATTERN EXAMPLE
EXPOSED METAL SHOWN
SCALE:15X

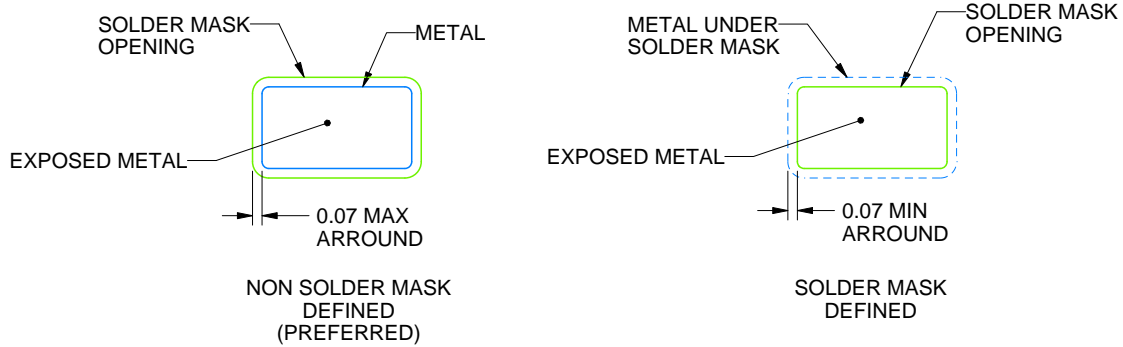

SOLDER MASK DETAILS

4214840/G 08/2024

NOTES: (continued)

6. Publication IPC-7351 may have alternate designs.

7. Solder mask tolerances between and around signal pads can vary based on board fabrication site.

EXAMPLE STENCIL DESIGN

DBV0006A

SOT-23 - 1.45 mm max height

SMALL OUTLINE TRANSISTOR



SOLDER PASTE EXAMPLE
BASED ON 0.125 mm THICK STENCIL
SCALE:15X

4214840/G 08/2024

NOTES: (continued)

8. Laser cutting apertures with trapezoidal walls and rounded corners may offer better paste release. IPC-7525 may have alternate design recommendations.
9. Board assembly site may have different recommendations for stencil design.

DCK0006A



PACKAGE OUTLINE

SOT - 1.1 max height

SMALL OUTLINE TRANSISTOR

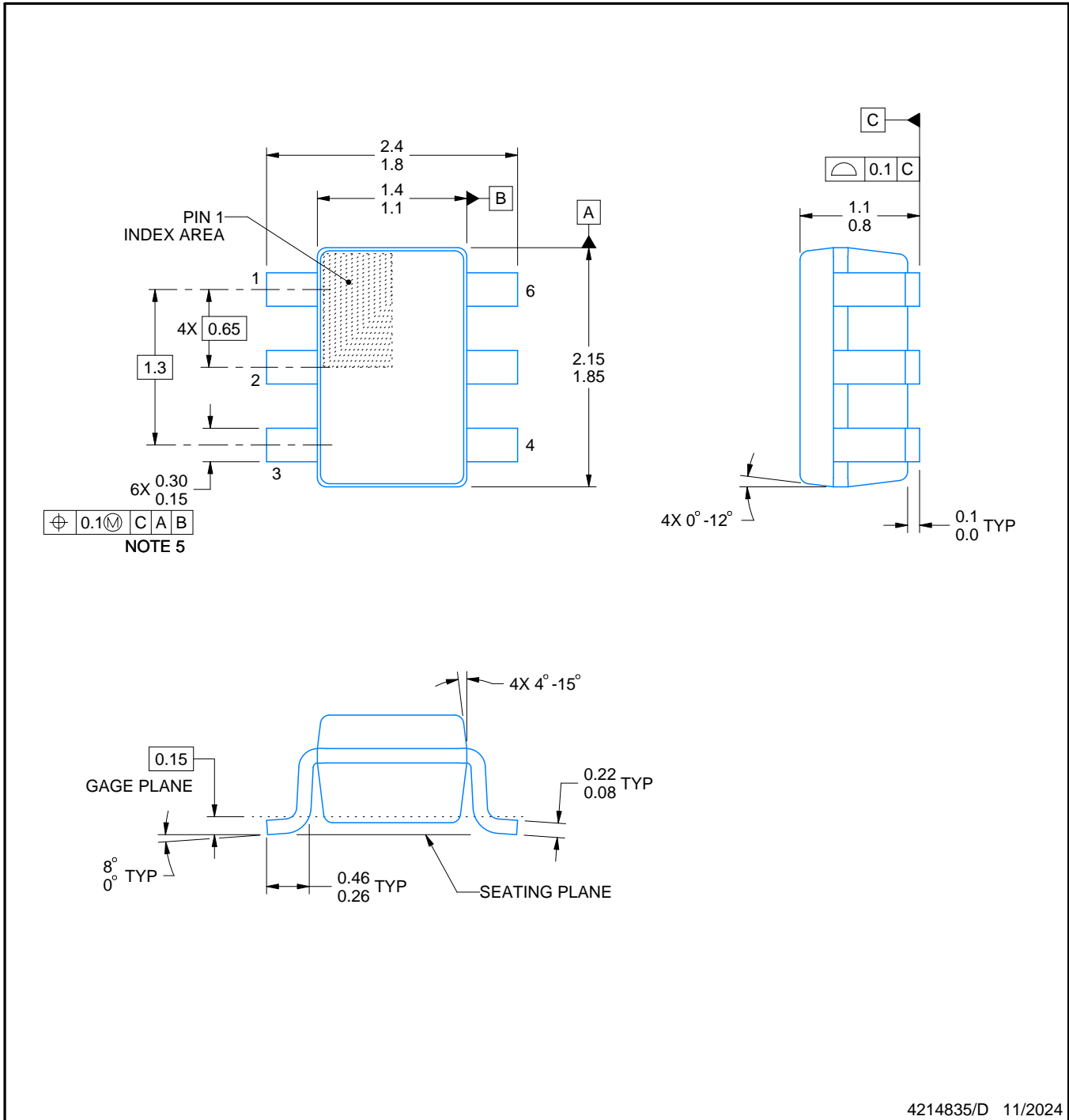

4214835/D 11/2024

NOTES:

1. All linear dimensions are in millimeters. Any dimensions in parenthesis are for reference only. Dimensioning and tolerancing per ASME Y14.5M.
2. This drawing is subject to change without notice.
3. Body dimensions do not include mold flash or protrusion. Mold flash and protrusion shall not exceed 0.15 per side.
4. Falls within JEDEC MO-203 variation AB.

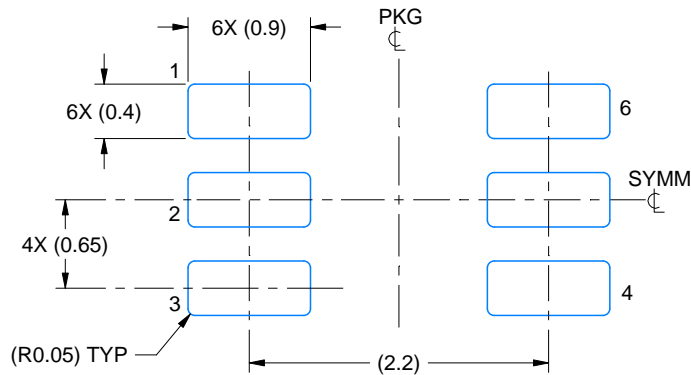

LAND PATTERN EXAMPLE
EXPOSED METAL SHOWN
SCALE:18X

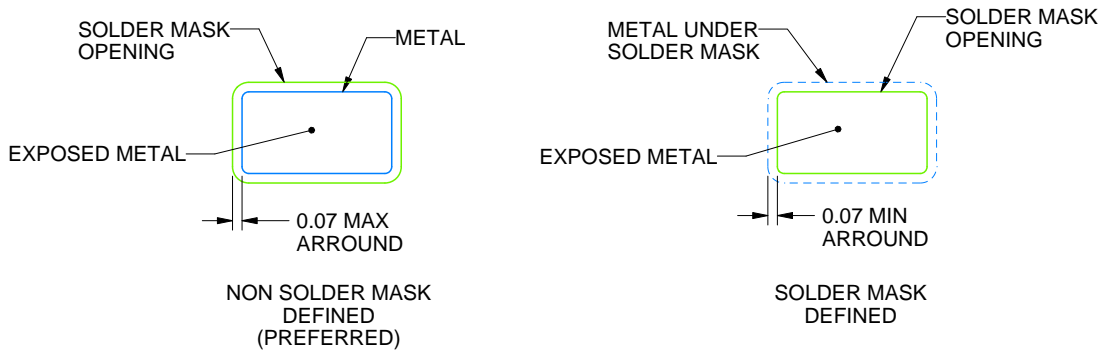

SOLDER MASK DETAILS

4214835/D 11/2024

NOTES: (continued)

- 5. Publication IPC-7351 may have alternate designs.
- 6. Solder mask tolerances between and around signal pads can vary based on board fabrication site.

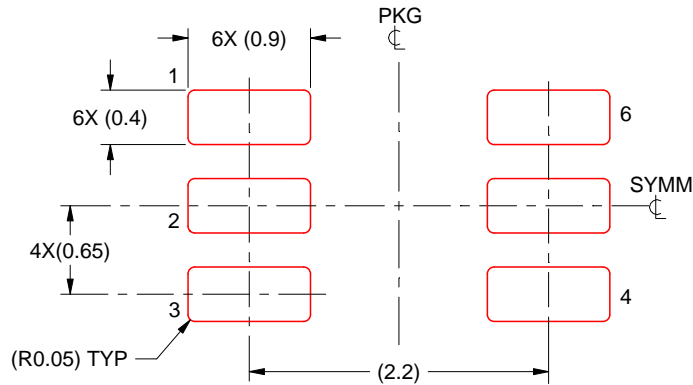

SOLDER PASTE EXAMPLE
BASED ON 0.125 THICK STENCIL
SCALE:18X

4214835/D 11/2024

NOTES: (continued)

7. Laser cutting apertures with trapezoidal walls and rounded corners may offer better paste release. IPC-7525 may have alternate design recommendations.
8. Board assembly site may have different recommendations for stencil design.

重要なお知らせと免責事項

TI は、技術データと信頼性データ (データシートを含みます)、設計リソース (リファレンス デザインを含みます)、アプリケーションや設計に関する各種アドバイス、Web ツール、安全性情報、その他のリソースを、欠陥が存在する可能性のある「現状のまま」提供しており、商品性および特定目的に対する適合性の黙示保証、第三者の知的財産権の非侵害保証を含むいかなる保証も、明示的または黙示的にかかわらず拒否します。

これらのリソースは、TI 製品を使用する設計の経験を積んだ開発者への提供を意図したものです。(1) お客様のアプリケーションに適した TI 製品の選定、(2) お客様のアプリケーションの設計、検証、試験、(3) お客様のアプリケーションに該当する各種規格や、その他のあらゆる安全性、セキュリティ、規制、または他の要件への確実な適合に関する責任を、お客様のみが単独で負うものとし、

上記の各種リソースは、予告なく変更される可能性があります。これらのリソースは、リソースで説明されている TI 製品を使用するアプリケーションの開発の目的でのみ、TI はその使用をお客様に許諾します。これらのリソースに関して、他の目的で複製することや掲載することは禁止されています。TI や第三者の知的財産権のライセンスが付与されている訳ではありません。お客様は、これらのリソースを自身で使用した結果発生するあらゆる申し立て、損害、費用、損失、責任について、TI およびその代理人を完全に補償するものとし、TI は一切の責任を拒否します。

TI の製品は、[TI の販売条件](#)、[TI の総合的な品質ガイドライン](#)、[ti.com](#) または TI 製品などに関連して提供される他の適用条件に従い提供されます。TI がこれらのリソースを提供することは、適用される TI の保証または他の保証の放棄の拡大や変更を意味するものではありません。TI がカスタム、またはカスタマー仕様として明示的に指定していない限り、TI の製品は標準的なカタログに掲載される汎用機器です。

お客様がいかなる追加条項または代替条項を提案する場合も、TI はそれらに異議を唱え、拒否します。

Copyright © 2026, Texas Instruments Incorporated

最終更新日 : 2025 年 10 月