

TLV3801/TLV3802/TLV3811(C) LVDS 出力、225ps の高速コンパレータ

1 特長

- 小さい伝搬遅延時間: 225ps
- 小さいオーバードライブ分散: 5ps
- 静止電流: 17 mA
- 高いトグル周波数: 3GHz/6Gbps
- 狭パルス幅検出性能: 240ps
- LVDS 出力
- 入力と出力のグラウンド基準電圧を分離
- 単一電源電圧: 2.7V~5.25V
- 低い入力オフセット電圧: $\pm 0.5\text{mV}$
- 内部 2mV ヒステリシス: TLV380x
- 内部 1.1mV ヒステリシス: TLV3811
- 内部 0mV ヒステリシス: TLV3811C
- パッケージ: TLV3801 (8 ピン WSON)、TLV3811(C) (6 ピン DSBGA)、TLV3802 (12 ピン WSON)

2 アプリケーション

- LIDAR の距離センシング
- タイム・オブ・フライト (ToF) センサ
- オシロスコープとロジック・アナライザの高速トリガ機能
- 高速差動ライン・レシーバ
- ドローン・ビジョン

3 概要

TLV380x/TLV3811(C) は、広い電源電圧範囲と 3GHz の非常に高いトグル周波数に対応する 225ps 高速コンパレータです。動作電源電圧範囲が 2.7V~5.25V (単一電源の場合)、2.7V~5.25V (分割電源の場合) であることに加えて、これらの機能はすべて業界標準の小型パッケージで供給されるため、これらのデバイスは LIDAR、差動ラ

イン・レシーバ・アプリケーション、試験 / 測定システムに最適です。

TLV380x/TLV3811(C) は、5ps という非常に強力な入力オーバードライブ性能と、わずか 240ps の狭パルス幅性能を備えています。ばらつきの小さい伝搬遅延特性 (入力オーバードライブ起因) と、短いパルスを検出する能力を併せ持つこれらのデバイスは、ファクトリ・オートメーション、ドローン・ビジョンなどのタイム・オブ・フライト (ToF) アプリケーションに最適です。

TLV380x/TLV3811(C) の低電圧差動信号 (LVDS) 出力は、データ スループットの向上と消費電力の最適化にも役立ちます。同様に相補出力は、各出力の同相ノイズを抑制することで、EMI 低減に役立ちます。LVDS 出力は、アプリケーション内の下流の大半の FPGA や CPU など、標準 LVDS 入力を受け入れるその他のデバイスの直接駆動およびインターフェイスを可能にします。

TLV3801 および TLV3802 は 8 ピン WSON パッケージおよび 12 ピン WSON パッケージ、TLV3811(C) は超小型の 6 ピン WCSP パッケージで提供されているため、光学センサ モジュールなどスペースの制約が厳しいアプリケーションに適しています。

製品情報

部品番号	パッケージ (1)	本体サイズ (公称)
TLV3801	WSON (8)	2.00mm × 2.00mm
TLV3811(C)	DSBGA (6)	1.218mm × 0.818mm
TLV3802	WSON (12)	3.00mm × 2.00mm

1. 利用可能なすべてのパッケージについては、データシートの末尾にある注文情報を参照してください。

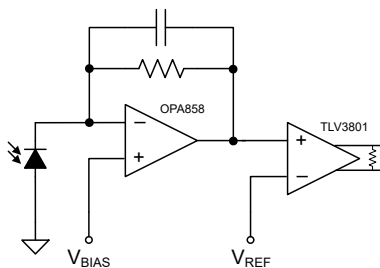

TLV3801 光レシーバ回路

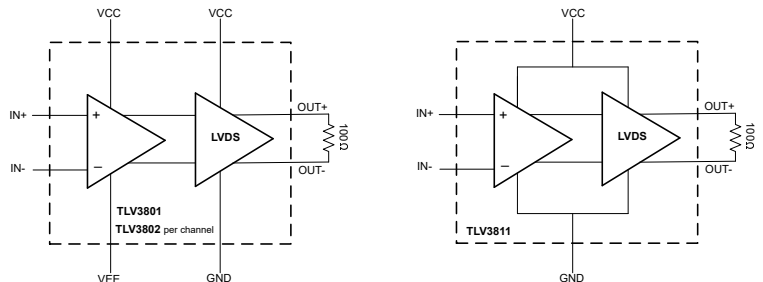

機能ブロック図



Table of Contents

1 特長.....	1	7.3 Feature Description.....	14
2 アプリケーション.....	1	7.4 Device Functional Modes.....	14
3 概要.....	1	8 Application and Implementation.....	16
4 Revision History.....	2	8.1 Application Information.....	16
5 Pin Configuration and Functions.....	3	8.2 Typical Application.....	16
6 Specifications.....	5	8.3 Power Supply Recommendations.....	21
6.1 Absolute Maximum Ratings.....	5	8.4 Layout.....	22
6.2 ESD Ratings.....	5	9 Device and Documentation Support.....	23
6.3 Thermal Information.....	5	9.1 Device Support.....	23
6.4 Recommended Operating Conditions.....	5	9.2 ドキュメントの更新通知を受け取る方法.....	23
6.5 Electrical Characteristics.....	7	9.3 サポート・リソース.....	23
6.6 Timing Diagrams.....	9	9.4 Trademarks.....	23
6.7 Typical Characteristics.....	10	9.5 静電気放電に関する注意事項.....	23
7 Detailed Description.....	14	9.6 用語集.....	23
7.1 Overview.....	14	10 Mechanical, Packaging, and Orderable Information.....	23
7.2 Functional Block Diagram.....	14		

4 Revision History

資料番号末尾の英字は改訂を表しています。その改訂履歴は英語版に準じています。

Changes from Revision B (March 2023) to Revision C (November 2023) Page

- TLV3802 のプレビューを RTM リリースに変更..... 1

Changes from Revision A (October 2022) to Revision B (March 2023) Page

- データシート全体に TLV3811(C) および TLV3802 (仮) を追加..... 1

Changes from Revision * (December 2021) to Revision A (October 2022) Page

- TLV3811 のプレビューを RTM に変更..... 1

5 Pin Configuration and Functions



図 5-1. WSON Package
8-Pin DSG
Top View



図 5-2. DSBGA Package
6-Pin YBG
Top View

表 5-1. Pin Functions

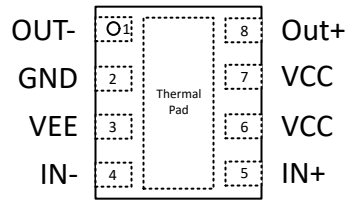
NAME	PIN		I/O	DESCRIPTION
	TLV3801	TLV3811(C)		
IN+	5	A1	I	Non-inverting input
IN-	4	B1	I	Inverting input
OUT+	8	A3	O	Non-inverting output
OUT-	1	B3	O	Inverting output
V _{EE}	3	-	I	Negative power supply (If using single supply, connect to GND)
V _{CC}	6, 7	A2	I	Positive power supply
GND	2	B2	I	Ground

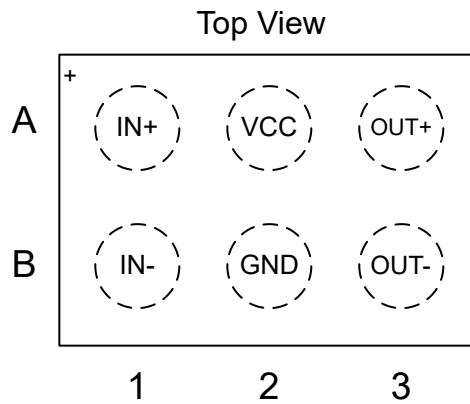
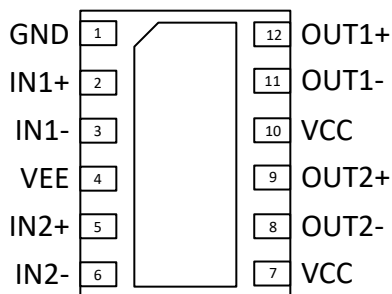

**図 5-3. WSON Package
12-Pin DSS
Top View**

表 5-2. Pin Functions

PIN		I/O	DESCRIPTION
NAME	TLV3802		
GND	1	I	Ground
IN1+	2	I	Channel 1 Non-inverting input
IN1-	3	I	Channel 1 Inverting input
VEE	4	I	Negative power supply (If using single supply, connect to GND)
IN2+	5	I	Channel 2 Non-inverting input
IN2-	6	I	Channel 2 Inverting input
VCC	7	I	Positive power supply
OUT2-	8	O	Channel 2 Inverting output
OUT2+	9	O	Channel 2 Non-inverting output
VCC	10	I	Positive power supply
OUT1-	11	O	Channel 1 Inverting output
OUT1+	12	O	Channel 1 Non-inverting output
Thermal Pad	–	–	Connect directly to VEE

6 Specifications

6.1 Absolute Maximum Ratings

over operating free-air temperature range (unless otherwise noted)⁽¹⁾

	MIN	MAX	UNIT
Supply voltage: ($V_{CC} - V_{EE}$) and ($V_{CC} - GND$) ⁽²⁾	-0.3	5.5	V
Input pins (IN+, IN-) from V_{EE} (WSON) ⁽³⁾	$V_{EE} - 0.3$	$V_{CC} + 0.3$	V
Input pins (IN+, IN-) from GND (DSBGA) ⁽⁴⁾	GND - 0.3	$V_{CC} + 0.3$	V
Current into input pins (IN+, IN-)	-10	10	mA
Output (OUT+, OUT-)	GND	V_{CC}	V
Current into output pins (OUT+, OUT-)		10	mA
Junction temperature, T_J		150	°C
Storage temperature, T_{stg}	-65	150	°C

- (1) Operation outside the Absolute Maximum Ratings may cause permanent device damage. Absolute Maximum Ratings do not imply functional operation of the device at these or any other conditions beyond those listed under Recommended Operating Conditions. If used outside the Recommended Operating Conditions but within the Absolute Maximum Ratings, the device may not be fully functional, and this may affect device reliability, functionality, performance, and shorten the device lifetime.
- (2) V_{EE} less than or equal to GND
- (3) Input terminals are diode-clamped to V_{EE} and V_{CC}
- (4) Input terminals are diode-clamped to GND and V_{CC}

6.2 ESD Ratings

			VALUE	UNIT
$V_{(ESD)}$	Electrostatic discharge	Human-body model (HBM), per ANSI/ESDA/JEDEC JS-001 ⁽¹⁾	±2000	V
		Charged-device model (CDM), per ANSI/ESDA/JEDEC JS-002 ⁽²⁾	±1000	

- (1) JEDEC document JEP155 states that 500 V HBM allows safe manufacturing with a standard ESD control process.
- (2) JEDEC document JEP157 states that 250 V CDM allows safe manufacturing with a standard ESD control process.

6.3 Thermal Information

THERMAL METRIC ⁽¹⁾		TLV3801	TLV3811(C)	TLV3802	UNIT
		DSG (WSON)	YBG (DSBGA)	DSS (WSON)	
		8 PINS	6 PINS	12 PINS	
R_{qJA}	Junction-to-ambient thermal resistance	69.4	132.1	63.2	°C/W
$R_{qJC(top)}$	Junction-to-case (top) thermal resistance	95.7	1.4	61.9	°C/W
R_{qJB}	Junction-to-board thermal resistance	36.2	41	30.7	°C/W
γ_{JT}	Junction-to-top characterization parameter	3.5	0.3	2.4	°C/W
γ_{JB}	Junction-to-board characterization parameter	36.0	41	30.7	°C/W
$R_{qJC(bot)}$	Junction-to-case (bottom) thermal resistance	9.4	n/a	8.7	°C/W

- (1) For more information about traditional and new thermal metrics, see the [Semiconductor and IC Package Thermal Metrics](#) report.

6.4 Recommended Operating Conditions

over operating free-air temperature range (unless otherwise noted)

	MIN	MAX	UNIT
Single supply operation: $V_{CC} - V_{EE}$ with $V_{EE} = GND$	2.7	5.25	V
Split supply operation: $V_{CC} - V_{EE}$ with $V_{EE} < GND$ (WSON)	2.7	5.25	V
Split supply operation: $V_{CC} - GND$ with $V_{EE} < GND$ (WSON)	2.4	5.25	V
Input voltage range (WSON)	$V_{EE} + 1.5$	$V_{CC} + 0.1$	V
Input voltage range (DSBGA)	GND + 1.5	$V_{CC} + 0.1$	V
Differential Input voltage range	-1.5	+1.5	V

6.4 Recommended Operating Conditions (続き)

over operating free-air temperature range (unless otherwise noted)

	MIN	MAX	UNIT
Ambient temperature, T_A	-40	125	°C

6.5 Electrical Characteristics

For $V_{CC} = 3.3\text{ V}$, $V_{EE} = \text{GND} = 0$, $V_{CM} = 2.5\text{ V}$ at $T_A = 25^\circ\text{C}$ (Unless otherwise noted)

PARAMETER		TEST CONDITIONS	MIN	TYP	MAX	UNIT
DC Input Characteristics						
V_{OS}	Input offset voltage	$T_A = -40^\circ\text{C}$ to $+125^\circ\text{C}$	-5 ⁽¹⁾	±0.5	+5 ⁽¹⁾	mV
V_{HYS}	Input hysteresis voltage	TLV3801, TLV3802		2		mV
V_{HYS} (DSBGA)	Input hysteresis voltage	TLV3811		1.1		mV
	Input hysteresis voltage	TLV3811C		0		mV
$V_{CM\text{-}Range}$	Common-mode voltage range	Single Supply: $V_{EE} = \text{GND}$ $V_{CC} - V_{EE} = 2.7\text{ V}$ to 5.25 V $T_A = -40^\circ\text{C}$ to $+125^\circ\text{C}$	$V_{EE} + 1.5$		V_{CC}	V
$V_{CM\text{-}Range}$ (WSON)	Common-mode voltage range	Split Supply: $V_{EE} < \text{GND}$ $V_{CC} - V_{EE} = 2.7\text{ V}$ to 5.25 V and $V_{CC} - \text{GND} = 2.4\text{ V}$ to 5.25 V $T_A = -40^\circ\text{C}$ to $+125^\circ\text{C}$	$V_{EE} + 1.5$		V_{CC}	V
CMRR (WSON)	Common mode rejection ratio	$V_{CM} = V_{EE} + 1.5\text{V}$ to V_{CC}		80		dB
CMRR (DSBGA)	Common mode rejection ratio	$V_{CM} = \text{GND} + 1.5\text{V}$ to V_{CC}		80		dB
PSRR	Power supply rejection ratio	Single Supply: $V_{EE} = \text{GND}$ $V_{CC} - V_{EE} = 2.7\text{ V}$ to 5.25 V		80		dB
PSRR (WSON)	Power supply rejection ratio	Split Supply: $V_{EE} < \text{GND}$ $V_{CC} - V_{EE} = 2.7\text{ V}$ to 5.25 V and $V_{CC} - \text{GND} = 2.4\text{ V}$ to 5.25 V		80		dB
I_B	Input bias current	$T_A = -40^\circ\text{C}$ to $+125^\circ\text{C}$	-10	2	10	μA
I_{OS}	Input offset current	$T_A = -40^\circ\text{C}$ to $+125^\circ\text{C}$	-4	±0.1	4	μA
C_{IC}	Input capacitance, common mode			1		pF
DC Output Characteristics						
V_{OCM}	Output common mode voltage	$V_{CC} - \text{GND} \geq 2.6\text{ V}$ $T_A = -40^\circ\text{C}$ to $+125^\circ\text{C}$	1.125	1.25	1.375	V
	Output common mode voltage	$V_{CC} - \text{GND} < 2.6\text{ V}$ $T_A = -40^\circ\text{C}$ to $+125^\circ\text{C}$	0.92	1.2	1.29	V
ΔV_{OCM}	Output common mode voltage mismatch	$T_A = -40^\circ\text{C}$ to $+125^\circ\text{C}$	-30		30	mV
V_{OCM_PP}	Peak-to-Peak output common mode voltage			50		mVpp
V_{OD}	Differential output voltage (WSON)	$T_A = -40^\circ\text{C}$ to $+125^\circ\text{C}$	250	350	450	mV
V_{OD}	Differential output voltage (DSBGA)	$T_A = -40^\circ\text{C}$ to $+125^\circ\text{C}$	240	350	450	mV
ΔV_{OD}	Differential output voltage mismatch	$T_A = -40^\circ\text{C}$ to $+125^\circ\text{C}$	-30		30	mV
Power Supply						
I_Q (TLV3801)	Quiescent current per comparator	$T_A = -40^\circ\text{C}$ to $+125^\circ\text{C}$		20	26.6	mA
I_Q (TLV3811(C))	Quiescent current per comparator	$T_A = -40^\circ\text{C}$ to $+125^\circ\text{C}$		17	23	mA

6.5 Electrical Characteristics (続き)

For $V_{CC} = 3.3\text{ V}$, $V_{EE} = \text{GND} = 0$, $V_{CM} = 2.5\text{ V}$ at $T_A = 25^\circ\text{C}$ (Unless otherwise noted)

PARAMETER		TEST CONDITIONS	MIN	TYP	MAX	UNIT
I_Q (TLV3802)	Quiescent current per comparator	$T_A = -40^\circ\text{C}$ to $+125^\circ\text{C}$		19	23.5	mA
AC Characteristics						
t_{PD}	Propagation delay	$V_{OVERDRIVE} = 50\text{ mV}$, $V_{UNDERDRIVE} = 50\text{ mV}$, 50 MHz Squarewave		225		ps
Tempco of t_{PD}	Temperature Coefficient of propagation delay			± 0.2		ps/ $^\circ\text{C}$
t_{PD_SKEW}	Propagation delay skew	$V_{OVERDRIVE} = 50\text{ mV}$, $V_{UNDERDRIVE} = 50\text{ mV}$, 50 MHz Squarewave		± 2.5		ps
Δt_{PD} (TLV3802 only)	Channel-to-channel propagation delay skew	$V_{OVERDRIVE} = V_{UNDERDRIVE} = 50\text{ mV}$, 50 MHz Squarewave		6		ps
$t_{CM_DISPERSION}$	Common mode dispersion	V_{CM} varied from $V_{CM}(\text{min})$ to $V_{CM}(\text{max})$		2		ps
$t_{OD_DISPERSION}$	Overdrive dispersion	Overdrive varied from 20 mV to 100 mV		5		ps
$t_{OD_DISPERSION}$	Overdrive dispersion	Overdrive varied from 10 mV to 1 V		15		ps
$t_{UD_DISPERSION}$	Underdrive dispersion	Underdrive varied from 20 mV to 100 mV		7		ps
$t_{UD_DISPERSION}$	Underdrive dispersion	Underdrive varied from 10 mV to 1 V		10		ps
t_R	Rise time	20% to 80%		135		ps
t_F	Fall time	80% to 20%		135		ps
f_{TOGGLE}	Input toggle frequency	$V_{IN} = 200\text{ mV}_{PP}$ Sine Wave, $V_{OD} = 550\text{ mV}$		2.3		GHz
f_{TOGGLE}	Input toggle frequency	$V_{IN} = 200\text{ mV}_{PP}$ Sine Wave, 50% Output swing		3		GHz
TR	Toggle Rate	$V_{IN} = 200\text{ mV}_{PP}$ Sine Wave, $V_{OD} = 550\text{ mV}$		4.6		Gbps
TR	Toggle Rate	$V_{IN} = 200\text{ mV}_{PP}$ Sine Wave, 50% Output swing		6		Gbps
PulseWidth	Minimum allowed input pulse width	$V_{OVERDRIVE} = V_{UNDERDRIVE} = 50\text{ mV}$ $PW_{OUT} = 90\%$ of PW_{IN}		240		ps

(1) Ensured by characterization

6.6 Timing Diagrams



図 6-1. General Timing Diagram



図 6-2. Overdrive Dispersion

6.7 Typical Characteristics

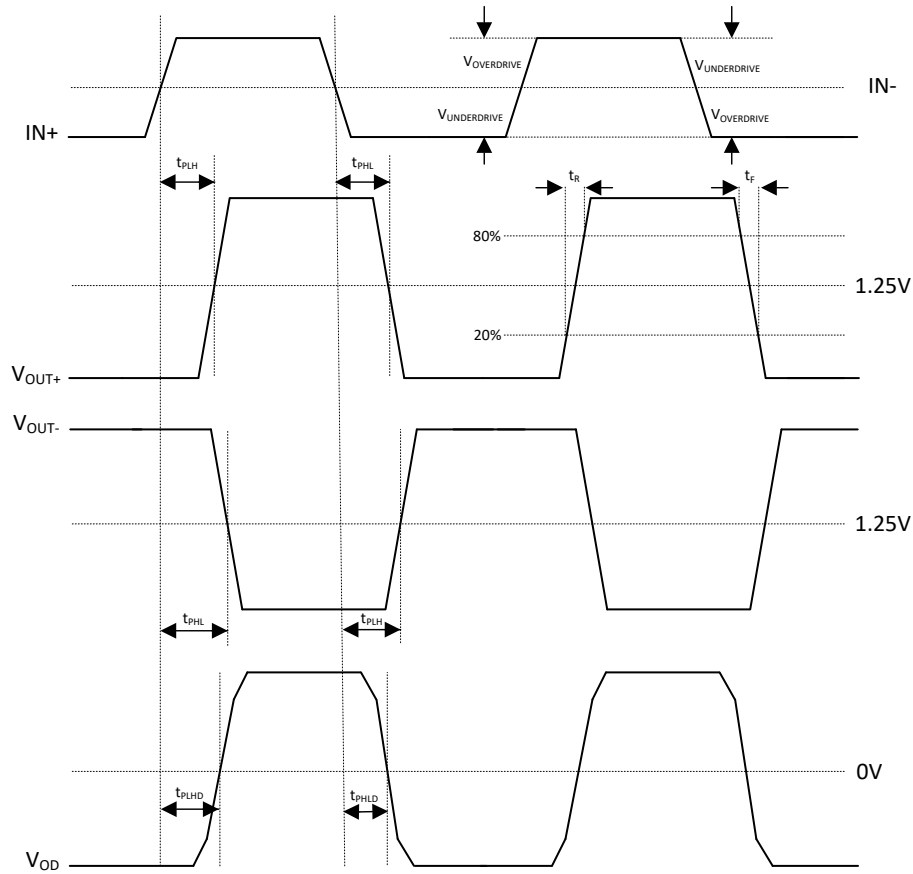
At $T_A = 25^\circ\text{C}$, $V_{CC} - V_{EE} = 3.3\text{ V}$ to 5 V while $V_{EE} = \text{GND} = 0$, $V_{CM} = 2.5\text{ V}$, and input overdrive/underdrive = 50 mV , unless otherwise noted.

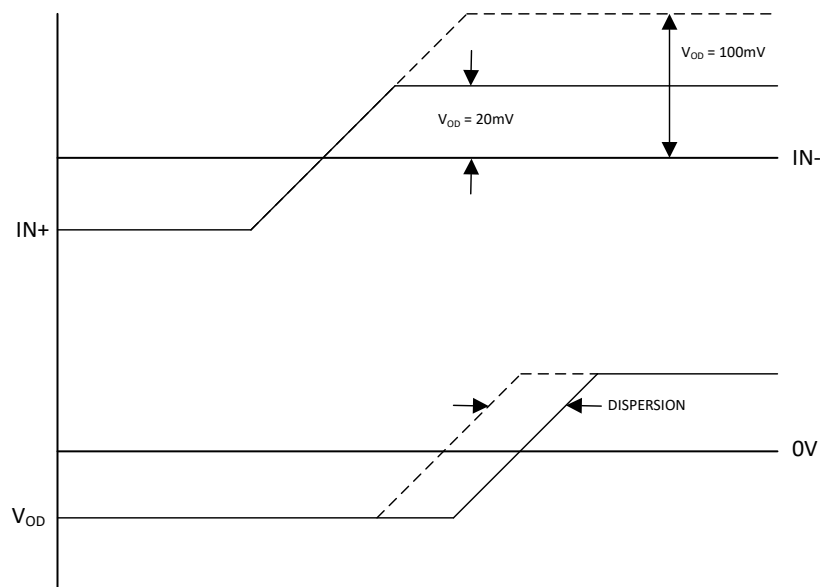
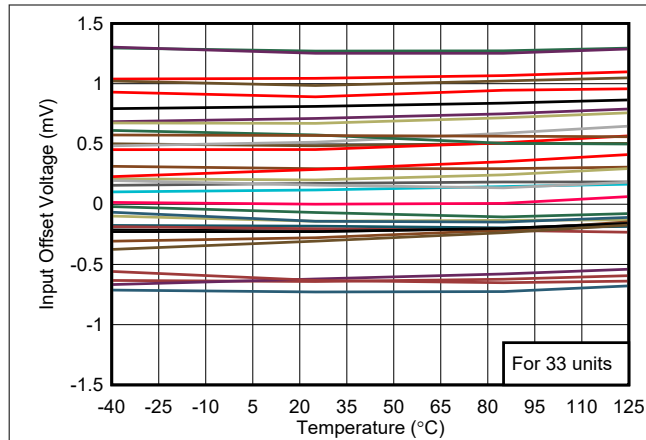

Figure 6-3. Offset vs. Temperature

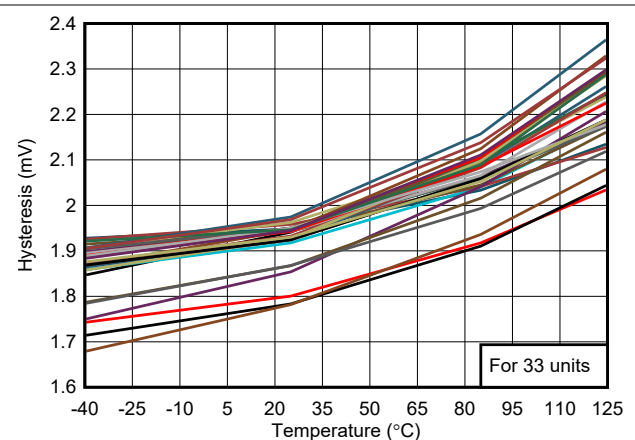

Figure 6-4. TLV3801 Hysteresis vs. Temperature

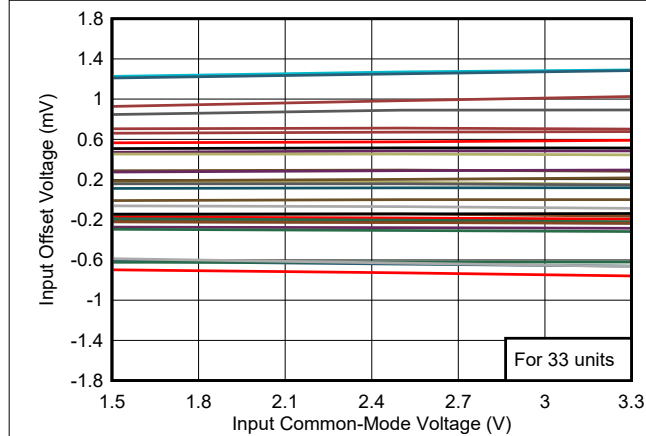

Figure 6-5. Offset vs. Common-Mode, 3.3 V

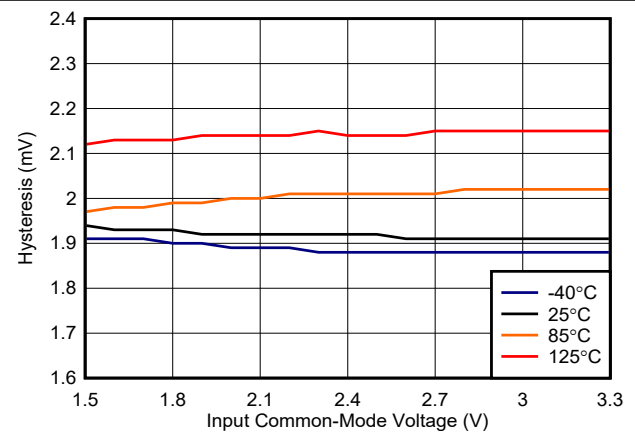

Figure 6-6. TLV3801 Hysteresis vs. Common-Mode, 3.3 V

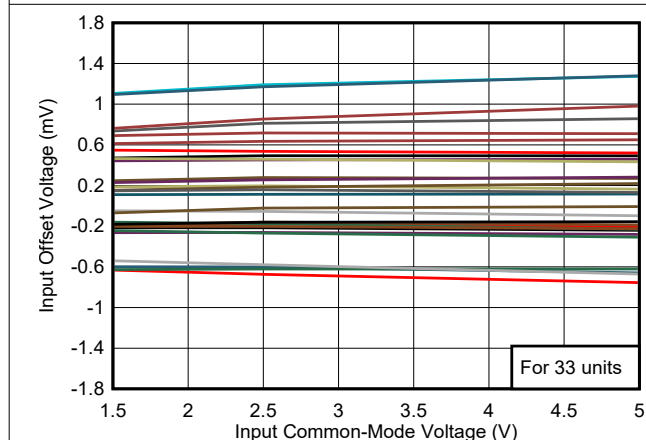

Figure 6-7. Offset vs. Common-Mode, 5 V

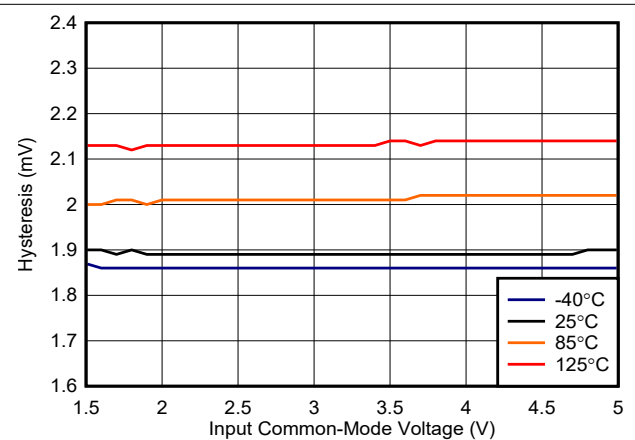

Figure 6-8. TLV3801 Hysteresis vs. Common-Mode, 5 V

6.7 Typical Characteristics (continued)

At $T_A = 25^\circ\text{C}$, $V_{CC} - V_{EE} = 3.3\text{ V}$ to 5 V while $V_{EE} = \text{GND} = 0$, $V_{CM} = 2.5\text{ V}$, and input overdrive/underdrive = 50 mV , unless otherwise noted.

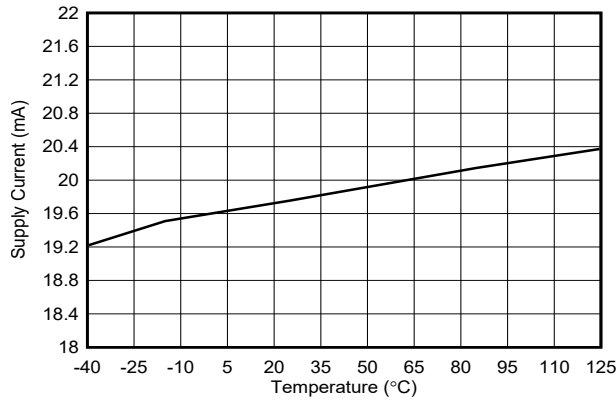

Figure 6-9. TLV3801 Supply Current vs. Temperature

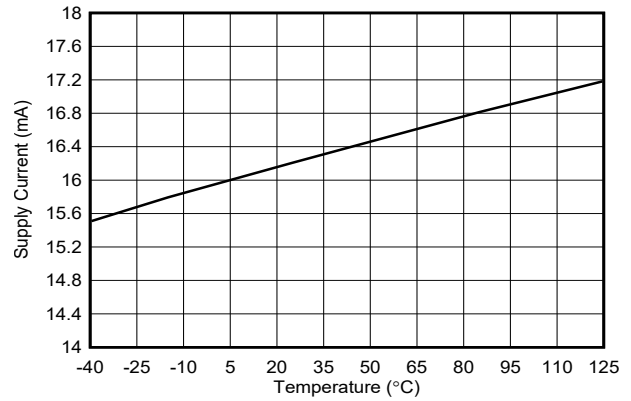

Figure 6-10. TLV3811(C) Supply Current vs. Temperature

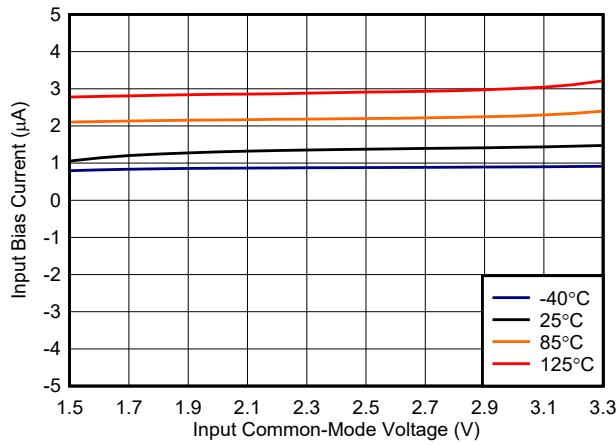

Figure 6-11. Bias Current vs. Common-Mode, 3.3 V

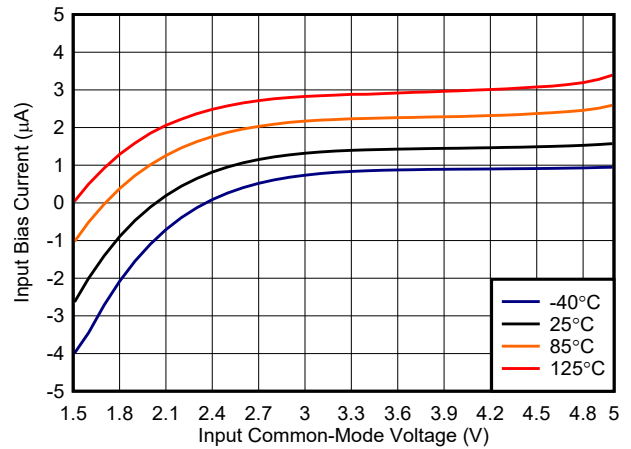

Figure 6-12. Bias Current vs. Common-Mode, 5 V

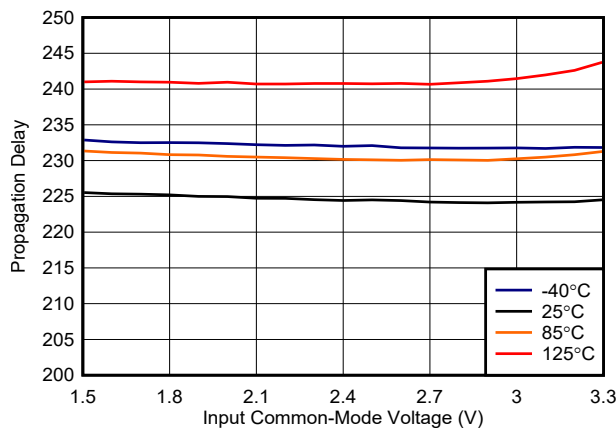

Figure 6-13. Propagation Delay vs. Common-Mode, 3.3 V

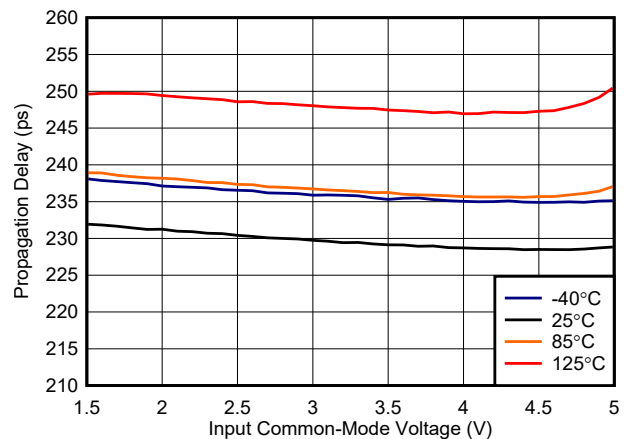

Figure 6-14. Propagation Delay vs. Common-Mode, 5 V

6.7 Typical Characteristics (continued)

At $T_A = 25^\circ\text{C}$, $V_{CC} - V_{EE} = 3.3\text{ V}$ to 5 V while $V_{EE} = \text{GND} = 0$, $V_{CM} = 2.5\text{ V}$, and input overdrive/underdrive = 50 mV , unless otherwise noted.

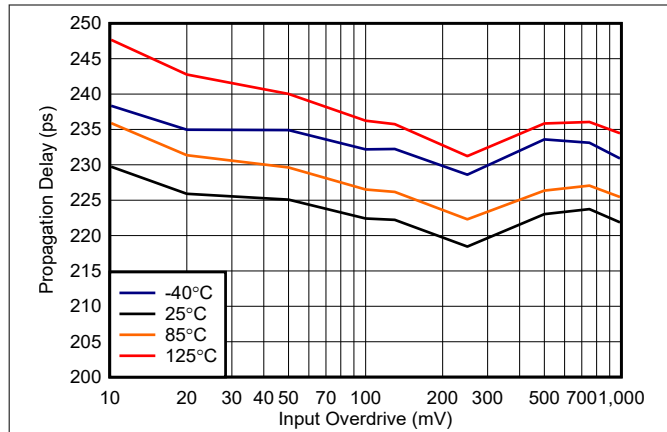

Figure 6-15. Propagation Delay vs. Overdrive, 3.3 V

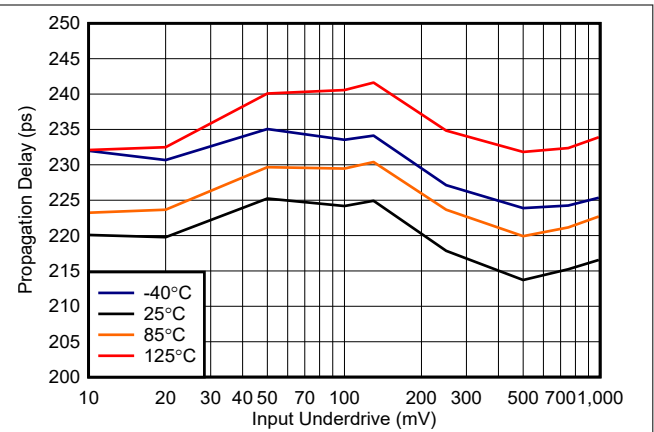

Figure 6-16. Propagation Delay vs. Underdrive, 3.3 V

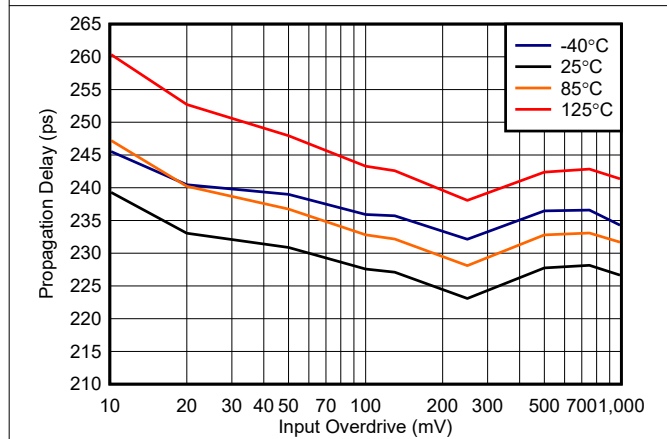

Figure 6-17. Propagation Delay vs. Overdrive, 5 V

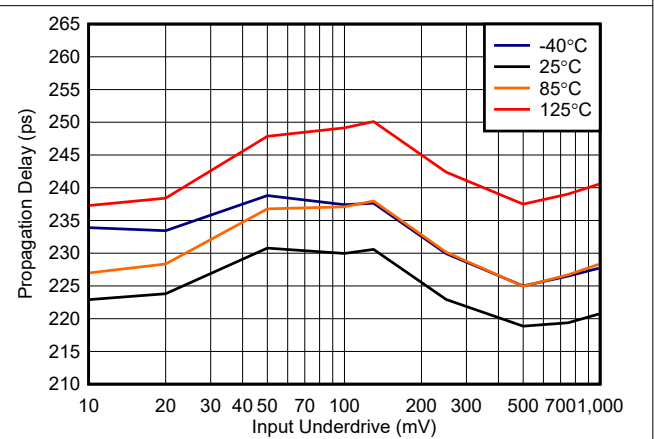

Figure 6-18. Propagation Delay vs. Underdrive, 5 V

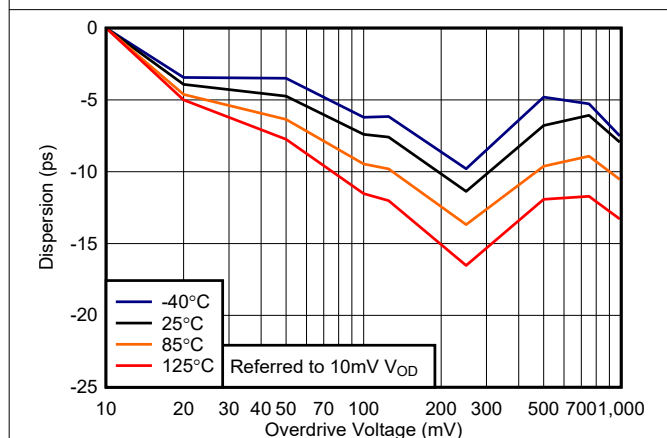

Figure 6-19. Dispersion vs. Overdrive, 3.3 V

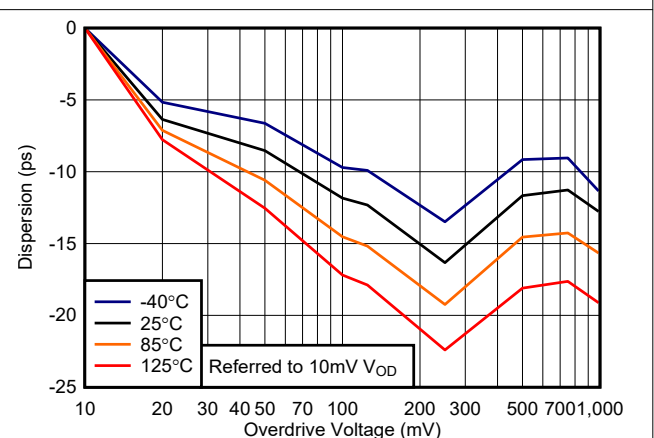

Figure 6-20. Dispersion vs. Overdrive, 5 V

6.7 Typical Characteristics (continued)

At $T_A = 25^\circ\text{C}$, $V_{CC} - V_{EE} = 3.3\text{ V}$ to 5 V while $V_{EE} = \text{GND} = 0$, $V_{CM} = 2.5\text{ V}$, and input overdrive/underdrive = 50 mV , unless otherwise noted.



图 6-21. Minimum Pulse Width vs. Common-Mode, 3.3 V



图 6-22. Minimum Pulse Width vs. Common-Mode, 5 V

7 Detailed Description

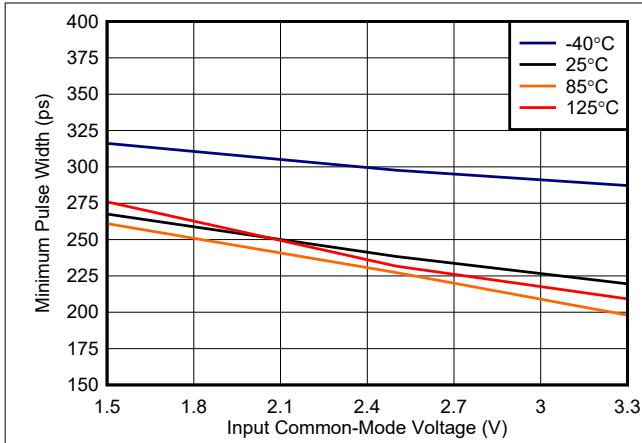
7.1 Overview

The TLV380x/TLV3811(C) are high-speed comparators with LVDS output. The fast response time of these comparators make them well suited for applications that require narrow pulse width detection or high toggle frequencies. The TLV3801 is available in the 8-pin WSON package and the TLV3802 is available in the 12-pin WSON package while the TLV3811(C) is available in the 6-pin DSBGA package.

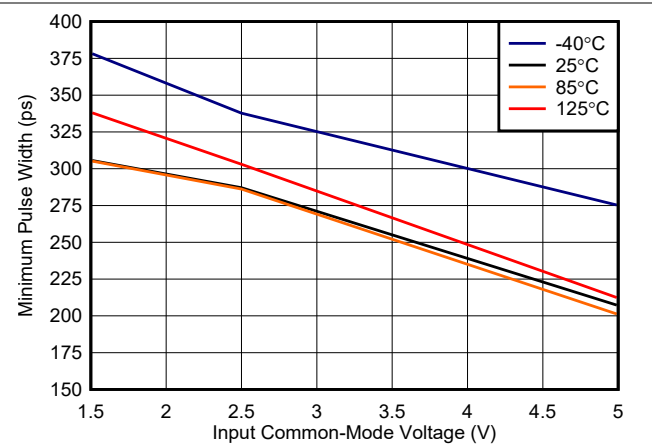
7.2 Functional Block Diagram

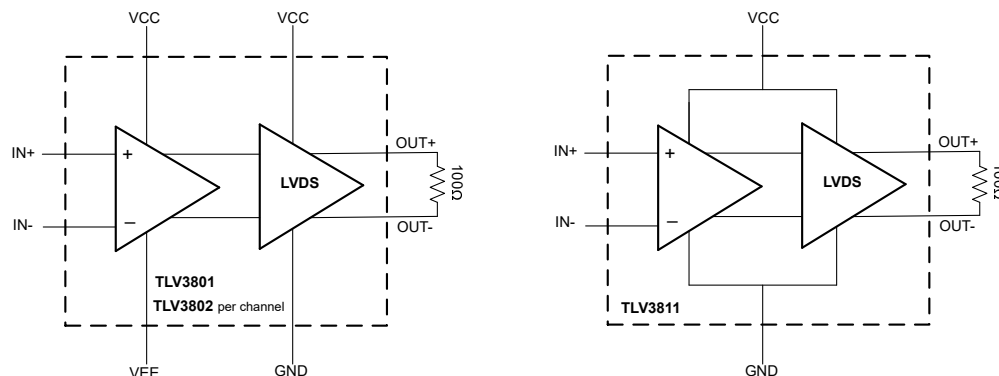

7.3 Feature Description

The TLV380x/TLV3811(C) are high-speed comparators with a typical propagation delay of 225 ps and LVDS output. The minimum pulse width detection capability is 240 ps and the typical toggle frequency is 3 GHz (6 Gbps). These comparators are well suited for distance sensing for LIDAR and time-of-flight applications as well as for high-speed test and measurement systems. The TLV380x has two separate power rails for the input and the output; this allows the input to be referenced from either single or split supply (VCC and VEE) while the output is referenced from ground (VCC and GND). On the other hand, the TLV3811(C) has one power rail for both inputs and outputs and can only be operated at a single supply.

7.4 Device Functional Modes

The TLV380x has a single functional mode and is operational on the condition that both the input supply voltage (VCC - VEE) is greater than or equal to 2.7 V and the output supply voltage (VCC - GND) is greater than or equal to 2.4 V.

The TLV3811(C) has a single functional mode and is operational when the power supply voltage (VCC - GND) is greater than or equal to 2.7 V.

7.4.1 Inputs

The TLV380x/TLV3811(C) feature an input stage, capable of operating between 1.5 V above VEE (GND for TLV3811(C)) and 0.1 V above VCC, with an internal ESD protection circuit that includes two pairs of front-to-back diodes between IN+ and IN- as well as two 50 Ω resistors, as shown in [Figure 7-1](#). This prevents damage to the input stage by limiting the differential input voltage to be no more than twice the diode's forward-voltage drop $2 \times V_F$ (2×0.7 V).



図 7-1. Input Stage Circuitry

When the differential input voltage exceeds $2 \times V_F$, the input bias current increases at the input pins IN+ and IN-, as shown in 式 1.

$$\text{Input Current} = [(V_{IN+} - V_{IN-}) - 2 \times V_F] / (2 \times 50) \quad (1)$$

To avoid damaging the inputs when exceeding the recommended input voltage range, an external resistor should be used to limit the current. The current should be limited to less than 10 mA.

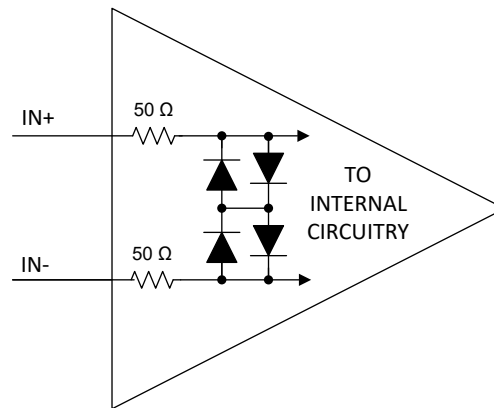
7.4.2 LVDS Output

The TLV380x/TLV3811(C) outputs are LVDS compliant. When the input of the downstream device is terminated with a 100 Ω resistor, the comparators provide a ± 350 mV differential swing at an output common-mode voltage of 1.25 V above GND. Fully differential outputs enable fast digital toggling and reduce EMI compared to single-ended output standards.

8 Application and Implementation

注

Information in the following applications sections is not part of the TI component specification, and TI does not warrant its accuracy or completeness. TI's customers are responsible for determining suitability of components for their purposes, as well as validating and testing their design implementation to confirm system functionality.

8.1 Application Information

8.1.1 Capacitive Loads

Under reasonable capacitive loads, the device maintains specified propagation delay. However, excessive capacitive loading under high switching frequencies may increase supply current, propagation delay, or induce decreased slew rate.

8.1.2 Hysteresis

A comparator's high, open-loop gain creates a small band of input differential voltage where the comparator may produce "chatter" which causes the output to toggle back and forth between a "logic high" and a "logic low". This can cause design challenges for inputs with slow rise and fall times or systems with excessive noise. These challenges can be prevented by adding hysteresis to the comparator. However, hysteresis must be added strategically when input signals are small since it can cause signals to go undetected. As a result, TLV3811C is optimized for detecting small, fast-switching inputs and has 0 mV of internal hysteresis. On the other hand, for detecting larger input signals in the presence of noise, the TLV3811 has 1.1 mV of internal hysteresis and TLV3801 and TLV3802 have 2 mV.

Since the TLV380x/TLV3811(C) only have a minimal amount of internal hysteresis, external hysteresis can be applied in the form of a positive feedback loop that adjusts the trip point of the comparator depending on its current output state. See the [Non-Inverting Comparator With Hysteresis](#) section for more details.

8.2 Typical Application

8.2.1 Optical Receiver

The TLV380x/TLV3811(C) can be used in conjunction with a high performance amplifier such as the OPA858 to create an optical receiver as shown in the [Figure 8-1](#). The photodiode operates in photoconductive mode: exposure to light will cause a reverse current through the photodiode. A bias voltage is applied to the op amp's non-inverting input to prevent saturation at the negative power supply. The OPA858 takes the current conducting through the diode and translates it into a voltage for a high speed comparator to detect. The TLV380x/TLV3811(C) will then output the proper LVDS signal according to the threshold set (V_{REF}).



図 8-1. Optical Receiver

8.2.1.1 Design Requirements

表 8-1. Design Parameters

PARAMETER	VALUE
V_{CC}	+5 V
V_{EE}	0 V
$V_{OUT, SWING}$	100 mV
I_{DIODE}	100 μ A
f_p	159 MHz

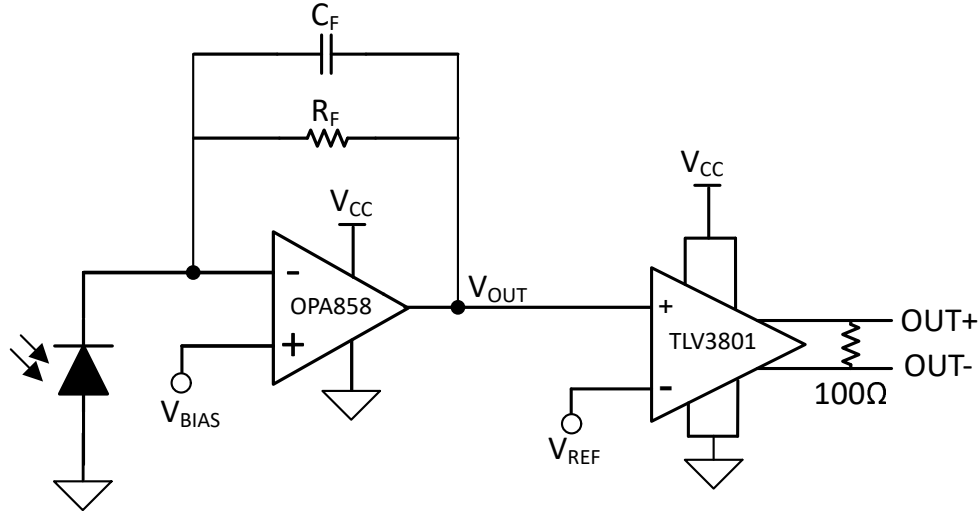
8.2.1.2 Detailed Design Procedure

Set V_{BIAS} to be in the recommended common-mode voltage range of the OPA858. This is also the minimum output voltage of the op amp $V_{OUT, MIN}$ as the op amp will attempt to settle at the voltage applied to the non-inverting input.

The maximum output voltage of the op amp $V_{OUT, MAX}$ can be calculated from the desired output voltage swing $V_{OUT, SWING}$ and $V_{OUT, MIN}$, as shown in 式 2.

$$V_{OUT, MAX} = V_{OUT, SWING} + V_{OUT, MIN} \quad (2)$$

The gain resistor R_F is determined by the desired $V_{OUT, MAX}$ and $V_{OUT, MIN}$ and the maximum current I_{DIODE} through the diode, as shown in 式 2.

$$R_F = (V_{OUT, MAX} - V_{OUT, MIN}) / I_{DIODE} \quad (3)$$

The feedback capacitor, in combination with the gain resistor, forms a pole in the frequency response of the amplifier. The feedback capacitor can be determined by the gain resistor and the desired pole frequency f_p , as shown in 式 2.

$$C_F = 1 / (2 \times \pi \times R_F \times f_p) \quad (4)$$

Set V_{REF} to be the switching threshold voltage between $V_{OUT, MAX}$ and $V_{OUT, MIN}$.

TLV3801, TLV3802, TLV3811

JAJSLB5C – DECEMBER 2021 – REVISED DECEMBER 2023

Select values for V_{BIAS} and V_{REF} . Plug in given values for $V_{OUT, MAX}$, I_{DIODE} , and f_p . For the given example, $V_{BIAS} = 1.5\text{ V}$, $V_{REF} = 1.55\text{ V}$, and R_F, C_F is solved as $1\text{ k}\Omega$ and 1 pF , respectively.

For more information, please refer to the op amp tutorials for stability analysis on the transimpedance amplifier [Spice Stability Analysis](#) and [Op Amp Stability](#). See application note SBOA268A [Transimpedance Amplifier Circuit](#) for more detailed procedures.

8.2.1.3 Application Performance Plots



図 8-2. Optical Receiver Output Waveforms

8.2.2 Non-Inverting Comparator With Hysteresis

A way to implement external hysteresis is to add two resistors to the circuit: one in series between the reference voltage and the inverting pin, and another from the inverting pin to one of the differential output pins.

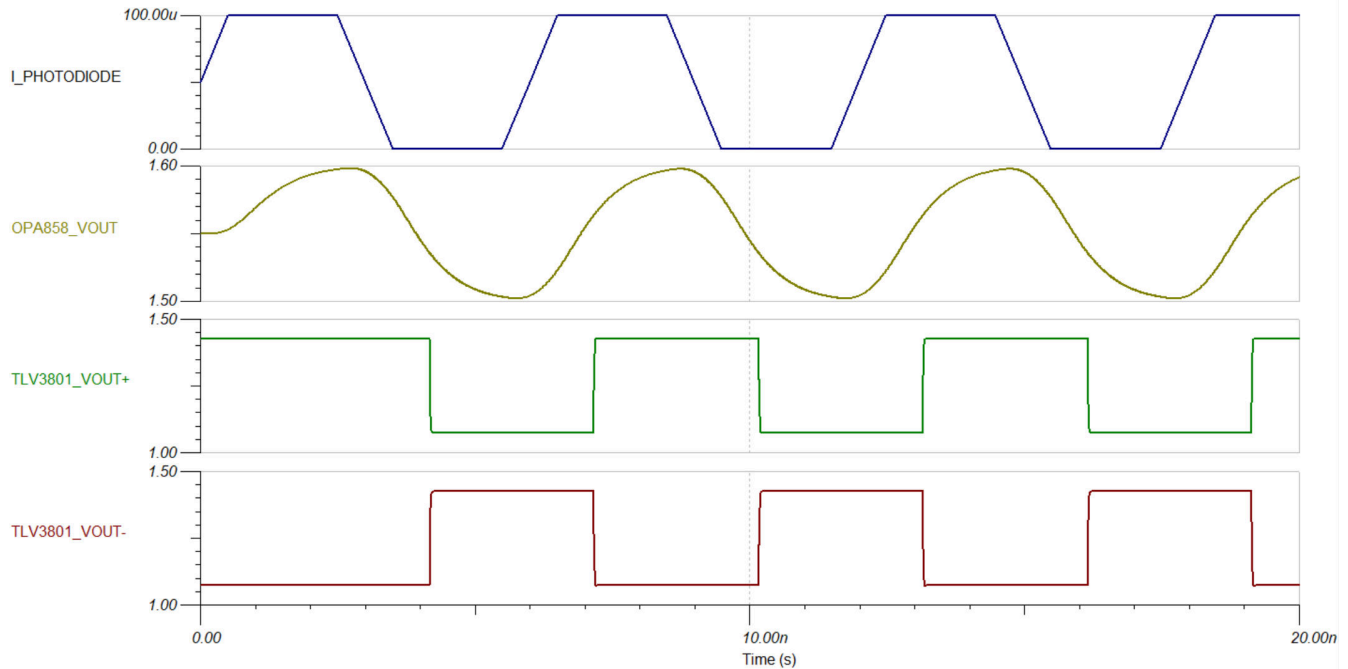

図 8-3. Non-Inverting Comparator with Hysteresis Circuit

8.2.2.1 Design Requirements

表 8-2. Design Parameters

PARAMETER	VALUE
V_{HYS}	50 mV
V_{REF}	2.5 V

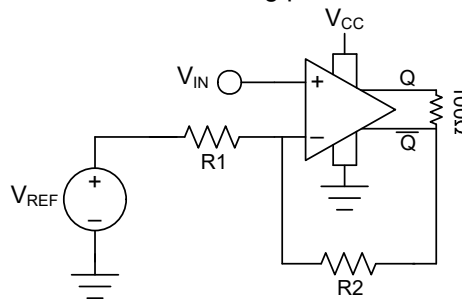
表 8-2. Design Parameters (続き)

PARAMETER	VALUE
V_{T1}	2.34 V
V_{T2}	2.29 V
Q	1.375 V
\bar{Q}	1.025 V

8.2.2.2 Detailed Design Procedure

First, create an equation for V_T that covers both output voltages when the output is high or low.

$$V_{T1} = \frac{V_{REF}R_2 + QR_1}{R_1 + R_2} \quad (5)$$

$$V_{T2} = \frac{V_{REF}R_2 + \bar{Q}R_1}{R_1 + R_2} \quad (6)$$

The hysteresis voltage in this network is equal to the difference in the two threshold voltage equations.

$$V_{HYS} = V_{T1} - V_{T2} \quad (7)$$

$$V_{HYS} = \frac{V_{REF}R_2 + QR_1}{R_1 + R_2} - \frac{V_{REF}R_2 + \bar{Q}R_1}{R_1 + R_2} \quad (8)$$

$$V_{HYS} = \frac{(Q - \bar{Q})R_1}{R_1 + R_2} \quad (9)$$

$$V_{HYS} = \frac{V_{OD}R_1}{R_1 + R_2} \quad (10)$$

Note that these equations do not take into account the effects of the internal hysteresis and offset voltage of the comparator. Design parameters will need to be adjusted accordingly.

Select a value for R_2 . Plug in given values for V_{REF} , V_{T1} , V_{T2} , Q , and \bar{Q} , and solve for R_1 . For the given example, $R_2 = 50 \text{ k}\Omega$, and R_1 is solved as $= 8.3 \text{ k}\Omega$.

8.2.2.3 Application Performance Plots



図 8-4. Hysteresis Curve for LVDS Comparator

8.2.3 Logic Clock Source to LVDS Transceiver

The 図 8-5 shows a logic clock source being terminated and driven with the TLV3802/TLV3811(C) across a CAT6 Cable to receive an equivalent LVDS clock signal at the receiver end.

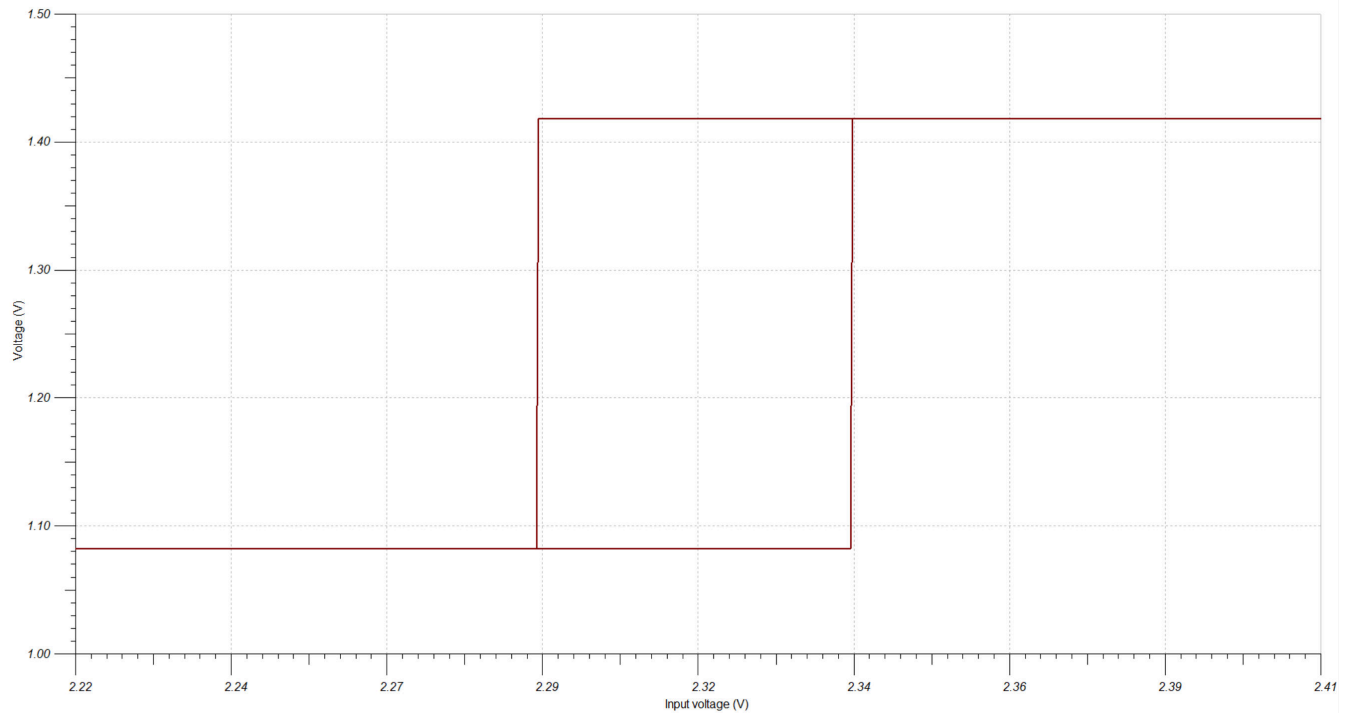

図 8-5. LVDS Clock Transceiver

8.2.4 External Trigger Function for Oscilloscopes

図 8-6 is a typical configuration for creating an external trigger on oscilloscopes. The user adjusts the trigger level, and a DAC converts this trigger level to a voltage the TLV380x/TLV3811(C) can use as a reference. The input voltage from an oscilloscope channel is then compared to the trigger reference voltage, and the TLV380x/TLV3811(C) sends an LVDS signal to a downstream FPGA to begin a capture. It is common to see bipolar inputs in test and measurement systems such as oscilloscopes; therefore, the TLV380x can be configured in split supply so that the inputs are in the allowable input voltage range.

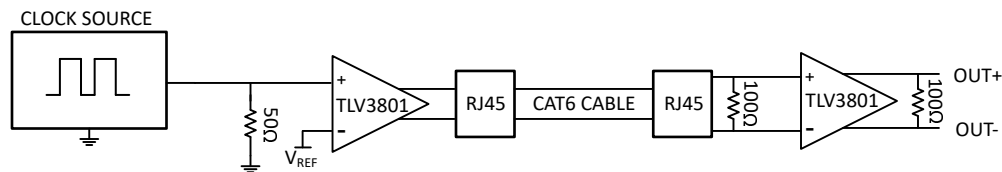
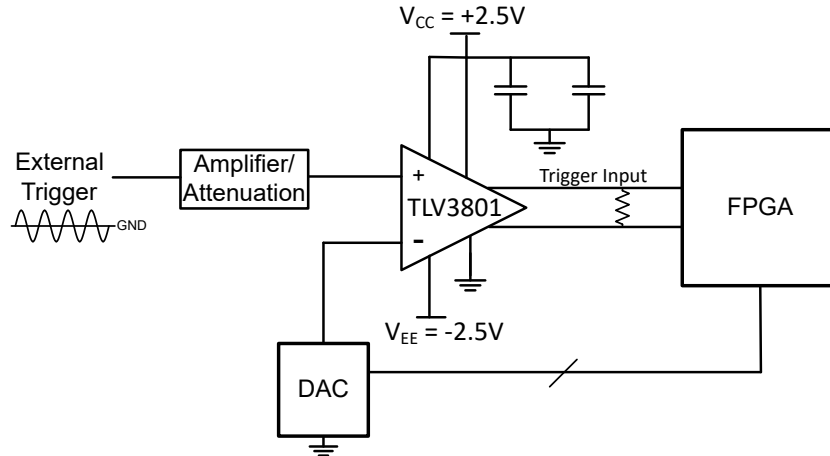

8-6. External Trigger Function

8.3 Power Supply Recommendations

The TLV380x has two separate power rails: VCC - VEE for the input stage and VCC - GND for the output stage. This allows for both single and split supply capabilities for the input stage with a separate ground reference for the LVDS output stage. Split supply operation allows users to apply both positive and negative (bipolar) voltages to the input pins.

When operating from a single supply, the supply voltage range for both the input and output stage is 2.7 V to 5.25 V. When operating from split supply rails, the supply voltage range for the input stage (VCC - VEE) is 2.7 V to 5.25 V, and the supply voltage range for the output stage (VCC - GND) is 2.4 V to 5.25 V. The output logic level is independent of the VCC and VEE levels. The TLV3811(C) is specified for operation from 2.4 V to 5.25 V and can only be operated from a single supply with both inputs and outputs referenced to GND.

Regardless of single supply or split supply operation, proper decoupling capacitors are required. It is recommended to use a scheme of multiple, low-ESR ceramic capacitors from the supply pins to the ground plane for optimum performance. A good combination would be 100 pF, 10 nF, and 1 uF with the lowest value capacitor closest to the comparator.

8.4 Layout

8.4.1 Layout Guidelines

Comparators are very sensitive to input noise. For best results, adhere to the following layout guidelines.

1. Use a printed-circuit-board (PCB) with a good, unbroken, low-inductance ground plane. Proper grounding (use of a ground plane) helps maintain specified device performance.
2. To minimize supply noise for single and split supply, place decoupling capacitor arrays as close as possible to V_{CC} .
3. On the inputs and the output, keep lead lengths as short as possible to avoid unwanted parasitic feedback around the comparator. Keep inputs away from the output.
4. Solder the device directly to the PCB rather than using a socket.
5. For slow-moving input signals, take care to prevent parasitic feedback. A small capacitor (1000 pF or less) placed between the inputs can help eliminate oscillations in the transition region. This capacitor causes some degradation to propagation delay when impedance is low. The topside ground plane runs between the output and inputs.
6. Use a 100 Ω termination resistor across the device's LVDS output.
7. Use higher performance substrate materials such as Rogers.

8.4.2 Layout Example



图 8-7. TLV3801EVM Layout Example

9 Device and Documentation Support

9.1 Device Support

9.1.1 Development Support

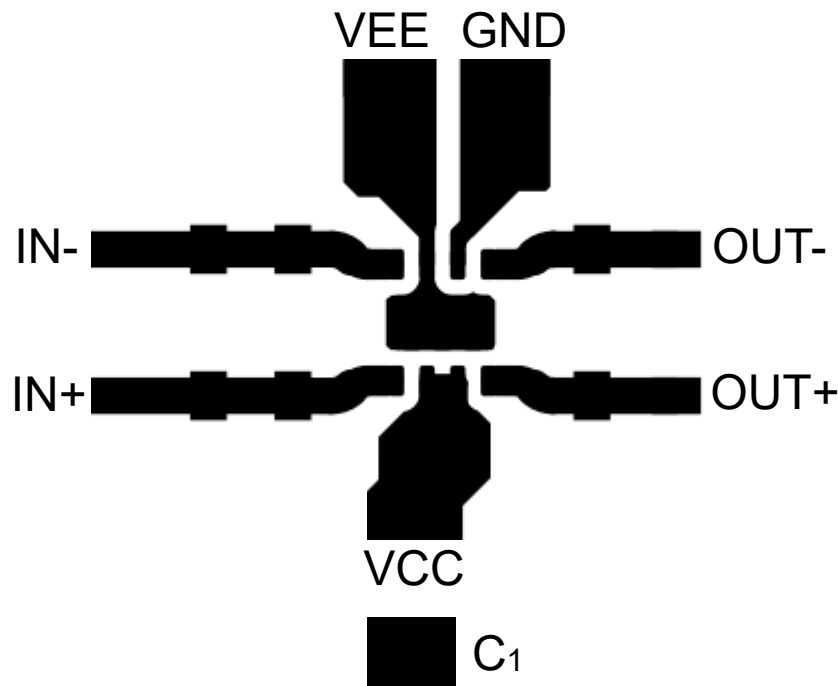
[LIDAR Pulsed Time of Flight Reference Design](#)

9.2 ドキュメントの更新通知を受け取る方法

ドキュメントの更新についての通知を受け取るには、www.tij.co.jp のデバイス製品フォルダを開いてください。[通知] をクリックして登録すると、変更されたすべての製品情報に関するダイジェストを毎週受け取ることができます。変更の詳細については、改訂されたドキュメントに含まれている改訂履歴をご覧ください。

9.3 サポート・リソース

テキサス・インスツルメンツ E2E™ サポート・フォーラムは、エンジニアが検証済みの回答と設計に関するヒントをエキスパートから迅速かつ直接得ることができる場所です。既存の回答を検索したり、独自の質問をしたりすることで、設計に必要な支援を迅速に得ることができます。

リンクされているコンテンツは、各寄稿者により「現状のまま」提供されるものです。これらはテキサス・インスツルメンツの仕様を構成するものではなく、必ずしもテキサス・インスツルメンツの見解を反映したものではありません。テキサス・インスツルメンツの[使用条件](#)を参照してください。

9.4 Trademarks

テキサス・インスツルメンツ E2E™ is a trademark of Texas Instruments.

すべての商標は、それぞれの所有者に帰属します。

9.5 静電気放電に関する注意事項



この IC は、ESD によって破損する可能性があります。テキサス・インスツルメンツは、IC を取り扱う際には常に適切な注意を払うことを推奨します。正しい取り扱いおよび設置手順に従わない場合、デバイスを破損するおそれがあります。

ESD による破損は、わずかな性能低下からデバイスの完全な故障まで多岐にわたります。精密な IC の場合、パラメータがわずかに変化するだけで公表されている仕様から外れる可能性があるため、破損が発生しやすくなっています。

9.6 用語集

[テキサス・インスツルメンツ用語集](#) この用語集には、用語や略語の一覧および定義が記載されています。

10 Mechanical, Packaging, and Orderable Information

The following pages include mechanical, packaging, and orderable information. This information is the most current data available for the designated devices. This data is subject to change without notice and revision of this document. For browser-based versions of this data sheet, refer to the left-hand navigation.

PACKAGING INFORMATION

Orderable part number	Status (1)	Material type (2)	Package Pins	Package qty Carrier	RoHS (3)	Lead finish/ Ball material (4)	MSL rating/ Peak reflow (5)	Op temp (°C)	Part marking (6)
TLV3801DSGR	Active	Production	WSON (DSG) 8	3000 LARGE T&R	Yes	SN	Level-2-260C-1 YEAR	-40 to 125	3801
TLV3801DSGR.B	Active	Production	WSON (DSG) 8	3000 LARGE T&R	Yes	SN	Level-2-260C-1 YEAR	-40 to 125	3801
TLV3801DSGT	Active	Production	WSON (DSG) 8	250 SMALL T&R	Yes	SN	Level-2-260C-1 YEAR	-40 to 125	3801
TLV3801DSGT.B	Active	Production	WSON (DSG) 8	250 SMALL T&R	Yes	SN	Level-2-260C-1 YEAR	-40 to 125	3801
TLV3802DSSR	Active	Production	WSON (DSS) 12	3000 LARGE T&R	Yes	SN	Level-2-260C-1 YEAR	-40 to 125	3802
TLV3802DSSR.B	Active	Production	WSON (DSS) 12	3000 LARGE T&R	Yes	SN	Level-2-260C-1 YEAR	-40 to 125	3802
TLV3811CYBGR	Active	Production	DSBGA (YBG) 6	3000 LARGE T&R	Yes	SNAGCU	Level-1-260C-UNLIM	-40 to 125	02
TLV3811CYBGR.A	Active	Production	DSBGA (YBG) 6	3000 LARGE T&R	Yes	SNAGCU	Level-1-260C-UNLIM	-40 to 125	02
TLV3811CYBGT	Active	Production	DSBGA (YBG) 6	250 LARGE T&R	Yes	SNAGCU	Level-1-260C-UNLIM	-40 to 125	02
TLV3811CYBGT.A	Active	Production	DSBGA (YBG) 6	250 LARGE T&R	Yes	SNAGCU	Level-1-260C-UNLIM	-40 to 125	02
TLV3811YBGR	Active	Production	DSBGA (YBG) 6	3000 LARGE T&R	Yes	SNAGCU	Level-1-260C-UNLIM	-40 to 125	LQ
TLV3811YBGR.A	Active	Production	DSBGA (YBG) 6	3000 LARGE T&R	Yes	SNAGCU	Level-1-260C-UNLIM	-40 to 125	LQ
TLV3811YBGT	Active	Production	DSBGA (YBG) 6	250 SMALL T&R	Yes	SNAGCU	Level-1-260C-UNLIM	-40 to 125	LQ
TLV3811YBGT.A	Active	Production	DSBGA (YBG) 6	250 SMALL T&R	Yes	SNAGCU	Level-1-260C-UNLIM	-40 to 125	LQ

(1) **Status:** For more details on status, see our [product life cycle](#).

(2) **Material type:** When designated, preproduction parts are prototypes/experimental devices, and are not yet approved or released for full production. Testing and final process, including without limitation quality assurance, reliability performance testing, and/or process qualification, may not yet be complete, and this item is subject to further changes or possible discontinuation. If available for ordering, purchases will be subject to an additional waiver at checkout, and are intended for early internal evaluation purposes only. These items are sold without warranties of any kind.

(3) **RoHS values:** Yes, No, RoHS Exempt. See the [TI RoHS Statement](#) for additional information and value definition.

(4) **Lead finish/Ball material:** Parts may have multiple material finish options. Finish options are separated by a vertical ruled line. Lead finish/Ball material values may wrap to two lines if the finish value exceeds the maximum column width.

(5) **MSL rating/Peak reflow:** The moisture sensitivity level ratings and peak solder (reflow) temperatures. In the event that a part has multiple moisture sensitivity ratings, only the lowest level per JEDEC standards is shown. Refer to the shipping label for the actual reflow temperature that will be used to mount the part to the printed circuit board.

(6) **Part marking:** There may be an additional marking, which relates to the logo, the lot trace code information, or the environmental category of the part.

Multiple part markings will be inside parentheses. Only one part marking contained in parentheses and separated by a "~" will appear on a part. If a line is indented then it is a continuation of the previous line and the two combined represent the entire part marking for that device.

Important Information and Disclaimer: The information provided on this page represents TI's knowledge and belief as of the date that it is provided. TI bases its knowledge and belief on information provided by third parties, and makes no representation or warranty as to the accuracy of such information. Efforts are underway to better integrate information from third parties. TI has taken and continues to take reasonable steps to provide representative and accurate information but may not have conducted destructive testing or chemical analysis on incoming materials and chemicals. TI and TI suppliers consider certain information to be proprietary, and thus CAS numbers and other limited information may not be available for release.

In no event shall TI's liability arising out of such information exceed the total purchase price of the TI part(s) at issue in this document sold by TI to Customer on an annual basis.

OTHER QUALIFIED VERSIONS OF TLV3801, TLV3802 :

- Automotive : [TLV3801-Q1](#), [TLV3802-Q1](#)

NOTE: Qualified Version Definitions:

- Automotive - Q100 devices qualified for high-reliability automotive applications targeting zero defects

TAPE AND REEL INFORMATION

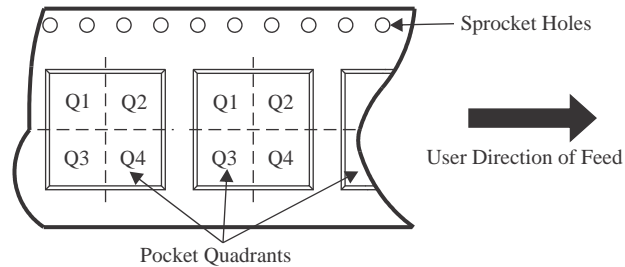
QUADRANT ASSIGNMENTS FOR PIN 1 ORIENTATION IN TAPE

*All dimensions are nominal

Device	Package Type	Package Drawing	Pins	SPQ	Reel Diameter (mm)	Reel Width W1 (mm)	A0 (mm)	B0 (mm)	K0 (mm)	P1 (mm)	W (mm)	Pin1 Quadrant
TLV3801DSGR	WSO	DSG	8	3000	180.0	8.4	2.2	2.2	1.2	4.0	8.0	Q2
TLV3801DSGT	WSO	DSG	8	250	179.0	8.4	2.2	2.2	1.2	4.0	8.0	Q2
TLV3802DSSR	WSO	DSS	12	3000	180.0	8.4	2.3	3.2	1.0	4.0	8.0	Q1
TLV3811CYBGR	DSBGA	YBG	6	3000	180.0	8.4	0.87	1.27	0.6	2.0	8.0	Q2
TLV3811CYBGT	DSBGA	YBG	6	250	180.0	8.4	0.87	1.27	0.6	2.0	8.0	Q2
TLV3811YBGT	DSBGA	YBG	6	250	180.0	8.4	0.87	1.27	0.6	2.0	8.0	Q2

TAPE AND REEL BOX DIMENSIONS

*All dimensions are nominal

Device	Package Type	Package Drawing	Pins	SPQ	Length (mm)	Width (mm)	Height (mm)
TLV3801DSGR	WSON	DSG	8	3000	213.0	191.0	35.0
TLV3801DSGT	WSON	DSG	8	250	213.0	191.0	35.0
TLV3802DSSR	WSON	DSS	12	3000	213.0	191.0	35.0
TLV3811CYBGR	DSBGA	YBG	6	3000	182.0	182.0	20.0
TLV3811CYBGT	DSBGA	YBG	6	250	182.0	182.0	20.0
TLV3811YBGT	DSBGA	YBG	6	250	182.0	182.0	20.0

EXAMPLE BOARD LAYOUT

YBG0006

DSBGA - 0.5 mm max height

DIE SIZE BALL GRID ARRAY

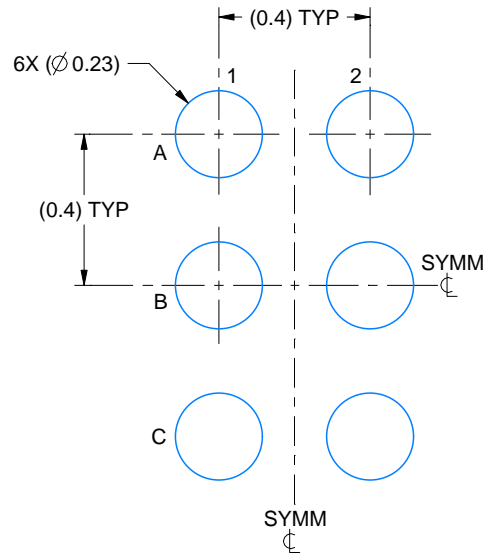

LAND PATTERN EXAMPLE
EXPOSED METAL SHOWN
SCALE: 50X

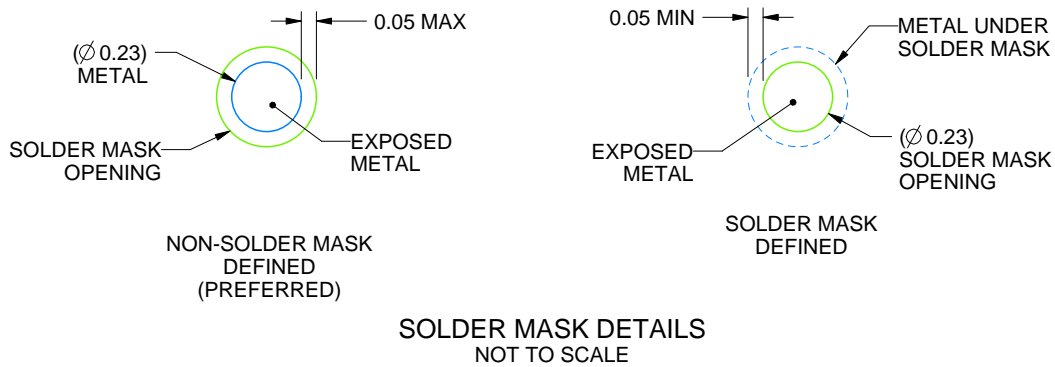

SOLDER MASK DETAILS
NOT TO SCALE

4224328/A 05/2018

NOTES: (continued)

- Final dimensions may vary due to manufacturing tolerance considerations and also routing constraints. See Texas Instruments Literature No. SNVA009 (www.ti.com/lit/snva009).

EXAMPLE STENCIL DESIGN

YBG0006

DSBGA - 0.5 mm max height

DIE SIZE BALL GRID ARRAY

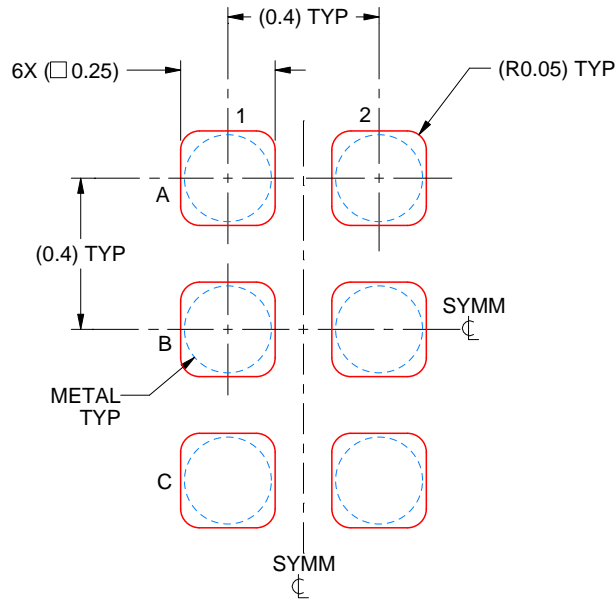

SOLDER PASTE EXAMPLE
BASED ON 0.1 mm THICK STENCIL
SCALE: 50X

4224328/A 05/2018

NOTES: (continued)

4. Laser cutting apertures with trapezoidal walls and rounded corners may offer better paste release.

GENERIC PACKAGE VIEW

DSG 8

WSON - 0.8 mm max height

2 x 2, 0.5 mm pitch

PLASTIC SMALL OUTLINE - NO LEAD

This image is a representation of the package family, actual package may vary.
Refer to the product data sheet for package details.

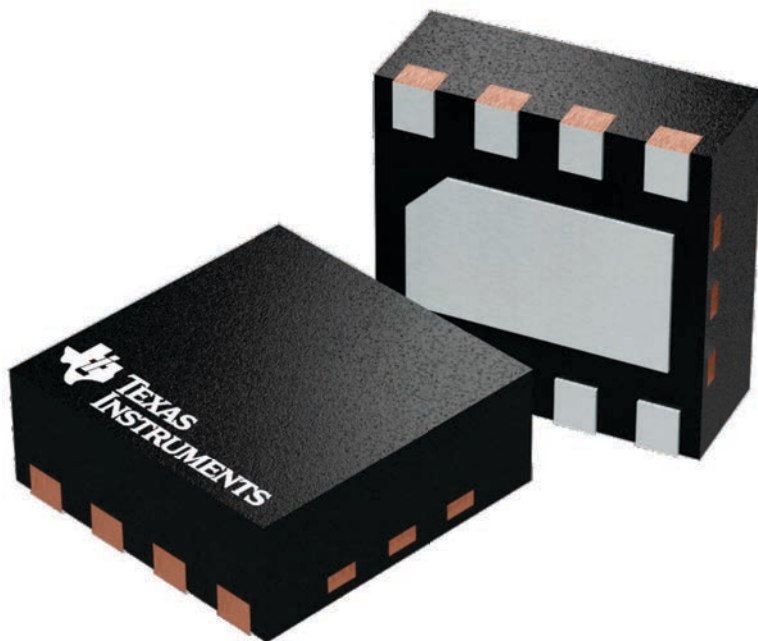

4224783/A

DSG0008B

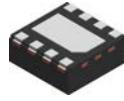

PACKAGE OUTLINE

WSON - 0.8 mm max height

PLASTIC SMALL OUTLINE - NO LEAD

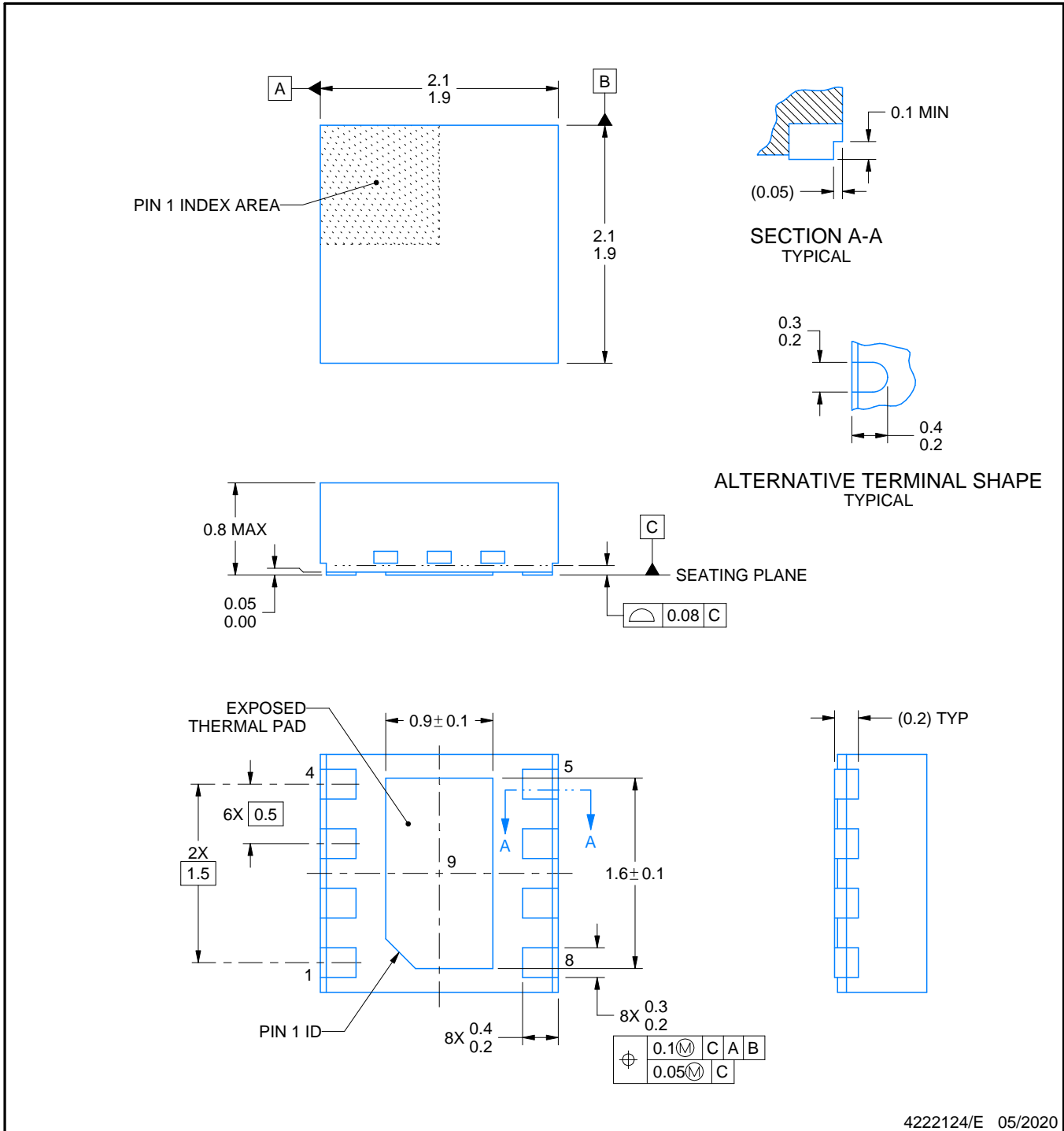

NOTES:

1. All linear dimensions are in millimeters. Any dimensions in parenthesis are for reference only. Dimensioning and tolerancing per ASME Y14.5M.
2. This drawing is subject to change without notice.
3. The package thermal pad must be soldered to the printed circuit board for thermal and mechanical performance.

EXAMPLE STENCIL DESIGN

DSG0008B

WSON - 0.8 mm max height

PLASTIC SMALL OUTLINE - NO LEAD

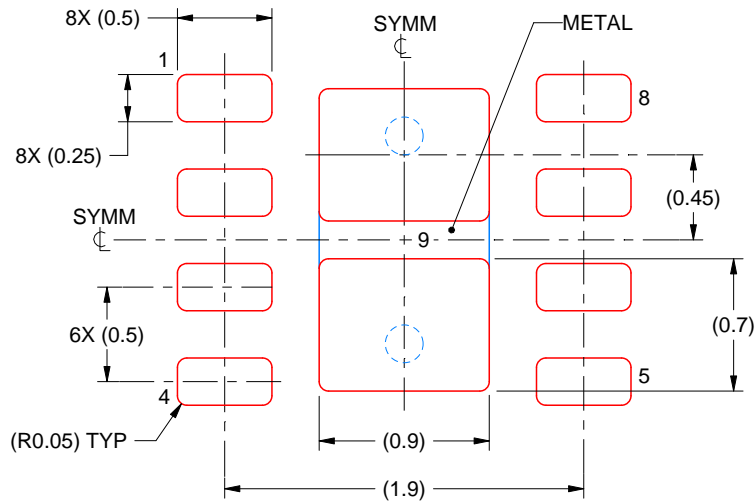

SOLDER PASTE EXAMPLE
BASED ON 0.125 mm THICK STENCIL

EXPOSED PAD 9:
87% PRINTED SOLDER COVERAGE BY AREA UNDER PACKAGE
SCALE:25X

4222124/E 05/2020

NOTES: (continued)

6. Laser cutting apertures with trapezoidal walls and rounded corners may offer better paste release. IPC-7525 may have alternate design recommendations.

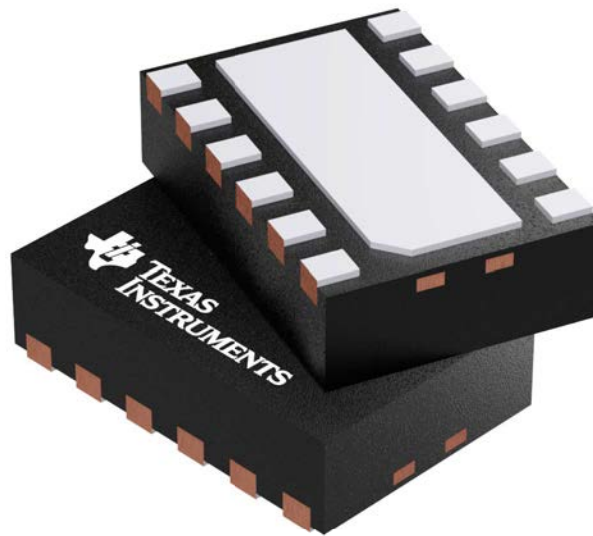

Images above are just a representation of the package family, actual package may vary.
Refer to the product data sheet for package details.

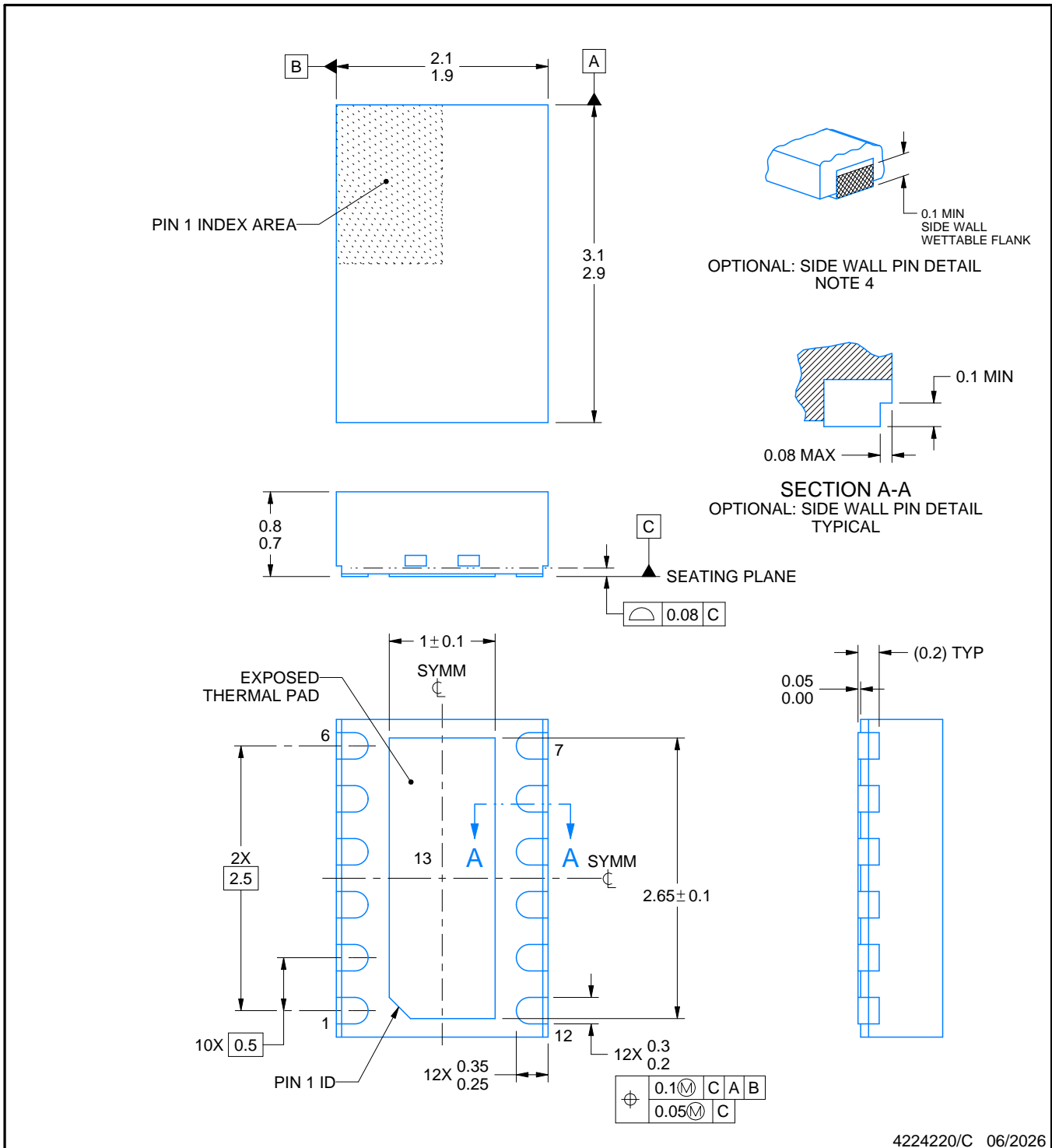

NOTES:

1. All linear dimensions are in millimeters. Any dimensions in parenthesis are for reference only. Dimensioning and tolerancing per ASME Y14.5M.
2. This drawing is subject to change without notice.
3. The package thermal pad must be soldered to the printed circuit board for optimal thermal and mechanical performance.
4. Minimum 0.1 mm solder wetting on pin side wall. Available for wettable flank version only.

EXAMPLE BOARD LAYOUT

DSS0012C

WSON - 0.8 mm max height

PLASTIC SMALL OUTLINE - NO LEAD

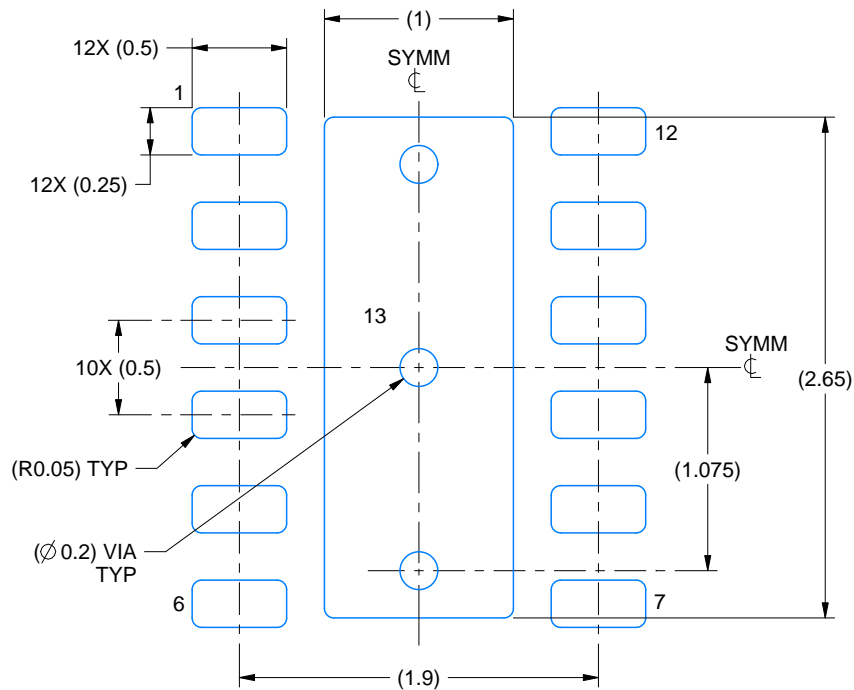

LAND PATTERN EXAMPLE
EXPOSED METAL SHOWN
SCALE:25X

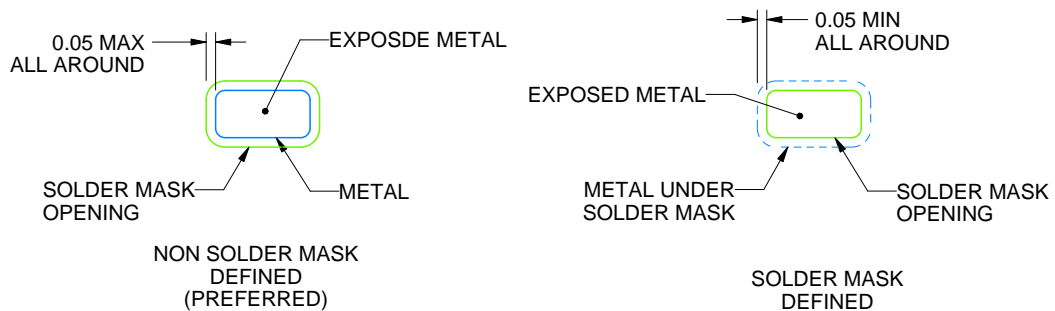

SOLDER MASK DETAILS

4224220/C 06/2026

NOTES: (continued)

- This package is designed to be soldered to a thermal pad on the board. For more information, see Texas Instruments literature number SLUA271 (www.ti.com/lit/slua271).
- Vias are optional depending on application, refer to device data sheet. If any vias are implemented, refer to their locations shown on this view. It is recommended that vias under paste be filled, plugged or tented.

EXAMPLE STENCIL DESIGN

DSS0012C

WSON - 0.8 mm max height

PLASTIC SMALL OUTLINE - NO LEAD

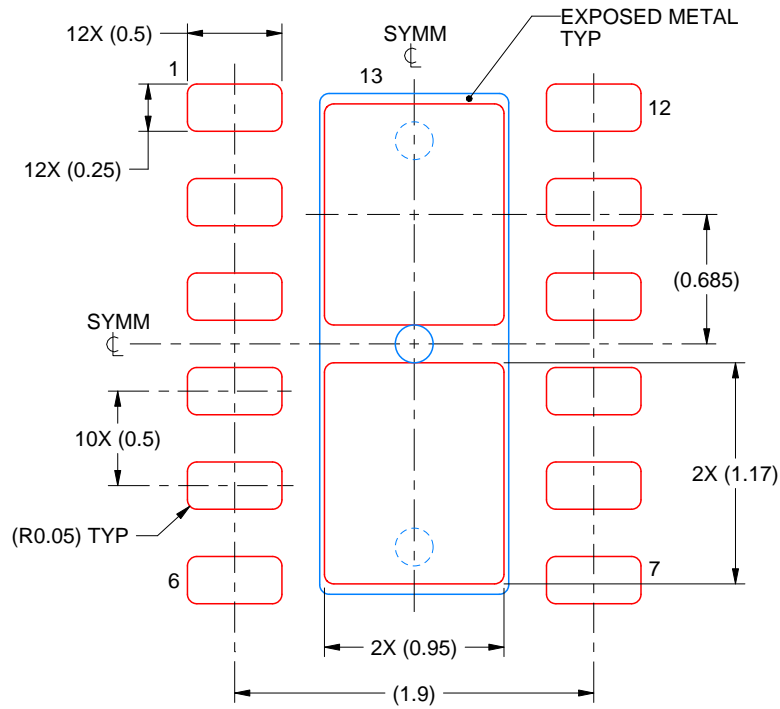

SOLDER PASTE EXAMPLE
BASED ON 0.125 mm THICK STENCIL

EXPOSED PAD 13:
83% PRINTED SOLDER COVERAGE BY AREA UNDER PACKAGE
SCALE:25X

4224220/C 06/2026

NOTES: (continued)

7. Laser cutting apertures with trapezoidal walls and rounded corners may offer better paste release. IPC-7525 may have alternate design recommendations.

重要なお知らせと免責事項

TI は、技術データと信頼性データ (データシートを含みます)、設計リソース (リファレンス デザインを含みます)、アプリケーションや設計に関する各種アドバイス、Web ツール、安全性情報、その他のリソースを、欠陥が存在する可能性のある「現状のまま」提供しており、商品性および特定目的に対する適合性の黙示保証、第三者の知的財産権の非侵害保証を含むいかなる保証も、明示的または黙示的にかかわらず拒否します。

これらのリソースは、TI 製品を使用する設計の経験を積んだ開発者への提供を意図したものです。(1) お客様のアプリケーションに適した TI 製品の選定、(2) お客様のアプリケーションの設計、検証、試験、(3) お客様のアプリケーションに該当する各種規格や、その他のあらゆる安全性、セキュリティ、規制、または他の要件への確実な適合に関する責任を、お客様のみが単独で負うものとし、

上記の各種リソースは、予告なく変更される可能性があります。これらのリソースは、リソースで説明されている TI 製品を使用するアプリケーションの開発の目的でのみ、TI はその使用をお客様に許諾します。これらのリソースに関して、他の目的で複製することや掲載することは禁止されています。TI や第三者の知的財産権のライセンスが付与されている訳ではありません。お客様は、これらのリソースを自身で使用した結果発生するあらゆる申し立て、損害、費用、損失、責任について、TI およびその代理人を完全に補償するものとし、TI は一切の責任を拒否します。

TI の製品は、[TI の販売条件](#)、[TI の総合的な品質ガイドライン](#)、[ti.com](#) または TI 製品などに関連して提供される他の適用条件に従い提供されます。TI がこれらのリソースを提供することは、適用される TI の保証または他の保証の放棄の拡大や変更を意味するものではありません。TI がカスタム、またはカスタマー仕様として明示的に指定していない限り、TI の製品は標準的なカタログに掲載される汎用機器です。

お客様がいかなる追加条項または代替条項を提案する場合も、TI はそれらに異議を唱え、拒否します。

Copyright © 2026, Texas Instruments Incorporated

最終更新日 : 2025 年 10 月