

# TLV930x コスト重視システム向け 40V、1MHz、RRO オペアンプ

## 1 特長

- 低いオフセット電圧:  $\pm 0.5\text{mV}$
- 低い入力オフセット電圧ドリフト:  $\pm 2\mu\text{V}/^\circ\text{C}$
- 低ノイズ: 1kHz 時に  $33\text{nV}/\sqrt{\text{Hz}}$
- 大きい同相除去比: 110dB
- 小さいバイアス電流:  $\pm 10\text{pA}$
- レール・ツー・レール出力
- 広帯域幅: 1MHz GBW
- 高スルーレート:  $3\text{V}/\mu\text{s}$
- 低い静止電流:  $150\mu\text{A}$  (アンプ 1 個あたり)
- 広い電源範囲:  $\pm 2.25\text{V} \sim \pm 20\text{V}$ ,  $4.5\text{V} \sim 40\text{V}$
- 堅牢な EMI 性能: 1GHz 時に 72dB
- 多重化対応 / コンパレータ入力
  - 差動および同相入力電圧範囲は電源レールまで
- 業界標準パッケージ
  - シングル: SOT-23-5, SC70
  - デュアル: SOIC-8, TSSOP-8, VSSOP-8
  - クワッド: SOIC-14, TSSOP-14

## 2 アプリケーション

- 商用ネットワークとサーバーの PSU (電源)
- 産業用 AC-DC
- 商用 DC/DC
- モータ・ドライブ: AC およびサーボ・ドライブの電源
- ビル・オートメーション

## 3 概要

TLV930x ファミリー (TLV9301、TLV9302、TLV9304) は 40V の、コスト最適化されたオペアンプのファミリーです。これらのデバイスは、レール・ツー・レール出力、低いオフセット (標準値  $\pm 0.5\text{mV}$ )、低いオフセット・ドリフト係数 (標準値  $\pm 2\mu\text{V}/^\circ\text{C}$ )、1MHz の帯域幅などの優れた汎用 DC および AC 仕様を備えています。

広い差動入力電圧範囲、大きな出力電流 ( $\pm 60\text{mA}$ )、高いスルーレート ( $3\text{V}/\mu\text{s}$ ) などの便利な特長から、TLV930x は高電圧でコストの制約が厳しいアプリケーションに適した堅牢なオペアンプです。

TLV930x ファミリーのオペアンプは標準パッケージで供給され、 $-40^\circ\text{C} \sim 125^\circ\text{C}$  で動作が規定されています。

### 製品情報

| 部品番号 <sup>(1)</sup> | パッケージ      | 本体サイズ (公称)      |
|---------------------|------------|-----------------|
| TLV9301             | SOT-23 (5) | 2.90mm × 1.60mm |
|                     | SC70 (5)   | 2.00mm × 1.25mm |
| TLV9302             | SOIC (8)   | 4.90mm × 3.91mm |
|                     | SOT-23-8   | 2.90mm × 1.60mm |
|                     | TSSOP (8)  | 4.40mm × 3.00mm |
|                     | VSSOP (8)  | 2.30mm × 2.00mm |
| TLV9304             | SOIC (14)  | 8.65mm × 3.91mm |
|                     | TSSOP (14) | 5.00mm × 4.40mm |

(1) 利用可能なすべてのパッケージについては、このデータシートの末尾にある注文情報を参照してください。

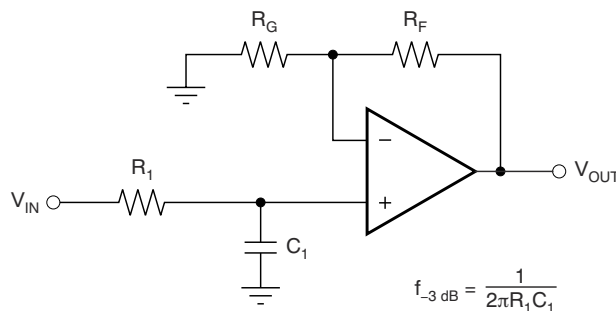

$$f_{-3\text{dB}} = \frac{1}{2\pi R_1 C_1}$$

$$\frac{V_{\text{OUT}}}{V_{\text{IN}}} = \left(1 + \frac{R_F}{R_G}\right) \left(\frac{1}{1 + sR_1 C_1}\right)$$

### 単極、ローパス・フィルタの TLV930x



## Table of Contents

|   |           |   |           |
|---|-----------|---|-----------|
| 1 特長.....                                       | 1         | 7.4 Device Functional Modes.....                                | 24        |
| 2 アプリケーション.....                                 | 1         | <b>8 Application and Implementation.....</b>                    | <b>25</b> |
| 3 概要.....                                       | 1         | 8.1 Application Information.....                                | 25        |
| 4 Revision History.....                         | 2         | 8.2 Typical Applications.....                                   | 25        |
| 5 Pin Configuration and Functions.....          | 3         | <b>9 Power Supply Recommendations.....</b>                      | <b>27</b> |
| 6 Specifications.....                           | 5         | <b>10 Layout.....</b>   | <b>27</b> |
| 6.1 Absolute Maximum Ratings.....               | 5         | 10.1 Layout Guidelines.....                                     | 27        |
| 6.2 ESD Ratings.....                            | 5         | 10.2 Layout Example.....  | 27        |
| 6.3 Recommended Operating Conditions.....       | 5         | <b>11 Device and Documentation Support.....</b>                 | <b>30</b> |
| 6.4 Thermal Information for Single Channel..... | 5         | 11.1 Device Support.....  | 30        |
| 6.5 Thermal Information for Dual Channel.....   | 6         | 11.2 Documentation Support.....                                 | 30        |
| 6.6 Thermal Information for Quad Channel.....   | 6         | 11.3 Receiving Notification of Documentation Updates.....       | 30        |
| 6.7 Electrical Characteristics.....             | 7         | 11.4 サポート・リソース.....   | 30        |
| 6.8 Typical Characteristics.....                | 9         | 11.5 Trademarks.....  | 30        |
| <b>7 Detailed Description.....</b>              | <b>16</b> | 11.6 Electrostatic Discharge Caution.....                       | 31        |
| 7.1 Overview.....                               | 16        | 11.7 Glossary.....  | 31        |
| 7.2 Functional Block Diagram.....               | 16        | <b>12 Mechanical, Packaging, and Orderable Information.....</b> | <b>32</b> |
| 7.3 Feature Description.....                    | 17        |   |           |

## 4 Revision History

資料番号末尾の英字は改訂を表しています。その改訂履歴は英語版に準じています。

| Changes from Revision C (February 2021) to Revision D (August 2021)   | Page |
|---|------|
| • Removed preview note and added thermal data for VSSOP-8 (DGK) package in <i>Thermal Information for Dual Channel</i> .....        | 6    |
| Changes from Revision B (March 2020) to Revision C (February 2021)  | Page |
| • 文書全体にわたって表、図、相互参照の採番方法を更新.....  | 1    |
| • 「製品情報」表の TLV9302 の SOT-23 (8) パッケージからプレビューの注を削除.....  | 1    |
| • 「製品情報」表の TLV9302 の VSSOP (8) パッケージからプレビューの注を削除.....   | 1    |
| • Removed Table of Graphs table from the <i>Specifications</i> section.....   | 9    |
| • Removed <i>Related Links</i> section from the <i>Device and Documentation Support</i> section.....                                | 30   |
| Changes from Revision A (April 2019) to Revision B (March 2020)   | Page |
| • TLV9301 と TLV9304 のデバイス・ステータスを「事前情報」から「量産データ」に変更.....   | 1    |
| • 「製品情報」表の TLV9301 の SOT-23 (5) パッケージからプレビューの注を削除.....  | 1    |
| • 「製品情報」表の TLV9301 の SC70 (5) パッケージからプレビューの注を削除.....  | 1    |
| • 「製品情報」表の TLV9304 の SOIC (14) パッケージからプレビューの注を削除.....   | 1    |
| • 「製品情報」表の TLV9304 の TSSOP (14) パッケージからプレビューの注を削除.....  | 1    |
| • Removed preview notation from TLV9301 DBV package (SOT-23) in the <i>Pin Configuration and Functions</i> section.....             | 3    |
| • Removed preview notation from TLV9301 DCK package (SC70) in the <i>Pin Configuration and Functions</i> section.....               | 3    |
| • Removed preview notation from TLV9304 D (SOIC) and TSSOP (PW) packages in the <i>Pin Configuration and Functions</i> section..... | 3    |
| Changes from Revision * (February 2019) to Revision A (April 2019)  | Page |
| • TLV9302 のデバイス・ステータスを「事前情報」から「量産データ」に変更.....   | 1    |

## 5 Pin Configuration and Functions



图 5-1. TLV9301 DBV Package  
5-Pin SOT-23  
Top View



图 5-2. TLV9301 DCK Package  
5-Pin SC70  
Top View

表 5-1. Pin Functions: TLV9301

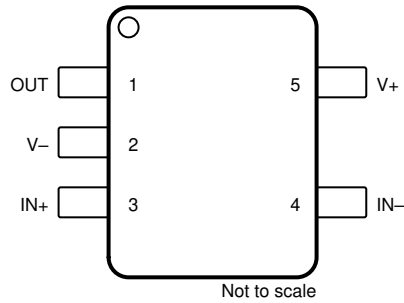
| NAME | PIN |     | I/O | DESCRIPTION                     |
|------|-----|-----|-----|---------------------------------|
|      | DBV | DCK |     |                                 |
| +IN  | 3   | 1   | I   | Noninverting input              |
| -IN  | 4   | 3   | I   | Inverting input                 |
| OUT  | 1   | 4   | O   | Output                          |
| V+   | 5   | 5   | —   | Positive (highest) power supply |
| V-   | 2   | 2   | —   | Negative (lowest) power supply  |

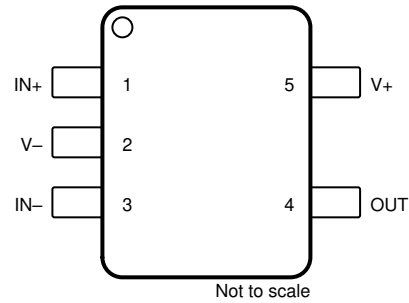

图 5-3. TLV9302 D, DDF, DGK, and PW Package  
8-Pin SOIC, TSOT, TSSOP, and VSSOP  
Top View

表 5-2. Pin Functions: TLV9302

| NAME  | PIN |  | I/O | DESCRIPTION                     |
|-------|-----|--|-----|---------------------------------|
|       | NO. |  |     |                                 |
| +IN A | 3   |  | I   | Noninverting input, channel A   |
| +IN B | 5   |  | I   | Noninverting input, channel B   |
| -IN A | 2   |  | I   | Inverting input, channel A      |
| -IN B | 6   |  | I   | Inverting input, channel B      |
| OUT A | 1   |  | O   | Output, channel A               |
| OUT B | 7   |  | O   | Output, channel B               |
| V+    | 8   |  | —   | Positive (highest) power supply |
| V-    | 4   |  | —   | Negative (lowest) power supply  |

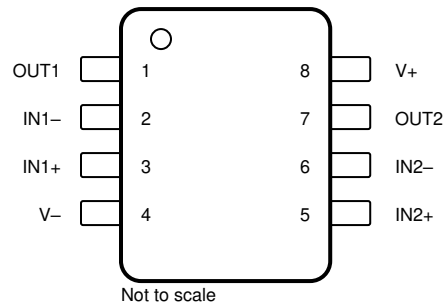
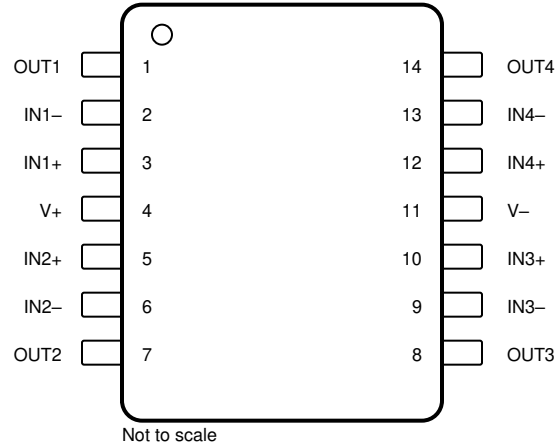

**图 5-4. TLV9304 D and PW Package  
14-Pin SOIC and TSSOP  
Top View**

**表 5-3. Pin Functions: TLV9304**

| PIN   |     | I/O | DESCRIPTION                     |
|-------|-----|-----|---------------------------------|
| NAME  | NO. |     |                                 |
| +IN A | 3   | I   | Noninverting input, channel A   |
| +IN B | 5   | I   | Noninverting input, channel B   |
| +IN C | 10  | I   | Noninverting input, channel C   |
| +IN D | 12  | I   | Noninverting input, channel D   |
| -IN A | 2   | I   | Inverting input, channel A      |
| -IN B | 6   | I   | Inverting input, channel B      |
| -IN C | 9   | I   | Inverting input, channel C      |
| -IN D | 13  | I   | Inverting input, channel D      |
| OUT A | 1   | O   | Output, channel A               |
| OUT B | 7   | O   | Output, channel B               |
| OUT C | 8   | O   | Output, channel C               |
| OUT D | 14  | O   | Output, channel D               |
| V+    | 4   | —   | Positive (highest) power supply |
| V-    | 11  | —   | Negative (lowest) power supply  |

## 6 Specifications

### 6.1 Absolute Maximum Ratings

over operating ambient temperature range (unless otherwise noted)<sup>(1)</sup>

|                                      |   | MIN          | MAX          | UNIT |
|--------------------------------------|---|--------------|--------------|------|
| Supply voltage, $V_S = (V+) - (V-)$  |   | 0            | 42           | V    |
| Signal input pins                    | Common-mode voltage <sup>(3)</sup>      | $(V-) - 0.5$ | $(V+) + 0.5$ | V    |
|                                      | Differential voltage <sup>(3) (4)</sup> |              | $V_S + 0.2$  | V    |
|                                      | Current <sup>(3)</sup>                  | -10          | 10           | mA   |
| Output short-circuit <sup>(2)</sup>  |   | Continuous   |              |      |
| Operating ambient temperature, $T_A$ |   | -55          | 150          | °C   |
| Junction temperature, $T_J$          |   |              | 150          | °C   |
| Storage temperature, $T_{stg}$       |   | -65          | 150          | °C   |

- (1) Stresses beyond those listed under *Absolute Maximum Ratings* may cause permanent damage to the device. These are stress ratings only, which do not imply functional operation of the device at these or any other conditions beyond those indicated under *Recommended Operating Conditions*. Exposure to absolute-maximum-rated conditions for extended periods may affect device reliability.
- (2) Short-circuit to ground, one amplifier per package.
- (3) Input pins are diode-clamped to the power-supply rails. Input signals that may swing more than 0.5 V beyond the supply rails must be current limited to 10 mA or less.
- (4) Large differential voltages applied between IN+ and IN- for extended periods of time may cause a long-term shift to the input offset voltage. This effect increases as temperature rises above 25°C.

### 6.2 ESD Ratings

|             |                         |  | VALUE | UNIT |
|-------------|-------------------------|--|-------|------|
| $V_{(ESD)}$ | Electrostatic discharge | Human-body model (HBM), per ANSI/ESDA/JEDEC JS-001 <sup>(1)</sup>              | ±2000 | V    |
|             |                         | Charged-device model (CDM), per JEDEC specification JESD22-C101 <sup>(2)</sup> | ±1000 |      |

- (1) JEDEC document JEP155 states that 500-V HBM allows safe manufacturing with a standard ESD control process.
- (2) JEDEC document JEP157 states that 250-V CDM allows safe manufacturing with a standard ESD control process.

### 6.3 Recommended Operating Conditions

over operating ambient temperature range (unless otherwise noted)

|       |                               | MIN          | MAX        | UNIT |
|-------|-------------------------------|--------------|------------|------|
| $V_S$ | Supply voltage, $(V+) - (V-)$ | 4.5          | 40         | V    |
| $V_I$ | Input voltage range           | $(V-) - 0.1$ | $(V+) - 2$ | V    |
| $T_A$ | Specified temperature         | -40          | 125        | °C   |

### 6.4 Thermal Information for Single Channel

| THERMAL METRIC <sup>(1)</sup> |  | TLV9301      |            | UNIT |
|-------------------------------|--|--------------|------------|------|
|                               |  | DBV (SOT-23) | DCK (SC70) |      |
|                               |  | 5 PINS       | 5 PINS     |      |
| $R_{\theta JA}$               | Junction-to-ambient thermal resistance       | 192.5        | 203.9      | °C/W |
| $R_{\theta JC(top)}$          | Junction-to-case (top) thermal resistance    | 113.3        | 116.2      | °C/W |
| $R_{\theta JB}$               | Junction-to-board thermal resistance         | 60.2         | 51.7       | °C/W |
| $\psi_{JT}$                   | Junction-to-top characterization parameter   | 37.6         | 24.6       | °C/W |
| $\psi_{JB}$                   | Junction-to-board characterization parameter | 60.1         | 51.9       | °C/W |
| $R_{\theta JC(bot)}$          | Junction-to-case (bottom) thermal resistance | N/A          | N/A        | °C/W |

- (1) For more information about traditional and new thermal metrics, see the *Semiconductor and IC Package Thermal Metrics* application report, [SPRA953](#).

## 6.5 Thermal Information for Dual Channel

| THERMAL METRIC <sup>(1)</sup> |  | TLV9302  |                |             |            | UNIT |
|-------------------------------|--|----------|----------------|-------------|------------|------|
|                               |  | D (SOIC) | DDF (SOT-23-8) | DGK (VSSOP) | PW (TSSOP) |      |
|                               |  | 8 PINS   | 8 PINS         | 8 PINS      | 8 PINS     |      |
| R <sub>θJA</sub>              | Junction-to-ambient thermal resistance       | 138.7    | 150.4          | 189.3       | 188.4      | °C/W |
| R <sub>θJC(top)</sub>         | Junction-to-case (top) thermal resistance    | 78.7     | 85.6           | 75.8        | 77.1       | °C/W |
| R <sub>θJB</sub>              | Junction-to-board thermal resistance         | 82.2     | 70.0           | 111.0       | 119.1      | °C/W |
| ψ <sub>JT</sub>               | Junction-to-top characterization parameter   | 27.8     | 8.1            | 15.4        | 14.2       | °C/W |
| ψ <sub>JB</sub>               | Junction-to-board characterization parameter | 81.4     | 69.6           | 109.3       | 117.4      | °C/W |
| R <sub>θJC(bot)</sub>         | Junction-to-case (bottom) thermal resistance | N/A      | N/A            | N/A         | N/A        | °C/W |

- (1) For more information about traditional and new thermal metrics, see the *Semiconductor and IC Package Thermal Metrics* application report, [SPRA953](#).

## 6.6 Thermal Information for Quad Channel

| THERMAL METRIC <sup>(1)</sup> |  | TLV9304  |            | UNIT |
|-------------------------------|--|----------|------------|------|
|                               |  | D (SOIC) | PW (TSSOP) |      |
|                               |  | 14 PINS  | 14 PINS    |      |
| R <sub>θJA</sub>              | Junction-to-ambient thermal resistance       | 105.5    | 134.5      | °C/W |
| R <sub>θJC(top)</sub>         | Junction-to-case (top) thermal resistance    | 61.4     | 55.4       | °C/W |
| R <sub>θJB</sub>              | Junction-to-board thermal resistance         | 61.0     | 79.2       | °C/W |
| ψ <sub>JT</sub>               | Junction-to-top characterization parameter   | 21.6     | 9.3        | °C/W |
| ψ <sub>JB</sub>               | Junction-to-board characterization parameter | 60.3     | 78.4       | °C/W |
| R <sub>θJC(bot)</sub>         | Junction-to-case (bottom) thermal resistance | N/A      | N/A        | °C/W |

- (1) For more information about traditional and new thermal metrics, see the *Semiconductor and IC Package Thermal Metrics* application report, [SPRA953](#).

## 6.7 Electrical Characteristics

For  $V_S = (V_+) - (V_-) = 4.5 \text{ V to } 40 \text{ V}$  ( $\pm 2.25 \text{ V to } \pm 20 \text{ V}$ ) at  $T_A = 25^\circ\text{C}$ ,  $R_L = 10 \text{ k}\Omega$  connected to  $V_S / 2$ ,  $V_{CM} = V_S / 2$ , and  $V_{OUT} = V_S / 2$ , unless otherwise noted.

| PARAMETER                  |  | TEST CONDITIONS   |   | MIN  | TYP               | MAX         | UNIT                                 |
|----------------------------|--|---|---|--|-------------------|-------------|--------------------------------------|
| <b>OFFSET VOLTAGE</b>      |  |   |   |  |                   |             |                                      |
| $V_{OS}$                   | Input offset voltage                     | $V_{CM} = V_-$  | $T_A = -40^\circ\text{C to } 125^\circ\text{C}$ | $\pm 0.5$  | $\pm 2.5$         | $\pm 2.75$  | mV                                   |
|                            |  |   |   |  |                   |             |                                      |
| $dV_{OS}/dT$               | Input offset voltage drift               |   | $T_A = -40^\circ\text{C to } 125^\circ\text{C}$ |  | $\pm 2$           |             | $\mu\text{V}/^\circ\text{C}$         |
| PSRR                       | Input offset voltage versus power supply | $V_{CM} = V_-$  | $T_A = -40^\circ\text{C to } 125^\circ\text{C}$ |  | $\pm 2$           | $\pm 5$     | $\mu\text{V}/\text{V}$               |
|                            | Channel separation                       |   |   | $f = 0 \text{ Hz}$   |                   | 5           |                                      |
| <b>INPUT BIAS CURRENT</b>  |  |   |   |  |                   |             |                                      |
| $I_B$                      | Input bias current                       |   |   |  | $\pm 10$          |             | pA                                   |
| $I_{OS}$                   | Input offset current                     |   |   |  | $\pm 10$          |             | pA                                   |
| <b>NOISE</b>               |  |   |   |  |                   |             |                                      |
| $E_N$                      | Input voltage noise                      | $f = 0.1 \text{ Hz to } 10 \text{ Hz}$  |   |  | 6                 |             | $\mu\text{V}_{PP}$                   |
|                            |  |   |   |  | 1                 |             | $\mu\text{V}_{RMS}$                  |
| $e_N$                      | Input voltage noise density              | $f = 1 \text{ kHz}$<br>$f = 10 \text{ kHz}$   |   |  | 33                |             | $\text{nV}/\sqrt{\text{Hz}}$         |
|                            |  |   |   |  | 30                |             |                                      |
| $i_N$                      | Input current noise                      | $f = 1 \text{ kHz}$   |   |  | 5                 |             | $\text{fA}/\sqrt{\text{Hz}}$         |
| <b>INPUT VOLTAGE RANGE</b> |  |   |   |  |                   |             |                                      |
| $V_{CM}$                   | Common-mode voltage range                |   |   | $(V_-) - 0.2$  |                   | $(V_+) - 2$ | V                                    |
| CMRR                       | Common-mode rejection ratio              | $V_S = 40 \text{ V}, (V_-) - 0.1 \text{ V} < V_{CM} < (V_+) - 2 \text{ V}$                  | $T_A = -40^\circ\text{C to } 125^\circ\text{C}$ | 95   | 110               |             | dB                                   |
|                            |  | $V_S = 4.5 \text{ V}, (V_-) - 0.1 \text{ V} < V_{CM} < (V_+) - 2 \text{ V}$                 |   |  | 90                |             |                                      |
|                            |  | $(V_+) - 2 \text{ V} < V_{CM} < (V_+) + 0.1 \text{ V}$                                      |   | See <a href="#">Common-Mode Voltage Range</a>  |                   |             |                                      |
| <b>INPUT CAPACITANCE</b>   |  |   |   |  |                   |             |                                      |
| $Z_{ID}$                   | Differential                             |   |   |  | $110 \parallel 4$ |             | $\text{M}\Omega \parallel \text{pF}$ |
| $Z_{ICM}$                  | Common-mode                              |   |   |  | $6 \parallel 1.5$ |             | $\text{T}\Omega \parallel \text{pF}$ |
| <b>OPEN-LOOP GAIN</b>      |  |   |   |  |                   |             |                                      |
| $A_{OL}$                   | Open-loop voltage gain                   | $V_S = 40 \text{ V}, V_{CM} = V_-$<br>$(V_-) + 0.1 \text{ V} < V_O < (V_+) - 0.1 \text{ V}$ | $T_A = -40^\circ\text{C to } 125^\circ\text{C}$ | 120  | 130               |             | dB                                   |
|                            |  |   |   | 116  | 127               |             |                                      |
| <b>FREQUENCY RESPONSE</b>  |  |   |   |  |                   |             |                                      |
| GBW                        | Gain-bandwidth product                   |   |   |  | 1                 |             | MHz                                  |
| SR                         | Slew rate                                | $V_S = 40 \text{ V}, G = +1, C_L = 20 \text{ pF}$   |   |  | 3                 |             | $\text{V}/\mu\text{s}$               |
| $t_s$                      | Settling time                            |   |   | $T_0 0.1\%, V_S = 40 \text{ V}, V_{STEP} = 10 \text{ V}, G = +1, C_L = 20 \text{ pF}$  | 5                 |             | $\mu\text{s}$                        |
|                            |  |   |   | $T_0 0.1\%, V_S = 40 \text{ V}, V_{STEP} = 2 \text{ V}, G = +1, C_L = 20 \text{ pF}$   | 2.5               |             |                                      |
|                            |  |   |   | $T_0 0.01\%, V_S = 40 \text{ V}, V_{STEP} = 10 \text{ V}, G = +1, C_L = 20 \text{ pF}$ | 6                 |             |                                      |
|                            |  |   |   | $T_0 0.01\%, V_S = 40 \text{ V}, V_{STEP} = 2 \text{ V}, G = +1, C_L = 20 \text{ pF}$  | 3.5               |             |                                      |
|                            | Phase margin                             | $G = +1, R_L = 10 \text{ k}\Omega, C_L = 20 \text{ pF}$                                     |   |  | 60                |             | $^\circ$                             |
|                            | Overload recovery time                   | $V_{IN} \times \text{gain} > V_S$   |   |  | 1                 |             | $\mu\text{s}$                        |
| THD+N                      | Total harmonic distortion + noise        | $V_S = 40 \text{ V}, V_O = 1 \text{ V}_{RMS}, G = -1, f = 1 \text{ kHz}$                    |   |  | 0.003%            |             |                                      |

## 6.7 Electrical Characteristics (continued)

For  $V_S = (V+) - (V-) = 4.5\text{ V to }40\text{ V}$  ( $\pm 2.25\text{ V to } \pm 20\text{ V}$ ) at  $T_A = 25^\circ\text{C}$ ,  $R_L = 10\text{ k}\Omega$  connected to  $V_S / 2$ ,  $V_{CM} = V_S / 2$ , and  $V_{OUT} = V_S / 2$ , unless otherwise noted.

| PARAMETER                      | TEST CONDITIONS                     |   | MIN  | TYP      | MAX | UNIT          |
|--------------------------------|-------------------------------------|---|--|----------|-----|---------------|
| <b>OUTPUT</b>                  |                                     |   |  |          |     |               |
| Voltage output swing from rail | Positive and negative rail headroom | $V_S = 40\text{ V}, R_L = \text{no load}$     |  | 3        |     | mV            |
|                                |                                     | $V_S = 40\text{ V}, R_L = 10\text{ k}\Omega$  |  | 50       | 75  |               |
|                                |                                     | $V_S = 40\text{ V}, R_L = 2\text{ k}\Omega$   |  | 250      | 350 |               |
|                                |                                     | $V_S = 4.5\text{ V}, R_L = \text{no load}$    |  | 1        |     |               |
|                                |                                     | $V_S = 4.5\text{ V}, R_L = 10\text{ k}\Omega$ |  | 20       | 30  |               |
|                                |                                     | $V_S = 4.5\text{ V}, R_L = 2\text{ k}\Omega$  |  | 40       | 75  |               |
| $I_{SC}$                       | Short-circuit current               |   |  | $\pm 60$ |     | mA            |
| $C_{LOAD}$                     | Capacitive load drive               |   | See <a href="#">Typical Characteristics</a>    |          |     |               |
| $Z_O$                          | Open-loop output impedance          | $f = 1\text{ MHz}, I_O = 0\text{ A}$          |  | 600      |     | $\Omega$      |
| <b>POWER SUPPLY</b>            |                                     |   |  |          |     |               |
| $I_Q$                          | Quiescent current per amplifier     | $I_O = 0\text{ A}$                            |  | 150      | 175 | $\mu\text{A}$ |
|                                |                                     |   | $T_A = -40^\circ\text{C to }125^\circ\text{C}$ |          | 175 |               |

## 6.8 Typical Characteristics

at  $T_A = 25^\circ\text{C}$ ,  $V_S = \pm 20\text{ V}$ ,  $V_{CM} = V_S / 2$ ,  $R_{LOAD} = 10\text{ k}\Omega$  connected to  $V_S / 2$ , and  $C_L = 100\text{ pF}$  (unless otherwise noted)

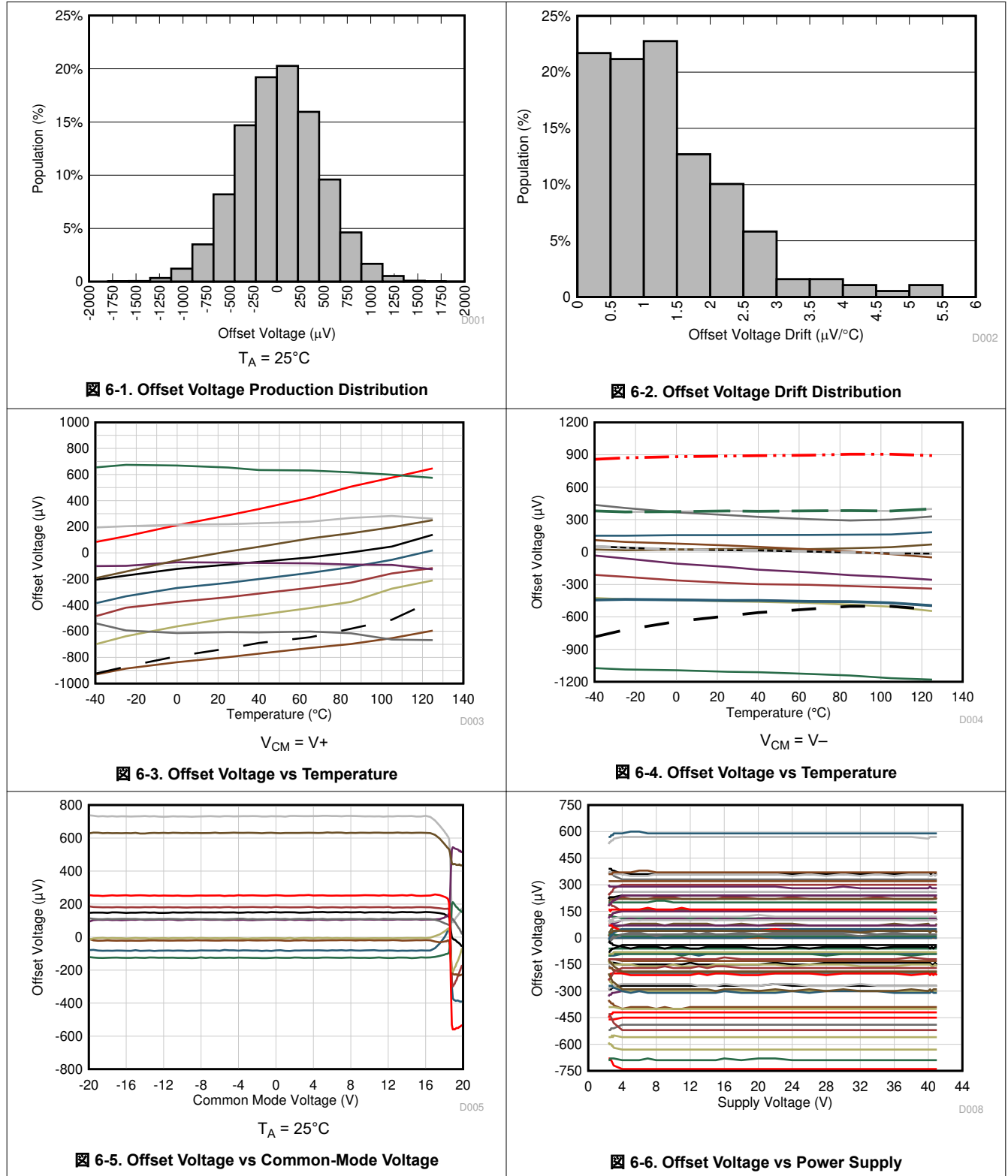

## 6.8 Typical Characteristics (continued)

at  $T_A = 25^\circ\text{C}$ ,  $V_S = \pm 20\text{ V}$ ,  $V_{\text{CM}} = V_S / 2$ ,  $R_{\text{LOAD}} = 10\text{ k}\Omega$  connected to  $V_S / 2$ , and  $C_L = 100\text{ pF}$  (unless otherwise noted)

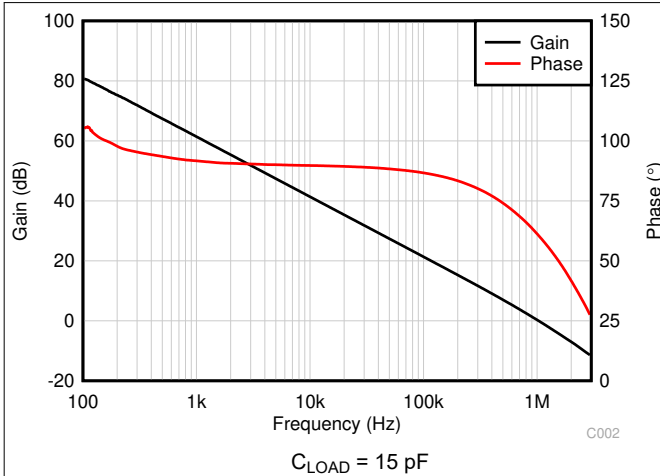

Figure 6-7. Open-Loop Gain and Phase vs Frequency

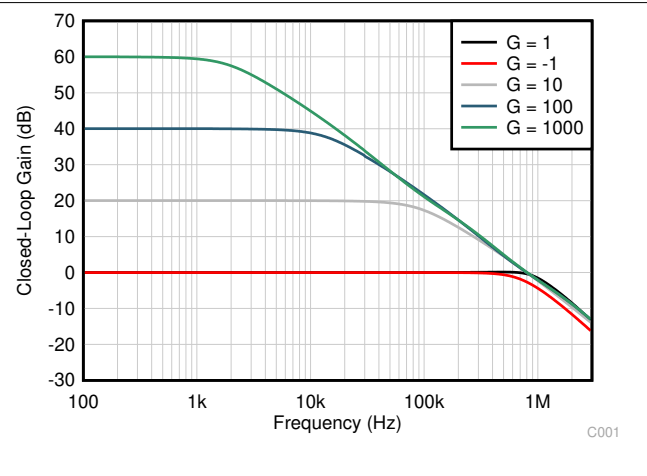

Figure 6-8. Closed-Loop Gain and Phase vs Frequency

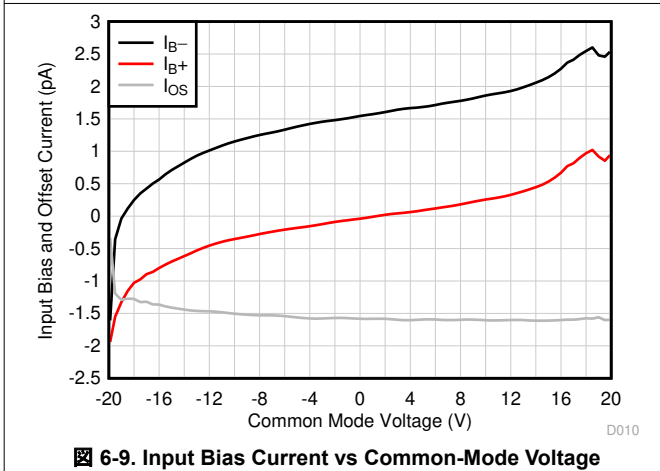

Figure 6-9. Input Bias Current vs Common-Mode Voltage

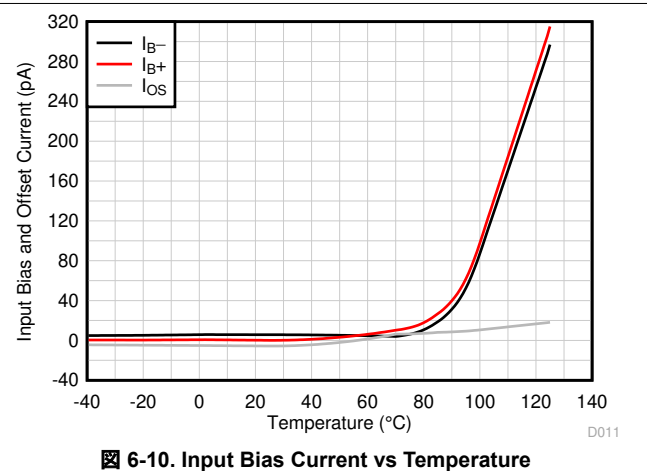

Figure 6-10. Input Bias Current vs Temperature

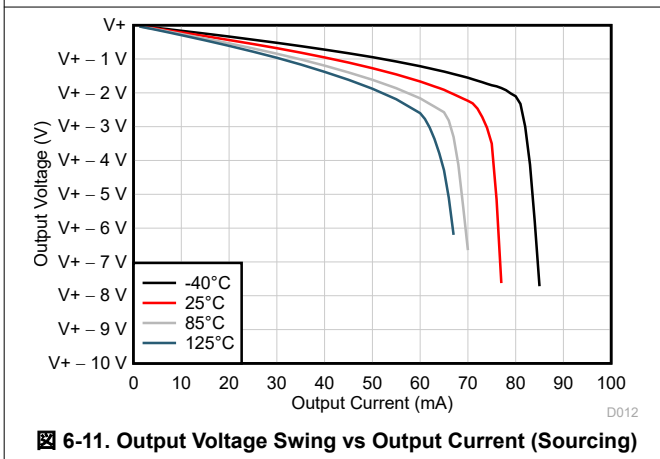

Figure 6-11. Output Voltage Swing vs Output Current (Sourcing)

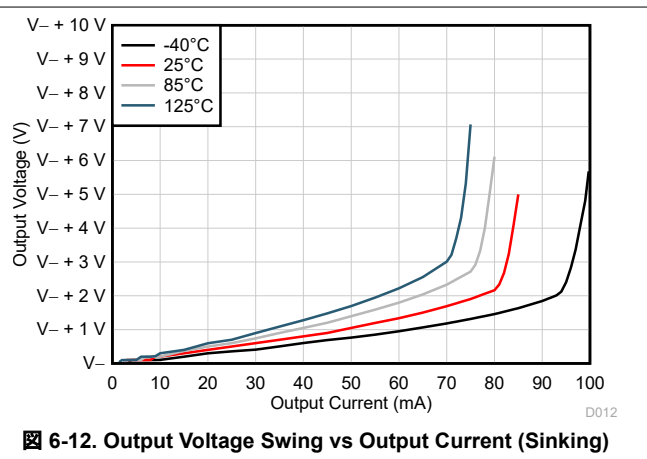
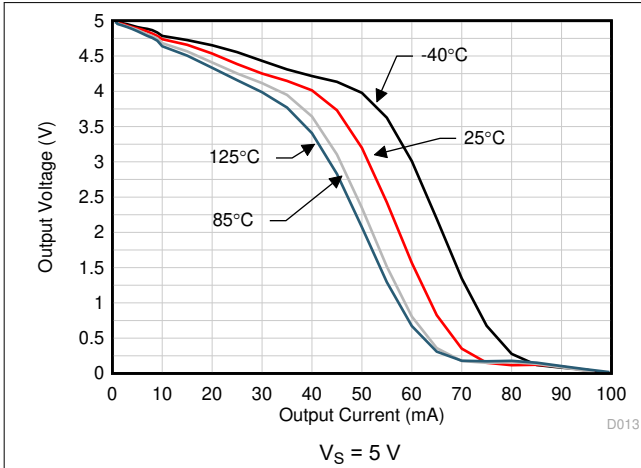

Figure 6-12. Output Voltage Swing vs Output Current (Sinking)

### 6.8 Typical Characteristics (continued)

at  $T_A = 25^\circ\text{C}$ ,  $V_S = \pm 20\text{ V}$ ,  $V_{CM} = V_S / 2$ ,  $R_{LOAD} = 10\text{ k}\Omega$  connected to  $V_S / 2$ , and  $C_L = 100\text{ pF}$  (unless otherwise noted)



**6-13. Output Voltage Swing vs Output Current (Sourcing)**

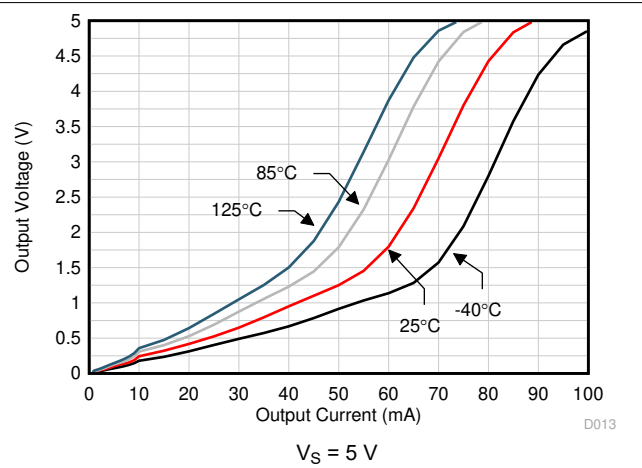

**6-14. Output Voltage Swing vs Output Current (Sinking)**

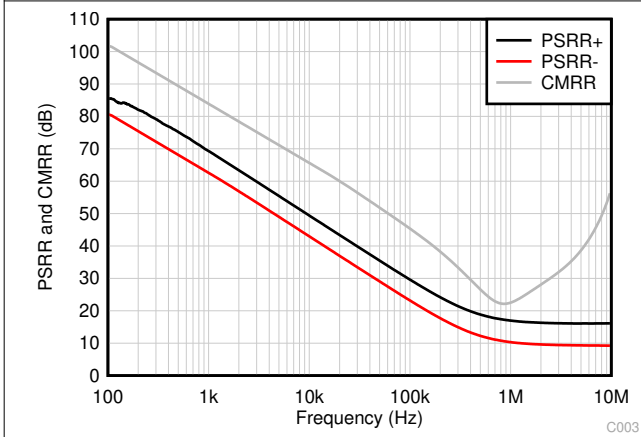

**6-15. CMRR and PSRR vs Frequency**

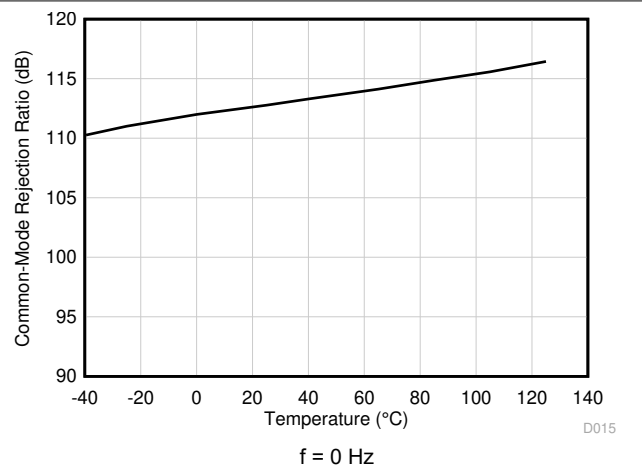

**6-16. CMRR vs Temperature (dB)**

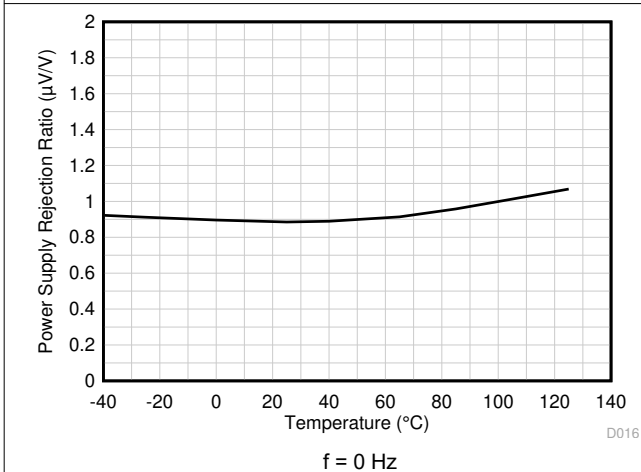

**6-17. PSRR vs Temperature (dB)**

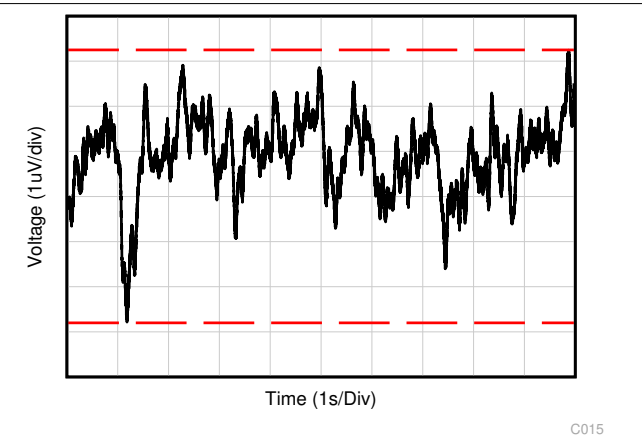

**6-18. 0.1-Hz to 10-Hz Noise**

### 6.8 Typical Characteristics (continued)

at  $T_A = 25^\circ\text{C}$ ,  $V_S = \pm 20\text{ V}$ ,  $V_{CM} = V_S / 2$ ,  $R_{LOAD} = 10\text{ k}\Omega$  connected to  $V_S / 2$ , and  $C_L = 100\text{ pF}$  (unless otherwise noted)

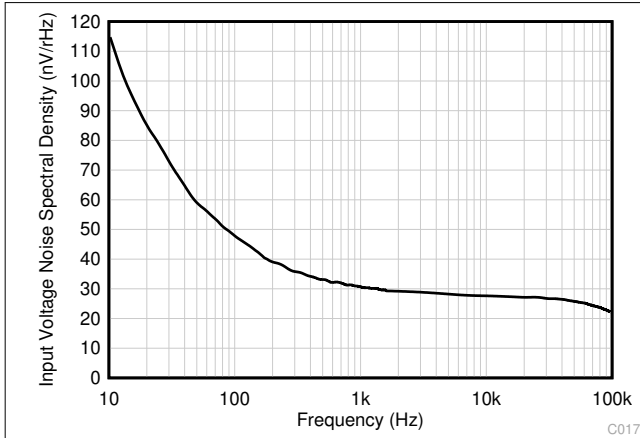

6-19. Input Voltage Noise Spectral Density vs Frequency

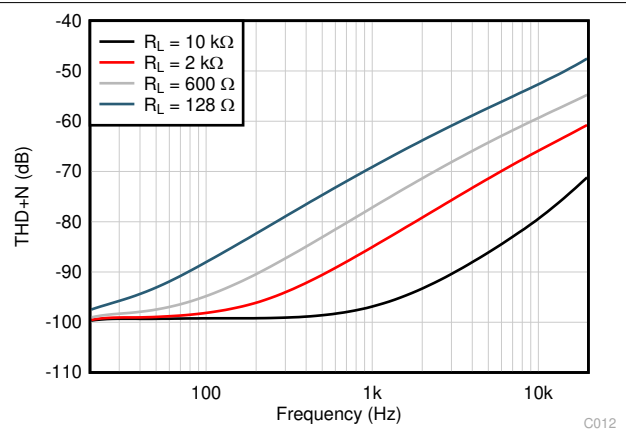

BW = 80 kHz,  $V_{OUT} = 3.5\text{ V}_{RMS}$

6-20. THD+N Ratio vs Frequency

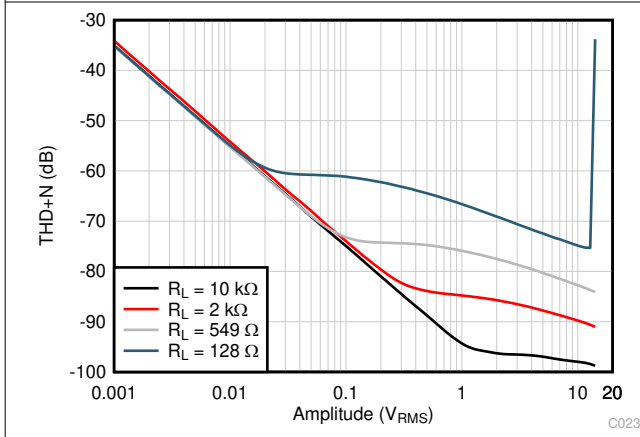

BW = 80 kHz,  $f = 1\text{ kHz}$

6-21. THD+N vs Output Amplitude

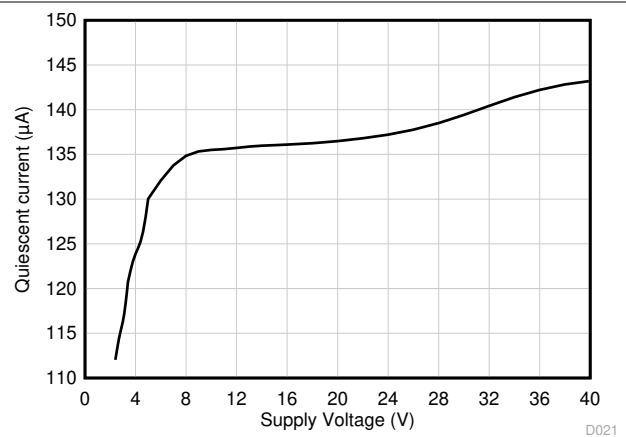

6-22. Quiescent Current vs Supply Voltage

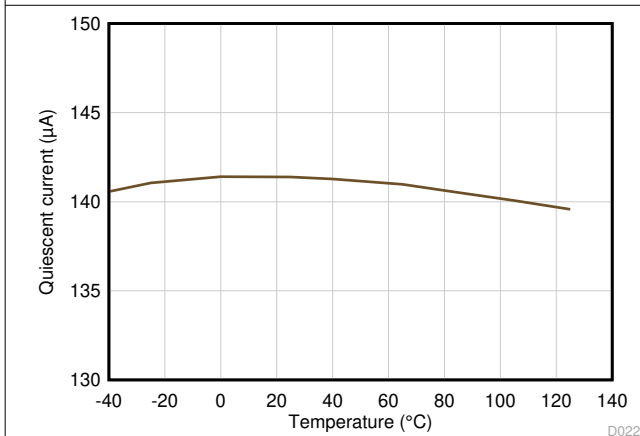

6-23. Quiescent Current vs Temperature

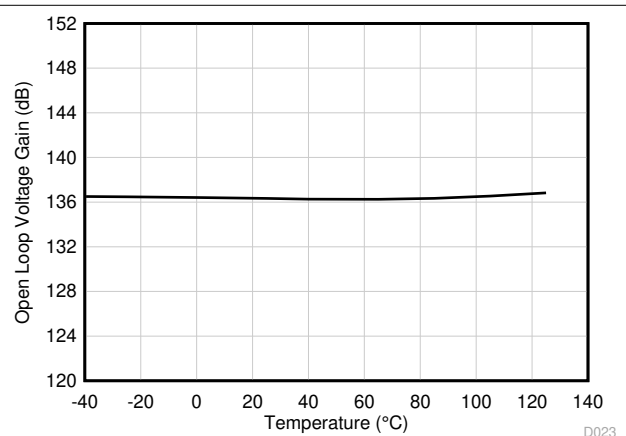

6-24. Open-Loop Voltage Gain vs Temperature (dB)

### 6.8 Typical Characteristics (continued)

at  $T_A = 25^\circ\text{C}$ ,  $V_S = \pm 20\text{ V}$ ,  $V_{CM} = V_S / 2$ ,  $R_{LOAD} = 10\text{ k}\Omega$  connected to  $V_S / 2$ , and  $C_L = 100\text{ pF}$  (unless otherwise noted)

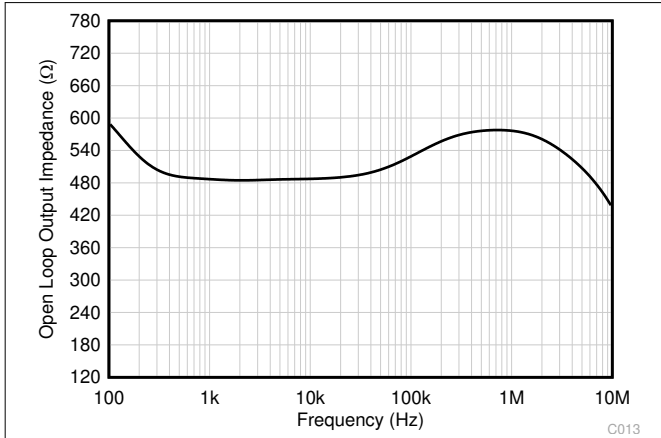

6-25. Open-Loop Output Impedance vs Frequency

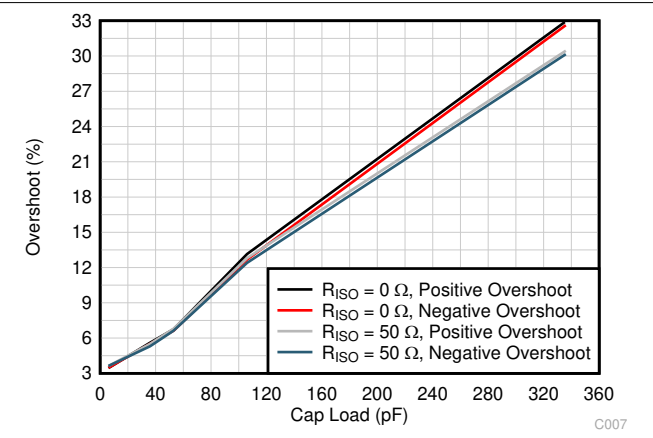

$G = -1$ , 100-mV output step

6-26. Small-Signal Overshoot vs Capacitive Load

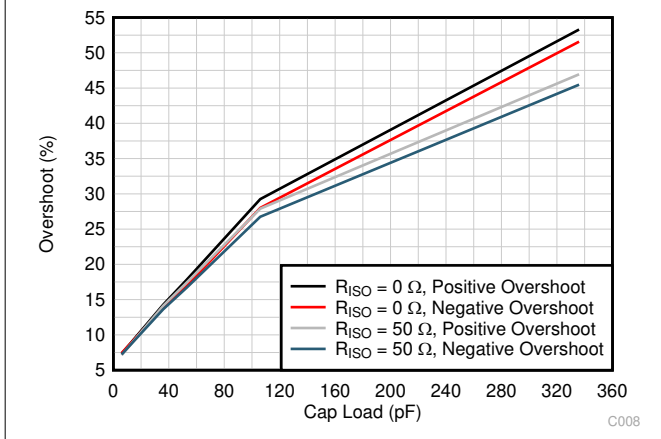

$G = 1$ , 100-mV output step

6-27. Small-Signal Overshoot vs Capacitive Load

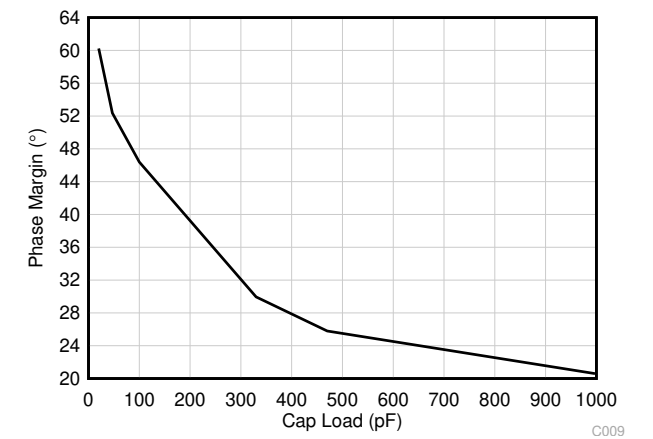

$G = -1$ , 100-mV output step

6-28. Small-Signal Overshoot vs Capacitive Load

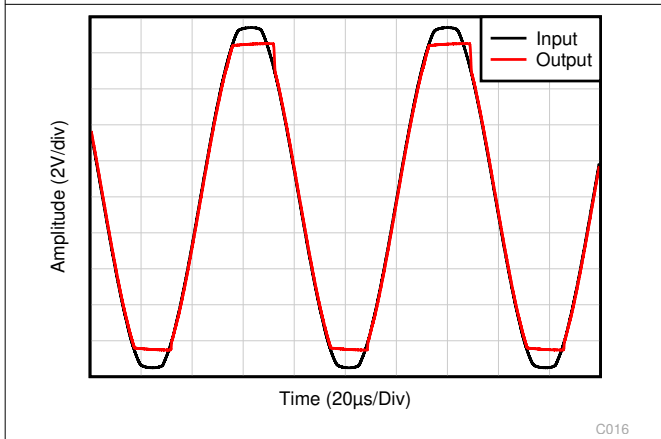

6-29. No Phase Reversal

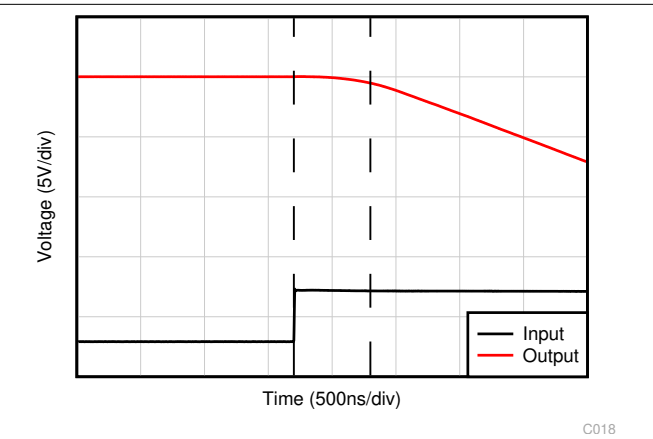

$G = -10$

6-30. Positive Overload Recovery

## 6.8 Typical Characteristics (continued)

at  $T_A = 25^\circ\text{C}$ ,  $V_S = \pm 20\text{ V}$ ,  $V_{CM} = V_S / 2$ ,  $R_{LOAD} = 10\text{ k}\Omega$  connected to  $V_S / 2$ , and  $C_L = 100\text{ pF}$  (unless otherwise noted)

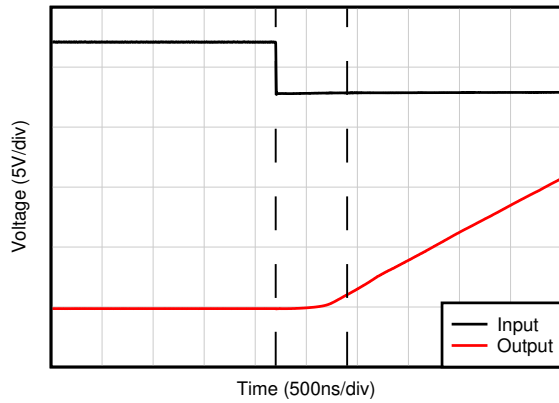

Time (500ns/div)

$G = -10$

C018

**6-31. Negative Overload Recovery**

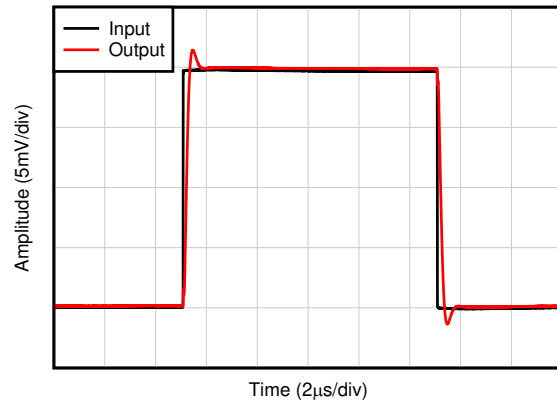

Time (2µs/div)

$C_L = 20\text{ pF}$ ,  $G = 1$ , 20-mV step response

C010

**6-32. Small-Signal Step Response**

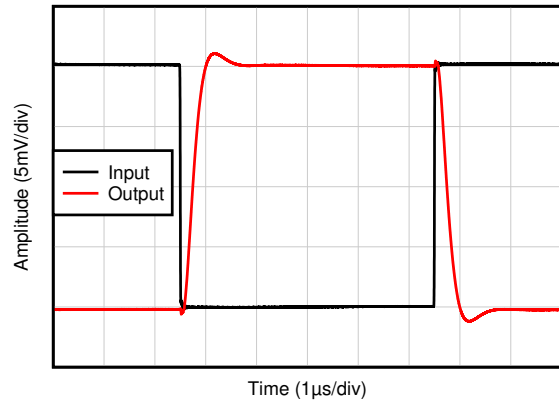

Time (1µs/div)

$R_L = 1\text{ k}\Omega$ ,  $C_L = 20\text{ pF}$ ,  $G = -1$ , 10-mV step response

C011

**6-33. Small-Signal Step Response**

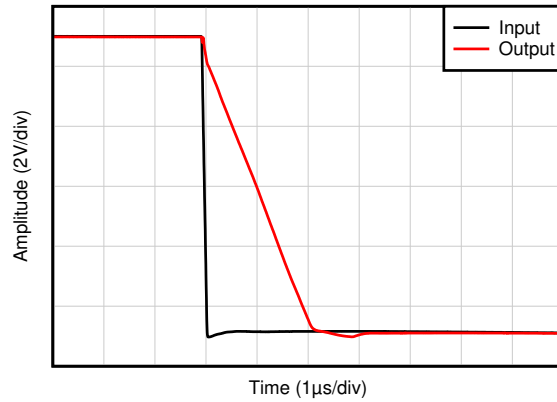

Time (1µs/div)

$C_L = 20\text{ pF}$ ,  $G = 1$

C005

**6-34. Large-Signal Step Response (Falling)**

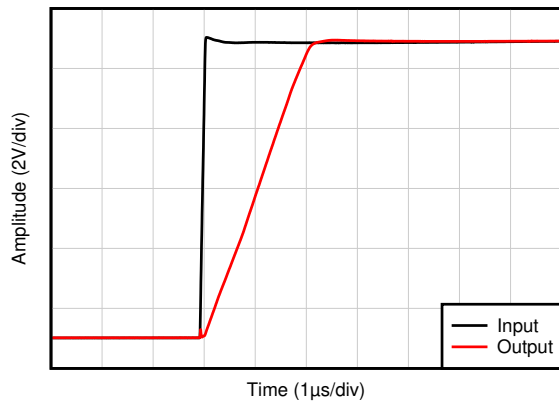

Time (1µs/div)

$C_L = 20\text{ pF}$ ,  $G = 1$

C005

**6-35. Large-Signal Step Response (Rising)**

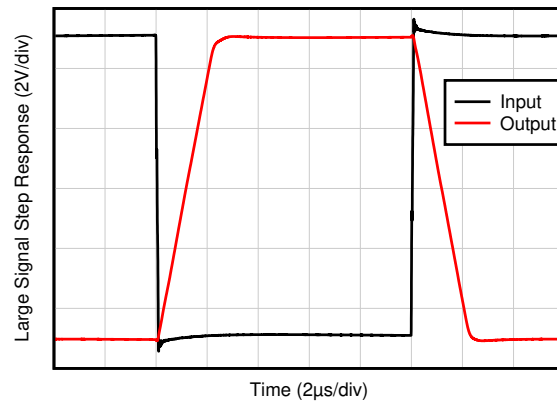

Time (2µs/div)

$C_L = 10\text{ pF}$ ,  $G = -1$

C021

**6-36. Large-Signal Step Response**

### 6.8 Typical Characteristics (continued)

at  $T_A = 25^\circ\text{C}$ ,  $V_S = \pm 20\text{ V}$ ,  $V_{CM} = V_S / 2$ ,  $R_{LOAD} = 10\text{ k}\Omega$  connected to  $V_S / 2$ , and  $C_L = 100\text{ pF}$  (unless otherwise noted)

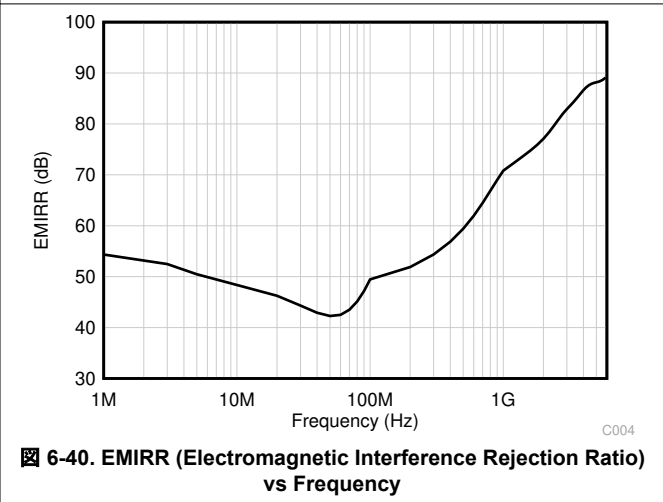
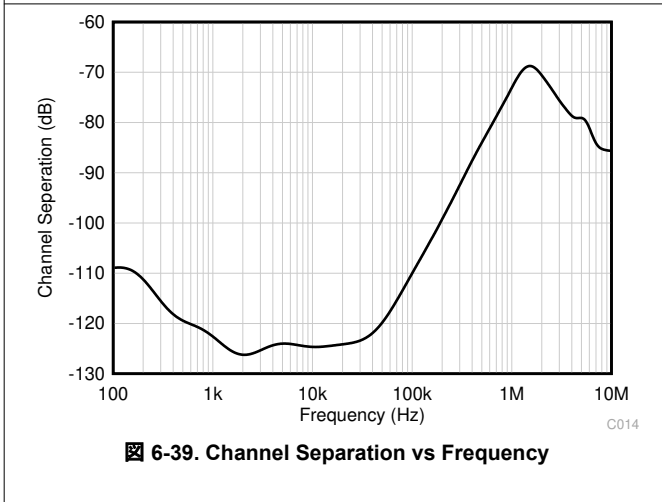
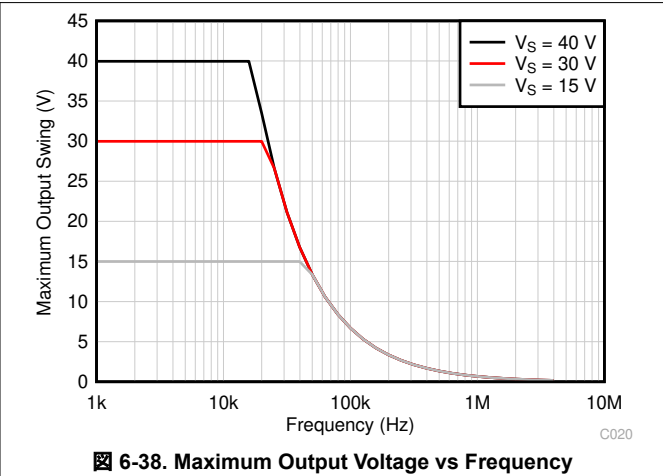
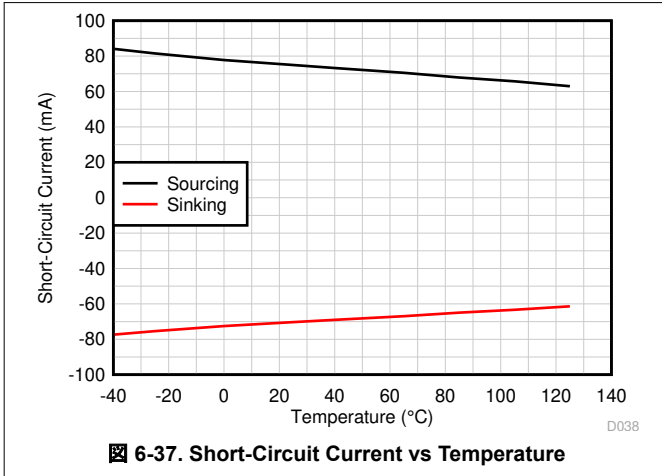

## 7 Detailed Description

### 7.1 Overview

The TLV930x family (TLV9301, TLV9302, and TLV9304) is a family of 40-V, cost-optimized operational amplifiers. These devices offer strong general-purpose DC and AC specifications, including rail-to-rail output, low offset ( $\pm 0.5$  mV, typ), low offset drift ( $\pm 2$   $\mu\text{V}/^\circ\text{C}$ , typ), and 1-MHz bandwidth.

Convenient features such as wide differential input-voltage range, high output current ( $\pm 60$  mA), and high slew rate (3 V/ $\mu\text{s}$ ) make the TLV930x a robust operational amplifier for high-voltage, cost-sensitive applications.

The TLV930x family of op amps is available in standard packages and is specified from  $-40^\circ\text{C}$  to  $125^\circ\text{C}$ .

### 7.2 Functional Block Diagram

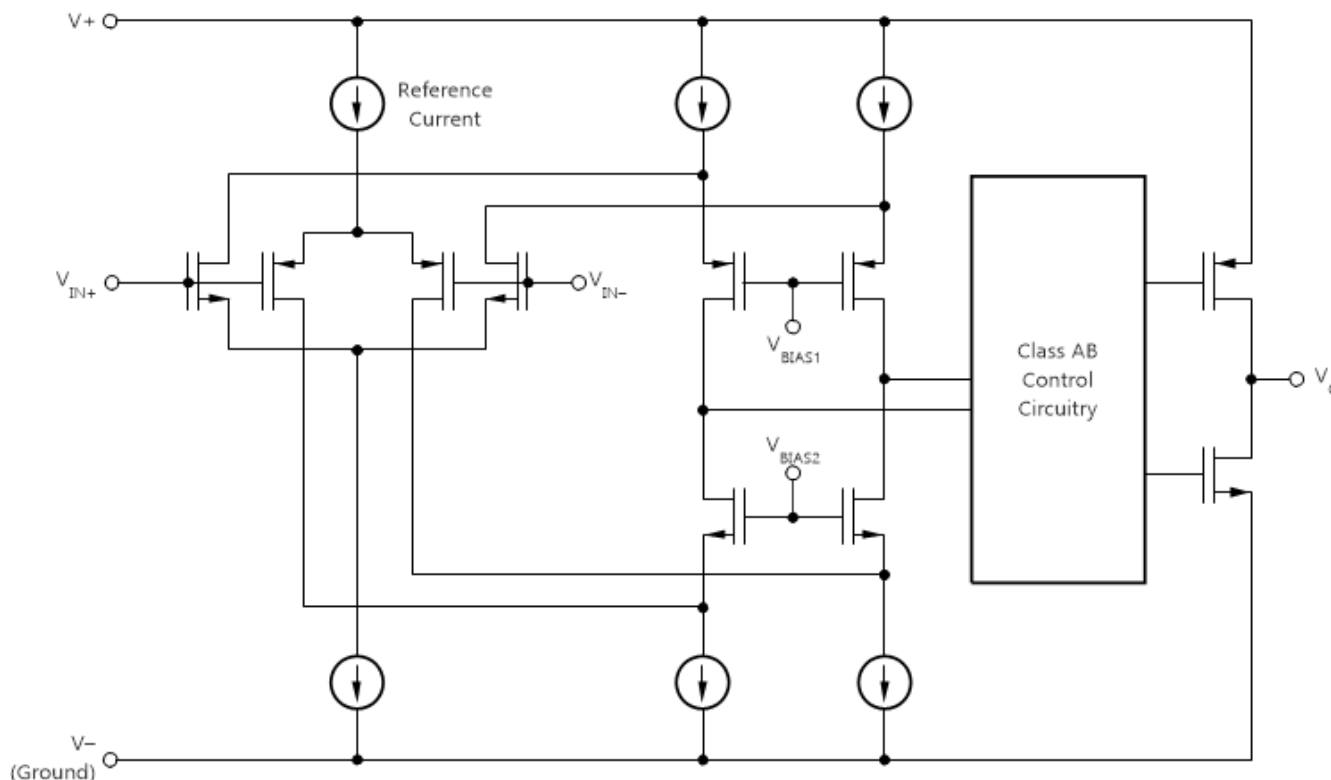

## 7.3 Feature Description

### 7.3.1 Input Protection Circuitry

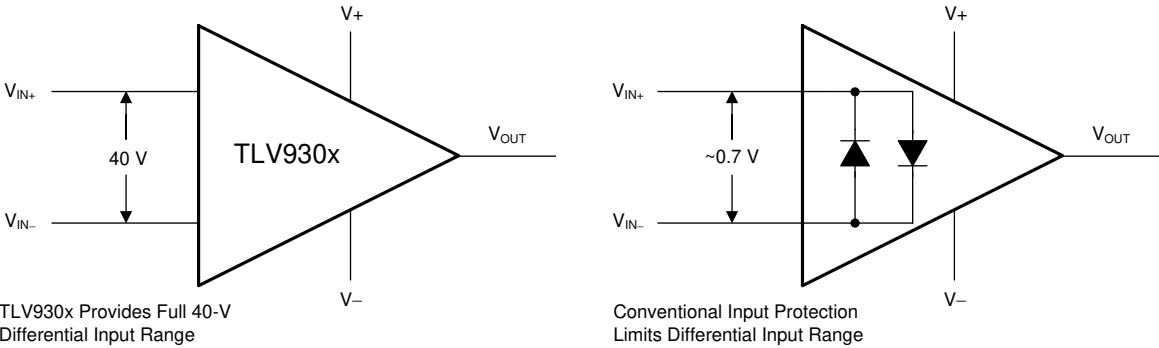
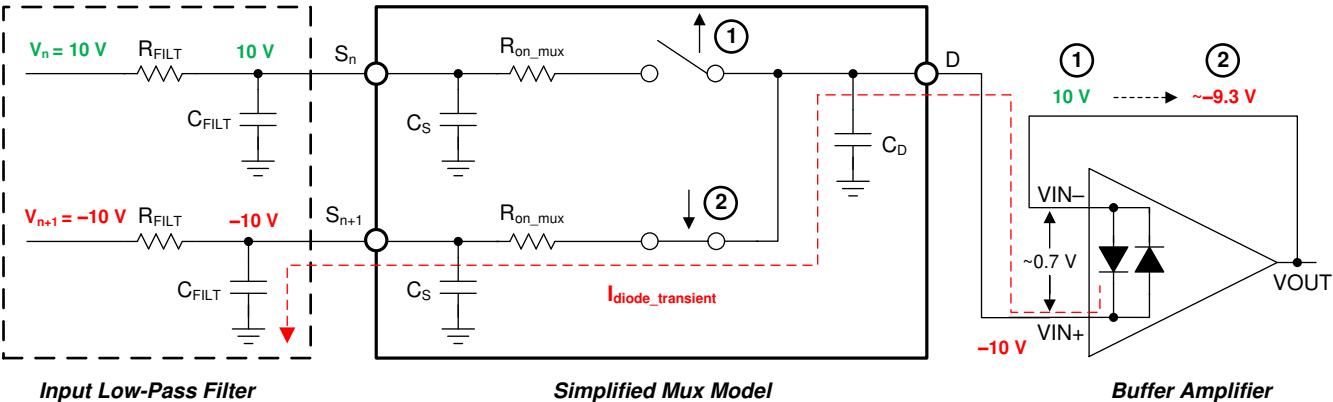
The TLV930x uses a patented input architecture to eliminate the requirement for input protection diodes but still provides robust input protection under transient conditions.  7-1 shows conventional input diode protection schemes that are activated by fast transient step responses and introduce signal distortion and settling time delays because of alternate current paths, as shown in  7-2. For low-gain circuits, these fast-ramping input signals forward-bias back-to-back diodes, causing an increase in input current and resulting in extended settling time.

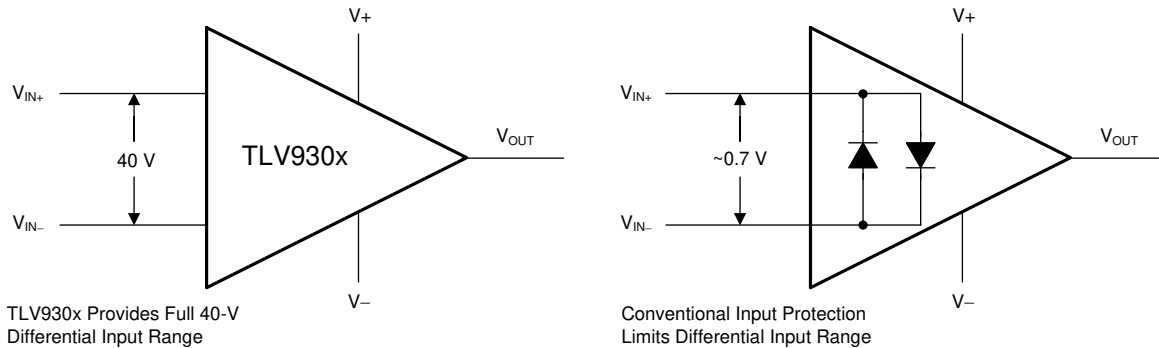

 7-1. TLV930x Input Protection Does Not Limit Differential Input Capability

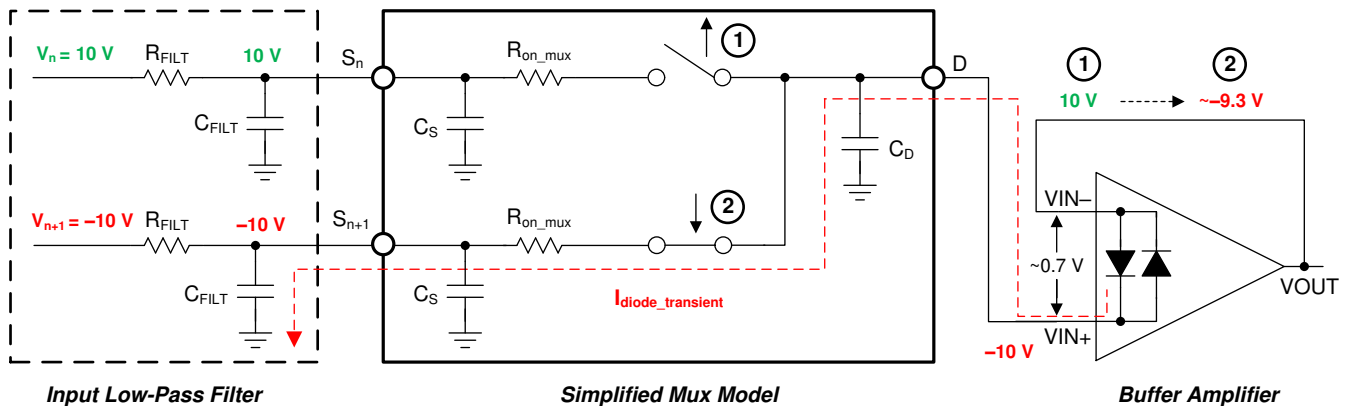

 7-2. Back-to-Back Diodes Create Settling Issues

The TLV930x family of operational amplifiers provides a true high-impedance differential input capability for high-voltage applications. This patented input protection architecture does not introduce additional signal distortion or delayed settling time, making the device an optimal op amp for multichannel, high-switched, input applications. The TLV930x tolerates a maximum differential swing (voltage between inverting and noninverting pins of the op amp) of up to 40 V, making the device suitable for use as a comparator or in applications with fast-ramping input signals.

### 7.3.2 EMI Rejection

The TLV930x uses integrated electromagnetic interference (EMI) filtering to reduce the effects of EMI from sources such as wireless communications and densely-populated boards with a mix of analog signal chain and digital components. EMI immunity can be improved with circuit design techniques; the TLV930x benefits from these design improvements. Texas Instruments has developed the ability to accurately measure and quantify the immunity of an operational amplifier over a broad frequency spectrum extending from 10 MHz to 6 GHz. [Figure 7-3](#) shows the results of this testing on the TLV930x. [Table 7-1](#) shows the EMIRR IN+ values for the TLV930x at particular frequencies commonly encountered in real-world applications. [Table 7-1](#) lists applications that may be centered on or operated near the particular frequency shown. The [EMI Rejection Ratio of Operational Amplifiers](#) application report contains detailed information on the topic of EMIRR performance as it relates to op amps and is available for download from [www.ti.com](http://www.ti.com).

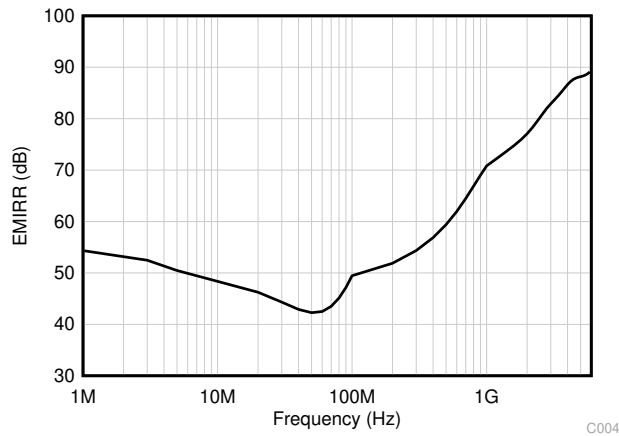

**Figure 7-3. EMIRR Testing**

**Table 7-1. TLV930x EMIRR IN+ for Frequencies of Interest**

| FREQUENCY | APPLICATION OR ALLOCATION  | EMIRR IN+ |
|-----------|--|-----------|
| 400 MHz   | Mobile radio, mobile satellite, space operation, weather, radar, ultra-high frequency (UHF) applications   | 59.5 dB   |
| 900 MHz   | Global system for mobile communications (GSM) applications, radio communication, navigation, GPS (to 1.6 GHz), GSM, aeronautical mobile, UHF applications                        | 68.9 dB   |
| 1.8 GHz   | GSM applications, mobile personal communications, broadband, satellite, L-band (1 GHz to 2 GHz)  | 77.8 dB   |
| 2.4 GHz   | 802.11b, 802.11g, 802.11n, Bluetooth®, mobile personal communications, industrial, scientific and medical (ISM) radio band, amateur radio and satellite, S-band (2 GHz to 4 GHz) | 78.0 dB   |
| 3.6 GHz   | Radiolocation, aero communication and navigation, satellite, mobile, S-band  | 88.8 dB   |
| 5 GHz     | 802.11a, 802.11n, aero communication and navigation, mobile communication, space and satellite operation, C-band (4 GHz to 8 GHz)  | 87.6 dB   |

### 7.3.3 Phase Reversal Protection

The TLV930x family has internal phase-reversal protection. Many op amps exhibit a phase reversal when the input is driven beyond its linear common-mode range. This condition is most often encountered in noninverting circuits when the input is driven beyond the specified common-mode voltage range, causing the output to reverse into the opposite rail. The TLV930x is a rail-to-rail input op amp; therefore, the common-mode range can extend up to the rails. Input signals beyond the rails do not cause phase reversal; instead, the output limits into the appropriate rail. This performance is shown in [Figure 7-4](#).

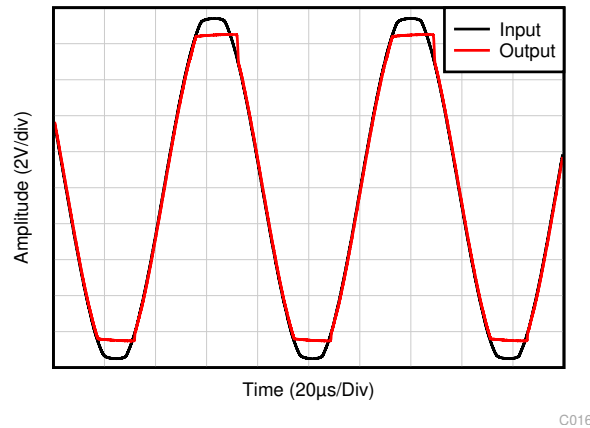

**Figure 7-4. No Phase Reversal**

### 7.3.4 Thermal Protection

The internal power dissipation of any amplifier causes its internal (junction) temperature to rise. This phenomenon is called *self heating*. The absolute maximum junction temperature of the TLV930x is 150°C. Exceeding this temperature causes damage to the device. The TLV930x has a thermal protection feature that prevents damage from self heating. The protection works by monitoring the temperature of the device and turning off the op amp output drive for temperatures above 140°C. [Figure 7-5](#) shows an application example for the TLV9301 that has significant self heating (159°C) because of its power dissipation (0.81 W). Thermal calculations indicate that for an ambient temperature of 65°C the device junction temperature must reach 187°C. The actual device, however, turns off the output drive to maintain a safe junction temperature. [Figure 7-5](#) shows how the circuit behaves during thermal protection. During normal operation, the device acts as a buffer so the output is 3 V. When self heating causes the device junction temperature to increase above 140°C, the thermal protection forces the output to a high-impedance state and the output is pulled to ground through resistor  $R_L$ .

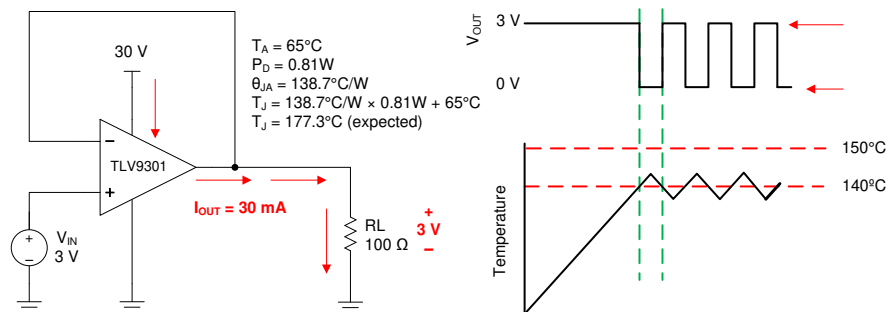

**Figure 7-5. Thermal Protection**

### 7.3.5 Capacitive Load and Stability

The TLV930x features a resistive output stage capable of driving smaller capacitive loads, and by leveraging an isolation resistor, the device can easily be configured to drive large capacitive loads. Increasing the gain enhances the ability of the amplifier to drive greater capacitive loads; see [Figure 7-6](#) and [Figure 7-7](#). The particular op amp circuit configuration, layout, gain, and output loading are some of the factors to consider when establishing whether an amplifier is stable in operation.

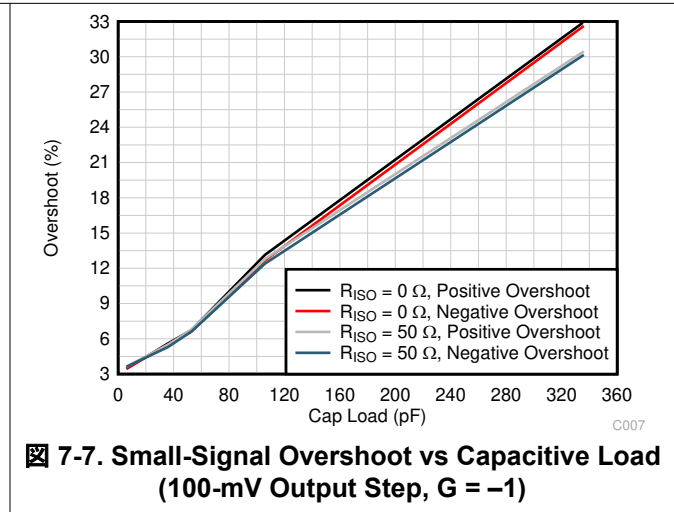
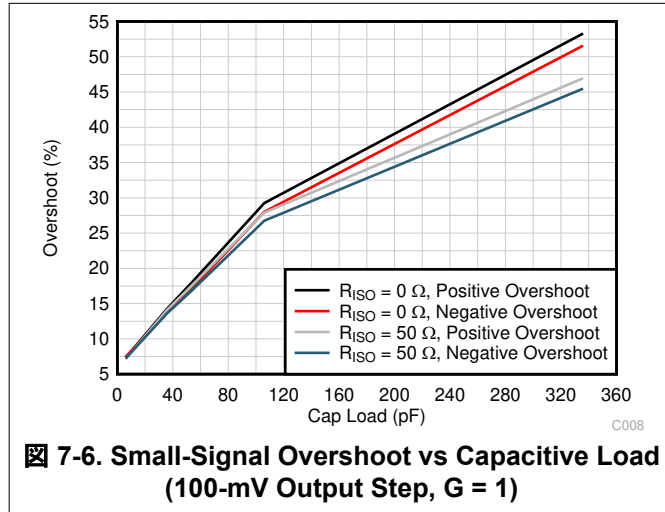

For additional drive capability in unity-gain configurations, improve capacitive load drive by inserting a small (10  $\Omega$  to 20  $\Omega$ ) resistor,  $R_{ISO}$ , in series with the output, as shown in [Figure 7-8](#). This resistor significantly reduces ringing and maintains DC performance for purely capacitive loads. However, if a resistive load is in parallel with the capacitive load, then a voltage divider is created, thus introducing a gain error at the output and slightly reducing the output swing. The error introduced is proportional to the ratio  $R_{ISO} / R_L$ , and is generally negligible at low output levels. A high capacitive load drive makes the TLV930x well suited for applications such as reference buffers, MOSFET gate drives, and cable-shield drives. The circuit shown in [Figure 7-8](#) uses an isolation resistor,  $R_{ISO}$ , to stabilize the output of an op amp.  $R_{ISO}$  modifies the open-loop gain of the system for increased phase margin. For additional information on techniques to optimize and design using this circuit, TI Precision Design [TIDU032](#) details complete design goals, simulation, and test results.

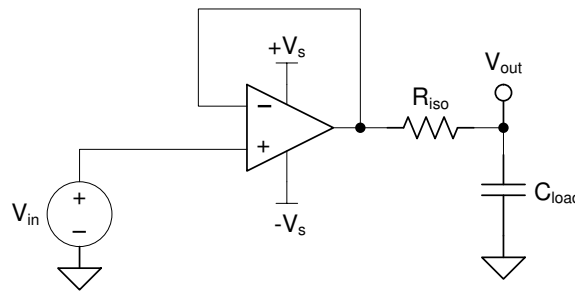

**Figure 7-8. Extending Capacitive Load Drive With the TLV9301**

### 7.3.6 Common-Mode Voltage Range

The TLV930x is a 40-V, rail-to-rail output operational amplifier with an input common-mode range that extends 100 mV beyond  $V_{-}$  and within 2 V of  $V_{+}$  for normal operation. The device accomplishes this performance through a complementary input stage, using a P-channel differential pair. Additionally, a complementary N-channel differential pair has been included in parallel with the P-channel pair to eliminate common undesirable op amp behaviors, such as phase reversal.

The TLV930x can operate with common mode ranges beyond 100 mV of the top rail, but with reduced performance above  $(V_{+}) - 2$  V. The N-channel pair is active for input voltages close to the positive rail, typically  $(V_{+}) - 1$  V to 100 mV above the positive supply. The P-channel pair is active for inputs from 100 mV below the negative supply to approximately  $(V_{+}) - 2$  V. There is a small transition region, typically  $(V_{+}) - 2$  V to  $(V_{+}) - 1$  V in which both input pairs are on. This transition region can vary modestly with process variation, and within the transition region and N-channel region, many specifications of the op amp, including PSRR, CMRR, offset voltage, offset drift, noise and THD performance may be degraded compared to operation within the P-channel region.

**表 7-2. Typical Performance for Common-Mode Voltages Within 2 V of the Positive Supply**

| PARAMETER                 | MIN           | TYP | MAX             | UNIT                           |
|---------------------------|---------------|-----|-----------------|--------------------------------|
| Input common-mode voltage | $(V_{+}) - 2$ |     | $(V_{+}) + 0.1$ | V                              |
| Offset voltage            |               | 1.5 |                 | mV                             |
| Offset voltage drift      |               | 2   |                 | $\mu\text{V}/^{\circ}\text{C}$ |
| Common-mode rejection     |               | 75  |                 | dB                             |
| Open-loop gain            |               | 75  |                 | dB                             |
| Gain-bandwidth product    |               | 0.7 |                 | MHz                            |

### 7.3.7 Electrical Overstress

Designers often ask questions about the capability of an operational amplifier to withstand electrical overstress (EOS). These questions tend to focus on the device inputs, but may involve the supply voltage pins or even the output pin. Each of these different pin functions have electrical stress limits determined by the voltage breakdown characteristics of the particular semiconductor fabrication process and specific circuits connected to the pin. Additionally, internal electrostatic discharge (ESD) protection is built into these circuits to protect them from accidental ESD events both before and during product assembly.

Having a good understanding of this basic ESD circuitry and its relevance to an electrical overstress event is helpful.  7-9 shows an illustration of the ESD circuits contained in the TLV930x (indicated by the dashed line area). The ESD protection circuitry involves several current-steering diodes connected from the input and output pins and routed back to the internal power-supply lines, where the diodes meet at an absorption device or the power-supply ESD cell, internal to the operational amplifier. This protection circuitry is intended to remain inactive during normal circuit operation.

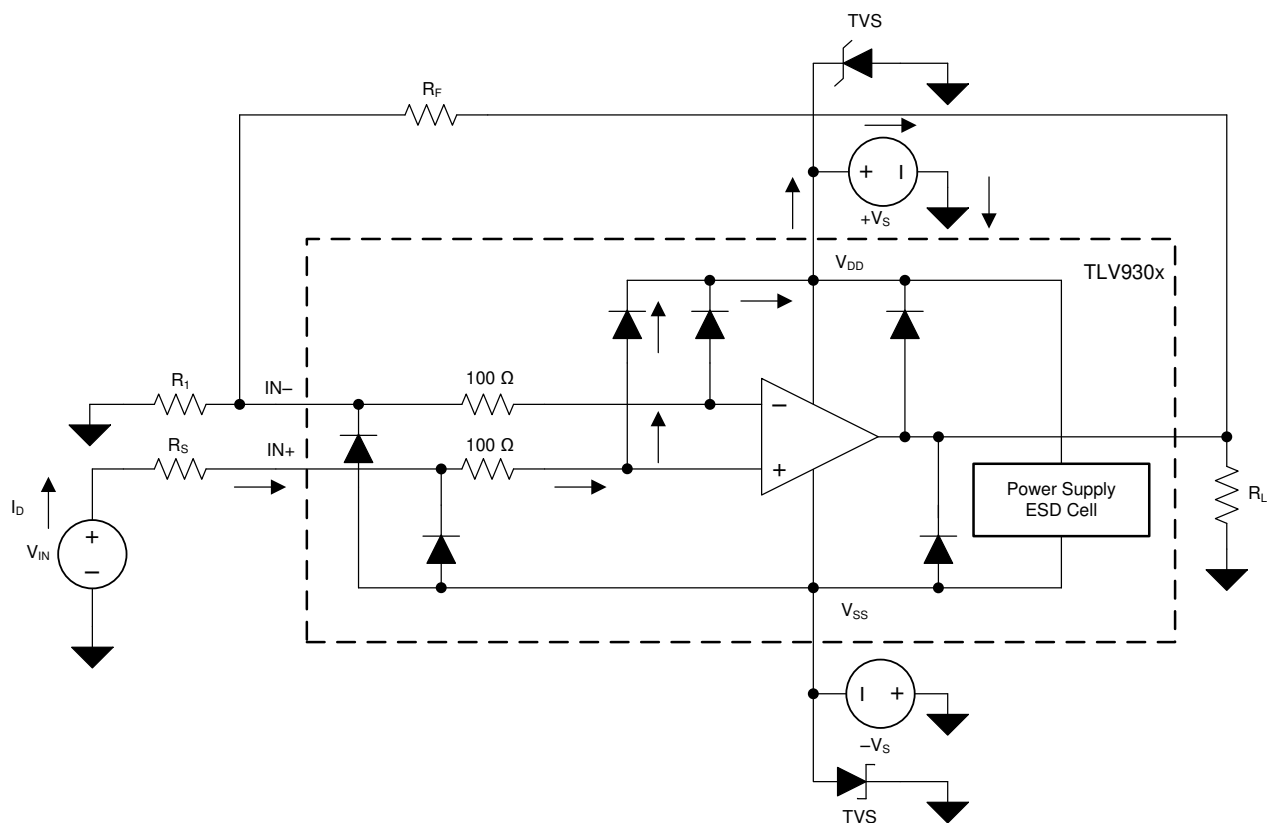

 7-9. Equivalent Internal ESD Circuitry Relative to a Typical Circuit Application

An ESD event is very short in duration and very high voltage (for example, 1 kV, 100 ns), whereas an EOS event is long duration and lower voltage (for example, 50 V, 100 ms). The ESD diodes are designed for out-of-circuit ESD protection (that is, during assembly, test, and storage of the device before being soldered to the PCB). During an ESD event, the ESD signal is passed through the ESD steering diodes to an absorption circuit (labeled ESD power-supply circuit). The ESD absorption circuit clamps the supplies to a safe level.

Although this behavior is necessary for out-of-circuit protection, excessive current and damage is caused if activated in-circuit. A transient voltage suppressors (TVS) can be used to prevent against damage caused by turning on the ESD absorption circuit during an in-circuit ESD event. Using the appropriate current limiting resistors and TVS diodes allows for the use of device ESD diodes to protect against EOS events.

### 7.3.8 Overload Recovery

Overload recovery is defined as the time required for the op amp output to recover from a saturated state to a linear state. The output devices of the op amp enter a saturation region when the output voltage exceeds the rated operating voltage, either due to the high input voltage or the high gain. After the device enters the saturation region, the charge carriers in the output devices require time to return back to the linear state. After the charge carriers return back to the linear state, the device begins to slew at the specified slew rate. Thus, the propagation delay in case of an overload condition is the sum of the overload recovery time and the slew time. The overload recovery time for the TLV930x is approximately 1  $\mu$ s.

### 7.3.9 Typical Specifications and Distributions

Designers often have questions about a typical specification of an amplifier in order to design a more robust circuit. Due to natural variation in process technology and manufacturing procedures, every specification of an amplifier will exhibit some amount of deviation from the ideal value, like an amplifier's input offset voltage. These deviations often follow *Gaussian* ("bell curve"), or *normal* distributions, and circuit designers can leverage this information to guardband their system, even when there is not a minimum or maximum specification in [セクション 6.7](#).

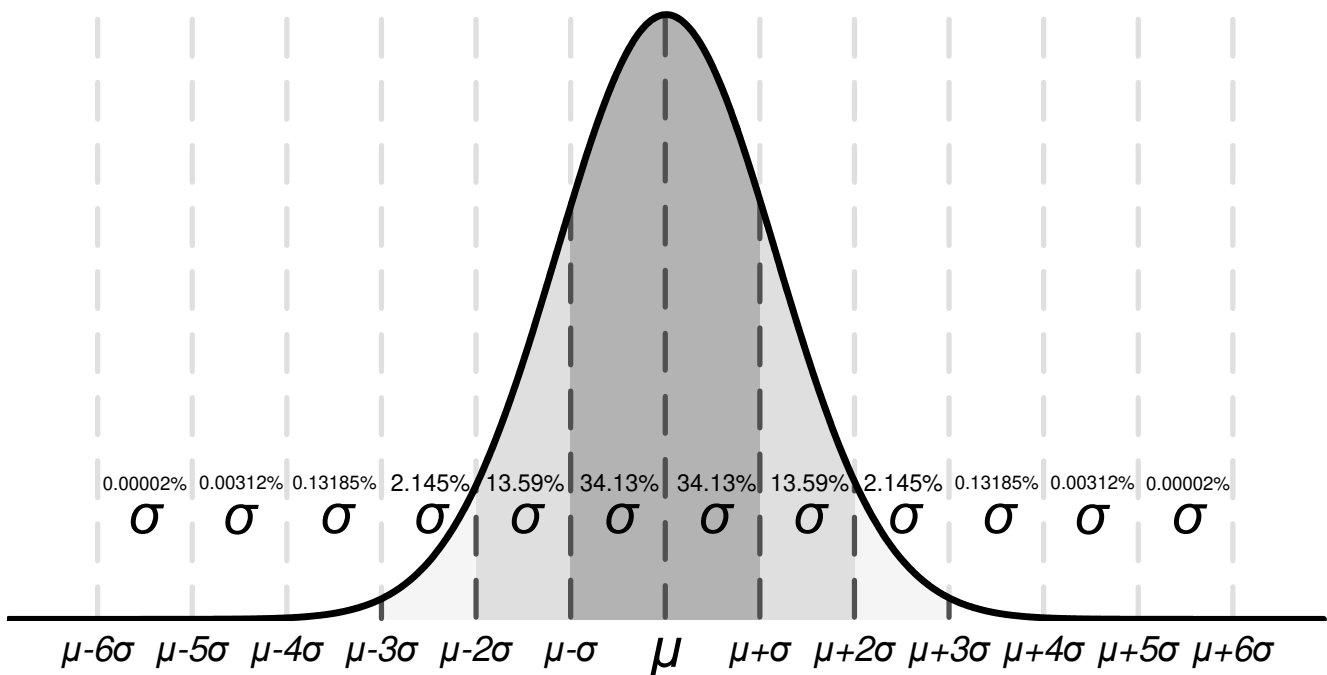

7-10. Ideal Gaussian Distribution

7-10 shows an example distribution, where  $\mu$ , or *mu*, is the mean of the distribution, and where  $\sigma$ , or *sigma*, is the standard deviation of a system. For a specification that exhibits this kind of distribution, approximately two-thirds (68.26%) of all units can be expected to have a value within one standard deviation, or one sigma, of the mean (from  $\mu - \sigma$  to  $\mu + \sigma$ ).

Depending on the specification, values listed in the *typical* column in [セクション 6.7](#) are represented in different ways. As a general rule of thumb, if a specification naturally has a nonzero mean (for example, like gain bandwidth), then the typical value is equal to the mean ( $\mu$ ). However, if a specification naturally has a mean near zero (like input offset voltage), then the typical value is equal to the mean plus one standard deviation ( $\mu + \sigma$ ) in order to most accurately represent the typical value.

You can use this chart to calculate approximate probability of a specification in a unit; for example, for TLV930x, the typical input voltage offset is 500  $\mu\text{V}$ , so 68.2% of all TLV930x devices are expected to have an offset from  $-500 \mu\text{V}$  to  $+500 \mu\text{V}$ . At  $4 \sigma$  ( $\pm 2000 \mu\text{V}$ ), 99.9937% of the distribution has an offset voltage less than  $\pm 2000 \mu\text{V}$ , which means 0.0063% of the population is outside of these limits, which corresponds to about 1 in 15,873 units.

Specifications with a value in the minimum or maximum column are assured by TI, and units outside these limits will be removed from production material. For example, the TLV930x family has a maximum offset voltage of 2.5 mV at 125°C, and even though this corresponds to  $5 \sigma$  ( $\approx 1$  in 1.7 million units), which is extremely unlikely, TI assures that any unit with larger offset than 2.5 mV will be removed from production material.

For specifications with no value in the minimum or maximum column, consider selecting a sigma value of sufficient guardband for your application, and design worst-case conditions using this value. For example, the  $6\sigma$  value corresponds to about 1 in 500 million units, which is an extremely unlikely chance, and could be an option as a wide guardband to design a system around. In this case, the TLV930x family does not have a maximum or minimum for offset voltage drift, but based on [Figure 6-2](#) and the typical value of  $2 \mu\text{V}/^\circ\text{C}$  in [Section 6.7](#), it can be calculated that the  $6\text{-}\sigma$  value for offset voltage drift is about  $12 \mu\text{V}/^\circ\text{C}$ . When designing for worst-case system conditions, this value can be used to estimate the worst possible offset across temperature without having an actual minimum or maximum value.

However, process variation and adjustments over time can shift typical means and standard deviations, and unless there is a value in the minimum or maximum specification column, TI cannot assure the performance of a device. This information should be used only to estimate the performance of a device.

## 7.4 Device Functional Modes

The TLV930x has a single functional mode and is operational when the power-supply voltage is greater than 4.5 V ( $\pm 2.25$  V). The maximum power supply voltage for the TLV930x is 40 V ( $\pm 20$  V).

## 8 Application and Implementation

### Note

以下のアプリケーション情報は、TI の製品仕様に含まれるものではなく、TI ではその正確性または完全性を保証いたしません。個々の目的に対する製品の適合性については、お客様の責任で判断していただくこととなります。お客様は自身の設計実装を検証しテストすることで、システムの機能を確認する必要があります。

### 8.1 Application Information

The TLV930x family offers excellent DC precision and DC performance. These devices operate up to 40-V supply rails and offer true rail-to-rail input/output, low offset voltage and offset voltage drift, as well as 1-MHz bandwidth and high output drive. These features make the TLV930x a robust, high-performance operational amplifier for high-voltage industrial applications.

### 8.2 Typical Applications

#### 8.2.1 High Voltage Precision Comparator

Many different systems require controlled voltages across numerous system nodes to ensure robust operation. A comparator can be used to monitor and control voltages by comparing a reference threshold voltage with an input voltage and providing an output when the input crosses this threshold.

The TLV930x family of op amps make excellent high voltage comparators due to their MUX-friendly input stage (see [セクション 7.3.1](#)). Previous generation high-voltage op amps often use back-to-back diodes across the inputs to prevent damage to the op amp which greatly limits these op amps to be used as comparators, but the TLV930x's patented input stage allows the device to have a wide differential voltage between the inputs.



図 8-1. Typical Comparator Application

#### 8.2.1.1 Design Requirements

The primary objective is to design a 40-V precision comparator.

- System supply voltage ( $V_+$ ): 40 V
- Resistor 1 value: 100 k $\Omega$
- Resistor 2 value: 100 k $\Omega$
- Reference threshold voltage ( $V_{TH}$ ): 20 V
- Input voltage range ( $V_{IN}$ ): 0 V – 40 V
- Output voltage range ( $V_{OUT}$ ): 0 V – 40 V

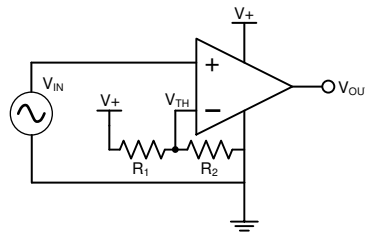
### 8.2.1.2 Detailed Design Procedure

This noninverting comparator circuit applies the input voltage ( $V_{IN}$ ) to the noninverting terminal of the op amp. Two resistors ( $R_1$  and  $R_2$ ) divide the supply voltage ( $V_+$ ) to create a mid-supply threshold voltage ( $V_{TH}$ ) as calculated in 式 1. The circuit is shown in 图 8-1. When  $V_{IN}$  is less than  $V_{TH}$ , the output voltage transitions to the negative supply and equals the low-level output voltage. When  $V_{IN}$  is greater than  $V_{TH}$ , the output voltage transitions to the positive supply and equals the high-level output voltage.

In this example, resistor 1 and 2 have been selected to be 100 k $\Omega$ , which sets the reference threshold at 20 V. However, resistor 1 and 2 can be adjusted to modify the threshold using 式 1. Resistor 1 and 2's values have also been selected to reduce power consumption, but these values can be further increased to reduce power consumption, or reduced to improve noise performance.

$$V_{TH} = \frac{R_2}{R_1 + R_2} \times V_+ \quad (1)$$

### 8.2.1.3 Application Curve



图 8-2. Comparator Output Response to Input Voltage

## 9 Power Supply Recommendations

The TLV930x is specified for operation from 4.5 V to 40 V ( $\pm 2.25$  V to  $\pm 20$  V); many specifications apply from  $-40^{\circ}\text{C}$  to  $125^{\circ}\text{C}$ . Parameters that can exhibit significant variance with regard to operating voltage or temperature are presented in [セクション 6.7](#).

### CAUTION

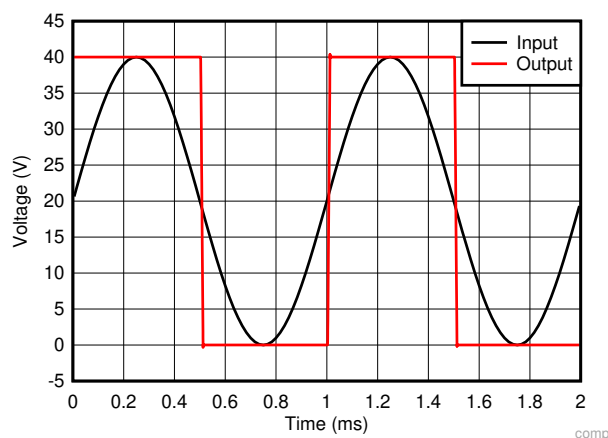
Supply voltages larger than 40 V can permanently damage the device; see the [Absolute Maximum Ratings](#) table.

Place 0.1- $\mu\text{F}$  bypass capacitors close to the power-supply pins to reduce errors coupling in from noisy or high-impedance power supplies. For more detailed information on bypass capacitor placement, refer to [セクション 10](#).

## 10 Layout

### 10.1 Layout Guidelines

For best operational performance of the device, use good PCB layout practices, including:

- Noise can propagate into analog circuitry through the power pins of the circuit as a whole and op amp itself. Bypass capacitors are used to reduce the coupled noise by providing low-impedance power sources local to the analog circuitry.
  - Connect low-ESR, 0.1- $\mu\text{F}$  ceramic bypass capacitors between each supply pin and ground, placed as close to the device as possible. A single bypass capacitor from V+ to ground is applicable for single-supply applications.
- Separate grounding for analog and digital portions of circuitry is one of the simplest and most-effective methods of noise suppression. One or more layers on multilayer PCBs are usually devoted to ground planes. A ground plane helps distribute heat and reduces EMI noise pickup. Make sure to physically separate digital and analog grounds paying attention to the flow of the ground current.
- In order to reduce parasitic coupling, run the input traces as far away from the supply or output traces as possible. If these traces cannot be kept separate, crossing the sensitive trace perpendicular is much better as opposed to in parallel with the noisy trace.
- Place the external components as close to the device as possible. As illustrated in [図 10-2](#), keeping RF and RG close to the inverting input minimizes parasitic capacitance.
- Keep the length of input traces as short as possible. Always remember that the input traces are the most sensitive part of the circuit.
- Consider a driven, low-impedance guard ring around the critical traces. A guard ring can significantly reduce leakage currents from nearby traces that are at different potentials.
- Cleaning the PCB following board assembly is recommended for best performance.
- Any precision integrated circuit may experience performance shifts due to moisture ingress into the plastic package. Following any aqueous PCB cleaning process, baking the PCB assembly is recommended to remove moisture introduced into the device packaging during the cleaning process. A low temperature, post cleaning bake at  $85^{\circ}\text{C}$  for 30 minutes is sufficient for most circumstances.

### 10.2 Layout Example

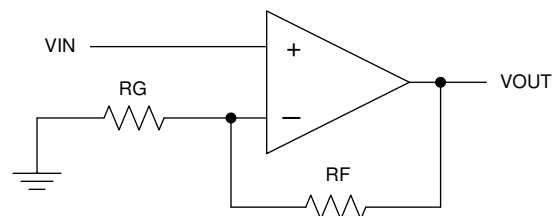

**图 10-1. Schematic Representation**

**TLV9301, TLV9302, TLV9304**

JAJ5FF0D – FEBRUARY 2019 – REVISED AUGUST 2021

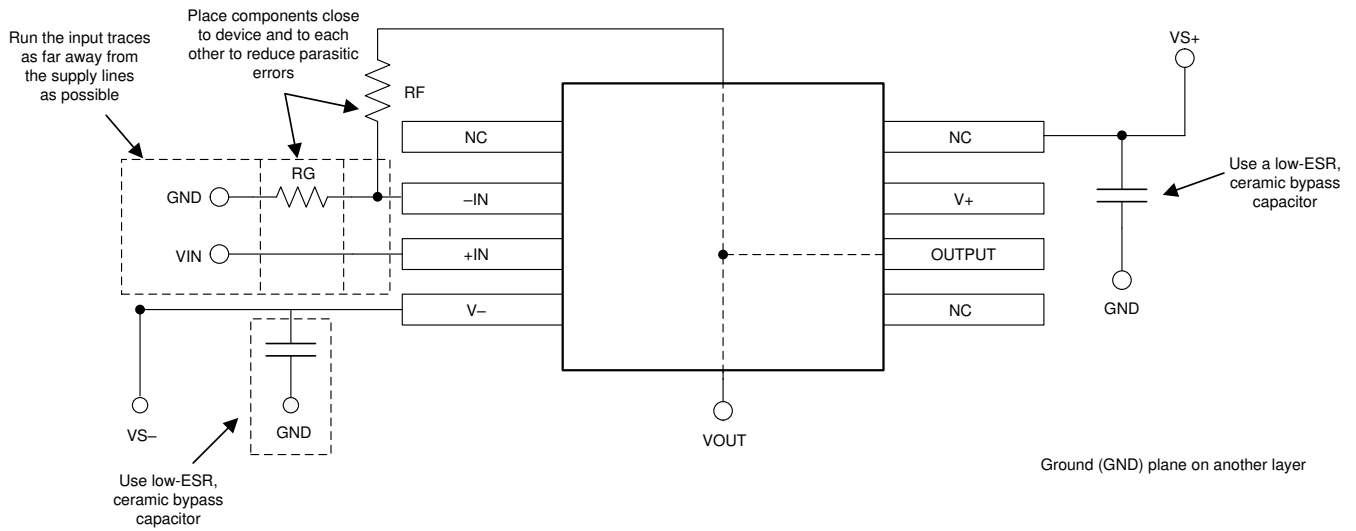

**10-2. Operational Amplifier Board Layout for Noninverting Configuration**

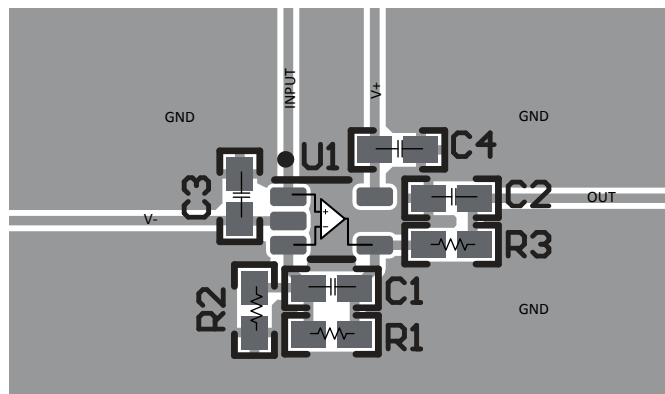

**10-3. Example Layout for SC70 (DCK) Package**

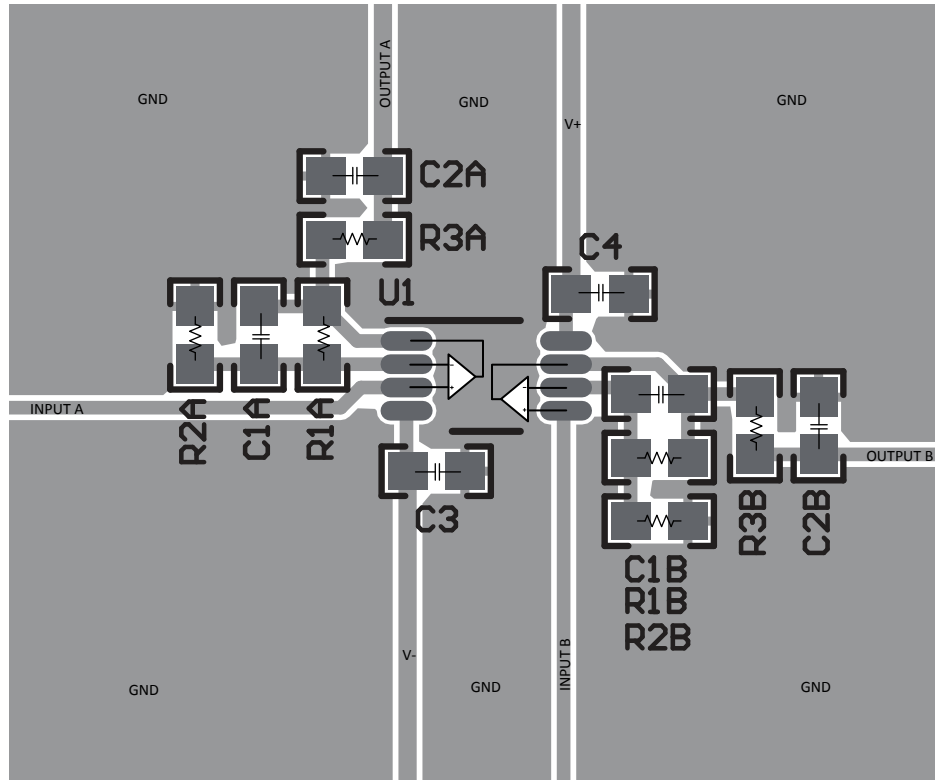

**10-4. Example Layout for VSSOP-8 (DGK) Package**

## 11 Device and Documentation Support

### 11.1 Device Support

#### 11.1.1 Development Support

##### 11.1.1.1 TINA-TI™ (Free Software Download)

TINA™ is a simple, powerful, and easy-to-use circuit simulation program based on a SPICE engine. TINA-TI is a free, fully-functional version of the TINA software, preloaded with a library of macro models in addition to a range of both passive and active models. TINA-TI provides all the conventional dc, transient, and frequency domain analysis of SPICE, as well as additional design capabilities.

Available as a [free download](#) from the Analog eLab Design Center, TINA-TI offers extensive post-processing capability that allows users to format results in a variety of ways. Virtual instruments offer the ability to select input waveforms and probe circuit nodes, voltages, and waveforms, creating a dynamic quick-start tool.

---

#### Note

These files require that either the TINA software (from DesignSoft™) or TINA-TI software be installed. Download the free TINA-TI software from the [TINA-TI folder](#).

---

##### 11.1.1.2 TI Precision Designs

The TLV930x is featured in several TI Precision Designs, available online at <http://www.ti.com/ww/en/analog/precision-designs/>. TI Precision Designs are analog solutions created by TI's precision analog applications experts and offer the theory of operation, component selection, simulation, complete PCB schematic and layout, bill of materials, and measured performance of many useful circuits.

### 11.2 Documentation Support

#### 11.2.1 Related Documentation

Texas Instruments, [EMI Rejection Ratio of Operational Amplifiers application report](#)

Texas Instruments, [Capacitive Load Drive Solution using an Isolation Resistor reference design](#)

### 11.3 Receiving Notification of Documentation Updates

To receive notification of documentation updates, navigate to the device product folder on [ti.com](http://ti.com). Click on *Subscribe to updates* to register and receive a weekly digest of any product information that has changed. For change details, review the revision history included in any revised document.

### 11.4 サポート・リソース

[TI E2E™ サポート・フォーラム](#)は、エンジニアが検証済みの回答と設計に関するヒントをエキスパートから迅速かつ直接得ることができる場所です。既存の回答を検索したり、独自の質問をしたりすることで、設計に必要な支援を迅速に得ることができます。

リンクされているコンテンツは、該当する貢献者により、現状のまま提供されるものです。これらは TI の仕様を構成するものではなく、必ずしも TI の見解を反映したものではありません。TI の[使用条件](#)を参照してください。

### 11.5 Trademarks

TINA-TI™ are trademarks of Texas Instruments, Inc and DesignSoft, Inc.

TINA™ and DesignSoft™ are trademarks of DesignSoft, Inc.

TI E2E™ is a trademark of Texas Instruments.

Bluetooth® is a registered trademark of Bluetooth SIG, Inc.

すべての商標は、それぞれの所有者に帰属します。

## 11.6 Electrostatic Discharge Caution



This integrated circuit can be damaged by ESD. Texas Instruments recommends that all integrated circuits be handled with appropriate precautions. Failure to observe proper handling and installation procedures can cause damage.

ESD damage can range from subtle performance degradation to complete device failure. Precision integrated circuits may be more susceptible to damage because very small parametric changes could cause the device not to meet its published specifications.

## 11.7 Glossary

[TI Glossary](#) This glossary lists and explains terms, acronyms, and definitions.

## 12 Mechanical, Packaging, and Orderable Information

The following pages include mechanical, packaging, and orderable information. This information is the most current data available for the designated devices. This data is subject to change without notice and revision of this document. For browser-based versions of this data sheet, refer to the left-hand navigation.

**PACKAGING INFORMATION**

| Orderable part number        | Status<br>(1) | Material type<br>(2) | Package   Pins        | Package qty   Carrier | RoHS<br>(3) | Lead finish/<br>Ball material<br>(4) | MSL rating/<br>Peak reflow<br>(5) | Op temp (°C) | Part marking<br>(6) |
|------------------------------|---------------|----------------------|-----------------------|-----------------------|-------------|--------------------------------------|-----------------------------------|--------------|---------------------|
| <a href="#">TLV9301IDBVR</a> | Active        | Production           | SOT-23 (DBV)   5      | 3000   LARGE T&R      | Yes         | NIPDAU   SN                          | Level-1-260C-UNLIM                | -40 to 125   | T93V                |
| TLV9301IDBVR.A               | Active        | Production           | SOT-23 (DBV)   5      | 3000   LARGE T&R      | Yes         | NIPDAU                               | Level-1-260C-UNLIM                | -40 to 125   | T93V                |
| <a href="#">TLV9301IDCKR</a> | Active        | Production           | SC70 (DCK)   5        | 3000   LARGE T&R      | Yes         | SN                                   | Level-2-260C-1 YEAR               | -40 to 125   | 1FN                 |
| TLV9301IDCKR.A               | Active        | Production           | SC70 (DCK)   5        | 3000   LARGE T&R      | Yes         | SN                                   | Level-2-260C-1 YEAR               | -40 to 125   | 1FN                 |
| <a href="#">TLV9302IDDFR</a> | Active        | Production           | SOT-23-THIN (DDF)   8 | 3000   LARGE T&R      | Yes         | NIPDAU                               | Level-1-260C-UNLIM                | -40 to 125   | T93F                |
| TLV9302IDDFR.A               | Active        | Production           | SOT-23-THIN (DDF)   8 | 3000   LARGE T&R      | Yes         | NIPDAU                               | Level-1-260C-UNLIM                | -40 to 125   | T93F                |
| TLV9302IDDFRG4               | Active        | Production           | SOT-23-THIN (DDF)   8 | 3000   LARGE T&R      | Yes         | NIPDAU                               | Level-1-260C-UNLIM                | -40 to 125   | T93F                |
| TLV9302IDDFRG4.A             | Active        | Production           | SOT-23-THIN (DDF)   8 | 3000   LARGE T&R      | Yes         | NIPDAU                               | Level-1-260C-UNLIM                | -40 to 125   | T93F                |
| <a href="#">TLV9302IDGKR</a> | Active        | Production           | VSSOP (DGK)   8       | 2500   LARGE T&R      | Yes         | NIPDAU   SN                          | Level-1-260C-UNLIM                | -40 to 125   | (2HAT, T932)        |
| TLV9302IDGKR.A               | Active        | Production           | VSSOP (DGK)   8       | 2500   LARGE T&R      | Yes         | NIPDAU                               | Level-1-260C-UNLIM                | -40 to 125   | (2HAT, T932)        |
| <a href="#">TLV9302IDR</a>   | Active        | Production           | SOIC (D)   8          | 2500   LARGE T&R      | Yes         | NIPDAU                               | Level-1-260C-UNLIM                | -40 to 125   | T9302D              |
| TLV9302IDR.A                 | Active        | Production           | SOIC (D)   8          | 2500   LARGE T&R      | Yes         | NIPDAU                               | Level-1-260C-UNLIM                | -40 to 125   | T9302D              |
| TLV9302IDRG4                 | Active        | Production           | SOIC (D)   8          | 2500   LARGE T&R      | Yes         | NIPDAU                               | Level-1-260C-UNLIM                | -40 to 125   | T9302D              |
| TLV9302IDRG4.A               | Active        | Production           | SOIC (D)   8          | 2500   LARGE T&R      | Yes         | NIPDAU                               | Level-1-260C-UNLIM                | -40 to 125   | T9302D              |
| <a href="#">TLV9302IPWR</a>  | Active        | Production           | TSSOP (PW)   8        | 2000   LARGE T&R      | Yes         | NIPDAU                               | Level-1-260C-UNLIM                | -40 to 125   | T9302P              |
| TLV9302IPWR.A                | Active        | Production           | TSSOP (PW)   8        | 2000   LARGE T&R      | Yes         | NIPDAU                               | Level-1-260C-UNLIM                | -40 to 125   | T9302P              |
| <a href="#">TLV9304IDR</a>   | Active        | Production           | SOIC (D)   14         | 2500   LARGE T&R      | Yes         | NIPDAU                               | Level-1-260C-UNLIM                | -40 to 125   | TLV9304D            |
| TLV9304IDR.A                 | Active        | Production           | SOIC (D)   14         | 2500   LARGE T&R      | Yes         | NIPDAU                               | Level-1-260C-UNLIM                | -40 to 125   | TLV9304D            |
| <a href="#">TLV9304IPWR</a>  | Active        | Production           | TSSOP (PW)   14       | 2000   LARGE T&R      | Yes         | SN                                   | Level-2-260C-1 YEAR               | -40 to 125   | (PTL93PW, T9304PW)  |
| TLV9304IPWR.A                | Active        | Production           | TSSOP (PW)   14       | 2000   LARGE T&R      | Yes         | SN                                   | Level-2-260C-1 YEAR               | -40 to 125   | (PTL93PW, T9304PW)  |

<sup>(1)</sup> **Status:** For more details on status, see our [product life cycle](#).

<sup>(2)</sup> **Material type:** When designated, preproduction parts are prototypes/experimental devices, and are not yet approved or released for full production. Testing and final process, including without limitation quality assurance, reliability performance testing, and/or process qualification, may not yet be complete, and this item is subject to further changes or possible discontinuation. If available for ordering, purchases will be subject to an additional waiver at checkout, and are intended for early internal evaluation purposes only. These items are sold without warranties of any kind.

<sup>(3)</sup> **RoHS values:** Yes, No, RoHS Exempt. See the [TI RoHS Statement](#) for additional information and value definition.

- (4) **Lead finish/Ball material:** Parts may have multiple material finish options. Finish options are separated by a vertical ruled line. Lead finish/Ball material values may wrap to two lines if the finish value exceeds the maximum column width.
- (5) **MSL rating/Peak reflow:** The moisture sensitivity level ratings and peak solder (reflow) temperatures. In the event that a part has multiple moisture sensitivity ratings, only the lowest level per JEDEC standards is shown. Refer to the shipping label for the actual reflow temperature that will be used to mount the part to the printed circuit board.
- (6) **Part marking:** There may be an additional marking, which relates to the logo, the lot trace code information, or the environmental category of the part.

Multiple part markings will be inside parentheses. Only one part marking contained in parentheses and separated by a "~" will appear on a part. If a line is indented then it is a continuation of the previous line and the two combined represent the entire part marking for that device.

**Important Information and Disclaimer:**The information provided on this page represents TI's knowledge and belief as of the date that it is provided. TI bases its knowledge and belief on information provided by third parties, and makes no representation or warranty as to the accuracy of such information. Efforts are underway to better integrate information from third parties. TI has taken and continues to take reasonable steps to provide representative and accurate information but may not have conducted destructive testing or chemical analysis on incoming materials and chemicals. TI and TI suppliers consider certain information to be proprietary, and thus CAS numbers and other limited information may not be available for release.

In no event shall TI's liability arising out of such information exceed the total purchase price of the TI part(s) at issue in this document sold by TI to Customer on an annual basis.

**OTHER QUALIFIED VERSIONS OF TLV9304 :**

- Automotive : [TLV9304-Q1](#)

NOTE: Qualified Version Definitions:

- Automotive - Q100 devices qualified for high-reliability automotive applications targeting zero defects

**TAPE AND REEL INFORMATION**

**QUADRANT ASSIGNMENTS FOR PIN 1 ORIENTATION IN TAPE**

\*All dimensions are nominal

| Device         | Package Type | Package Drawing | Pins | SPQ  | Reel Diameter (mm) | Reel Width W1 (mm) | A0 (mm) | B0 (mm) | K0 (mm) | P1 (mm) | W (mm) | Pin1 Quadrant |
|----------------|--------------|-----------------|------|------|--------------------|--------------------|---------|---------|---------|---------|--------|---------------|
| TLV9301IDBVR   | SOT-23       | DBV             | 5    | 3000 | 178.0              | 8.4                | 3.2     | 3.2     | 1.4     | 4.0     | 8.0    | Q3            |
| TLV9301IDCKR   | SC70         | DCK             | 5    | 3000 | 178.0              | 8.4                | 2.25    | 2.45    | 1.2     | 4.0     | 8.0    | Q3            |
| TLV9301IDCKR   | SC70         | DCK             | 5    | 3000 | 180.0              | 8.4                | 2.3     | 2.5     | 1.2     | 4.0     | 8.0    | Q3            |
| TLV9302IDDFR   | SOT-23-THIN  | DDF             | 8    | 3000 | 180.0              | 8.4                | 3.2     | 3.2     | 1.4     | 4.0     | 8.0    | Q3            |
| TLV9302IDDFRG4 | SOT-23-THIN  | DDF             | 8    | 3000 | 180.0              | 8.4                | 3.2     | 3.2     | 1.4     | 4.0     | 8.0    | Q3            |
| TLV9302IDGKR   | VSSOP        | DGK             | 8    | 2500 | 330.0              | 12.4               | 5.3     | 3.4     | 1.4     | 8.0     | 12.0   | Q1            |
| TLV9302IDGKR   | VSSOP        | DGK             | 8    | 2500 | 330.0              | 12.4               | 5.3     | 3.4     | 1.4     | 8.0     | 12.0   | Q1            |
| TLV9302IDR     | SOIC         | D               | 8    | 2500 | 330.0              | 12.4               | 6.4     | 5.2     | 2.1     | 8.0     | 12.0   | Q1            |
| TLV9302IDRG4   | SOIC         | D               | 8    | 2500 | 330.0              | 12.4               | 6.4     | 5.2     | 2.1     | 8.0     | 12.0   | Q1            |
| TLV9302IPWR    | TSSOP        | PW              | 8    | 2000 | 330.0              | 12.4               | 7.0     | 3.6     | 1.6     | 8.0     | 12.0   | Q1            |
| TLV9304IDR     | SOIC         | D               | 14   | 2500 | 330.0              | 16.4               | 6.5     | 9.0     | 2.1     | 8.0     | 16.0   | Q1            |
| TLV9304IPWR    | TSSOP        | PW              | 14   | 2000 | 330.0              | 12.4               | 6.9     | 5.6     | 1.6     | 8.0     | 12.0   | Q1            |

**TAPE AND REEL BOX DIMENSIONS**

\*All dimensions are nominal

| Device         | Package Type | Package Drawing | Pins | SPQ  | Length (mm) | Width (mm) | Height (mm) |
|----------------|--------------|-----------------|------|------|-------------|------------|-------------|
| TLV9301IDBVR   | SOT-23       | DBV             | 5    | 3000 | 208.0       | 191.0      | 35.0        |
| TLV9301IDCKR   | SC70         | DCK             | 5    | 3000 | 208.0       | 191.0      | 35.0        |
| TLV9301IDCKR   | SC70         | DCK             | 5    | 3000 | 210.0       | 185.0      | 35.0        |
| TLV9302IDDFR   | SOT-23-THIN  | DDF             | 8    | 3000 | 210.0       | 185.0      | 35.0        |
| TLV9302IDDFRG4 | SOT-23-THIN  | DDF             | 8    | 3000 | 210.0       | 185.0      | 35.0        |
| TLV9302IDGKR   | VSSOP        | DGK             | 8    | 2500 | 353.0       | 353.0      | 32.0        |
| TLV9302IDGKR   | VSSOP        | DGK             | 8    | 2500 | 367.0       | 367.0      | 35.0        |
| TLV9302IDR     | SOIC         | D               | 8    | 2500 | 353.0       | 353.0      | 32.0        |
| TLV9302IDRG4   | SOIC         | D               | 8    | 2500 | 353.0       | 353.0      | 32.0        |
| TLV9302IPWR    | TSSOP        | PW              | 8    | 2000 | 353.0       | 353.0      | 32.0        |
| TLV9304IDR     | SOIC         | D               | 14   | 2500 | 353.0       | 353.0      | 32.0        |
| TLV9304IPWR    | TSSOP        | PW              | 14   | 2000 | 366.0       | 364.0      | 50.0        |



# EXAMPLE BOARD LAYOUT

DCK0005A

SOT - 1.1 max height

SMALL OUTLINE TRANSISTOR



LAND PATTERN EXAMPLE  
EXPOSED METAL SHOWN  
SCALE:18X



SOLDER MASK DETAILS

4214834/G 11/2024

NOTES: (continued)

- 7. Publication IPC-7351 may have alternate designs.
- 8. Solder mask tolerances between and around signal pads can vary based on board fabrication site.

# EXAMPLE STENCIL DESIGN

DCK0005A

SOT - 1.1 max height

SMALL OUTLINE TRANSISTOR



SOLDER PASTE EXAMPLE  
BASED ON 0.125 THICK STENCIL  
SCALE: 18X

4214834/G 11/2024

NOTES: (continued)

9. Laser cutting apertures with trapezoidal walls and rounded corners may offer better paste release. IPC-7525 may have alternate design recommendations.
10. Board assembly site may have different recommendations for stencil design.

# DDF0008A



# PACKAGE OUTLINE

## SOT-23-THIN - 1.1 mm max height

PLASTIC SMALL OUTLINE



### NOTES:

1. All linear dimensions are in millimeters. Any dimensions in parenthesis are for reference only. Dimensioning and tolerancing per ASME Y14.5M.
2. This drawing is subject to change without notice.
3. This dimension does not include mold flash, protrusions, or gate burrs. Mold flash, protrusions, or gate burrs shall not exceed 0.15 mm per side.

# EXAMPLE BOARD LAYOUT

DDF0008A

SOT-23-THIN - 1.1 mm max height

PLASTIC SMALL OUTLINE

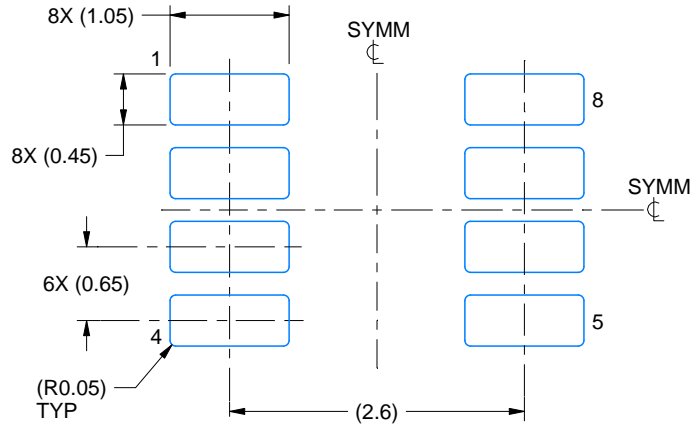

LAND PATTERN EXAMPLE  
EXPOSED METAL SHOWN  
SCALE:15X

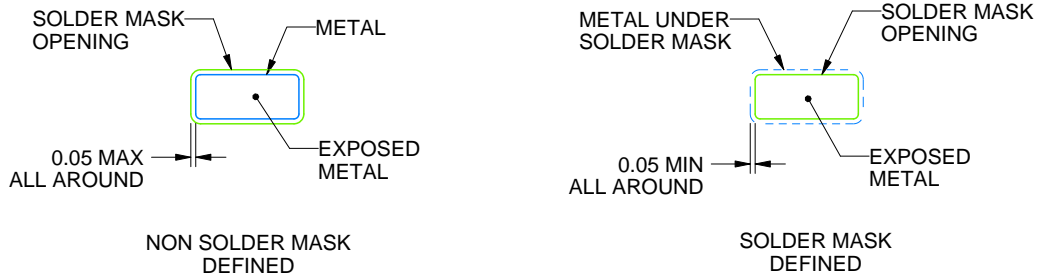

SOLDER MASK DETAILS

4222047/E 07/2024

NOTES: (continued)

- 4. Publication IPC-7351 may have alternate designs.
- 5. Solder mask tolerances between and around signal pads can vary based on board fabrication site.

# EXAMPLE STENCIL DESIGN

DDF0008A

SOT-23-THIN - 1.1 mm max height

PLASTIC SMALL OUTLINE



SOLDER PASTE EXAMPLE  
BASED ON 0.125 mm THICK STENCIL  
SCALE:15X

4222047/E 07/2024

NOTES: (continued)

6. Laser cutting apertures with trapezoidal walls and rounded corners may offer better paste release. IPC-7525 may have alternate design recommendations.
7. Board assembly site may have different recommendations for stencil design.



D0008A

# PACKAGE OUTLINE

## SOIC - 1.75 mm max height

SMALL OUTLINE INTEGRATED CIRCUIT



4214825/C 02/2019

### NOTES:

1. Linear dimensions are in inches [millimeters]. Dimensions in parenthesis are for reference only. Controlling dimensions are in inches. Dimensioning and tolerancing per ASME Y14.5M.
2. This drawing is subject to change without notice.
3. This dimension does not include mold flash, protrusions, or gate burrs. Mold flash, protrusions, or gate burrs shall not exceed  $.006$  [0.15] per side.
4. This dimension does not include interlead flash.
5. Reference JEDEC registration MS-012, variation AA.

# EXAMPLE BOARD LAYOUT

D0008A

SOIC - 1.75 mm max height

SMALL OUTLINE INTEGRATED CIRCUIT



LAND PATTERN EXAMPLE  
EXPOSED METAL SHOWN  
SCALE:8X



SOLDER MASK DETAILS

4214825/C 02/2019

NOTES: (continued)

- 6. Publication IPC-7351 may have alternate designs.
- 7. Solder mask tolerances between and around signal pads can vary based on board fabrication site.

# EXAMPLE STENCIL DESIGN

D0008A

SOIC - 1.75 mm max height

SMALL OUTLINE INTEGRATED CIRCUIT



SOLDER PASTE EXAMPLE  
BASED ON .005 INCH [0.125 MM] THICK STENCIL  
SCALE:8X

4214825/C 02/2019

NOTES: (continued)

8. Laser cutting apertures with trapezoidal walls and rounded corners may offer better paste release. IPC-7525 may have alternate design recommendations.
9. Board assembly site may have different recommendations for stencil design.

PW0014A



# PACKAGE OUTLINE

## TSSOP - 1.2 mm max height

SMALL OUTLINE PACKAGE

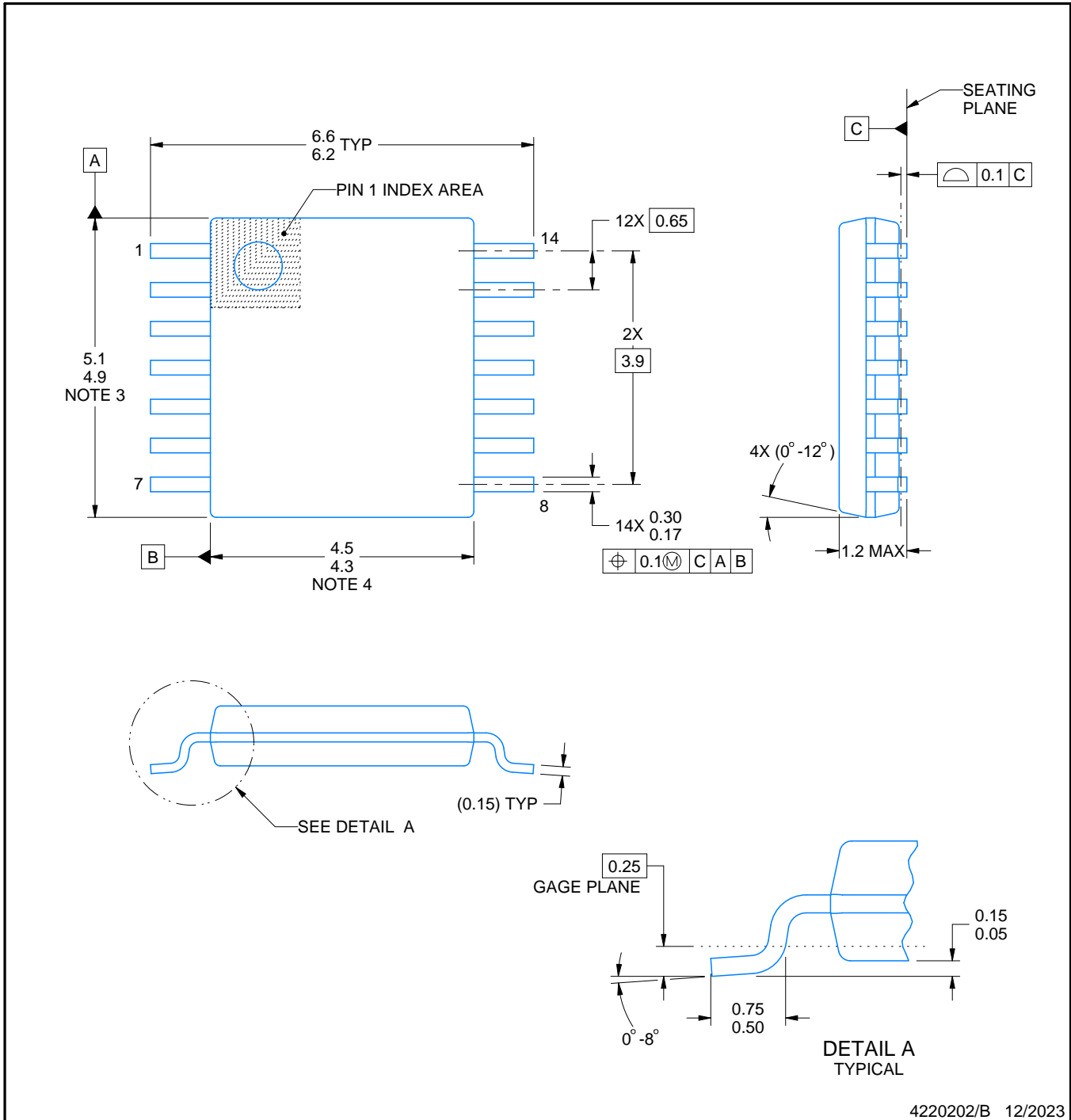

4220202/B 12/2023

### NOTES:

1. All linear dimensions are in millimeters. Any dimensions in parenthesis are for reference only. Dimensioning and tolerancing per ASME Y14.5M.
2. This drawing is subject to change without notice.
3. This dimension does not include mold flash, protrusions, or gate burrs. Mold flash, protrusions, or gate burrs shall not exceed 0.15 mm per side.
4. This dimension does not include interlead flash. Interlead flash shall not exceed 0.25 mm per side.
5. Reference JEDEC registration MO-153.

# EXAMPLE BOARD LAYOUT

PW0014A

TSSOP - 1.2 mm max height

SMALL OUTLINE PACKAGE



LAND PATTERN EXAMPLE  
EXPOSED METAL SHOWN  
SCALE: 10X



4220202/B 12/2023

NOTES: (continued)

- 6. Publication IPC-7351 may have alternate designs.
- 7. Solder mask tolerances between and around signal pads can vary based on board fabrication site.

# EXAMPLE STENCIL DESIGN

PW0014A

TSSOP - 1.2 mm max height

SMALL OUTLINE PACKAGE



SOLDER PASTE EXAMPLE  
BASED ON 0.125 mm THICK STENCIL  
SCALE: 10X

4220202/B 12/2023

NOTES: (continued)

8. Laser cutting apertures with trapezoidal walls and rounded corners may offer better paste release. IPC-7525 may have alternate design recommendations.
9. Board assembly site may have different recommendations for stencil design.

PW0008A



# PACKAGE OUTLINE

TSSOP - 1.2 mm max height

SMALL OUTLINE PACKAGE

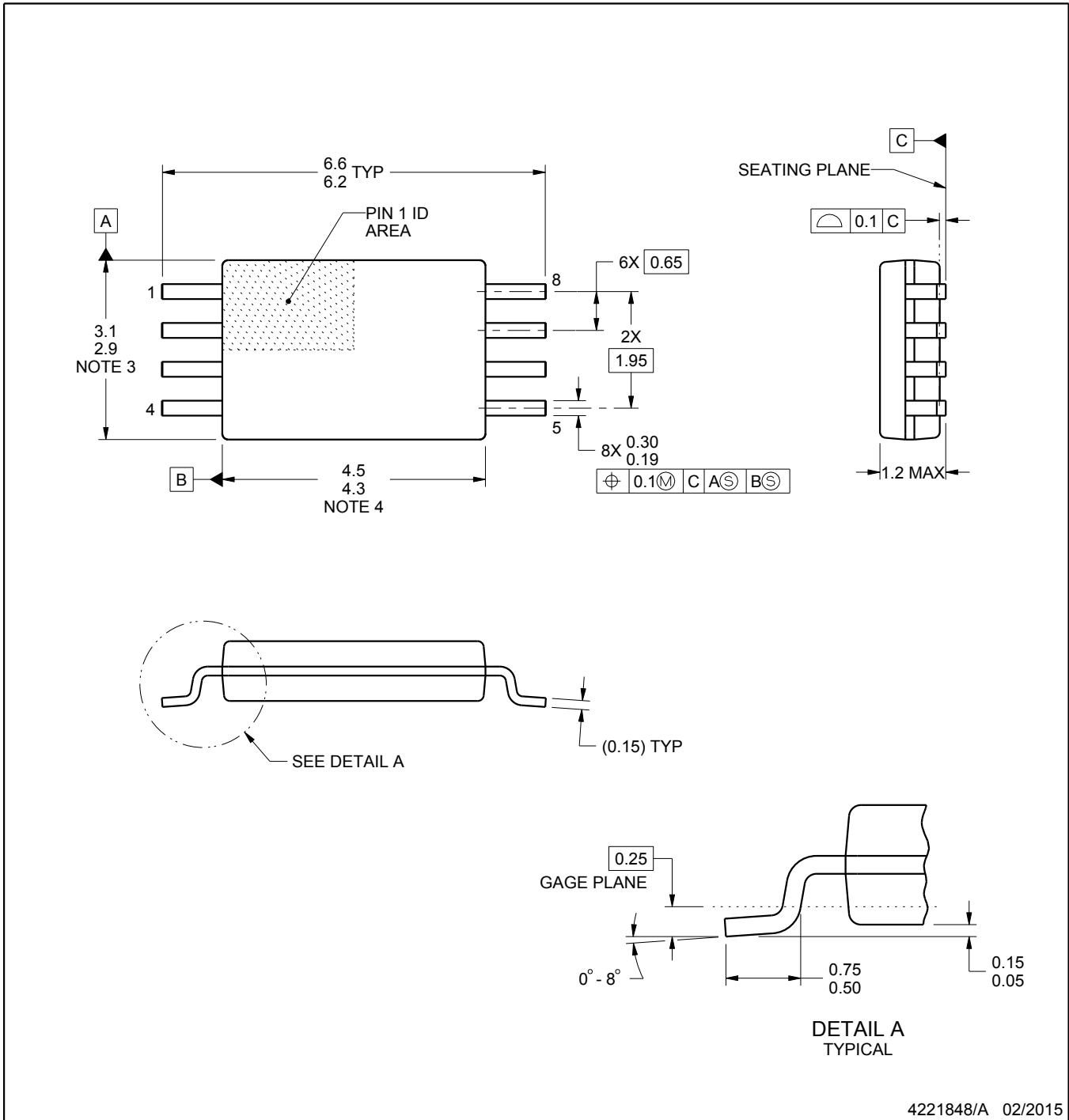

4221848/A 02/2015

NOTES:

1. All linear dimensions are in millimeters. Any dimensions in parenthesis are for reference only. Dimensioning and tolerancing per ASME Y14.5M.
2. This drawing is subject to change without notice.
3. This dimension does not include mold flash, protrusions, or gate burrs. Mold flash, protrusions, or gate burrs shall not exceed 0.15 mm per side.
4. This dimension does not include interlead flash. Interlead flash shall not exceed 0.25 mm per side.
5. Reference JEDEC registration MO-153, variation AA.

# EXAMPLE BOARD LAYOUT

PW0008A

TSSOP - 1.2 mm max height

SMALL OUTLINE PACKAGE

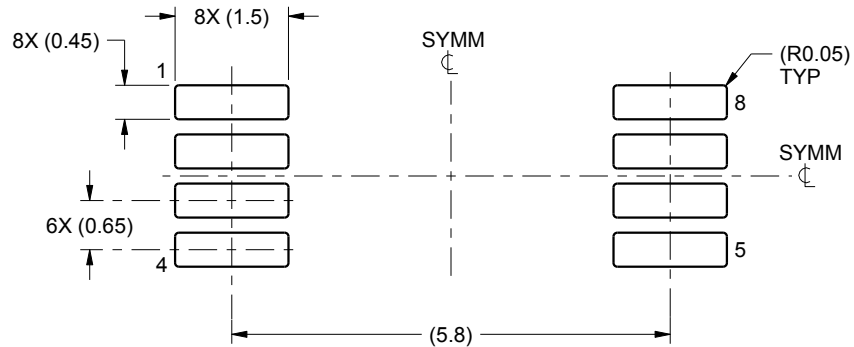

LAND PATTERN EXAMPLE  
SCALE:10X



SOLDER MASK DETAILS  
NOT TO SCALE

4221848/A 02/2015

NOTES: (continued)

- 6. Publication IPC-7351 may have alternate designs.
- 7. Solder mask tolerances between and around signal pads can vary based on board fabrication site.

# EXAMPLE STENCIL DESIGN

PW0008A

TSSOP - 1.2 mm max height

SMALL OUTLINE PACKAGE



SOLDER PASTE EXAMPLE  
BASED ON 0.125 mm THICK STENCIL  
SCALE:10X

4221848/A 02/2015

NOTES: (continued)

8. Laser cutting apertures with trapezoidal walls and rounded corners may offer better paste release. IPC-7525 may have alternate design recommendations.
9. Board assembly site may have different recommendations for stencil design.



# EXAMPLE BOARD LAYOUT

DBV0005A

SOT-23 - 1.45 mm max height

SMALL OUTLINE TRANSISTOR



LAND PATTERN EXAMPLE  
EXPOSED METAL SHOWN  
SCALE:15X



SOLDER MASK DETAILS

4214839/K 08/2024

NOTES: (continued)

- 6. Publication IPC-7351 may have alternate designs.
- 7. Solder mask tolerances between and around signal pads can vary based on board fabrication site.

# EXAMPLE STENCIL DESIGN

DBV0005A

SOT-23 - 1.45 mm max height

SMALL OUTLINE TRANSISTOR



SOLDER PASTE EXAMPLE  
BASED ON 0.125 mm THICK STENCIL  
SCALE:15X

4214839/K 08/2024

NOTES: (continued)

8. Laser cutting apertures with trapezoidal walls and rounded corners may offer better paste release. IPC-7525 may have alternate design recommendations.
9. Board assembly site may have different recommendations for stencil design.

DGK0008A

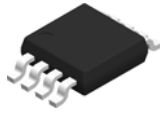

# PACKAGE OUTLINE

VSSOP - 1.1 mm max height

SMALL OUTLINE PACKAGE



4214862/A 04/2023

NOTES:

PowerPAD is a trademark of Texas Instruments.

1. All linear dimensions are in millimeters. Any dimensions in parenthesis are for reference only. Dimensioning and tolerancing per ASME Y14.5M.
2. This drawing is subject to change without notice.
3. This dimension does not include mold flash, protrusions, or gate burrs. Mold flash, protrusions, or gate burrs shall not exceed 0.15 mm per side.
4. This dimension does not include interlead flash. Interlead flash shall not exceed 0.25 mm per side.
5. Reference JEDEC registration MO-187.

# EXAMPLE BOARD LAYOUT

DGK0008A

™ VSSOP - 1.1 mm max height

SMALL OUTLINE PACKAGE

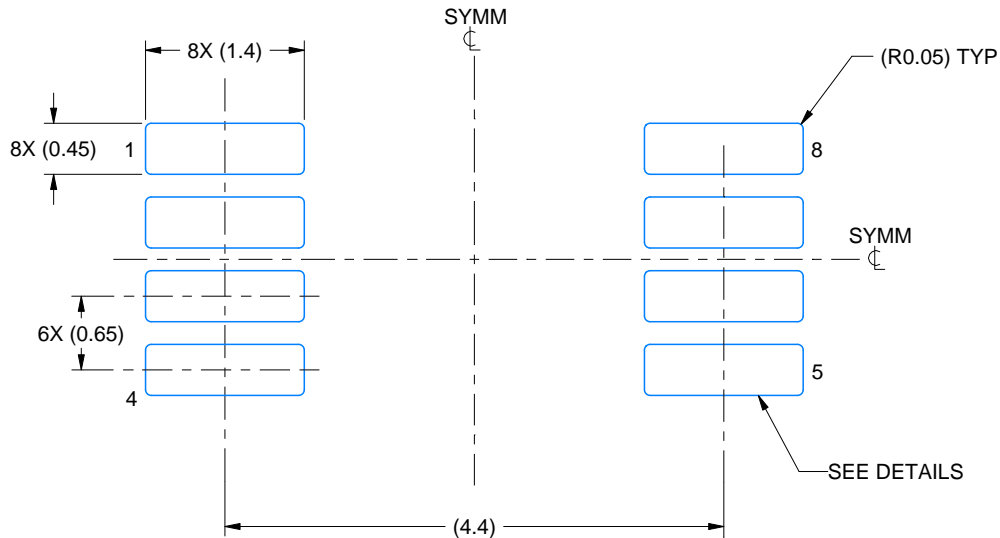

LAND PATTERN EXAMPLE  
EXPOSED METAL SHOWN  
SCALE: 15X

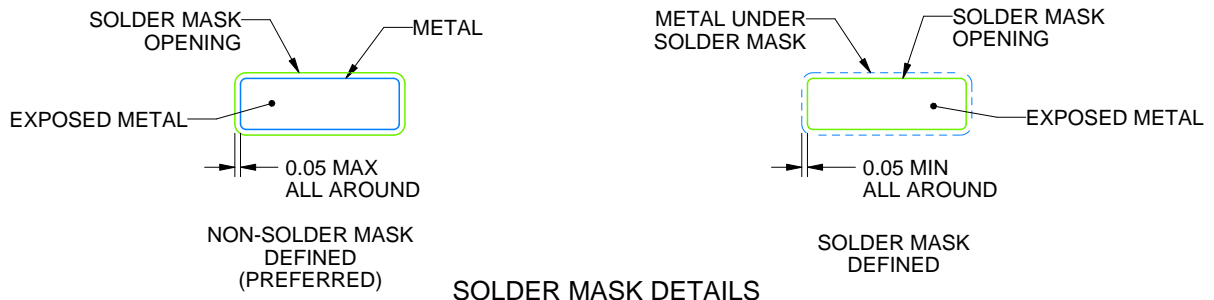

SOLDER MASK DETAILS

4214862/A 04/2023

NOTES: (continued)

6. Publication IPC-7351 may have alternate designs.
7. Solder mask tolerances between and around signal pads can vary based on board fabrication site.
8. Vias are optional depending on application, refer to device data sheet. If any vias are implemented, refer to their locations shown on this view. It is recommended that vias under paste be filled, plugged or tented.
9. Size of metal pad may vary due to creepage requirement.

# EXAMPLE STENCIL DESIGN

DGK0008A

<sup>TM</sup> VSSOP - 1.1 mm max height

SMALL OUTLINE PACKAGE



SOLDER PASTE EXAMPLE  
SCALE: 15X

4214862/A 04/2023

NOTES: (continued)

11. Laser cutting apertures with trapezoidal walls and rounded corners may offer better paste release. IPC-7525 may have alternate design recommendations.
12. Board assembly site may have different recommendations for stencil design.

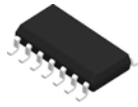

# D0014A

# PACKAGE OUTLINE

## SOIC - 1.75 mm max height

SMALL OUTLINE INTEGRATED CIRCUIT

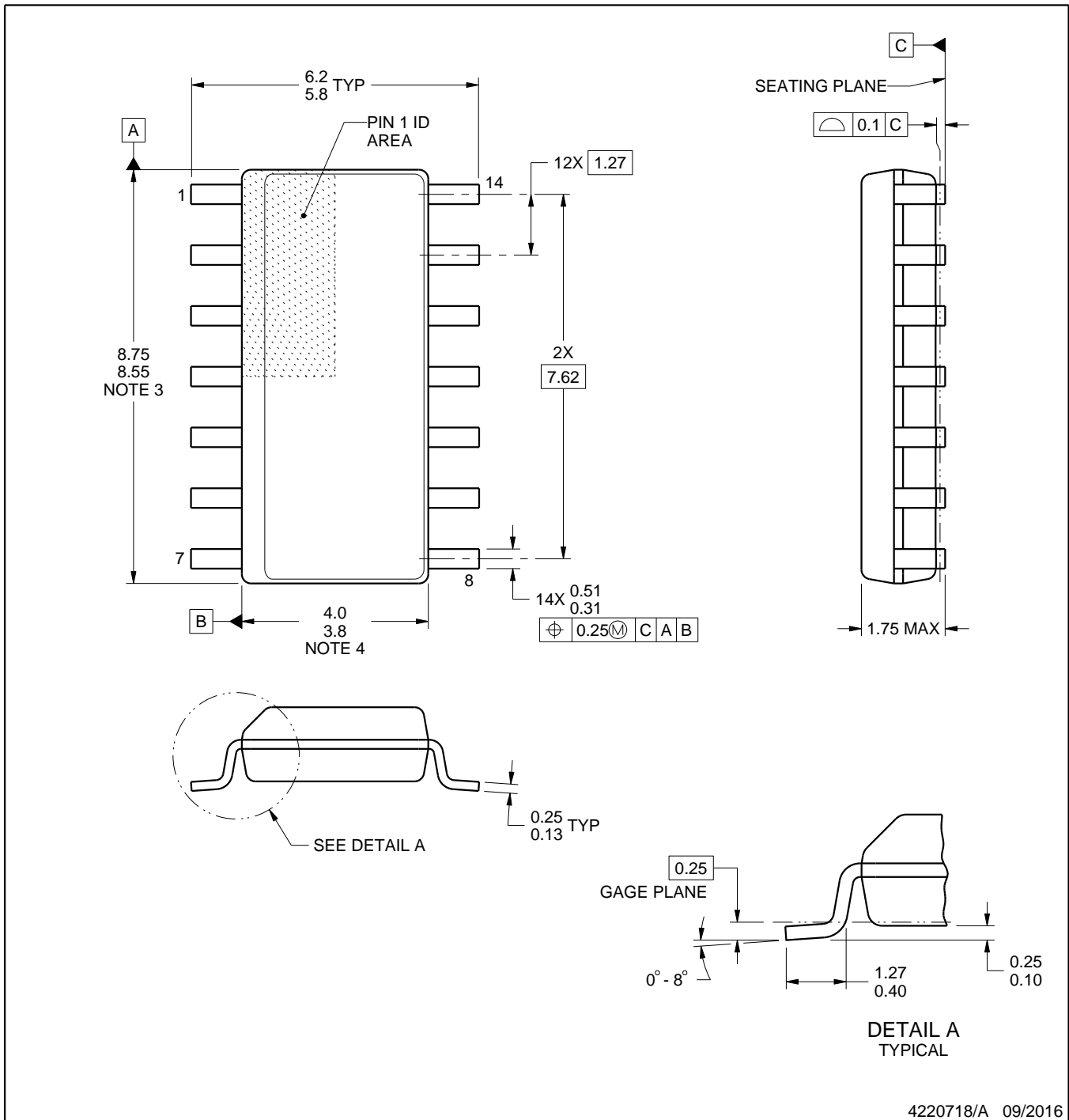

4220718/A 09/2016

### NOTES:

1. All linear dimensions are in millimeters. Dimensions in parenthesis are for reference only. Dimensioning and tolerancing per ASME Y14.5M.
2. This drawing is subject to change without notice.
3. This dimension does not include mold flash, protrusions, or gate burrs. Mold flash, protrusions, or gate burrs shall not exceed 0.15 mm, per side.
4. This dimension does not include interlead flash. Interlead flash shall not exceed 0.43 mm, per side.
5. Reference JEDEC registration MS-012, variation AB.

# EXAMPLE BOARD LAYOUT

D0014A

SOIC - 1.75 mm max height

SMALL OUTLINE INTEGRATED CIRCUIT



LAND PATTERN EXAMPLE  
SCALE:8X



SOLDER MASK DETAILS

4220718/A 09/2016

NOTES: (continued)

6. Publication IPC-7351 may have alternate designs.
7. Solder mask tolerances between and around signal pads can vary based on board fabrication site.

# EXAMPLE STENCIL DESIGN

D0014A

SOIC - 1.75 mm max height

SMALL OUTLINE INTEGRATED CIRCUIT

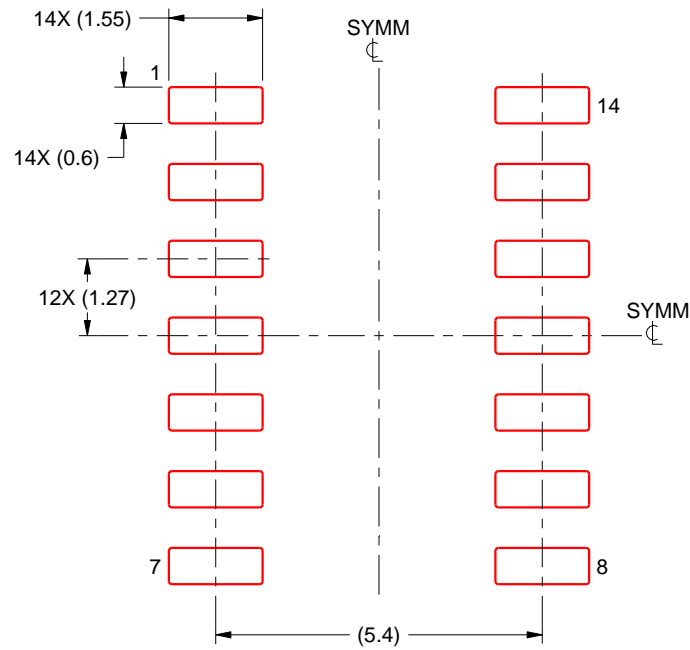

SOLDER PASTE EXAMPLE  
BASED ON 0.125 mm THICK STENCIL  
SCALE:8X

4220718/A 09/2016

NOTES: (continued)

8. Laser cutting apertures with trapezoidal walls and rounded corners may offer better paste release. IPC-7525 may have alternate design recommendations.
9. Board assembly site may have different recommendations for stencil design.

## 重要なお知らせと免責事項

TI は、技術データと信頼性データ(データシートを含みます)、設計リソース(リファレンス デザインを含みます)、アプリケーションや設計に関する各種アドバイス、Web ツール、安全性情報、その他のリソースを、欠陥が存在する可能性のある「現状のまま」提供しており、商品性および特定目的に対する適合性の黙示保証、第三者の知的財産権の非侵害保証を含むいかなる保証も、明示的または黙示的にかかわらず拒否します。

これらのリソースは、TI 製品を使用する設計の経験を積んだ開発者への提供を意図したものです。(1) お客様のアプリケーションに適した TI 製品の選定、(2) お客様のアプリケーションの設計、検証、試験、(3) お客様のアプリケーションに該当する各種規格や、その他のあらゆる安全性、セキュリティ、規制、または他の要件への確実な適合に関する責任を、お客様のみが単独で負うものとし、

上記の各種リソースは、予告なく変更される可能性があります。これらのリソースは、リソースで説明されている TI 製品を使用するアプリケーションの開発の目的でのみ、TI はその使用をお客様に許諾します。これらのリソースに関して、他の目的で複製することや掲載することは禁止されています。TI や第三者の知的財産権のライセンスが付与されている訳ではありません。お客様は、これらのリソースを自身で使用した結果発生するあらゆる申し立て、損害、費用、損失、責任について、TI およびその代理人を完全に補償するものとし、TI は一切の責任を拒否します。

TI の製品は、[TI の販売条件](#)、[TI の総合的な品質ガイドライン](#)、[ti.com](#) または TI 製品などに関連して提供される他の適用条件に従い提供されます。TI がこれらのリソースを提供することは、適用される TI の保証または他の保証の放棄の拡大や変更を意味するものではありません。TI がカスタム、またはカスタマー仕様として明示的に指定していない限り、TI の製品は標準的なカタログに掲載される汎用機器です。

お客様がいかなる追加条項または代替条項を提案する場合も、TI はそれらに異議を唱え、拒否します。

Copyright © 2026, Texas Instruments Incorporated

最終更新日 : 2025 年 10 月