

TMP23x-Q1 車載用、高精度アナログ出力温度センサ

1 特長

- 車載アプリケーション向けに AEC-Q100 認証済み
 - TMP235-Q1 グレード 0: $-40^{\circ}\text{C} \sim +150^{\circ}\text{C}$
 - TMP236-Q1 グレード 1: $-40^{\circ}\text{C} \sim +125^{\circ}\text{C}$
- 機能安全対応
 - 機能安全システムの設計に役立つ資料を利用可能
- 広い温度範囲にわたって厳密な精度を維持
 - $\pm 2.5^{\circ}\text{C}$ (最大値): $-40^{\circ}\text{C} \sim +150^{\circ}\text{C}$ (TMP235-Q1)
 - $\pm 2.5^{\circ}\text{C}$ (最大値): $-10^{\circ}\text{C} \sim +125^{\circ}\text{C}$ (TMP236-Q1)
- 正勾配のセンサ・ゲイン、オフセット (標準値):
 - $10\text{mV}/^{\circ}\text{C}$, 0°C で 500mV (TMP235-Q1)
 - $19.5\text{mV}/^{\circ}\text{C}$, 0°C で 400mV (TMP236-Q1)
- 広い動作電源電圧範囲
 - $2.3\text{V} \sim 5.5\text{V}$ (TMP235-Q1)
 - $3.1\text{V} \sim 5.5\text{V}$ (TMP236-Q1)
- 出力短絡保護
- 低い消費電力: $9\mu\text{A}$ (標準値)
- 最大 1000pF の負荷を駆動できる強力な出力
- 供給されるパッケージ・オプション:
 - 5 ピンの SC70 (DCK) 表面実装
 - 3 ピンの SOT-23 (DBZ) 表面実装
 - 業界標準の LMT8x-Q1、LM50-Q1、および LM20 温度センサとフットプリント互換
- サーミスタに対するコスト効率の優れた代替

2 アプリケーション

- 車載用ヘッド・ユニット
- 電動パワー・ステアリング (EPS)
- シフト・システム
- バッテリー管理システム (BMS)
- ガソリン・エンジン

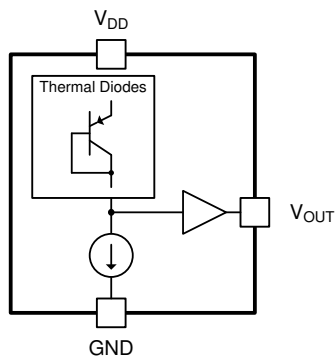

機能ブロック図

3 概要

TMP23x-Q1 デバイスは、温度に比例する出力電圧を備えた車載用高精度 CMOS IC リニア・アナログ温度センサのファミリーであり、パワートレインからインフォテインメントまで各種の車載用アプリケーションに役立ちます。これらの温度センサは、 $0^{\circ}\text{C} \sim +70^{\circ}\text{C}$ の範囲で $\pm 0.5^{\circ}\text{C}$ の精度 (標準値) を実現しています。TMP235-Q1 デバイスは、 $-40^{\circ}\text{C} \sim +150^{\circ}\text{C}$ の温度範囲全体にわたって $10\text{mV}/^{\circ}\text{C}$ の正の勾配出力、電源電圧範囲は $2.3\text{V} \sim 5.5\text{V}$ となっています。よりゲインの高い TMP236-Q1 センサは、 $-10^{\circ}\text{C} \sim +125^{\circ}\text{C}$ の範囲で $19.5\text{mV}/^{\circ}\text{C}$ の正の勾配出力、電源電圧範囲は $3.1\text{V} \sim 5.5\text{V}$ です。

静止電流は $9\mu\text{A}$ (標準値)、パワーオン時間は $800\mu\text{s}$ (標準値) で、効果的な電源サイクリング・アーキテクチャにより、バッテリー駆動のデバイスで消費電力を最小化できます。Class-AB 出力ドライバは、最大出力が $500\mu\text{A}$ と強力で、最大 1000pF の容量性負荷を駆動でき、A/D コンバータのサンプル・ホールド入力と直接接続するよう設計されています。優れた精度と強力なリニア出力ドライバを備えた TMP23x-Q1 アナログ出力温度センサは、パッシブなサーミスタに代わるコスト効率の優れた代替品となります。

デバイス情報⁽¹⁾

部品番号	パッケージ	本体サイズ (公称)
TMP235-Q1、 TMP236-Q1	SC70 (5)	2.00mm×1.25mm
	SOT-23 (3)	2.92mm×1.30mm

- (1) 利用可能なパッケージについては、このデータシートの末尾にある注文情報を参照してください。

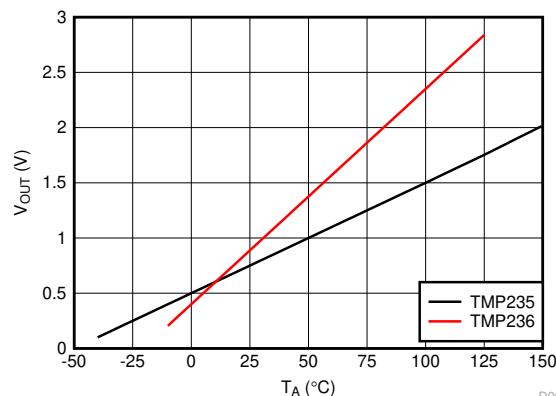

出力電圧と周囲温度との関係

D003



Table of Contents

1 特長.....	1	7.4 Device Functional Modes.....	11
2 アプリケーション.....	1	8 Application and Implementation.....	12
3 概要.....	1	8.1 Application Information.....	12
4 Revision History.....	2	8.2 Typical Application.....	12
5 Pin Configuration and Functions.....	3	9 Power Supply Recommendations.....	13
6 Specifications.....	4	10 Layout.....	13
6.1 Absolute Maximum Ratings.....	4	10.1 Layout Guidelines.....	13
6.2 ESD Ratings.....	4	10.2 Layout Examples.....	13
6.3 Recommended Operating Conditions.....	4	11 Device and Documentation Support.....	14
6.4 Thermal Information.....	4	11.1 Receiving Notification of Documentation Updates..	14
6.5 Electrical Characteristics.....	5	11.2 サポート・リソース.....	14
6.6 Typical Characteristics.....	6	11.3 Trademarks.....	14
7 Detailed Description.....	8	11.4 Electrostatic Discharge Caution.....	14
7.1 Overview.....	8	11.5 Glossary.....	14
7.2 Functional Block Diagram.....	8	12 Mechanical, Packaging, and Orderable	
7.3 Feature Description.....	8	Information.....	14

4 Revision History

資料番号末尾の英字は改訂を表しています。その改訂履歴は英語版に準じています。

Changes from Revision C (November 2019) to Revision D (June 2022)	Page
• 文書全体にわたって表、図、相互参照の採番方法を更新.....	1
• 「特長」セクションに機能安全の箇条書き項目を追加.....	1
Changes from Revision B (October 2019) to Revision C (November 2019)	Page
• Added temperature accuracy specs for the TMP236-Q1 SOT-23 package.....	5
Changes from Revision A (May 2019) to Revision B (October 2019)	Page
• ドキュメントのステータスを「事前情報」から「量産データ」に変更.....	1
Changes from Revision * (April 2019) to Revision A (May 2019)	Page
• Changed recommended operating temperature range from: –50°C to 150°C to: –40°C to 150°C	4

5 Pin Configuration and Functions



图 5-1. DBZ Package 3-Pin SOT-23 Top View



NC- no internal connection

图 5-2. DCK Package 5-Pin SC70 Top View

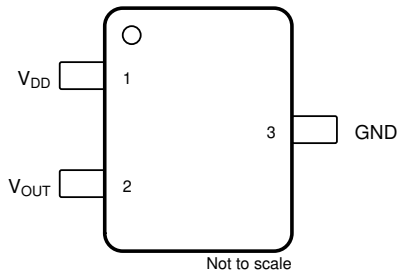
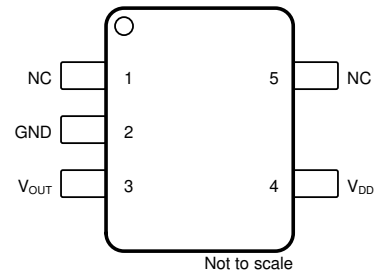
表 5-1. Pin Functions

NAME	PIN		TYPE	DESCRIPTION
	SOT-23	SC70		
GND	3	2	Ground	Power supply ground.
NC	—	5	—	No internal connection. This pin may be left floating or connected to GND.
NC	—	1	—	No internal connection. This pin may be left floating or connected to GND.
V _{OUT}	2	3	O	Outputs voltage proportional to temperature
V _{DD}	1	4	I	Positive supply input

6 Specifications

6.1 Absolute Maximum Ratings

over operating free-air temperature range (unless otherwise noted) ⁽¹⁾

	MIN	MAX	UNIT
Supply voltage, V_{DD}		+6	V
Output voltage, V_{OUT}	-0.3	$(V_{DD} + 0.3)$	
Output current	-30	+30	mA
Latch-up current, each pin	-200	+200	
Junction temperature (T_J)		+150	°C
Storage temperature (T_{stg})	-65	+150	

- (1) Stresses beyond those listed under *Absolute Maximum Ratings* may cause permanent damage to the device. These are stress ratings only, which do not imply functional operation of the device at these or any other conditions beyond those indicated under *Recommended Operating Conditions*. Exposure to absolute-maximum-rated conditions for extended periods may affect device reliability.

6.2 ESD Ratings

			VALUE	UNIT	
$V_{(ESD)}$	Electrostatic discharge	Human body model (HBM), per AEC Q100-002 ⁽¹⁾ HBM ESD Classification Level 2	±2000	V	
		Charged device model (CDM), per AEC Q100-011 CDM ESD Classification Level C4B	All Pins	±500	V
			Corner Pins	±750	V

- (1) AEC Q100-002 indicates that HBM stressing shall be in accordance with the ANSI/ESDA/JEDEC JS-001 specification

6.3 Recommended Operating Conditions

over operating free-air temperature range (unless otherwise noted)

		MIN	NOM	MAX	UNIT
V_{DD}	Input voltage (TMP235-Q1)	2.3		5.5	V
	Input voltage (TMP236-Q1)	3.1		5.5	
T_A	Operating free-air temperature	-40		150	°C

6.4 Thermal Information

THERMAL METRIC ⁽¹⁾ ⁽²⁾		TMP23X-Q1		UNIT
		DCK (SC70)	DBZ (SOT-23)	
		5 PINS	3 PINS	
$R_{\theta JA}$	Junction-to-ambient thermal resistance ⁽³⁾ ⁽⁴⁾	275	167	°C/W
$R_{\theta JC(top)}$	Junction-to-case (top) thermal resistance	84	90	°C/W
$R_{\theta JB}$	Junction-to-board thermal resistance	56	146	°C/W
Ψ_{JT}	Junction-to-top characterization parameter	1.2	35	°C/W
Ψ_{JB}	Junction-to-board characterization parameter	55	146	°C/W

- (1) For more information about traditional and new thermal metrics, see the [Semiconductor and IC Package Thermal Metrics](#) application report.
- (2) For information on self-heating and thermal response time see [Layout Guidelines](#) section.
- (3) The junction to ambient thermal resistance ($R_{\theta JA}$) under natural convection is obtained in a simulation on a JEDEC-standard, High-K board as specified in JESD51-7, in an environment described in JESD51-2. Exposed pad packages assume that thermal vias are included in the PCB, per JESD 51-5.
- (4) Changes in output due to self heating can be computed by multiplying the internal dissipation by the thermal resistance.

6.5 Electrical Characteristics

TMP235-Q1: $V_{DD} = 2.3\text{ V to }5.5\text{ V}$, GND = Ground, $T_A = -40^\circ\text{C to }+125^\circ\text{C}$ and no load (unless otherwise noted)

TMP236-Q1: $V_{DD} = 3.1\text{ V to }5.5\text{ V}$, GND = Ground, $T_A = -10^\circ\text{C to }+125^\circ\text{C}$ and no load (unless otherwise noted)

PARAMETER		TEST CONDITIONS	MIN	TYP	MAX	UNIT	
POWER SUPPLY							
I_{DD}	Operating current	$T_A = 25^\circ\text{C}$, $V_{DD} = 2.3\text{ V}$, TMP235-Q1		9		μA	
		$T_A = 25^\circ\text{C}$, $V_{DD} = 3.1\text{ V}$, TMP236-Q1		10			
		$T_A = -40^\circ\text{C to }+125^\circ\text{C}$, TMP235-Q1			14.5		
		$T_A = -10^\circ\text{C to }+125^\circ\text{C}$, TMP236-Q1					15
		$T_A = 150^\circ\text{C}$, TMP235-Q1					17
$\Delta^\circ\text{C}/\Delta V_{DD}$	Line regulation		-0.1	0.02	0.1	$^\circ\text{C/V}$	
SENSOR ACCURACY							
T_{ACY}	Temperature accuracy ⁽¹⁾	$T_A = 25^\circ\text{C}$		± 0.5		$^\circ\text{C}$	
		$T_A = 0^\circ\text{C to }70^\circ\text{C}$ (SC70 Package) (TMP235-Q1)	-1.5	± 0.5	+1.2		
		$T_A = 0^\circ\text{C to }70^\circ\text{C}$ (SOT-23 Package) (TMP235-Q1)	-1.5	± 0.5	+1.2		
		$T_A = -40^\circ\text{C to }125^\circ\text{C}$ (TMP235-Q1)	-2.5	± 0.5	+2.5		
		$T_A = -40^\circ\text{C to }150^\circ\text{C}$ (TMP235-Q1)	-2.5	± 0.5	+2.5		
		$T_A = -10^\circ\text{C to }125^\circ\text{C}$ (TMP236-Q1)	-2.5	± 0.5	+2.5		
T_{ACY}	Temperature accuracy ⁽¹⁾	$T_A = 0^\circ\text{C to }70^\circ\text{C}$ (SOT-23 Package) (TMP236-Q1)	-1.5	± 0.5	+1.5	$^\circ\text{C}$	
SENSOR OUTPUT							
$V_{0^\circ\text{C}}$	Output voltage offset at 0°C	TMP235-Q1		500		mV	
		TMP236-Q1		400			
T_C	Temperature coefficient (sensor gain)	TMP235-Q1		10		$\text{mV}/^\circ\text{C}$	
		TMP236-Q1		19.5			
V_{ONL}	Output nonlinearity ⁽²⁾	$T_A = 0^\circ\text{C to }70^\circ\text{C}$, no load		± 0.5		$^\circ\text{C}$	
I_{OUT}	Output current				500	μA	
Z_{OUT}	Output impedance	$I_{OUT} = 100\ \mu\text{A}$, $f = 100\text{ Hz}$		20		Ω	
		$I_{OUT} = 100\ \mu\text{A}$, $f = 500\text{ Hz}$		50			
	Output load regulation	$T_A = 0^\circ\text{C to }70^\circ\text{C}$, $I_{OUT} = 100\ \mu\text{A}$, $\Delta V_{OUT} / \Delta I_{OUT}$		1		Ω	
t_{ON}	Turn on time	Time to reach accuracy within $\pm 0.5^\circ\text{C}$		800		μs	
C_{LOAD}	Typical load capacitance				1000	pF	
t_{RES}	Thermal response to 63%	SC70	30°C (Air) to $+125^\circ\text{C}$ (Fluid Bath)		1.3	s	

- (1) Accuracy is defined as the error between the measured and reference output voltages, tabulated in the [TMP235-Q1 Transfer Table](#) and [TMP236-Q1 Transfer Table](#) at the specified conditions of supply voltage and temperature (expressed in $^\circ\text{C}$). Accuracy limits include line regulation within the specified conditions. Accuracy limits do not include load regulation; they assume no DC load.
- (2) Nonlinearity is defined as the deviation of the output-voltage-versus-temperature curve from the best-fit straight line, over the device's rated temperature range.

6.6 Typical Characteristics

at $T_A = 25^\circ\text{C}$, (unless otherwise noted)

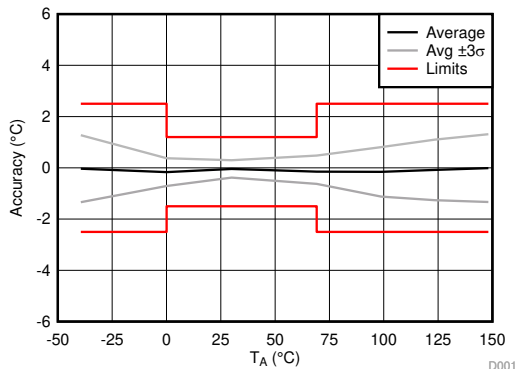

TMP235-Q1: $V_{DD} = 2.3$ to 5.5 V, $I_{OUT} = 0$ μA , $C_{LOAD} = 1000$ pF

6-1. Accuracy vs T_A Temperature

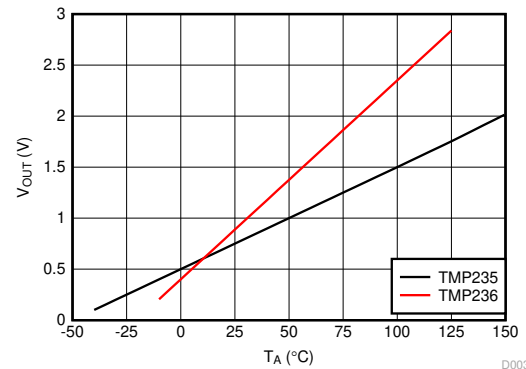

$I_{OUT} = 0$ μA , $C_{LOAD} = 1000$ pF

6-2. Output Voltage vs Ambient Temperature

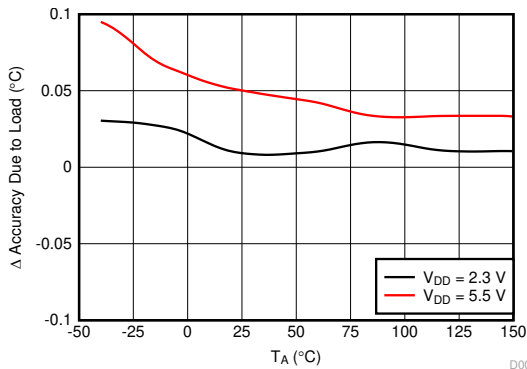

TMP23x-Q1: I_{OUT} = from 0 μA to 100 μA , $C_{LOAD} = 1000$ pF

6-3. Changes in Accuracy vs Ambient Temperature (Due to Load)

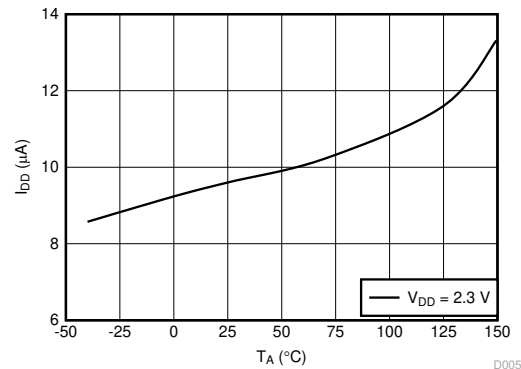

TMP23x-Q1: $I_{OUT} = 0$ μA , $C_{LOAD} = 1000$ pF

6-4. Supply Current vs Temperature

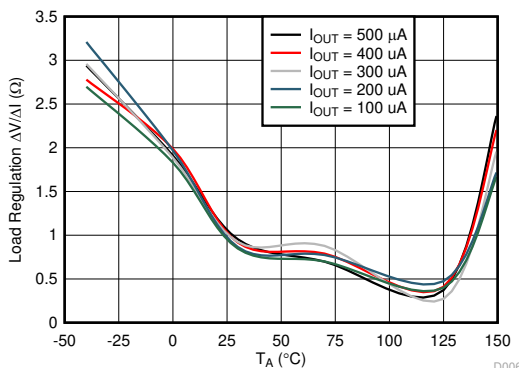

TMP23x-Q1: $V_{DD} = 2.3$ V, $C_{LOAD} = 1000$ pF

6-5. Load Regulation vs Ambient Temperature

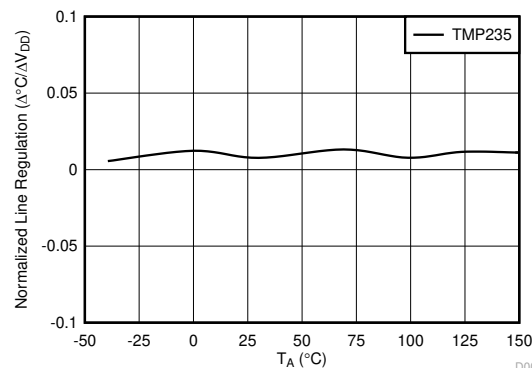

TMP23x-Q1: $V_{DD} = 2.3$ to 5.5 V, $I_{OUT} = 0$ μA , $C_{LOAD} = 1000$ pF

6-6. Line Regulation ($\Delta^\circ\text{C} / \Delta V_{DD}$) vs Ambient Temperature

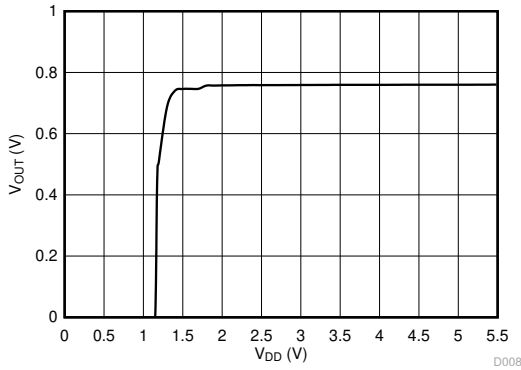

TMP23x-Q1: $T_A = 25^\circ\text{C}$

6-7. Output Voltage vs Power Supply

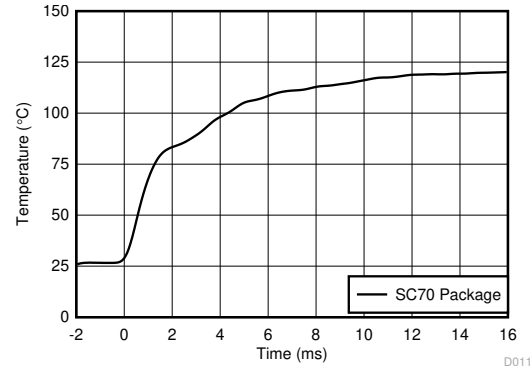

TMP23x-Q1: 1 × 1 (inches) PCB, Air 26°C to Fluid Bath 123°C

6-8. Thermal Response (Air-to-Fluid Bath)

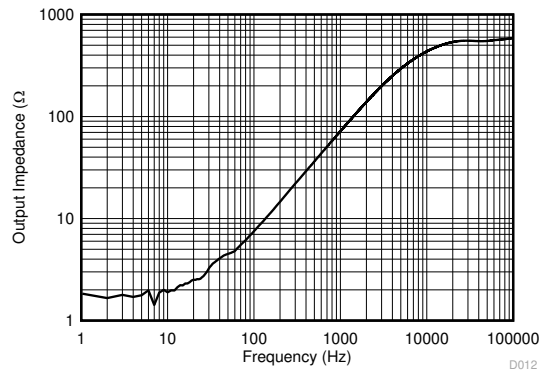

TMP23x-Q1: $T_A = 25^\circ\text{C}$, $V_{DD} = 5\text{ V}$, $I_{OUT} = 100\ \mu\text{A}$

6-9. Output Impedance vs Frequency

7 Detailed Description

7.1 Overview

The TMP23x-Q1 devices are a family of linear analog temperature sensors with an output voltage proportional to temperature. These temperature sensors have an accuracy from 0°C to 70°C of ±1.5°C. The TMP235-Q1 device provides a positive slope output of 10 mV/°C over the full –40°C to +150°C temperature range and a supply range from 2.3 V to 5.5 V. The higher gain TMP236-Q1 sensor provides a positive slope output of 19.5 mV/°C from –10°C to +125°C and a supply range from 3.1 V to 5.5 V. A class-AB output driver provides a maximum output of 500 µA to drive capacitive loads up to 1000 pF.

7.2 Functional Block Diagram

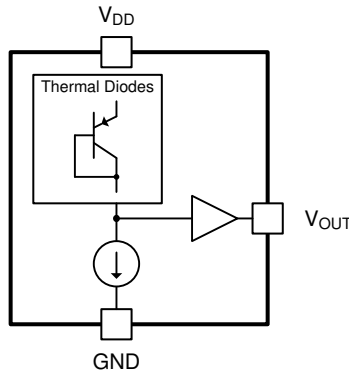

7.3 Feature Description

As shown in [Figure 6-2](#), the TMP23x-Q1 devices are linear. A small V_{OUT} gain shift, however, is present at temperatures above 100°C. When small shifts are expected, a piecewise linear function provides the best accuracy and is used for the device accuracy specifications (see [Specifications](#)). Typical output voltages of the TMP23x-Q1 devices across the full operating temperature range are listed in [Table 7-3](#) and [Table 7-4](#). The ideal linear columns represent the ideal linear V_{OUT} output response with respect to temperature, while the piecewise linear columns indicate the small voltage shift at elevated temperatures.

The piecewise linear function uses three temperature ranges listed in [Table 7-1](#) and [Table 7-2](#). In equation form, the voltage output V_{OUT} of the TMP23x-Q1 is calculated by [Equation 1](#):

$$V_{OUT} = (T_A - T_{INFL}) \times T_C + V_{OFFS} \quad (1)$$

where

- V_{OUT} is the TMP23x-Q1 voltage output for a given temperature
- T_A is the ambient temperature in °C
- T_{INFL} is the temperature inflection point for a piecewise segment in °C
- T_C is the TMP23x-Q1 temperature coefficient or gain
- V_{OFFS} is the TMP23x-Q1 voltage offset

Therefore, the T_A temperature for a given V_{OUT} voltage output within a piecewise voltage range (V_{RANGE}) is calculated in [Equation 2](#). For applications where the accuracy enhancement above 100°C is not required, use the first row of [Table 7-1](#) and [Table 7-2](#) for all voltages.

$$T_A = (V_{OUT} - V_{OFFS}) / T_C + T_{INFL} \quad (2)$$

表 7-1. TMP235-Q1 Piecewise Linear Function Summary

T_A RANGE (°C)	V_{RANGE} (mV)	T_{INFL} (°C)	T_C (mV/°C)	V_{OFFS} (mV)
–40 to +100	< 1500	0	10	500
100 to 125	1500 to 1752.5	100	10.1	1500
125 to 150	> 1752.5	125	10.6	1752.5

表 7-2. TMP236-Q1 Piecewise Linear Function Summary

T _A RANGE (°C)	V _{RANGE} (mV)	T _{INFL} (°C)	T _C (mV/°C)	V _{OFFS} (mV)
-40 to +100	≤ 2350	0	19.5	400
100 to 125	> 2350	100	19.7	2350
125 to 150	—	—	—	—

表 7-3. TMP235-Q1 Transfer Table

TEMPERATURE (°C)	V _{OUT} (mV) IDEAL LINEAR VALUES	V _{OUT} (mV) PIECEWISE LINEAR VALUES
-40	100	100
-35	150	150
-30	200	200
-25	250	250
-20	300	300
-15	350	350
-10	400	400
-5	450	450
0	500	500
5	550	550
10	600	600
15	650	650
20	700	700
25	750	750
30	800	800
35	850	850
40	900	900
45	950	950
50	1000	1000
55	1050	1050
60	1100	1100
65	1150	1150
70	1200	1200
75	1250	1250
80	1300	1300
85	1350	1350
90	1400	1400
95	1450	1450
100	1500	1500
105	1550	1550.5
110	1600	1601
115	1650	1651.5
120	1700	1702
125	1750	1752.5
130	1800	1805.5
135	1850	1858.5
140	1900	1911.5
145	1950	1964.5

表 7-3. TMP235-Q1 Transfer Table (continued)

TEMPERATURE (°C)	V _{OUT} (mV) IDEAL LINEAR VALUES	V _{OUT} (mV) PIECEWISE LINEAR VALUES
150	2000	2017.5

表 7-4. TMP236-Q1 Transfer Table

TEMPERATURE (°C)	V _{OUT} (mV) IDEAL LINEAR VALUES	V _{OUT} (mV) PIECEWISE LINEAR VALUES
-40	—	—
-35	—	—
-30	—	—
-25	—	—
-20	—	—
-15	—	—
-10	205	205
-5	303	303
0	400	400
5	498	498
10	595	595
15	693	693
20	790	790
25	888	888
30	985	985
35	1083	1083
40	1180	1180
45	1278	1278
50	1375	1375
55	1473	1473
60	1570	1570
65	1668	1668
70	1765	1765
75	1863	1863
80	1960	1960
85	2058	2058
90	2155	2155
95	2253	2253
100	2350	2350
105	2448	2448.5
110	2545	2547
115	2643	2645.4
120	2740	2743.9
125	2838	2842.4
130	—	—
135	—	—
140	—	—
145	—	—
150	—	—

7.4 Device Functional Modes

The singular functional mode of the TMP23x-Q1 is an analog output directly proportional to temperature.

8 Application and Implementation

注

以下のアプリケーション情報は、TI の製品仕様に含まれるものではなく、TI ではその正確性または完全性を保証いたしません。個々の目的に対する製品の適合性については、お客様の責任で判断していただくこととなります。お客様は自身の設計実装を検証しテストすることで、システムの機能を確認する必要があります。

8.1 Application Information

The features of the TMP235-Q1 make the series of devices designed for various general temperature-sensing applications. The TMP235-Q1 and TMP236-Q1 devices can operate down to a 2.3-V and a 3.1-V supply with 9- μ A power consumption, respectively. The TMP23x-Q1 series is mounted in two surface mount technology packages (SC70 and SOT-23.)

8.2 Typical Application

8.2.1 Connection to an ADC



図 8-1. Suggested Connections to an ADC Input Stage

8.2.1.1 Design Requirements

See 図 8-1 for suggested connections to an ADC input stage. Most CMOS-based ADCs have a sampled data comparator input structure. When the ADC charges the sampling capacitor (C_{SAMPLE}), the capacitor requires instantaneous charge from the output of the analog source temperature sensor, such as the TMP235-Q1. Therefore, the output impedance of the temperature sensor can affect ADC performance. In most cases, adding an external capacitor (C_{FILTER}) mitigates design challenges. The TMP235-Q1 is specified and characterized with a 1000-pF maximum capacitive load (C_{LOAD}). 図 8-1 shows C_{LOAD} as the sum of $C_{FILTER} + C_{MUX} + C_{SAMPLE}$. TI recommends maximizing the C_{FILTER} value while allowing for the maximum specified ADC input capacitance ($C_{MUX} + C_{SAMPLE}$) to limit the total C_{LOAD} at 1000 pF. In most cases, a 680-pF C_{FILTER} provides a reasonable allowance for ADC input capacitance to minimize ADC sampling error and reduce noise coupling. An optional series resistor (R_{FILTER}) and C_{FILTER} provides additional low-pass filtering to reject system level noise. TI recommends placing R_{FILTER} and C_{FILTER} as close as possible to the ADC input for optimal performance.

8.2.1.2 Detailed Design Procedure

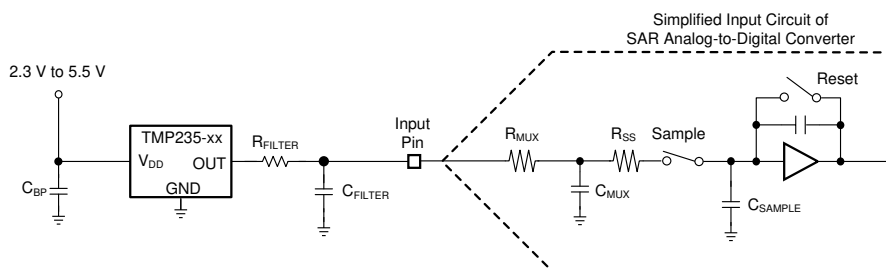
Depending on the input characteristics of the ADC, an external C_{FILTER} may be required. The value of C_{FILTER} depends on the size of the sampling capacitor (C_{SAMPLE}) and the sampling frequency while observing a maximum C_{LOAD} of 1000 pF. The capacitor requirements can vary because the input stages of all ADCs are not identical. 図 8-1 shows a general ADC application as an example only.

8.2.1.3 Application Curve

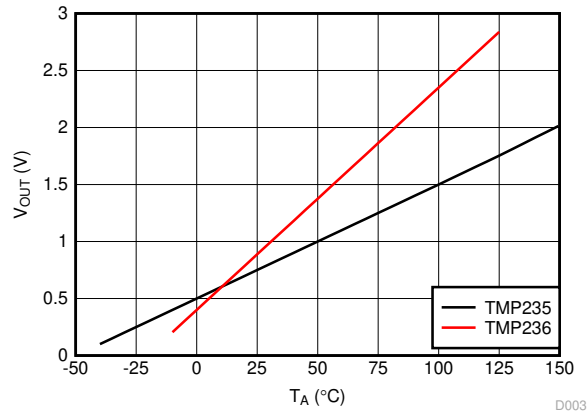

8-2. Output Voltage vs. Ambient

9 Power Supply Recommendations

The low supply current and supply range of the TMP23x-Q1 allow the device to be easily powered from many sources.

Power supply bypassing is strongly recommended. In noisy environments, TI recommends to add a filter with 0.1- μ F capacitor and 100- Ω resistor between external supply and V_{DD} to limit the power supply noise. Larger capacitances may be required and are dependent on the noise of the power supply.

10 Layout

10.1 Layout Guidelines

The layout of the TMP23x-Q1 series is simple. If a power supply bypass capacitor is used, the capacitor must be connected as [Layout Examples](#) shows.

10.2 Layout Examples

 VIA to ground plane

 VIA to power plane

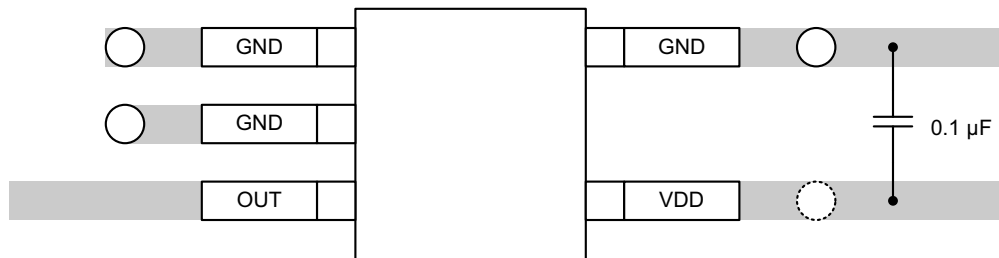

10-1. Recommended Layout: SC70 Package

11 Device and Documentation Support

11.1 Receiving Notification of Documentation Updates

To receive notification of documentation updates, navigate to the device product folder on [ti.com](https://www.ti.com). Click on *Subscribe to updates* to register and receive a weekly digest of any product information that has changed. For change details, review the revision history included in any revised document.

11.2 サポート・リソース

TI E2E™ サポート・フォーラムは、エンジニアが検証済みの回答と設計に関するヒントをエキスパートから迅速かつ直接得ることができる場所です。既存の回答を検索したり、独自の質問をしたりすることで、設計に必要な支援を迅速に得ることができます。

リンクされているコンテンツは、該当する貢献者により、現状のまま提供されるものです。これらは TI の仕様を構成するものではなく、必ずしも TI の見解を反映したものではありません。TI の[使用条件](#)を参照してください。

11.3 Trademarks

TI E2E™ is a trademark of Texas Instruments.

すべての商標は、それぞれの所有者に帰属します。

11.4 Electrostatic Discharge Caution



This integrated circuit can be damaged by ESD. Texas Instruments recommends that all integrated circuits be handled with appropriate precautions. Failure to observe proper handling and installation procedures can cause damage.

ESD damage can range from subtle performance degradation to complete device failure. Precision integrated circuits may be more susceptible to damage because very small parametric changes could cause the device not to meet its published specifications.

11.5 Glossary

[TI Glossary](#) This glossary lists and explains terms, acronyms, and definitions.

12 Mechanical, Packaging, and Orderable Information

The following pages include mechanical, packaging, and orderable information. This information is the most current data available for the designated devices. This data is subject to change without notice and revision of this document. For browser-based versions of this data sheet, refer to the left-hand navigation.

PACKAGING INFORMATION

Orderable part number	Status (1)	Material type (2)	Package Pins	Package qty Carrier	RoHS (3)	Lead finish/ Ball material (4)	MSL rating/ Peak reflow (5)	Op temp (°C)	Part marking (6)
TMP235AEDBZRQ1	Active	Production	SOT-23 (DBZ) 3	3000 LARGE T&R	Yes	NIPDAU NIPDAUAG	Level-2-260C-1 YEAR	-40 to 150	235E
TMP235AEDBZRQ1.A	Active	Production	SOT-23 (DBZ) 3	3000 LARGE T&R	Yes	NIPDAU	Level-2-260C-1 YEAR	-40 to 150	235E
TMP235AEDBZTQ1	Obsolete	Production	SOT-23 (DBZ) 3	-	-	Call TI	Call TI	-40 to 150	235E
TMP235AEDCKRQ1	Active	Production	SC70 (DCK) 5	3000 LARGE T&R	Yes	NIPDAUAG	Level-2-260C-1 YEAR	-40 to 150	1CF
TMP235AEDCKRQ1.A	Active	Production	SC70 (DCK) 5	3000 LARGE T&R	Yes	NIPDAUAG	Level-2-260C-1 YEAR	-40 to 150	1CF
TMP235AQDBZRQ1	Active	Production	SOT-23 (DBZ) 3	3000 LARGE T&R	Yes	NIPDAU SN NIPDAUAG	Level-2-260C-1 YEAR	-40 to 125	235Q
TMP235AQDBZRQ1.A	Active	Production	SOT-23 (DBZ) 3	3000 LARGE T&R	Yes	NIPDAU	Level-2-260C-1 YEAR	-40 to 125	235Q
TMP235AQDBZTQ1	Obsolete	Production	SOT-23 (DBZ) 3	-	-	Call TI	Call TI	-40 to 125	235Q
TMP235AQDCKRQ1	Active	Production	SC70 (DCK) 5	3000 LARGE T&R	Yes	NIPDAUAG	Level-2-260C-1 YEAR	-40 to 125	1CG
TMP235AQDCKRQ1.A	Active	Production	SC70 (DCK) 5	3000 LARGE T&R	Yes	NIPDAUAG	Level-2-260C-1 YEAR	-40 to 125	1CG
TMP235AQDCKTQ1	Obsolete	Production	SC70 (DCK) 5	-	-	Call TI	Call TI	-40 to 125	1CG
TMP236AQDBZRQ1	Active	Production	SOT-23 (DBZ) 3	3000 LARGE T&R	Yes	NIPDAU SN NIPDAUAG	Level-2-260C-1 YEAR	-40 to 125	236Q
TMP236AQDBZRQ1.A	Active	Production	SOT-23 (DBZ) 3	3000 LARGE T&R	Yes	NIPDAU	Level-2-260C-1 YEAR	-40 to 125	236Q
TMP236AQDBZTQ1	Obsolete	Production	SOT-23 (DBZ) 3	-	-	Call TI	Call TI	-40 to 125	236Q

(1) **Status:** For more details on status, see our [product life cycle](#).

(2) **Material type:** When designated, preproduction parts are prototypes/experimental devices, and are not yet approved or released for full production. Testing and final process, including without limitation quality assurance, reliability performance testing, and/or process qualification, may not yet be complete, and this item is subject to further changes or possible discontinuation. If available for ordering, purchases will be subject to an additional waiver at checkout, and are intended for early internal evaluation purposes only. These items are sold without warranties of any kind.

(3) **RoHS values:** Yes, No, RoHS Exempt. See the [TI RoHS Statement](#) for additional information and value definition.

(4) **Lead finish/Ball material:** Parts may have multiple material finish options. Finish options are separated by a vertical ruled line. Lead finish/Ball material values may wrap to two lines if the finish value exceeds the maximum column width.

(5) **MSL rating/Peak reflow:** The moisture sensitivity level ratings and peak solder (reflow) temperatures. In the event that a part has multiple moisture sensitivity ratings, only the lowest level per JEDEC standards is shown. Refer to the shipping label for the actual reflow temperature that will be used to mount the part to the printed circuit board.

(6) Part marking: There may be an additional marking, which relates to the logo, the lot trace code information, or the environmental category of the part.

Multiple part markings will be inside parentheses. Only one part marking contained in parentheses and separated by a "-" will appear on a part. If a line is indented then it is a continuation of the previous line and the two combined represent the entire part marking for that device.

Important Information and Disclaimer:The information provided on this page represents TI's knowledge and belief as of the date that it is provided. TI bases its knowledge and belief on information provided by third parties, and makes no representation or warranty as to the accuracy of such information. Efforts are underway to better integrate information from third parties. TI has taken and continues to take reasonable steps to provide representative and accurate information but may not have conducted destructive testing or chemical analysis on incoming materials and chemicals. TI and TI suppliers consider certain information to be proprietary, and thus CAS numbers and other limited information may not be available for release.

In no event shall TI's liability arising out of such information exceed the total purchase price of the TI part(s) at issue in this document sold by TI to Customer on an annual basis.

OTHER QUALIFIED VERSIONS OF TMP235-Q1, TMP236-Q1 :

- Catalog : [TMP235](#), [TMP236](#)

NOTE: Qualified Version Definitions:

- Catalog - TI's standard catalog product

TAPE AND REEL INFORMATION

QUADRANT ASSIGNMENTS FOR PIN 1 ORIENTATION IN TAPE

*All dimensions are nominal

Device	Package Type	Package Drawing	Pins	SPQ	Reel Diameter (mm)	Reel Width W1 (mm)	A0 (mm)	B0 (mm)	K0 (mm)	P1 (mm)	W (mm)	Pin1 Quadrant
TMP235AEDBZRQ1	SOT-23	DBZ	3	3000	180.0	8.4	2.9	3.35	1.35	4.0	8.0	Q3
TMP235AEDBZRQ1	SOT-23	DBZ	3	3000	180.0	8.4	3.15	2.77	1.22	4.0	8.0	Q3
TMP235AEDCKRQ1	SC70	DCK	5	3000	180.0	8.4	2.47	2.3	1.25	4.0	8.0	Q3
TMP235AQDBZRQ1	SOT-23	DBZ	3	3000	180.0	8.4	3.15	2.77	1.22	4.0	8.0	Q3
TMP235AQDBZRQ1	SOT-23	DBZ	3	3000	180.0	8.4	2.9	3.35	1.35	4.0	8.0	Q3
TMP235AQDCKRQ1	SC70	DCK	5	3000	180.0	8.4	2.47	2.3	1.25	4.0	8.0	Q3
TMP236AQDBZRQ1	SOT-23	DBZ	3	3000	180.0	8.4	2.9	3.35	1.35	4.0	8.0	Q3
TMP236AQDBZRQ1	SOT-23	DBZ	3	3000	180.0	8.4	3.2	2.85	1.3	4.0	8.0	Q3

TAPE AND REEL BOX DIMENSIONS

*All dimensions are nominal

Device	Package Type	Package Drawing	Pins	SPQ	Length (mm)	Width (mm)	Height (mm)
TMP235AEDBZRQ1	SOT-23	DBZ	3	3000	210.0	185.0	35.0
TMP235AEDBZRQ1	SOT-23	DBZ	3	3000	213.0	191.0	35.0
TMP235AEDCKRQ1	SC70	DCK	5	3000	213.0	191.0	35.0
TMP235AQDBZRQ1	SOT-23	DBZ	3	3000	213.0	191.0	35.0
TMP235AQDBZRQ1	SOT-23	DBZ	3	3000	210.0	185.0	35.0
TMP235AQDCKRQ1	SC70	DCK	5	3000	213.0	191.0	35.0
TMP236AQDBZRQ1	SOT-23	DBZ	3	3000	210.0	185.0	35.0
TMP236AQDBZRQ1	SOT-23	DBZ	3	3000	210.0	185.0	35.0

DBZ0003A



PACKAGE OUTLINE

SOT-23 - 1.12 mm max height

SMALL OUTLINE TRANSISTOR

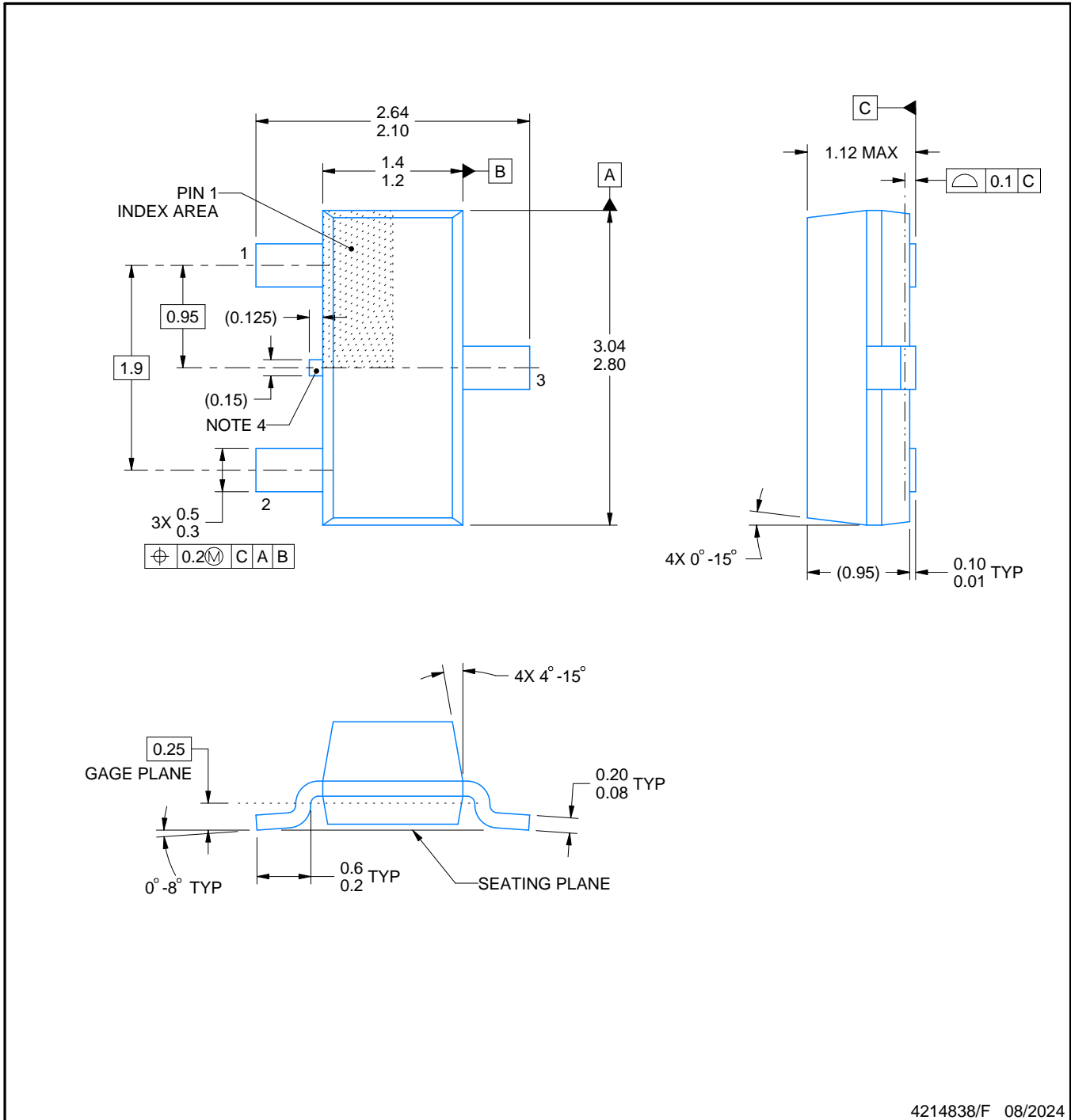

4214838/F 08/2024

NOTES:

1. All linear dimensions are in millimeters. Any dimensions in parenthesis are for reference only. Dimensioning and tolerancing per ASME Y14.5M.
2. This drawing is subject to change without notice.
3. Reference JEDEC registration TO-236, except minimum foot length.
4. Support pin may differ or may not be present.
5. Body dimensions do not include mold flash, protrusions, or gate burrs. Mold flash, protrusions, or gate burrs shall not exceed 0.25mm per side

EXAMPLE BOARD LAYOUT

DBZ0003A

SOT-23 - 1.12 mm max height

SMALL OUTLINE TRANSISTOR



LAND PATTERN EXAMPLE
SCALE:15X

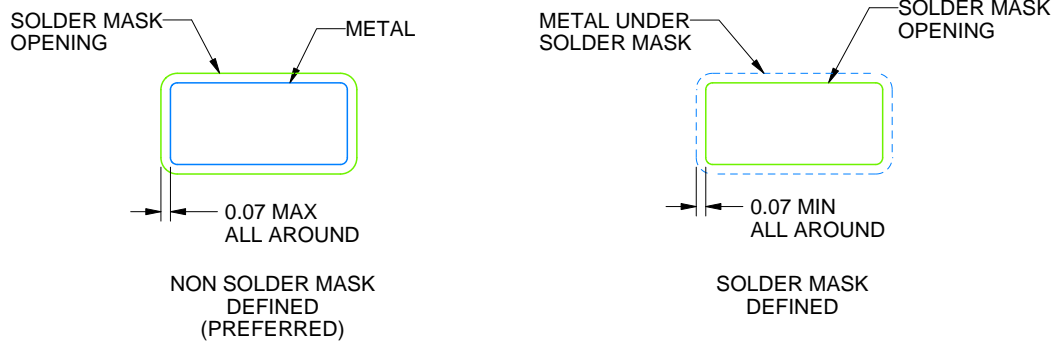

SOLDER MASK DETAILS

4214838/F 08/2024

NOTES: (continued)

- 5. Publication IPC-7351 may have alternate designs.
- 6. Solder mask tolerances between and around signal pads can vary based on board fabrication site.

EXAMPLE STENCIL DESIGN

DBZ0003A

SOT-23 - 1.12 mm max height

SMALL OUTLINE TRANSISTOR

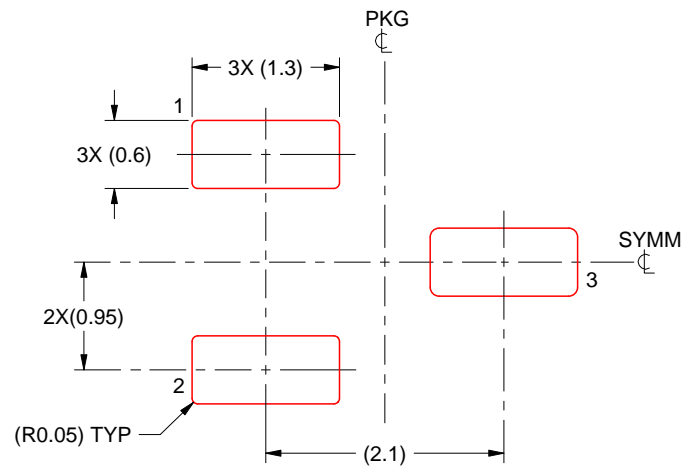

SOLDER PASTE EXAMPLE
BASED ON 0.125 THICK STENCIL
SCALE:15X

4214838/F 08/2024

NOTES: (continued)

7. Laser cutting apertures with trapezoidal walls and rounded corners may offer better paste release. IPC-7525 may have alternate design recommendations.
8. Board assembly site may have different recommendations for stencil design.

DCK0005A



PACKAGE OUTLINE

SOT - 1.1 max height

SMALL OUTLINE TRANSISTOR

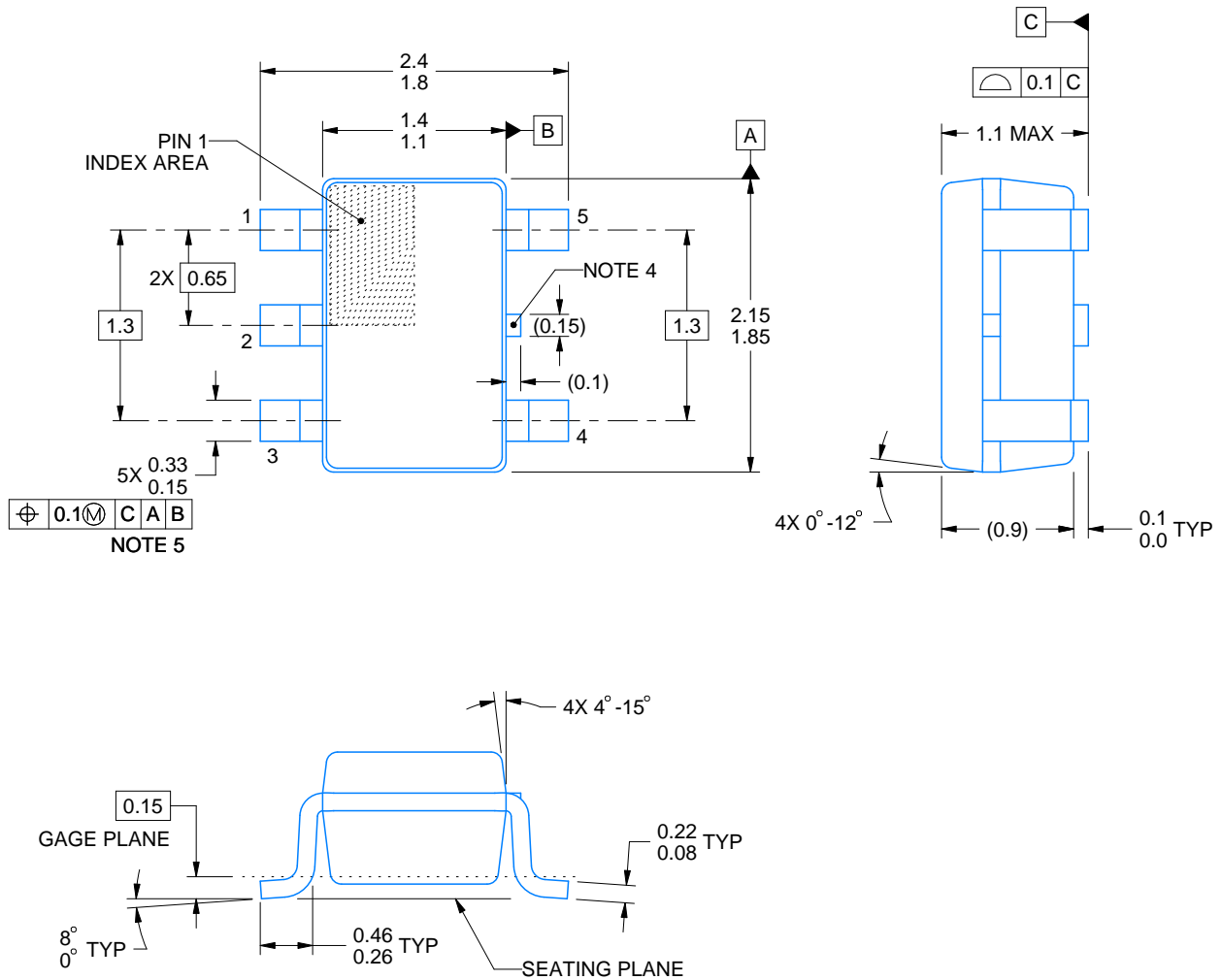

4214834/G 11/2024

NOTES:

1. All linear dimensions are in millimeters. Any dimensions in parenthesis are for reference only. Dimensioning and tolerancing per ASME Y14.5M.
2. This drawing is subject to change without notice.
3. Reference JEDEC MO-203.
4. Support pin may differ or may not be present.
5. Lead width does not comply with JEDEC.
6. Body dimensions do not include mold flash, protrusions, or gate burrs. Mold flash, protrusions, or gate burrs shall not exceed 0.25mm per side

EXAMPLE BOARD LAYOUT

DCK0005A

SOT - 1.1 max height

SMALL OUTLINE TRANSISTOR



LAND PATTERN EXAMPLE
EXPOSED METAL SHOWN
SCALE:18X



SOLDER MASK DETAILS

4214834/G 11/2024

NOTES: (continued)

- 7. Publication IPC-7351 may have alternate designs.
- 8. Solder mask tolerances between and around signal pads can vary based on board fabrication site.

EXAMPLE STENCIL DESIGN

DCK0005A

SOT - 1.1 max height

SMALL OUTLINE TRANSISTOR



SOLDER PASTE EXAMPLE
BASED ON 0.125 THICK STENCIL
SCALE:18X

4214834/G 11/2024

NOTES: (continued)

9. Laser cutting apertures with trapezoidal walls and rounded corners may offer better paste release. IPC-7525 may have alternate design recommendations.
10. Board assembly site may have different recommendations for stencil design.

重要なお知らせと免責事項

TI は、技術データと信頼性データ (データシートを含みます)、設計リソース (リファレンス デザインを含みます)、アプリケーションや設計に関する各種アドバイス、Web ツール、安全性情報、その他のリソースを、欠陥が存在する可能性のある「現状のまま」提供しており、商品性および特定目的に対する適合性の黙示保証、第三者の知的財産権の非侵害保証を含むいかなる保証も、明示的または黙示的にかかわらず拒否します。

これらのリソースは、TI 製品を使用する設計の経験を積んだ開発者への提供を意図したものです。(1) お客様のアプリケーションに適した TI 製品の選定、(2) お客様のアプリケーションの設計、検証、試験、(3) お客様のアプリケーションに該当する各種規格や、その他のあらゆる安全性、セキュリティ、規制、または他の要件への確実な適合に関する責任を、お客様のみが単独で負うものとし、

上記の各種リソースは、予告なく変更される可能性があります。これらのリソースは、リソースで説明されている TI 製品を使用するアプリケーションの開発の目的でのみ、TI はその使用をお客様に許諾します。これらのリソースに関して、他の目的で複製することや掲載することは禁止されています。TI や第三者の知的財産権のライセンスが付与されている訳ではありません。お客様は、これらのリソースを自身で使用した結果発生するあらゆる申し立て、損害、費用、損失、責任について、TI およびその代理人を完全に補償するものとし、TI は一切の責任を拒否します。

TI の製品は、[TI の販売条件](#)、[TI の総合的な品質ガイドライン](#)、[ti.com](#) または TI 製品などに関連して提供される他の適用条件に従い提供されます。TI がこれらのリソースを提供することは、適用される TI の保証または他の保証の放棄の拡大や変更を意味するものではありません。TI がカスタム、またはカスタマー仕様として明示的に指定していない限り、TI の製品は標準的なカタログに掲載される汎用機器です。

お客様がいかなる追加条項または代替条項を提案する場合も、TI はそれらに異議を唱え、拒否します。

Copyright © 2026, Texas Instruments Incorporated

最終更新日 : 2025 年 10 月