

# TPS2223, TPS2224, TPS2226 DUAL-SLOT CARDBUS POWER-INTERFACE SWITCHES FOR SERIAL PCMCIA CONTROLLERS

SLVS317 – MAY 2001

## features

- Fully Integrated  $V_{CC}$  and  $V_{pp}$  Switching for 3.3 V, 5 V, and 12 V (no 12 V on TPS2223)
- Meets Current PC Card™ Standards
- $V_{pp}$  Output Selection Independent of  $V_{CC}$
- 12-V and 5-V Supplies Can Be Disabled
- TTL-Logic Compatible Inputs
- Short-Circuit and Thermal Protection
- 24-Pin HTSSOP, 24- or 30-Pin SSOP
- 140- $\mu$ A (Typical) Quiescent Current from 3.3-V Input
- Break-Before-Make Switching
- Power-On Reset
- -40°C to 85°C Operating Ambient Temperature Range

## applications

- Notebook and Desktop Computers
- Bar Code Scanners
- Digital Cameras
- Set-Top Boxes
- PDAs

## description

The TPS2223, TPS2224 and TPS2226 Card-Bus™ power-interface switches provide an integrated power-management solution for two PC Card sockets. These devices allow the controlled distribution of 3.3 V, 5 V, and 12 V to each card slot. The current-limiting and thermal-protection features eliminate the need for fuses. Current-limit reporting helps the user isolate a system fault. The switch  $r_{DS(on)}$  and current-limit values have been set for the peak and average current requirements stated in the PC Card specification, and optimized for cost.

Like the TPS2214 and TPS2214A and the TPS2216 and TPS2216A, this family of devices supports independent VPP/VCC switching; however, the standby and interface-mode pins are not supported. Shutdown mode is now supported independently on SHDN as well as in the serial interface. Optimized for lower power implementation, the TPS2223 does not support 12-V switching to VPP. See the available options table for pin-compatible device information.

TPS2223, TPS2224  
DB OR PWP PACKAGE  
(TOP VIEW)

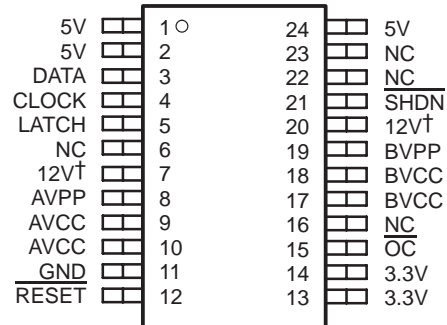

NC – No internal connection

† Pin 7 and 20 are NC for TPS2223.

## AVAILABLE OPTIONS

$T_A$	PACKAGED DEVICES			
	PLASTIC SMALL OUTLINE			PowerPAD™ PLASTIC SMALL OUTLINE (PWP-24)†
	DB-24		DB-30	
-40°C to 85°C	TPS2223DB, TPS2224DB		TPS2226DB	
	Pin compatibles	TPS2214, TPS2214A	Pin compatibles	TPS2216, TPS2216A, TPS2206
				TPS2223PWP, TPS2224PWP

† The DB and PWP packages are also available taped and reeled. Add R suffix to device type (e.g., TPS2223PWPR) for taped and reeled.



Please be aware that an important notice concerning availability, standard warranty, and use in critical applications of Texas Instruments semiconductor products and disclaimers thereto appears at the end of this data sheet.

PowerPAD is a trademark of Texas Instruments.

CardBus and PC Card are trademarks of PCMCIA (Personal Computer Memory Card International Association).

PRODUCTION DATA information is current as of publication date. Products conform to specifications per the terms of Texas Instruments standard warranty. Production processing does not necessarily include testing of all parameters.



POST OFFICE BOX 655303 • DALLAS, TEXAS 75265

Copyright © 2001, Texas Instruments Incorporated

# TPS2223, TPS2224, TPS2226 DUAL-SLOT CARDBUS POWER-INTERFACE SWITCHES FOR SERIAL PCMCIA CONTROLLERS

SLVS317 – MAY 2001

TPS2226  
DB PACKAGE  
(TOP VIEW)

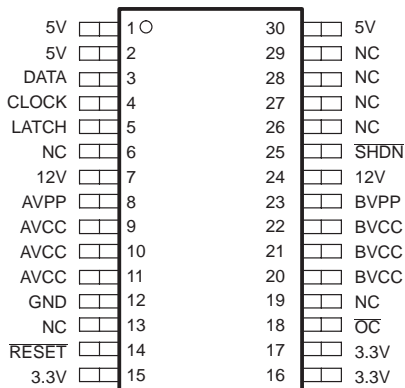

NC – No internal connection

## functional block diagram†

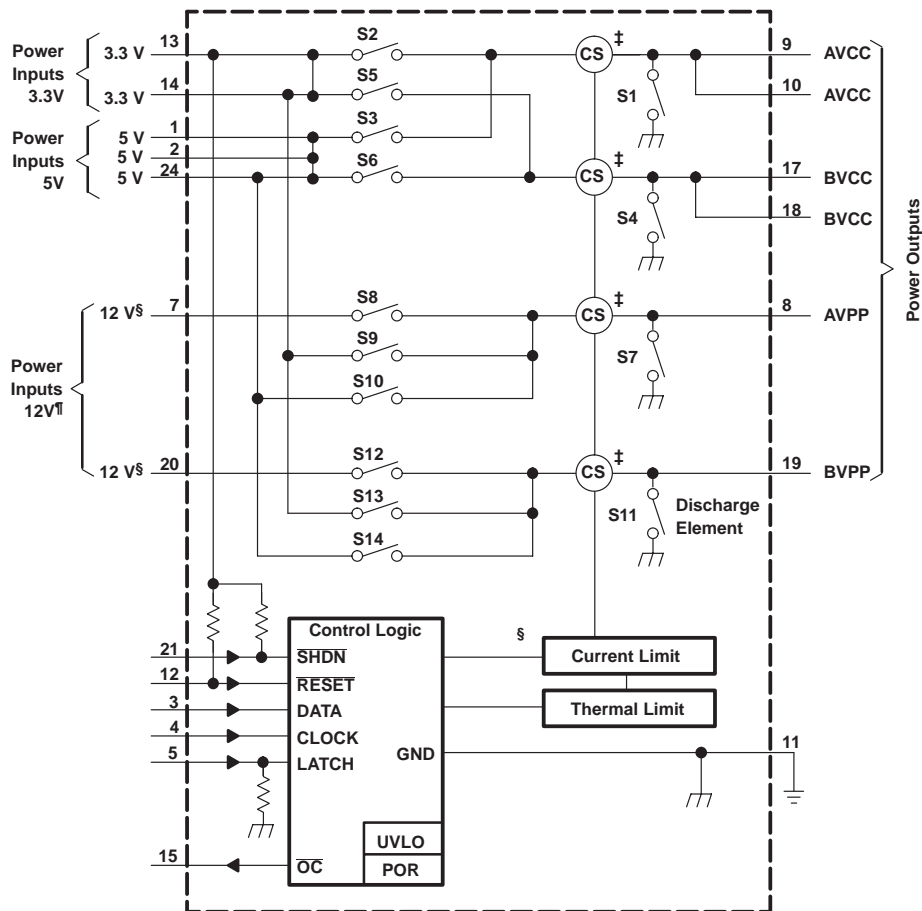

† Diagram shown for 24-pin DB package.

‡ Current sense

§ The two 12-V pins must be externally connected.

¶ No Connections for TPS2223

**TPS2223, TPS2224, TPS2226**  
**DUAL-SLOT CARDBUS POWER-INTERFACE SWITCHES**  
**FOR SERIAL PCMCIA CONTROLLERS**

SLVS317 – MAY 2001

**Terminal Functions**

TERMINAL				I/O	DESCRIPTION
NAME	NO.				
	TPS2223	TPS2224	TPS2226		
3.3V	13, 14	13, 14	15, 16, 17	I	3.3-V input for card power and chip power
5V	1, 2, 24	1, 2, 24	1, 2, 30	I	5-V input for card power
12V	NA	7, 20	7, 24	I	12-V input for card power (xVPP). The two 12-V pins must be externally connected.
AVCC	9, 10	9, 10	9, 10, 11	O	Switched output that delivers 3.3 V, 5 V, ground or high impedance to card
AVPP	8	8	8	O	Switched output that delivers 3.3 V, 5 V, 12 V, ground or high impedance to card (12 V not applicable to TPS2223)
BVCC	17, 18	17, 18	20, 21, 22	O	Switched output that delivers 3.3 V, 5 V, ground or high impedance to card
BVPP	19	19	23	O	Switched output that delivers 3.3 V, 5 V, 12 V, ground or high impedance to card (12 V not applicable for TPS2223)
GND	11	11	12		Ground
$\overline{\text{OC}}$	15	15	18	O	Open-drain overcurrent reporting output that goes low when an overcurrent condition exists. An external pullup is required.
$\overline{\text{SHDN}}$	21	21	25	I	Hi-Z (open) all switches. Identical function to serial D8. Asynchronous active-low command, internal pullup
$\overline{\text{RESET}}$	12	12	14	I	Logic-level RESET input active low. Asynchronous active-low command, internal pullup
CLOCK	4	4	4	I	Logic-level clock for serial data word
DATA	3	3	3	I	Logic-level serial data word
LATCH	5	5	5	I	Logic-level latch for serial data word, internal pulldown
NC	6, 7, 16, 20, 22, 23	6, 16, 22, 23	6, 13, 19, 26–29		No internal connection

# TPS2223, TPS2224, TPS2226 DUAL-SLOT CARDBUS POWER-INTERFACE SWITCHES FOR SERIAL PCMCIA CONTROLLERS

SLVS317 – MAY 2001

## absolute maximum ratings over operating free-air temperature (unless otherwise noted)†

Input voltage range for card power: $V_{I(3.3V)}$ .....	-0.3 V to 5.5 V
$V_{I(5V)}$ .....	-0.3 V to 5.5 V
$V_{I(12V)}^{\ddagger}$ .....	-0.3 V to 14 V
Logic input/output voltage .....	-0.3 V to 6 V
Output voltage: $V_{O(xVCC)}$ .....	-0.3 V to 6 V
$V_{O(xVPP)}$ .....	-0.3 V to 14 V
Continuous total power dissipation .....	See Dissipation Rating Table
Output current: $I_{O(xVCC)}$ .....	Internally Limited
$I_{O(xVPP)}$ .....	Internally Limited
Operating virtual junction temperature range, $T_J$ .....	-40°C to 100°C
Storage temperature range, $T_{STG}$ .....	-55°C to 150°C
Lead temperature 1.6 mm (1/16 inch) from case for 10 seconds) .....	260°C
$\overline{OC}$ sink current .....	10 mA

† Stresses beyond those listed under “absolute maximum ratings” may cause permanent damage to the device. These are stress ratings only, and functional operation of the device at these or any other conditions beyond those indicated under “recommended operating conditions” is not implied. Exposure to absolute-maximum-rated conditions for extended periods may affect device reliability.

‡ Not applicable for TPS2223

DISSIPATION RATING TABLE

PACKAGE§		$T_A \leq 25^\circ\text{C}$ POWER RATING	DERATING FACTOR ABOVE $T_A = 25^\circ\text{C}$	$T_A = 70^\circ\text{C}$ POWER RATING	$T_A = 85^\circ\text{C}$ POWER RATING
DB	24	890 mW	8.9 mW/°C	489 mW	356 mW
	30	1095 mW	10.95 mW/°C	602 mW	438 mW
PWP	24	3322 mW	33.22 mW/°C	1827 mW	1329 mW

§ These devices are mounted on an JEDEC low-k board (2-oz. traces on surface).

## recommended operating conditions

		MIN	MAX	UNIT
Input voltage, $V_{I(3.3V)}$ is required for all circuit operations. 5V and 12V are only required for their respective functions.	$V_{I(3.3V)}^{\text{¶}}$	3	3.6	V
	$V_{I(5V)}$	3	5.5	
	$V_{I(12V)}^{\ddagger}$	7	13.5	
Output current, $I_O$	$I_{O(xVCC)}$ at $T_J = 100^\circ\text{C}$		1	A
	$I_{O(xVPP)}$ at $T_J = 100^\circ\text{C}$		100	mA
Clock frequency, $f_{(\text{clock})}$			2.5	MHz
Pulse duration, $t_w$	Data		200	ns
	Latch		250	
	Clock		100	
	Reset		100	
Data-to-clock hold time (see Figure 2)			100	ns
Data-to-clock setup time, $t_{su}$ (see Figure 2)			100	ns
Latch delay time, $t_{d(\text{latch})}$ (see Figure 2)			100	ns
Clock delay time, $t_{d(\text{clock})}$ (see Figure 2)			250	ns
Operating virtual junction temperature, $T_J$ (maximum to be calculated at worst cast $P_D$ at 85°C ambient)		-40	100	°C

‡ Not applicable for TPS2223

¶ It is understood that for  $V_{I(3.3V)} < 3$  V, voltages within the absolute maximum ratings applied to pin 5V or pin 12V will not damage the IC.



**TPS2223, TPS2224, TPS2226**  
**DUAL-SLOT CARDBUS POWER-INTERFACE SWITCHES**  
**FOR SERIAL PCMCIA CONTROLLERS**

SLVS317 – MAY 2001

electrical characteristics,  $T_J = 25^\circ\text{C}$ ,  $V_I(5\text{V}) = 5\text{ V}$ ,  $V_I(3.3\text{V}) = 3.3\text{ V}$ ,  $V_I(12\text{V}) = 12\text{ V}$  (not applicable for TPS2223), all outputs unloaded (unless otherwise noted)

**power switch**

PARAMETER		TEST CONDITIONS†		MIN	TYP	MAX	UNIT
$r_{DS(on)}$	Static drain-source on-state resistance	3.3V to xVCC, with two switches on	$I_O = 750\text{ mA}$ each		85	110	m $\Omega$
			$I_O = 750\text{ mA}$ each, $T_J = 100^\circ\text{C}$		110	140	
		5V to xVCC, with two switches on	$I_O = 500\text{ mA}$ each		95	130	
			$I_O = 500\text{ mA}$ each, $T_J = 100^\circ\text{C}$		120	160	
		3.3V or 5V to xVPP, with two switches on	$I_O = 50\text{ mA}$ each		0.8	1	$\Omega$
			$I_O = 50\text{ mA}$ each, $T_J = 100^\circ\text{C}$		1	1.3	
	12V to xVPP, with two switches on	$I_O = 50\text{ mA}$ each		2	2.5		
		$I_O = 50\text{ mA}$ each, $T_J = 100^\circ\text{C}$		2.5	3.4		
Output discharge resistance	Discharge at xVCC	$I_O(\text{disc}) = 1\text{ mA}$		0.5	0.7	1	k $\Omega$
	Discharge at xVPP	$I_O(\text{disc}) = 1\text{ mA}$		0.2	0.4	0.5	
$I_{OS}$	Short-circuit output current	Limit (steady-state value), output powered into a short circuit	$I_{OS}(xVCC)$	1	1.4	2	A
			$I_{OS}(xVPP)$	120	200	300	mA
		Limit (steady-state value), output powered into a short circuit, $T_J = 100^\circ\text{C}$	$I_{OS}(xVCC)$	1	1.4	2	A
			$I_{OS}(xVPP)$	120	200	300	mA
Thermal shutdown temperature (see Note 1)	Thermal trip point, $T_J$	Rising temperature			135		$^\circ\text{C}$
	Hysteresis, $T_J$				10		
Current-limit response time (see Note 1)		$V_O(xVCC)$ with 100-m $\Omega$ short, from short to OC signal falling edge			10		$\mu\text{s}$
		$V_O(xVPP)$ with 100-m $\Omega$ short, from short to OC signal falling edge			3		
$I_I$	Input current, quiescent	Normal operation and reset mode	$I_I(3.3\text{V})$		140	200	$\mu\text{A}$
			$I_I(5\text{V})$		8	12	
			$I_I(12\text{V})$		100	180	
	Shutdown mode, $V_O(xVCC) = \text{Hi-Z}$ , $V_O(xVPP) = \text{Hi-Z}$	$I_I(3.3\text{V})$		0.3	2		
		$I_I(5\text{V})$		0.1	2		
		$I_I(12\text{V})$		0.3	2		
$I_{lkg}$	Leakage current, output off state	Shutdown mode	$V_O(xVCC) = 5\text{ V}$ , $V_I(5\text{V}) = V_I(12\text{V}) = 0$	$T_J = 100^\circ\text{C}$		10	$\mu\text{A}$
			$V_O(xVPP) = 12\text{ V}$ , $V_I(5\text{V}) = V_I(12\text{V}) = 0$	$T_J = 100^\circ\text{C}$		50	
						10	
						50	

† Pulse-testing techniques maintain junction temperature close to ambient temperature; thermal effects must be taken into account separately.  
 NOTE 1: Specified by design; not tested in production.

**TPS2223, TPS2224, TPS2226**  
**DUAL-SLOT CARDBUS POWER-INTERFACE SWITCHES**  
**FOR SERIAL PCMCIA CONTROLLERS**

SLVS317 – MAY 2001

electrical characteristics,  $T_J = 25^\circ\text{C}$ ,  $V_{I(5V)} = 5\text{ V}$ ,  $V_{I(3.3V)} = 3.3\text{ V}$ ,  $V_{I(12V)} = 12\text{ V}$  (not applicable for TPS2223), all outputs unloaded (unless otherwise noted) (continued)

**logic section (CLOCK, DATA, LATCH,  $\overline{\text{RESET}}$ ,  $\overline{\text{SHDN}}$ ,  $\overline{\text{OC}}$ )**

PARAMETER		TEST CONDITIONS	MIN	TYP	MAX	UNIT
$I_I$	Input current, logic	$\overline{\text{RESET}} = 5.5\text{ V}$	-1		1	$\mu\text{A}$
		$\overline{\text{RESET}} = 0\text{ V}$	-30	-20	-10	
	$I_I(\overline{\text{SHDN}})$ (see Note 2)	$\overline{\text{SHDN}} = 5.5\text{ V}$	-1		1	
		$\overline{\text{SHDN}} = 0\text{ V}$	-50		-3	
	$I_I(\text{LATCH})$ (see Note 2)	LATCH = 5.5 V			50	
		LATCH = 0 V	-1		1	
$I_I(\text{CLOCK, DATA})$	0 V to 5.5 V	-1		1		
$V_{IH}$	High-level input voltage, logic		2			V
$V_{IL}$	Low-level input voltage, logic				0.8	V
$V_{O(\text{sat})}$	Output saturation voltage at $\overline{\text{OC}}$	$I_O = 2\text{ mA}$		0.14	0.4	V
$I_{Ikg}$	Leakage current at $\overline{\text{OC}}$	$V_{O(\overline{\text{OC}})} = 5.5\text{ V}$		0	1	$\mu\text{A}$

NOTE 2: LATCH has low current pulldown.  $\overline{\text{RESET}}$  and  $\overline{\text{SHDN}}$  have low-current pullup.

**UVLO and POR (power-on reset)**

PARAMETER		TEST CONDITIONS	MIN	TYP	MAX	UNIT
$V_{I(3.3V)}$	Input voltage at 3.3V pin, UVLO	3.3 V level below which all switches are Hi-Z	2.4	2.7	2.9	V
$V_{hys(3.3V)}$	UVLO hysteresis voltage at VA (see Note 1)		70	100		mV
$V_{I(5V)}$	Input voltage at 5V pin, UVLO	5 V level below which only 5V switches are Hi-Z	2.3	2.5	2.9	V
$V_{hys(5V)}$	UVLO hysteresis voltage at 5V (see Note 1)		70	100		mV
$t_{df}$	Delay time for falling response, UVLO (see Note 1)	Delay from voltage hit (step from 3 V to 2.3 V) to Hi-Z control (90% $V_G$ to GND)		4		$\mu\text{s}$
$V_{I(\text{POR})}$	Input voltage, power-on reset (see Note 1)	3.3 V voltage below which POR is asserted causing a RESET internally with all line switches open and all discharge switches closed.			1.7	V

NOTE 1: Specified by design; not tested in production.



**TPS2223, TPS2224, TPS2226**  
**DUAL-SLOT CARDBUS POWER-INTERFACE SWITCHES**  
**FOR SERIAL PCMCIA CONTROLLERS**

SLVS317 – MAY 2001

switching characteristics,  $V_{CC} = 5\text{ V}$ ,  $T_A = 25^\circ\text{C}$ ,  $V_{I(3.3V)} = 3.3\text{ V}$ ,  $V_{I(5V)} = 5\text{ V}$ ,  $V_{I(12)} = 12\text{ V}$  (not applicable for TPS2223) all outputs unloaded (unless otherwise noted)

PARAMETER†	LOAD CONDITION	TEST CONDITIONS‡	MIN	TYP	MAX	UNIT
$t_r$ Output rise times (see Note 1)	$C_L(xVCC) = 0.1\ \mu\text{F}$ , $C_L(xVPP) = 0.1\ \mu\text{F}$ , $I_O(xVCC) = 0\ \text{A}$ , $I_O(xVPP) = 0\ \text{A}$	$V_O(xVCC) = 5\ \text{V}$		0.9		ms
		$V_O(xVPP) = 12\ \text{V}$		0.26		
	$C_L(xVCC) = 150\ \mu\text{F}$ , $C_L(xVPP) = 10\ \mu\text{F}$ , $I_O(xVCC) = 0.75\ \text{A}$ , $I_O(xVPP) = 50\ \text{mA}$	$V_O(xVCC) = 5\ \text{V}$		1.1		
		$V_O(xVPP) = 12\ \text{V}$		0.6		
$t_f$ Output fall times (see Note 1)	$C_L(xVCC) = 0.1\ \mu\text{F}$ , $C_L(xVPP) = 0.1\ \mu\text{F}$ , $I_O(xVCC) = 0\ \text{A}$ , $I_O(xVPP) = 0\ \text{A}$	$V_O(xVCC) = 5\ \text{V}$ , Discharge switches ON		0.5		ms
		$V_O(xVPP) = 12\ \text{V}$ , Discharge switches ON		0.2		
	$C_L(xVCC) = 150\ \mu\text{F}$ , $C_L(xVPP) = 10\ \mu\text{F}$ , $I_O(xVCC) = 0.75\ \text{A}$ , $I_O(xVPP) = 50\ \text{mA}$	$V_O(xVCC) = 5\ \text{V}$		2.35		
		$V_O(xVPP) = 12\ \text{V}$		3.9		
$t_{pd}$ Propagation delay (see Note 1)	$C_L(xVCC) = 0.1\ \mu\text{F}$ , $C_L(xVPP) = 0.1\ \mu\text{F}$ , $I_O(xVCC) = 0\ \text{A}$ , $I_O(xVPP) = 0\ \text{A}$	Latch↑ to xVPP (12 V)§	$t_{pdon}$	2		ms
			$t_{pdoff}$	0.62		
		Latch↑ to xVPP (5 V)	$t_{pdon}$	0.77		
			$t_{pdoff}$	0.51		
		Latch↑ to xVPP (3.3 V)	$t_{pdon}$	0.75		
			$t_{pdoff}$	0.52		
		Latch↑ to xVCC (5 V)	$t_{pdon}$	0.3		
			$t_{pdoff}$	2.5		
	$C_L(xVCC) = 150\ \mu\text{F}$ , $C_L(xVPP) = 10\ \mu\text{F}$ , $I_O(xVCC) = 0.75\ \text{A}$ , $I_O(xVPP) = 50\ \text{mA}$	Latch↑ to xVPP (12 V)§	$t_{pdon}$	2.2		ms
			$t_{pdoff}$	0.8		
		Latch↑ to xVPP (5 V)	$t_{pdon}$	0.8		
			$t_{pdoff}$	0.6		
		Latch↑ to xVPP (3.3 V)	$t_{pdon}$	0.8		
			$t_{pdoff}$	0.6		
Latch↑ to xVCC (5 V)	$t_{pdon}$	0.6				
	$t_{pdoff}$	2.5				
Latch↑ to xVCC (3.3V)	$t_{pdon}$	0.5				
	$t_{pdoff}$	2.6				

† Refer to Parameter Measurement Information in Figure 1.

‡ No card inserted, assumes a 0.1- $\mu\text{F}$  output capacitor (see Figure 1).

§ Not applicable for TPS2223

NOTE 1: Specified by design; not tested in production.



# TPS2223, TPS2224, TPS2226 DUAL-SLOT CARDBUS POWER-INTERFACE SWITCHES FOR SERIAL PCMCIA CONTROLLERS

SLVS317 – MAY 2001

## PARAMETER MEASUREMENT INFORMATION

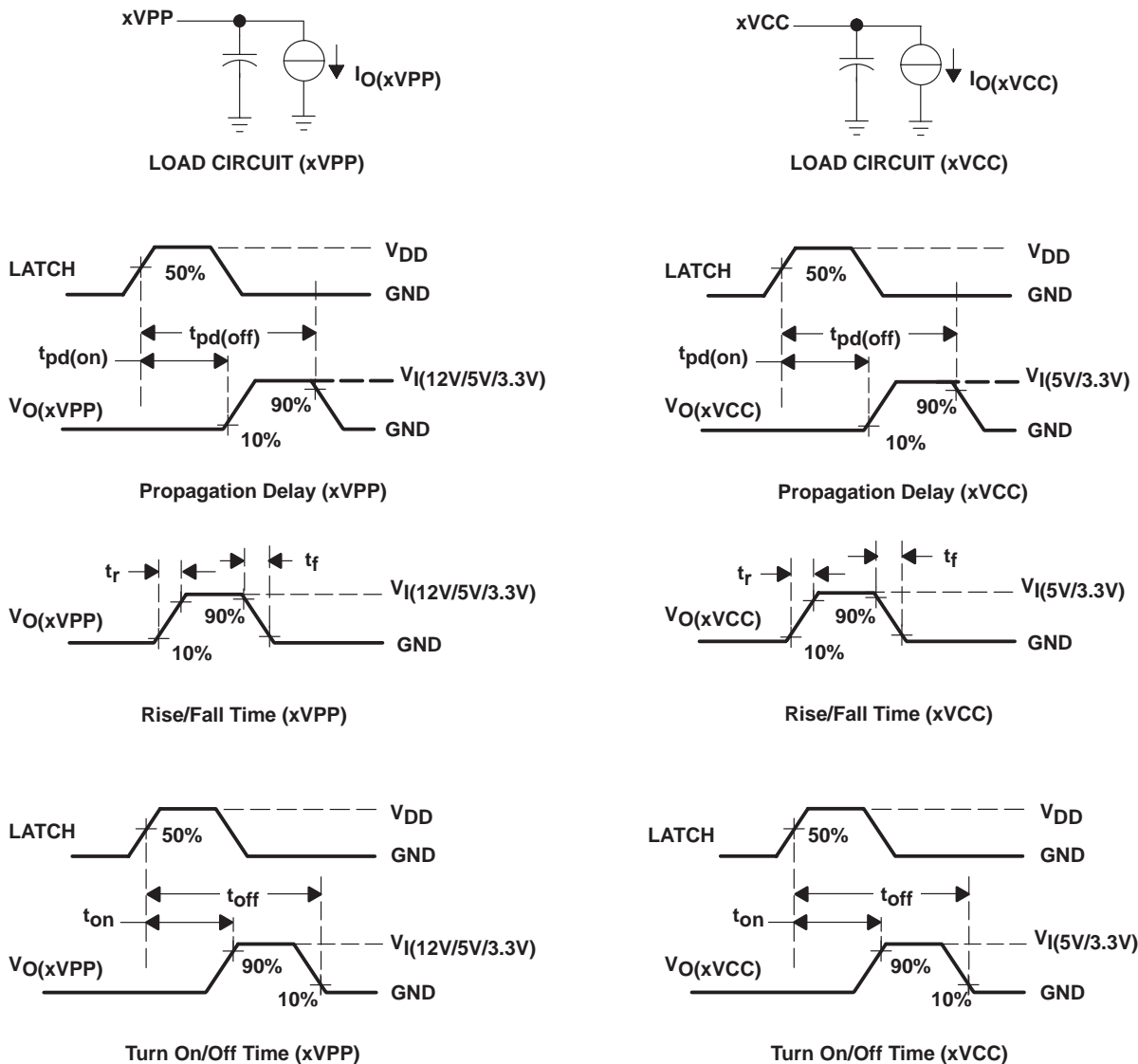

## VOLTAGE WAVEFORMS

Figure 1. Test Circuits and Voltage Waveforms



**TPS2223, TPS2224, TPS2226**  
**DUAL-SLOT CARDBUS POWER-INTERFACE SWITCHES**  
**FOR SERIAL PCMCIA CONTROLLERS**

SLVS317 – MAY 2001

**PARAMETER MEASUREMENT INFORMATION**

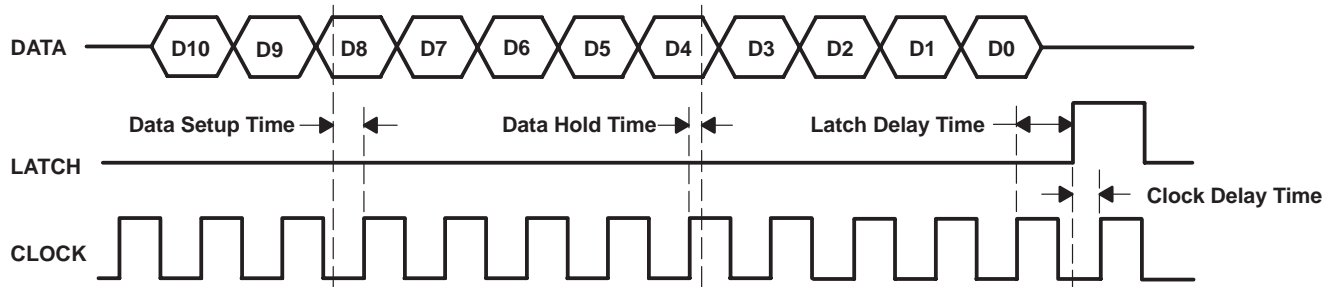

NOTE: Data is clocked in on the positive edge of the clock. The positive edge of the latch signal should occur before the next positive edge of the clock. For definition of D0 to D10, see the control logic table.

**Figure 2. Serial-Interface Timing for TPS2226**

**Table of Graphs**

		<b>FIGURE</b>
Short-circuit response, short applied to powered-on 5-V xVCC-switch output	vs Time	3
Short-circuit response, short applied to powered-on 12-V xVPP-switch output	vs Time	4
$\overline{OC}$ response with ramped overcurrent-limit load on 5-V xVCC-switch output	vs Time	5
$\overline{OC}$ response with ramped overcurrent-limit load on 12-V xVPP-switch output	vs Time	6
xVCC Turnon propagation delay time ( $C_L = 150 \mu\text{F}$ )	vs Junction temperature	7
xVCC Turnoff propagation delay time ( $C_L = 150 \mu\text{F}$ )	vs Junction temperature	8
xVPP Turnon propagation delay time ( $C_L = 10 \mu\text{F}$ )	vs Junction temperature	9
xVPP Turnoff propagation delay time ( $C_L = 10 \mu\text{F}$ )	vs Junction temperature	10
xVCC Turnon propagation delay time ( $T_J = 25^\circ\text{C}$ )	vs Load capacitance	11
xVCC Turnoff propagation delay time ( $T_J = 25^\circ\text{C}$ )	vs Load capacitance	12
xVPP Turnon propagation delay time ( $T_J = 25^\circ\text{C}$ )	vs Load capacitance	13
xVPP Turnoff propagation delay time ( $T_J = 25^\circ\text{C}$ )	vs Load capacitance	14
xVCC Rise time ( $C_L = 150 \mu\text{F}$ )	vs Junction temperature	15
xVCC Fall time ( $C_L = 150 \mu\text{F}$ )	vs Junction temperature	16
xVPP Rise time ( $C_L = 10 \mu\text{F}$ )	vs Junction temperature	17
xVPP Fall time ( $C_L = 10 \mu\text{F}$ )	vs Junction temperature	18
xVCC Rise time ( $T_J = 25^\circ\text{C}$ )	vs Load capacitance	19
xVCC Fall time ( $T_J = 25^\circ\text{C}$ )	vs Load capacitance	20
xVPP Rise time ( $T_J = 25^\circ\text{C}$ )	vs Load capacitance	21
xVPP Fall time ( $T_J = 25^\circ\text{C}$ )	vs Load capacitance	22

**TPS2223, TPS2224, TPS2226  
DUAL-SLOT CARDBUS POWER-INTERFACE SWITCHES  
FOR SERIAL PCMCIA CONTROLLERS**

SLVS317 – MAY 2001

**PARAMETER MEASUREMENT INFORMATION**

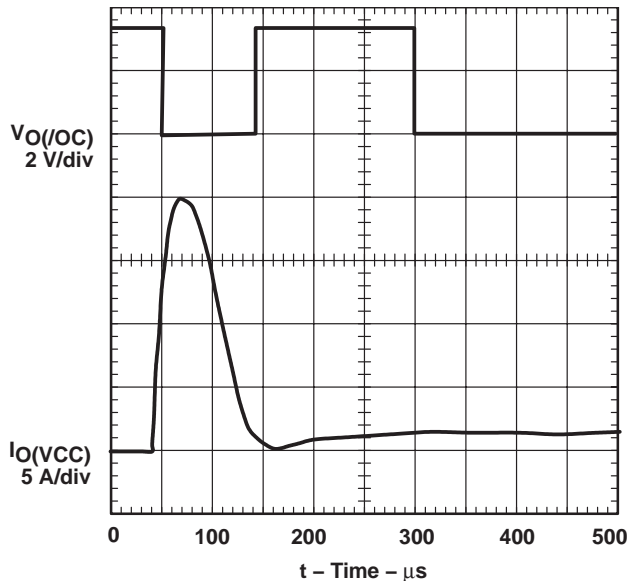

**Figure 3. Short-Circuit Response, Short Applied to Powered-on 5-V xVCC-Switch Output**

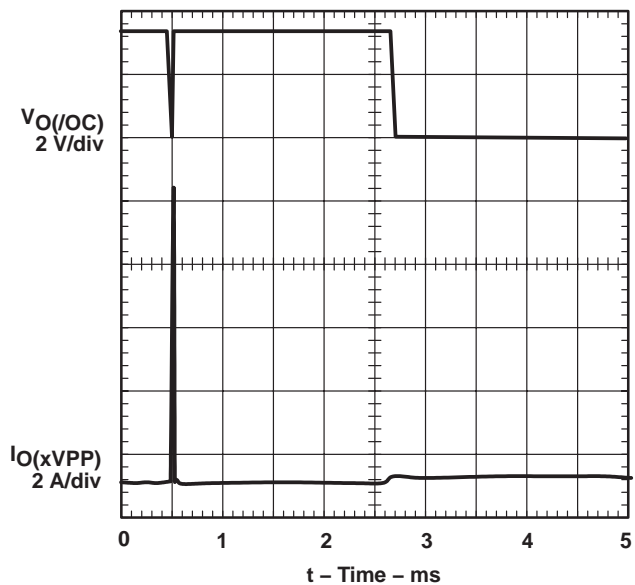

**Figure 4. Short-Circuit Response, Short Applied to Powered-on 12-V xVPP-Switch Output**

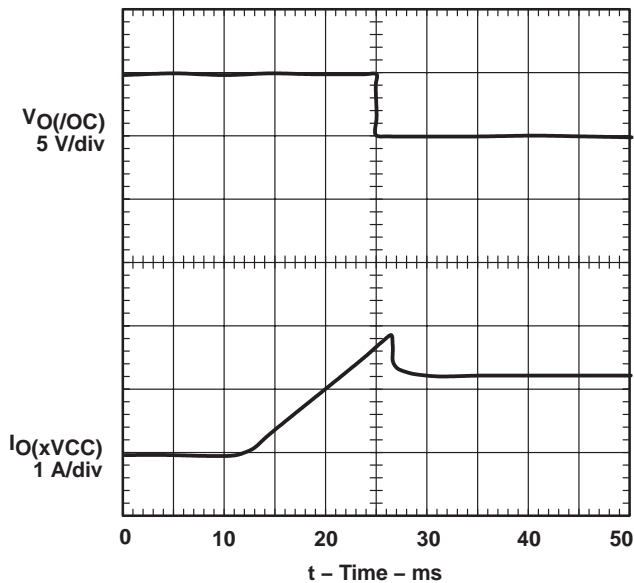

**Figure 5.  $\overline{OC}$  Response With Ramped Overcurrent-Limit Load on 5-V xVCC-Switch Output**

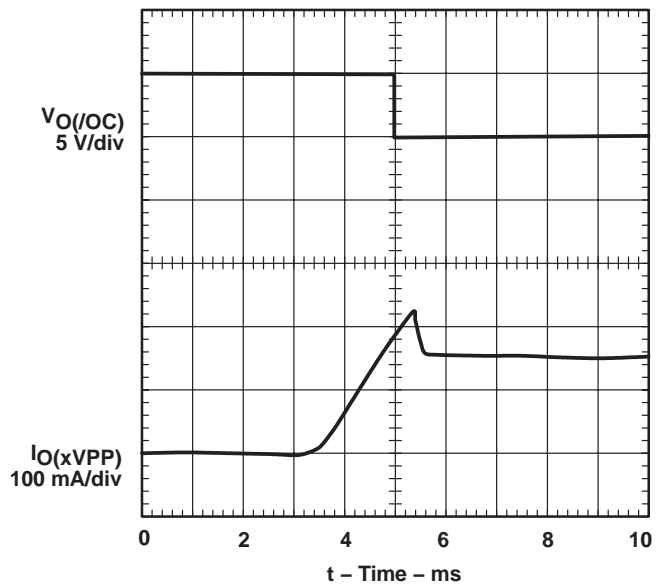

**Figure 6.  $\overline{OC}$  Response With Ramped Overcurrent-Limit Load on 12-V xVPP-Switch Output**

PARAMETER MEASUREMENT INFORMATION

TURNON PROPAGATION DELAY TIME, xVCC  
 vs  
 JUNCTION TEMPERATURE

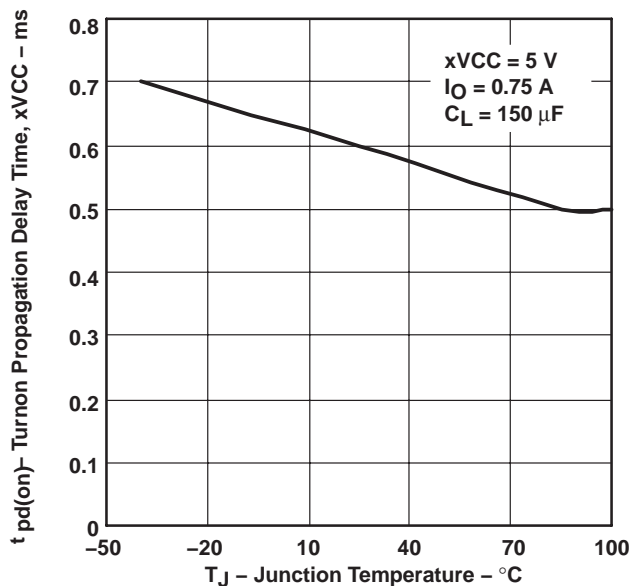

Figure 7

TURNOFF PROPAGATION DELAY TIME, xVCC  
 vs  
 JUNCTION TEMPERATURE

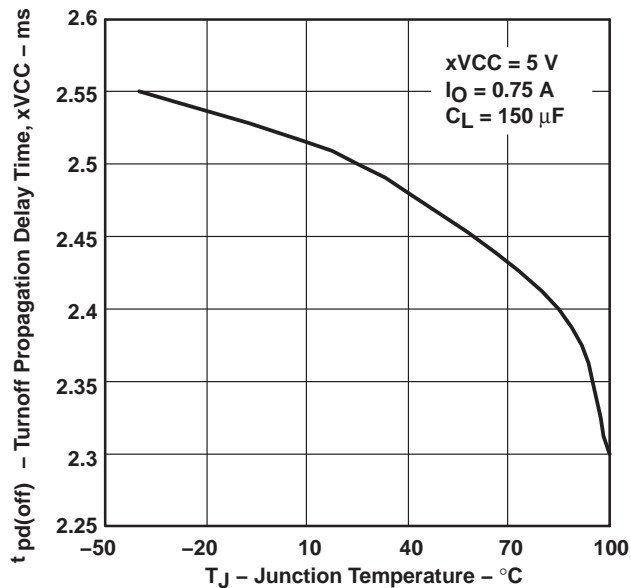

Figure 8

TURNON PROPAGATION DELAY TIME, xVPP  
 vs  
 JUNCTION TEMPERATURE

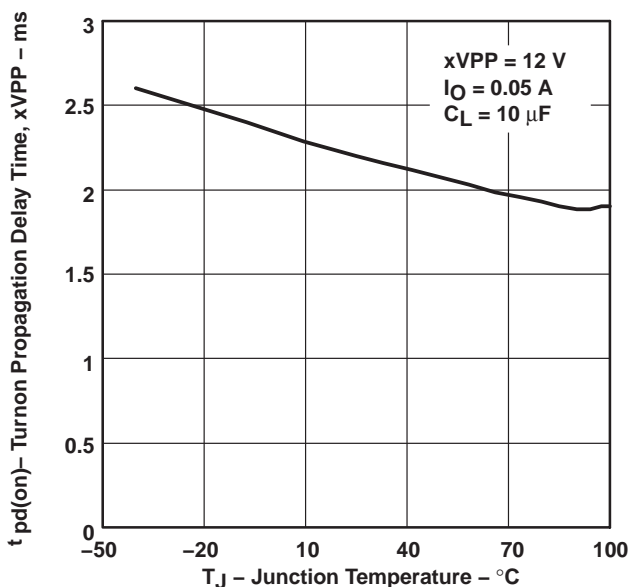

Figure 9

TURNOFF PROPAGATION DELAY TIME, xVPP  
 vs  
 JUNCTION TEMPERATURE

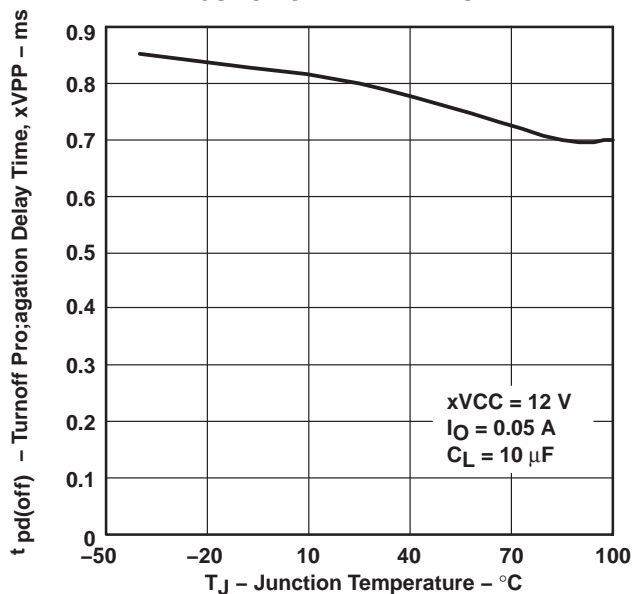

Figure 10

**TPS2223, TPS2224, TPS2226**  
**DUAL-SLOT CARDBUS POWER-INTERFACE SWITCHES**  
**FOR SERIAL PCMCIA CONTROLLERS**

SLVS317 – MAY 2001

**PARAMETER MEASUREMENT INFORMATION**

**TURNON PROPAGATION DELAY TIME, xVCC**  
**VS**  
**LOAD CAPACITANCE**

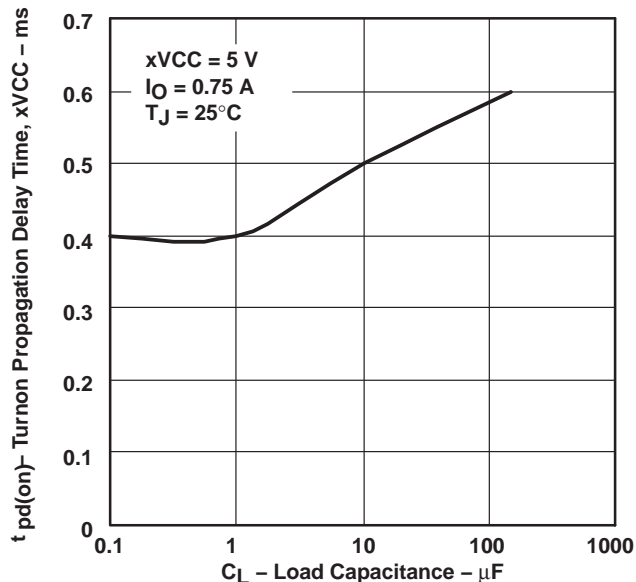

**Figure 11**

**TURNOFF PROPAGATION DELAY TIME, xVCC**  
**VS**  
**LOAD CAPACITANCE**

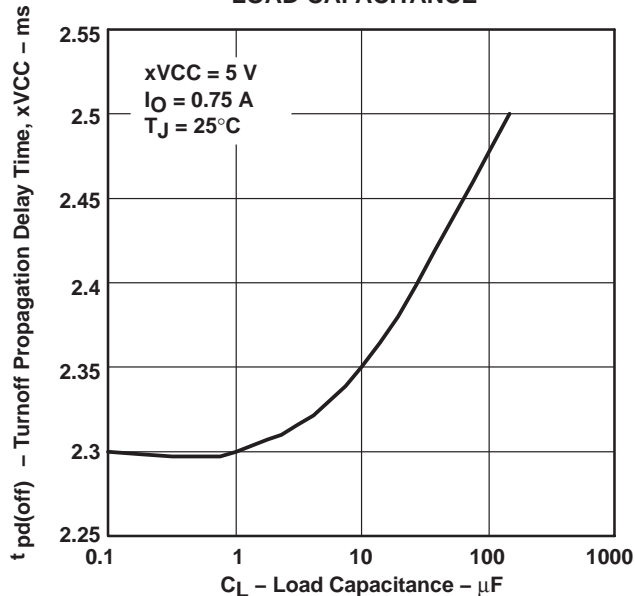

**Figure 12**

**TURNON PROPAGATION DELAY TIME, xVPP**  
**VS**  
**LOAD CAPACITANCE**

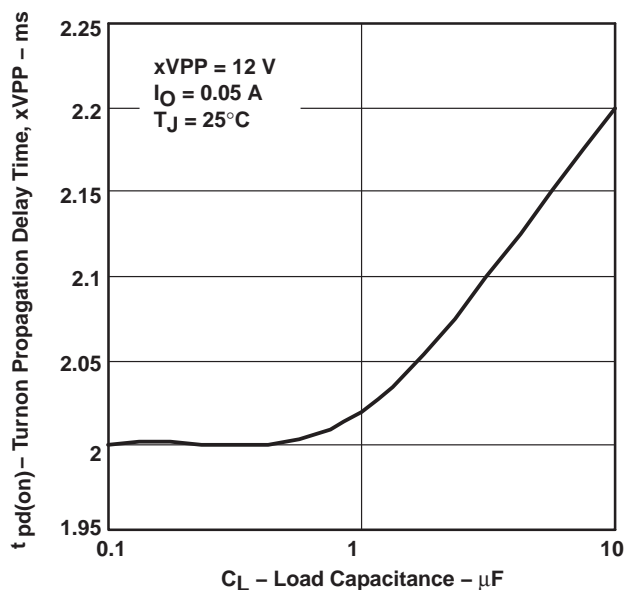

**Figure 13**

**TURNOFF PROPAGATION DELAY TIME, xVPP**  
**VS**  
**LOAD CAPACITANCE**

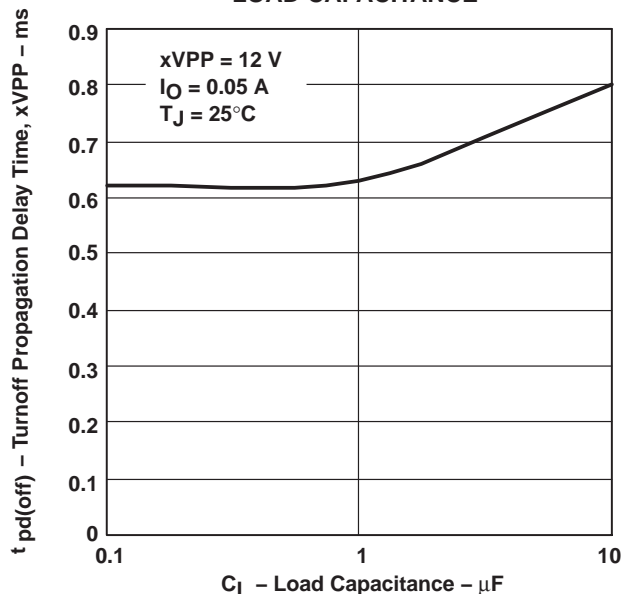

**Figure 14**



PARAMETER MEASUREMENT INFORMATION

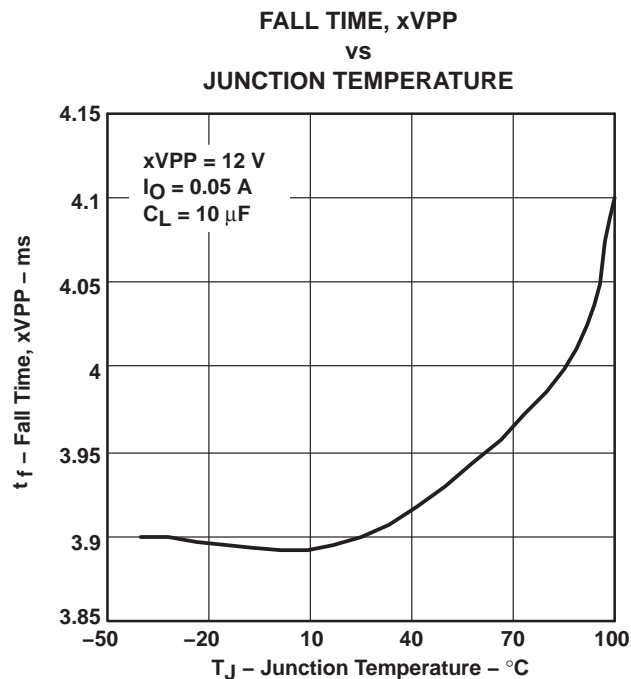
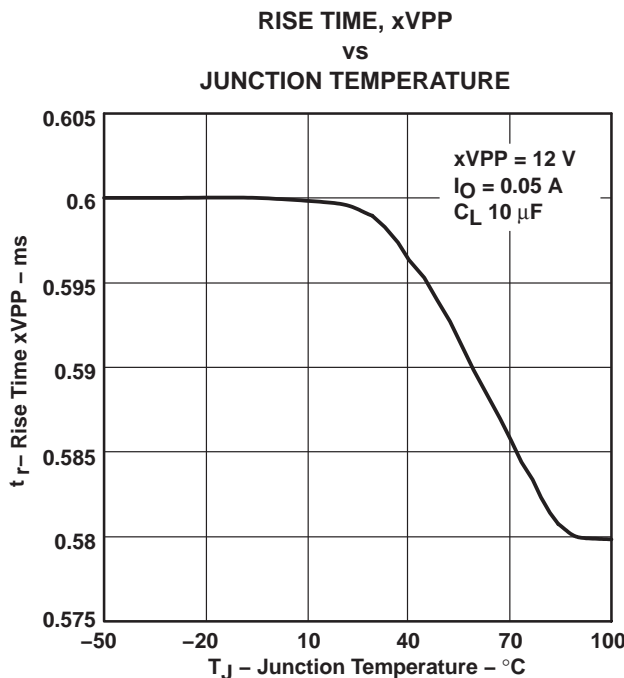
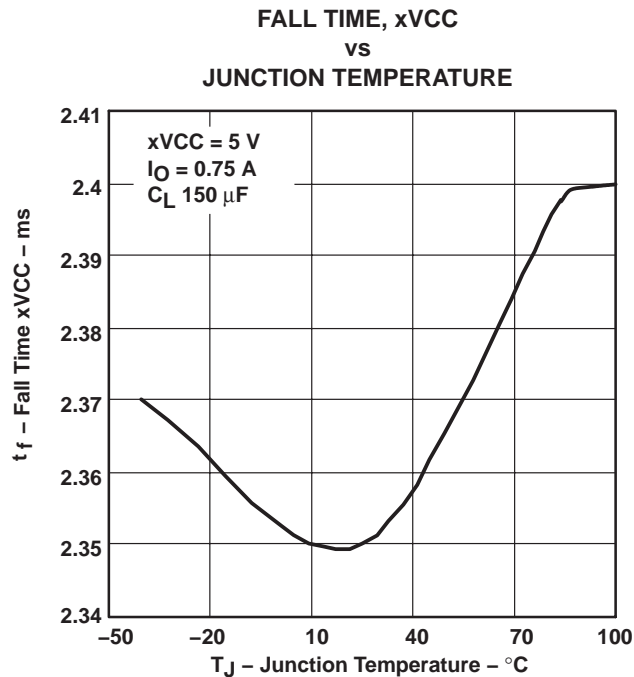
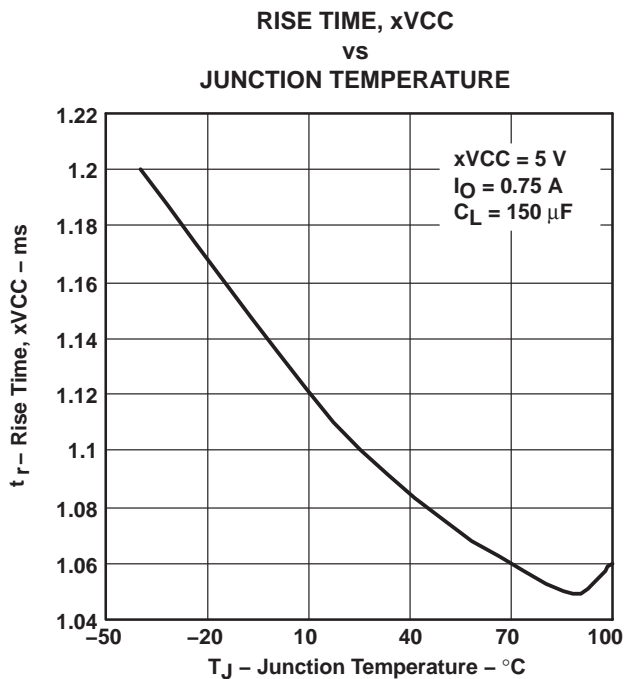

**TPS2223, TPS2224, TPS2226  
DUAL-SLOT CARDBUS POWER-INTERFACE SWITCHES  
FOR SERIAL PCMCIA CONTROLLERS**

SLVS317 – MAY 2001

**PARAMETER MEASUREMENT INFORMATION**

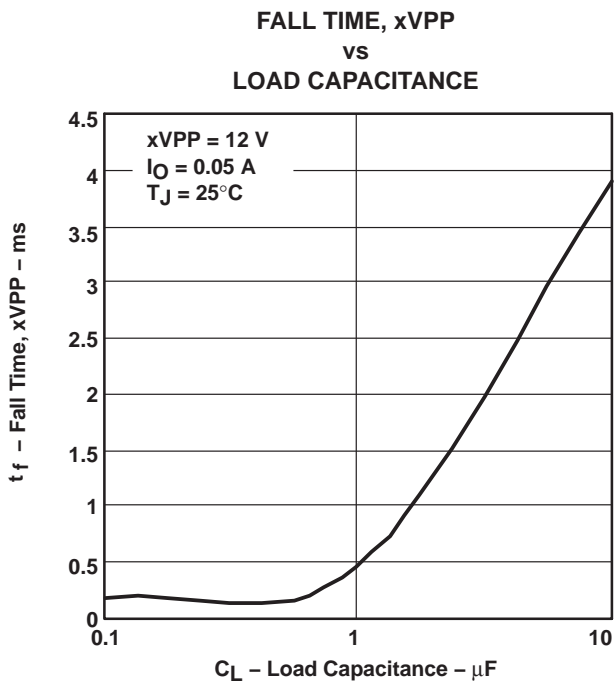
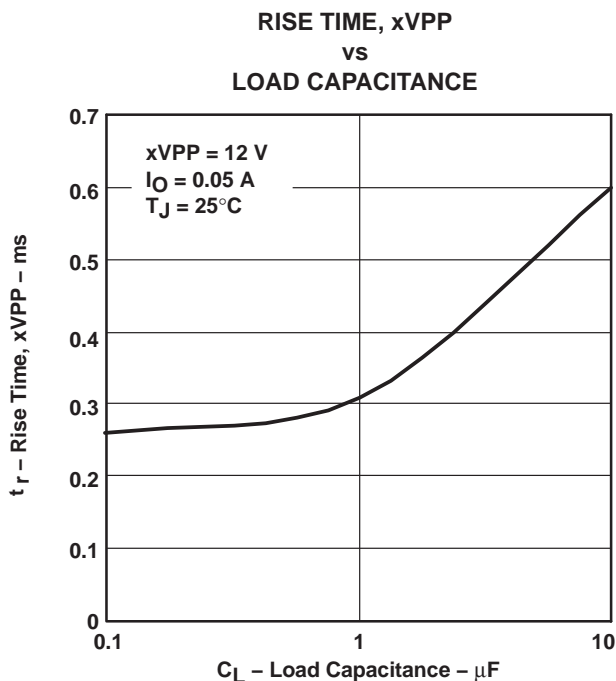
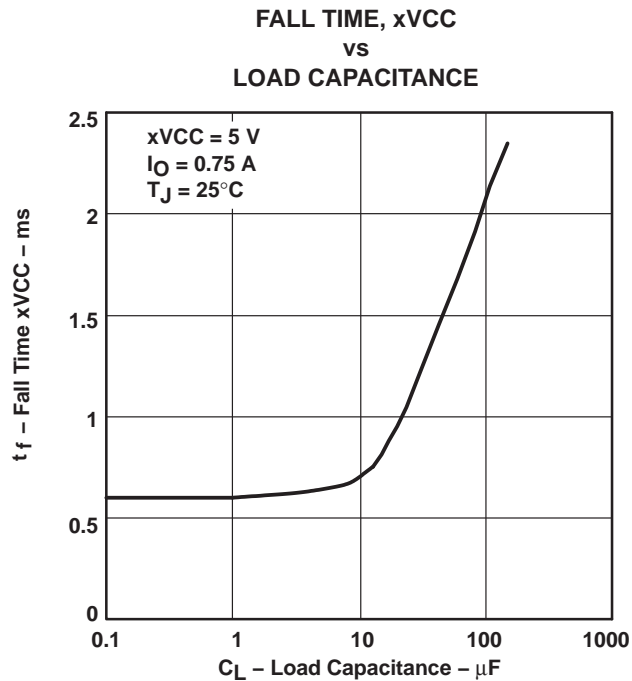
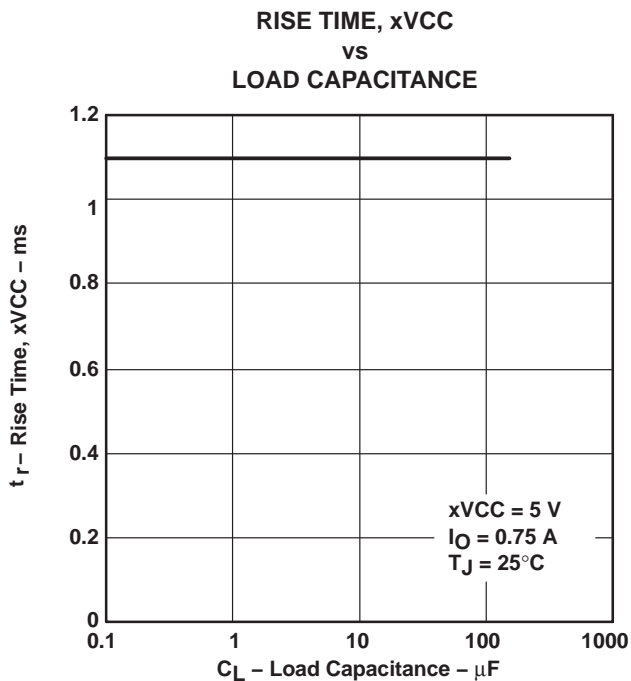

**TYPICAL CHARACTERISTICS**

**Table of Graphs**

			<b>FIGURE</b>
$I_I$	Input current, xVCC = 3.3 V	vs Junction temperature	23
	Input current, xVCC = 5 V		24
	Input current, xVPP = 12 V		25
$r_{DS(on)}$	Static drain-source on-state resistance, 3.3 V to xVCC switch	vs Junction temperature	26
	Static drain-source on-state resistance, 5 V to xVCC switch		27
	Static drain-source on-state resistance, 12 V to xVPP switch		28
$V_O$	xVCC switch voltage drop, 3.3-V input	vs Load current	29
	xVCC switch voltage drop, 5-V input		30
	xVPP switch voltage drop, 12-V input		31
$I_{OS}$	Short-circuit current limit, 3.3 V to xVCC	vs Junction temperature	32
	Short-circuit current limit, 5 V to xVCC		33
	Short-circuit current limit, 12 V to xVCC		34

**INPUT CURRENT, xVCC = 3.3 V  
 vs  
 JUNCTION TEMPERATURE**

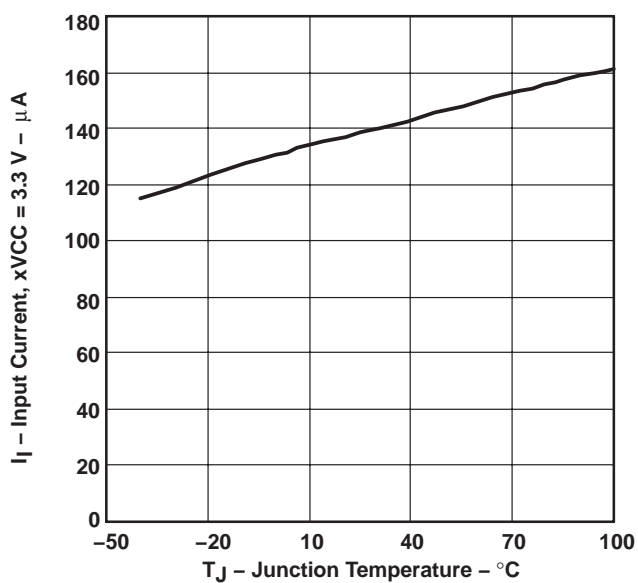

**Figure 23**

**INPUT CURRENT, xVCC = 5 V  
 vs  
 JUNCTION TEMPERATURE**

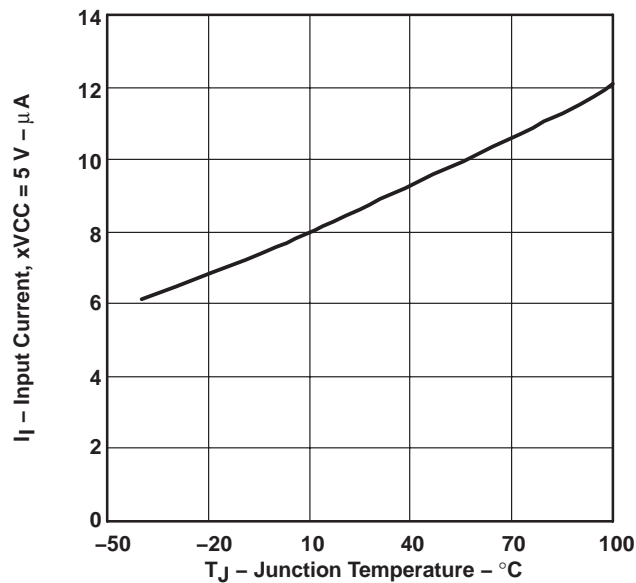

**Figure 24**

**TPS2223, TPS2224, TPS2226**  
**DUAL-SLOT CARDBUS POWER-INTERFACE SWITCHES**  
**FOR SERIAL PCMCIA CONTROLLERS**

SLVS317 – MAY 2001

**TYPICAL CHARACTERISTICS**

**INPUT CURRENT, xVPP = 12 V**  
**vs**  
**JUNCTION TEMPERATURE**

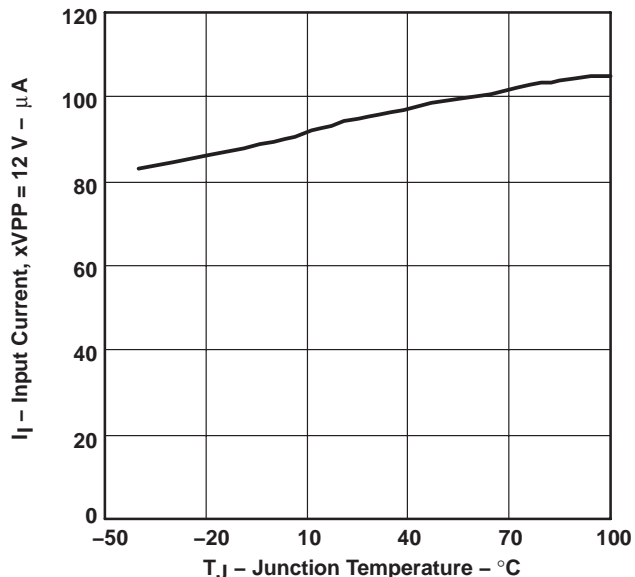

**Figure 25**

**STATIC DRAIN-SOURCE ON-STATE RESISTANCE,**  
**3.3 V TO xVCC SWITCH**  
**vs**  
**JUNCTION TEMPERATURE**

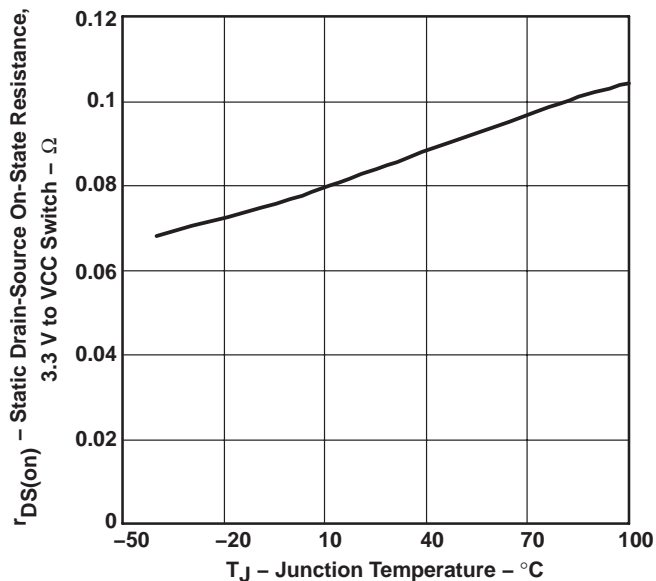

**Figure 26**

**STATIC DRAIN-SOURCE ON-STATE RESISTANCE,**  
**5 V TO xVCC SWITCH**  
**vs**  
**JUNCTION TEMPERATURE**

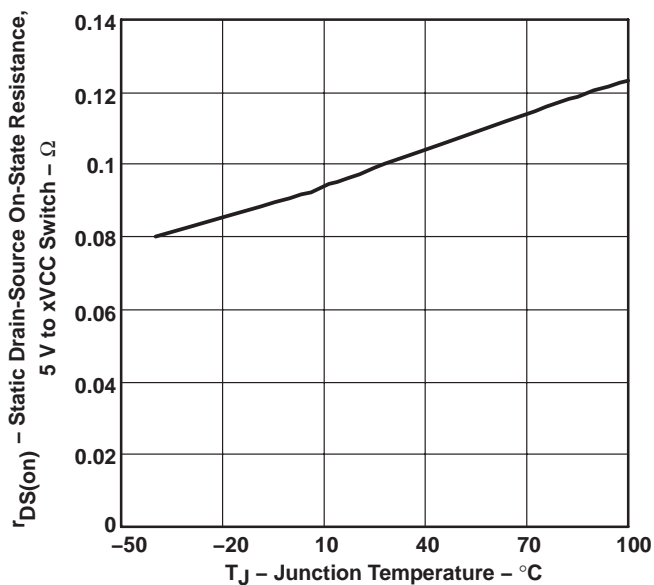

**Figure 27**

**STATIC DRAIN-SOURCE ON-STATE RESISTANCE,**  
**12 V TO xVPP SWITCH**  
**vs**  
**JUNCTION TEMPERATURE**

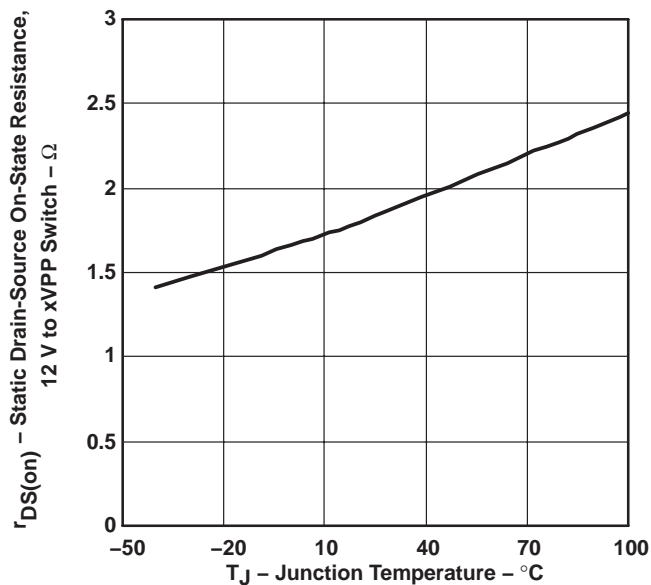

**Figure 28**





TYPICAL CHARACTERISTICS

xVCC SWITCH VOLTAGE DROP, 3.3-V INPUT  
 VS  
 LOAD CURRENT

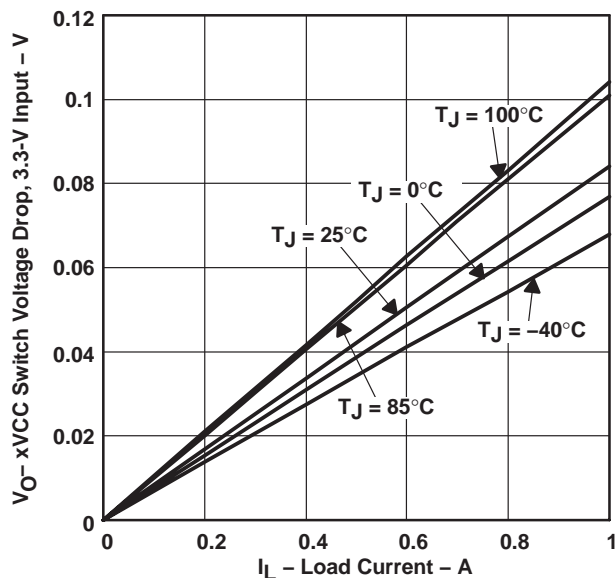

Figure 29

xVCC SWITCH VOLTAGE DROP, 5-V INPUT  
 VS  
 LOAD CURRENT

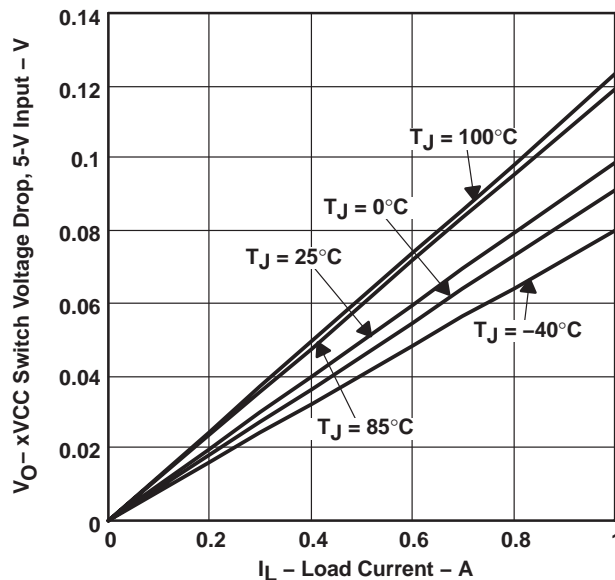

Figure 30

xVPP SWITCH VOLTAGE DROP, 12-V INPUT  
 VS  
 LOAD CURRENT

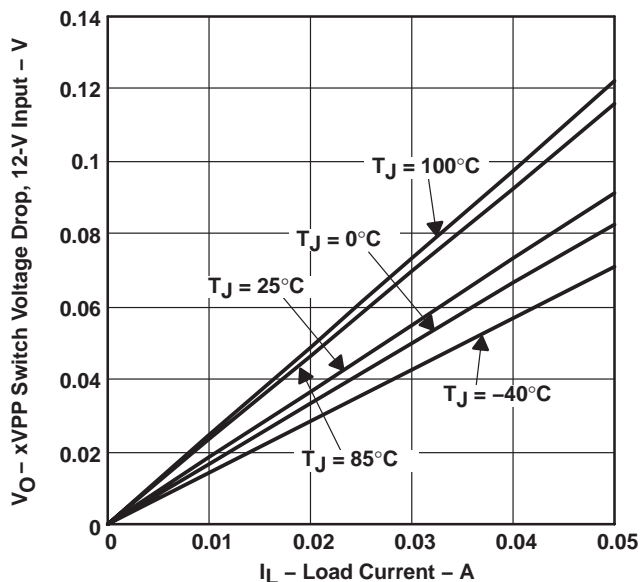

Figure 31

SHORT-CIRCUIT CURRENT LIMIT, 3.3 V TO xVCC  
 VS  
 JUNCTION TEMPERATURE

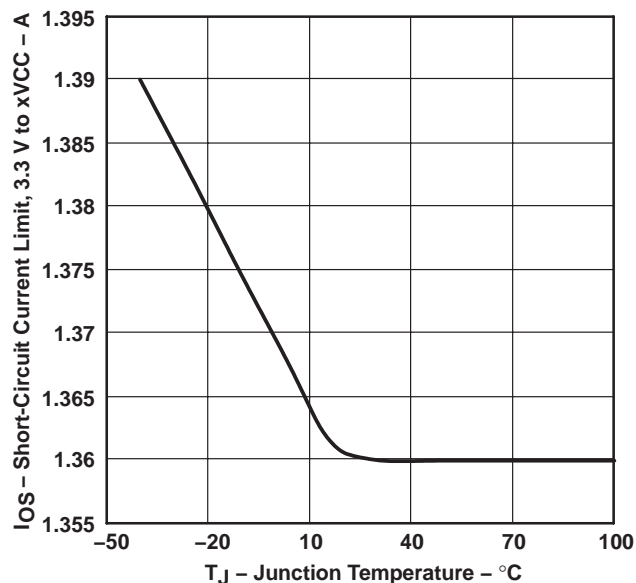

Figure 32

**TPS2223, TPS2224, TPS2226**  
**DUAL-SLOT CARDBUS POWER-INTERFACE SWITCHES**  
**FOR SERIAL PCMCIA CONTROLLERS**

SLVS317 – MAY 2001

**TYPICAL CHARACTERISTICS**

**SHORT-CIRCUIT CURRENT LIMIT, 5 V TO xVCC**  
**vs**  
**JUNCTION TEMPERATURE**

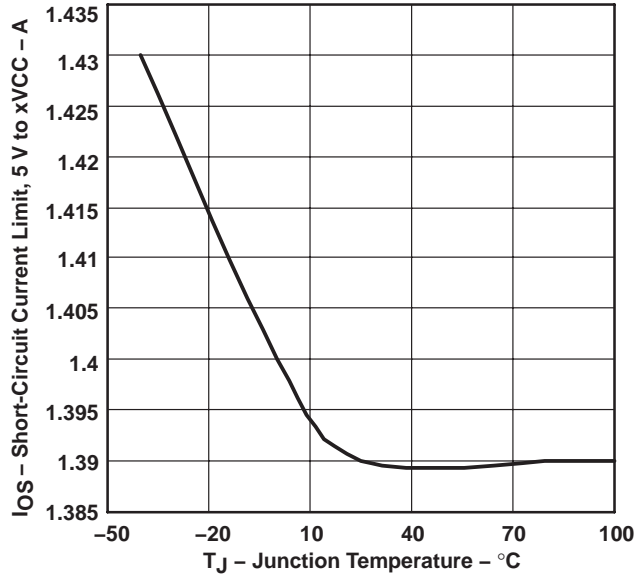

**Figure 33**

**SHORT-CIRCUIT CURRENT LIMIT, 12 V TO xVPP**  
**vs**  
**JUNCTION TEMPERATURE**

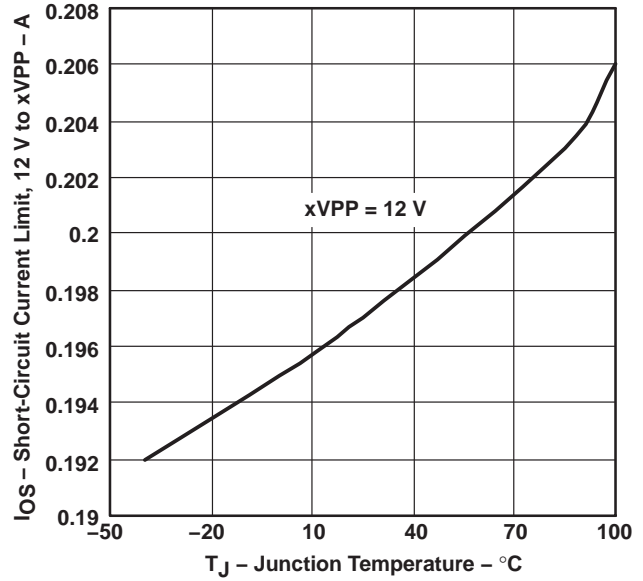

**Figure 34**

## APPLICATION INFORMATION

### overview

PC Cards were initially introduced as a means to add flash memory to portable computers. The idea of add-in cards quickly took hold, and modems, wireless LANs, global positioning satellite System (GPS), multimedia, and hard-disk versions were soon available. As the number of PC Card applications grew, the engineering community quickly recognized the need for a standard to ensure compatibility across platforms. To this end, the PCMCIA (Personal Computer Memory Card International Association) was established, comprising members from leading computer, software, PC Card, and semiconductor manufacturers. One key goal was to realize the *plug-and-play* concept, so that cards and hosts from different vendors would be transparently compatible.

### PC Card power specification

System compatibility also means power compatibility. The most current set of specifications (PC Card Standard) set forth by the PCMCIA committee states that power is to be transferred between the host and the card through eight of the 68 terminals of the PC Card connector. This power interface consists of two  $V_{CC}$ , two  $V_{pp}$ , and four ground terminals. Multiple  $V_{CC}$  and ground terminals minimize connector-terminal and line resistance. The two  $V_{pp}$  terminals were originally specified as separate signals, but are normally tied together in the host to form a single node to minimize voltage losses. Card primary power is supplied through the  $V_{CC}$  terminals; flash-memory programming and erase voltage is supplied through the  $V_{pp}$  terminals. Cardbus cards of today typically do not use 12 V, which is now more of an optional requirement in the host.

### designing for voltage regulation

The current PCMCIA specification for output voltage regulation,  $V_{O(reg)}$ , of the 5-V output is 5% (250 mV). In a typical PC power-system design, the power supply has an output-voltage regulation,  $V_{PS(reg)}$ , of 2% (100 mV). Also, a voltage drop from the power supply to the PC Card will result from resistive losses,  $V_{PCB}$ , in the PCB traces and the PCMCIA connector. A typical design would limit the total of these resistive losses to less than 1% (50 mV) of the output voltage. Therefore, the allowable voltage drop,  $V_{DS}$ , for the TPS2223, TPS2224 and TPS2226 would be the PCMCIA voltage regulation less the power supply regulation and less the PCB and connector resistive drops:

$$V_{DS} = V_{O(reg)} - V_{PS(reg)} - V_{PCB}$$

Typically, this would leave 100 mV for the allowable voltage drop across the 5-V switch. The specification for output voltage regulation of the 3.3-V output is 300 mV; therefore, using the same equation by deducting the voltage drop percentages (2%) for power-supply regulation and PCB resistive loss (1%), the allowable voltage drop for the 3.3-V switch is 200 mV. The voltage drop is the output current multiplied by the switch resistance of the TPS2223, TPS2224, and TPS2226. Therefore, the maximum output current,  $I_{Omax}$ , that can be delivered to the PC Card in regulation is the allowable voltage drop across the IC, divided by the output-switch resistance.

$$I_{Omax} = \frac{V_{DS}}{r_{DS(on)}}$$

The xVCC outputs have been designed to deliver the peak and average currents defined by the PC Card specification within regulation over the operating temperature range. The xVPP outputs of the TPS2226 have been designed to deliver 100 mA continuously.

# TPS2223, TPS2224, TPS2226 DUAL-SLOT CARDBUS POWER-INTERFACE SWITCHES FOR SERIAL PCMCIA CONTROLLERS

SLVS317 – MAY 2001

---

## APPLICATION INFORMATION

### overcurrent and overtemperature protection

PC Cards are inherently subject to damage that can result from mishandling. Host systems require protection against short-circuited cards that could lead to power-supply or PCB trace damage. Even extremely robust systems could undergo rapid battery discharge into a damaged PC Card, resulting in the rather sudden and unacceptable loss of system power. The reliability of fused systems is poor, in comparison, as blown fuses require troubleshooting and repair, usually by the manufacturer.

The TPS2223, TPS2224 and TPS2226 take a two-pronged approach to overcurrent protection, which is designed to activate if an output is shorted or when an overcurrent condition is present when switches are powered up. First, instead of fuses, sense FETs monitor each of the xVCC and xVPP power outputs. Unlike sense resistors or polyfuses, these FETs do not add to the series resistance of the switch; therefore voltage and power losses are reduced. Overcurrent sensing is applied to each output separately. Excessive current generates an error signal that limits the output current of only the affected output, preventing damage to the host. Each xVCC output overcurrent limits from 1 A to 2.2 A, typically around 1.6 A; the xVPP outputs limit from 100 mA to 250 mA, typically around 200 mA.

Second, when an overcurrent condition is detected, the TPS2223, TPS2224 and TPS2226 assert an active low  $\overline{OC}$  signal that can be monitored by the microprocessor or controller to initiate diagnostics and/or send the user a warning message. In the event that an overcurrent condition persists, causing the IC to exceed its maximum junction temperature, thermal-protection circuitry activates, shutting down all power outputs until the device cools to within a safe operating region, which is ensured by a thermal shutdown hysteresis. Thermal limiting prevents destruction of the IC from overheating beyond the package power-dissipation ratings.

During power up, the devices control the rise times of the xVCC and xVPP outputs and limit the inrush current into a large load capacitance, faulty card, or connector.

### 12-V supply not required

A few PC Card switches use the externally supplied 12 V to power gate drive and other chip functions, which requires that power be present at all times. The TPS2224 and TPS2226 offer considerable power savings by using an internal charge pump to generate the required higher gate drive voltages from the VA input (3.3 V). Therefore, the external 12-V supply can be disabled except when needed by the PC Card in the slot, thereby extending battery lifetime. A special feature in the 12-V circuitry actually helps to reduce the supply current demanded from the 3.3 V input. When 12 V is supplied and requested at the VPP output, a voltage selection circuit will draw the charge-pump drive current for the 12-V FETs from the 12-V input. This selection is automatic and effectively reduces demand fluctuations on the normal 3.3-V VCC rail. For proper operation of this feature, a minimum 3.3-V input capacitance of 4.7  $\mu$ F is recommended, and a minimum 12-V input ramp-up rate of 12 V/50 ms (240 V/s) is required. Additional power savings are realized by the TPS2226 during a software shutdown in which quiescent current drops to a maximum of 1  $\mu$ A.

### voltage-transitioning requirement

PC Cards, like portables, are migrating from 5 V to 3.3 V to minimize power consumption, optimize board space, and increase logic speeds. The TPS2223, TPS2224 and TPS2226 meet all combinations of power delivery as currently defined in the PCMCIA standard. The latest protocol accommodates mixed 3.3-V/5-V systems by first powering the card with 5 V, then polling it to determine its 3.3-V compatibility. The PCMCIA specification requires that the capacitors on 3.3-V-compatible cards be discharged to below 0.8 V before applying 3.3-V power. This action ensures that sensitive 3.3-V circuitry is not subjected to any residual 5-V charge and functions as a power reset. PC Card specification requires that  $V_{CC}$  be discharged within 100 ms. PC Card resistance cannot be relied on to provide a discharge path for voltages stored on PC Card capacitance because of possible high-impedance isolation by power-management schemes. The devices include discharge transistors on all xVCC and xVPP outputs to meet the specification requirement.



POST OFFICE BOX 655303 • DALLAS, TEXAS 75265

## APPLICATION INFORMATION

### shutdown mode

In the shutdown mode, which can be controlled by  $\overline{\text{SHDN}}$  or bit D8 of the input serial DATA word, each of the xVCC and xVPP outputs is forced to a high-impedance state. In this mode, the chip quiescent current is reduced to 1  $\mu\text{A}$  or less to conserve battery power.

### power-supply considerations

These switches have multiple pins for each 3.3-V and 5-V power input and for the switched xVCC outputs. Any individual pin can conduct the rated input or output current. Unless all pins are connected in parallel, the series resistance is higher than that specified, resulting in increased voltage drops and power loss. It is recommended that all input and output power pins be paralleled for optimum operation.

To increase the noise immunity of the TPS2223, TPS2224 and TPS2226, the power-supply inputs should be bypassed with at least a 4.7  $\mu\text{F}$  electrolytic or tantalum capacitor paralleled by a 0.047- $\mu\text{F}$  to 0.1- $\mu\text{F}$  ceramic capacitor. It is strongly recommended that the switched outputs be bypassed with a 0.1- $\mu\text{F}$  (or larger) ceramic capacitor; doing so improves the immunity of the IC to electrostatic discharge (ESD). Care should be taken to minimize the inductance of PCB traces between the devices and the load. High switching currents can produce large negative voltage transients, which forward biases substrate diodes, resulting in unpredictable performance. Similarly, no pin should be taken below  $-0.3\text{ V}$ .

### $\overline{\text{RESET}}$ input

To ensure that cards are in a known state after power brownouts or system initialization, the PC Cards should be reset at the same time as the host by applying low-impedance paths from xVCC and xVPP terminals to ground. A low-impedance output state allows discharging of residual voltage remaining on PC Card filter capacitance, permitting the system (host and PC Cards) to be powered up concurrently. The active low  $\overline{\text{RESET}}$  input will close internal switches S1, S4, S7, and S11 with all other switches left open. The TPS2223, TPS2224 and TPS2226 remain in the low-impedance output state until the signal is deasserted and further data is clocked in and latched. The input serial data cannot be latched during reset mode.  $\overline{\text{RESET}}$  is provided for direct compatibility with systems that use an active-low reset voltage supervisor. The  $\overline{\text{RESET}}$  pin has an internal 150-k $\Omega$  pullup resistor.

### calculating junction temperature

The switch resistance,  $r_{\text{DS(on)}}$ , is dependent on the junction temperature,  $T_J$ , of the die. The junction temperature is dependent on both  $r_{\text{DS(on)}}$  and the current through the switch. To calculate  $T_J$ , first find  $r_{\text{DS(on)}}$  from Figures 26 through 28, using an initial temperature estimate about 30°C above ambient. Then calculate the power dissipation for each switch, using the formula:

$$P_D = r_{\text{DS(on)}} \times I^2$$

Next, sum the power dissipation of all switches and calculate the junction temperature:

$$T_J = \left( \sum P_D \times R_{\theta\text{JA}} \right) + T_A$$

Where:

$R_{\theta\text{JA}}$  is the inverse of the derating factor given in the dissipation rating table.

Compare the calculated junction temperature with the initial temperature estimate. If the temperatures are not within a few degrees of each other, recalculate using the calculated temperature as the initial estimate.

# TPS2223, TPS2224, TPS2226 DUAL-SLOT CARDBUS POWER-INTERFACE SWITCHES FOR SERIAL PCMCIA CONTROLLERS

SLVS317 – MAY 2001

## APPLICATION INFORMATION

### logic inputs and outputs

The serial interface consists of DATA, CLOCK, and LATCH leads. The data is clocked in on the positive edge of the clock (see Figure 2). The 11-bit (D0–D10) serial data word is loaded during the positive edge of the latch signal. The positive edge of the latch signal should occur before the next positive edge of the clock occurs.

The serial interface of the device is compatible with serial-interface PCMCIA controllers.

An overcurrent output ( $\overline{OC}$ ) is provided to indicate an overcurrent or overtemperature condition in any of the xVCC and xVPP outputs as previously discussed.

### TPS2223, TPS2224 and TPS2226 control logic

#### xVPP

D8 ( $\overline{SHDN}$ )	AVPP CONTROL SIGNALS			OUTPUT V_AVPP	BVPP CONTROL SIGNALS				OUTPUT V_BVPP
	D0	D1	D9		D8 ( $\overline{SHDN}$ )	D4	D5	D10	
1	0	0	X	0 V	1	0	0	X	0 V
1	0	1	0	3.3 V	1	0	1	0	3.3 V
1	0	1	1	5 V	1	0	1	1	5 V
1	1	0	X	12 V <sup>†</sup>	1	1	0	X	12 V <sup>†</sup>
1	1	1	X	Hi-Z	1	1	1	X	Hi-Z
0	X	X	X	Hi-Z	0	X	X	X	Hi-Z

<sup>†</sup> The output V\_xVPP is Hi-Z for TPS2223.

#### xVCC

D8 ( $\overline{SHDN}$ )	AVCC CONTROL SIGNALS		OUTPUT V_AVCC	BVCC CONTROL SIGNALS			OUTPUT V_BVCC
	D3	D2		D8 ( $\overline{SHDN}$ )	D6	D7	
1	0	0	0 V	1	0	0	0 V
1	0	1	3.3 V	1	0	1	3.3 V
1	1	0	5 V	1	1	0	5 V
1	1	1	0 V	1	1	1	0 V
0	X	X	Hi-Z	0	X	X	Hi-Z

**APPLICATION INFORMATION**

**ESD protections (see Figure 35)**

All inputs and outputs of these devices incorporate ESD-protection circuitry designed to withstand a 2-kV human-body-model discharge as defined in MIL-STD-883C, Method 3015. The xVCC and xVPP outputs can be exposed to potentially higher discharges from the external environment through the PC Card connector. Bypassing the outputs with 0.1- $\mu$ F capacitors protects the devices from discharges up to 10 kV.

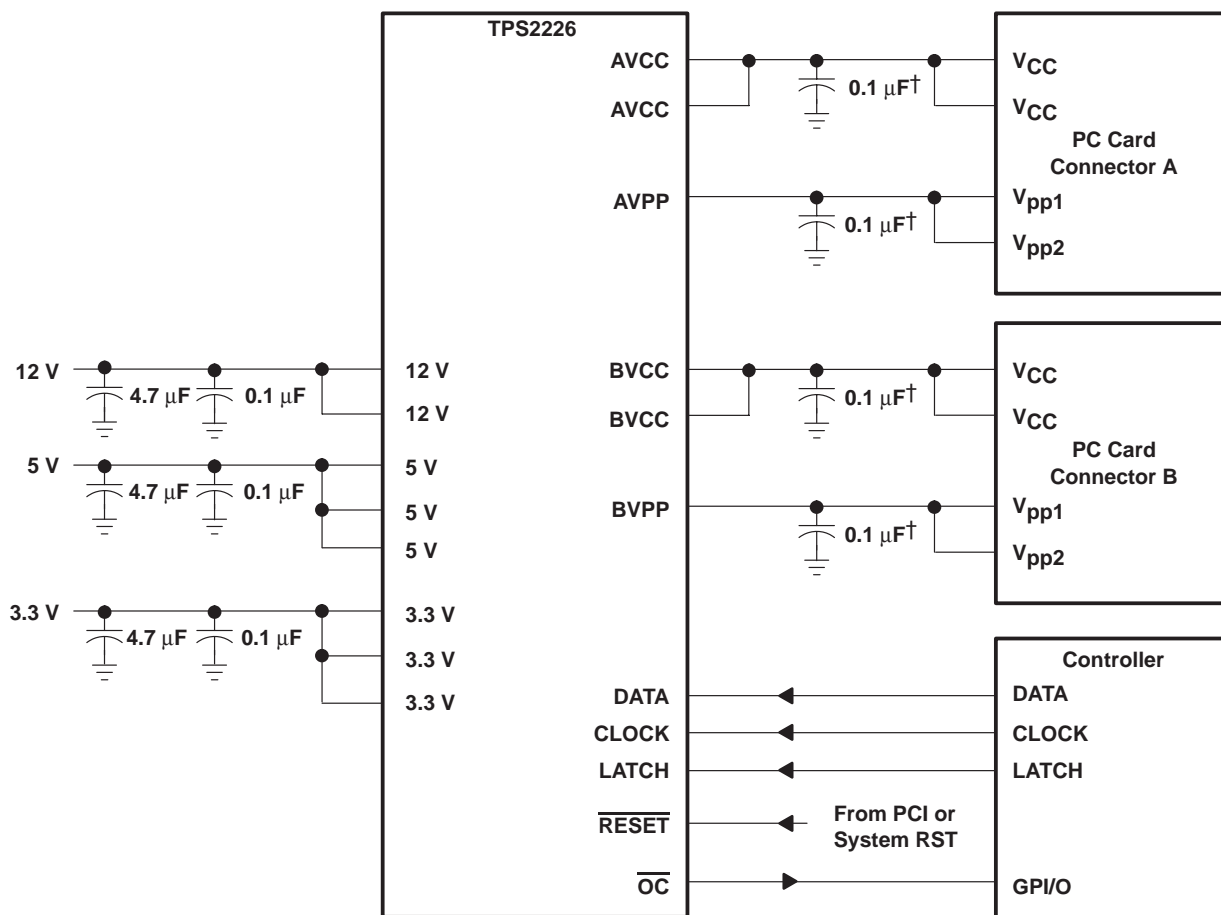

† Maximum recommended output capacitance for xVCC is 220  $\mu$ F including card capacitance, and for xVPP is 10  $\mu$ F, without  $\overline{OC}$  glitch when switches are powered on.

**Figure 35. Detailed Interconnections and Capacitor Recommendations**

# TPS2223, TPS2224, TPS2226 DUAL-SLOT CARDBUS POWER-INTERFACE SWITCHES FOR SERIAL PCMCIA CONTROLLERS

SLVS317 – MAY 2001

## APPLICATION INFORMATION

### 12-V flash memory supply

The TPS6734 is a fixed 12-V output boost converter capable of delivering 120 mA from inputs as low as 2.7 V. The device is pin-for-pin compatible with the MAX734 regulator and offers the following advantages: lower supply current, wider operating input-voltage range, and higher output currents. As shown in Figure 36, the only external components required are: an inductor, a Schottky rectifier, an output filter capacitor, an input filter capacitor, and a small capacitor for loop compensation. The entire converter occupies less than 0.7 in<sup>2</sup> of PCB space when implemented with surface-mount components. An enable input is provided to shut the converter down and reduce the supply current to 3  $\mu$ A when 12 V is not needed.

The TPS6734 is a 170-kHz current-mode PWM (pulse-width modulation) controller with an n-channel MOSFET power switch. Gate drive for the switch is derived from the 12-V output after start-up to minimize the die area needed to realize the 0.7- $\Omega$  MOSFET and improve efficiency at input voltages below 5 V. Soft start is accomplished with the addition of one small capacitor. A 1.22-V reference, pin 2 of TPS6734, is brought out for external use. For additional information, see the TPS6734 data sheet (SLVS127).

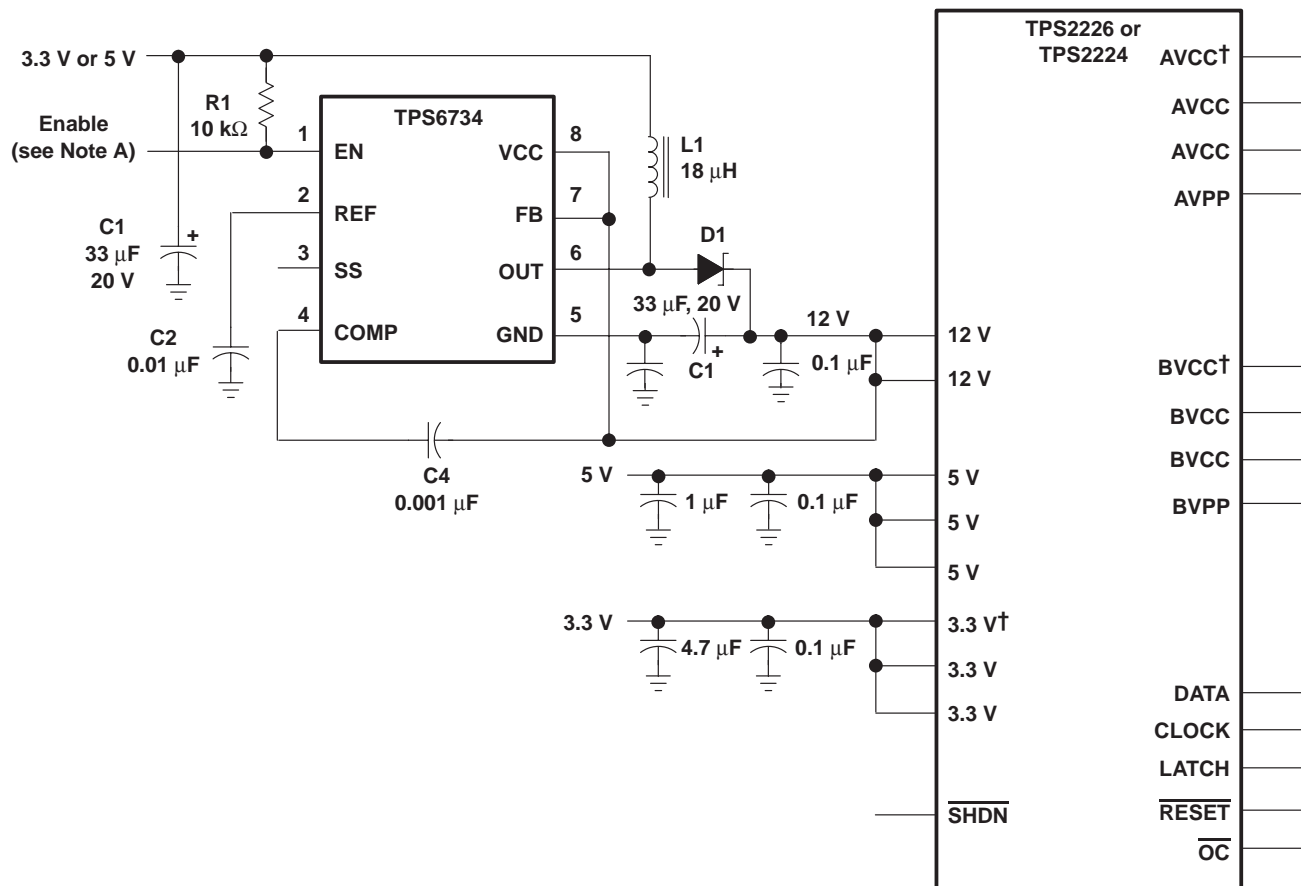

† Not on TPS2224

NOTE A: The enable terminal can be tied to a general-purpose I/O terminal on the PCMCIA controller or tied high.

Figure 36. TPS2224 and TPS2226 with TPS6734 12-V, 120-mA Supply



**PACKAGING INFORMATION**

Orderable part number	Status (1)	Material type (2)	Package   Pins	Package qty   Carrier	RoHS (3)	Lead finish/ Ball material (4)	MSL rating/ Peak reflow (5)	Op temp (°C)	Part marking (6)
<a href="#">TPS2223DB</a>	Active	Production	SSOP (DB)   24	60   TUBE	Yes	NIPDAU	Level-1-260C-UNLIM	-40 to 85	TPS2223
TPS2223DB.A	Active	Production	SSOP (DB)   24	60   TUBE	Yes	NIPDAU	Level-1-260C-UNLIM	-40 to 85	TPS2223
<a href="#">TPS2224DB</a>	Active	Production	SSOP (DB)   24	60   TUBE	Yes	NIPDAU	Level-1-260C-UNLIM	-40 to 85	TPS2224
TPS2224DB.A	Active	Production	SSOP (DB)   24	60   TUBE	Yes	NIPDAU	Level-1-260C-UNLIM	-40 to 85	TPS2224
<a href="#">TPS2224PWP</a>	Active	Production	HTSSOP (PWP)   24	60   TUBE	Yes	NIPDAU	Level-2-260C-1 YEAR	-40 to 85	TPS2224
TPS2224PWP.A	Active	Production	HTSSOP (PWP)   24	60   TUBE	Yes	NIPDAU	Level-2-260C-1 YEAR	-40 to 85	TPS2224
<a href="#">TPS2226DB</a>	Active	Production	SSOP (DB)   30	50   TUBE	Yes	NIPDAU	Level-1-260C-UNLIM	-40 to 85	TPS2226
TPS2226DB.A	Active	Production	SSOP (DB)   30	50   TUBE	Yes	NIPDAU	Level-1-260C-UNLIM	-40 to 85	TPS2226
<a href="#">TPS2226DBR</a>	Active	Production	SSOP (DB)   30	2000   LARGE T&R	Yes	NIPDAU	Level-1-260C-UNLIM	-40 to 85	TPS2226
TPS2226DBR.A	Active	Production	SSOP (DB)   30	2000   LARGE T&R	Yes	NIPDAU	Level-1-260C-UNLIM	-40 to 85	TPS2226

(1) **Status:** For more details on status, see our [product life cycle](#).

(2) **Material type:** When designated, preproduction parts are prototypes/experimental devices, and are not yet approved or released for full production. Testing and final process, including without limitation quality assurance, reliability performance testing, and/or process qualification, may not yet be complete, and this item is subject to further changes or possible discontinuation. If available for ordering, purchases will be subject to an additional waiver at checkout, and are intended for early internal evaluation purposes only. These items are sold without warranties of any kind.

(3) **RoHS values:** Yes, No, RoHS Exempt. See the [TI RoHS Statement](#) for additional information and value definition.

(4) **Lead finish/Ball material:** Parts may have multiple material finish options. Finish options are separated by a vertical ruled line. Lead finish/Ball material values may wrap to two lines if the finish value exceeds the maximum column width.

(5) **MSL rating/Peak reflow:** The moisture sensitivity level ratings and peak solder (reflow) temperatures. In the event that a part has multiple moisture sensitivity ratings, only the lowest level per JEDEC standards is shown. Refer to the shipping label for the actual reflow temperature that will be used to mount the part to the printed circuit board.

(6) **Part marking:** There may be an additional marking, which relates to the logo, the lot trace code information, or the environmental category of the part.

Multiple part markings will be inside parentheses. Only one part marking contained in parentheses and separated by a "~" will appear on a part. If a line is indented then it is a continuation of the previous line and the two combined represent the entire part marking for that device.

**Important Information and Disclaimer:** The information provided on this page represents TI's knowledge and belief as of the date that it is provided. TI bases its knowledge and belief on information provided by third parties, and makes no representation or warranty as to the accuracy of such information. Efforts are underway to better integrate information from third parties. TI has taken and continues to take reasonable steps to provide representative

and accurate information but may not have conducted destructive testing or chemical analysis on incoming materials and chemicals. TI and TI suppliers consider certain information to be proprietary, and thus CAS numbers and other limited information may not be available for release.

In no event shall TI's liability arising out of such information exceed the total purchase price of the TI part(s) at issue in this document sold by TI to Customer on an annual basis.

**TAPE AND REEL INFORMATION**

**QUADRANT ASSIGNMENTS FOR PIN 1 ORIENTATION IN TAPE**

\*All dimensions are nominal

Device	Package Type	Package Drawing	Pins	SPQ	Reel Diameter (mm)	Reel Width W1 (mm)	A0 (mm)	B0 (mm)	K0 (mm)	P1 (mm)	W (mm)	Pin1 Quadrant
TPS2226DBR	SSOP	DB	30	2000	330.0	16.4	8.1	10.4	2.5	12.0	16.0	Q1

**TAPE AND REEL BOX DIMENSIONS**

\*All dimensions are nominal

Device	Package Type	Package Drawing	Pins	SPQ	Length (mm)	Width (mm)	Height (mm)
TPS2226DBR	SSOP	DB	30	2000	353.0	353.0	32.0

**TUBE**

\*All dimensions are nominal

Device	Package Name	Package Type	Pins	SPQ	L (mm)	W (mm)	T (μm)	B (mm)
TPS2223DB	DB	SSOP	24	60	530	10.5	4000	4.1
TPS2223DB.A	DB	SSOP	24	60	530	10.5	4000	4.1
TPS2224DB	DB	SSOP	24	60	530	10.5	4000	4.1
TPS2224DB.A	DB	SSOP	24	60	530	10.5	4000	4.1
TPS2224PWP	PWP	HTSSOP	24	60	530	10.2	3600	3.5
TPS2224PWP.A	PWP	HTSSOP	24	60	530	10.2	3600	3.5
TPS2226DB	DB	SSOP	30	50	530	10.5	4000	4.1
TPS2226DB.A	DB	SSOP	30	50	530	10.5	4000	4.1

## GENERIC PACKAGE VIEW

**PWP 24**

**PowerPAD™ TSSOP - 1.2 mm max height**

4.4 x 7.6, 0.65 mm pitch

PLASTIC SMALL OUTLINE

This image is a representation of the package family, actual package may vary.  
Refer to the product data sheet for package details.



4224742/B

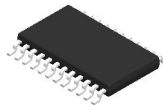

# PACKAGE OUTLINE

## PWP0024B

## PowerPAD™ TSSOP - 1.2 mm max height

PLASTIC SMALL OUTLINE

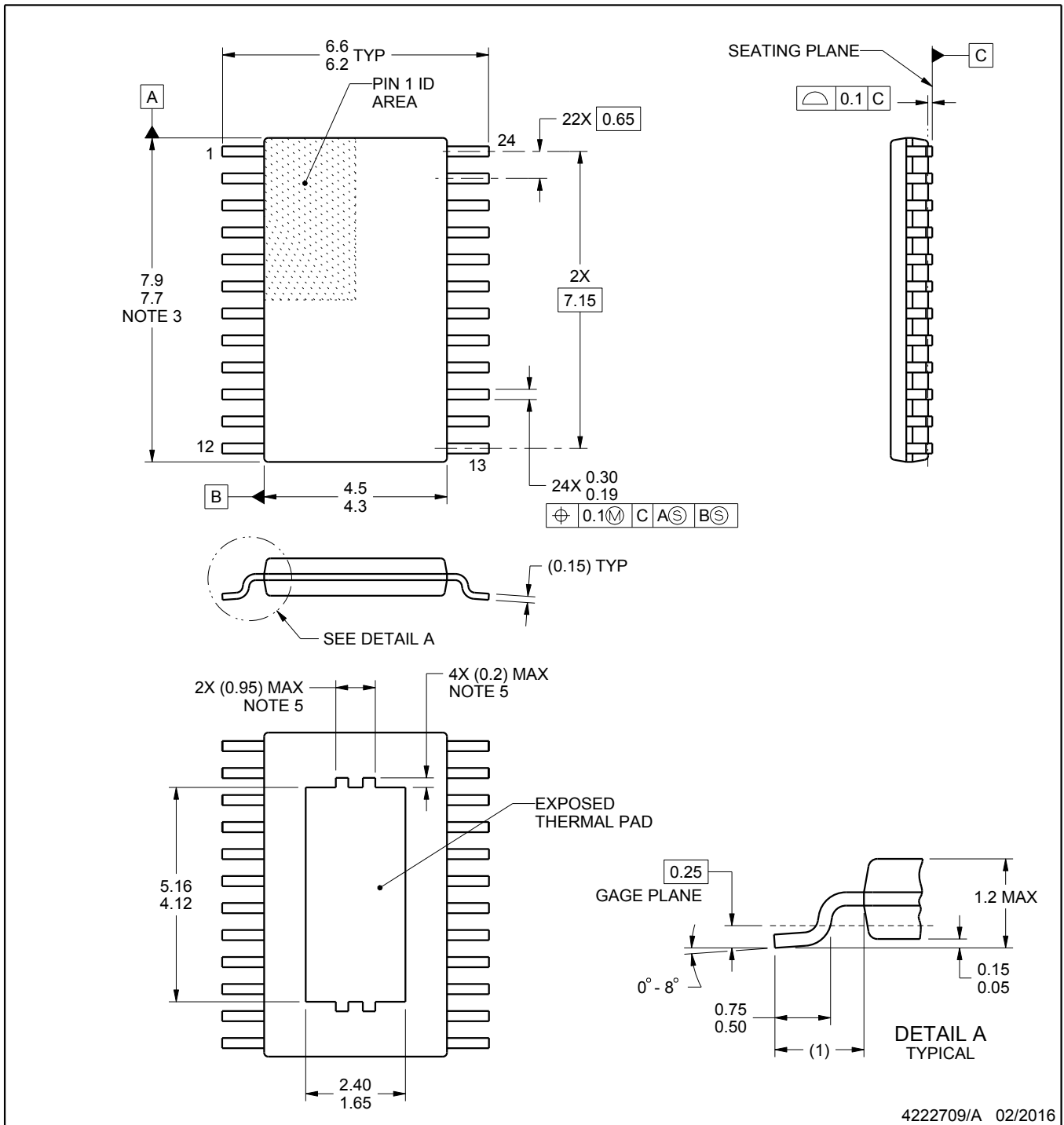

### NOTES:

PowerPAD is a trademark of Texas Instruments.

1. All linear dimensions are in millimeters. Any dimensions in parenthesis are for reference only. Dimensioning and tolerancing per ASME Y14.5M.
2. This drawing is subject to change without notice.
3. This dimension does not include mold flash, protrusions, or gate burrs. Mold flash, protrusions, or gate burrs shall not exceed 0.15 mm per side.
4. Reference JEDEC registration MO-153.
5. Features may not be present and may vary.

# EXAMPLE BOARD LAYOUT

PWP0024B

PowerPAD™ TSSOP - 1.2 mm max height

PLASTIC SMALL OUTLINE

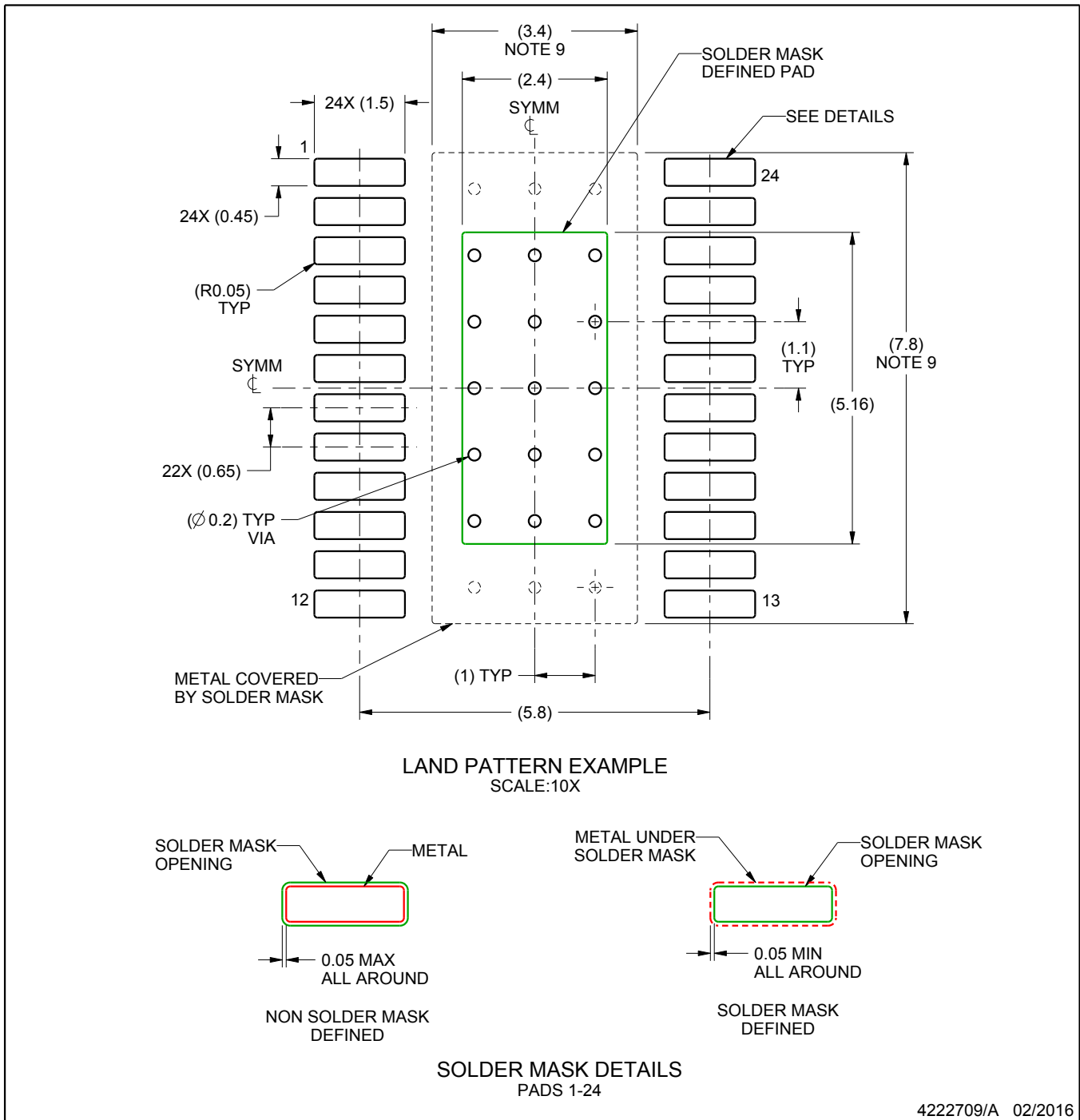

NOTES: (continued)

6. Publication IPC-7351 may have alternate designs.
7. Solder mask tolerances between and around signal pads can vary based on board fabrication site.
8. This package is designed to be soldered to a thermal pad on the board. For more information, see Texas Instruments literature numbers SLMA002 ([www.ti.com/lit/slma002](http://www.ti.com/lit/slma002)) and SLMA004 ([www.ti.com/lit/slma004](http://www.ti.com/lit/slma004)).
9. Size of metal pad may vary due to creepage requirement.



# EXAMPLE STENCIL DESIGN

PWP0024B

PowerPAD™ TSSOP - 1.2 mm max height

PLASTIC SMALL OUTLINE

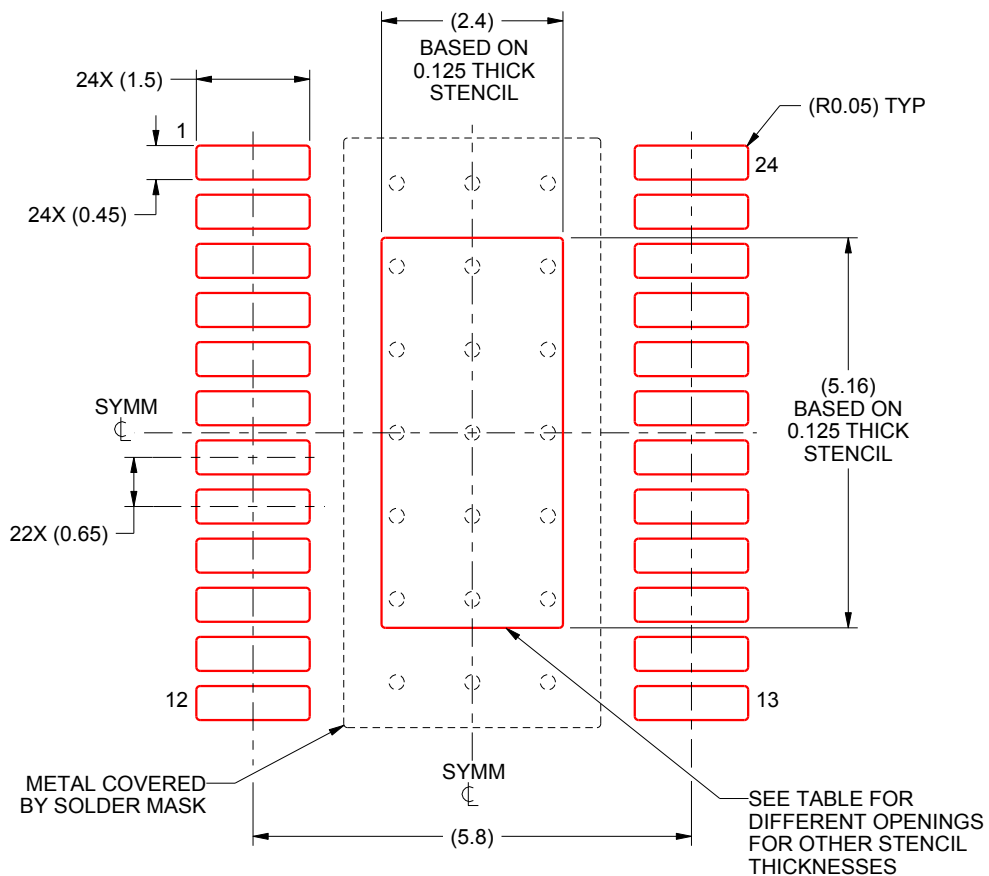

**SOLDER PASTE EXAMPLE**  
 EXPOSED PAD  
 100% PRINTED SOLDER COVERAGE BY AREA  
 SCALE:10X

STENCIL THICKNESS	SOLDER STENCIL OPENING
0.1	2.68 X 5.77
0.125	2.4 X 5.16 (SHOWN)
0.15	2.19 X 4.71
0.175	2.03 X 4.36

4222709/A 02/2016

NOTES: (continued)

- 10. Laser cutting apertures with trapezoidal walls and rounded corners may offer better paste release. IPC-7525 may have alternate design recommendations.
- 11. Board assembly site may have different recommendations for stencil design.

# DB0030A



# PACKAGE OUTLINE

## TSSOP - 2 mm max height

SMALL OUTLINE PACKAGE

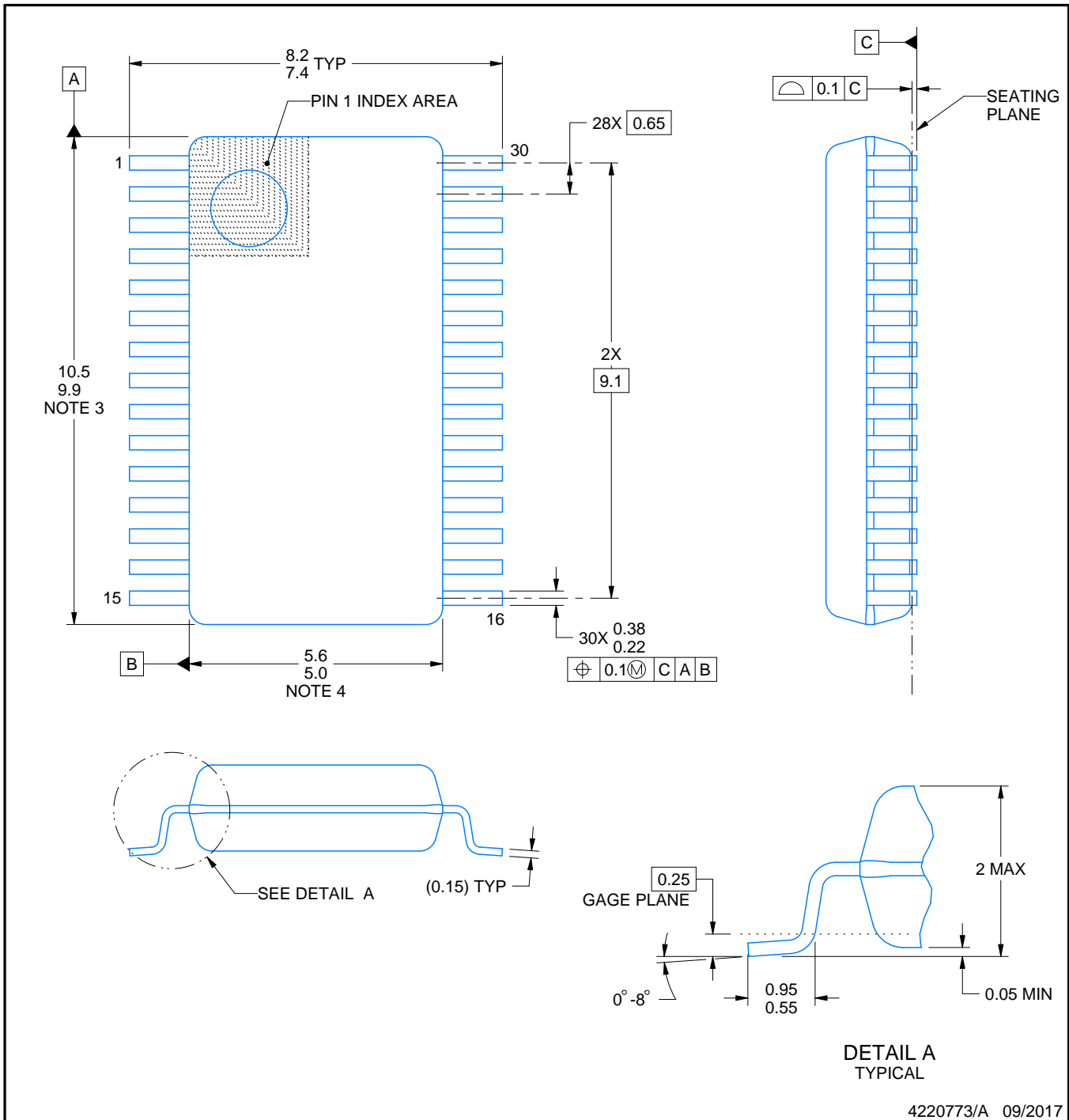

4220773/A 09/2017

### NOTES:

1. All linear dimensions are in millimeters. Any dimensions in parenthesis are for reference only. Dimensioning and tolerancing per ASME Y14.5M.
2. This drawing is subject to change without notice.
3. This dimension does not include mold flash, protrusions, or gate burrs. Mold flash, protrusions, or gate burrs shall not exceed 0.15 mm per side.
4. This dimension does not include interlead flash. Interlead flash shall not exceed 0.25 mm per side.
5. Reference JEDEC registration MO-150.

# EXAMPLE BOARD LAYOUT

DB0030A

TSSOP - 2 mm max height

SMALL OUTLINE PACKAGE

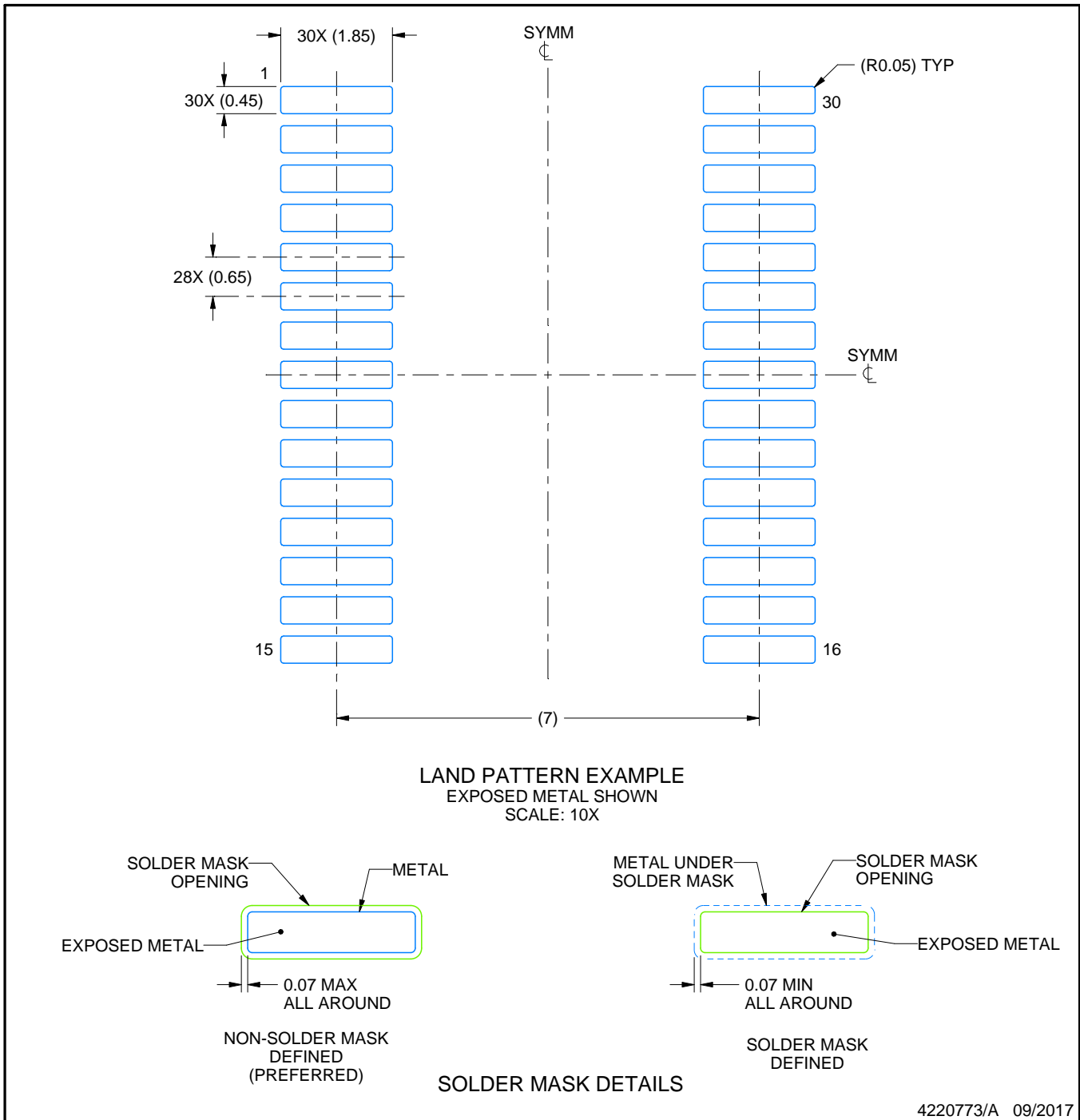

NOTES: (continued)

6. Publication IPC-7351 may have alternate designs.
7. Solder mask tolerances between and around signal pads can vary based on board fabrication site.

# EXAMPLE STENCIL DESIGN

DB0030A

TSSOP - 2 mm max height

SMALL OUTLINE PACKAGE

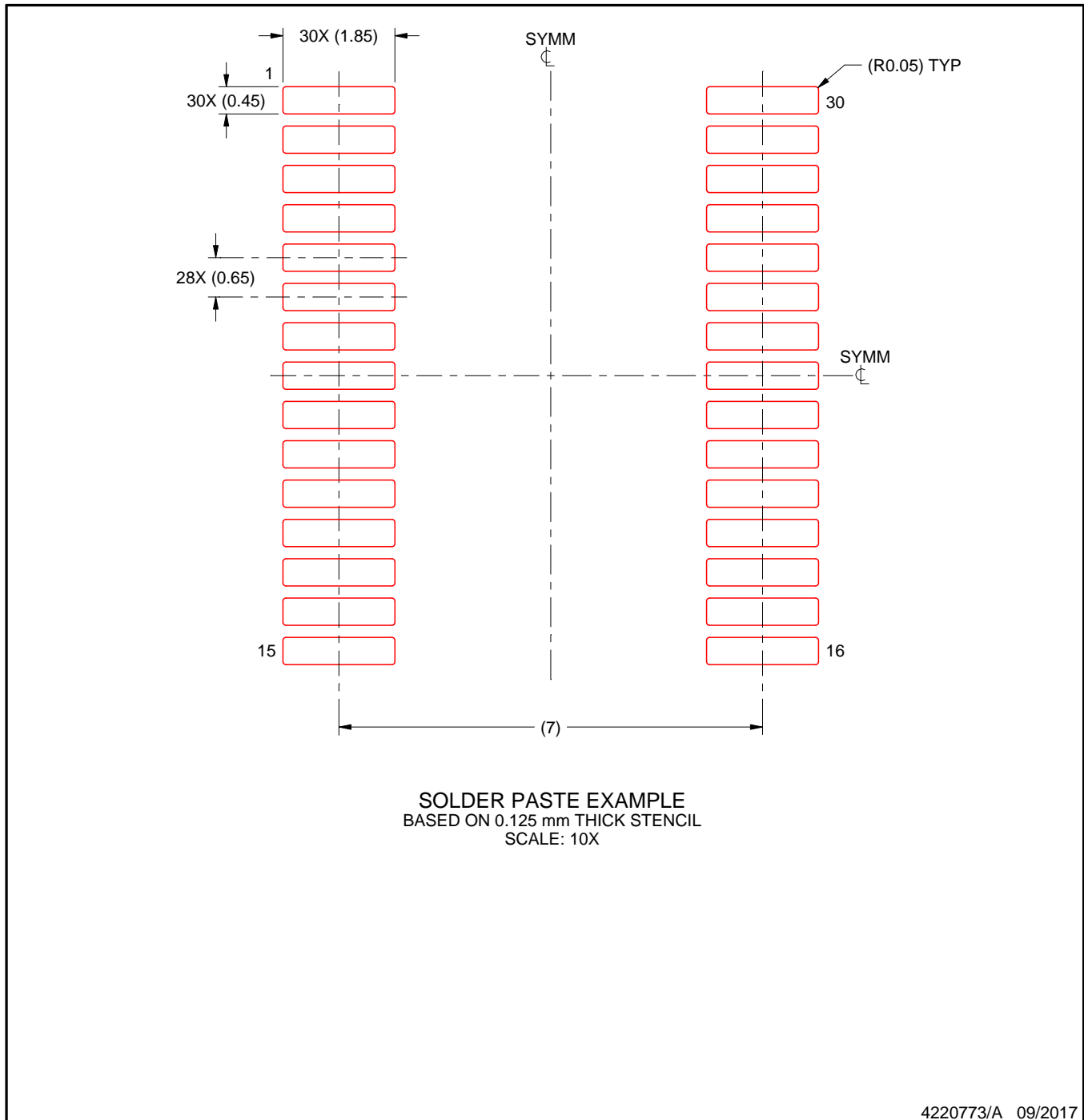

NOTES: (continued)

8. Laser cutting apertures with trapezoidal walls and rounded corners may offer better paste release. IPC-7525 may have alternate design recommendations.
9. Board assembly site may have different recommendations for stencil design.

DB (R-PDSO-G\*\*)

PLASTIC SMALL-OUTLINE

28 PINS SHOWN



- NOTES: A. All linear dimensions are in millimeters.  
 B. This drawing is subject to change without notice.  
 C. Body dimensions do not include mold flash or protrusion not to exceed 0,15.  
 D. Falls within JEDEC MO-150

## IMPORTANT NOTICE AND DISCLAIMER

TI PROVIDES TECHNICAL AND RELIABILITY DATA (INCLUDING DATASHEETS), DESIGN RESOURCES (INCLUDING REFERENCE DESIGNS), APPLICATION OR OTHER DESIGN ADVICE, WEB TOOLS, SAFETY INFORMATION, AND OTHER RESOURCES "AS IS" AND WITH ALL FAULTS, AND DISCLAIMS ALL WARRANTIES, EXPRESS AND IMPLIED, INCLUDING WITHOUT LIMITATION ANY IMPLIED WARRANTIES OF MERCHANTABILITY, FITNESS FOR A PARTICULAR PURPOSE OR NON-INFRINGEMENT OF THIRD PARTY INTELLECTUAL PROPERTY RIGHTS.

These resources are intended for skilled developers designing with TI products. You are solely responsible for (1) selecting the appropriate TI products for your application, (2) designing, validating and testing your application, and (3) ensuring your application meets applicable standards, and any other safety, security, regulatory or other requirements.

These resources are subject to change without notice. TI grants you permission to use these resources only for development of an application that uses the TI products described in the resource. Other reproduction and display of these resources is prohibited. No license is granted to any other TI intellectual property right or to any third party intellectual property right. TI disclaims responsibility for, and you fully indemnify TI and its representatives against any claims, damages, costs, losses, and liabilities arising out of your use of these resources.

TI's products are provided subject to [TI's Terms of Sale](#), [TI's General Quality Guidelines](#), or other applicable terms available either on [ti.com](#) or provided in conjunction with such TI products. TI's provision of these resources does not expand or otherwise alter TI's applicable warranties or warranty disclaimers for TI products. Unless TI explicitly designates a product as custom or customer-specified, TI products are standard, catalog, general purpose devices.

TI objects to and rejects any additional or different terms you may propose.

Copyright © 2025, Texas Instruments Incorporated

Last updated 10/2025