

UCC2720x、8V UVLO (低電圧ロックアウト) 機能搭載、120V、3A/3A、ハーフブリッジドライバ

1 特長

- ハイサイドおよびローサイド構成の 2 つの N チャンネル MOSFET を駆動
- HS の負電圧 (-5V)
- 最大ブート電圧: 120V
- 最大 VDD 電圧: 20V
- オンチップ 0.65V V_F 、0.65Ω R_D ブートストラップ ダイオード
- 伝搬遅延時間: 22ns
- 3A シンク、3A ソース出力電流
- 立ち上がり時間 8ns、立ち下がり時間 7ns (1000pF 負荷時)
- 遅延マッチング: 1ns
- ハイサイドおよびローサイドドライバに対する低電圧誤動作防止機能
- -40°C~150°Cで動作が規定

2 アプリケーション

- ソーラー電力オプティマイザとマイクロ インバータ
- テレコムおよび商業用電源
- オンライン UPS とオフライン UPS
- エネルギー ストレージ システム
- バッテリー テスト機器

3 概要

UCC2720x ファミリの高周波 N チャンネル MOSFET ドライバは、120V のブートストラップ ダイオードと、それぞれ独立した入力を持つハイサイドおよびローサイドドライバを搭載し、制御の柔軟性を最大限に高めています。これにより、ハーフブリッジ、フルブリッジ、2 スイッチ フォワード、およびアクティブ クランプ フォワードのコンバータで、N チャンネル MOSFET 制御が可能です。ローサイドとハイサイドのゲートドライバが独立して制御され、それぞれのオン/オフ間に 1ns でマッチングが行われます。

ブートストラップ ダイオードを内蔵しているため、外部にディスクリット ダイオードが不要です。ハイサイドドライバとローサイドドライバの両方に低電圧誤動作防止機能が搭載され、駆動電圧が規定のスレッシュホールド未満の場合は出力が強制的に Low になります。

UCC2720x には、2 つのバージョンが用意されています。UCC27200 はノイズ耐性の高い CMOS 入力スレッシュホールドを備え、UCC27201 は TTL 互換のスレッシュホールドを備えています。

製品情報 (1)

部品番号	パッケージ	本体サイズ (公称)
UCC2720x	D (SOIC, 8)	3.9mm × 4.9 mm
	DDA (PowerPAD™ SOIC, 8)	3.9mm × 4.9 mm
	DRM (VSON, 8)	4.0mm × 4.0mm

(1) 供給されているすべてのパッケージについては、[セクション 12](#) を参照してください。

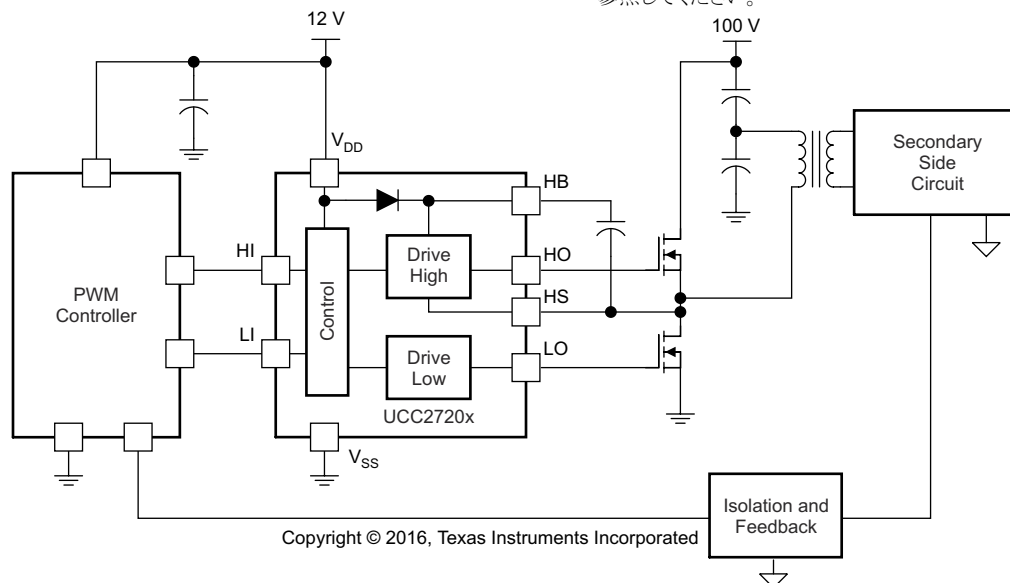

アプリケーション概略図



Table of Contents

1 特長	1	7 Application and Implementation	13
2 アプリケーション	1	7.1 Application Information.....	13
3 概要	1	7.2 Typical Application.....	13
4 Pin Configuration and Functions	3	8 Power Supply Recommendations	18
5 Specifications	4	9 Layout	19
5.1 Absolute Maximum Ratings.....	4	9.1 Layout Guidelines.....	19
5.2 ESD Ratings.....	4	9.2 Layout Example.....	19
5.3 Recommended Operating Conditions.....	4	10 Device and Documentation Support	20
5.4 Thermal Information.....	4	10.1 サード・パーティ製品に関する免責事項.....	20
5.5 Electrical Characteristics.....	5	10.2 Documentation Support.....	20
5.6 Switching Characteristics.....	6	10.3 ドキュメントの更新通知を受け取る方法.....	20
5.7 Timing Diagrams.....	7	10.4 サポート・リソース.....	20
5.8 Typical Characteristics.....	8	10.5 Trademarks.....	20
6 Detailed Description	11	10.6 静電気放電に関する注意事項.....	20
6.1 Overview.....	11	10.7 用語集.....	20
6.2 Functional Block Diagram.....	11	11 Revision History	21
6.3 Feature Description.....	11	12 Mechanical, Packaging, and Orderable Information	22
6.4 Device Functional Modes.....	12		

4 Pin Configuration and Functions



図 4-1. D Package 8-Pin SOIC Top View



図 4-2. DDA Package 8-Pin SO PowerPAD Top View

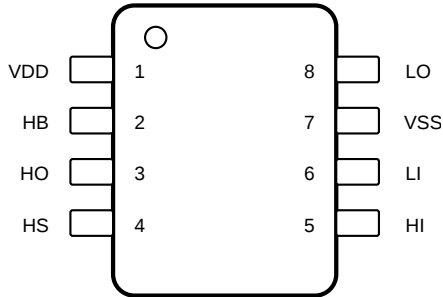

図 4-3. DRM Package 8-Pin VSON Top View

表 4-1. Pin Functions

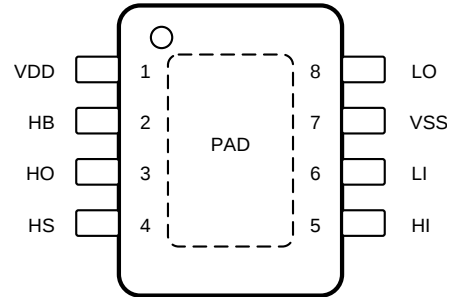
PIN		I/O	DESCRIPTION
NAME	NO.		
HB	2	I	High-side bootstrap supply. The bootstrap diode is on-chip but the external bootstrap capacitor is required. Connect positive side of the bootstrap capacitor to this pin. Typical range of HB bypass capacitor is 0.022μF to 0.1μF, the value is dependant on the gate charge of the high-side MOSFET however.
HI	5	I	High-side input.
HO	3	O	High-side output. Connect to the gate of the high-side power MOSFET.
HS	4	I	High-side source connection. Connect to source of high-side power MOSFET. Connect negative side of bootstrap capacitor to this pin.
LI	6	I	Low-side input.
LO	8	O	Low-side output. Connect to the gate of the low-side power MOSFET.
VDD	1	I	Positive supply to the lower gate driver. Decouple this pin to VSS (GND). Typical decoupling capacitor range is 0.22μF to 1μF.
VSS	7	O	Negative supply terminal for the device which is generally grounded.
PowerPAD	PAD	—	Used on the DDA and DRM packages only. Electrically referenced to VSS (GND) ⁽¹⁾ . Connect to a large thermal mass trace or GND plane to dramatically improve thermal performance.

(1) The thermal pad is not directly connected to any leads of the package; however, it is electrically and thermally connected to the substrate which is the ground of the device.

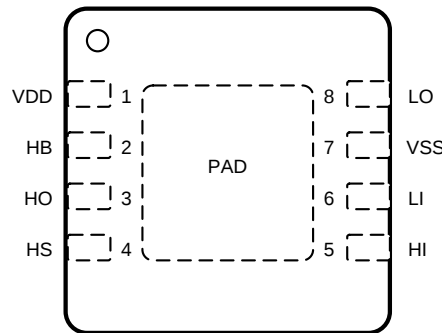
5 Specifications

5.1 Absolute Maximum Ratings

Over operating free-air temperature range and all voltages are with respect to V_{SS} (unless otherwise noted).⁽¹⁾

		MIN	MAX	UNIT
V_{DD}	Supply voltage	-0.3	20	V
V_{HI}, V_{LI}	Input voltages on HI and LI	-0.3	20	V
V_{LO}	Output voltage on LO	DC	$V_{DD} + 0.3$	V
		Repetitive pulse < 100 ns ⁽²⁾	$V_{DD} + 0.3$	
V_{HO}	Output voltage on HO	DC	$V_{HS} - 0.3$ $V_{HB} + 0.3$	V
		Repetitive pulse < 100 ns ⁽²⁾	$V_{HS} - 2$ $V_{HB} + 0.3$	
V_{HS}	Voltage on HS	DC	-1 120	V
		Repetitive pulse < 100 ns ⁽²⁾	-5 120	
V_{HB}	Voltage on HB	-0.3	120	V
	Voltage on HB-HS	-0.3	20	V
T_J	Operating junction temperature	-40	150	°C
T_{stg}	Storage temperature	-65	150	°C

- (1) Operation outside the *Absolute Maximum Ratings* may cause permanent device damage. *Absolute Maximum Ratings* do not imply functional operation of the device at these or any other conditions beyond those listed under *Recommended Operating Conditions*. If used outside the *Recommended Operating Conditions* but within the *Absolute Maximum Ratings*, the device may not be fully functional, and this may affect device reliability, functionality, performance, and shorten the device lifetime.
- (2) Values are verified by characterization and are not production tested.

5.2 ESD Ratings

		VALUE	UNIT
$V_{(ESD)}$	Electrostatic discharge	Human-body model (HBM), per ANSI/ESDA/JEDEC JS-001 ⁽¹⁾	V
		Charged-device model (CDM), per JEDEC specification JESD22-C101 ⁽²⁾	

- (1) JEDEC document JEP155 states that 500-V HBM allows safe manufacturing with a standard ESD control process.
- (2) JEDEC document JEP157 states that 250-V CDM allows safe manufacturing with a standard ESD control process.

5.3 Recommended Operating Conditions

Over operating free-air temperature range and all voltages are with respect to V_{SS} (unless otherwise noted).

		MIN	NOM	MAX	UNIT
V_{DD}	Supply voltage	8	12	17	V
V_{HS}	Voltage on HS	-1		105	V
	Voltage on HS (repetitive pulse < 100 ns) ⁽¹⁾	-5		110	
V_{HB}	Voltage on HB	$V_{HS} + 8.0$		115	
SR_{HS}	Voltage slew rate on HS			50	V/ns
T_J	Operating junction temperature	-40		150	°C

- (1) Values are verified by characterization and are not production tested.

5.4 Thermal Information

THERMAL METRIC ⁽¹⁾		UCC27200/UCC27201			UNIT
		D (SOIC)	DDA (PowerPad™ SOIC)	DRM (VSON)	
		8 Pins	8 Pins	8 Pins	
$R_{\theta JA}$	Junction-to-ambient thermal resistance	112.5	44.8	46.2	°C/W
$R_{\theta JC(top)}$	Junction-to-case (top) thermal resistance	52.1	68.5	41.1	°C/W
$R_{\theta JB}$	Junction-to-board thermal resistance	59.6	20	21.3	°C/W
Ψ_{JT}	Junction-to-top characterization parameter	7	6.9	1.3	°C/W

5.4 Thermal Information (続き)

THERMAL METRIC ⁽¹⁾		UCC27200/UCC27201			UNIT
		D (SOIC)	DDA (PowerPad™ SOIC)	DRM (VSON)	
		8 Pins	8 Pins	8 Pins	
Ψ_{JB}	Junction-to-board characterization parameter	58.7	20	21.2	°C/W
$R_{\theta JC(bot)}$	Junction-to-case (bottom) thermal resistance	-	8.4	9.1	°C/W

(1) For more information about traditional and new thermal metrics, see the Semiconductor and IC Package Thermal Metrics application report, SPRA953.

5.5 Electrical Characteristics

$V_{DD} = V_{HB} = 12\text{ V}$, $V_{HS} = V_{SS} = 0\text{ V}$, No load on LO or HO, $T_A = T_J = -40^\circ\text{C}$ to $+150^\circ\text{C}$ (unless otherwise noted).

PARAMETER		TEST CONDITIONS	MIN	TYP	MAX	UNIT
SUPPLY CURRENTS						
I_{DD}	VDD quiescent current	$V_{LI} = V_{HI} = 0\text{ V}$		0.11	0.8	mA
I_{DDO}	VDD operating current	$f = 500\text{ kHz}$, $C_{LOAD} = 0$		1	3	mA
I_{HB}	Boot voltage quiescent current	$V_{LI} = V_{HI} = 0\text{ V}$		0.065	0.8	mA
I_{HBO}	Boot voltage operating current	$f = 500\text{ kHz}$, $C_{LOAD} = 0$		0.9	3	mA
I_{HBS}	HB to VSS quiescent current	$V_{HS} = V_{HB} = 105\text{ V}$		0.0005	1	μA
I_{HBSO}	HB to VSS operating current	$f = 500\text{ kHz}$, $C_{LOAD} = 0$		0.03		mA
INPUT						
V_{HIT}	Input voltage high threshold	UCC27200		6	8	V
V_{LIT}	Input voltage low threshold		3	5.6		V
V_{IHYS}	Input voltage hysteresis		0.4			V
R_{IN}	Input pulldown resistance	UCC27200, $V_{IN} = 3\text{ V}$	100	200	350	kΩ
V_{HIT}	Input voltage high threshold	UCC27201	1.9	2.3	2.7	V
V_{LIT}	Input voltage low threshold		1.3	1.6	1.9	V
V_{IHYS}	Input voltage hysteresis		0.7			V
R_{IN}	Input pulldown resistance	UCC27201, $V_{IN} = 3\text{ V}$		68		kΩ
UNDERVOLTAGE PROTECTION (UVLO)						
V_{DDR}	VDD rising threshold		6.2	7.1	7.8	V
V_{DDHYS}	VDD threshold hysteresis			0.5		V
V_{HBR}	VHB rising threshold		5.8	6.7	7.2	V
V_{HBHYS}	VHB threshold hysteresis			0.4		V
BOOTSTRAP DIODE						
V_F	Low-current forward voltage	$I_{VDD-HB} = 100\text{ μA}$		0.65	0.85	V
V_{FI}	High-current forward voltage	$I_{VDD-HB} = 100\text{ mA}$		0.85	1.1	V
R_D	Dynamic resistance, $\Delta V_F/\Delta I$	$I_{VDD-HB} = 120\text{ mA}$ and 100 mA		0.65	1	Ω
LO GATE DRIVER						
V_{LOL}	Low level output voltage	$I_{LO} = 100\text{ mA}$		0.1	0.4	V
V_{LOH}	High level output voltage	$I_{LO} = -100\text{ mA}$, $V_{LOH} = V_{DD} - V_{LO}$		0.13	0.42	V
	Peak pullup current ⁽¹⁾	$V_{LO} = 0\text{ V}$		3		A
	Peak pulldown current ⁽¹⁾	$V_{LO} = 12\text{ V}$		3		A
HO GATE DRIVER						
V_{HOL}	Low level output voltage	$I_{HO} = 100\text{ mA}$		0.1	0.4	V
V_{HOH}	High level output voltage	$I_{HO} = -100\text{ mA}$, $V_{HOH} = V_{HB} - V_{HO}$		0.13	0.42	V
	Peak pullup current ⁽¹⁾	$V_{HO} = 0\text{ V}$		3		A
	Peak pulldown current ⁽¹⁾	$V_{HO} = 12\text{ V}$		3		A

(1) Parameter not tested in production.

5.6 Switching Characteristics

$V_{DD} = V_{HB} = 12\text{ V}$, $V_{HS} = V_{SS} = 0\text{ V}$, No load on LO or HO, $T_A = T_J = -40^\circ\text{C}$ to $+150^\circ\text{C}$ (unless otherwise noted).

PARAMETER		TEST CONDITIONS	MIN	TYP	MAX	UNIT
PROPAGATION DELAYS						
t_{DLFF}	VLI falling to VLO falling	$C_{LOAD} = 0\text{ pF}$, from V_{LIT} of LI to 90% of LO falling		22	50	ns
t_{DHFF}	VHI falling to VHO falling	$C_{LOAD} = 0\text{ pF}$, from V_{HIT} of HI to 90% of HO falling		22	50	ns
t_{DLRR}	VLI rising to VLO rising	$C_{LOAD} = 0\text{ pF}$, from V_{HIT} of LI to 10% of LO rising		22	50	ns
t_{DHRR}	VHI rising to VHO rising	$C_{LOAD} = 0\text{ pF}$, from V_{HIT} of HI to 10% of HO rising		22	50	ns
DELAY MATCHING						
t_{MON}	LI ON, HI OFF			1	7	ns
t_{MOFF}	LI OFF, HI ON			1	7	ns
OUTPUT RISE AND FALL TIME						
t_{R_LO}	LO rise time	$C_{LOAD} = 1000\text{ pF}$, from 10% to 90%		8		ns
t_{R_HO}	HO rise time	$C_{LOAD} = 1000\text{ pF}$, from 10% to 90%		8		ns
t_{F_LO}	LO fall time	$C_{LOAD} = 1000\text{ pF}$, from 10% to 90%		7		ns
t_{F_HO}	HO fall time	$C_{LOAD} = 1000\text{ pF}$, from 10% to 90%		7		ns
$t_{R_LO_p1}$	LO rise time (3 V to 9 V)	$C_{LOAD} = 0.1\text{ }\mu\text{F}$, (3V to 9V)		0.26	0.6	μs
$t_{R_HO_p1}$	HO rise time (3 V to 9 V)	$C_{LOAD} = 0.1\text{ }\mu\text{F}$, (3V to 9V)		0.26	0.6	μs
$t_{F_LO_p1}$	LO fall time (9 V to 3 V)	$C_{LOAD} = 0.1\text{ }\mu\text{F}$, (9V to 3V)		0.22	0.6	μs
$t_{F_HO_p1}$	HO fall time (9 V to 3 V)	$C_{LOAD} = 0.1\text{ }\mu\text{F}$, (9V to 3V)		0.22	0.6	μs
MISCELLANEOUS						
t_{IN_PW}	Minimum input pulse width that changes the output LO				50	ns
t_{IN_PW}	Minimum input pulse width that changes the output HO				50	ns
t_{OFF_BSD}	Bootstrap diode turnoff time ^{(1) (2)}	$I_F = 20\text{ mA}$, $I_{REV} = 0.5\text{ A}$ ⁽³⁾		20		ns

(1) Parameter not tested in production.

(2) Typical values for $T_A = 25^\circ\text{C}$.

(3) I_F : Forward current applied to bootstrap diode, I_{REV} : Reverse current applied to bootstrap diode.

5.7 Timing Diagrams



図 5-1. Timing Diagrams

5.8 Typical Characteristics



5-2. Quiescent Current vs Supply Voltage

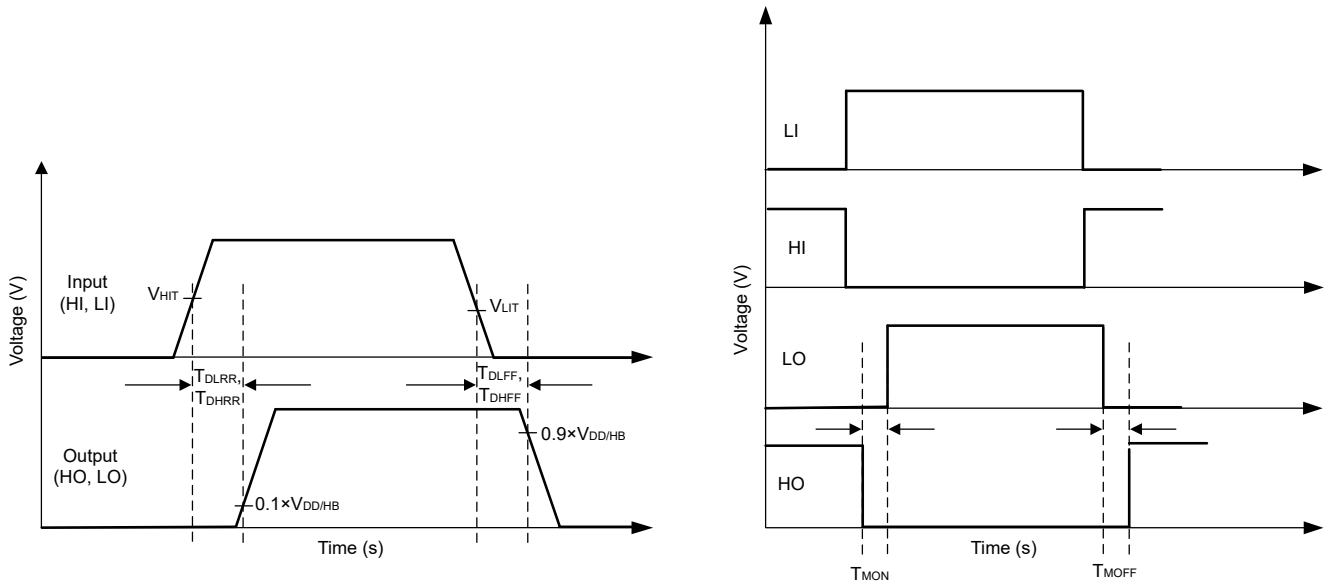
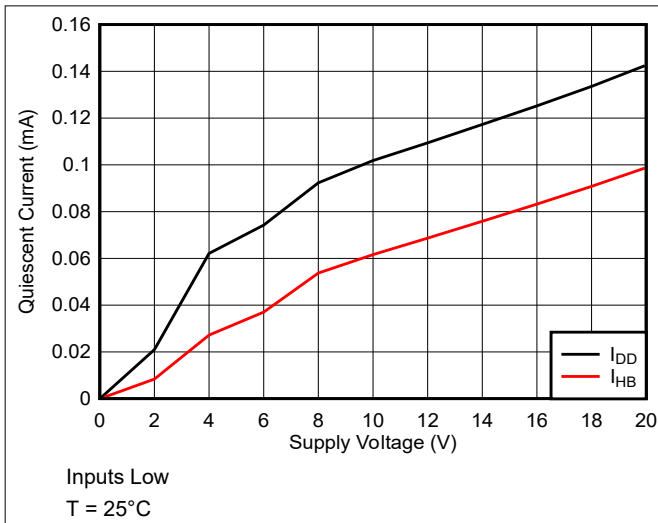
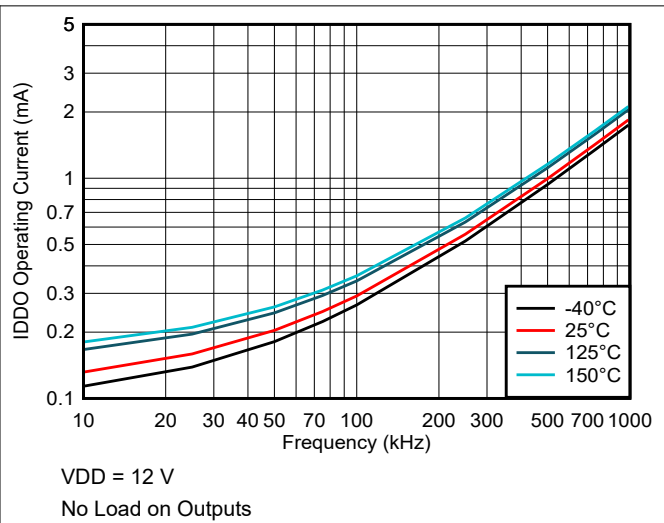

5-3. VDD Operating Current vs Frequency

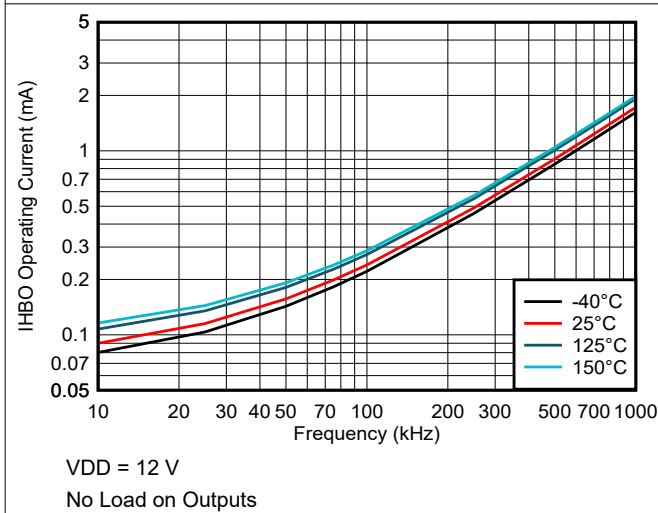

5-4. Boot Voltage Operating Current vs Frequency

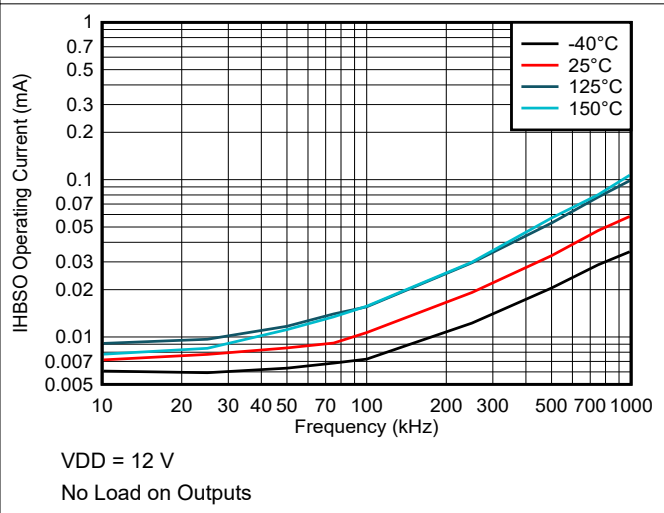

5-5. HB to VSS Operating Current vs Frequency

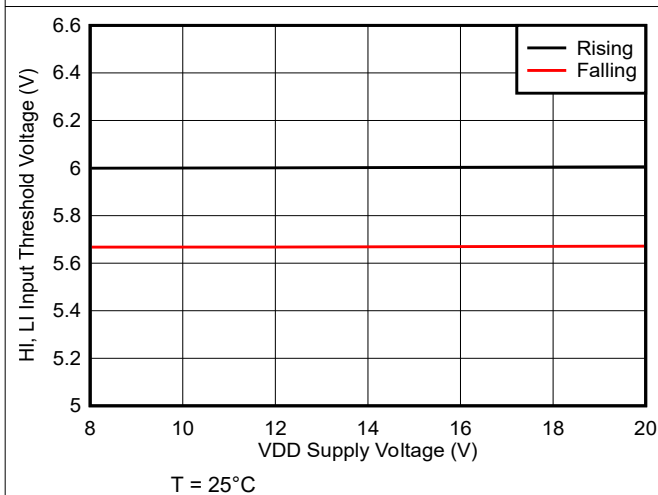

5-6. UCC27200A Input Threshold vs Supply Voltage

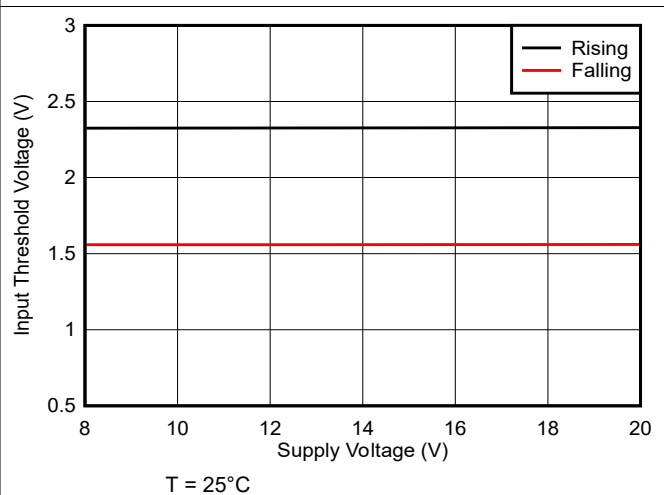

5-7. UCC27201A Input Threshold vs Supply Voltage

5.8 Typical Characteristics (continued)

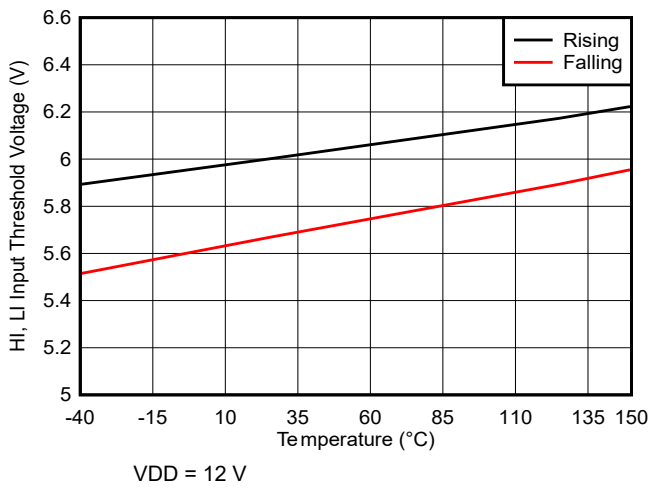

5-8. UCC27200A Input Threshold vs Temperature

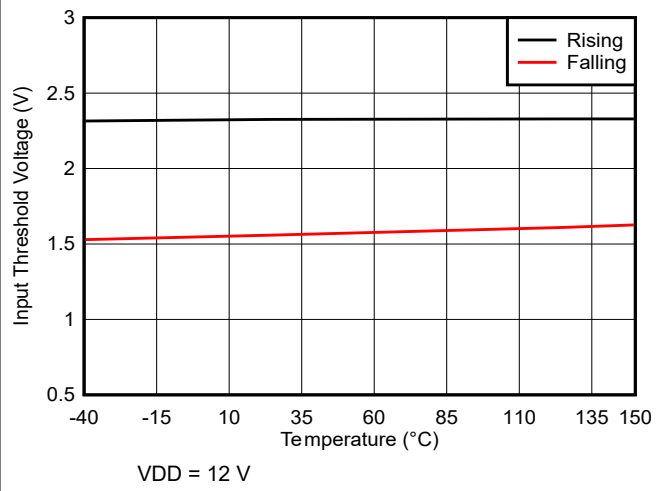

5-9. UCC27201A Input Threshold vs Temperature

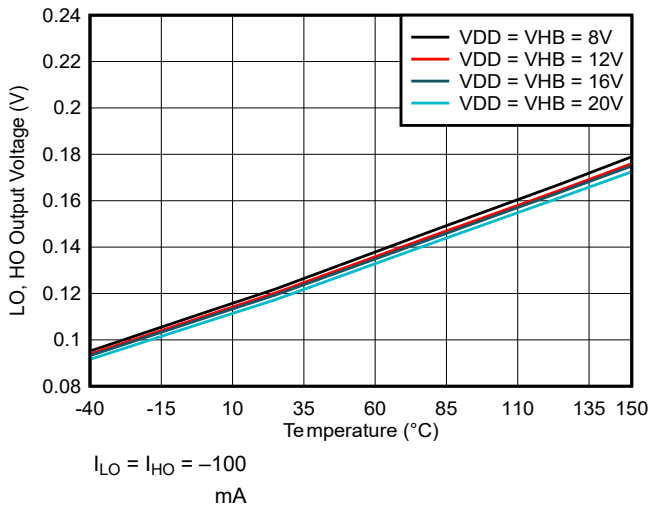

5-10. LO and HO High-Level Output Voltage vs Temperature

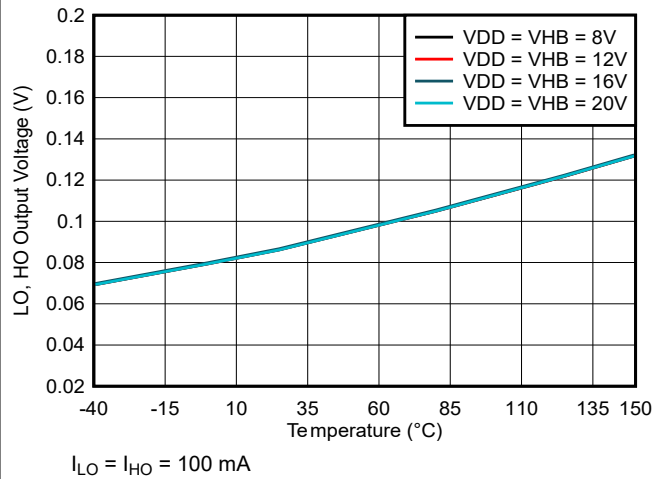

5-11. LO and HO Low-Level Output Voltage vs Temperature

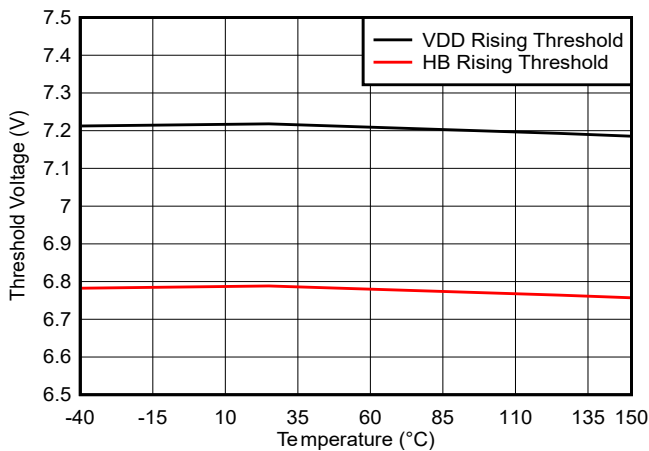

5-12. Undervoltage Lockout Threshold vs Temperature

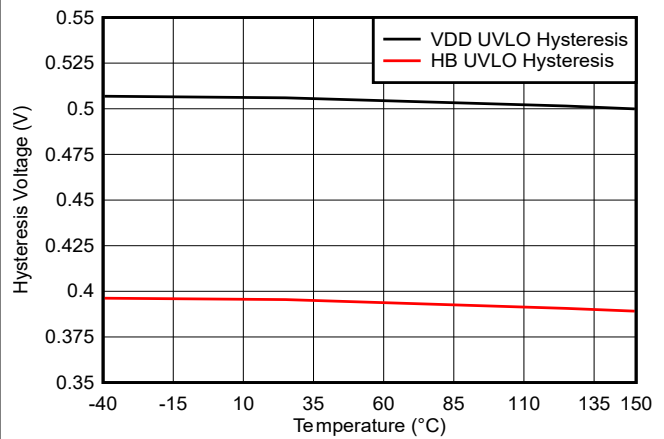

5-13. Undervoltage Lockout Threshold Hysteresis vs Temperature

5.8 Typical Characteristics (continued)

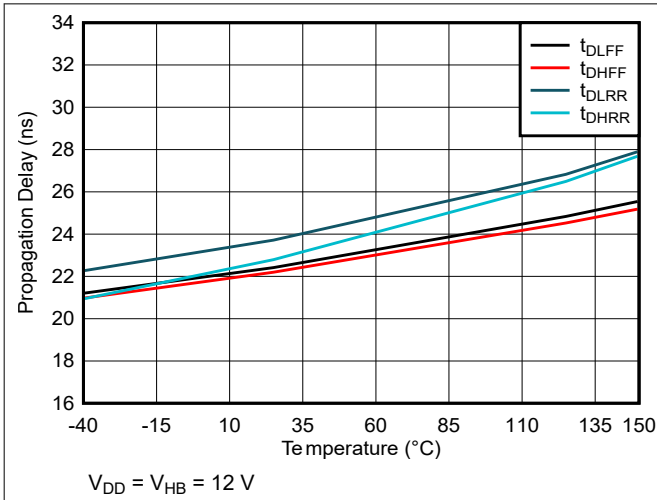

5-14. Propagation Delays vs Temperature

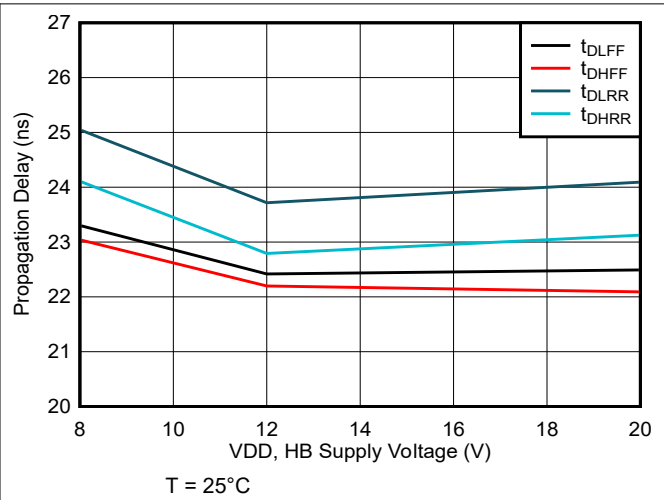

5-15. Propagation Delay vs Supply Voltage

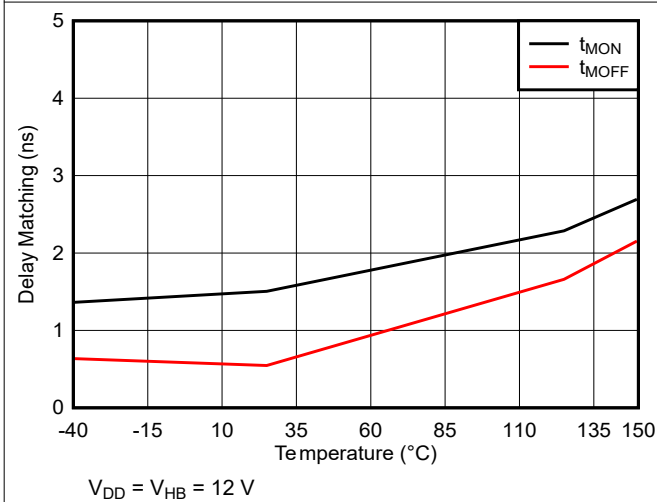

5-16. Delay Matching vs Temperature

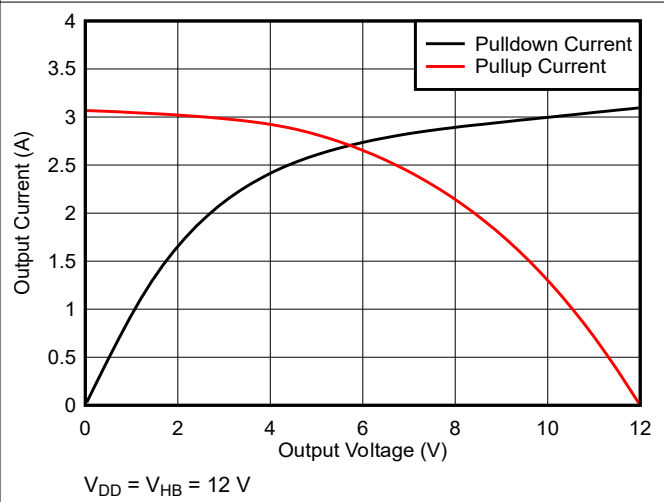

5-17. Output Current vs Output Voltage

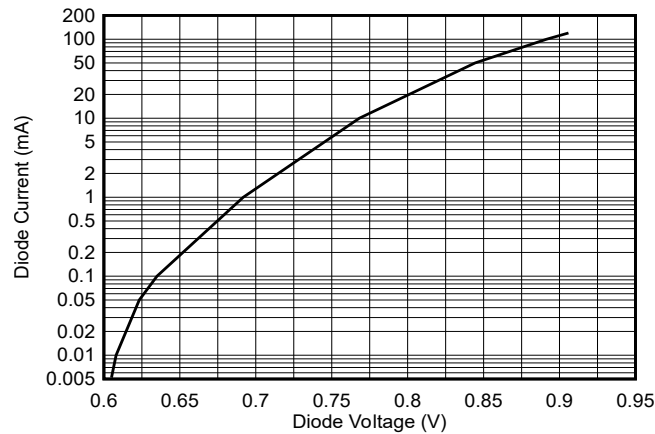

5-18. Diode Current vs Diode Voltage

6 Detailed Description

6.1 Overview

The UCC27200 and UCC27201 are high-side and low-side drivers. The high-side and low-side each have independent inputs which allow maximum flexibility of input control signals in the application. The boot diode for the high-side driver bias supply is internal to the UCC27200 and UCC27201. The UCC27200 is the CMOS compatible input version and the UCC27201 is the TTL or logic compatible version. The high-side driver is referenced to the switch node (HS) which is typically the source pin of the high-side MOSFET and drain pin of the low-side MOSFET. The low-side driver is referenced to VSS which is typically ground. The functions contained are the input stages, UVLO protection, level shift, boot diode, and output driver stages.

6.2 Functional Block Diagram

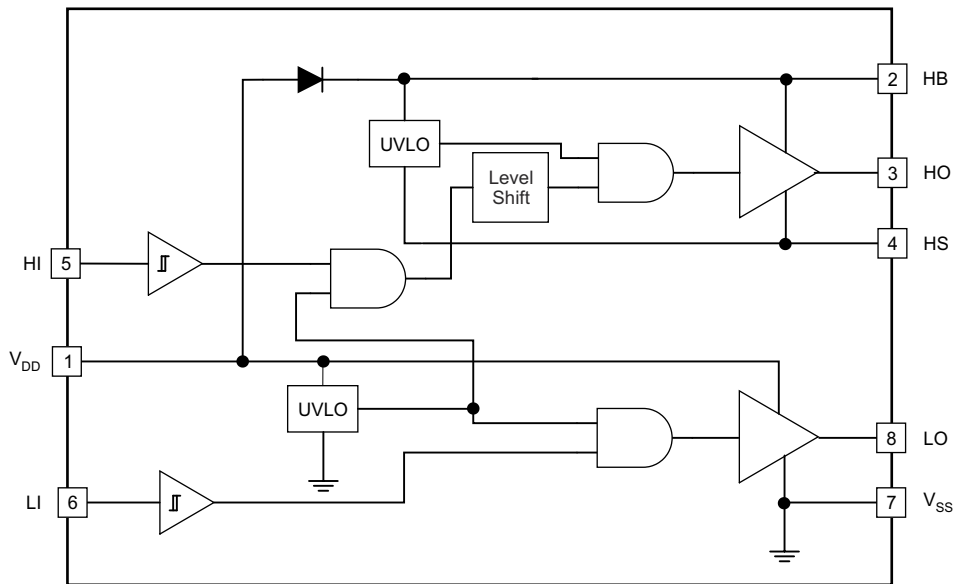

Copyright © 2016, Texas Instruments Incorporated

6.3 Feature Description

6.3.1 Input Stages

The input stages provide the interface to the PWM output signals. The input impedance of the UCC27200 is 200k Ω nominal and input capacitance is approximately 4pF. The 200k Ω is a pull-down resistance to VSS (ground). The CMOS compatible input of the UCC27200 provides a rising threshold of 6V and falling threshold of 5.6V. The inputs of the UCC27200 are intended to be driven from 0 to VDD levels.

The input stages of the UCC27201 incorporate an open drain configuration to provide the lower input thresholds. The input impedance is 68k Ω nominal and input capacitance is approximately 4pF. The 68k Ω is a pull-down resistance to VSS (ground). The logic level compatible input provides a rising threshold of 2.3V and a falling threshold of 1.6V.

6.3.2 Undervoltage Lockout (UVLO)

The bias supplies for the high-side and low-side drivers have undervoltage lockout (UVLO) protection. VDD as well as VHB to VHS differential voltages are monitored. The VDD UVLO disables both drivers when VDD is below the specified threshold. The rising VDD threshold is 7.1V with 0.5V hysteresis. The VHB UVLO disables only the high-side driver when the VHB to VHS differential voltage is below the specified threshold. The VHB UVLO rising threshold is 6.7V with 0.4V hysteresis.

6.3.3 Level Shift

The level shift circuit is the interface from the high-side input to the high-side driver stage which is referenced to the switch node (HS). The level shift allows control of the HO output referenced to the HS pin and provides excellent delay matching with the low-side driver.

6.3.4 Boot Diode

The boot diode necessary to generate the high-side bias is included in the UCC2720x family of drivers. The diode anode is connected to VDD and cathode connected to VHB. With the VHB capacitor connected to HB and the HS pins, the VHB capacitor charge is refreshed every switching cycle when HS transitions to ground. The boot diode provides fast recovery times, low diode resistance, and voltage rating margin to allow for efficient and reliable operation.

6.3.5 Output Stages

The output stages are the interface to the power MOSFETs in the power train. High slew rate, low resistance and high peak current capability of both output drivers allow for efficient switching of the power MOSFETs. The low-side output stage is referenced from VDD to VSS and the high-side is referenced from VHB to VHS.

6.4 Device Functional Modes

The device operates in normal mode and UVLO mode. See [セクション 6.3.2](#) for more information on UVLO operation mode. In normal mode, the output stage is dependent on the states of the HI and LI pins.

表 6-1. Device Logic Table

HI PIN	LI PIN	HO ⁽¹⁾	LO ⁽²⁾
L	L	L	L
L	H	L	H
H	L	H	L
H	H	H	H

(1) HO is measured with respect to the HS.

(2) LO is measured with respect to the VSS.

7 Application and Implementation

注

以下のアプリケーション情報は、TI の製品仕様に含まれるものではなく、TI ではその正確性または完全性を保証いたしません。個々の目的に対する製品の適合性については、お客様の責任で判断していただくこととなります。お客様は自身の設計実装を検証しテストすることで、システムの機能を確認する必要があります。

7.1 Application Information

To effect fast switching of power devices and reduce associated switching power losses, a powerful gate driver is employed between the PWM output of controllers and the gates of the power semiconductor devices. Also, gate drivers are indispensable when it is impossible for the PWM controller to directly drive the gates of the switching devices. With the advent of digital power, this situation is often encountered because the PWM signal from the digital controller is often a 3.3V logic signal which cannot effectively turn on a power switch. Level shifting circuitry is needed to boost the 3.3V signal to the gate-drive voltage (such as 12V) to fully turn on the power device and minimize conduction losses. Traditional buffer drive circuits based on NPN and PNP bipolar transistors in totem-pole arrangement, being emitter follower configurations, prove inadequate with digital power because they lack level-shifting capability. Gate drivers effectively combine both the level-shifting and buffer-drive functions. Gate drivers also find other needs such as minimizing the effect of high-frequency switching noise by locating the high-current driver physically close to the power switch, driving gate-drive transformers and controlling floating power-device gates, reducing power dissipation and thermal stress in controllers by moving gate charge power losses from the controller into the driver.

7.2 Typical Application

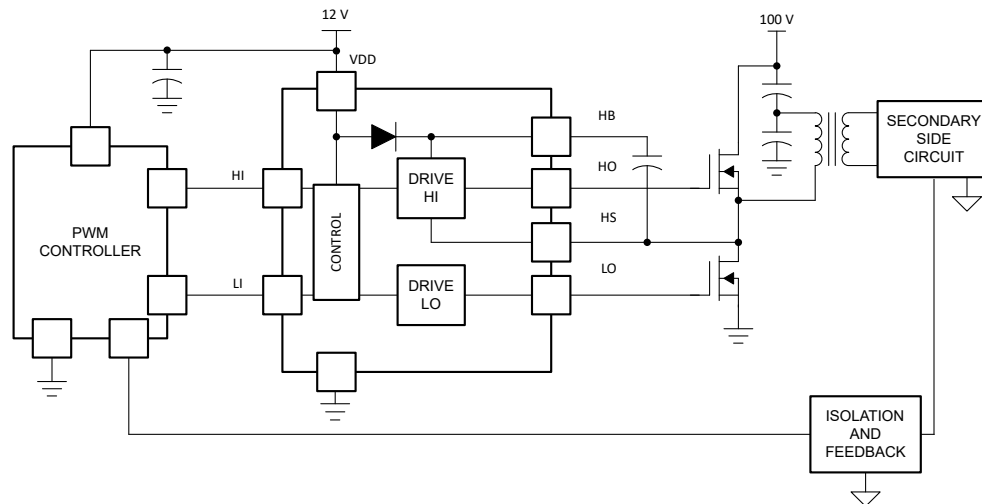

Copyright © 2017, Texas Instruments Incorporated

図 7-1. UCC2720x Typical Application Diagram

7.2.1 Design Requirements

For this design example, use the parameters listed in 表 7-1.

表 7-1. Design Specifications

DESIGN PARAMETER	EXAMPLE VALUE
Supply voltage, VDD	12V
Voltage on HS, VHS	0V to 100V
Voltage on HB, VHB	12V to 112V
Output current rating, IO	-3A to 3A

表 7-1. Design Specifications (続き)

DESIGN PARAMETER	EXAMPLE VALUE
Operating frequency	200kHz

7.2.2 Detailed Design Procedure

7.2.2.1 Input Threshold Type

The UCC27200 device features CMOS compatible input threshold logic with wide hysteresis. The threshold voltage levels are low voltage and independent of the VDD supply voltage, which allows compatibility with both logic-level input signals from microcontrollers as well as higher-voltage input signals from analog controllers. See the [Electrical Characteristics](#) table for the actual input threshold voltage levels and hysteresis specifications for the UCC27200 device.

The UCC27201 device features TTL compatible input threshold logic with wide hysteresis. The threshold voltage levels are low voltage and independent of the VDD supply voltage, which allows compatibility with both logic-level input signals from microcontrollers as well as higher-voltage input signals from analog controllers. See the *Electrical Characteristics* table for the actual input threshold voltage levels and hysteresis specifications for the UCC27201 device.

7.2.2.2 V_{DD} Bias Supply Voltage

The bias supply voltage to be applied to the VDD pin of the device should never exceed the values listed in the [Absolute Maximum Ratings](#) table. Different power switches demand different voltage levels to be applied at the gate terminals for effective turnon and turnoff. With certain power switches, a positive gate voltage may be required for turnon and a negative gate voltage may be required for turnoff, in which case the VDD bias supply equals the voltage differential. With a wide operating range from 8V to 17V, the UCC2720x devices can be used to drive a variety of power switches, such as Si MOSFETs, IGBTs, and wide-bandgap power semiconductors.

7.2.2.3 Peak Source and Sink Currents

Generally, the switching speed of the power switch during turnon and turnoff should be as fast as possible in order to minimize switching power losses. The gate driver device must be able to provide the required peak current for achieving the targeted switching speeds with the targeted power MOSFET. The system requirement for the switching speed is typically described in terms of the slew rate of the drain-to-source voltage of the power MOSFET (such as dV_{DS}/dt). For example, the system requirement might state that a SPP20N60C3 power MOSFET must be turned-on with a dV_{DS}/dt of 20V/ns or higher with a DC bus voltage of 400V in a continuous-conduction-mode (CCM) boost PFC-converter application. This type of application is an inductive hard-switching application and reducing switching power losses is critical. This requirement means that the entire drain-to-source voltage swing during power MOSFET turnon event (from 400V in the OFF state to $V_{DS(on)}$ in on state) must be completed in approximately 20ns or less. When the drain-to-source voltage swing occurs, the Miller charge of the power MOSFET (Q_{GD} parameter in the SPP20N60C3 data sheet is 33nC typical) is supplied by the peak current of gate driver. According to power MOSFET inductive switching mechanism, the gate-to-source voltage of the power MOSFET at this time is the Miller plateau voltage, which is typically a few volts higher than the threshold voltage of the power MOSFET, $V_{GS(TH)}$.

To achieve the targeted dV_{DS}/dt , the gate driver must be capable of providing the Q_{GD} charge in 20ns or less. In other words a peak current of 1.65A (= 33nC / 20ns) or higher must be provided by the gate driver. The UCC2720x gate driver is capable of providing 3A peak sourcing current which clearly exceeds the design requirement and has the capability to meet the switching speed needed. The overdrive capability provides an extra margin against part-to-part variations in the Q_{GD} parameter of the power MOSFET along with additional flexibility to insert external gate resistors and fine tune the switching speed for efficiency versus EMI optimizations. However, in practical designs the parasitic trace inductance in the gate drive circuit of the PCB will have a definitive role to play on the power MOSFET switching speed. The effect of this trace inductance is to limit the dI/dt of the output current pulse of the gate driver. In order to illustrate this, consider output current pulse waveform from the gate driver to be approximated to a triangular profile, where the area under the triangle ($\frac{1}{2} \times I_{PEAK} \times \text{time}$) would equal the total gate charge of the power MOSFET (Q_G parameter in SPP20N60C3 power MOSFET datasheet = 87nC typical). If the parasitic trace inductance limits the dI/dt then a situation may occur in which the full peak current capability of the gate driver is not fully achieved in the time required to deliver the Q_G required for the power MOSFET switching. In other words the time parameter in the equation would dominate and the I_{PEAK} value of the current pulse would be much less than the true peak current capability of the device, while the required Q_G is still delivered. Because of this, the desired switching speed may not be realized,

even when theoretical calculations indicate the gate driver is capable of achieving the targeted switching speed. Thus, placing the gate driver device very close to the power MOSFET and designing a tight gate drive-loop with minimal PCB trace inductance is important to realize the full peak-current capability of the gate driver.

7.2.2.4 Propagation Delay

The acceptable propagation delay from the gate driver is dependent on the switching frequency at which it is used and the acceptable level of pulse distortion to the system. The UCC2720x device features 22ns (typical) propagation delays, which ensures very little pulse distortion and allows operation at very high-frequencies. See the [Electrical Characteristics](#) table for the propagation and switching characteristics of the UCC2720x device.

7.2.2.5 Power Dissipation

Power dissipation of the gate driver has two portions as shown in [式 1](#).

$$P_{DISS} = P_{DC} + P_{SW} \quad (1)$$

Use [式 2](#) to calculate the DC portion of the power dissipation (PDC).

$$PDC = I_Q \times V_{DD} \quad (2)$$

where

- I_Q is the quiescent current for the driver.

The quiescent current is the current consumed by the device to bias all internal circuits such as input stage, reference voltage, logic circuits, protections, and also any current associated with switching of internal devices when the driver output changes state (such as charging and discharging of parasitic capacitances, parasitic shoot-through, and so forth). The UCC2720x features very low quiescent currents (refer to the [Electrical Characteristics](#) table) and contain internal logic to eliminate any shoot-through in the output driver stage. Thus the effect of the PDC on the total power dissipation within the gate driver can be safely assumed to be negligible. The power dissipated in the gate-driver package during switching (PSW) depends on the following factors:

- Gate charge required of the power device (usually a function of the drive voltage V_G , which is very close to input bias supply voltage V_{DD})
- Switching frequency
- Use of external gate resistors. When a driver device is tested with a discrete, capacitive load calculating the power that is required from the bias supply is fairly simple. The energy that must be transferred from the bias supply to charge the capacitor is given by [式 3](#).

$$EG = \frac{1}{2} C_{LOAD} \times V_{DD}^2 \quad (3)$$

- where
- C_{LOAD} is load capacitor
- V_{DD} is bias voltage feeding the driver

There is an equal amount of energy dissipated when the capacitor is charged and when it is discharged. This leads to a total power loss given by [式 4](#).

$$PG = C_{LOAD} \times V_{DD}^2 \times f_{SW} \quad (4)$$

where

- f_{SW} is the switching frequency

The switching load presented by a power MOSFET/IGBT is converted to an equivalent capacitance by examining the gate charge required to switch the device. This gate charge includes the effects of the input capacitance plus the added charge needed to swing the drain voltage of the power device as it switches between the ON and OFF states. Most manufacturers provide specifications of typical and maximum gate charge, in nC, to switch the device under specified conditions. Using the gate charge Q_g , determine the power

that must be dissipated when switching a capacitor which is calculated using the equation $Q_G = C_{LOAD} \times V_{DD}$ to provide 式 5 for power.

$$P_G = C_{LOAD} \times V_{DD}^2 \times f_{SW} = Q_G \times V_{DD} \times f_{SW} \quad (5)$$

This power P_G is dissipated in the resistive elements of the circuit when the MOSFET/IGBT is being turned on and off. Half of the total power is dissipated when the load capacitor is charged during turnon, and the other half is dissipated when the load capacitor is discharged during turnoff. When no external gate resistor is employed between the driver and MOSFET/IGBT, this power is completely dissipated inside the driver package. With the use of external gate-drive resistors, the power dissipation is shared between the internal resistance of driver and external gate resistor.

7.2.3 Application Curves

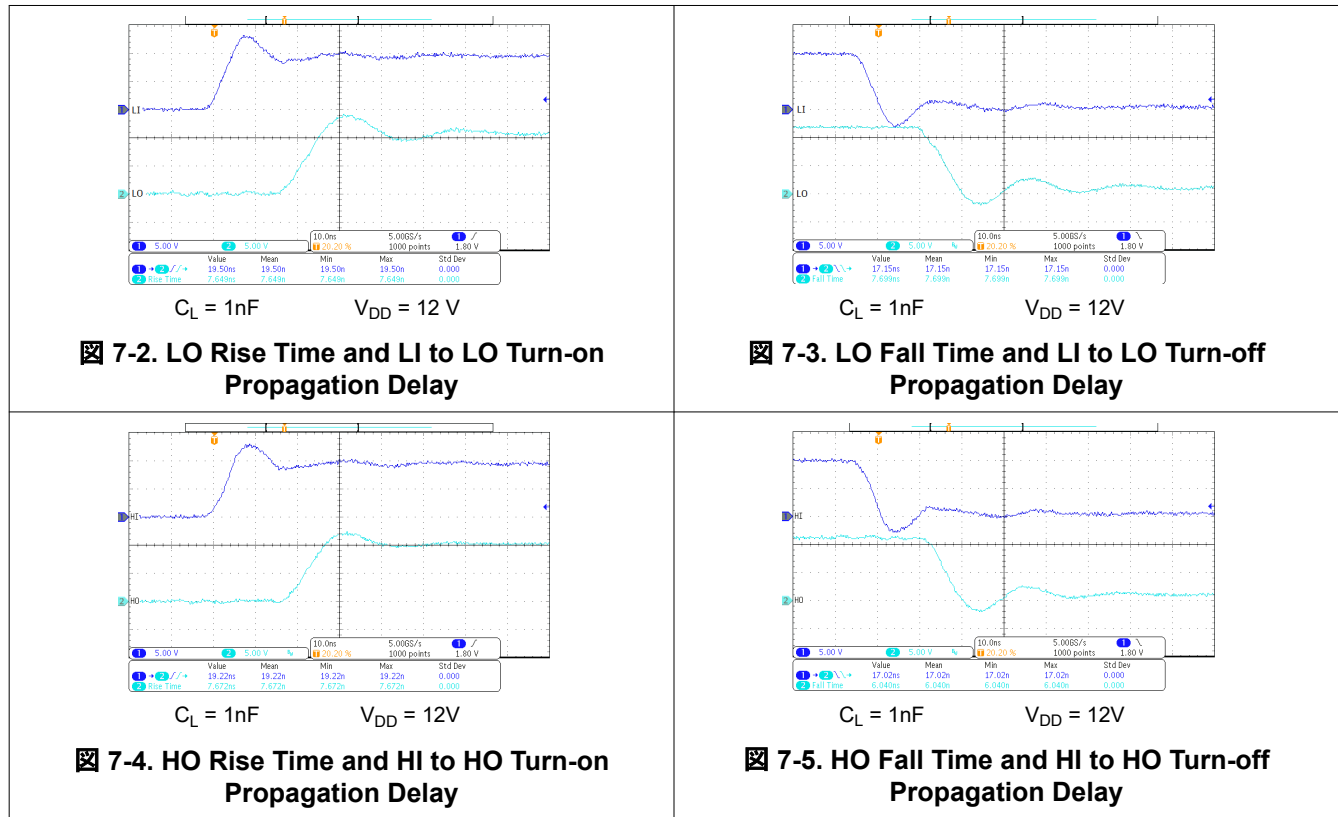

8 Power Supply Recommendations

The bias supply voltage range for which the device is rated to operate is from 8V to 17V. The lower end of this range is governed by the internal UVLO protection feature on the VDD pin supply circuit blocks. Whenever the driver is in UVLO condition when the VDD pin voltage is below the V(ON) supply start threshold, this feature holds the output low, regardless of the status of the inputs. The upper end of this range is driven by the 20V absolute maximum voltage rating of the VDD pin of the device (which is a stress rating). Keeping a 3V margin to allow for transient voltage spikes, the maximum voltage for the VDD pin is 17V. The UVLO protection feature also involves a hysteresis function. This means that when the VDD pin bias voltage has exceeded the threshold voltage and device begins to operate, and if the voltage drops, then the device continues to deliver normal functionality unless the voltage drop exceeds the hysteresis specification VDD(hys). Therefore, ensuring that, while operating at or near the 8V range, the voltage ripple on the auxiliary power supply output is smaller than the hysteresis specification of the device is important to avoid triggering device shutdown. During system shutdown, the device operation continues until the VDD pin voltage has dropped below the V(OFF) threshold which must be accounted for while evaluating system shutdown timing design requirements. Likewise, at system start-up, the device does not begin operation until the VDD pin voltage has exceeded above the V(ON) threshold. The quiescent current consumed by the internal circuit blocks of the device is supplied through the VDD pin. Although this fact is well known, recognizing that the charge for source current pulses delivered by the LO pin is also supplied through the same VDD pin is important. As a result, every time a current is sourced out of the LO pin a corresponding current pulse is delivered into the device through the VDD pin. Thus ensuring that a local bypass capacitor is provided between the VDD and GND pins and located as close to the device as possible for the purpose of decoupling is important. A low ESR, ceramic surface mount capacitor is a must. TI recommends using a capacitor in the range of 0.22 μ F to 4.7 μ F between VDD and GND. In a similar manner, the current pulses delivered by the HO pin are sourced from the HB pin. Therefore, TI recommends a 0.022 μ F to 0.1 μ F local decoupling capacitor between the HB and HS pins.

9 Layout

9.1 Layout Guidelines

To improve the switching characteristics and efficiency of a design, the following layout rules must be followed.

- Place the driver as close as possible to the MOSFETs.
- Place the V_{DD} and V_{HB} (bootstrap) capacitors as close as possible to the driver.
- Pay close attention to the GND trace. Use the thermal pad of the DDA and DRM package as GND by connecting it to the VSS pin (GND). The GND trace from the driver goes directly to the source of the MOSFET but must not be in the high current path of the MOSFET(s) drain or source current.
- Use similar rules for the HS node as for GND for the high-side driver.
- Use wide traces for LO and HO closely following the associated GND or HS traces. 60mil to 100mil width is preferable where possible.
- Use as least two or more vias if the driver outputs or SW node must be routed from one layer to another. For GND the number of vias must be a consideration of the thermal pad requirements as well as parasitic inductance.
- Avoid L_I and H_I (driver input) going close to the HS node or any other high dV/dT traces that can induce significant noise into the relatively high impedance leads.
- Keep in mind that a poor layout can cause a significant drop in efficiency versus a good PCB layout and can even lead to decreased reliability of the whole system.

9.2 Layout Example



図 9-1. Example Component Placement

10 Device and Documentation Support

10.1 サード・パーティ製品に関する免責事項

サード・パーティ製品またはサービスに関するテキサス・インスツルメンツの出版物は、単独またはテキサス・インスツルメンツの製品、サービスと一緒に提供される場合に関係なく、サード・パーティ製品またはサービスの適合性に関する是認、サード・パーティ製品またはサービスの是認の表明を意味するものではありません。

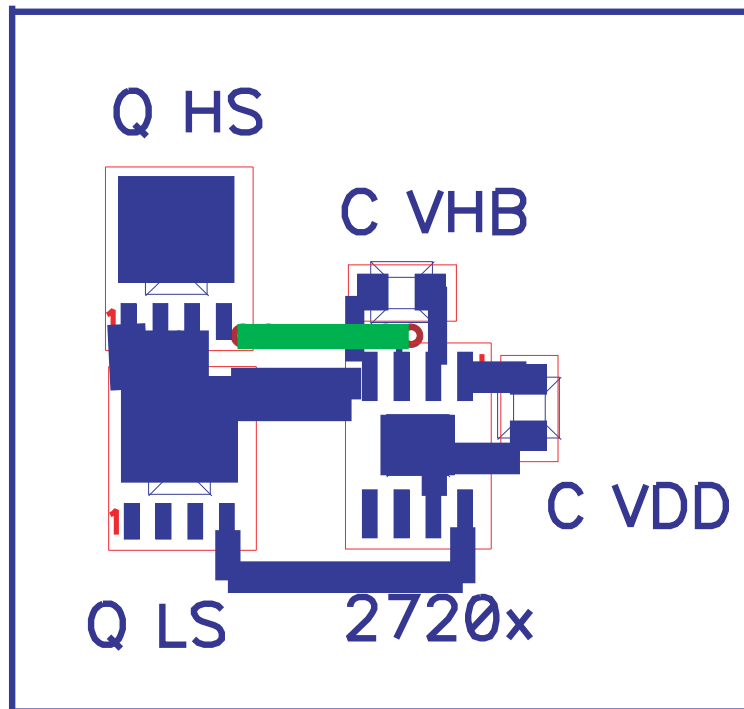
10.2 Documentation Support

10.2.1 Related Documentation

For related documentation see the following:

- QFN/SON PCB Attachment, [SLUA271](#)
- PowerPAD Thermally Enhanced Package, [SLMA002](#)
- PowePAD Made Easy, [SLMA004](#)

10.3 ドキュメントの更新通知を受け取る方法

ドキュメントの更新についての通知を受け取るには、www.tij.co.jp のデバイス製品フォルダを開いてください。[通知] をクリックして登録すると、変更されたすべての製品情報に関するダイジェストを毎週受け取ることができます。変更の詳細については、改訂されたドキュメントに含まれている改訂履歴をご覧ください。

10.4 サポート・リソース

テキサス・インスツルメンツ E2E™ サポート・フォーラムは、エンジニアが検証済みの回答と設計に関するヒントをエキスパートから迅速かつ直接得ることができる場所です。既存の回答を検索したり、独自の質問をしたりすることで、設計に必要な支援を迅速に得ることができます。

リンクされているコンテンツは、各寄稿者により「現状のまま」提供されるものです。これらはテキサス・インスツルメンツの仕様を構成するものではなく、必ずしもテキサス・インスツルメンツの見解を反映したものではありません。テキサス・インスツルメンツの[使用条件](#)を参照してください。

10.5 Trademarks

テキサス・インスツルメンツ E2E™ is a trademark of Texas Instruments.

すべての商標は、それぞれの所有者に帰属します。

10.6 静電気放電に関する注意事項



この IC は、ESD によって破損する可能性があります。テキサス・インスツルメンツは、IC を取り扱う際には常に適切な注意を払うことを推奨します。正しい取り扱いおよび設置手順に従わない場合、デバイスを破損するおそれがあります。

ESD による破損は、わずかな性能低下からデバイスの完全な故障まで多岐にわたります。精密な IC の場合、パラメータがわずかに変化するだけで公表されている仕様から外れる可能性があるため、破損が発生しやすくなっています。

10.7 用語集

[テキサス・インスツルメンツ用語集](#) この用語集には、用語や略語の一覧および定義が記載されています。

11 Revision History

資料番号末尾の英字は改訂を表しています。その改訂履歴は英語版に準じています。

Changes from Revision C (April 2016) to Revision D (July 2024)	Page
• デバイスの主な特長を反映するようにドキュメントのタイトルを変更。デバイスの特性を反映するように仕様の一部を更新。.....	1
• ドキュメント全体にわたって表、図、相互参照の採番方法を更新.....	1
• 「特長」セクションを変更: 1) 接合部温度範囲の仕様を変更。修正前: -40°C ~ 140°C。修正後: -40°C ~ 150°C。2) 伝搬遅延の標準値を変更。修正前: 20ns。修正後: 22ns。3) 「1MHz を超える動作」の記述を削除 (このスイッチング周波数は規定のパラメータではないため)。4) ブートストラップ ダイオード抵抗の標準値を変更。修正前: 0.6Ω。修正後: 0.65Ω。.....	1
• 「アプリケーション」セクションを更新して代表的なアプリケーションの上位 5 つを記載.....	1
• Updated Absolute Maximum Ratings section to remove "Power dissipation at TA = 25°C" and "Lead temperature (soldering, 10s)". Power dissipation can be calculated with thermal metrics in "Thermal Information" table.....	4
• Updated Recommended Operating Conditions: Operating Junction Temperature maximum changed from 140°C to 150°C.....	4
• Updated Thermal Information section to reflect device characteristics.	4
• Updated Supply Currents specifications in the Electrical Characteristics table: 1) I _{DD} typical changed (From: 0.4mA. To: 0.11mA). 2) I _{DDO} typical changed (From: 2.5mA for UCC27200 and 3.8mA for UCC27201. To: 1mA for both). 3) I _{DDO} maximum changed (From: 4mA for UC27200 and 5.5mA for UCC27201. To: 3mA for both). 4) I _{HB} typical changed (From: 0.4mA. To: 0.065mA). 5) I _{HBO} typical changed (From: 2.5mA. To: 0.9mA). 6) I _{HBO} maximum changed (From: 4mA. To: 3mA). 7) I _{HBS} test condition changed to match V _{HS} maximum recommended operating conditions (From: 110V. To: 105V). 8) I _{HBSO} typical changed (From: 0.1mA. To: 0.03mA).....	4
• Updated Input specifications in the Electrical Characteristics table: 1) UCC27200 V _{HIT} typical changed (From: 5.8V. To: 6V). 2) UCC27200 V _{LIT} typical changed (From: 5.4V. To: 5.6V). 3) UCC27201 V _{HIT} specifications changed (From: 1.7V typical, 2.5V maximum. To: 1.9V minimum, 2.3V typical, 2.7V maximum). 4) UCC27201 V _{LIT} specifications changed (From: 0.8V minimum, 1.6V typical. To: 1.3V minimum, 1.6V typical, 1.9V maximum). 5) UCC27201 V _{IHYS} typical changed (From: 100mV. To: 700mV). 6) UCC27201 R _{IN} specifications changed from (100kΩ minimum, 200kΩ typical, 350kΩ maximum. To: 68kΩ typical).	4
• Updated Bootstrap diode specifications in the Electrical Characteristics table: 1) R _D test conditions changed (From: 100mA and 80mA. To: 120mA and 100mA). 2) R _D typical changed (From: 0.6Ω. To: 0.65Ω).	4
• Updated LO/HO Gate Driver specifications in the Electrical Characteristics table: 1) V _{LOL} typical changed (From 0.18V. To 0.1V). 2) V _{LOH} typical changed (From: 0.25V. To: 0.13V).	4
• Removed specifications with test conditions "-40°C to 125°C T _J ", since all parameters are specified from -40°C to 150°C T _J (unless otherwise noted).	4
• Changed Propagation Delays typical specification (From: 20ns. To: 22ns).....	4
• Updated Output Rise and Fall Time specifications: 1) t _R typical changed (From: 0.35us. To: 0.26us). 2) t _F typical changed (From: 0.3us. To: 0.22us).	4
• Updated all plots in Typical Characteristics section to reflect the device's typical specification.	8
• Updated Input Stages section. 1) Changed UCC27201A input pulldown resistance typical to match the specification in the electrical characteristics table (From: 70kΩ. To: 68kΩ). 2) Changed input capacitance From: 2pF To: 4pF. 3) Changed UCC27200A input thresholds to 6V and 5.6V to reflect the specification in the electrical characteristics table (From: 48% and 45% of VDD. To: 6V and 5.6V).....	11
• Updated Typical Application section to display a different application diagram and detailed design procedure since information in legacy datasheet had an outdated circuit with obsolete part numbers.	13
• Changed application curves to display propagation delay and rise/fall time plots.	17
• Updated Power Supply Recommendations section to fix 3 typos.....	18

Changes from Revision B (November 2008) to Revision C (April 2016)**Page**

- 「製品情報」表、「改訂履歴」セクション、「ピン構成および機能」セクション、「仕様」セクション、「詳細説明」セクション、「アプリケーションと実装」セクション、「電源に関する推奨事項」セクション、「レイアウト」セクション、「デバイスおよびドキュメントのサポート」セクション、「メカニカル、パッケージ、および注文情報」セクションを追加..... 1

12 Mechanical, Packaging, and Orderable Information

The following pages include mechanical, packaging, and orderable information. This information is the most current data available for the designated devices. This data is subject to change without notice and revision of this document. For browser-based versions of this data sheet, refer to the left-hand navigation.

重要なお知らせと免責事項

テキサス・インスツルメンツは、技術データと信頼性データ (データシートを含みます)、設計リソース (リファレンス デザインを含みます)、アプリケーションや設計に関する各種アドバイス、Web ツール、安全性情報、その他のリソースを、欠陥が存在する可能性のある「現状のまま」提供しており、商品性および特定目的に対する適合性の黙示保証、第三者の知的財産権の非侵害保証を含むいかなる保証も、明示的または黙示的にかかわらず拒否します。

これらのリソースは、テキサス・インスツルメンツ製品を使用する設計の経験を積んだ開発者への提供を意図したものです。(1) お客様のアプリケーションに適した テキサス・インスツルメンツ製品の選定、(2) お客様のアプリケーションの設計、検証、試験、(3) お客様のアプリケーションに該当する各種規格や、その他のあらゆる安全性、セキュリティ、規制、または他の要件への確実な適合に関する責任を、お客様のみが単独で負うものとします。

上記の各種リソースは、予告なく変更される可能性があります。これらのリソースは、リソースで説明されている テキサス・インスツルメンツ製品を使用するアプリケーションの開発の目的でのみ、テキサス・インスツルメンツはその使用をお客様に許諾します。これらのリソースに関して、他の目的で複製することや掲載することは禁止されています。テキサス・インスツルメンツや第三者の知的財産権のライセンスが付与されている訳ではありません。お客様は、これらのリソースを自身で使用した結果発生するあらゆる申し立て、損害、費用、損失、責任について、テキサス・インスツルメンツおよびその代理人を完全に補償するものとし、テキサス・インスツルメンツは一切の責任を拒否します。

テキサス・インスツルメンツの製品は、[テキサス・インスツルメンツの販売条件](#)、または [ti.com](https://www.ti.com) やかかる テキサス・インスツルメンツ製品の関連資料などのいずれかを通じて提供する適用可能な条項の下で提供されています。テキサス・インスツルメンツがこれらのリソースを提供することは、適用されるテキサス・インスツルメンツの保証または他の保証の放棄の拡大や変更を意味するものではありません。

お客様がいかなる追加条項または代替条項を提案した場合でも、テキサス・インスツルメンツはそれらに異議を唱え、拒否します。

郵送先住所: Texas Instruments, Post Office Box 655303, Dallas, Texas 75265

Copyright © 2024, Texas Instruments Incorporated

PACKAGING INFORMATION

Orderable part number	Status (1)	Material type (2)	Package Pins	Package qty Carrier	RoHS (3)	Lead finish/ Ball material (4)	MSL rating/ Peak reflow (5)	Op temp (°C)	Part marking (6)
UCC27200D	Obsolete	Production	SOIC (D) 8	-	-	Call TI	Call TI	-40 to 140	27200
UCC27200DDA	Obsolete	Production	SO PowerPAD (DDA) 8	-	-	Call TI	Call TI	-40 to 140	27200
UCC27200DDAR	Active	Production	SO PowerPAD (DDA) 8	2500 LARGE T&R	Yes	NIPDAU NIPDAUAG	Level-1-260C-UNLIM	-40 to 150	27200
UCC27200DDAR.A	Active	Production	SO PowerPAD (DDA) 8	2500 LARGE T&R	Yes	NIPDAU	Level-1-260C-UNLIM	-40 to 150	27200
UCC27200DDAR.B	Active	Production	SO PowerPAD (DDA) 8	2500 LARGE T&R	Yes	NIPDAU	Level-1-260C-UNLIM	-40 to 150	27200
UCC27200DR	Active	Production	SOIC (D) 8	2500 LARGE T&R	Yes	NIPDAU	Level-1-260C-UNLIM	-40 to 150	27200
UCC27200DR.A	Active	Production	SOIC (D) 8	2500 LARGE T&R	Yes	NIPDAU	Level-1-260C-UNLIM	-40 to 150	27200
UCC27200DR.B	Active	Production	SOIC (D) 8	2500 LARGE T&R	Yes	NIPDAU	Level-1-260C-UNLIM	-40 to 150	27200
UCC27200DRG4	Active	Production	SOIC (D) 8	2500 LARGE T&R	Yes	NIPDAU	Level-1-260C-UNLIM	-40 to 140	27200
UCC27200DRG4.A	Active	Production	SOIC (D) 8	2500 LARGE T&R	Yes	NIPDAU	Level-1-260C-UNLIM	-40 to 140	27200
UCC27200DRG4.B	Active	Production	SOIC (D) 8	2500 LARGE T&R	Yes	NIPDAU	Level-1-260C-UNLIM	-40 to 140	27200
UCC27200DRMR	Active	Production	VSON (DRM) 8	3000 LARGE T&R	Yes	Call TI Nipdauag Nipdau	Level-2-260C-1 YEAR	-40 to 150	27200
UCC27200DRMR.A	Active	Production	VSON (DRM) 8	3000 LARGE T&R	Yes	Call TI	Level-2-260C-1 YEAR	-40 to 150	27200
UCC27200DRMR.B	Active	Production	VSON (DRM) 8	3000 LARGE T&R	Yes	Call TI	Level-2-260C-1 YEAR	-40 to 150	27200
UCC27200DRMT	Obsolete	Production	VSON (DRM) 8	-	-	Call TI	Call TI	-40 to 140	27200
UCC27201D	Obsolete	Production	SOIC (D) 8	-	-	Call TI	Call TI	-40 to 140	27201
UCC27201DDA	Obsolete	Production	SO PowerPAD (DDA) 8	-	-	Call TI	Call TI	-40 to 140	27201
UCC27201DDAR	Active	Production	SO PowerPAD (DDA) 8	2500 LARGE T&R	Yes	NIPDAU NIPDAUAG	Level-1-260C-UNLIM	-40 to 150	27201
UCC27201DDAR.A	Active	Production	SO PowerPAD (DDA) 8	2500 LARGE T&R	Yes	NIPDAU	Level-1-260C-UNLIM	-40 to 150	27201
UCC27201DDAR.B	Active	Production	SO PowerPAD (DDA) 8	2500 LARGE T&R	Yes	NIPDAU	Level-1-260C-UNLIM	-40 to 150	27201
UCC27201DR	Active	Production	SOIC (D) 8	2500 LARGE T&R	Yes	NIPDAU	Level-1-260C-UNLIM	-40 to 150	27201
UCC27201DR.A	Active	Production	SOIC (D) 8	2500 LARGE T&R	Yes	NIPDAU	Level-1-260C-UNLIM	-40 to 150	27201

Orderable part number	Status (1)	Material type (2)	Package Pins	Package qty Carrier	RoHS (3)	Lead finish/ Ball material (4)	MSL rating/ Peak reflow (5)	Op temp (°C)	Part marking (6)
UCC27201DR.B	Active	Production	SOIC (D) 8	2500 LARGE T&R	Yes	NIPDAU	Level-1-260C-UNLIM	-40 to 150	27201
UCC27201DRG4	Active	Production	SOIC (D) 8	2500 LARGE T&R	Yes	NIPDAU	Level-1-260C-UNLIM	-40 to 150	27201
UCC27201DRG4.A	Active	Production	SOIC (D) 8	2500 LARGE T&R	Yes	NIPDAU	Level-1-260C-UNLIM	-40 to 150	27201
UCC27201DRG4.B	Active	Production	SOIC (D) 8	2500 LARGE T&R	Yes	NIPDAU	Level-1-260C-UNLIM	-40 to 150	27201
UCC27201DRMR	Active	Production	VSON (DRM) 8	3000 LARGE T&R	Yes	Call TI Nipdauag Nipdau	Level-1-260C-UNLIM	-40 to 150	27201
UCC27201DRMR.A	Active	Production	VSON (DRM) 8	3000 LARGE T&R	Yes	Call TI	Level-1-260C-UNLIM	-40 to 150	27201
UCC27201DRMR.B	Active	Production	VSON (DRM) 8	3000 LARGE T&R	Yes	Call TI	Level-1-260C-UNLIM	-40 to 150	27201
UCC27201DRMRG4	Active	Production	VSON (DRM) 8	3000 LARGE T&R	Yes	NIPDAU	Level-1-260C-UNLIM	-40 to 150	27201
UCC27201DRMRG4.A	Active	Production	VSON (DRM) 8	3000 LARGE T&R	Yes	NIPDAU	Level-1-260C-UNLIM	-40 to 150	27201
UCC27201DRMRG4.B	Active	Production	VSON (DRM) 8	3000 LARGE T&R	Yes	NIPDAU	Level-1-260C-UNLIM	-40 to 150	27201
UCC27201DRMT	Obsolete	Production	VSON (DRM) 8	-	-	Call TI	Call TI	-40 to 140	27201

(1) **Status:** For more details on status, see our [product life cycle](#).

(2) **Material type:** When designated, preproduction parts are prototypes/experimental devices, and are not yet approved or released for full production. Testing and final process, including without limitation quality assurance, reliability performance testing, and/or process qualification, may not yet be complete, and this item is subject to further changes or possible discontinuation. If available for ordering, purchases will be subject to an additional waiver at checkout, and are intended for early internal evaluation purposes only. These items are sold without warranties of any kind.

(3) **RoHS values:** Yes, No, RoHS Exempt. See the [TI RoHS Statement](#) for additional information and value definition.

(4) **Lead finish/Ball material:** Parts may have multiple material finish options. Finish options are separated by a vertical ruled line. Lead finish/Ball material values may wrap to two lines if the finish value exceeds the maximum column width.

(5) **MSL rating/Peak reflow:** The moisture sensitivity level ratings and peak solder (reflow) temperatures. In the event that a part has multiple moisture sensitivity ratings, only the lowest level per JEDEC standards is shown. Refer to the shipping label for the actual reflow temperature that will be used to mount the part to the printed circuit board.

(6) **Part marking:** There may be an additional marking, which relates to the logo, the lot trace code information, or the environmental category of the part.

Multiple part markings will be inside parentheses. Only one part marking contained in parentheses and separated by a "~" will appear on a part. If a line is indented then it is a continuation of the previous line and the two combined represent the entire part marking for that device.

Important Information and Disclaimer: The information provided on this page represents TI's knowledge and belief as of the date that it is provided. TI bases its knowledge and belief on information provided by third parties, and makes no representation or warranty as to the accuracy of such information. Efforts are underway to better integrate information from third parties. TI has taken and continues to take reasonable steps to provide representative

and accurate information but may not have conducted destructive testing or chemical analysis on incoming materials and chemicals. TI and TI suppliers consider certain information to be proprietary, and thus CAS numbers and other limited information may not be available for release.

In no event shall TI's liability arising out of such information exceed the total purchase price of the TI part(s) at issue in this document sold by TI to Customer on an annual basis.

OTHER QUALIFIED VERSIONS OF UCC27200 :

- Automotive : [UCC27200-Q1](#)

NOTE: Qualified Version Definitions:

- Automotive - Q100 devices qualified for high-reliability automotive applications targeting zero defects

TAPE AND REEL INFORMATION

QUADRANT ASSIGNMENTS FOR PIN 1 ORIENTATION IN TAPE

*All dimensions are nominal

Device	Package Type	Package Drawing	Pins	SPQ	Reel Diameter (mm)	Reel Width W1 (mm)	A0 (mm)	B0 (mm)	K0 (mm)	P1 (mm)	W (mm)	Pin1 Quadrant
UCC27200DDAR	SO PowerPAD	DDA	8	2500	330.0	12.8	6.4	5.2	2.1	8.0	12.0	Q1
UCC27200DR	SOIC	D	8	2500	330.0	12.4	6.4	5.2	2.1	8.0	12.0	Q1
UCC27200DRG4	SOIC	D	8	2500	330.0	12.4	6.4	5.2	2.1	8.0	12.0	Q1
UCC27200DRMR	VSON	DRM	8	3000	330.0	12.4	4.25	4.25	1.15	8.0	12.0	Q2
UCC27201DDAR	SO PowerPAD	DDA	8	2500	330.0	12.8	6.4	5.2	2.1	8.0	12.0	Q1
UCC27201DR	SOIC	D	8	2500	330.0	12.4	6.4	5.2	2.1	8.0	12.0	Q1
UCC27201DRG4	SOIC	D	8	2500	330.0	12.4	6.4	5.2	2.1	8.0	12.0	Q1
UCC27201DRMR	VSON	DRM	8	3000	330.0	12.4	4.25	4.25	1.15	8.0	12.0	Q2
UCC27201DRMRG4	VSON	DRM	8	3000	330.0	12.4	4.25	4.25	1.15	8.0	12.0	Q2

TAPE AND REEL BOX DIMENSIONS



*All dimensions are nominal

Device	Package Type	Package Drawing	Pins	SPQ	Length (mm)	Width (mm)	Height (mm)
UCC27200DDAR	SO PowerPAD	DDA	8	2500	364.0	364.0	27.0
UCC27200DR	SOIC	D	8	2500	353.0	353.0	32.0
UCC27200DRG4	SOIC	D	8	2500	353.0	353.0	32.0
UCC27200DRMR	VSON	DRM	8	3000	367.0	367.0	35.0
UCC27201DDAR	SO PowerPAD	DDA	8	2500	364.0	364.0	27.0
UCC27201DR	SOIC	D	8	2500	353.0	353.0	32.0
UCC27201DRG4	SOIC	D	8	2500	353.0	353.0	32.0
UCC27201DRMR	VSON	DRM	8	3000	367.0	367.0	35.0
UCC27201DRMRG4	VSON	DRM	8	3000	367.0	367.0	35.0

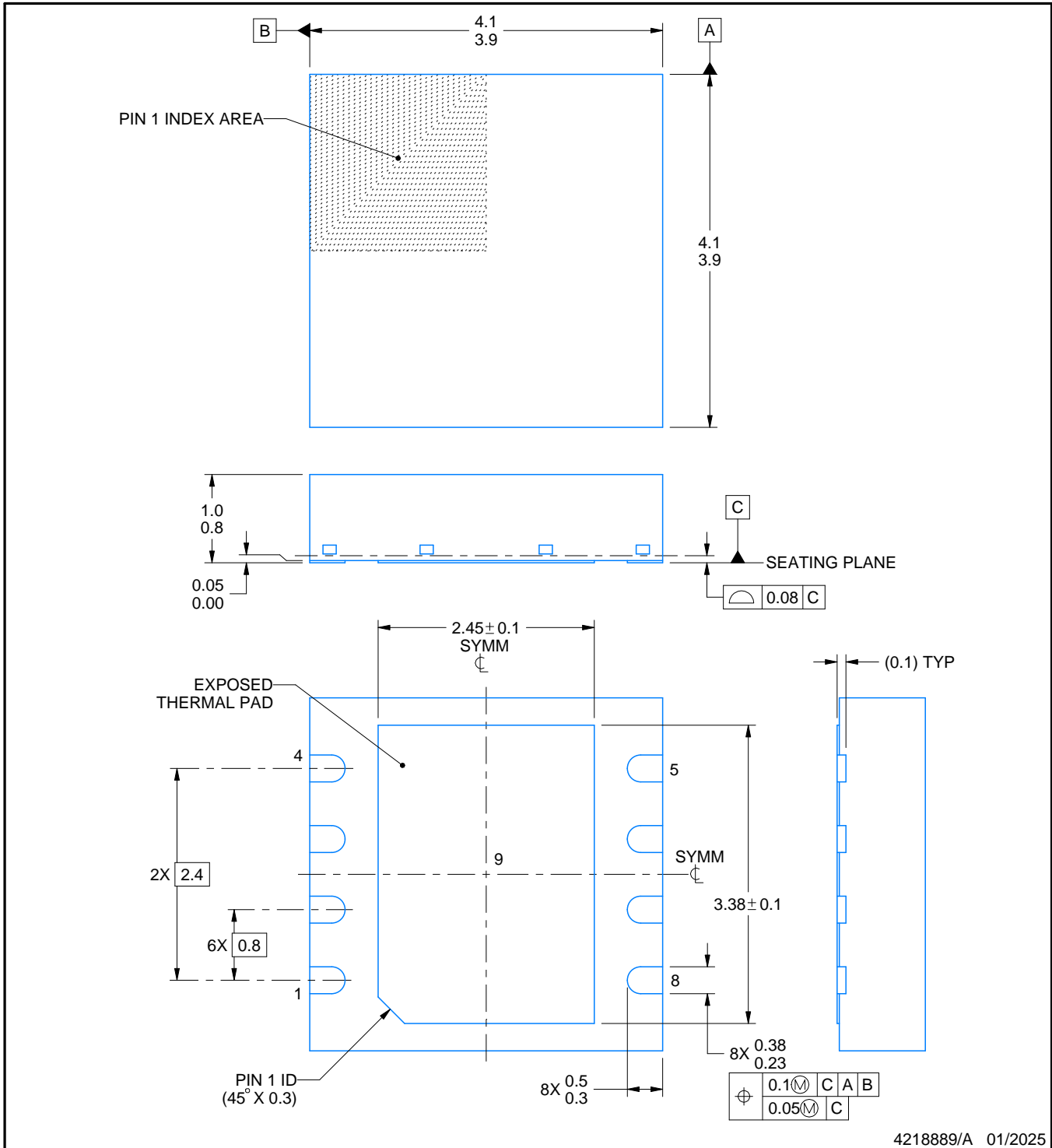
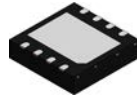

NOTES:

1. All linear dimensions are in millimeters. Any dimensions in parenthesis are for reference only. Dimensioning and tolerancing per ASME Y14.5M.
2. This drawing is subject to change without notice.
3. The package thermal pad must be soldered to the printed circuit board for thermal and mechanical performance.

EXAMPLE BOARD LAYOUT

DRM0008A

VSON - 1 mm max height

PLASTIC SMALL OUTLINE - NO LEAD

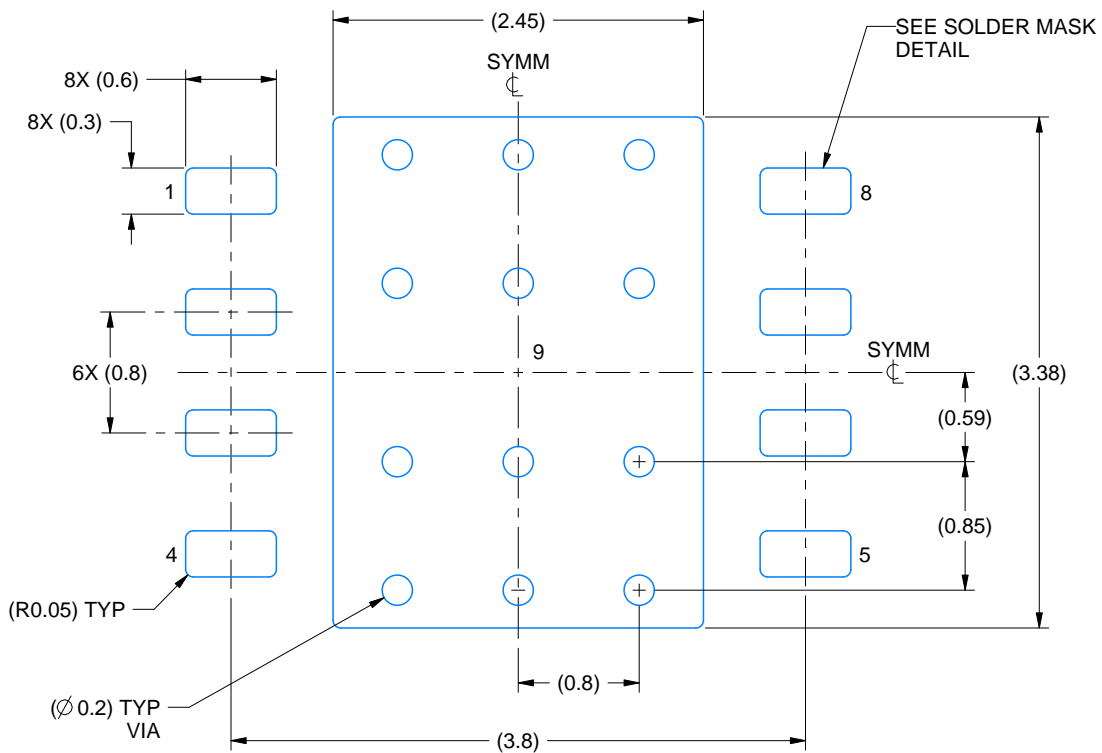

LAND PATTERN EXAMPLE
EXPOSED METAL SHOWN
SCALE: 20X

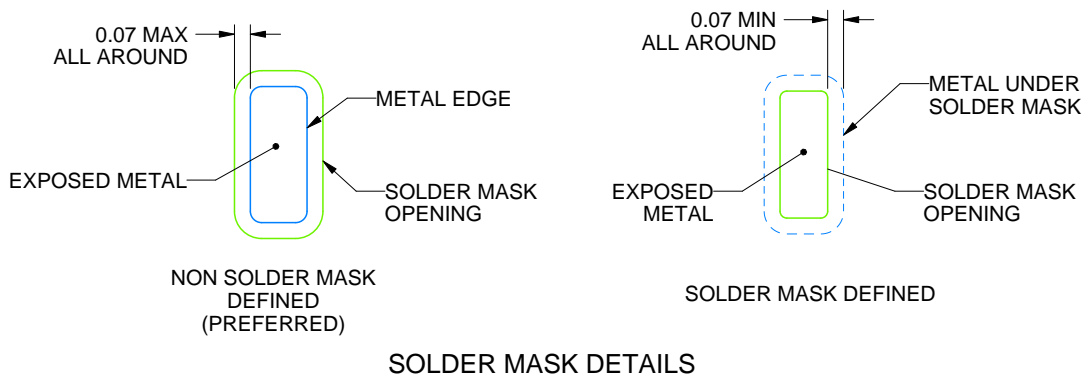

4218889/A 01/2025

NOTES: (continued)

4. This package is designed to be soldered to a thermal pad on the board. For more information, see Texas Instruments literature number SLUA271 (www.ti.com/lit/sluea271).
5. Vias are optional depending on application, refer to device data sheet. If any vias are implemented, refer to their locations shown on this view. It is recommended that vias under paste be filled, plugged or tented.

EXAMPLE STENCIL DESIGN

DRM0008A

VSON - 1 mm max height

PLASTIC SMALL OUTLINE - NO LEAD

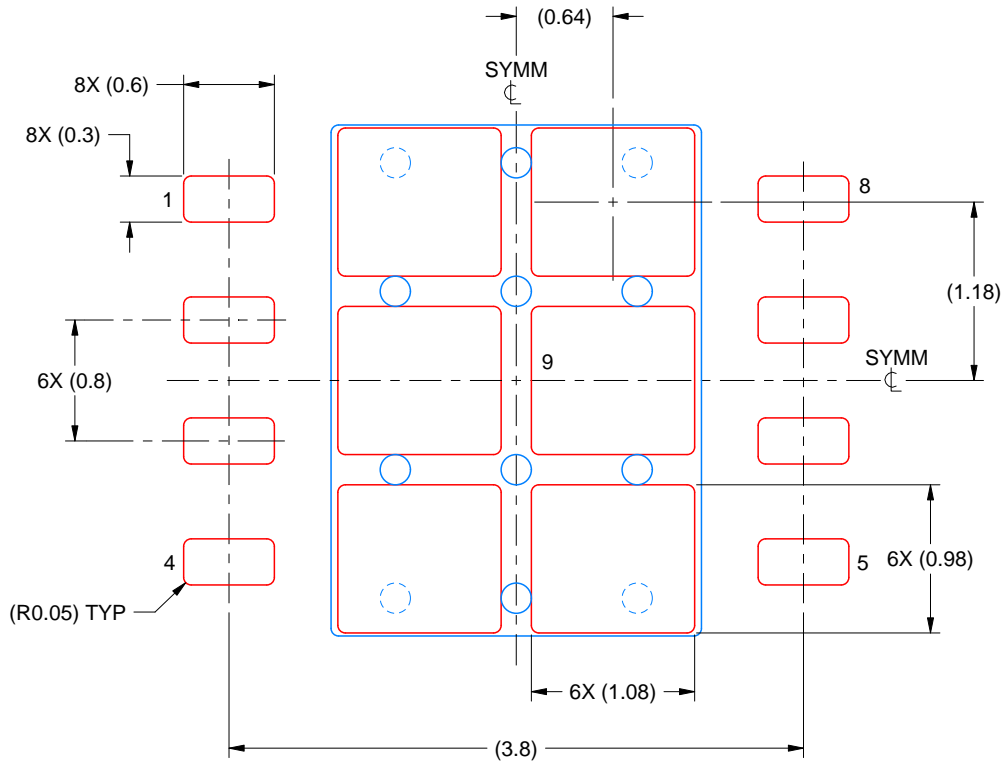

SOLDER PASTE EXAMPLE
BASED ON 0.125 MM THICK STENCIL
SCALE: 20X

EXPOSED PAD 9
77% PRINTED SOLDER COVERAGE BY AREA UNDER PACKAGE

4218889/A 01/2025

NOTES: (continued)

6. Laser cutting apertures with trapezoidal walls and rounded corners may offer better paste release. IPC-7525 may have alternate design recommendations.



D0008A

PACKAGE OUTLINE

SOIC - 1.75 mm max height

SMALL OUTLINE INTEGRATED CIRCUIT



4214825/C 02/2019

NOTES:

- Linear dimensions are in inches [millimeters]. Dimensions in parenthesis are for reference only. Controlling dimensions are in inches. Dimensioning and tolerancing per ASME Y14.5M.
- This drawing is subject to change without notice.
- This dimension does not include mold flash, protrusions, or gate burrs. Mold flash, protrusions, or gate burrs shall not exceed .006 [0.15] per side.
- This dimension does not include interlead flash.
- Reference JEDEC registration MS-012, variation AA.

EXAMPLE BOARD LAYOUT

D0008A

SOIC - 1.75 mm max height

SMALL OUTLINE INTEGRATED CIRCUIT



LAND PATTERN EXAMPLE
EXPOSED METAL SHOWN
SCALE:8X



SOLDER MASK DETAILS

4214825/C 02/2019

NOTES: (continued)

6. Publication IPC-7351 may have alternate designs.

7. Solder mask tolerances between and around signal pads can vary based on board fabrication site.

EXAMPLE STENCIL DESIGN

D0008A

SOIC - 1.75 mm max height

SMALL OUTLINE INTEGRATED CIRCUIT



SOLDER PASTE EXAMPLE
BASED ON .005 INCH [0.125 MM] THICK STENCIL
SCALE:8X

4214825/C 02/2019

NOTES: (continued)

8. Laser cutting apertures with trapezoidal walls and rounded corners may offer better paste release. IPC-7525 may have alternate design recommendations.
9. Board assembly site may have different recommendations for stencil design.



Images above are just a representation of the package family, actual package may vary.
Refer to the product data sheet for package details.

DDA (R-PDSO-G8)

PowerPAD™ PLASTIC SMALL-OUTLINE



4202561/F 12/11

- NOTES:
- All linear dimensions are in millimeters. Dimensioning and tolerancing per ASME Y14.5-1994.
 - This drawing is subject to change without notice.
 - Body dimensions do not include mold flash or protrusion not to exceed 0,15.
 - This package is designed to be soldered to a thermal pad on the board. Refer to Technical Brief, PowerPad Thermally Enhanced Package, Texas Instruments Literature No. SLMA002 for information regarding recommended board layout. This document is available at www.ti.com <<http://www.ti.com>>.
 - See the additional figure in the Product Data Sheet for details regarding the exposed thermal pad features and dimensions.
 - This package complies to JEDEC MS-012 variation BA

PowerPAD is a trademark of Texas Instruments.

DDA (R-PDSO-G8)

PowerPAD™ PLASTIC SMALL OUTLINE

THERMAL INFORMATION

This PowerPAD™ package incorporates an exposed thermal pad that is designed to be attached to a printed circuit board (PCB). The thermal pad must be soldered directly to the PCB. After soldering, the PCB can be used as a heatsink. In addition, through the use of thermal vias, the thermal pad can be attached directly to the appropriate copper plane shown in the electrical schematic for the device, or alternatively, can be attached to a special heatsink structure designed into the PCB. This design optimizes the heat transfer from the integrated circuit (IC).

For additional information on the PowerPAD package and how to take advantage of its heat dissipating abilities, refer to Technical Brief, PowerPAD Thermally Enhanced Package, Texas Instruments Literature No. SLMA002 and Application Brief, PowerPAD Made Easy, Texas Instruments Literature No. SLMA004. Both documents are available at www.ti.com.

The exposed thermal pad dimensions for this package are shown in the following illustration.

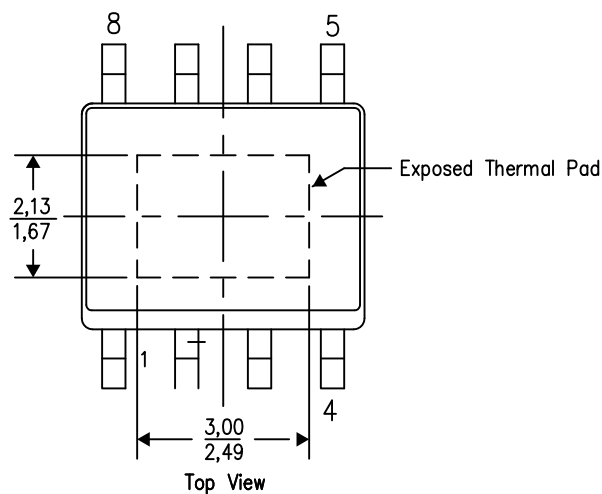

Exposed Thermal Pad Dimensions

4206322-5/L 05/12

NOTE: A. All linear dimensions are in millimeters

PowerPAD is a trademark of Texas Instruments

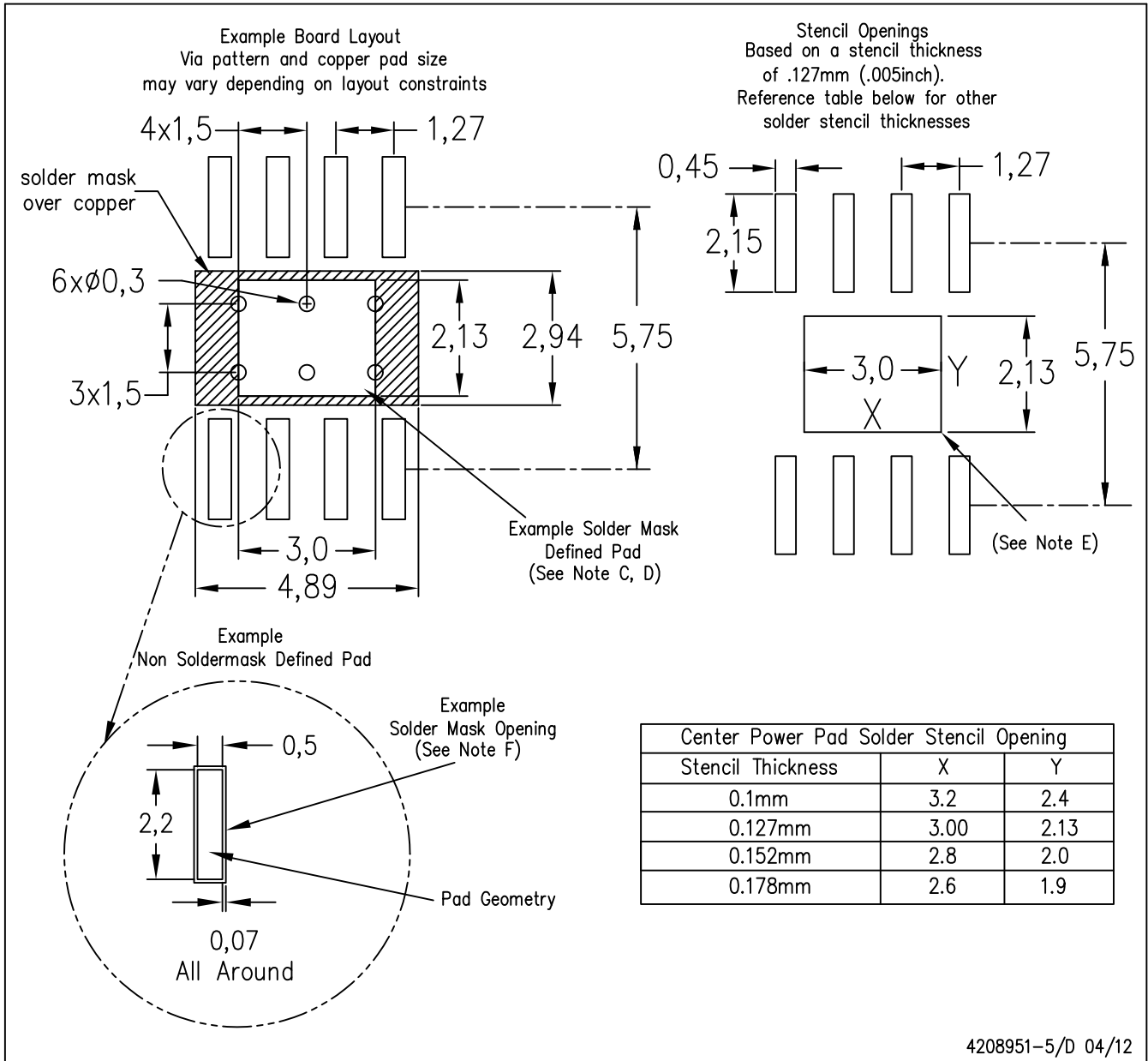

- NOTES:
- A. All linear dimensions are in millimeters.
 - B. This drawing is subject to change without notice.
 - C. Customers should place a note on the circuit board fabrication drawing not to alter the center solder mask defined pad.
 - D. This package is designed to be soldered to a thermal pad on the board. Refer to Technical Brief, PowerPad Thermally Enhanced Package, Texas Instruments Literature No. SLMA002, SLMA004, and also the Product Data Sheets for specific thermal information, via requirements, and recommended board layout. These documents are available at www.ti.com <<http://www.ti.com>>. Publication IPC-7351 is recommended for alternate designs.
 - E. Laser cutting apertures with trapezoidal walls and also rounding corners will offer better paste release. Customers should contact their board assembly site for stencil design recommendations. Example stencil design based on a 50% volumetric metal load solder paste. Refer to IPC-7525 for other stencil recommendations.
 - F. Customers should contact their board fabrication site for solder mask tolerances between and around signal pads.

PowerPAD is a trademark of Texas Instruments.

DDA (R-PDSO-G8)

PowerPAD™ PLASTIC SMALL-OUTLINE

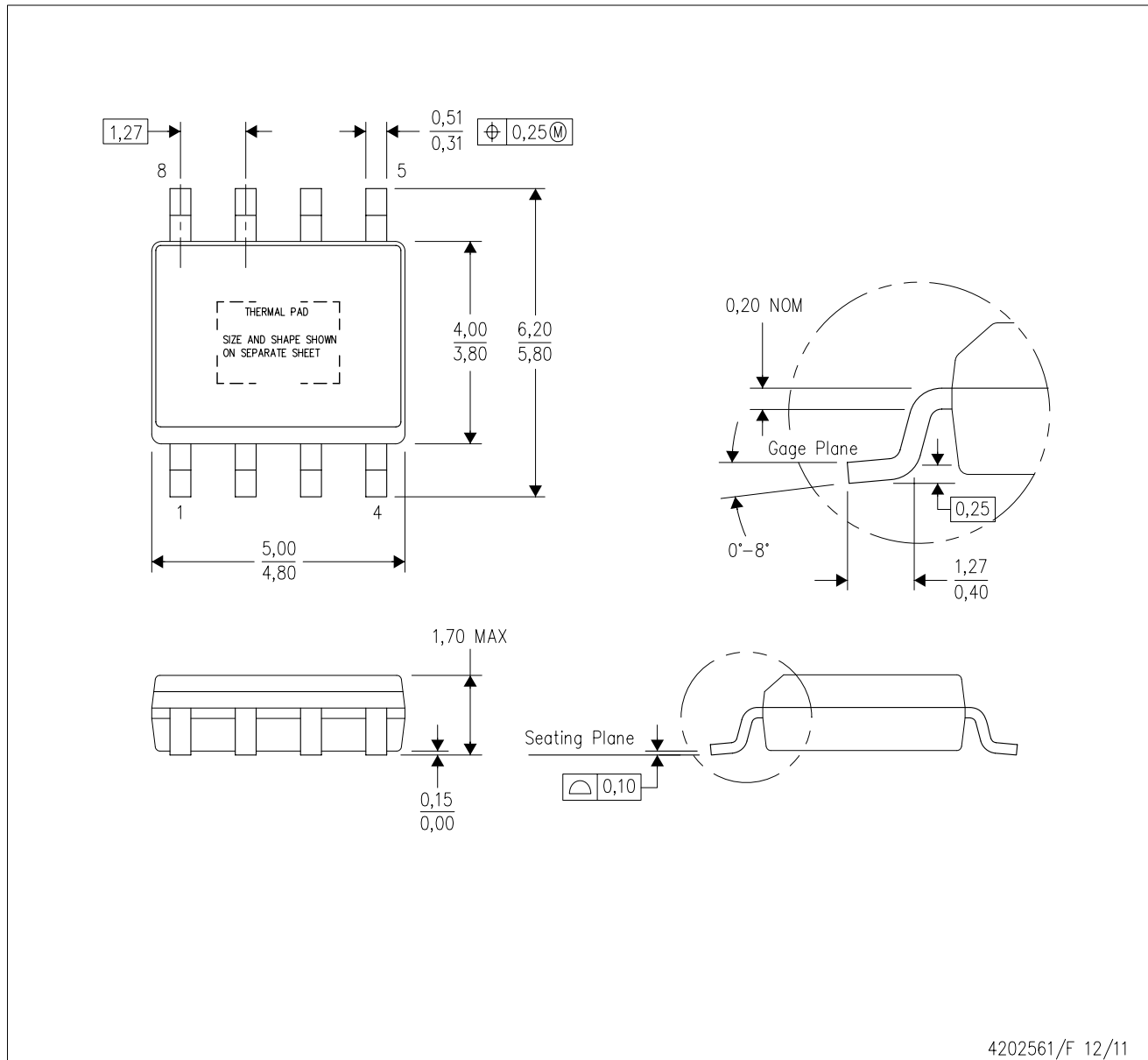

4202561/F 12/11

- NOTES:
- All linear dimensions are in millimeters. Dimensioning and tolerancing per ASME Y14.5-1994.
 - This drawing is subject to change without notice.
 - Body dimensions do not include mold flash or protrusion not to exceed 0,15.
 - This package is designed to be soldered to a thermal pad on the board. Refer to Technical Brief, PowerPad Thermally Enhanced Package, Texas Instruments Literature No. SLMA002 for information regarding recommended board layout. This document is available at www.ti.com <<http://www.ti.com>>.
 - See the additional figure in the Product Data Sheet for details regarding the exposed thermal pad features and dimensions.
 - This package complies to JEDEC MS-012 variation BA

PowerPAD is a trademark of Texas Instruments.

DDA (R-PDSO-G8)

PowerPAD™ PLASTIC SMALL OUTLINE

THERMAL INFORMATION

This PowerPAD™ package incorporates an exposed thermal pad that is designed to be attached to a printed circuit board (PCB). The thermal pad must be soldered directly to the PCB. After soldering, the PCB can be used as a heatsink. In addition, through the use of thermal vias, the thermal pad can be attached directly to the appropriate copper plane shown in the electrical schematic for the device, or alternatively, can be attached to a special heatsink structure designed into the PCB. This design optimizes the heat transfer from the integrated circuit (IC).

For additional information on the PowerPAD package and how to take advantage of its heat dissipating abilities, refer to Technical Brief, PowerPAD Thermally Enhanced Package, Texas Instruments Literature No. SLMA002 and Application Brief, PowerPAD Made Easy, Texas Instruments Literature No. SLMA004. Both documents are available at www.ti.com.

The exposed thermal pad dimensions for this package are shown in the following illustration.

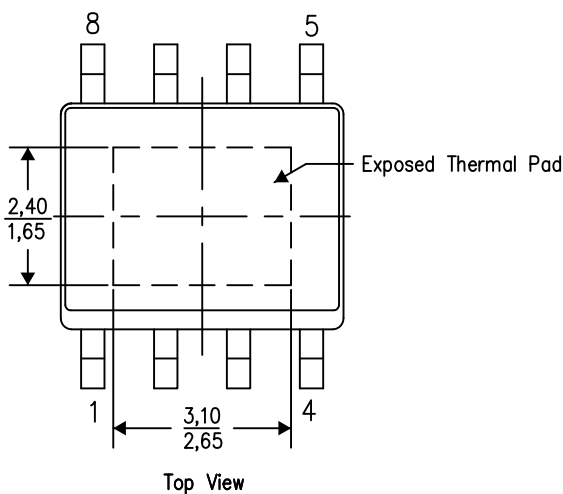

Exposed Thermal Pad Dimensions

4206322-6/L 05/12

NOTE: A. All linear dimensions are in millimeters

PowerPAD is a trademark of Texas Instruments

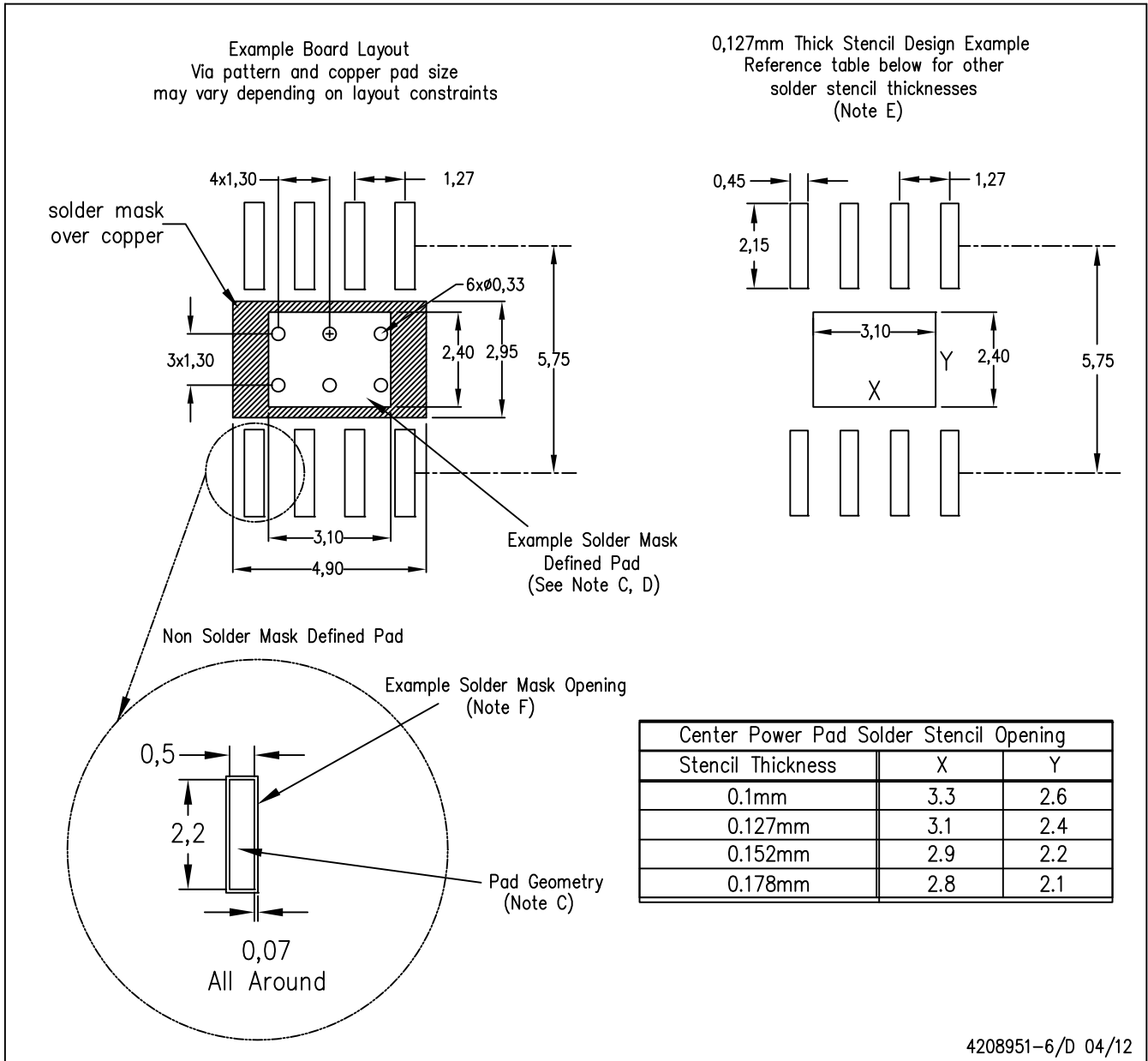

- NOTES:
- A. All linear dimensions are in millimeters.
 - B. This drawing is subject to change without notice.
 - C. Publication IPC-7351 is recommended for alternate designs.
 - D. This package is designed to be soldered to a thermal pad on the board. Refer to Technical Brief, PowerPad Thermally Enhanced Package, Texas Instruments Literature No. SLMA002, SLMA004, and also the Product Data Sheets for specific thermal information, via requirements, and recommended board layout. These documents are available at www.ti.com <<http://www.ti.com>>. Publication IPC-7351 is recommended for alternate designs.
 - E. Laser cutting apertures with trapezoidal walls and also rounding corners will offer better paste release. Customers should contact their board assembly site for stencil design recommendations. Example stencil design based on a 50% volumetric metal load solder paste. Refer to IPC-7525 for other stencil recommendations.
 - F. Customers should contact their board fabrication site for solder mask tolerances between and around signal pads.

PowerPAD is a trademark of Texas Instruments.

DDA0008B

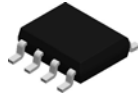

PACKAGE OUTLINE

PowerPAD™ SOIC - 1.7 mm max height

PLASTIC SMALL OUTLINE

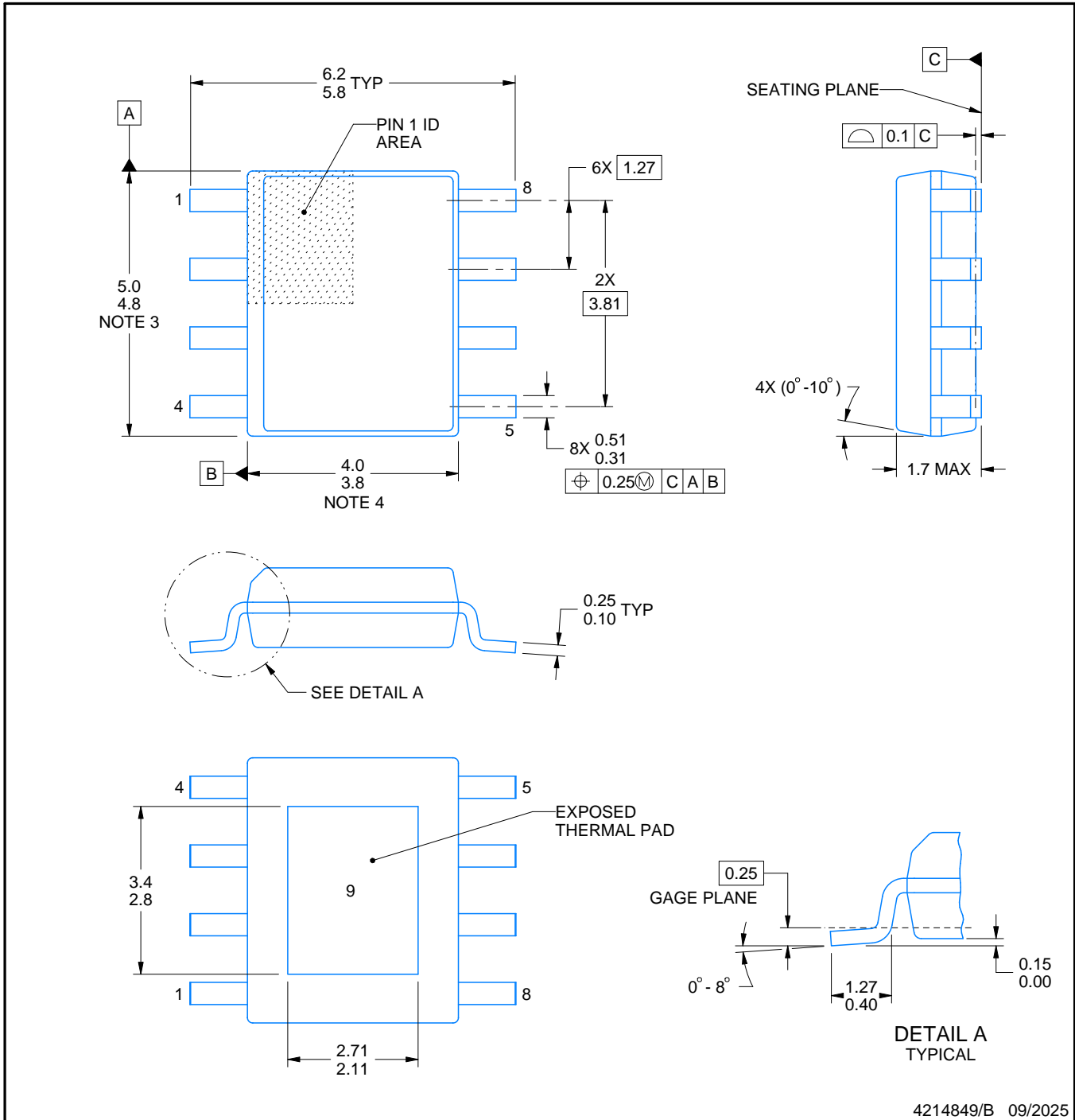

4214849/B 09/2025

NOTES:

PowerPAD is a trademark of Texas Instruments.

1. All linear dimensions are in millimeters. Any dimensions in parenthesis are for reference only. Dimensioning and tolerancing per ASME Y14.5M.
2. This drawing is subject to change without notice.
3. This dimension does not include mold flash, protrusions, or gate burrs. Mold flash, protrusions, or gate burrs shall not exceed 0.15 mm per side.
4. This dimension does not include interlead flash. Interlead flash shall not exceed 0.25 mm per side.
5. Reference JEDEC registration MS-012.

EXAMPLE BOARD LAYOUT

DDA0008B

PowerPAD™ SOIC - 1.7 mm max height

PLASTIC SMALL OUTLINE

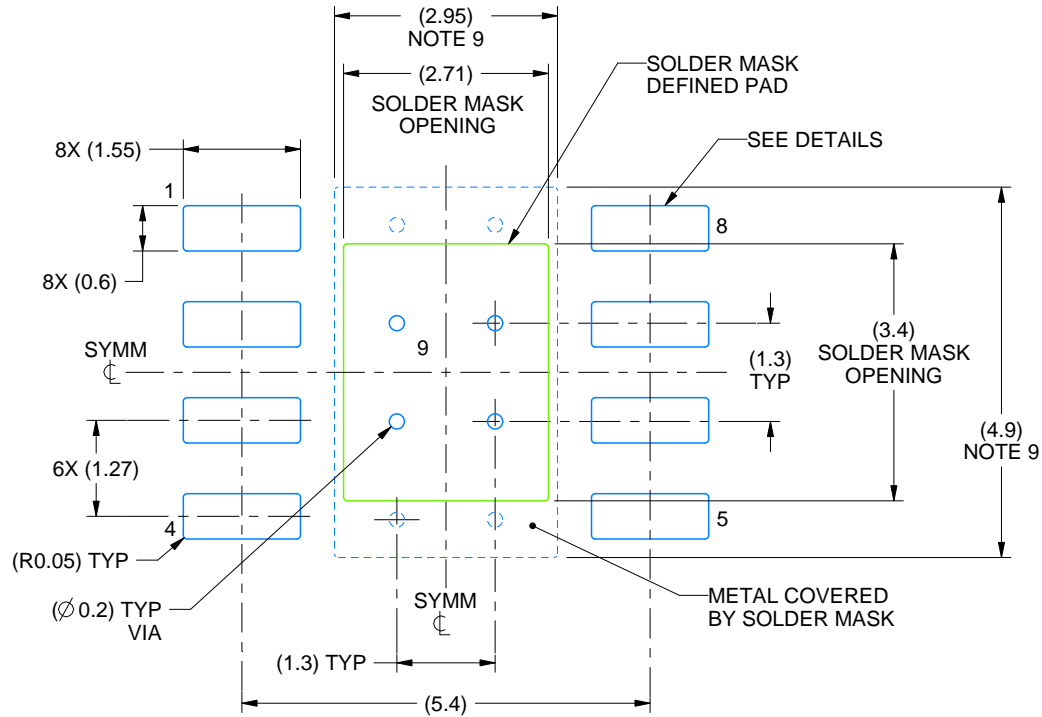

LAND PATTERN EXAMPLE
SCALE:10X

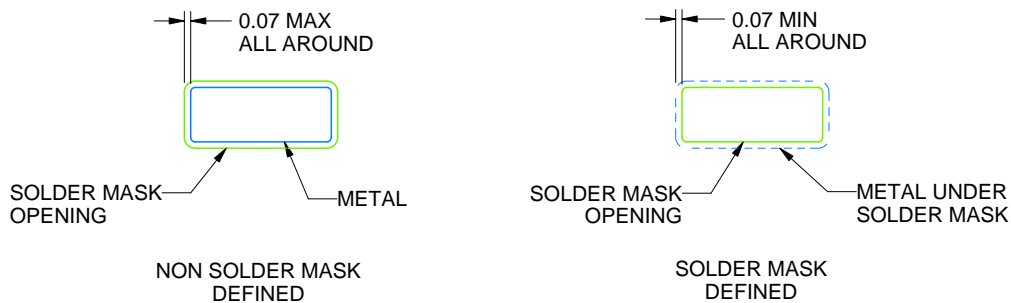

SOLDER MASK DETAILS
PADS 1-8

4214849/B 09/2025

NOTES: (continued)

6. Publication IPC-7351 may have alternate designs.
7. Solder mask tolerances between and around signal pads can vary based on board fabrication site.
8. This package is designed to be soldered to a thermal pad on the board. For more information, see Texas Instruments literature numbers SLMA002 (www.ti.com/lit/slma002) and SLMA004 (www.ti.com/lit/slma004).
9. Size of metal pad may vary due to creepage requirement.
10. Vias are optional depending on application, refer to device data sheet. If any vias are implemented, refer to their locations shown on this view. It is recommended that vias under paste be filled, plugged or tented.

EXAMPLE STENCIL DESIGN

DDA0008B

PowerPAD™ SOIC - 1.7 mm max height

PLASTIC SMALL OUTLINE

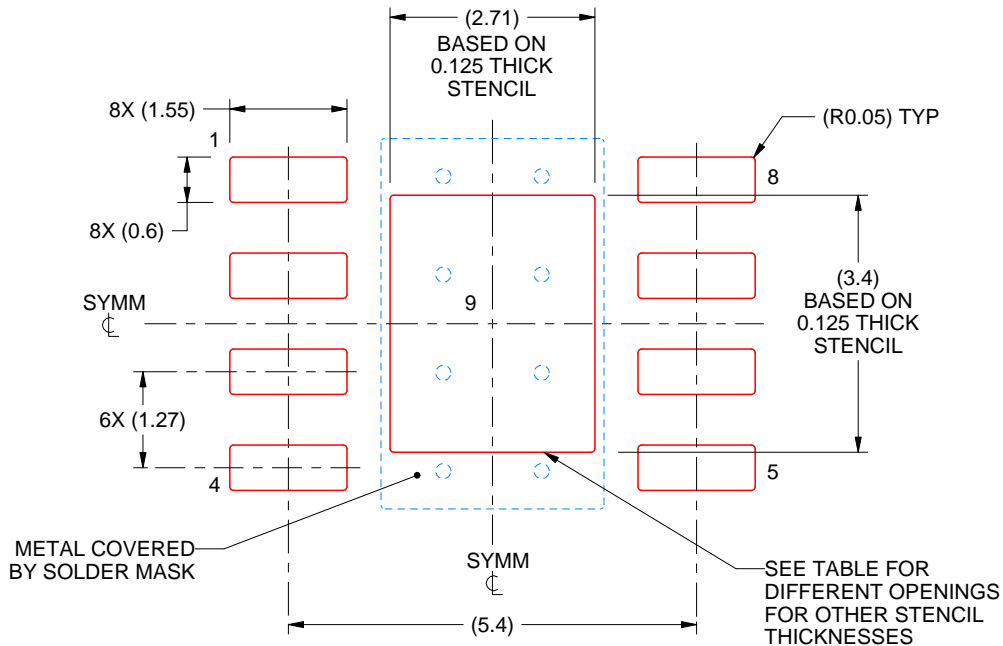

SOLDER PASTE EXAMPLE
EXPOSED PAD
100% PRINTED SOLDER COVERAGE BY AREA
SCALE:10X

STENCIL THICKNESS	SOLDER STENCIL OPENING
0.1	3.03 X 3.80
0.125	2.71 X 3.40 (SHOWN)
0.150	2.47 X 3.10
0.175	2.29 X 2.87

4214849/B 09/2025

NOTES: (continued)

11. Laser cutting apertures with trapezoidal walls and rounded corners may offer better paste release. IPC-7525 may have alternate design recommendations.
12. Board assembly site may have different recommendations for stencil design.

重要なお知らせと免責事項

TI は、技術データと信頼性データ(データシートを含みます)、設計リソース(リファレンス デザインを含みます)、アプリケーションや設計に関する各種アドバイス、Web ツール、安全性情報、その他のリソースを、欠陥が存在する可能性のある「現状のまま」提供しており、商品性および特定目的に対する適合性の黙示保証、第三者の知的財産権の非侵害保証を含むいかなる保証も、明示的または黙示的にかかわらず拒否します。

これらのリソースは、TI 製品を使用する設計の経験を積んだ開発者への提供を意図したものです。(1) お客様のアプリケーションに適した TI 製品の選定、(2) お客様のアプリケーションの設計、検証、試験、(3) お客様のアプリケーションに該当する各種規格や、その他のあらゆる安全性、セキュリティ、規制、または他の要件への確実な適合に関する責任を、お客様のみが単独で負うものとし、

上記の各種リソースは、予告なく変更される可能性があります。これらのリソースは、リソースで説明されている TI 製品を使用するアプリケーションの開発の目的でのみ、TI はその使用をお客様に許諾します。これらのリソースに関して、他の目的で複製することや掲載することは禁止されています。TI や第三者の知的財産権のライセンスが付与されている訳ではありません。お客様は、これらのリソースを自身で使用した結果発生するあらゆる申し立て、損害、費用、損失、責任について、TI およびその代理人を完全に補償するものとし、TI は一切の責任を拒否します。

TI の製品は、[TI の販売条件](#)、[TI の総合的な品質ガイドライン](#)、[ti.com](#) または TI 製品などに関連して提供される他の適用条件に従い提供されます。TI がこれらのリソースを提供することは、適用される TI の保証または他の保証の放棄の拡大や変更を意味するものではありません。TI がカスタム、またはカスタマー仕様として明示的に指定していない限り、TI の製品は標準的なカタログに掲載される汎用機器です。

お客様がいかなる追加条項または代替条項を提案する場合も、TI はそれらに異議を唱え、拒否します。

Copyright © 2026, Texas Instruments Incorporated

最終更新日 : 2025 年 10 月