

Low Frequency Quartz Crystals from Micro Crystal are the simple solution to sourcing crystals compatible with TI's MSP430 Ultra Low Power Microcontrollers!



Take full advantage of the capabilities of TI's MSP430. Add a 32.768 kHz crystal to your MSP430 controller and you'll generate an accurate reference frequency for the microcontroller's sleep mode, as well as your other circuitry that may require a timing reference.

We can help you match the right crystal and you'll have a reliable and accurate timing source.

Micro Crystal has worked with TI to help you choose an ideal crystal for your circuit application. Tell us about your application and we will provide recommendations for a crystal that is known to function well in your application.

The Micro Crystal line includes timing crystals in a variety of sizes and package designs to meet a wide range of size and cost constraints. We can offer application engineering assistance to help you optimize the efficiency of your sleep mode circuitry, as well as selection advice. Fast delivery is available on 32.768 kHz crystals in virtually any quantity required.



### MS3V-T1R

Tuning Fork Crystal 30 kHz – 200 kHz

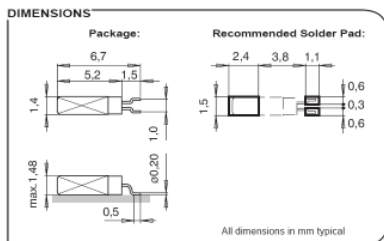
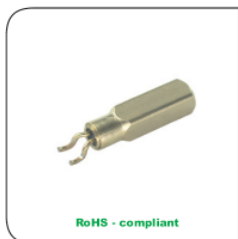

Contact: [sales@microcrystal.com](mailto:sales@microcrystal.com)

Micro Crystal is one of the world's leading producers of subminiature timing crystals. Founded in 1978 by the Swiss watch industry, Micro Crystal is still a company of The Swatch Group.

Complete Datasheets in PDF format are available at: [www.microcrystal.com](http://www.microcrystal.com)

In accordance with our policy of continuous development and improvement, Micro Crystal reserves the right to modify specifications or design-recommendations without prior notice. The recommendations stated above are based on measured-results, respecting the "oscillator design rules". Micro Crystal makes no representation or warranty for information in this "Crystal Recommendations".

# Crystal Recommendations

TI MSP430 x1xx & x3xx Families

## MSP430x1xx & x3xx Families

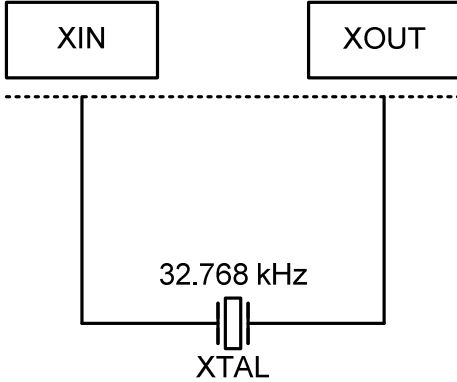

## MSP430x1xx & x3xx Families

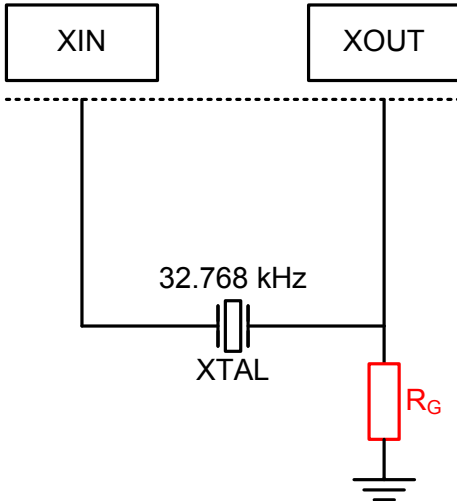

### Oscillator Design Check

Test Conditions		
Power Supply Voltage $V_{DD}$	$\geq 3.0$	V
Load Capacitors	Integrated	pF
Results		
Effective Load Capacitance	10.2	pF
Oscillation Allowance	300	k $\Omega$
Oscillator Output Voltage AC	400	mV <sub>RMS</sub>
Drive Level	0.220	$\mu$ W
Startup Time	1000	ms
Overtone Mode Suppression	Safe	----

### Oscillator Design Check

Test Conditions		
Power Supply Voltage $V_{DD}$	<b>&lt;3.0</b>	V
Load Capacitors	Integrated	pF
<b>R<sub>G</sub></b>	<b>5.1</b>	<b>M<math>\Omega</math></b>
Results		
Effective Load Capacitance	10.2	pF
Oscillation Allowance	300	k $\Omega$
Oscillator Output Voltage AC	350	mV <sub>RMS</sub>
Drive Level	0.220	$\mu$ W
Startup Time	1000	ms
Overtone Mode Suppression	Safe	----

### Recommendation

Crystal		
Crystal Type	MS3V-T1R / CC7V-T1A	
Frequency	32.768	kHz
Load Capacitance $C_L$	9.0 or 12.5	pF
Tolerance	+/-20	ppm

### Remarks

If  $V_{DD} < 3.0$  V, the 5.1 M $\Omega$  (R<sub>G</sub>) option allows the use of SMD quartz crystals with an ESR up to 60 k $\Omega$  typ.

Please find detailed information about MS3V-T1R, CC7V-T1A and all others crystal types at [www.microcrystal.com](http://www.microcrystal.com).

In accordance with our policy of continuous development and improvement, Micro Crystal reserves the right to modify specifications or design-recommendations without prior notice. The recommendations stated above are based on measured-results, respecting the "oscillator design rules". Micro Crystal makes no representation or warranty for information in this "Crystal Recommendations".

## MSP430x4xx Family

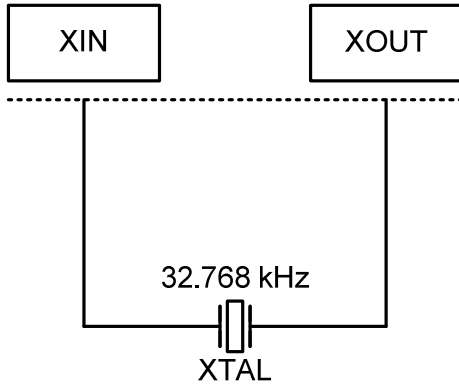

## Oscillator Design Check

Test Conditions		
Power Supply Voltage $V_{DD}$	$\geq 1.8$	V
Load Capacitors	Integrated	pF
Oscillator Setting $C_X$	18	pF
Results		
Effective Load Capacitance	9.0	pF
Oscillation Allowance	500	$k\Omega$
Oscillator Output Voltage AC	130	$mV_{RMS}$
Drive Level	0.070	$\mu W$
Startup Time	400	ms
Overtone Mode Suppression	Safe	----

## Recommendation

Crystal		
Crystal Type	MS3V-T1R / CC7V-T1A	
Frequency	32.768	kHz
Load Capacitance $C_L$	7.0 or 9.0	pF
Tolerance	$\pm 20$	ppm
Oscillator Settings		
Oscillator Setting	$C_X$	0 10 <b>14</b> <b>18</b> pF
OSCCAPx		0 1 <b>2</b> <b>3</b> ----
Load Capacitance	$C_L$	4.0 5.8 <b>7.0</b> <b>9.0</b> pF

## Remarks

**Recommended setting:**  $C_X = 18$  pF (OSCCAPx = 3) Corresponding crystal's  $C_L$ : 9.0 pF.

**Alternative setting:**  $C_X = 14$  pF (OSCCAPx = 2) Corresponding crystal's  $C_L$ : 7.0 pF.

The  $C_X$ : 0 pF and 10 pF settings are not recommended to use with quartz crystals.

$C_X$  corresponds to parameter  $C_{XIN}$  and  $C_{XOUT}$  (Integrated Load Capacitance),  $C_{XIN} = C_{XOUT}$ .

Please find detailed information about MS3V-T1R, CC7V-T1A and all others crystal types at [www.microcrystal.com](http://www.microcrystal.com).

### MSP430x2xx Family

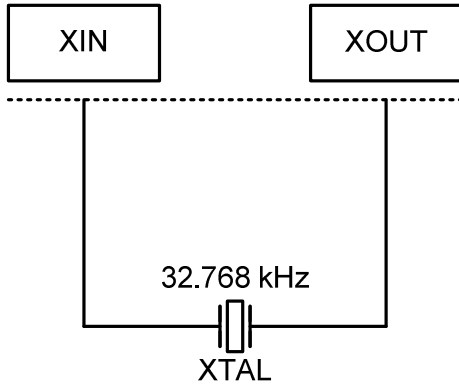

### Oscillator Design Check

Test Conditions		
Power Supply Voltage $V_{DD}$	$\geq 1.8$	V
Load Capacitors	Integrated	pF
Oscillator Setting $C_x$	8.5	pF
Results		
Effective Load Capacitance	12.2	pF
Oscillation Allowance	500	$k\Omega$
Oscillator Output Voltage AC	90	$mV_{RMS}$
Drive Level	0.030	$\mu W$
Startup Time	450	ms
Overtone Mode Suppression	Safe	----

### Recommendation

Crystal	
Crystal Type	MS3V-T1R / CC7V-T1A
Frequency	32.768 kHz
Load Capacitance $C_L$	9.0 or 12.5 pF
Tolerance	+/-20 ppm
Oscillator Settings	
Oscillator Setting	$C_x$ 1 <b>5.5</b> <b>8.5</b> 11 pF
XCAPx	0 <b>1</b> <b>2</b> 3 ----
Load Capacitance	$C_L$ 5.0 <b>9.0</b> <b>12.5</b> 14.5 pF

### Remarks

**Recommended setting:**  $C_x = 8.5$  pF (XCAPx = 2) **Corresponding crystal's  $C_L$ : 12.5 pF.**

**Alternative setting:**  $C_x = 5.5$  pF (XCAPx = 1) **Corresponding crystal's  $C_L$ : 9.0 pF.**

The  $C_x$ : 1 pF and 11 pF settings are not recommended to use with quartz crystals.

$C_x$  corresponds to parameter  $C_{L,eff}$  (Integrated Effective Load Capacitance, LF mode).

Please find detailed information about MS3V-T1R, CC7V-T1A and all others crystal types at [www.microcrystal.com](http://www.microcrystal.com).

In accordance with our policy of continuous development and improvement, Micro Crystal reserves the right to modify specifications or design-recommendations without prior notice. The recommendations stated above are based on measured-results, respecting the "oscillator design rules". Micro Crystal makes no representation or warranty for information in this "Crystal Recommendations".

## MSP430x5xx Family

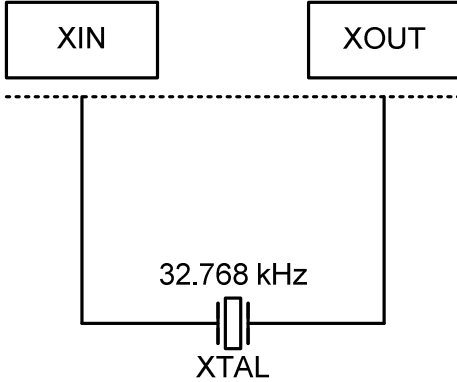

## Oscillator Design Check

Test Conditions		
Power Supply Voltage $V_{DD}$	$\geq 1.8$	V
Load Capacitors	Integrated	pF
Oscillator Setting XTS	3	----
Oscillator Setting XCAPx	3	----
Results		
Effective Load Capacitance	12.5	pF
Oscillation Allowance	$>500$	$k\Omega$
Oscillator Output Voltage AC	90	$mV_{RMS}$
Drive Level	0.010	$\mu W$
Startup Time	200	ms
Overtone Mode Suppression	Safe	----

## Recommendation

Crystal		
Crystal Type	MS3V-T1R / CC7V-T1A	
Frequency	32.768	kHz
Load Capacitance $C_L$	7.0 or 12.5	pF
Tolerance	$\pm 20$	ppm

## Oscillator Settings

	XCAPx	XTS				Effective Load Capacitance $C_{Load} / pF$	Crystal Load Capacitance $C_L / pF$
		0	1	2	3		
	0				4.3	To be used with external load capacitors	
	1	✓			7.5	7.0 pF	
	2				10.3	Does not correspond to a standard $C_L$ value	
	3			✓	12.5	12.5 pF	

## Remarks

**Recommended setting:** XTS = 3 / XCAPx = 3 Corresponding crystal's  $C_L$ : 12.5 pF.

**Lowest power consumption setting:** XTS = 0 / XCAPx = 1 Corresponding crystal's  $C_L$ : 7.0 pF.

XTS: oscillator's drive setting, 0 = min to 3 = max.

XCAPx: integrated load capacitors  $C_{XIN}$  and  $C_{XOUT}$  (represented by  $C_{L,eff}$ ) setting, 0 = 2 pF, 1 = 5.5 pF, 2 = 8.5 pF and 3 = 12.0 pF.

Please find detailed information about MS3V-T1R, CC7V-T1A and all others crystal types at [www.microcrystal.com](http://www.microcrystal.com).

## IMPORTANT NOTICE

Texas Instruments Incorporated and its subsidiaries (TI) reserve the right to make corrections, modifications, enhancements, improvements, and other changes to its products and services at any time and to discontinue any product or service without notice. Customers should obtain the latest relevant information before placing orders and should verify that such information is current and complete. All products are sold subject to TI's terms and conditions of sale supplied at the time of order acknowledgment.

TI warrants performance of its hardware products to the specifications applicable at the time of sale in accordance with TI's standard warranty. Testing and other quality control techniques are used to the extent TI deems necessary to support this warranty. Except where mandated by government requirements, testing of all parameters of each product is not necessarily performed.

TI assumes no liability for applications assistance or customer product design. Customers are responsible for their products and applications using TI components. To minimize the risks associated with customer products and applications, customers should provide adequate design and operating safeguards.

TI does not warrant or represent that any license, either express or implied, is granted under any TI patent right, copyright, mask work right, or other TI intellectual property right relating to any combination, machine, or process in which TI products or services are used. Information published by TI regarding third-party products or services does not constitute a license from TI to use such products or services or a warranty or endorsement thereof. Use of such information may require a license from a third party under the patents or other intellectual property of the third party, or a license from TI under the patents or other intellectual property of TI.

Reproduction of TI information in TI data books or data sheets is permissible only if reproduction is without alteration and is accompanied by all associated warranties, conditions, limitations, and notices. Reproduction of this information with alteration is an unfair and deceptive business practice. TI is not responsible or liable for such altered documentation. Information of third parties may be subject to additional restrictions.

Resale of TI products or services with statements different from or beyond the parameters stated by TI for that product or service voids all express and any implied warranties for the associated TI product or service and is an unfair and deceptive business practice. TI is not responsible or liable for any such statements.

TI products are not authorized for use in safety-critical applications (such as life support) where a failure of the TI product would reasonably be expected to cause severe personal injury or death, unless officers of the parties have executed an agreement specifically governing such use. Buyers represent that they have all necessary expertise in the safety and regulatory ramifications of their applications, and acknowledge and agree that they are solely responsible for all legal, regulatory and safety-related requirements concerning their products and any use of TI products in such safety-critical applications, notwithstanding any applications-related information or support that may be provided by TI. Further, Buyers must fully indemnify TI and its representatives against any damages arising out of the use of TI products in such safety-critical applications.

TI products are neither designed nor intended for use in military/aerospace applications or environments unless the TI products are specifically designated by TI as military-grade or "enhanced plastic." Only products designated by TI as military-grade meet military specifications. Buyers acknowledge and agree that any such use of TI products which TI has not designated as military-grade is solely at the Buyer's risk, and that they are solely responsible for compliance with all legal and regulatory requirements in connection with such use.

TI products are neither designed nor intended for use in automotive applications or environments unless the specific TI products are designated by TI as compliant with ISO/TS 16949 requirements. Buyers acknowledge and agree that, if they use any non-designated products in automotive applications, TI will not be responsible for any failure to meet such requirements.

Following are URLs where you can obtain information on other Texas Instruments products and application solutions:

### Products

Audio	<a href="http://www.ti.com/audio">www.ti.com/audio</a>
Amplifiers	<a href="http://amplifier.ti.com">amplifier.ti.com</a>
Data Converters	<a href="http://dataconverter.ti.com">dataconverter.ti.com</a>
DLP® Products	<a href="http://www.dlp.com">www.dlp.com</a>
DSP	<a href="http://dsp.ti.com">dsp.ti.com</a>
Clocks and Timers	<a href="http://www.ti.com/clocks">www.ti.com/clocks</a>
Interface	<a href="http://interface.ti.com">interface.ti.com</a>
Logic	<a href="http://logic.ti.com">logic.ti.com</a>
Power Mgmt	<a href="http://power.ti.com">power.ti.com</a>
Microcontrollers	<a href="http://microcontroller.ti.com">microcontroller.ti.com</a>
RFID	<a href="http://www.ti-rfid.com">www.ti-rfid.com</a>
OMAP Mobile Processors	<a href="http://www.ti.com/omap">www.ti.com/omap</a>
Wireless Connectivity	<a href="http://www.ti.com/wirelessconnectivity">www.ti.com/wirelessconnectivity</a>

### Applications

Communications and Telecom	<a href="http://www.ti.com/communications">www.ti.com/communications</a>
Computers and Peripherals	<a href="http://www.ti.com/computers">www.ti.com/computers</a>
Consumer Electronics	<a href="http://www.ti.com/consumer-apps">www.ti.com/consumer-apps</a>
Energy and Lighting	<a href="http://www.ti.com/energy">www.ti.com/energy</a>
Industrial	<a href="http://www.ti.com/industrial">www.ti.com/industrial</a>
Medical	<a href="http://www.ti.com/medical">www.ti.com/medical</a>
Security	<a href="http://www.ti.com/security">www.ti.com/security</a>
Space, Avionics and Defense	<a href="http://www.ti.com/space-avionics-defense">www.ti.com/space-avionics-defense</a>
Transportation and Automotive	<a href="http://www.ti.com/automotive">www.ti.com/automotive</a>
Video and Imaging	<a href="http://www.ti.com/video">www.ti.com/video</a>

TI E2E Community Home Page

[e2e.ti.com](http://e2e.ti.com)

Mailing Address: Texas Instruments, Post Office Box 655303, Dallas, Texas 75265  
Copyright © 2011, Texas Instruments Incorporated