

TLV1117LV 正側固定電圧出力の 1A 低ドロップアウト・レギュレータ

1 特長

- 標準精度: 1.5%
- 低 I_Q : 100 μ A 以下
 - 標準の 1117 デバイスに比べて 1/500 の低い値
- V_{IN} : 2V~5.5V
 - V_{IN} の絶対最大定格: 6V
- 出力電流が 0mA 時でも安定動作
- 低いドロップアウト: $V_{OUT} = 3.3V$ で 1A 出力時に 455mV
- 高 PSRR: 1kHz 時に 65dB
- 最小電流制限規定値: 1.1A
- コスト効率の優れたセラミック・コンデンサ使用時に安定動作:
 - ESR 0 Ω に対応
- 温度範囲: -40 $^{\circ}$ C~+125 $^{\circ}$ C
- サーマル・シャットダウン機能と過電流保護機能
- アップグレードされた機能を持つドロップイン代替品については、[TLV761](#) を参照してください
- SOT-223 パッケージで供給
 - 利用可能な電圧オプションの詳細なリストについては、このドキュメントの最後にある「[メカニカル、パッケージ、および注文情報](#)」セクションを参照してください。

2 アプリケーション

- セット・トップ・ボックス
- テレビ、モニター
- PC 周辺機器、ノートブック、マザーボード
- モデム、その他の通信製品
- スイッチング電源のポスト・レギュレーション

3 概要

TLV1117LV 低ドロップアウト (LDO) リニア・レギュレータは、一般的な TLV1117 電圧レギュレータの低入力電圧版です。

TLV1117LV は非常に低消費電力のデバイスで、従来の 1117 電圧レギュレータと比べて静止時に消費する電流は 1/500 です。この設計のため本デバイスは、非常に低いスタンバイ電流を必要とするアプリケーションに適しています。また、TLV1117LV LDO は、負荷電流が 0mA の状態で安定します。最小の負荷要件はないため、通常動作時に 1A という大きな負荷電流に対応するだけでなく、スタンバイ時の非常に小さい負荷に対して、レギュレータから電力を供給する必要があるアプリケーション用としても、有効な選択肢となります。TLV1117LV はライン過渡特性と負荷過渡特性が優れており、その結果、要求される負荷電流が 1mA 未満から 500 mA を超える範囲で変化する場合でも、出力電圧振幅のアンダーシュートやオーバーシュートは非常に小さく抑えられます。

高精度のバンドギャップとエラー・アンプにより、1.5% の精度を実現しています。本デバイスの電源電圧変動除去比 (PSRR) は非常に高いので、スイッチング・レギュレータの後段に配置するポスト・レギュレーションにも使用できます。他の有用な特徴としては、低出力ノイズ、低ドロップアウト電圧などが挙げられます。

また、等価直列抵抗 (ESR) 0 Ω のコンデンサでも安定するよう内部的に補償されています。これらの主な長所が、コスト効率の優れた小型のセラミック・コンデンサの使用を可能にしています。必要に応じて、コスト効率が優れていて、バイアス電圧が高く温度ディレーティングが大きいタイプのコンデンサを使用することもできます。

TLV1117LV は SOT-223 パッケージで供給されます。

パッケージ情報

部品番号	パッケージ(1)	本体サイズ (公称)
TLV1117LV	DCY (SOT-223, 4)	6.50mm × 3.50mm

- (1) 利用可能なパッケージについては、このデータシートの末尾にある注文情報を参照してください。

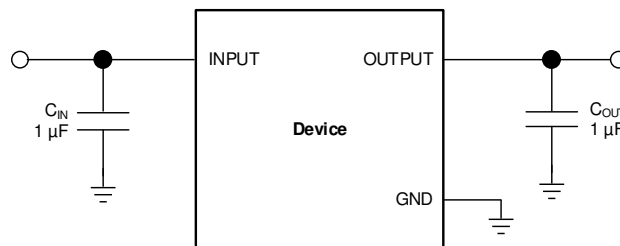

代表的なアプリケーション回路



Table of Contents

1 特長	1	8 Application and Implementation	13
2 アプリケーション	1	8.1 Application Information.....	13
3 概要	1	8.2 Typical Application.....	13
4 Revision History	2	8.3 Best Design Practices.....	14
5 Pin Configuration and Functions	3	8.4 Power Supply Recommendations.....	14
6 Specifications	4	8.5 Layout.....	14
6.1 Absolute Maximum Ratings.....	4	9 Device and Documentation Support	16
6.2 ESD Ratings.....	4	9.1 Device Support.....	16
6.3 Recommended Operating Conditions.....	4	9.2 Documentation Support.....	16
6.4 Thermal Information.....	4	9.3 ドキュメントの更新通知を受け取る方法.....	16
6.5 Electrical Characteristics.....	5	9.4 サポート・リソース.....	16
6.6 Typical Characteristics.....	6	9.5 Trademarks.....	16
7 Detailed Description	11	9.6 静電気放電に関する注意事項.....	16
7.1 Overview.....	11	9.7 用語集.....	17
7.2 Functional Block Diagram.....	11	10 Mechanical, Packaging, and Orderable	
7.3 Feature Description.....	11	Information	17
7.4 Device Functional Modes.....	12		

4 Revision History

資料番号末尾の英字は改訂を表しています。その改訂履歴は英語版に準じています。

Changes from Revision B (January 2015) to Revision C (January 2023) Page

- 「特長」セクションにドロップイン代替に関する箇条書きを追加 **1**

Changes from Revision A (September 2011) to Revision B (January 2015) Page

- 「ESD 定格」表、「機能説明」セクション、「デバイスの機能モード」セクション、「アプリケーションと実装」セクション、「電源に関する推奨事項」セクション、「レイアウト」セクション、「デバイスおよびドキュメントのサポート」セクション、「メカニカル、パッケージ、および注文情報」セクションを追加。 **1**
- 表紙の図を差し替え **1**
- Deleted *Dissipation Ratings* table..... **4**

5 Pin Configuration and Functions



图 5-1. DCY Package, 4 Pins (SOT-223) (Top View)

表 5-1. Pin Functions

PIN		I/O	DESCRIPTION
NAME	NO.		
IN	3	I	Input pin. See the Input and Output Capacitor Requirements section for more details.
OUT	2, Tab	O	Regulated output voltage pin. See the Input and Output Capacitor Requirements section for more details.
GND	1	—	Ground pin.

6 Specifications

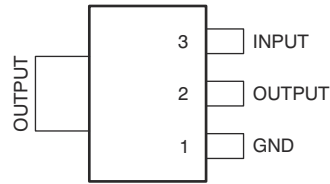
6.1 Absolute Maximum Ratings

at $T_J = 25^\circ\text{C}$ (unless otherwise noted); all voltages are with respect to GND⁽¹⁾

		MIN	MAX	UNIT
Voltage	V_{IN}	-0.3	6	V
	V_{OUT}	-0.3	6	V
Current	I_{OUT}	Internally limited		
Output short-circuit duration		Indefinite		
Continuous total power dissipation	P_{DISS}	See Thermal Information		
Temperature	Operating junction, T_J	-55	150	$^\circ\text{C}$
	Storage, T_{stg}	-55	150	$^\circ\text{C}$

- (1) Stresses beyond those listed under *Absolute Maximum Ratings* may cause permanent damage to the device. These are stress ratings only, and functional operation of the device at these or any other conditions beyond those indicated under *Recommended Operating Conditions* is not implied. Exposure to absolute-maximum-rated conditions for extended periods may affect device reliability.

6.2 ESD Ratings

			VALUE	UNIT
$V_{(ESD)}$	Electrostatic discharge	Human body model (HBM), per ANSI/ESDA/JEDEC JS-001, all pins ⁽¹⁾	± 2000	V
		Charged device model (CDM), per JEDEC specification JESD22-C101, all pins ⁽²⁾	± 500	

- (1) JEDEC document JEP155 states that 500-V HBM allows safe manufacturing with a standard ESD control process.
 (2) JEDEC document JEP157 states that 250-V CDM allows safe manufacturing with a standard ESD control process.

6.3 Recommended Operating Conditions

over operating free-air temperature range (unless otherwise noted)

		MIN	NOM	MAX	UNIT
V_{IN}	Input voltage	2		5.5	V
V_{OUT}	Output voltage	0		5.5	V
I_{OUT}	Output current	0		1	A

6.4 Thermal Information

THERMAL METRIC ⁽¹⁾		TLV1117LV	UNIT
		DCY (SOT-223)	
		4 PINS	
$R_{\theta JA}$	Junction-to-ambient thermal resistance	62.9	$^\circ\text{C}/\text{W}$
$\theta_{JC(top)}$	Junction-to-case (top) thermal resistance	47.2	$^\circ\text{C}/\text{W}$
$R_{\theta JC(top)}$	Junction-to-board thermal resistance	12	$^\circ\text{C}/\text{W}$
Ψ_{JT}	Junction-to-top characterization parameter	6.1	$^\circ\text{C}/\text{W}$
Ψ_{JB}	Junction-to-board characterization parameter	11.9	$^\circ\text{C}/\text{W}$

- (1) For more information about traditional and new thermal metrics, see the [Semiconductor and IC Package Thermal Metrics application note](#).

6.5 Electrical Characteristics

at $V_{IN} = V_{OUT(nom)} + 1.5\text{ V}$; $I_{OUT} = 10\text{ mA}$, $C_{OUT} = 1.0\text{ }\mu\text{F}$, and $T_A = 25^\circ\text{C}$ (unless otherwise noted)

PARAMETER		TEST CONDITIONS		MIN	TYP	MAX	UNIT
V_{IN}	Input voltage			2		5.5	V
V_{OUT}	DC output accuracy	$V_{OUT} > 2\text{ V}$		-1.5%		1.5%	
		$1.5\text{ V} \leq V_{OUT} < 2\text{ V}$		-2%		2%	
		$1.2\text{ V} \leq V_{OUT} < 1.5\text{ V}$		-40		40	mV
$\Delta V_{OUT(\Delta V_{IN})}$	Line regulation	$V_{OUT(nom)} + 0.5\text{ V} \leq V_{IN} \leq 5.5\text{ V}$, $I_{OUT} = 10\text{ mA}$			1	5	mV
$\Delta V_{OUT(\Delta I_{OUT})}$	Load regulation	$0\text{ mA} \leq I_{OUT} \leq 1\text{ A}$			1	35	mV
V_{DO}	Dropout voltage ⁽¹⁾	$V_{IN} = 0.98 \times V_{OUT(nom)}$	$V_{OUT} < 3.3\text{ V}$	$I_{OUT} = 200\text{ mA}$	115		mV
				$I_{OUT} = 500\text{ mA}$	285		
				$I_{OUT} = 800\text{ mA}$	455		
				$I_{OUT} = 1\text{ A}$	570	800	
		$V_{OUT} \geq 3.3\text{ V}$	$I_{OUT} = 200\text{ mA}$	90			
			$I_{OUT} = 500\text{ mA}$	230			
			$I_{OUT} = 800\text{ mA}$	365			
			$I_{OUT} = 1\text{ A}$	455	700		
I_{CL}	Output current limit	$V_{OUT} = 0.9 \times V_{OUT(nom)}$		1.1		A	
I_Q	Quiescent current	$I_{OUT} = 0\text{ mA}$			50	100	μA
PSRR	Power-supply rejection ratio	$V_{IN} = 3.3\text{ V}$, $V_{OUT} = 1.8\text{ V}$, $I_{OUT} = 500\text{ mA}$, $f = 100\text{ Hz}$			65		dB
V_n	Output noise voltage	BW = 10 Hz to 100 kHz, $V_{IN} = 2.8\text{ V}$, $V_{OUT} = 1.8\text{ V}$, $I_{OUT} = 500\text{ mA}$			60		μV_{RMS}
t_{STR}	Start-up time ⁽²⁾	$C_{OUT} = 1.0\text{ }\mu\text{F}$, $I_{OUT} = 1\text{ A}$			100		μs
UVLO	Undervoltage lockout	V_{IN} rising			1.95		V
T_{SD}	Thermal shutdown temperature	Shutdown, temperature increasing			165		$^\circ\text{C}$
		Reset, temperature decreasing			145		
T_J	Operating junction temperature			-40		125	$^\circ\text{C}$

(1) V_{DO} is measured for devices with $V_{OUT(nom)} = 2.5\text{ V}$ so that $V_{IN} = 2.45\text{ V}$.

(2) Start-up time = time from when V_{IN} asserts to when output is sustained at a value greater than or equal to $0.98 \times V_{OUT(nom)}$.

6.6 Typical Characteristics

at $V_{IN} = V_{OUT(nom)} + 1.5\text{ V}$, $I_{OUT} = 10\text{ mA}$, $C_{OUT} = 1.0\text{ }\mu\text{F}$, and $T_A = 25^\circ\text{C}$ (unless otherwise noted)

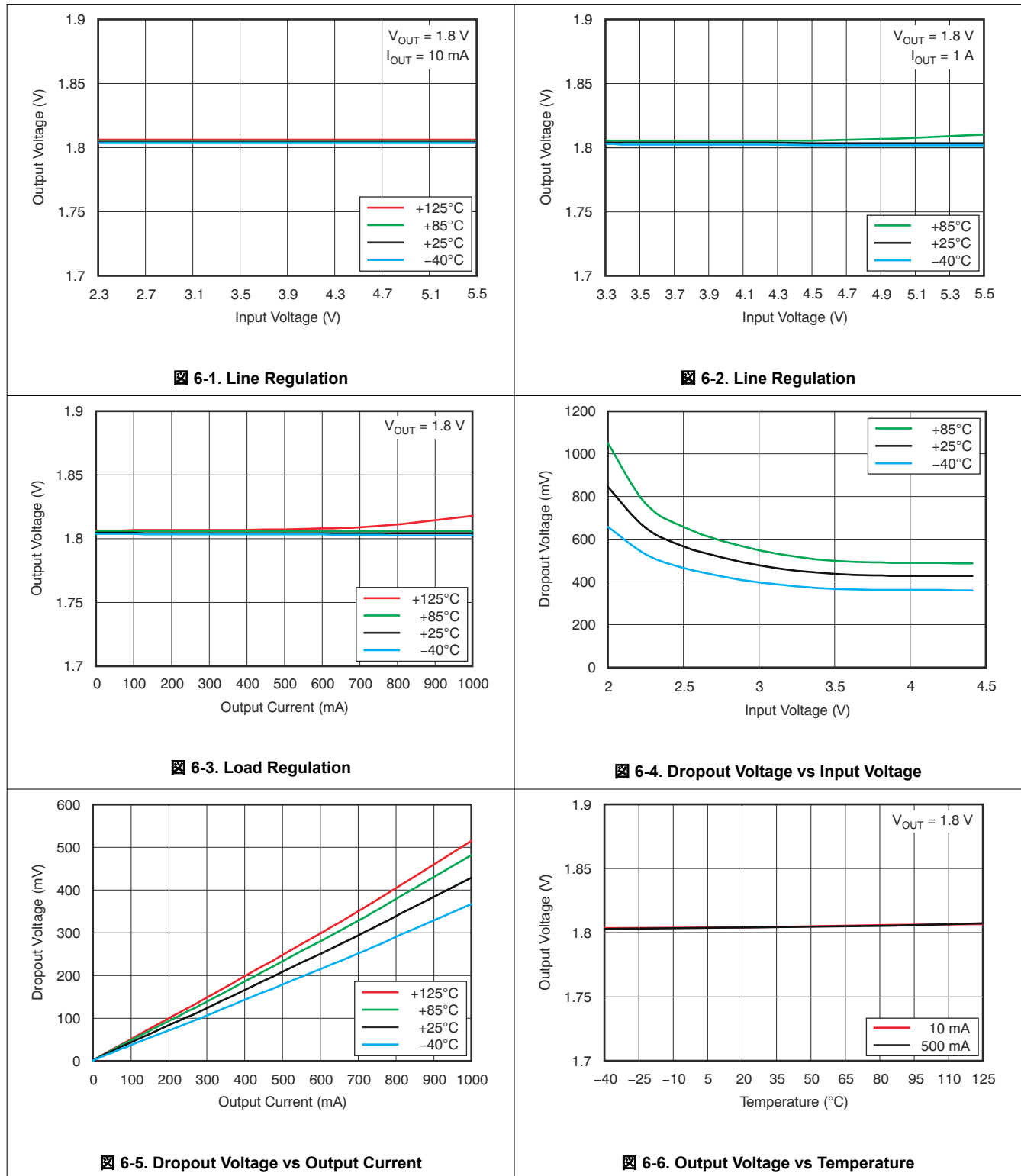

6.6 Typical Characteristics (continued)

at $V_{IN} = V_{OUT(nom)} + 1.5\text{ V}$, $I_{OUT} = 10\text{ mA}$, $C_{OUT} = 1.0\text{ }\mu\text{F}$, and $T_A = 25^\circ\text{C}$ (unless otherwise noted)

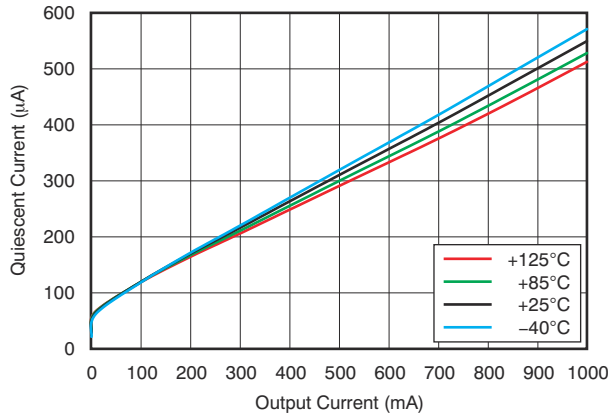

6-7. Quiescent Current vs Load

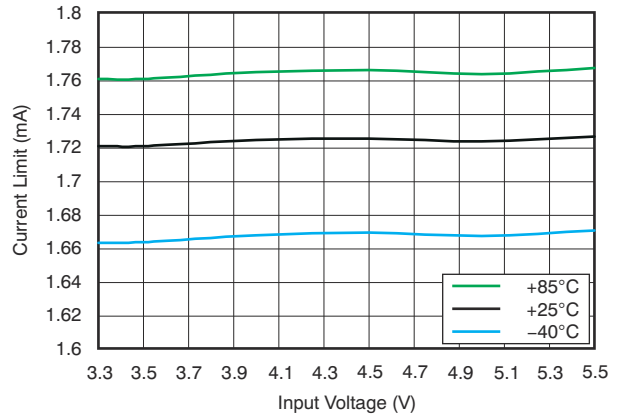

6-8. Current Limit vs Input Voltage

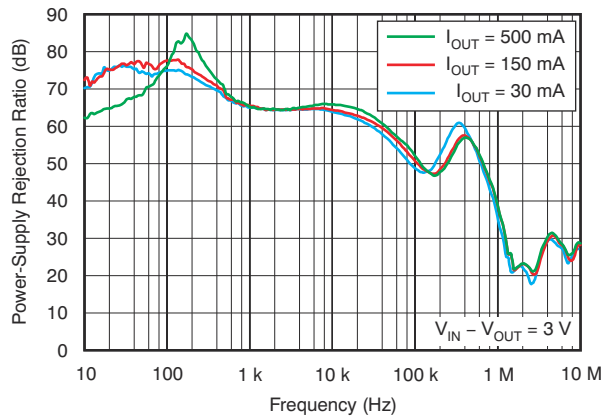

6-9. Power-Supply Rejection Ratio vs Frequency

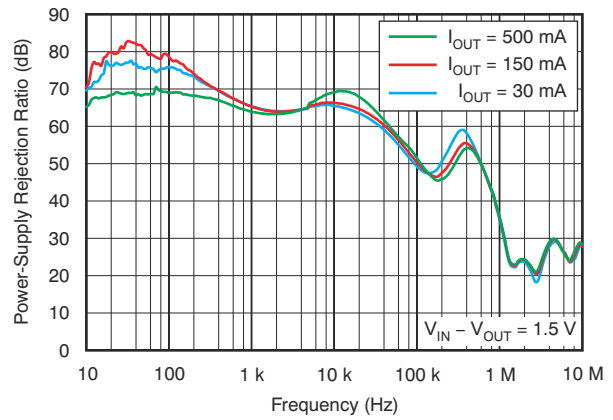

6-10. Power-Supply Rejection Ratio vs Frequency

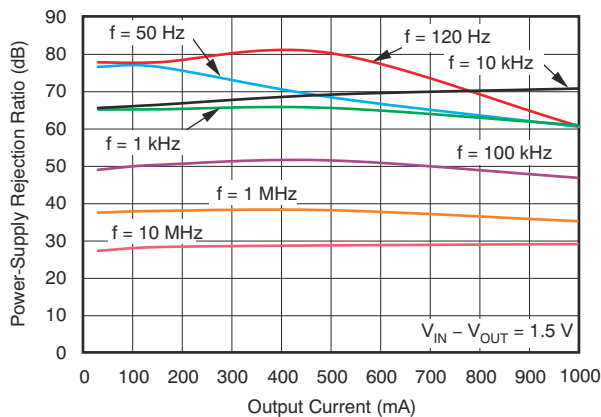

6-11. Power-Supply Rejection Ratio vs Output Current

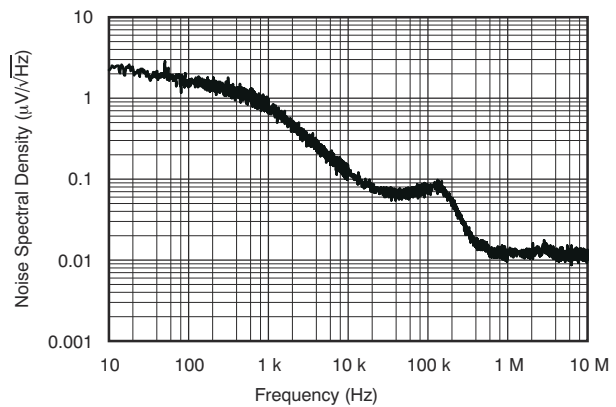

6-12. Spectral Noise Density vs Frequency

6.6 Typical Characteristics (continued)

at $V_{IN} = V_{OUT(nom)} + 1.5\text{ V}$, $I_{OUT} = 10\text{ mA}$, $C_{OUT} = 1.0\text{ }\mu\text{F}$, and $T_A = 25^\circ\text{C}$ (unless otherwise noted)

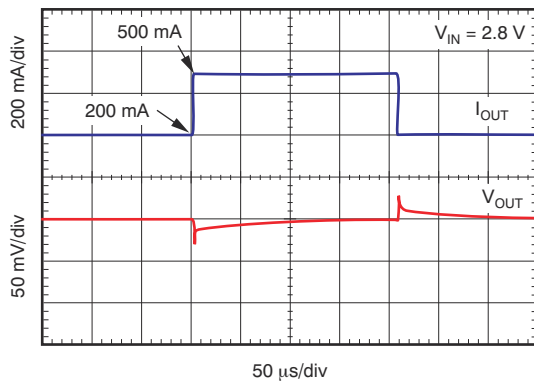

$C_{OUT} = 1\text{ }\mu\text{F}$

6-13. Load Transient Response 200 mA to 500 mA

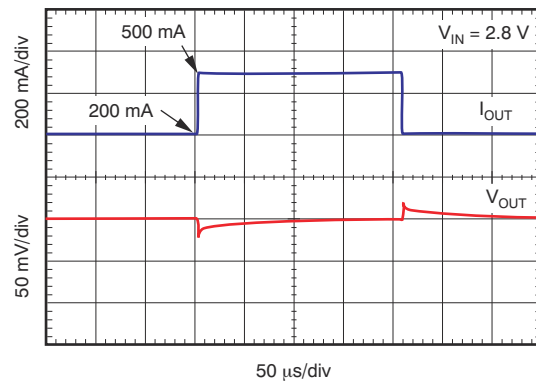

$C_{OUT} = 10\text{ }\mu\text{F}$

6-14. Load Transient Response 200 mA to 500 mA

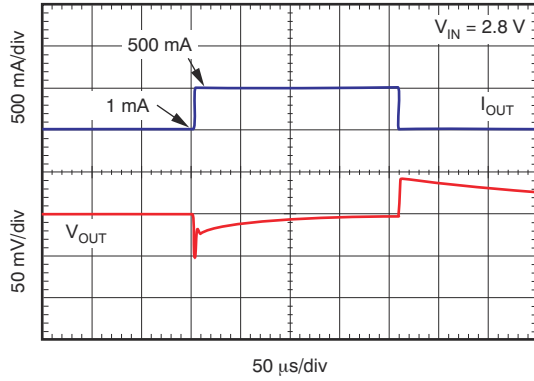

$C_{OUT} = 1\text{ }\mu\text{F}$

6-15. Load Transient Response 1 mA to 500 mA

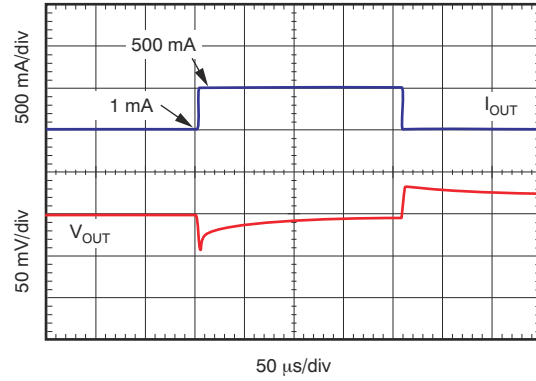

$C_{OUT} = 10\text{ }\mu\text{F}$

6-16. Load Transient Response 1 mA to 500 mA

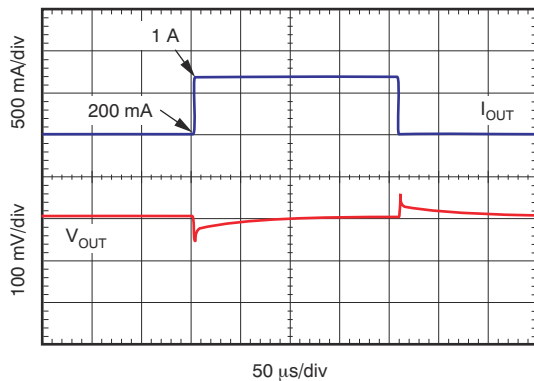

$C_{OUT} = 1\text{ }\mu\text{F}$

6-17. Load Transient Response 200 mA to 1 A

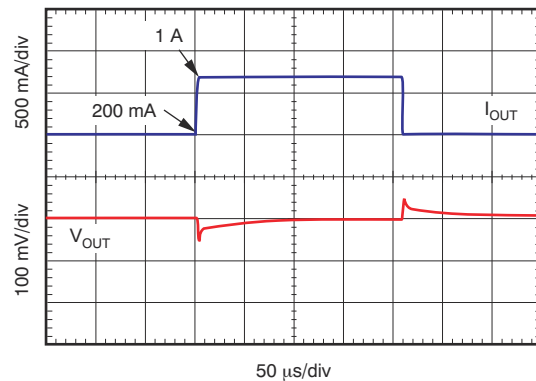

$C_{OUT} = 10\text{ }\mu\text{F}$

6-18. Load Transient Response 200 mA to 1 A

6.6 Typical Characteristics (continued)

at $V_{IN} = V_{OUT(nom)} + 1.5\text{ V}$, $I_{OUT} = 10\text{ mA}$, $C_{OUT} = 1.0\text{ }\mu\text{F}$, and $T_A = 25^\circ\text{C}$ (unless otherwise noted)

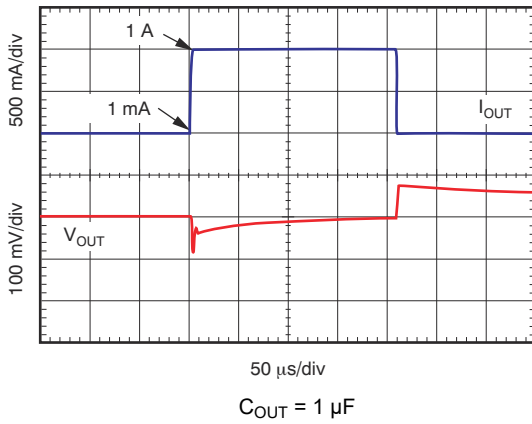

6-19. Load Transient Response 1 mA to 1 A

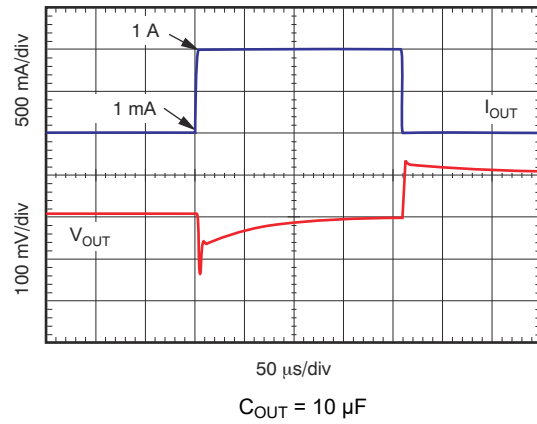

6-20. Load Transient Response 1 mA to 1 A

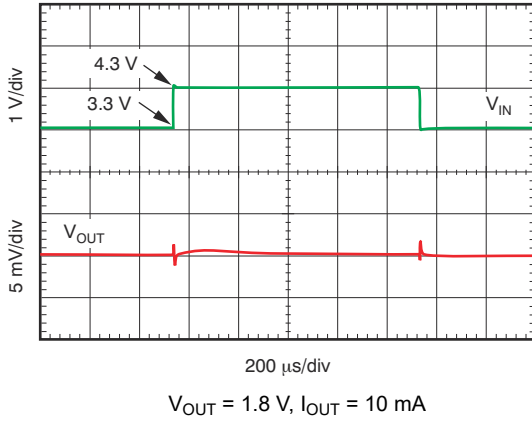

6-21. Line Transient Response

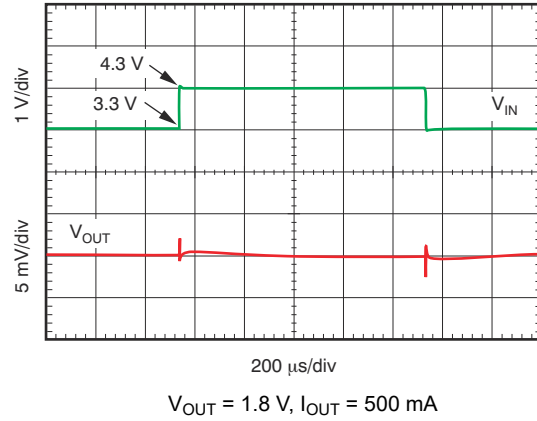

6-22. Line Transient Response

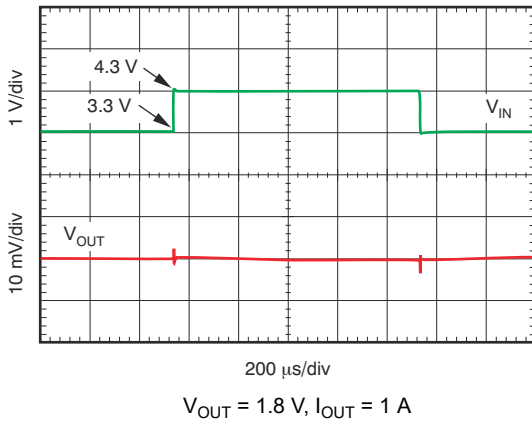

6-23. Line Transient Response

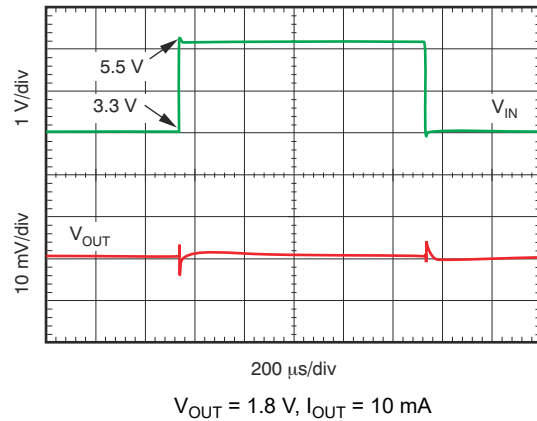

6-24. Line Transient Response

6.6 Typical Characteristics (continued)

at $V_{IN} = V_{OUT(nom)} + 1.5\text{ V}$, $I_{OUT} = 10\text{ mA}$, $C_{OUT} = 1.0\text{ }\mu\text{F}$, and $T_A = 25^\circ\text{C}$ (unless otherwise noted)

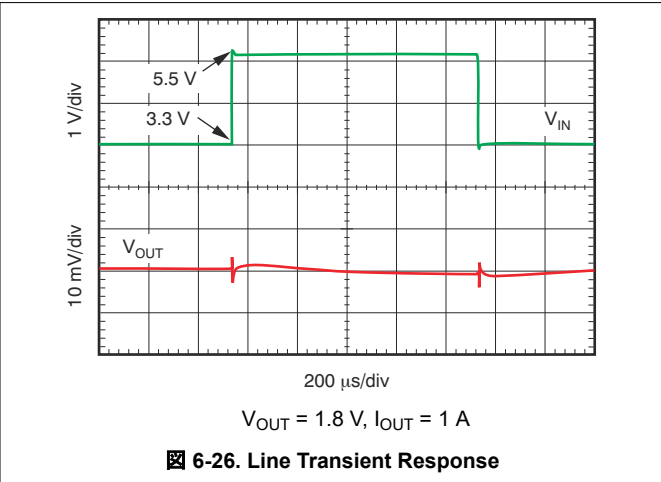
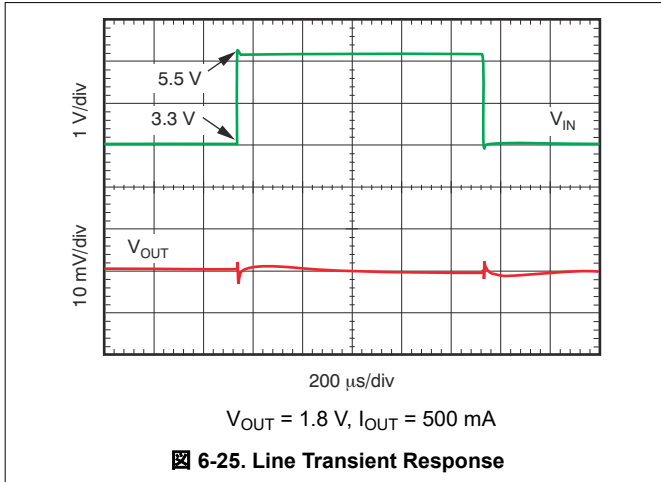

7 Detailed Description

7.1 Overview

The TLV1117LV is a low quiescent current, high PSRR LDO capable of handling up to 1 A of load current. This device features an integrated current limit, thermal shutdown, band-gap reference, and undervoltage lockout (UVLO) circuit blocks.

7.2 Functional Block Diagram

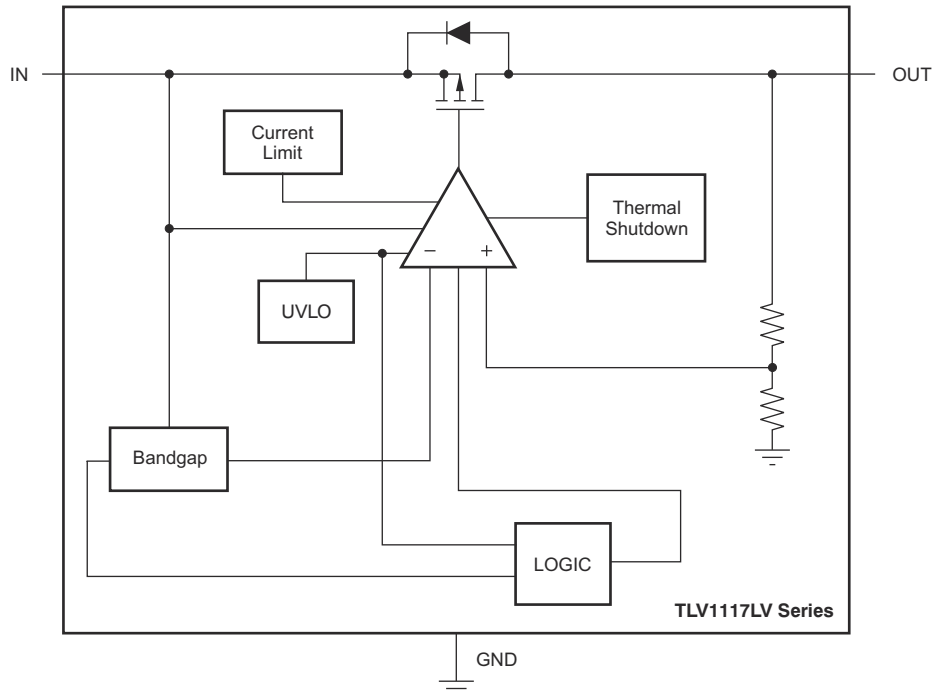

7.3 Feature Description

7.3.1 Internal Current Limit

The TLV1117LV internal current limit helps protect the regulator during fault conditions. During current limit, the output sources a fixed amount of current that is largely independent of the output voltage. In such a case, the output voltage is not regulated, and can be calculated by the formula: $V_{OUT} = I_{LIMIT} \times R_{LOAD}$. The PMOS pass transistor dissipates $(V_{IN} - V_{OUT}) \times I_{LIMIT}$ until thermal shutdown is triggered and the device turns off. When the device cools down, the internal thermal shutdown circuit turns the device back on. If the fault condition continues, the device cycles between current limit and thermal shutdown. See the [Thermal Protection](#) section for more details.

The PMOS pass transistor in the TLV1117LV has a built-in body diode that conducts current when the voltage at OUT exceeds the voltage at IN. This current is not limited; if extended reverse voltage operation is anticipated, external limiting to 5% of the rated output current is recommended.

7.3.2 Dropout Voltage

The TLV1117LV uses a PMOS pass transistor to achieve low dropout. When $(V_{IN} - V_{OUT})$ is less than the dropout voltage (V_{DO}), the PMOS pass transistor is in the linear region of operation and the input-to-output resistance is the $R_{DS(ON)}$ of the PMOS pass transistor. V_{DO} scales approximately with output current because the PMOS transistor behaves like a resistor in dropout.

As with any linear regulator, PSRR and transient response are degraded when $(V_{IN} - V_{OUT})$ approaches dropout.

7.3.3 Undervoltage Lockout

The TLV1117LV uses an undervoltage lockout (UVLO) circuit to keep the output shut off until internal circuitry is operating properly.

7.4 Device Functional Modes

7.4.1 Normal Operation

The device regulates to the nominal output voltage under the following conditions:

- The input voltage is greater than the nominal output voltage added to the dropout voltage
- The output current is less than the current limit
- The device die temperature is lower than the thermal shutdown temperature

7.4.2 Dropout Operation

If the input voltage is lower than the nominal output voltage plus the specified dropout voltage, but all other conditions are met for normal operation, the device operates in dropout mode. In this condition, the output voltage is the same the input voltage minus the dropout voltage. The transient performance of the device is significantly degraded because the pass transistor is in a triode state and no longer controls the current through the LDO. Line or load transients in dropout can result in large output voltage deviations.

表 7-1 shows the conditions that lead to the different modes of operation.

表 7-1. Device Functional Mode Comparison

OPERATING MODE	PARAMETER	
	V_{IN}	I_{OUT}
Normal mode	$V_{IN} > V_{OUT(nom)} + V_{DO}$	$I_{OUT} < I_{CL}$
Dropout mode	$V_{IN} < V_{OUT(nom)} + V_{DO}$	$I_{OUT} < I_{CL}$

8 Application and Implementation

注

以下のアプリケーション情報は、TI の製品仕様に含まれるものではなく、TI ではその正確性または完全性を保証いたしません。個々の目的に対する製品の適合性については、お客様の責任で判断していただくこととなります。お客様は自身の設計実装を検証しテストすることで、システムの機能を確認する必要があります。

8.1 Application Information

The TLV1117LV is a low quiescent current linear regulator designed for high current applications. Unlike typical high current linear regulators, the TLV1117LV consumes significantly less quiescent current. This device delivers excellent line and load transient performance. The device is low noise, and exhibits a very good PSRR. As a result, this device is designed for high current applications that require very sensitive power-supply rails.

This regulators offer both current limit and thermal protection. The operating junction temperature range of the device is -40°C to $+125^{\circ}\text{C}$.

8.2 Typical Application

図 8-1 shows a typical application circuit.



図 8-1. Typical Application Circuit

8.2.1 Design Requirements

For this design example, use the parameters listed in 表 8-1 as the input parameters.

表 8-1. Design Parameters

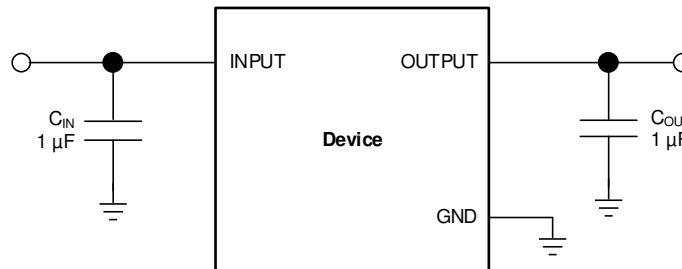
PARAMETER	DESIGN REQUIREMENT
Input voltage	2.5 V to 3.3 V
Output voltage	1.8 V
Output current	500 mA

8.2.2 Detailed Design Procedure

8.2.2.1 Input and Output Capacitor Requirements

For stability, 1.0- μF ceramic capacitors are required at the output. Higher-valued capacitors improve transient performance. Use X5R- and X7R-type ceramic capacitors because these capacitors have minimal variation in value and equivalent series resistance (ESR) over temperature. Unlike traditional linear regulators that need a minimum ESR for stability, the TLV1117LV is specified to be stable with no ESR. Therefore, cost-effective ceramic capacitors can be used with this device. Effective output capacitance that takes bias, temperature, and aging effects into consideration must be greater than 0.5 μF to ensure stability of the device.

Although an input capacitor is not required for stability, good analog design practice is to connect a 0.1- μF to 1.0- μF , low-ESR capacitor across the IN pin and GND pin of the regulator. This capacitor counteracts reactive input sources and improves transient response, noise rejection, and ripple rejection. A higher-value capacitor can be necessary if large, fast rise-time load transients are anticipated, or if the device is not located physically close to

the power source. If source impedance is greater than $2\ \Omega$, a $0.1\text{-}\mu\text{F}$ input capacitor can also be necessary to ensure stability.

8.2.2.2 Transient Response

As with any regulator, increasing the size of the output capacitor reduces overshoot and undershoot magnitude.

8.2.3 Application Curves

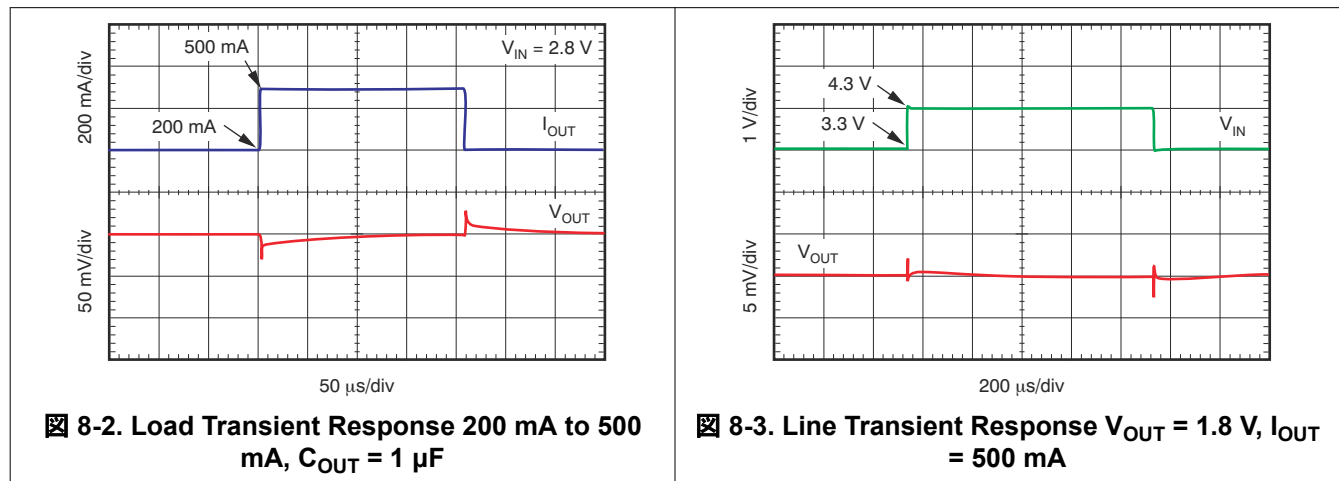

8.3 Best Design Practices

Place input and output capacitors as close to the device as possible.

Use a ceramic output capacitor.

Do not use an electrolytic output capacitor.

Do not exceed the device absolute maximum ratings.

8.4 Power Supply Recommendations

Connect a low output impedance power supply directly to the INPUT pin of the TLV1117LV. Inductive impedances between the input supply and the INPUT pin can create significant voltage excursions at the INPUT pin during start-up or load transient events.

8.5 Layout

8.5.1 Layout Guidelines

Place input and output capacitors as close to the device pins as possible. To improve characteristic AC performance (such as PSRR, output noise, and transient response), design the board with separate ground planes for V_{IN} and V_{OUT} , with the ground plane connected only at the GND pin of the device. In addition, the ground connection for the output capacitor must be connected directly to the GND pin of the device. Higher value ESR capacitors can degrade PSRR performance.

8.5.1.1 Thermal Protection

Thermal protection disables the output when the junction temperature rises to approximately 165°C , allowing the device to cool. When the junction temperature cools to approximately 145°C , the output circuitry is again enabled. Depending on power dissipation, thermal resistance, and ambient temperature, the thermal protection circuit can cycle on and off. This cycling limits the dissipation of the regulator, protecting the regulator from damage as a result of overheating.

Any tendency to activate the thermal protection circuit indicates excessive power dissipation or an inadequate heat sink. For reliable operation, limit junction temperature to 125°C maximum. To estimate the margin of safety in a complete design (including heat sink), increase the ambient temperature until the thermal protection is triggered; use worst-case loads and signal conditions.

The internal protection circuitry of the TLV1117LV is designed to protect against overload conditions. This circuitry is not intended to replace proper heat sinking. Continuously running the TLV1117LV into thermal shutdown degrades device reliability.

8.5.1.2 Power Dissipation

The ability to remove heat from the die is different for each package type, presenting different considerations in the printed circuit board (PCB) layout. The PCB area around the device that is free of other components moves the heat from the device to the ambient air. Performance data for JEDEC low and high-K boards are given in the [Thermal Information](#) table. Using heavier copper increases the effectiveness in removing heat from the device. The addition of plated through-holes to heat-dissipating layers also improves heat-sink effectiveness.

Power dissipation depends on input voltage and load conditions. Power dissipation (P_D) is equal to the product of the output current and the voltage drop across the output pass element, as shown in [式 1](#):

$$P_D = (V_{IN} - V_{OUT}) I_{OUT} \quad (1)$$

8.5.2 Layout Example

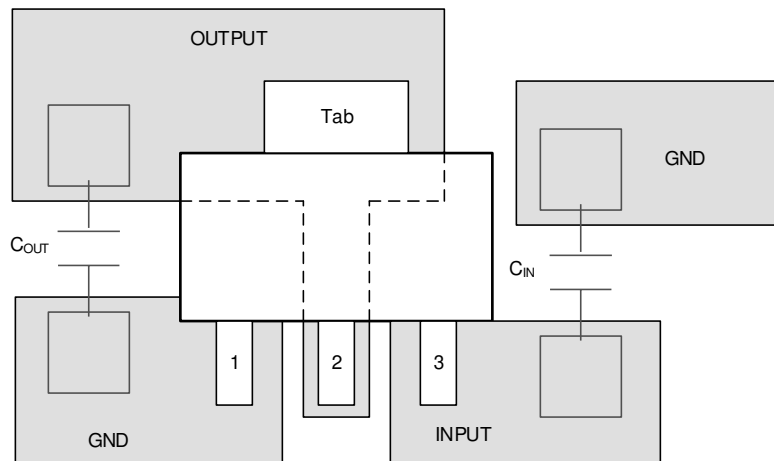

☒ 8-4. Layout Example

9 Device and Documentation Support

9.1 Device Support

9.1.1 Development Support

9.1.1.1 Evaluation Module

An evaluation module (EVM) is available to assist in the initial circuit performance evaluation using the TLV1117LV. The [TLV1117LV33EVM-714 evaluation module](#) (and [related user's guide](#)) can be requested at the TI website through the product folders or purchased directly from [the TI eStore](#).

9.1.1.2 Spice Models

Computer simulation of circuit performance using SPICE is often useful when analyzing the performance of analog circuits and systems. A SPICE model for the TLV1117LV is available through the product folders under *Tools & Software*.

9.1.2 Device Nomenclature

表 9-1. Available Options⁽¹⁾

PRODUCT	V _{OUT}
TLV1117LVxyyyz	xx is the nominal output voltage (for example 33 = 3.3 V). yyy is the package designator. z is the package quantity.

(1) For the most current package and ordering information, see the Package Option Addendum at the end of this document, or visit the device product folder at www.ti.com.

9.2 Documentation Support

9.2.1 Related Documentation

For related documentation see the following:

- Texas Instruments, [TLV1117LVxxEVM-714 Evaluation Module user's guide](#)

9.3 ドキュメントの更新通知を受け取る方法

ドキュメントの更新についての通知を受け取るには、ti.com のデバイス製品フォルダを開いてください。「更新の通知を受け取る」をクリックして登録すると、変更されたすべての製品情報に関するダイジェストを毎週受け取れます。変更の詳細については、修正されたドキュメントに含まれている改訂履歴をご覧ください。

9.4 サポート・リソース

[TI E2E™ サポート・フォーラム](#)は、エンジニアが検証済みの回答と設計に関するヒントをエキスパートから迅速かつ直接得ることができる場所です。既存の回答を検索したり、独自の質問をしたりすることで、設計に必要な支援を迅速に得ることができます。

リンクされているコンテンツは、該当する貢献者により、現状のまま提供されるものです。これらは TI の仕様を構成するものではなく、必ずしも TI の見解を反映したものではありません。TI の[使用条件](#)を参照してください。

9.5 Trademarks

TI E2E™ is a trademark of Texas Instruments.

すべての商標は、それぞれの所有者に帰属します。

9.6 静電気放電に関する注意事項



この IC は、ESD によって破損する可能性があります。テキサス・インスツルメンツは、IC を取り扱う際には常に適切な注意を払うことを推奨します。正しい取り扱いおよび設置手順に従わない場合、デバイスを破損するおそれがあります。

ESD による破損は、わずかな性能低下からデバイスの完全な故障まで多岐にわたります。精密な IC の場合、パラメータがわずかに変化するだけで公表されている仕様から外れる可能性があるため、破損が発生しやすくなっています。

9.7 用語集

[テキサス・インスツルメンツ用語集](#) この用語集には、用語や略語の一覧および定義が記載されています。

10 Mechanical, Packaging, and Orderable Information

The following pages include mechanical, packaging, and orderable information. This information is the most current data available for the designated devices. This data is subject to change without notice and revision of this document. For browser-based versions of this data sheet, refer to the left-hand navigation.

PACKAGING INFORMATION

Orderable part number	Status (1)	Material type (2)	Package Pins	Package qty Carrier	RoHS (3)	Lead finish/ Ball material (4)	MSL rating/ Peak reflow (5)	Op temp (°C)	Part marking (6)
TLV1117LV12DCYR	Active	Production	SOT-223 (DCY) 4	2500 LARGE T&R	Yes	SN	Level-1-260C-UNLIM	-40 to 125	SI
TLV1117LV12DCYR.B	Active	Production	SOT-223 (DCY) 4	2500 LARGE T&R	Yes	SN	Level-1-260C-UNLIM	-40 to 125	SI
TLV1117LV12DCYT	Obsolete	Production	SOT-223 (DCY) 4	-	-	Call TI	Call TI	-40 to 125	SI
TLV1117LV15DCYR	Active	Production	SOT-223 (DCY) 4	2500 LARGE T&R	Yes	SN	Level-1-260C-UNLIM	-40 to 125	VR
TLV1117LV15DCYR.B	Active	Production	SOT-223 (DCY) 4	2500 LARGE T&R	Yes	SN	Level-1-260C-UNLIM	-40 to 125	VR
TLV1117LV15DCYT	Obsolete	Production	SOT-223 (DCY) 4	-	-	Call TI	Call TI	-40 to 125	VR
TLV1117LV18DCYR	Active	Production	SOT-223 (DCY) 4	2500 LARGE T&R	Yes	SN	Level-1-260C-UNLIM	-40 to 125	SH
TLV1117LV18DCYR.B	Active	Production	SOT-223 (DCY) 4	2500 LARGE T&R	Yes	SN	Level-1-260C-UNLIM	-40 to 125	SH
TLV1117LV18DCYT	Active	Production	SOT-223 (DCY) 4	250 SMALL T&R	Yes	SN	Level-1-260C-UNLIM	-40 to 125	SH
TLV1117LV18DCYT.B	Active	Production	SOT-223 (DCY) 4	250 SMALL T&R	Yes	SN	Level-1-260C-UNLIM	-40 to 125	SH
TLV1117LV25DCYR	Active	Production	SOT-223 (DCY) 4	2500 LARGE T&R	Yes	SN	Level-1-260C-UNLIM	-40 to 125	VS
TLV1117LV25DCYR.B	Active	Production	SOT-223 (DCY) 4	2500 LARGE T&R	Yes	SN	Level-1-260C-UNLIM	-40 to 125	VS
TLV1117LV25DCYT	Active	Production	SOT-223 (DCY) 4	250 SMALL T&R	Yes	SN	Level-1-260C-UNLIM	-40 to 125	VS
TLV1117LV25DCYT.B	Active	Production	SOT-223 (DCY) 4	250 SMALL T&R	Yes	SN	Level-1-260C-UNLIM	-40 to 125	VS
TLV1117LV28DCYR	Active	Production	SOT-223 (DCY) 4	2500 LARGE T&R	Yes	SN	Level-1-260C-UNLIM	-40 to 125	VT
TLV1117LV28DCYR.B	Active	Production	SOT-223 (DCY) 4	2500 LARGE T&R	Yes	SN	Level-1-260C-UNLIM	-40 to 125	VT
TLV1117LV28DCYT	Obsolete	Production	SOT-223 (DCY) 4	-	-	Call TI	Call TI	-40 to 125	VT
TLV1117LV30DCYR	Active	Production	SOT-223 (DCY) 4	2500 LARGE T&R	Yes	SN	Level-1-260C-UNLIM	-40 to 125	VU
TLV1117LV30DCYR.B	Active	Production	SOT-223 (DCY) 4	2500 LARGE T&R	Yes	SN	Level-1-260C-UNLIM	-40 to 125	VU
TLV1117LV30DCYT	Obsolete	Production	SOT-223 (DCY) 4	-	-	Call TI	Call TI	-40 to 125	VU
TLV1117LV33DCYR	Active	Production	SOT-223 (DCY) 4	2500 LARGE T&R	Yes	SN	Level-1-260C-UNLIM	-40 to 125	TJ
TLV1117LV33DCYR.A	Active	Production	SOT-223 (DCY) 4	2500 LARGE T&R	Yes	SN	Level-1-260C-UNLIM	-40 to 125	TJ
TLV1117LV33DCYR.B	Active	Production	SOT-223 (DCY) 4	2500 LARGE T&R	Yes	SN	Level-1-260C-UNLIM	-40 to 125	TJ
TLV1117LV33DCYT	Obsolete	Production	SOT-223 (DCY) 4	-	-	Call TI	Call TI	-40 to 125	TJ

(1) **Status:** For more details on status, see our [product life cycle](#).

(2) **Material type:** When designated, preproduction parts are prototypes/experimental devices, and are not yet approved or released for full production. Testing and final process, including without limitation quality assurance, reliability performance testing, and/or process qualification, may not yet be complete, and this item is subject to further changes or possible discontinuation. If available for ordering, purchases will be subject to an additional waiver at checkout, and are intended for early internal evaluation purposes only. These items are sold without warranties of any kind.

(3) **RoHS values:** Yes, No, RoHS Exempt. See the [TI RoHS Statement](#) for additional information and value definition.

(4) **Lead finish/Ball material:** Parts may have multiple material finish options. Finish options are separated by a vertical ruled line. Lead finish/Ball material values may wrap to two lines if the finish value exceeds the maximum column width.

(5) **MSL rating/Peak reflow:** The moisture sensitivity level ratings and peak solder (reflow) temperatures. In the event that a part has multiple moisture sensitivity ratings, only the lowest level per JEDEC standards is shown. Refer to the shipping label for the actual reflow temperature that will be used to mount the part to the printed circuit board.

(6) **Part marking:** There may be an additional marking, which relates to the logo, the lot trace code information, or the environmental category of the part.

Multiple part markings will be inside parentheses. Only one part marking contained in parentheses and separated by a "~" will appear on a part. If a line is indented then it is a continuation of the previous line and the two combined represent the entire part marking for that device.

Important Information and Disclaimer:The information provided on this page represents TI's knowledge and belief as of the date that it is provided. TI bases its knowledge and belief on information provided by third parties, and makes no representation or warranty as to the accuracy of such information. Efforts are underway to better integrate information from third parties. TI has taken and continues to take reasonable steps to provide representative and accurate information but may not have conducted destructive testing or chemical analysis on incoming materials and chemicals. TI and TI suppliers consider certain information to be proprietary, and thus CAS numbers and other limited information may not be available for release.

In no event shall TI's liability arising out of such information exceed the total purchase price of the TI part(s) at issue in this document sold by TI to Customer on an annual basis.

TAPE AND REEL INFORMATION

QUADRANT ASSIGNMENTS FOR PIN 1 ORIENTATION IN TAPE

*All dimensions are nominal

Device	Package Type	Package Drawing	Pins	SPQ	Reel Diameter (mm)	Reel Width W1 (mm)	A0 (mm)	B0 (mm)	K0 (mm)	P1 (mm)	W (mm)	Pin1 Quadrant
TLV1117LV12DCYR	SOT-223	DCY	4	2500	330.0	12.4	7.05	7.4	1.9	8.0	12.0	Q3
TLV1117LV15DCYR	SOT-223	DCY	4	2500	330.0	12.4	7.05	7.4	1.9	8.0	12.0	Q3
TLV1117LV18DCYR	SOT-223	DCY	4	2500	330.0	12.4	7.05	7.4	1.9	8.0	12.0	Q3
TLV1117LV18DCYT	SOT-223	DCY	4	250	180.0	12.4	7.05	7.4	1.9	8.0	12.0	Q3
TLV1117LV25DCYR	SOT-223	DCY	4	2500	330.0	12.4	7.05	7.4	1.9	8.0	12.0	Q3
TLV1117LV25DCYT	SOT-223	DCY	4	250	180.0	12.4	7.05	7.4	1.9	8.0	12.0	Q3
TLV1117LV28DCYR	SOT-223	DCY	4	2500	330.0	12.4	7.05	7.4	1.9	8.0	12.0	Q3
TLV1117LV30DCYR	SOT-223	DCY	4	2500	330.0	12.4	7.05	7.4	1.9	8.0	12.0	Q3
TLV1117LV33DCYR	SOT-223	DCY	4	2500	330.0	12.4	7.05	7.4	1.9	8.0	12.0	Q3

TAPE AND REEL BOX DIMENSIONS



*All dimensions are nominal

Device	Package Type	Package Drawing	Pins	SPQ	Length (mm)	Width (mm)	Height (mm)
TLV1117LV12DCYR	SOT-223	DCY	4	2500	340.0	340.0	38.0
TLV1117LV15DCYR	SOT-223	DCY	4	2500	340.0	340.0	38.0
TLV1117LV18DCYR	SOT-223	DCY	4	2500	340.0	340.0	38.0
TLV1117LV18DCYT	SOT-223	DCY	4	250	340.0	340.0	38.0
TLV1117LV25DCYR	SOT-223	DCY	4	2500	340.0	340.0	38.0
TLV1117LV25DCYT	SOT-223	DCY	4	250	340.0	340.0	38.0
TLV1117LV28DCYR	SOT-223	DCY	4	2500	340.0	340.0	38.0
TLV1117LV30DCYR	SOT-223	DCY	4	2500	340.0	340.0	38.0
TLV1117LV33DCYR	SOT-223	DCY	4	2500	340.0	340.0	38.0

DCY (R-PDSO-G4)

PLASTIC SMALL-OUTLINE



- NOTES: A. All linear dimensions are in millimeters (inches).
 B. This drawing is subject to change without notice.
 C. Body dimensions do not include mold flash or protrusion.
 D. Falls within JEDEC TO-261 Variation AA.

DCY (R-PDSO-G4)

PLASTIC SMALL OUTLINE

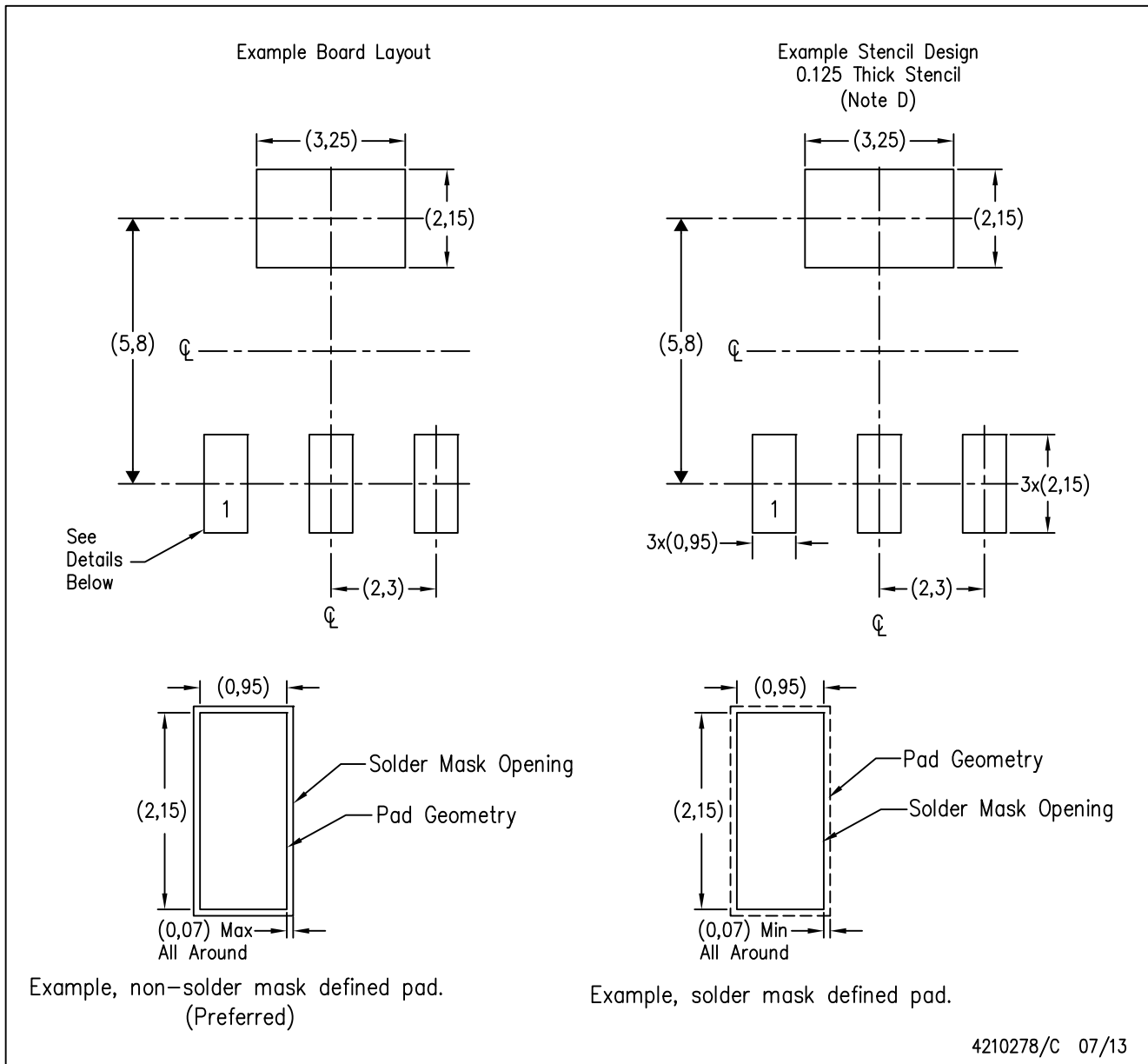

- NOTES:
- A. All linear dimensions are in millimeters.
 - B. This drawing is subject to change without notice.
 - C. Publication IPC-7351 is recommended for alternate designs.
 - D. Laser cutting apertures with trapezoidal walls and also rounding corners will offer better paste release. Customers should contact their board assembly site for stencil recommendations. Refer to IPC 7525 for stencil design considerations.

重要なお知らせと免責事項

TI は、技術データと信頼性データ(データシートを含みます)、設計リソース(リファレンス デザインを含みます)、アプリケーションや設計に関する各種アドバイス、Web ツール、安全性情報、その他のリソースを、欠陥が存在する可能性のある「現状のまま」提供しており、商品性および特定目的に対する適合性の黙示保証、第三者の知的財産権の非侵害保証を含むいかなる保証も、明示的または黙示的にかかわらず拒否します。

これらのリソースは、TI 製品を使用する設計の経験を積んだ開発者への提供を意図したものです。(1) お客様のアプリケーションに適した TI 製品の選定、(2) お客様のアプリケーションの設計、検証、試験、(3) お客様のアプリケーションに該当する各種規格や、その他のあらゆる安全性、セキュリティ、規制、または他の要件への確実な適合に関する責任を、お客様のみが単独で負うものとし、

上記の各種リソースは、予告なく変更される可能性があります。これらのリソースは、リソースで説明されている TI 製品を使用するアプリケーションの開発の目的でのみ、TI はその使用をお客様に許諾します。これらのリソースに関して、他の目的で複製することや掲載することは禁止されています。TI や第三者の知的財産権のライセンスが付与されている訳ではありません。お客様は、これらのリソースを自身で使用した結果発生するあらゆる申し立て、損害、費用、損失、責任について、TI およびその代理人を完全に補償するものとし、TI は一切の責任を拒否します。

TI の製品は、[TI の販売条件](#)、[TI の総合的な品質ガイドライン](#)、[ti.com](#) または TI 製品などに関連して提供される他の適用条件に従い提供されます。TI がこれらのリソースを提供することは、適用される TI の保証または他の保証の放棄の拡大や変更を意味するものではありません。TI がカスタム、またはカスタマー仕様として明示的に指定していない限り、TI の製品は標準的なカタログに掲載される汎用機器です。

お客様がいかなる追加条項または代替条項を提案する場合も、TI はそれらに異議を唱え、拒否します。

Copyright © 2025, Texas Instruments Incorporated

最終更新日：2025 年 10 月