

# EVM User's Guide: BQ25640EVM

## BQ25640 Evaluation Module



### Description

The BQ25640EVM evaluation module (EVM) is a complete evaluation system for the BQ25640 IC, a switch mode buck single-cell battery charger with an input range of 3.9V - 18V and NVDC power path management in a WQFN package.

The BQ25640EVM has a maximum operational input of 18V and a maximum charge current of 5A.

### Get Started

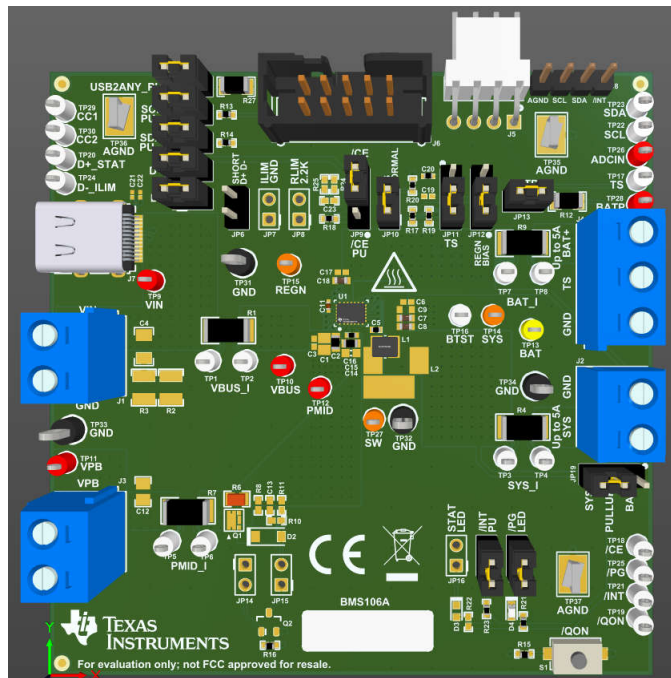
1. Order the EVM on [ti.com](https://ti.com).
2. Order the [EV2400](#) to communicate with the EVM.
3. Download the BQ25640 BQZ file.
4. Download the BQ25640 EVM design files on [ti.com](https://ti.com).

### Features

- Narrow VDC (NVDC) power path management for powering the systems and charging the battery.
- Supports I2C communication for systems configuration and status reporting.
- Test points for key signals available for testing purposes.
- Jumpers for easy configuration.
- One push-button for wake-up and reset input with adjustable timers.
- USB Type-C connector for USB Type-C detection evaluation.
- Connections for EV2400 & USB2ANY.

### Applications

- Consumer wearables, Smartwatch
- Portable speakers, TWS earphones
- IP camera, EPOS
- Portable medical equipment



**BQ25640EVM Hardware Board**

# 1 Evaluation Module Overview

## 1.1 Introduction

The BMS106 evaluation module (EVM) is a complete charger module for evaluating the BQ25640 device. The BQ25640 is an I<sup>2</sup>C-controlled single-cell charger with NVDC Power Path Management, Integrated ADC, USB Type-C Detection, and OTG mode output.

This user's guide provides detailed testing instructions for the BQ25640 evaluation module (EVM). Also included are descriptions of the necessary equipment, equipment setup, and test procedures. The reference documentation contains the printed-circuit board layouts, schematics, and the bill of materials (BOM).

Throughout this user's guide, the abbreviations *EVM*, *BQ25640EVM*, *BMS106*, and the term *evaluation module* are synonymous with the BMS106 evaluation module, unless otherwise noted.

	<b>Caution</b>	<b>Caution: Hot surface. Contact can cause burns. Do not touch!</b>
---	----------------	---

## 1.2 Kit Contents

The kit includes the following:

- 1 BQ25640 EVM

## 1.3 Specifications

[Table 1-1](#) lists the recommended operating conditions for this EVM.

**Table 1-1. Recommended Operating Conditions**

Symbol	Description	Min	Typ	Max	Unit
$V_{VBUS}, V_{VIN}$	Input voltage applied to VBUS pin	3.9		18.0	V
$V_{BAT}$	Battery voltage applied to BAT pin			4.8	V
$I_{VBUS}$	Input current into VBUS			3.2	A
$I_{SW}$	Output current from SW flowing to SYS pin load and battery at BAT pin			5.0	A
$I_{BAT}$	Fast charging current into battery at BAT pin			5.0	A
	Continuous RMS discharge current through internal BATFET			10	A

## 1.4 Device Information

This EVM does not include the EV2400 or USB2ANY interface boards. To evaluate the EVM, an EV2400 must be ordered separately to evaluate the EVM with the BQ25640 bqz GUI.

For detailed features and operation, see [Table 1-2](#) for the corresponding data sheet.

**Table 1-2. Device Data Sheets**

Device	Data Sheet	EVM Label
BQ25640	<a href="#">SLVSIK1</a>	BQ25640EVM

## 2 Hardware

### 2.1 Header Information

Table 2-1 lists the input and output connections available on this EVM and the respective descriptions.

**Table 2-1. EVM I/O Connections**

Jack	Description
J1(1) - VIN	Positive rail of the charger input voltage
J1(2) - GND	Ground
J2(1) - SYS	Positive rail of the charger system output voltage, typically connected to the system load
J2(2) - GND	Ground
J3(1) - VPB	Positive rail of the charger output voltage for power bank applications in reverse boost mode (OTG). This output also shares the rail with the VIN input rail in forward buck mode
J3(2)-GND	Ground
J4(3) - BAT+	Positive rail of the charger battery input, connected to the positive terminal of the external battery
J4(2) - TS	Connection available for external thermistor if required
J4(1) - GND	Ground
J5	I <sup>2</sup> C connector for the EV2400 interface board
J6	I <sup>2</sup> C connector for the USB2ANY interface board
J7	Input source USB Type-C port
J8	4 pin connector available for I <sup>2</sup> C lines and INT if interfacing with an MCU

## 2.2 Jumper Information

Table 2-2 lists the jumper and shunt installations available on this EVM and the respective descriptions.

**Table 2-2. EVM Jumper Shunt and Switch Installation**

Jack	Description	BQ25640 Setting
JP1	USB2ANY pull-up rail. Not required if using EV2400.	Installed
JP2	SCL pull-up rail. not required if using EV2400.	Installed
JP3	SDA pull-up rail. not required if using EV2400.	Installed
JP4	USB Type C port input D+ connection to charger D+ pin.	Installed
JP5	USB Type C port input D- connection to charger D- pin.	Installed
JP6	Charger D+ pin and charger D- pin short connection. Connect this to simulate the connection of a DCP-type USB port as defined by USB BC1.2.	Not Installed
JP7	D-_ILIM to ground connection.	Not Installed
JP8	D-_ILIM to 2.2kohm connection.	Not Installed
JP9	$\overline{CE}$ pin connection to ground or pullup to enable/disable charging. When $\overline{CE}$ connected to pullup, short pins 1-2, charge disabled.	Short pins 2-3
JP10	Connect 10 kohm in parallel with TS resistor network to simulate a battery at 25 C. Disconnect if using external thermistor.	Installed
JP11	Selector between charger TS pin and ADCIN.	Short pins 2-3
JP12	Selector between Pin 7 and Pin 19 as pullup for TS resistor network.	Short pins 2-3
JP13	BATP pin connection to BAT+ on J4.	Installed
JP14	$\overline{PG}$ pin connection to REGN.	Not Installed
JP16	D+_STAT pin LED indicator connection.	Not Installed
JP17	$\overline{INT}$ pin connection to pull-up rail.	Installed
JP18	$\overline{PG}$ pin LED indicator connection. On $\overline{PG}$ enabled chargers, this indicates the Power Good status.	Installed
JP19	I/O pull-up rail selection. Select either BAT or SYS as pullup rail.	Short pins 2-3
S1	$\overline{QON}$ control switch. Press either for exiting Shipping Mode or System Reset.	Default Off

## 2.3 Equipment

This section includes a list of supplies required to perform tests on this EVM.

- Power Supplies:** Power Supply #1 (PS #1): A power supply capable of supplying 5V at 3.5A is required. While this part can handle larger voltage and current, the part is not necessary for this procedure.
- Load #1 for simulating a battery:** 4-Quadrant Supply, Constant Voltage < 4.5V) "Kepco" Load, BOP, 20-5M, DC 0 to  $\pm 20V$ , 0 to  $\pm 5A$  (or higher)  
Alternative Option: A 0–20V/0–3.5A, > 30W DC electronic load set in a constant voltage loading mode
- Load #2 for simulating a load at SYS or load at VBUS in reverse/OTG mode:** Electronic or Resistive Load capable sinking up to 5A from up to 9V (or higher)
- Meters:** 4x "Fluke 75" multi-meters, (equivalent or better).  
Alternative Option: (2x) equivalent voltage meters and (2x) equivalent 5A or higher rated current meters.
- Computer:** A Windows 10 or 11 based computer with at least one USB port and a USB cable. Must have the latest version of Battery Management Studio installed.
- USB-TO-GPIO Communication Kit:** EV2400 USB-based PC interface board.
- Software:** BQStudio software with latest .bqz file for BQ25640 provided by Texas Instruments. Download and install bqStudio from <https://www.ti.com/tool/BQSTUDIO>.

## 2.4 Hardware Setup

Use the following list to set up the EVM testing equipment:

1. Review EVM jumper connections in [Table 2-2](#).
2. Set PS #1 for 5V DC, 2A current limit and then turn off the supply.
3. Connect the output of PS#1 in series with a current meter to J1 (VIN and PGND).
4. Connect a voltage meter across TP10 (VBUS) and TP31 (PGND), or across J1.
5. Turn on Load #1, set to constant voltage mode, and output to 2.5V. Disable Load. Connect Load in series with a current meter (multimeter), ground side, to J4 (BAT and PGND) as shown in [Figure 2-1](#) if not using a source meter with current measuring capabilities.
6. Connect a voltage meter across TP13 (BAT) and TP32 (PGND), or across J4-3 and J4-1 as in [Figure 2-1](#).
7. Connect a voltage meter across TP14 (SYS) and TP32 (PGND), or across J2-1 and J2-2 as in [Figure 2-1](#).
8. Connect a voltage meter across TP12 (PMID) and TP32 (PGND).
9. Connect the EV2400 USB interface board to the computer with a USB cable and from I2C port to J10 with the 4-pin cable as in [Figure 2-1](#).
10. Install shunts as shown in [Table 2-2](#). Note that the shunts in [Figure 2-1](#) are not necessarily installed per the table.

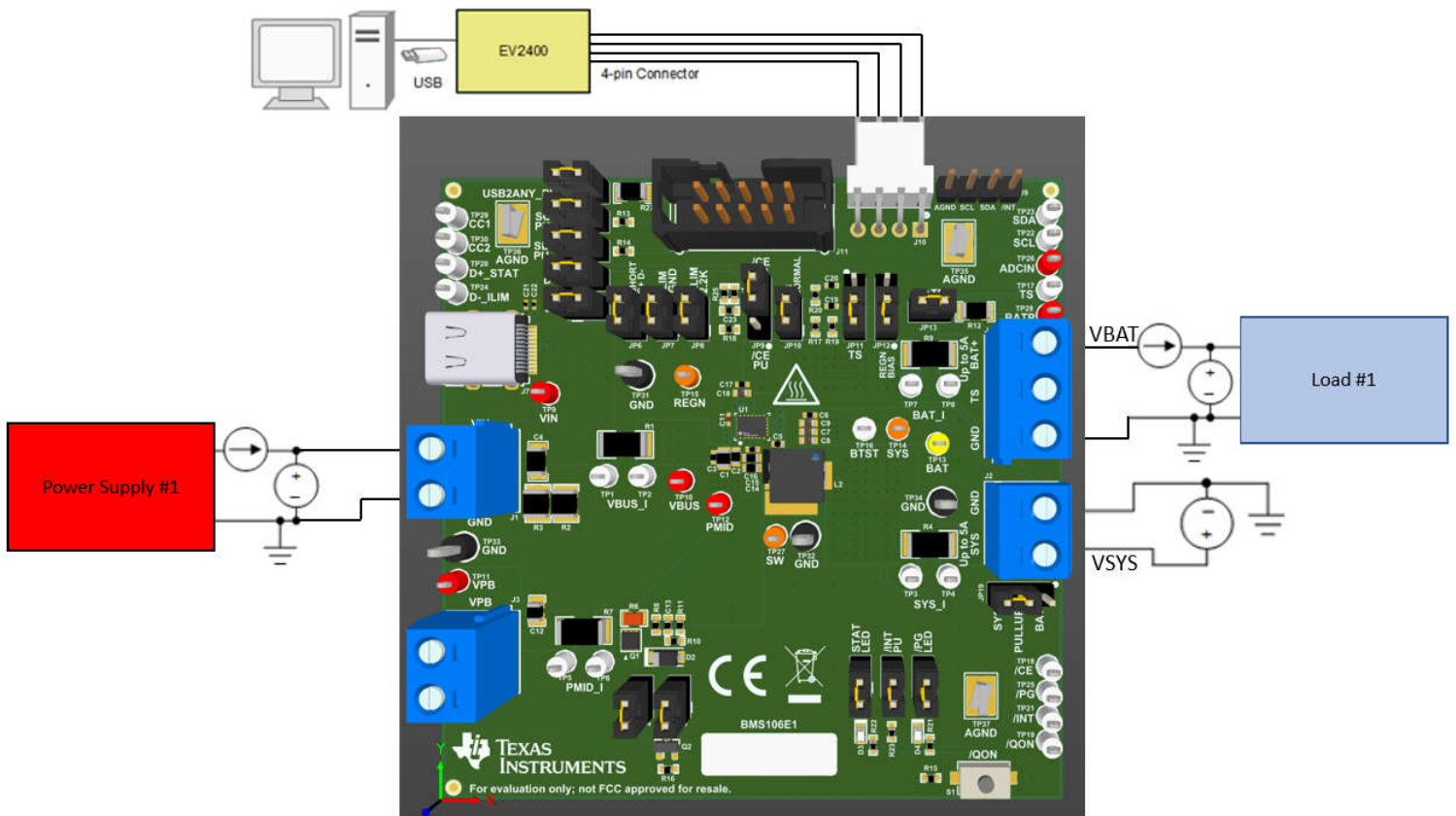


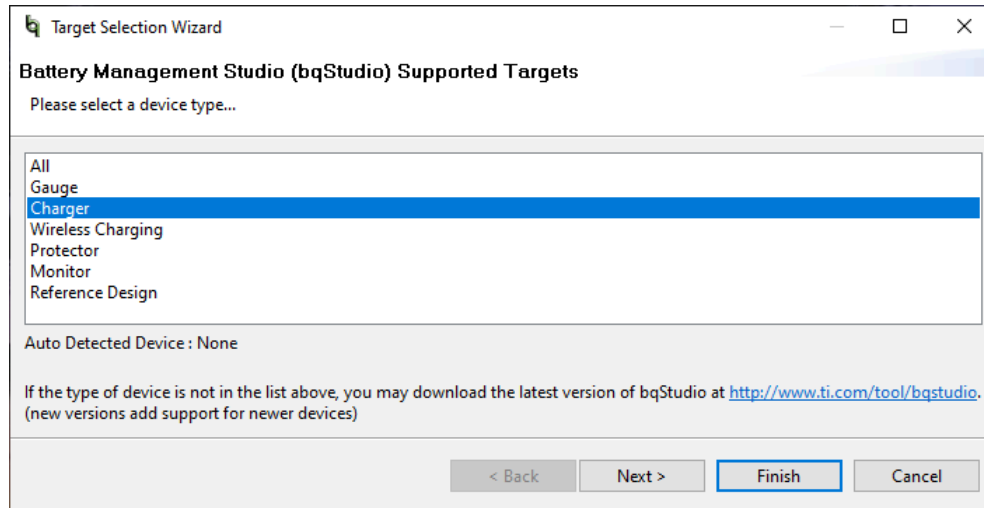
Figure 2-1. Test Setup for BQ25640 EVM

## 3 Software

### 3.1 Software Setup

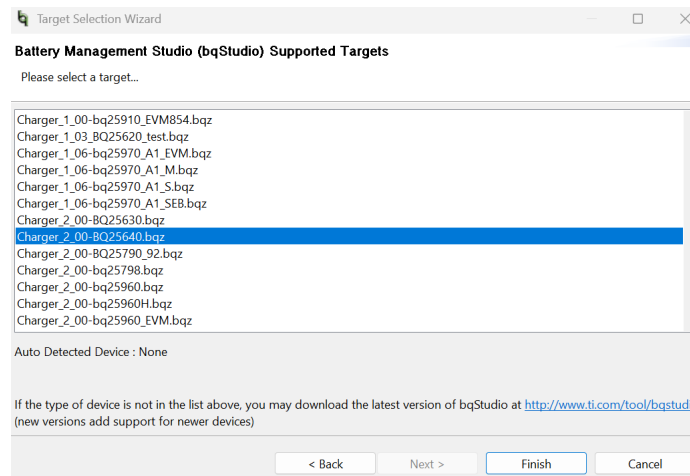
Use the following to set up the EVM testing software:

1. On the computer connected to the EV2400 interface board, launch Battery Management Studio (BQStudio). Select Charger as seen in [Figure 3-1](#).

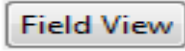


**Figure 3-1. BQStudio Device Type Selection Window**

2. Select the appropriate configuration file based on the device BQ25640 from the window shown in [Figure 3-2](#).



**Figure 3-2. BQStudio Charger Selection Window (choose Charger\_2\_00-bq25640.bqz)**

3. Choose  , on the window that appears, and the main window of the BQ25640 EVM software appears, as shown in [Figure 3-3](#).

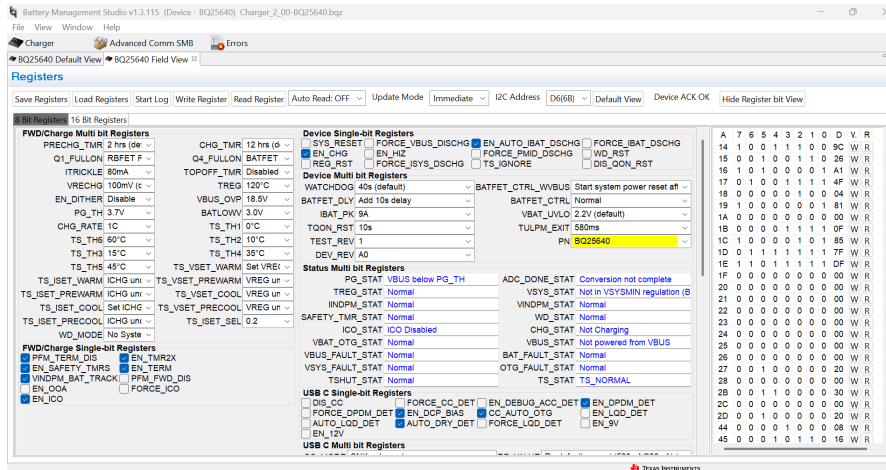


Figure 3-3. Main Window of BQ25640 EVM Software

## 3.2 Test Procedure

### 3.2.1 Initial Power Up

Use the following steps for enabling the EVM test setup:

1. Make sure that [Section 2.4](#) steps have been followed.
2. Make sure that [Section 3.1](#) steps have been followed.
3. Turn on PS #1:
  - **Measure** →  $V_{SYS}$  (SYS-TP19 and PGND-TP21) = 3.70V ±0.2V

---

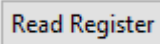
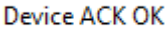
#### Note

Completely disconnect Load #1 from BATTERY connections if different value is seen.

---

### 3.2.2 I<sup>2</sup>C Register Communication Verification

Use the following steps for communication verification :

1. In the EVM software, click the  button
  - Verify that the GUI reads  in the top right corner.

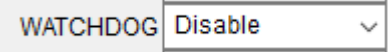


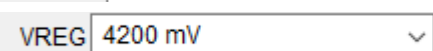

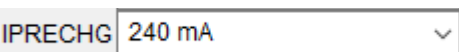
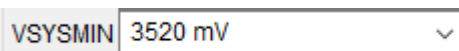
---

#### Note

If the device reads  verify [Section 2.4](#) and [Section 3.2.1](#) steps have been followed.

---

2. In the Field View (see [Figure 3-3](#)), make the following changes as necessary:

- Set 
- Set 
- Set 
- Set 
- Set 
- Set 
- Set 
- Check  EN\_CHG
- Uncheck  EN\_TERM

### 3.2.3 Charger Mode Verification

Use the following steps for charger mode verification:

- PS #1 is on from [Section 3.2.1](#). In the EVM software, select Read Register twice.
  - Verify that all Fault statuses read *Normal*.

Status Multi bit Registers			
PG_STAT	VBUS above PG_TH	ADC_DONE_STAT	Conversion not complete
TREG_STAT	Normal	VSYS_STAT	In VSYSMIN regulation (BAT < VS)
IINDPM_STAT	Normal	VINDPM_STAT	Normal
SAFETY_TMR_STAT	Normal	WD_STAT	Normal
ICO_STAT	ICO Routine Suspended	CHG_STAT	Pre-charge
VBAT_OTG_STAT	Normal	VBUS_STAT	Unknown adaptor (3.2A or result c
VBUS_FAULT_STAT	Normal	BAT_FAULT_STAT	Normal
VSYS_FAULT_STAT	Normal	OTG_FAULT_STAT	Normal
TSHUT_STAT	Normal	TS_STAT	TS_NORMAL

- To confirm SYS voltage regulation, enable Load #1 (see [Section 2.4](#)) and take DMM measurements as follows:
  - Measure** →  $V_{SYS}$  (SYS-TP14 and PGND-TP27 or TP29) = 3.75V ±0.3V.
  - Measure** →  $V_{BAT}$  (BAT-TP13 and PGND-TP27 or TP29) = 2.5V ±0.2V.
  - Measure** →  $I_{BAT}$  = 200mA ±50mA.
- To confirm battery charge current regulation, change Load #1 to 3.7V and take DMM measurements as follows:
  - Measure** →  $V_{SYS}$  (SYS-TP14 and PGND-TP27 or TP29) = 3.8V ±0.3V.
  - Measure** →  $V_{BAT}$  (BAT-TP13 and PGND-TP27 or TP29) = 3.7V ±0.2V.
  - Measure** →  $I_{BAT}$  = 480mA ±100mA.
- To confirm input current limit operation, in the EVM software on the 16-bit tab, set fast charge current to 1040mA and then take DMM measurement ( or PS #1 measurement if accurate) as follows:
  - Measure** →  $I_{IN}$  = 500 mA ±200mA.

### 3.2.4 Boost Mode Verification

Use the following steps for boost mode verification:

1. Turn off and disconnect PS #1.
2. Set Load #1, the battery simulator, to 3.7V and 2A current limit.

#### Note

If Load #1 connected from BATTERY-J4(3) to GND-J4(1) is not a four quadrant supply, then remove Load #1 and use PS #1, set to 3.7V, 2A current limit and connect to BATTERY-J4(3) and GND-J4(1).

3. In the EVM software on the 16-bit tab, confirm that VOTG, the OTG regulation voltage, is set to 5040mV and IOTG, the OTG current limit, is set to 1000mA.

OTG Multi bit Registers	
IOTG	1500.000 mA
VOTG	5100.000 mV

4. In the EVM software on the 8-bit tab, disable watchdog then check EN\_OTG.

Device Multi bit Registers	
WATCHDOG	Disable
BATFET_DLY	Add 10s delay
IBAT_PK	9A
TQON_RST	10s
TEST_REV	1
DEV_REV	A0
BATFET_CTRL_WVBUS	Start system power reset afl
BATFET_CTRL	Normal
VBAT_UVLO	2.2V (default)
TULPM_EXIT	580ms
PN	BQ25640

OTG Single-bit Registers	
<input checked="" type="checkbox"/> EN_OTG	<input type="checkbox"/> PFM_OTG_DIS
OTG Multi bit Registers	
VBAT_OTG_MIN	3.2V rising/ 3.0V falling
TS_TH_OTG_COLD	-20 deg C
TS_TH_OTG_HOT	60 deg C

5. Connect Load #2 across VPB-J3(1) and PGND-J3(2) or VIN-J1(2) and PGND-J1(1)
6. Set Load #2 to 500mA constant current load and the turn on the load.
7. To confirm the VOTG regulation,
  - **Measure** →  $V_{BUS} = 5100\text{mV} + 155\text{mV}$
8. Turn off and disconnect the power supply.
9. Remove Load #2 from the connection.

### 3.2.5 Helpful Tips

1. The leads and cables to the various power supplies, batteries and loads have resistance. The current meters also have series resistance. The charger dynamically reduces charge current depending on the voltage sensed at the VBUS pin (using the VINDPM feature), BAT pin (as part of normal termination), and TS pin (through the battery temperature monitoring feature via battery thermistor). Therefore, voltmeters must be used to measure the voltage as close to the IC pins as possible instead of relying on the digital readouts of the power supply. If a battery thermistor is not available, then that shunts JP13 in place.
2. When using a source meter that can source and sink current as your battery simulator, TI highly recommends adding a large ( $\geq 1000+ \mu\text{F}$ ) capacitor at the EVM BATTERY and GND connector to prevent oscillations at the BAT pin due to mismatched impedances of the charger output and source meter input within the respective regulation loop bandwidths. Configuring the source meter for 4-wire sensing eliminates the need for a separate voltmeter to measure the voltage at the BAT pin. When using 4-wire sensing, always make sure that the sensing leads are properly connected to prevent accidental overvoltage by the power leads.
3. For precise measurements of input and output current, especially near termination, the current meter in series with the battery or battery simulator must not be set to auto-range and needs to be removed entirely. An alternate method for measuring charge current is to either use an oscilloscope with hall effect current probe or by a differential voltage measurement across the relevant sensing resistors populated on the BQ25640EVM.

## 4 Hardware Design Files

### 4.1 Schematic

Figure 4-1 illustrates the schematic for the BQ25640EVM.

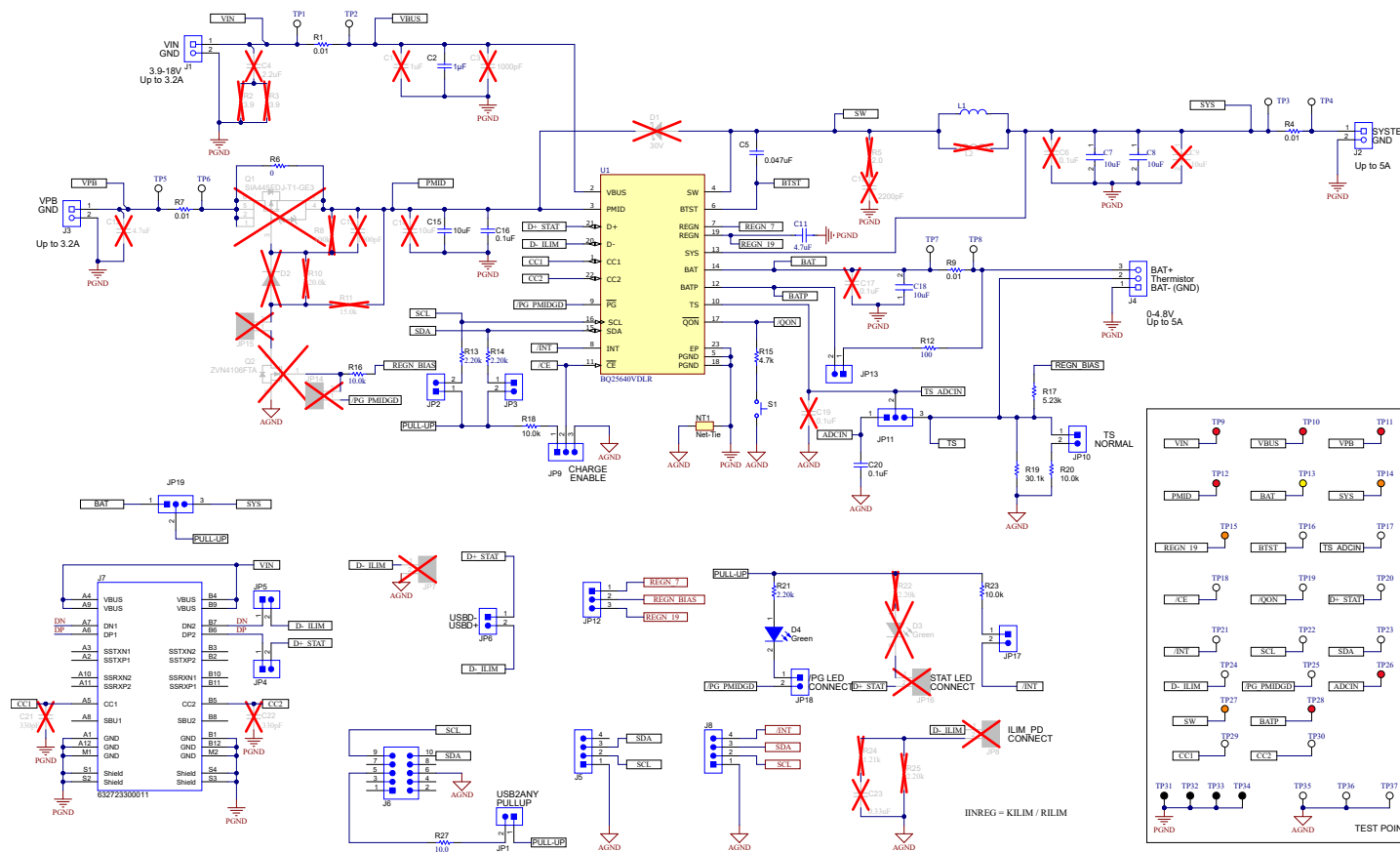
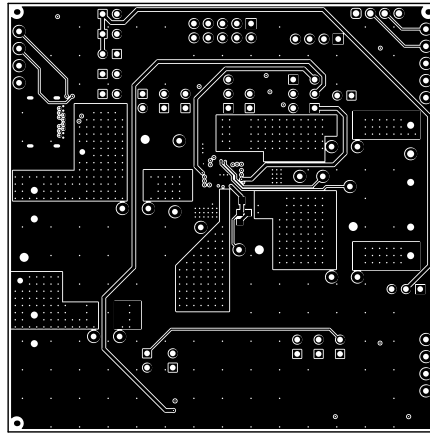


Figure 4-1. BQ25640EVM Schematic





**Figure 4-8. BMS106 Bottom Layer**

#### **4.2.1 PCB Layout Guidelines**

The switching node rise and fall times must be minimized for minimum switching loss. Proper layout of the components to minimize high frequency current path loop is important to prevent electrical and magnetic field radiation and high frequency resonant problems. Follow this specific order carefully to achieve the proper layout.

1. Place input capacitor as close as possible to PMID pin and GND pin connections and use shortest copper trace connection or GND plane.
2. Place inductor input pin to SW pin as close as possible. Minimize the copper area of this trace to lower electrical and magnetic field radiation but make the trace wide enough to carry the charging current. Do not use multiple layers in parallel for this connection. Minimize parasitic capacitance from this area to any other trace or plane.
3. Put output capacitor near to the inductor and the device. Ground connections need to be tied to the IC ground with a short copper trace connection or GND plane.
4. Place decoupling capacitors next to the IC pins and make trace connection as short as possible.
5. Make sure that the number and sizes of vias allow enough copper for a given current path.

See the EVM design for the recommended component placement with trace and via locations.

### 4.3 Bill of Materials (BOM)

**Table 4-1. Bill of Materials**

Designator	Qty	Value	Description	Package Reference	PartNumber	Manufacturer
!PCB1	1		Printed Circuit Board		BMS106	
C2	1	1uF	CAP, CERM, 1uF, 35V, +/- 10%, X7R, AEC-Q200 Grade 0, 0603	603	GMK107AB7105KAHT	Taiyo Yuden
C5	1	0.047uF	CAP, CERM, 0.047uF, 25V, +/- 10%, X7R, 0402	402	GRM155R71E473KA88D	MuRata
C11	1	4.7uF	4.7uF +/-20% 16V Ceramic Capacitor X5R 0402 (1005 Metric)	402	0402YD475MAT2A	KYOCERA AVX
C7, C8, C18	3	10uF	Chip Multilayer Ceramic Capacitors for General Purpose, 0603, 10uF, X7T, +22%/-33%, 10%, 10V	603	GRM188D71A106KA73D	MuRata
C15	1	10uF	CAP, CERM, 10uF, 25V, +/- 20%, X5R, 0603	603	GRT188R61E106ME13D	MuRata
C16, C20	2	0.1uF	CAP, CERM, 0.1uF, 50V, +/- 10%, X7R, 0402	402	C1005X7R1H104K050BE	TDK
D4	1	Green	LED, Green, SMD	1.6x0.8x0.8mm	LTST-C190GKT	Lite-On
FID1, FID2, FID3, FID4, FID5, FID6	6		Fiducial mark. There is nothing to buy or mount.	N/A	N/A	N/A
H1, H2, H3, H4	4		Bumpon, Hemisphere, 0.44 x 0.20, Clear	Transparent Bumpon	SJ-5303 (CLEAR)	3M
J1, J2, J3	3		Terminal Block, 5.08mm, 2x1, Brass, TH	2x1 5.08mm Terminal Block	ED120/2DS	On-Shore Technology
J4	1		Terminal Block, 5.08mm, 3x1, Brass, TH	3x1 5.08mm Terminal Block	ED120/3DS	On-Shore Technology
J7	1		Connector, Receptacle, USB Type C, R/A, THT/SMT	8.54x2.96x11.2mm	632723300011	Würth Elektronik
J8	1		Header, 2.54mm, 4x1, Gold, TH	4x1 Header	61300411121	Würth Elektronik
J6	1		Header (shrouded), 100mil, 5x2, High-Temperature, Gold, TH	5x2 Shrouded header	N2510-6002-RB	3M
J5	1		Header (friction lock), 100mil, 4x1, R/A, TH	4x1 R/A Header	22053041	Molex
JP1, JP2, JP3, JP4, JP5, JP6, JP10, JP13, JP17, JP18	10		Header, 100mil, 2x1, Tin, TH	Header, 2 PIN, 100mil, Tin	PEC02SAAN	Sullins Connector Solutions
JP9, JP11, JP12, JP19	4		Header, 100mil, 3x1, Tin, TH	Header, 3 PIN, 100mil, Tin	PEC03SAAN	Sullins Connector Solutions
L1	1	1uH	Inductor Shielded wirewound 1uH 20% 6.7A 0.019Ω DCR 1210	1210	DFE322520F-1R0M=P2	MuRata
LBL1	1		Thermal Transfer Printable Labels, 0.650" W x 0.200" H - 10,000 per roll	PCB Label 0.650 x 0.200 inch	THT-14-423-10	Brady
R1, R4, R7, R9	4	0.01	RES, 0.01, 1%, 1 W, 2010	2010	WSL2010R0100FEA18	Vishay-Dale

**Table 4-1. Bill of Materials (continued)**

Designator	Qty	Value	Description	Package Reference	PartNumber	Manufacturer
R16, R18, R20, R23	4	10.0k	RES, 10.0k, 1%, 0.063W, AEC-Q200 Grade 0, 0402	402	CRCW040210K0FKED	Vishay-Dale
R13, R14, R21	3	2.20k	RES, 2.20k, 1%, 0.063W, AEC-Q200 Grade 0, 0402	402	CRCW04022K20FKED	Vishay-Dale
R27	1	10	RES, 10.0, 1%, 0.25W, AEC-Q200 Grade 0, 1206	1206	CRCW120610R0FKEA	Vishay-Dale
R17	1	5.23k	RES, 5.23k, 1%, 0.063W, AEC-Q200 Grade 0, 0402	402	CRCW04025K23FKED	Vishay-Dale
R15	1	4.7k	RES, 4.7k, 5%, 0.063W, AEC-Q200 Grade 0, 0402	402	CRCW04024K70JNED	Vishay-Dale
R19	1	30.1k	RES, 30.1k, 1%, 0.063W, AEC-Q200 Grade 0, 0402	402	CRCW040230K1FKED	Vishay-Dale
R12	1	100	RES, 100, 1%, 0.25W, AEC-Q200 Grade 0, 1206	1206	CRCW1206100RFKEA	Vishay-Dale
R6	1	0	RES, 0, 1%, 0.5W, 0805	0805	5106	Keystone
S1	1		Switch, Normally open, 2.3N force, 200k operations, SMD	KSR	KSR221GLFS	C&K Components
SH-JP1, SH-JP2, SH-JP3, SH-JP4, SH-JP5, SH-JP9, SH-JP10, SH-JP11, SH-JP12, SH-JP13, SH-JP17, SH-JP18, SH-JP19	13	1x2	Shunt, 100mil, Gold plated, Black	Shunt	SNT-100-BK-G	Samtec
TP1, TP2, TP3, TP4, TP5, TP6, TP7, TP8, TP16, TP17, TP18, TP19, TP20, TP21, TP22, TP23, TP24, TP25, TP29, TP30	20		Test Point, Miniature, White, TH	White Miniature Testpoint	5002	Keystone Electronics
TP9, TP10, TP11, TP12, TP26, TP28	6		Test Point, Miniature, Red, TH	Red Miniature Testpoint	5000	Keystone Electronics
TP13	1		Test Point, Miniature, Yellow, TH	Yellow Miniature Testpoint	5004	Keystone Electronics
TP14, TP15, TP27	3		Test Point, Miniature, Orange, TH	Orange Miniature Testpoint	5003	Keystone Electronics
TP31, TP32, TP33, TP34	4		Test Point, Multipurpose, Black, TH	Black Multipurpose Testpoint	5011	Keystone Electronics
TP35, TP36, TP37	3		Test Point, Compact, SMT	Testpoint_Keystone_Compact	5016	Keystone Electronics

**Table 4-1. Bill of Materials (continued)**

Designator	Qty	Value	Description	Package Reference	PartNumber	Manufacturer
U1	1		I2C Controlled, 5A, Maximum 18V Input, Charger with NVDC Power Path Management and USB Type-C Detection	WQFN 22	BQ25640VDLR	Texas Instruments

## 5 Additional Information

### Trademarks

All trademarks are the property of their respective owners.

## STANDARD TERMS FOR EVALUATION MODULES

1. *Delivery:* TI delivers TI evaluation boards, kits, or modules, including any accompanying demonstration software, components, and/or documentation which may be provided together or separately (collectively, an "EVM" or "EVMs") to the User ("User") in accordance with the terms set forth herein. User's acceptance of the EVM is expressly subject to the following terms.
  - 1.1 EVMs are intended solely for product or software developers for use in a research and development setting to facilitate feasibility evaluation, experimentation, or scientific analysis of TI semiconductors products. EVMs have no direct function and are not finished products. EVMs shall not be directly or indirectly assembled as a part or subassembly in any finished product. For clarification, any software or software tools provided with the EVM ("Software") shall not be subject to the terms and conditions set forth herein but rather shall be subject to the applicable terms that accompany such Software
  - 1.2 EVMs are not intended for consumer or household use. EVMs may not be sold, sublicensed, leased, rented, loaned, assigned, or otherwise distributed for commercial purposes by Users, in whole or in part, or used in any finished product or production system.
2. *Limited Warranty and Related Remedies/Disclaimers:*
  - 2.1 These terms do not apply to Software. The warranty, if any, for Software is covered in the applicable Software License Agreement.
  - 2.2 TI warrants that the TI EVM will conform to TI's published specifications for ninety (90) days after the date TI delivers such EVM to User. Notwithstanding the foregoing, TI shall not be liable for a nonconforming EVM if (a) the nonconformity was caused by neglect, misuse or mistreatment by an entity other than TI, including improper installation or testing, or for any EVMs that have been altered or modified in any way by an entity other than TI, (b) the nonconformity resulted from User's design, specifications or instructions for such EVMs or improper system design, or (c) User has not paid on time. Testing and other quality control techniques are used to the extent TI deems necessary. TI does not test all parameters of each EVM. User's claims against TI under this Section 2 are void if User fails to notify TI of any apparent defects in the EVMs within ten (10) business days after delivery, or of any hidden defects with ten (10) business days after the defect has been detected.
  - 2.3 TI's sole liability shall be at its option to repair or replace EVMs that fail to conform to the warranty set forth above, or credit User's account for such EVM. TI's liability under this warranty shall be limited to EVMs that are returned during the warranty period to the address designated by TI and that are determined by TI not to conform to such warranty. If TI elects to repair or replace such EVM, TI shall have a reasonable time to repair such EVM or provide replacements. Repaired EVMs shall be warranted for the remainder of the original warranty period. Replaced EVMs shall be warranted for a new full ninety (90) day warranty period.

### **WARNING**

**Evaluation Kits are intended solely for use by technically qualified, professional electronics experts who are familiar with the dangers and application risks associated with handling electrical mechanical components, systems, and subsystems.**

**User shall operate the Evaluation Kit within TI's recommended guidelines and any applicable legal or environmental requirements as well as reasonable and customary safeguards. Failure to set up and/or operate the Evaluation Kit within TI's recommended guidelines may result in personal injury or death or property damage. Proper set up entails following TI's instructions for electrical ratings of interface circuits such as input, output and electrical loads.**

**NOTE:**

**EXPOSURE TO ELECTROSTATIC DISCHARGE (ESD) MAY CAUSE DEGRADATION OR FAILURE OF THE EVALUATION KIT; TI RECOMMENDS STORAGE OF THE EVALUATION KIT IN A PROTECTIVE ESD BAG.**

### 3 Regulatory Notices:

#### 3.1 United States

##### 3.1.1 Notice applicable to EVMs not FCC-Approved:

**FCC NOTICE:** This kit is designed to allow product developers to evaluate electronic components, circuitry, or software associated with the kit to determine whether to incorporate such items in a finished product and software developers to write software applications for use with the end product. This kit is not a finished product and when assembled may not be resold or otherwise marketed unless all required FCC equipment authorizations are first obtained. Operation is subject to the condition that this product not cause harmful interference to licensed radio stations and that this product accept harmful interference. Unless the assembled kit is designed to operate under part 15, part 18 or part 95 of this chapter, the operator of the kit must operate under the authority of an FCC license holder or must secure an experimental authorization under part 5 of this chapter.

##### 3.1.2 For EVMs annotated as FCC – FEDERAL COMMUNICATIONS COMMISSION Part 15 Compliant:

#### **CAUTION**

This device complies with part 15 of the FCC Rules. Operation is subject to the following two conditions: (1) This device may not cause harmful interference, and (2) this device must accept any interference received, including interference that may cause undesired operation.

Changes or modifications not expressly approved by the party responsible for compliance could void the user's authority to operate the equipment.

#### **FCC Interference Statement for Class A EVM devices**

*NOTE: This equipment has been tested and found to comply with the limits for a Class A digital device, pursuant to part 15 of the FCC Rules. These limits are designed to provide reasonable protection against harmful interference when the equipment is operated in a commercial environment. This equipment generates, uses, and can radiate radio frequency energy and, if not installed and used in accordance with the instruction manual, may cause harmful interference to radio communications. Operation of this equipment in a residential area is likely to cause harmful interference in which case the user will be required to correct the interference at his own expense.*

#### **FCC Interference Statement for Class B EVM devices**

*NOTE: This equipment has been tested and found to comply with the limits for a Class B digital device, pursuant to part 15 of the FCC Rules. These limits are designed to provide reasonable protection against harmful interference in a residential installation. This equipment generates, uses and can radiate radio frequency energy and, if not installed and used in accordance with the instructions, may cause harmful interference to radio communications. However, there is no guarantee that interference will not occur in a particular installation. If this equipment does cause harmful interference to radio or television reception, which can be determined by turning the equipment off and on, the user is encouraged to try to correct the interference by one or more of the following measures:*

- Reorient or relocate the receiving antenna.
- Increase the separation between the equipment and receiver.
- Connect the equipment into an outlet on a circuit different from that to which the receiver is connected.
- Consult the dealer or an experienced radio/TV technician for help.

#### 3.2 Canada

##### 3.2.1 For EVMs issued with an Industry Canada Certificate of Conformance to RSS-210 or RSS-247

#### **Concerning EVMs Including Radio Transmitters:**

This device complies with Industry Canada license-exempt RSSs. Operation is subject to the following two conditions:

(1) this device may not cause interference, and (2) this device must accept any interference, including interference that may cause undesired operation of the device.

#### **Concernant les EVMs avec appareils radio:**

Le présent appareil est conforme aux CNR d'Industrie Canada applicables aux appareils radio exempts de licence. L'exploitation est autorisée aux deux conditions suivantes: (1) l'appareil ne doit pas produire de brouillage, et (2) l'utilisateur de l'appareil doit accepter tout brouillage radioélectrique subi, même si le brouillage est susceptible d'en compromettre le fonctionnement.

#### **Concerning EVMs Including Detachable Antennas:**

Under Industry Canada regulations, this radio transmitter may only operate using an antenna of a type and maximum (or lesser) gain approved for the transmitter by Industry Canada. To reduce potential radio interference to other users, the antenna type and its gain should be so chosen that the equivalent isotropically radiated power (e.i.r.p.) is not more than that necessary for successful communication. This radio transmitter has been approved by Industry Canada to operate with the antenna types listed in the user guide with the maximum permissible gain and required antenna impedance for each antenna type indicated. Antenna types not included in this list, having a gain greater than the maximum gain indicated for that type, are strictly prohibited for use with this device.

### Concernant les EVMs avec antennes détachables

Conformément à la réglementation d'Industrie Canada, le présent émetteur radio peut fonctionner avec une antenne d'un type et d'un gain maximal (ou inférieur) approuvé pour l'émetteur par Industrie Canada. Dans le but de réduire les risques de brouillage radioélectrique à l'intention des autres utilisateurs, il faut choisir le type d'antenne et son gain de sorte que la puissance isotrope rayonnée équivalente (p.i.r.e.) ne dépasse pas l'intensité nécessaire à l'établissement d'une communication satisfaisante. Le présent émetteur radio a été approuvé par Industrie Canada pour fonctionner avec les types d'antenne énumérés dans le manuel d'usage et ayant un gain admissible maximal et l'impédance requise pour chaque type d'antenne. Les types d'antenne non inclus dans cette liste, ou dont le gain est supérieur au gain maximal indiqué, sont strictement interdits pour l'exploitation de l'émetteur.

#### 3.3 Japan

3.3.1 *Notice for EVMs delivered in Japan:* Please see [http://www.tij.co.jp/lstds/ti\\_ja/general/eStore/notice\\_01.page](http://www.tij.co.jp/lstds/ti_ja/general/eStore/notice_01.page) 日本国内に輸入される評価用キット、ボードについては、次のところをご覧ください。

<https://www.ti.com/ja-jp/legal/notice-for-evaluation-kits-delivered-in-japan.html>

3.3.2 *Notice for Users of EVMs Considered "Radio Frequency Products" in Japan:* EVMs entering Japan may not be certified by TI as conforming to Technical Regulations of Radio Law of Japan.

If User uses EVMs in Japan, not certified to Technical Regulations of Radio Law of Japan, User is required to follow the instructions set forth by Radio Law of Japan, which includes, but is not limited to, the instructions below with respect to EVMs (which for the avoidance of doubt are stated strictly for convenience and should be verified by User):

1. Use EVMs in a shielded room or any other test facility as defined in the notification #173 issued by Ministry of Internal Affairs and Communications on March 28, 2006, based on Sub-section 1.1 of Article 6 of the Ministry's Rule for Enforcement of Radio Law of Japan,
2. Use EVMs only after User obtains the license of Test Radio Station as provided in Radio Law of Japan with respect to EVMs, or
3. Use of EVMs only after User obtains the Technical Regulations Conformity Certification as provided in Radio Law of Japan with respect to EVMs. Also, do not transfer EVMs, unless User gives the same notice above to the transferee. Please note that if User does not follow the instructions above, User will be subject to penalties of Radio Law of Japan.

【無線電波を送信する製品の開発キットをお使いになる際の注意事項】 開発キットの中には技術基準適合証明を受けていないものがあります。技術適合証明を受けていないものご使用に際しては、電波法遵守のため、以下のいずれかの措置を取っていただく必要がありますのでご注意ください。

1. 電波法施行規則第6条第1項第1号に基づく平成18年3月28日総務省告示第173号で定められた電波暗室等の試験設備でご使用いただく。
2. 実験局の免許を取得後ご使用いただく。
3. 技術基準適合証明を取得後ご使用いただく。

なお、本製品は、上記の「ご使用にあたっての注意」を譲渡先、移転先に通知しない限り、譲渡、移転できないものとします。

上記を遵守頂けない場合は、電波法の罰則が適用される可能性があることをご留意ください。日本テキサス・イ

ンスツルメンツ株式会社

東京都新宿区西新宿 6 丁目 2 4 番 1 号

西新宿三井ビル

3.3.3 *Notice for EVMs for Power Line Communication:* Please see [http://www.tij.co.jp/lstds/ti\\_ja/general/eStore/notice\\_02.page](http://www.tij.co.jp/lstds/ti_ja/general/eStore/notice_02.page)

電力線搬送波通信についての開発キットをお使いになる際の注意事項については、次のところをご覧ください。 <https://www.ti.com/ja-jp/legal/notice-for-evaluation-kits-for-power-line-communication.html>

#### 3.4 European Union

3.4.1 *For EVMs subject to EU Directive 2014/30/EU (Electromagnetic Compatibility Directive):*

This is a class A product intended for use in environments other than domestic environments that are connected to a low-voltage power-supply network that supplies buildings used for domestic purposes. In a domestic environment this product may cause radio interference in which case the user may be required to take adequate measures.

- 
- 4 *EVM Use Restrictions and Warnings:*
    - 4.1 EVMS ARE NOT FOR USE IN FUNCTIONAL SAFETY AND/OR SAFETY CRITICAL EVALUATIONS, INCLUDING BUT NOT LIMITED TO EVALUATIONS OF LIFE SUPPORT APPLICATIONS.
    - 4.2 User must read and apply the user guide and other available documentation provided by TI regarding the EVM prior to handling or using the EVM, including without limitation any warning or restriction notices. The notices contain important safety information related to, for example, temperatures and voltages.
    - 4.3 *Safety-Related Warnings and Restrictions:*
      - 4.3.1 User shall operate the EVM within TI's recommended specifications and environmental considerations stated in the user guide, other available documentation provided by TI, and any other applicable requirements and employ reasonable and customary safeguards. Exceeding the specified performance ratings and specifications (including but not limited to input and output voltage, current, power, and environmental ranges) for the EVM may cause personal injury or death, or property damage. If there are questions concerning performance ratings and specifications, User should contact a TI field representative prior to connecting interface electronics including input power and intended loads. Any loads applied outside of the specified output range may also result in unintended and/or inaccurate operation and/or possible permanent damage to the EVM and/or interface electronics. Please consult the EVM user guide prior to connecting any load to the EVM output. If there is uncertainty as to the load specification, please contact a TI field representative. During normal operation, even with the inputs and outputs kept within the specified allowable ranges, some circuit components may have elevated case temperatures. These components include but are not limited to linear regulators, switching transistors, pass transistors, current sense resistors, and heat sinks, which can be identified using the information in the associated documentation. When working with the EVM, please be aware that the EVM may become very warm.
      - 4.3.2 EVMs are intended solely for use by technically qualified, professional electronics experts who are familiar with the dangers and application risks associated with handling electrical mechanical components, systems, and subsystems. User assumes all responsibility and liability for proper and safe handling and use of the EVM by User or its employees, affiliates, contractors or designees. User assumes all responsibility and liability to ensure that any interfaces (electronic and/or mechanical) between the EVM and any human body are designed with suitable isolation and means to safely limit accessible leakage currents to minimize the risk of electrical shock hazard. User assumes all responsibility and liability for any improper or unsafe handling or use of the EVM by User or its employees, affiliates, contractors or designees.
    - 4.4 User assumes all responsibility and liability to determine whether the EVM is subject to any applicable international, federal, state, or local laws and regulations related to User's handling and use of the EVM and, if applicable, User assumes all responsibility and liability for compliance in all respects with such laws and regulations. User assumes all responsibility and liability for proper disposal and recycling of the EVM consistent with all applicable international, federal, state, and local requirements.
  5. *Accuracy of Information:* To the extent TI provides information on the availability and function of EVMs, TI attempts to be as accurate as possible. However, TI does not warrant the accuracy of EVM descriptions, EVM availability or other information on its websites as accurate, complete, reliable, current, or error-free.
  6. *Disclaimers:*
    - 6.1 EXCEPT AS SET FORTH ABOVE, EVMS AND ANY MATERIALS PROVIDED WITH THE EVM (INCLUDING, BUT NOT LIMITED TO, REFERENCE DESIGNS AND THE DESIGN OF THE EVM ITSELF) ARE PROVIDED "AS IS" AND "WITH ALL FAULTS." TI DISCLAIMS ALL OTHER WARRANTIES, EXPRESS OR IMPLIED, REGARDING SUCH ITEMS, INCLUDING BUT NOT LIMITED TO ANY EPIDEMIC FAILURE WARRANTY OR IMPLIED WARRANTIES OF MERCHANTABILITY OR FITNESS FOR A PARTICULAR PURPOSE OR NON-INFRINGEMENT OF ANY THIRD PARTY PATENTS, COPYRIGHTS, TRADE SECRETS OR OTHER INTELLECTUAL PROPERTY RIGHTS.
    - 6.2 EXCEPT FOR THE LIMITED RIGHT TO USE THE EVM SET FORTH HEREIN, NOTHING IN THESE TERMS SHALL BE CONSTRUED AS GRANTING OR CONFERRING ANY RIGHTS BY LICENSE, PATENT, OR ANY OTHER INDUSTRIAL OR INTELLECTUAL PROPERTY RIGHT OF TI, ITS SUPPLIERS/LICENSORS OR ANY OTHER THIRD PARTY, TO USE THE EVM IN ANY FINISHED END-USER OR READY-TO-USE FINAL PRODUCT, OR FOR ANY INVENTION, DISCOVERY OR IMPROVEMENT, REGARDLESS OF WHEN MADE, CONCEIVED OR ACQUIRED.
  7. *USER'S INDEMNITY OBLIGATIONS AND REPRESENTATIONS.* USER WILL DEFEND, INDEMNIFY AND HOLD TI, ITS LICENSORS AND THEIR REPRESENTATIVES HARMLESS FROM AND AGAINST ANY AND ALL CLAIMS, DAMAGES, LOSSES, EXPENSES, COSTS AND LIABILITIES (COLLECTIVELY, "CLAIMS") ARISING OUT OF OR IN CONNECTION WITH ANY HANDLING OR USE OF THE EVM THAT IS NOT IN ACCORDANCE WITH THESE TERMS. THIS OBLIGATION SHALL APPLY WHETHER CLAIMS ARISE UNDER STATUTE, REGULATION, OR THE LAW OF TORT, CONTRACT OR ANY OTHER LEGAL THEORY, AND EVEN IF THE EVM FAILS TO PERFORM AS DESCRIBED OR EXPECTED.
-

8. *Limitations on Damages and Liability:*

8.1 *General Limitations.* IN NO EVENT SHALL TI BE LIABLE FOR ANY SPECIAL, COLLATERAL, INDIRECT, PUNITIVE, INCIDENTAL, CONSEQUENTIAL, OR EXEMPLARY DAMAGES IN CONNECTION WITH OR ARISING OUT OF THESE TERMS OR THE USE OF THE EVMS , REGARDLESS OF WHETHER TI HAS BEEN ADVISED OF THE POSSIBILITY OF SUCH DAMAGES. EXCLUDED DAMAGES INCLUDE, BUT ARE NOT LIMITED TO, COST OF REMOVAL OR REINSTALLATION, ANCILLARY COSTS TO THE PROCUREMENT OF SUBSTITUTE GOODS OR SERVICES, RETESTING, OUTSIDE COMPUTER TIME, LABOR COSTS, LOSS OF GOODWILL, LOSS OF PROFITS, LOSS OF SAVINGS, LOSS OF USE, LOSS OF DATA, OR BUSINESS INTERRUPTION. NO CLAIM, SUIT OR ACTION SHALL BE BROUGHT AGAINST TI MORE THAN TWELVE (12) MONTHS AFTER THE EVENT THAT GAVE RISE TO THE CAUSE OF ACTION HAS OCCURRED.

8.2 *Specific Limitations.* IN NO EVENT SHALL TI'S AGGREGATE LIABILITY FROM ANY USE OF AN EVM PROVIDED HEREUNDER, INCLUDING FROM ANY WARRANTY, INDEMNITY OR OTHER OBLIGATION ARISING OUT OF OR IN CONNECTION WITH THESE TERMS, , EXCEED THE TOTAL AMOUNT PAID TO TI BY USER FOR THE PARTICULAR EVM(S) AT ISSUE DURING THE PRIOR TWELVE (12) MONTHS WITH RESPECT TO WHICH LOSSES OR DAMAGES ARE CLAIMED. THE EXISTENCE OF MORE THAN ONE CLAIM SHALL NOT ENLARGE OR EXTEND THIS LIMIT.

9. *Return Policy.* Except as otherwise provided, TI does not offer any refunds, returns, or exchanges. Furthermore, no return of EVM(s) will be accepted if the package has been opened and no return of the EVM(s) will be accepted if they are damaged or otherwise not in a resalable condition. If User feels it has been incorrectly charged for the EVM(s) it ordered or that delivery violates the applicable order, User should contact TI. All refunds will be made in full within thirty (30) working days from the return of the components(s), excluding any postage or packaging costs.

10. *Governing Law:* These terms and conditions shall be governed by and interpreted in accordance with the laws of the State of Texas, without reference to conflict-of-laws principles. User agrees that non-exclusive jurisdiction for any dispute arising out of or relating to these terms and conditions lies within courts located in the State of Texas and consents to venue in Dallas County, Texas. Notwithstanding the foregoing, any judgment may be enforced in any United States or foreign court, and TI may seek injunctive relief in any United States or foreign court.

Mailing Address: Texas Instruments, Post Office Box 655303, Dallas, Texas 75265  
Copyright © 2023, Texas Instruments Incorporated

## IMPORTANT NOTICE AND DISCLAIMER

TI PROVIDES TECHNICAL AND RELIABILITY DATA (INCLUDING DATASHEETS), DESIGN RESOURCES (INCLUDING REFERENCE DESIGNS), APPLICATION OR OTHER DESIGN ADVICE, WEB TOOLS, SAFETY INFORMATION, AND OTHER RESOURCES "AS IS" AND WITH ALL FAULTS, AND DISCLAIMS ALL WARRANTIES, EXPRESS AND IMPLIED, INCLUDING WITHOUT LIMITATION ANY IMPLIED WARRANTIES OF MERCHANTABILITY, FITNESS FOR A PARTICULAR PURPOSE OR NON-INFRINGEMENT OF THIRD PARTY INTELLECTUAL PROPERTY RIGHTS.

These resources are intended for skilled developers designing with TI products. You are solely responsible for (1) selecting the appropriate TI products for your application, (2) designing, validating and testing your application, and (3) ensuring your application meets applicable standards, and any other safety, security, regulatory or other requirements.

These resources are subject to change without notice. TI grants you permission to use these resources only for development of an application that uses the TI products described in the resource. Other reproduction and display of these resources is prohibited. No license is granted to any other TI intellectual property right or to any third party intellectual property right. TI disclaims responsibility for, and you fully indemnify TI and its representatives against any claims, damages, costs, losses, and liabilities arising out of your use of these resources.

TI's products are provided subject to [TI's Terms of Sale](#), [TI's General Quality Guidelines](#), or other applicable terms available either on [ti.com](http://ti.com) or provided in conjunction with such TI products. TI's provision of these resources does not expand or otherwise alter TI's applicable warranties or warranty disclaimers for TI products. Unless TI explicitly designates a product as custom or customer-specified, TI products are standard, catalog, general purpose devices.

TI objects to and rejects any additional or different terms you may propose.

Copyright © 2026, Texas Instruments Incorporated

Last updated 10/2025