



Hermon Laboratories Ltd.
Harakevet Industrial Zone, Binyamina 30500,
Israel
Tel. +972-4-6288001
Fax. +972-4-6288277
E-mail: mail@hermonlabs.com

PARTIAL RADIATED EMISSIONS AND RADIATED IMMUNITY TEST REPORT

ACCORDING TO: EN 300 386 V1.4.1: 2008 with manufacturer's deviations:
Radiated immunity of 10 V/m in 80 – 1000 MHz range

FOR:

**Texas Instruments (Israel) Cable
Broadband Com.**

**TI chip, model TLK106 32p QFN
placed on Evaluation board,
model Pc483**

This report is in conformity with ISO/IEC 17025. The "A2LA Accredited" symbol endorsement applies only to the tests and calibrations that are listed in the scope of Hermon Laboratories accreditation. The test results relate only to the items tested.
This test report shall not be reproduced in any form except in full with the written approval of Hermon Laboratories Ltd.

Table of contents

1	Applicant information.....	3
2	Equipment under test attributes	3
3	Manufacturer information	3
4	Test details.....	3
5	Tests summary.....	4
6	EUT description.....	5
6.1	General information.....	5
6.2	Ports and lines	5
6.3	Support and test equipment	5
6.4	Test configuration.....	6
6.5	Performance criteria.....	7
6.6	Acceptance criteria.....	7
7	Emissions tests	8
7.1	Radiated disturbance	8
8	Immunity tests.....	19
8.1	Radiated immunity to radio frequency electromagnetic field	19
9	APPENDIX A Test equipment and ancillaries used for tests.....	25
10	APPENDIX B Measurement uncertainties.....	26
11	APPENDIX C Test laboratory description	27
12	APPENDIX D Specification references	27
13	APPENDIX E Test equipment correction factors.....	28
14	APPENDIX F Abbreviations and acronyms.....	30



1 Applicant information

Client name: Texas Instruments (Israel) Cable Broadband Com.
Address: 26 Zarchin Street, 43662 Raanana, Israel
Telephone: +972 9970 6969
Fax: +972 9970 6500
E-mail: noam.sadan@ti.com
Contact name: Mr. Noam Sadan

2 Equipment under test attributes

Product name: TI chip, model TLK106 32p QFN placed on Evaluation board, model Pc483
Model(s): TLK106 32p QFN
Serial number: 59904
Hardware version: 1
Software release: 1
Receipt date: 12/11/2012

3 Manufacturer information

Manufacturer name: Texas Instruments (Israel) Cable Broadband Com.
Address: 26 Zarchin Street, 43662 Raanana, Israel
Telephone: +972 9970 6969
Fax: +972 9970 6500
E-Mail: noam.sadan@ti.com
Contact name: Mr. Noam Sadan

4 Test details

Project ID: 23556
Location: Hermon Laboratories Ltd. Harakevet Industrial Zone, Binyamina 30500, Israel
Test started: 12/11/2012
Test completed: 12/12/2012
Test specification(s): EN 300 386 V1.4.1: 2008 with manufacturer's deviations:
Radiated immunity of 10 V/m in 80 – 1000 MHz range



5 Tests summary

Test	Status
EN 300 386 with manufacturer's deviations	
Radiated emissions, Class B	Pass preliminary test
Radiated immunity to radio frequency electromagnetic field of 10 V/m in 80 – 1000 MHz range	Pass preliminary test

The test results relate only to the items tested.

	Name and Title	Date	Signature
Tested by:	Mr. V. Dorofeyev, test engineer	December 12, 2012	
Reviewed by:	Mrs. M. Cherniavsky, certification engineer	April 15, 2013	
Approved by:	Mr. M. Nikishin, EMC and radio group manager	May 5, 2013	



6 EUT description

6.1 General information

The EUT is TI chip (Ethernet device) placed on the evaluation board enclosed in a metal enclosure. The EUT is powered from 5 VDC.

6.2 Ports and lines

Port type	Port description	Connected from	Connected to	Qty.	Cable type	Cable length, m
Signal	Ethernet	EUT	External loopback	1	Shielded	2.5
Control	USB	Laptop	USB2MII Board (FPGA Board)	1	Shielded	5

6.3 Support and test equipment

Description	Manufacturer	Model number	Serial number
Laptop	Dell	D630	E0101139-00
USB2MII Board (FPGA Board)	Texas instruments	Pc126	42662

6.4 Test configuration

6.4.1 EUT setup for radiation through cable

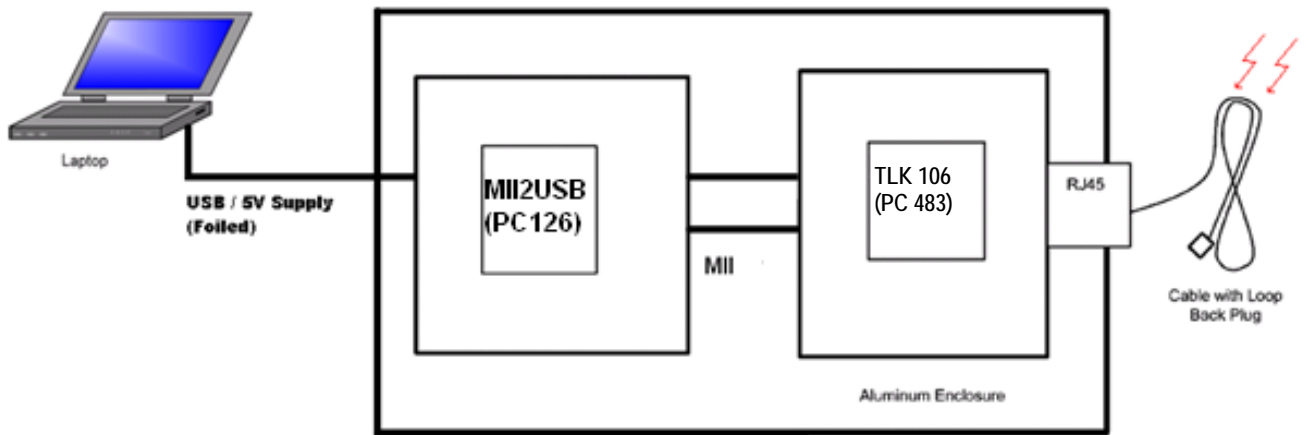

6.4.2 EUT setup for radiation from the EUT pins

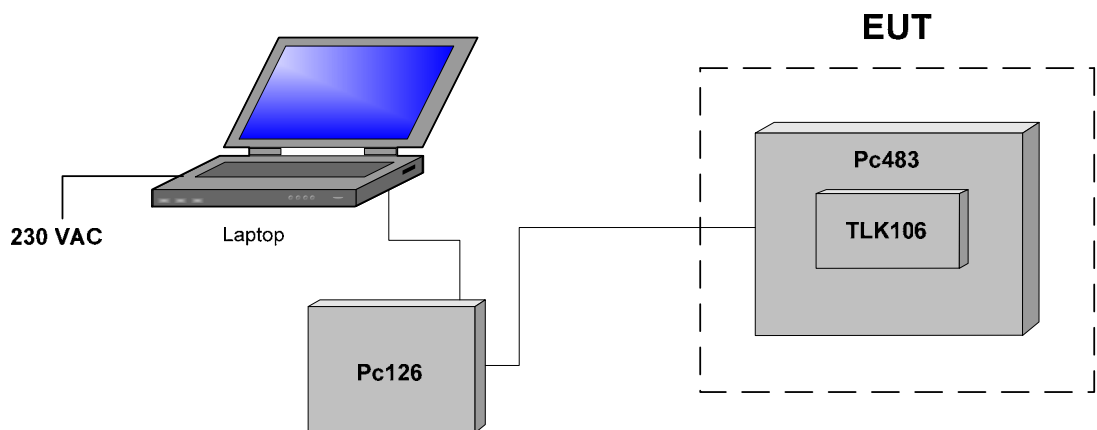

6.5 Performance criteria

6.5.1 General performance criteria of EN 300 386, Section 10

6.5.1.1 Performance criterion A

The equipment shall continue to operate as intended. No degradation of performance or loss of function is allowed below a performance level specified by the manufacturer when the equipment is used as intended. The performance level may be replaced by a permissible loss of performance. If the manufacturer does not specify the minimum performance level or the permissible performance loss, then either of these may be derived from the product description and documentation, and by what the user may reasonably expect from the equipment if used as intended.

6.5.2 Specific performance criteria of EN 300 386, Section 11 (Switching equipment specific requirements)

6.5.2.1 11.3.1 Digital ports

Performance criterion A:

During the sweep:

- the established connections shall be maintained throughout testing and the transfer of information shall be within the limits of the manufacturer's specification;
- loss of frame alignment or loss of synchronization is not allowed during each individual exposure.

For selected frequencies :

- it shall be possible to establish a connection between two ports;
- it shall be possible to clear a connection in a controlled manner.

6.5.3 Specific performance criteria of EN 300 386, Section 12 (Transmission equipment specific requirements)

6.5.3.1 12.3.1 Digital signal ports

Performance criterion A:

The performance of the equipment shall be verified by measuring the additional errors induced due to the application of any electromagnetic phenomena. During the test sweep the established connection shall be maintained throughout the testing and the transfer of information shall be without any reproducible bit errors. If degradation in performance is observed and the system is adaptive i.e. has capability to automatically re-train in the presence of an interfering signal, then for conducted immunity tests only the following procedure shall be followed:

- For each range of interfering frequencies, where degradation in performance is observed, three frequencies (beginning, middle and end) shall be identified.
- At each of the frequencies identified in step 1, the interfering signal shall be turned and the system allowed to re-train. If the system is able to re-train and then function with respect to the performance criteria A then the system performance is considered acceptable.
- The frequencies identified in step 1 shall be recorded in the test report.

6.6 Acceptance criteria

Data packets shall be transmitted from TI chip, using its internal PRBS generator to an external loopback, which returns the packets to TI chip to compare to transmitted packets. No data packets error is allowed during the test.

Test specification:		Section 6 Class B, Radiated disturbance	
Test procedure:		EN 55022, Section 10	
Test mode:		Compliance	
Date(s):		12/12/2012	
Temperature: 23 °C		Air Pressure: 1015 hPa	
		Relative Humidity: 39 %	
		Power Supply: 5 VDC	
Remarks:			

7 Emissions tests

7.1 Radiated disturbance

7.1.1 General

This test was performed to measure radiated disturbance from the EUT enclosure. The specification test limits are given in Table 7.1.1.

Table 7.1.1 Radiated disturbance limits

Frequency, MHz	Class B limit, dB(μV/m)			
	Peak @3 m	Quasi-peak		Average @3 m
		@10 m	@3 m	
30 - 230	—	30.0	40.5*	—
230 - 1000	—	37.0	47.5*	—
1000 – 3000	70	—	—	50
3000 - 6000	74	—	—	54

* The limit for test distance other than specified was calculated using the inverse linear distance extrapolation factor as follows: $Lim_{S_2} = Lim_{S_1} + 20 \log(S_1/S_2)$, where S_1 and S_2 – standard defined and test distance respectively in meters.

7.1.2 Test procedure

7.1.2.1 The EUT was set up as shown in Figure 7.1.1 and the associated photographs, energized and the EUT performance was checked.

7.1.2.2 The preliminary measurements were performed in the anechoic chamber at 3 m test distance. The specified frequency range was investigated with the antenna connected to the EMI receiver. To find maximum radiation the turntable was rotated 360° and the measuring antenna height was swept from 1 to 4 m in both, vertical and horizontal polarizations.

7.1.2.3 The worst test results for radiation through cable with respect to the limits were recorded in Table 7.1.2 and shown in the associated plots.

7.1.2.4 The test was repeated for evaluation of radiation from pins, the test results are shown in the associated plots.

Test specification: Section 6 Class B, Radiated disturbance			
Test procedure: EN 55022, Section 10			
Test mode: Compliance		Verdict: PASS	
Date(s): 12/12/2012			
Temperature: 23 °C	Air Pressure: 1015 hPa	Relative Humidity: 39 %	Power Supply: 5 VDC
Remarks:			

Figure 7.1.1 Setup for radiated emissions measurements in anechoic chamber, table-top EUT

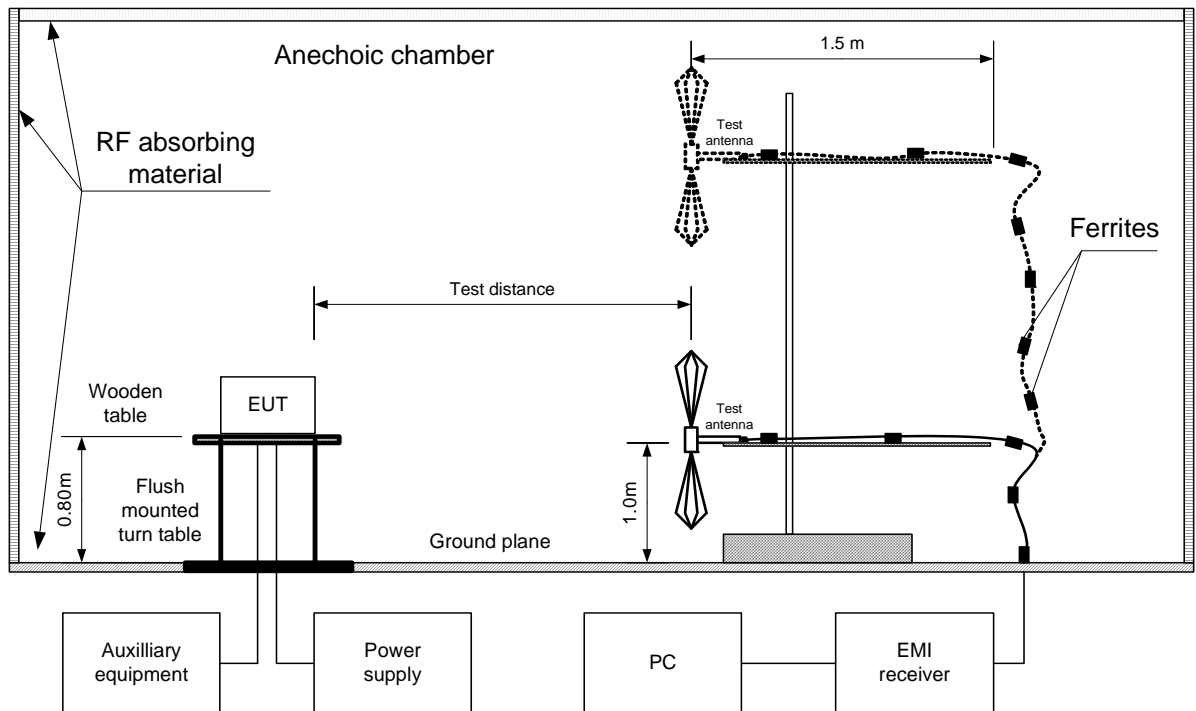

Test specification:	Section 6 Class B, Radiated disturbance		
Test procedure:	EN 55022, Section 10		
Test mode:	Compliance	Verdict:	PASS
Date(s):	12/12/2012		
Temperature: 23 °C	Air Pressure: 1015 hPa	Relative Humidity: 39 %	Power Supply: 5 VDC
Remarks:			

Photograph 7.1.1 Setup for preliminary radiated disturbance measurements, general view, EUT radiation through cable



Photograph 7.1.2 Setup for preliminary radiated disturbance measurements, general view, EUT radiation through cable



Test specification:	Section 6 Class B, Radiated disturbance		
Test procedure:	EN 55022, Section 10		
Test mode:	Compliance	Verdict:	PASS
Date(s):	12/12/2012		
Temperature: 23 °C	Air Pressure: 1015 hPa	Relative Humidity: 39 %	Power Supply: 5 VDC
Remarks:			

Photograph 7.1.3 Setup for radiated disturbance measurements, EUT radiation through cable

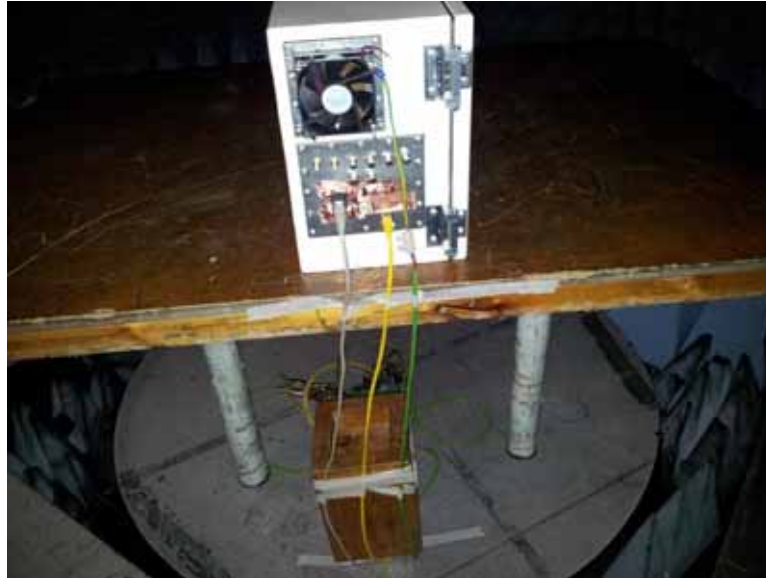

Photograph 7.1.4 Setup for radiated disturbance measurements, EUT close view





HERMON LABORATORIES

Test specification: Section 6 Class B, Radiated disturbance			
Test procedure: EN 55022, Section 10			
Test mode: Compliance		Verdict: PASS	
Date(s): 12/12/2012			
Temperature: 23 °C	Air Pressure: 1015 hPa	Relative Humidity: 39 %	Power Supply: 5 VDC
Remarks:			

Table 7.1.2 Radiated disturbance test results

EUT SET UP: TABLE-TOP
 TEST SITE: Fully anechoic chamber
 TEST DISTANCE: 3 m
 DETECTORS USED: PEAK / QUASI-PEAK
 FREQUENCY RANGE: 30 MHz – 1000 MHz
 RESOLUTION BANDWIDTH: 120 kHz

TLK106 32p QFN radiation through cable

Frequency, MHz	Peak emission, dB(μV/m)	Quasi-peak			Antenna polarization	Antenna height, m	Turn-table position**, degrees	Verdict
		Measured emission, dB(μV/m)	Limit, dB(μV/m)	Margin, to peak dB*				
32.41	37.97	Note*	40.5	-5.56	Vertical	Note*	Note*	Pass*
171.87	29.97	Note*	40.5	-10.53	Horizontal	Note*	Note*	

*Note: Quasi-peak emission was not measured

DETECTORS USED: PEAK / AVERAGE
 FREQUENCY RANGE: 1000 MHz – 2900 MHz
 RESOLUTION BANDWIDTH: 1000 kHz
 TEST SITE: Fully anechoic chamber
 TEST DISTANCE: 3 m

TLK106 32p QFN radiation through cable

Frequency, MHz	Peak			Average			Antenna polarization	Antenna height, m	Turn-table position**, degrees	Verdict
	Measured emission, dB(μV/m)	Limit, dB(μV/m)	Margin, dB*	Measured emission, dB(μV/m)	Limit, dB(μV/m)	Margin, dB*				
No emissions were found										Pass

Reference numbers of test equipment used

HL 2432	HL 2697	HL 4150	HL 4347	HL 4349			
---------	---------	---------	---------	---------	--	--	--

Full description is given in Appendix A.

Test specification:		Section 6 Class B, Radiated disturbance	
Test procedure:		EN 55022, Section 10	
Test mode:		Compliance	
Date(s):		12/12/2012	
Temperature: 23 °C		Air Pressure: 1015 hPa	
Relative Humidity: 39 %		Power Supply: 5 VDC	
Remarks:			
		Verdict: PASS	

Plot 7.1.1 Radiated disturbance measurements in 30 - 1000 MHz range, vertical antenna polarization

TEST SITE: Fully anechoic chamber
TEST DISTANCE: 3 m

TLK106 32p QFN radiation through cable

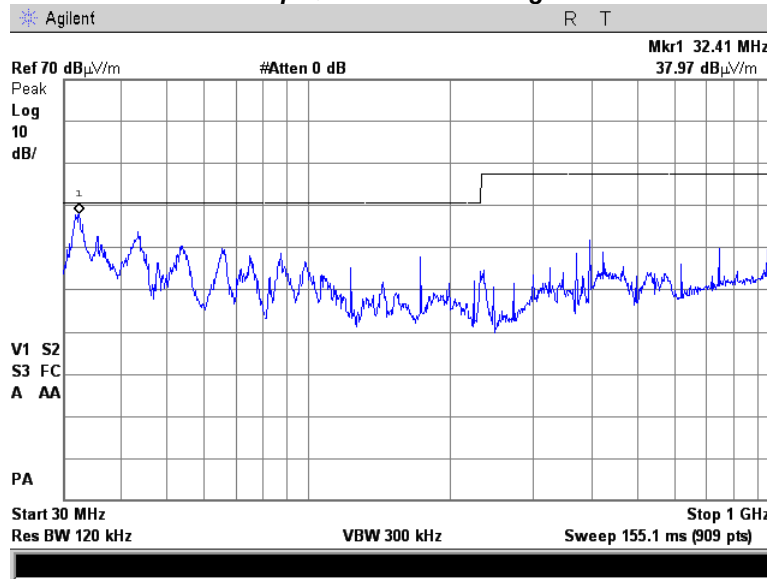

Plot 7.1.2 Radiated disturbance measurements in 30 - 1000 MHz range, horizontal antenna polarization

TEST SITE: Fully anechoic chamber
TEST DISTANCE: 3 m

TLK106 32p QFN radiation through cable

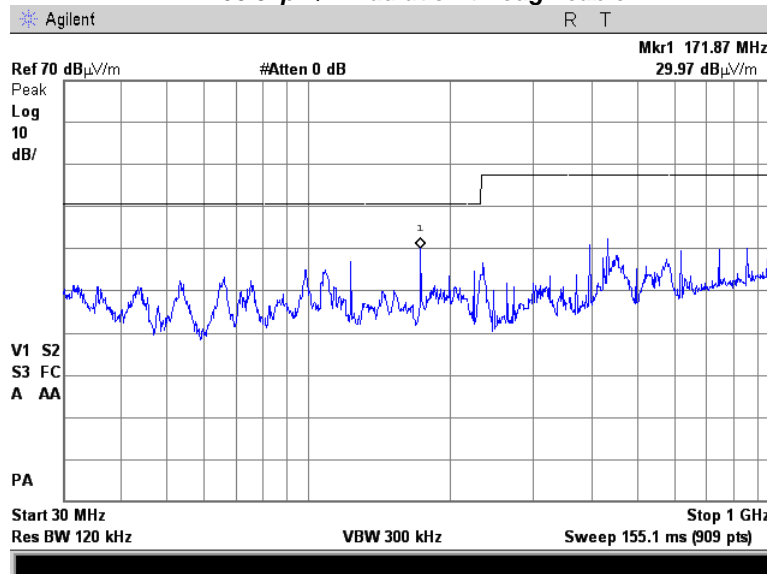

Test specification:		Section 6 Class B, Radiated disturbance	
Test procedure:		EN 55022, Section 10	
Test mode:		Compliance	
Date(s):		12/12/2012	
Temperature: 23 °C		Air Pressure: 1015 hPa	
		Relative Humidity: 39 %	
		Power Supply: 5 VDC	
Remarks:			

Plot 7.1.3 Radiated disturbance measurements in 1000 – 2900 MHz range, vertical antenna polarization

TEST SITE: Fully anechoic chamber
TEST DISTANCE: 3 m

TLK106 32p QFN radiation through cable

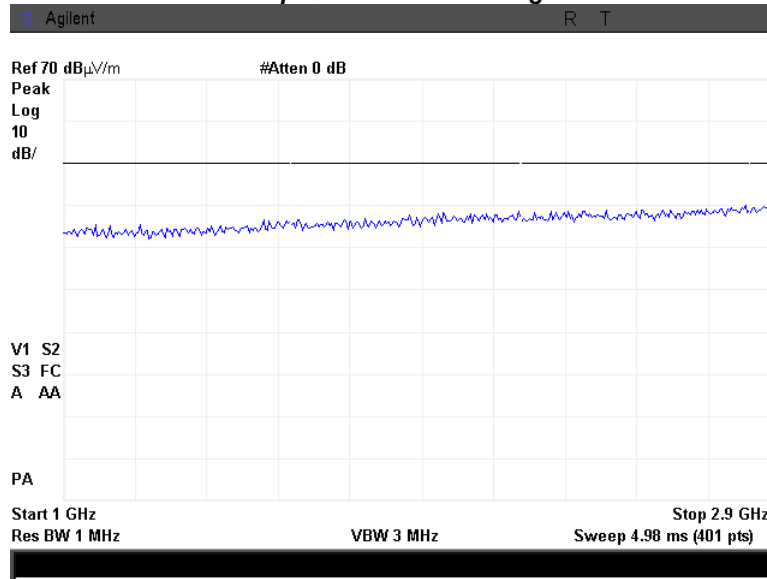

Plot 7.1.4 Radiated disturbance measurements in 1000 – 2900 MHz range, horizontal antenna polarization

TEST SITE: Fully anechoic chamber
TEST DISTANCE: 3 m

TLK106 32p QFN radiation through cable

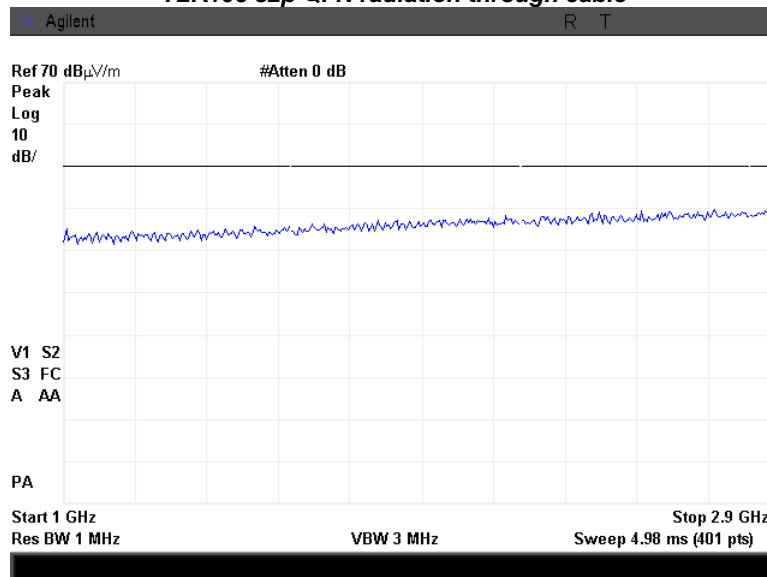

Test specification:	Section 6 Class B, Radiated disturbance		
Test procedure:	EN 55022, Section 10		
Test mode:	Compliance	Verdict:	PASS
Date(s):	12/12/2012		
Temperature: 23 °C	Air Pressure: 1015 hPa	Relative Humidity: 39 %	Power Supply: 5 VDC
Remarks:			

Photograph 7.1.5 Setup for radiated disturbance measurements, radiation from EUT pins

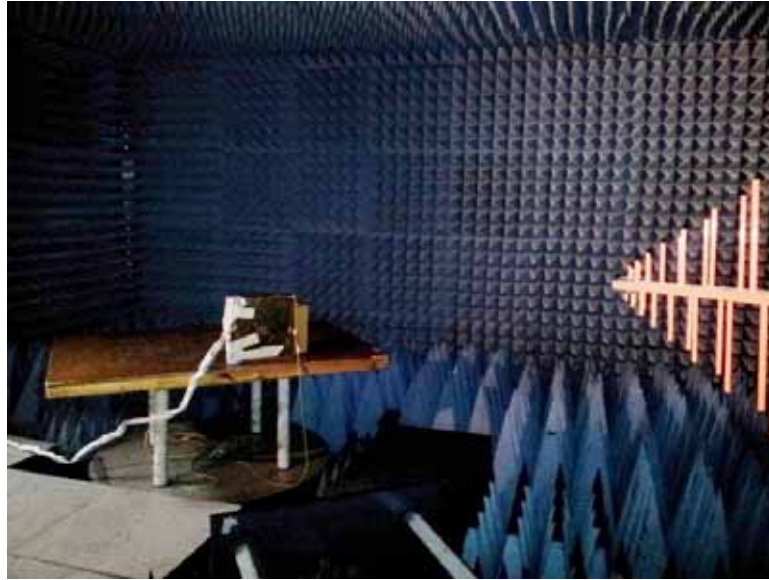

Photograph 7.1.6 Setup for radiated disturbance measurements, radiation from EUT pins

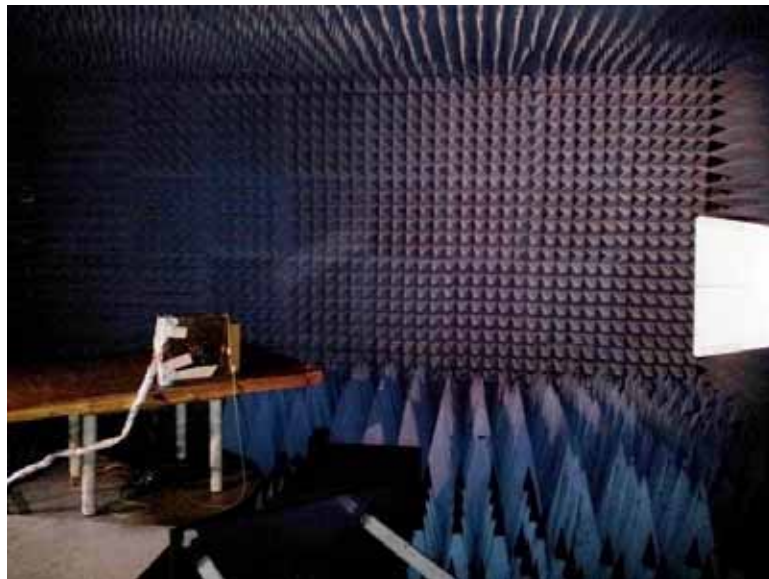



HERMON LABORATORIES

Test specification:	Section 6 Class B, Radiated disturbance		
Test procedure:	EN 55022, Section 10		
Test mode:	Compliance	Verdict:	PASS
Date(s):	12/12/2012		
Temperature: 23 °C	Air Pressure: 1015 hPa	Relative Humidity: 39 %	Power Supply: 5 VDC
Remarks:			

Photograph 7.1.7 Setup for radiated disturbance measurements, radiation from EUT pins



Test specification:		Section 6 Class B, Radiated disturbance	
Test procedure:		EN 55022, Section 10	
Test mode:		Compliance	
Date(s):		12/12/2012	
Temperature: 23 °C		Air Pressure: 1015 hPa	
		Relative Humidity: 39 %	
		Power Supply: 5 VDC	
Remarks:			

Plot 7.1.5 Radiated disturbance measurements in 30 - 1000 MHz range, vertical antenna polarization

TEST SITE: Fully anechoic chamber
TEST DISTANCE: 3 m

TLK106 32p QFN radiation from EUT pins

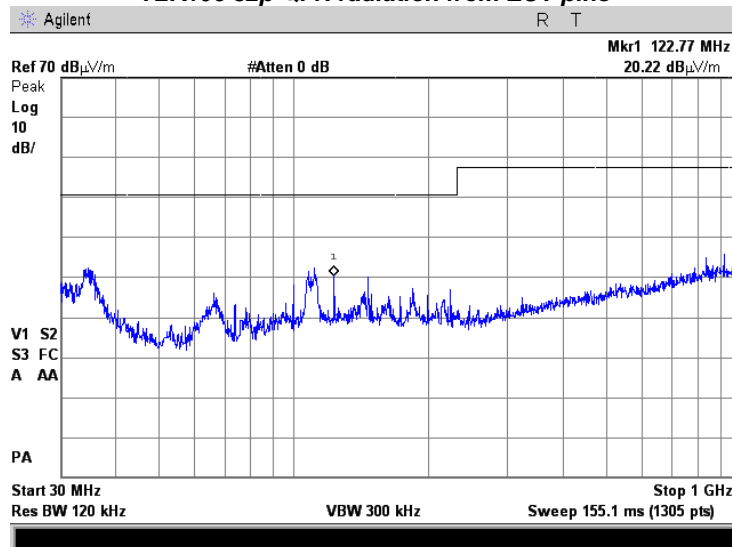

Note: To find the highest emission the measuring antenna height was swept from 1 to 1.8 m (turntable was not rotated)

Plot 7.1.6 Radiated disturbance measurements in 30 - 1000 MHz range, horizontal antenna polarization

TEST SITE: Fully anechoic chamber
TEST DISTANCE: 3 m

TLK106 32p QFN radiation from EUT pins

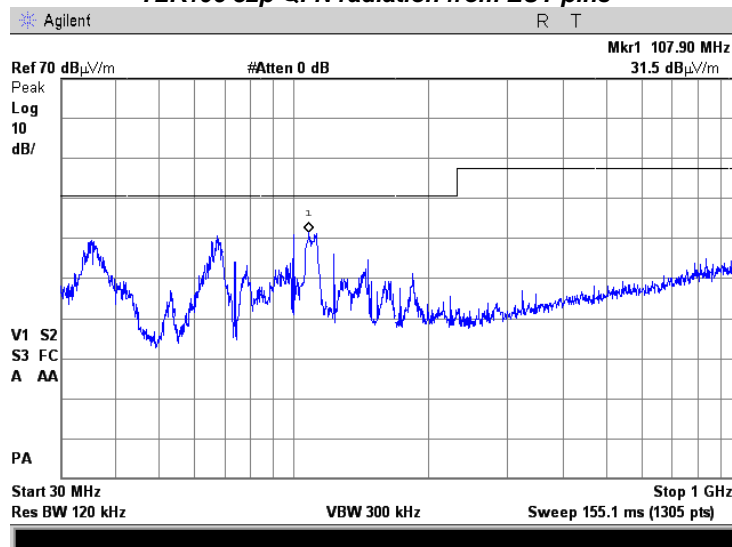

Note: To find the highest emission the measuring antenna height was swept from 1 to 1.8 m (turntable was not rotated)

Test specification:		Section 6 Class B, Radiated disturbance	
Test procedure:		EN 55022, Section 10	
Test mode:		Compliance	
Date(s):		12/12/2012	
Temperature: 23 °C		Air Pressure: 1015 hPa	
		Relative Humidity: 39 %	
		Power Supply: 5 VDC	
Remarks:			

Plot 7.1.7 Radiated disturbance measurements in 1000 – 2900 MHz range, vertical antenna polarization

TEST SITE: Fully anechoic chamber
TEST DISTANCE: 3 m

TLK106 32p QFN radiation from EUT pins

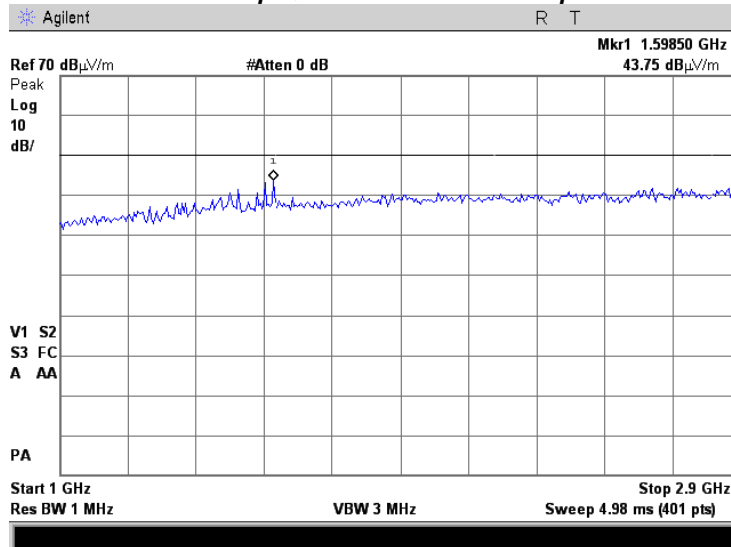

Note: To find the highest emission the measuring antenna height was swept from 1 to 1.8 m (turntable was not rotated)

Plot 7.1.8 Radiated disturbance measurements in 1000 – 2900 MHz range, horizontal antenna polarization

TEST SITE: Fully anechoic chamber
TEST DISTANCE: 3 m

TLK106 32p QFN radiation from EUT pins

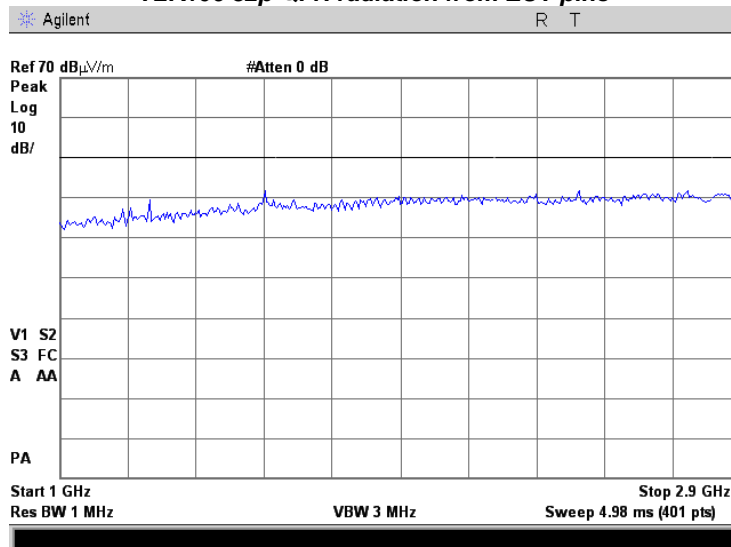

Note: To find the highest emission the measuring antenna height was swept from 1 to 1.8 m (turntable was not rotated)



Test specification:	Radiated immunity to radio frequency electromagnetic field		
Test procedure:	EN 61000-4-3; EN 55024, Section 4.2.3.1		
Test mode:	Evaluation	Verdict:	PASS
Date(s):	12/11/2012 - 12/12/2012		
Temperature: 23 °C	Air Pressure: 1014 hPa	Relative Humidity: 39 %	Power Supply: 5 VDC
Remarks:			

8 Immunity tests

8.1 Radiated immunity to radio frequency electromagnetic field

8.1.1 General

This test was performed to verify the EUT immunity to radiated radio frequency electromagnetic field. The radiated RF electromagnetic field levels, performance criterion and test results are referred to in Table 8.1.1.

8.1.2 Test procedure

- 8.1.2.1 The EUT was set up as shown in Figure 8.1.1 and the associated photographs, energized and the EUT performance was checked.
- 8.1.2.2 The electric field generating antenna was installed facing the EUT front panel at the specified distance.
- 8.1.2.3 The test setup was adjusted to produce the required field strength level. The field strength was monitored by the isotropic field probe, which was placed near the EUT.
- 8.1.2.4 The signal frequency was scanned throughout the frequency range.
- 8.1.2.5 The test was performed with antenna/s in both vertical and horizontal polarizations.
- 8.1.2.6 The test was repeated at selected frequencies.
- 8.1.2.7 The EUT operation was monitored throughout the test for any malfunction or degradation and its performance was recorded.
- 8.1.2.8 Upon this the test was completed.

Test specification:		Radiated immunity to radio frequency electromagnetic field	
Test procedure:		EN 61000-4-3; EN 55024, Section 4.2.3.1	
Test mode:		Evaluation	
Date(s):		12/11/2012 - 12/12/2012	
Temperature: 23 °C		Air Pressure: 1014 hPa	
		Relative Humidity: 39 %	
		Power Supply: 5 VDC	
Remarks:			

Figure 8.1.1 Setup for radiated immunity to RF electromagnetic field test, table-top EUT

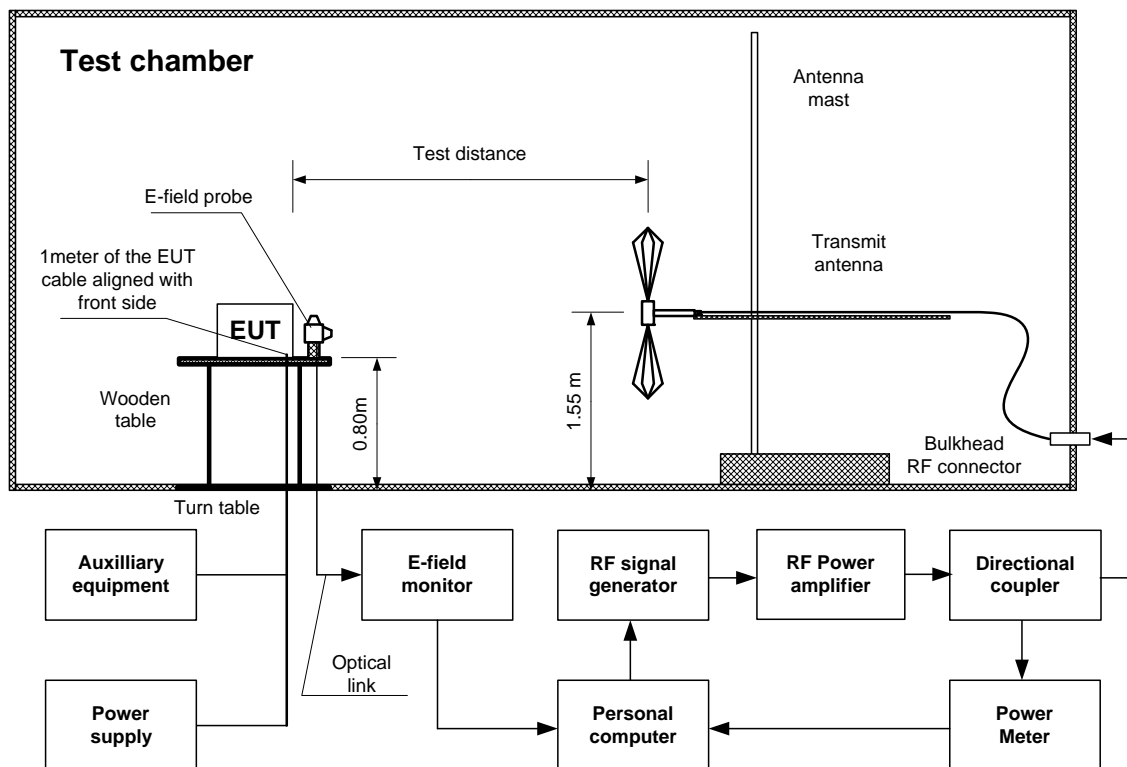

Test specification:	Radiated immunity to radio frequency electromagnetic field		
Test procedure:	EN 61000-4-3; EN 55024, Section 4.2.3.1		
Test mode:	Evaluation	Verdict:	PASS
Date(s):	12/11/2012 - 12/12/2012		
Temperature: 23 °C	Air Pressure: 1014 hPa	Relative Humidity: 39 %	Power Supply: 5 VDC
Remarks:			

Photograph 8.1.1 Setup for radiated immunity to RF electromagnetic field test, general view, EUT radiation through cable



Photograph 8.1.2 Setup for radiated immunity to RF electromagnetic field test, EUT close view, EUT radiation through cable



Test specification:	Radiated immunity to radio frequency electromagnetic field		
Test procedure:	EN 61000-4-3; EN 55024, Section 4.2.3.1		
Test mode:	Evaluation	Verdict:	PASS
Date(s):	12/11/2012 - 12/12/2012		
Temperature: 23 °C	Air Pressure: 1014 hPa	Relative Humidity: 39 %	Power Supply: 5 VDC
Remarks:			

Photograph 8.1.3 Setup for radiated immunity to RF electromagnetic field test, general view, radiation from EUT pins



Photograph 8.1.4 Setup for radiated immunity to RF electromagnetic field test, general view, radiation from EUT pins



Test specification:	Radiated immunity to radio frequency electromagnetic field		
Test procedure:	EN 61000-4-3; EN 55024, Section 4.2.3.1		
Test mode:	Evaluation	Verdict:	PASS
Date(s):	12/11/2012 - 12/12/2012		
Temperature: 23 °C	Air Pressure: 1014 hPa	Relative Humidity: 39 %	Power Supply: 5 VDC
Remarks:			

Photograph 8.1.5 Setup for radiated immunity to RF electromagnetic field test, EUT close view, radiation from EUT pins

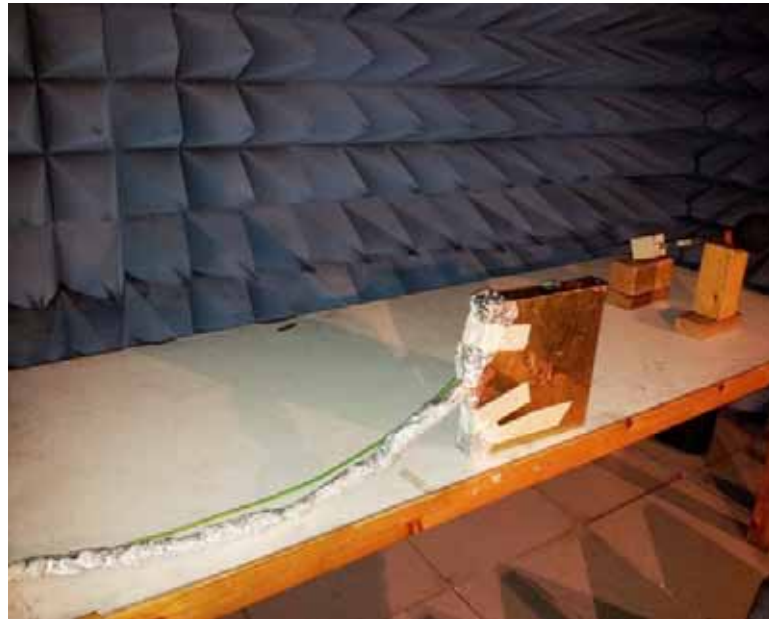

Test specification: Radiated immunity to radio frequency electromagnetic field			
Test procedure: EN 61000-4-3; EN 55024, Section 4.2.3.1			
Test mode: Evaluation		Verdict: PASS	
Date(s): 12/11/2012 - 12/12/2012			
Temperature: 23 °C	Air Pressure: 1014 hPa	Relative Humidity: 39 %	Power Supply: 5 VDC
Remarks:			

Table 8.1.1 Radiated immunity to RF electromagnetic field test results

TLK106 32p QFN radiation through cable

EUT SET UP: TABLE-TOP
 PERFORMANCE CRITERIA: A
 TEST SITE: FULLY ANECHOIC CHAMBER
 ANTENNA TO EUT DISTANCE: 2.4 m
 FREQUENCY RANGE: 80 – 1000 MHz
 MODULATION: 80% AM with 1 kHz
 DWELL TIME: 2.8 s
 FREQUENCY STEP: 1 % of current frequency

EUT orientation*	Antenna polarization	Field strength**, V_{rms}/m	EUT performance description during the test	Verdict
0°	Vertical	10***	NP	Pass***
	Horizontal		At 89.49 MHz and 98.59 MHz the errors appeared	

* - 0° = antenna installed facing the EUT front panel.
 ** - Field strength measured prior to modulation.
 *** - The standard requirement is 3 V_{rms}/m .

TLK106 32p QFN radiation from EUT pins

EUT SET UP: TABLE-TOP
 PERFORMANCE CRITERIA: A
 TEST SITE: MILITARY SEMI ANECHOIC CHAMBER
 ANTENNA TO EUT DISTANCE: 2.0 m
 FREQUENCY RANGE: 80 – 1000 MHz
 MODULATION: 80% AM with 1 kHz
 DWELL TIME: 2.8 s
 FREQUENCY STEP: 1 % of current frequency

EUT orientation*	Antenna polarization	Field strength**, V_{rms}/m	EUT performance description during the test	Verdict
0°	Vertical	10***	At 81, 115, 132, 214; 415; 520 MHz the errors appeared; the threshold 8 V defined for 115 and 132 MHz	Tested
	Horizontal		At 81, 129, 226 MHz the errors appeared; the threshold 9.5 V defined for 226 MHz	

* - 0° = antenna installed facing the EUT front panel.
 ** - Field strength measured prior to modulation.
 *** - The standard requirement is 3 V_{rms}/m .
 ***The 8 V_{rms}/m threshold was defined for 115 and 132 MHz, the 9.5 V_{rms}/m threshold defined for 226 MHz only.

Reference numbers of test equipment used

HL 0317	HL 0613	HL 0659	HL 0674	HL 1097	HL 1544	HL 1629	HL 2078
HL 2109	HL 2376	HL 2432	HL 2697	HL 2783	HL 2788	HL 3158	HL 3508

Full description is given in Appendix A.

9 APPENDIX A Test equipment and ancillaries used for tests

HL No	Description	Manufacturer	Model	Ser. No.	Last Cal./ Check	Due Cal./ Check
0317	Power Sensor, 30 MHz - 18 GHz, -70 to 20 dBm	Boonton Electronics Corp.	51072	26163	01-Jan-13	01-Jan-14
0613	Sensor Electric Field 10 kHz-1.0 GHz, 1-300 V/m (probe)	Amplifier Research	FP2000	18677	07-Dec-12	07-Dec-13
0659	Amplifier 1 to 4 GHz, 55 W	Milmega	AS0104-55/55B	971386	03-Jul-12	03-Jul-13
0674	Coupler Directional, high power 80 - 1000 MHz, 1500 W	WERLATONE	C3908	5843	01-Jan-13	01-Jan-14
1097	Attenuator, 50 Ohm, 5 W, DC to 8 GHz, 20 dB	Midwest Microwave	0793-20-NN-07	1097	10-Oct-12	10-Oct-13
1544	Cable RF, N/N-type, 3.2 m	Alpha Wire	RG-213/U	1544	19-Jul-12	19-Jul-13
1629	Isotropic Field Monitor	Amplifier Research	FM2000	23308	07-Dec-12	07-Dec-13
2078	Isotropic Field Probe 80 MHz - 40 GHz	Amplifier Research	FP2080	302541	10-Feb-13	10-Feb-14
2109	Anechoic Chamber 6(L) x 5.5(W) x 2.95(H) m	Hermon Laboratories	AC-2	2109	07-Nov-12	07-Nov-13
2376	Coupler coaxial bi-directional 1 - 4 GHz, 20 dB	Narda	3022	50076	21-Jun-12	21-Jun-13
2432	Antenna, Double-Ridged Waveguide Horn 1-18 GHz	EMC Test Systems	3115	00027177	07-Dec-12	07-Dec-13
2697	Antenna, 30 MHz - 3.0 GHz	Sunol Sciences Corp. Pleasanton, California USA	JB3	A022805	20-May-12	20-May-14
2783	Power Meter, RF, IEEE-488, 100 kHz - 100 GHz, -70 to +37 dBm	Boonton Electronics Corp.	4220	156602BK	02-Jan-13	02-Jan-14
2788	Horn Antenna, 0.5 to 4 GHz	GTE Sylvania	AN-10E	78004	30-Jul-10	30-Jul-13
3158	Amplifier, 80 to 1000 MHz, 500 W	Amplifier Research	500W100 0A	032960	03-Apr-13	03-Apr-14
3508	MIL STD Anechoic Chamber 6.0(L) x 4.8(W) x 2.9(H) m	ETS Lindgren	RFD-F/A-100	4311	30-Oct-12	30-Oct-13
4150	Preamplifier, 0.1 to 18 GHz, Gain 25 dB, N-type(f) in, N-type(m) out.	Agilent Technologies	87405C	MY470105 91	18-Jun-12	18-Jun-13
4347	Low Loss Armored Test Cable, DC - 18 GHz, 2.0 m, N type-M/N type-M	MegaPhase	NC29-N1N1-79	12025103 001	06-Mar-13	06-Mar-14
4349	Low Loss Armored Test Cable, DC - 18 GHz, 4.5 m, N type-M/N type-M	MegaPhase	NC29-N1N1-177	12025102 001	01-Jan-13	01-Jan-14

10 APPENDIX B Measurement uncertainties

Expanded uncertainty at 95% confidence in Hermon Labs EMC measurements

Test description	Expanded uncertainty
Radiated emissions at 3 m measuring distance Horizontal polarization	Biconilog antenna: ± 5.3 dB Biconical antenna: ± 5.0 dB Log periodic antenna: ± 5.3 dB
Vertical polarization	Double ridged horn antenna: ± 5.3 dB Biconilog antenna: ± 6.0 dB Biconical antenna: ± 5.7 dB Log periodic antenna: ± 6.0 dB Double ridged horn antenna: ± 6.0 dB
Radiated immunity AR FP2000 E-field probe AR FP2080 E-field probe	10 kHz to 250 MHz: ± 1.9 dB; 250 MHz to 1 GHz: ± 2.1 dB 80 MHz to 26 GHz: ± 2.7 dB; 26 GHz to 40 GHz: ± 4.0 dB

Hermon Laboratories is accredited by A2LA for calibration according to present requirements of ISO/IEC 17025 and NCSL Z540-1. The accreditation is granted to perform calibration of parameters that are listed in the Scope of Hermon Laboratories Accreditation.

Hermon Laboratories calibrates its reference and transfer standards by calibration laboratories accredited to ISO/IEC 17025 by a mutually recognized Accreditation Body or by a recognized national metrology institute. All reference and transfer standards used in the calibration system are traceable to national or international standards.

In-house calibration of all test and measurement equipment is performed on a regular basis according to Hermon Laboratories calibration procedures, manufacturer calibration/verification procedures or procedures defined in the relevant standards. The Hermon Laboratories test and measurement equipment is calibrated within the tolerances specified by the manufacturers and/or by the relevant standards.

11 APPENDIX C Test laboratory description

Tests were performed at Hermon Laboratories Ltd., which is a fully independent, private, EMC, safety, environmental and telecommunication testing facility.

Hermon Laboratories is listed by the Federal Communications Commission (USA) for all parts of Code of Federal Regulations 47 (CFR 47), Registration Numbers 90624 for OATS and 90623 for the anechoic chamber; by Industry Canada for electromagnetic emissions (file numbers IC 2186A-1 for OATS and IC 2186A-2 for anechoic chamber), certified by VCCI, Japan (the registration numbers are R-808 for OATS, R-1082 for semi anechoic chamber, G-27 for full-anechoic chamber, C-845 for conducted emissions (mains ports) site, T-1606 for conducted emissions (telecommunication ports) site), has a status of a Telefication - Listed Testing Laboratory, Certificate No. L138/00. The laboratory is accredited by American Association for Laboratory Accreditation (USA) according to ISO/IEC 17025 for electromagnetic compatibility, product safety, telecommunications testing and environmental simulation (for exact scope please refer to Certificate No. 839.01).

Address: P.O. Box 23, Binyamina 30500, Israel.
Telephone: +972 4628 8001
Fax: +972 4628 8277
e-mail: mail@hermonlabs.com
website: www.hermonlabs.com

Person for contact: Mr. Alex Usoskin, CEO.

12 APPENDIX D Specification references

EN 300 386 V1.4.1: 2008	Electromagnetic compatibility and Radio spectrum Matters (ERM). Telecommunication network equipment. ElectroMagnetic Compatibility (EMC) requirements
EN 55022: 2010	Limits and methods of measurement of interference characteristics of information technology equipment
CISPR 16-1-1: 2006	Specification for radio disturbance and immunity measuring apparatus and methods. Part 1-1: Radio disturbance and immunity measuring apparatus – Measuring apparatus
EN 61000-4-3: 2006+A1(08)+A2(10)	Electromagnetic compatibility (EMC). Part 4: testing and measurement techniques. Section 3: Radiated, radio frequency, electromagnetic field immunity test

13 APPENDIX E Test equipment correction factors

Antenna factor
Double-ridged guide horn antenna
Model 3115, serial number: 00027177, HL 2432

Frequency, MHz	Antenna factor. dB(1/m)
1000.0	24.7
1500.0	25.7
2000.0	27.8
2500.0	28.9
3000.0	30.7
3500.0	31.8
4000.0	33.0
4500.0	32.8
5000.0	34.2
5500.0	34.9
6000.0	35.2
6500.0	35.4
7000.0	36.3
7500.0	37.3
8000.0	37.5
8500.0	38.0
9000.0	38.3
9500.0	38.3
10000.0	38.7
10500.0	38.7
11000.0	38.9
11500.0	39.5
12000.0	39.5
12500.0	39.4
13000.0	40.5
13500.0	40.8
14000.0	41.5
14500.0	41.3
15000.0	40.2
15500.0	38.7
16000.0	38.5
16500.0	39.8
17000.0	41.9
17500.0	45.8
18000.0	49.1

Antenna factor in dB(1/m) is to be added to receiver meter reading in dB(μ V) to convert it into field strength in dB(μ V/m).



Antenna calibration
Sunlo Sciences Inc., model JB3, serial number A022805, HL 2697

Frequency, MHz	ACF, dB	Gain, dBi	Num gain	Frequency, MHz	ACF, dB	Gain, dBi	Num gain	Frequency, MHz	ACF, dB	Gain, dBi	Num gain	Frequency, MHz	ACF, dB	Gain, dBi	Num gain	Frequency, MHz	ACF, dB	Gain, dBi	Num gain
30	22.2	-22.5	0.01	620	19.7	6.3	4.27	1215	24.9	7.0	5.05	1810	28.3	7.1	5.08	2405	30.9	6.9	4.83
35	18.5	-17.4	0.02	625	19.7	6.5	4.42	1220	24.9	7.0	4.99	1815	28.5	6.9	4.91	2410	30.9	6.9	4.89
40	14.7	-12.5	0.06	630	19.6	6.6	4.57	1225	25.1	6.9	4.91	1820	28.6	6.8	4.74	2415	31.0	6.9	4.85
45	11.3	-8.1	0.16	635	19.7	6.5	4.48	1230	25.2	6.8	4.82	1825	28.7	6.8	4.75	2420	31.0	6.8	4.82
45	11.3	-8.1	0.16	640	19.9	6.4	4.40	1235	25.1	7.0	4.96	1830	28.7	6.8	4.76	2425	31.1	6.8	4.81
50	8.9	-4.7	0.34	645	19.9	6.5	4.45	1240	25.0	7.1	5.09	1835	28.7	6.7	4.72	2430	31.0	6.9	4.87
55	7.9	-2.8	0.52	650	19.9	6.5	4.51	1245	25.0	7.1	5.12	1840	28.8	6.7	4.69	2435	31.0	6.9	4.86
60	7.8	-2.1	0.82	655	19.9	6.6	4.60	1250	25.0	7.1	5.15	1845	28.6	6.9	4.50	2440	31.2	6.8	4.74
65	8.5	-2.0	0.63	660	19.9	6.7	4.69	1255	25.0	7.2	5.25	1850	28.4	7.1	5.12	2445	31.1	6.9	4.91
70	9.0	-1.9	0.64	665	19.9	6.7	4.70	1260	24.9	7.3	5.36	1855	28.5	7.0	5.07	2450	31.0	7.0	4.96
75	8.8	-1.1	0.78	670	20.0	6.7	4.71	1265	25.0	7.3	5.31	1860	28.6	7.0	5.01	2455	31.0	7.0	5.01
80	8.4	-0.2	0.97	675	20.1	6.7	4.71	1270	25.1	7.2	5.26	1865	28.5	7.1	5.17	2460	30.9	7.2	5.19
85	8.0	0.8	1.20	680	20.1	6.7	4.71	1275	25.3	7.0	5.05	1870	28.4	7.3	5.33	2465	31.1	6.9	4.95
90	8.2	1.1	1.29	685	20.1	6.8	4.79	1280	25.5	6.8	4.84	1875	28.4	7.2	5.28	2470	31.3	6.8	4.76
95	9.2	0.5	1.13	690	20.1	6.9	4.88	1285	25.4	7.0	4.97	1880	28.5	7.2	5.22	2475	31.4	6.7	4.69
100	10.6	-0.4	0.92	695	20.2	6.8	4.82	1290	25.3	7.1	5.10	1885	28.5	7.2	5.22	2480	31.3	6.8	4.79
110	12.6	-1.6	0.70	705	20.4	6.8	4.75	1300	25.2	7.3	5.33	1895	28.6	7.2	5.24	2490	31.1	7.0	4.99
120	13.9	-2.1	0.62	715	20.5	6.8	4.80	1310	25.5	7.1	5.09	1905	28.6	7.3	5.36	2500	30.9	7.2	5.27
125	14.2	-2.0	0.63	720	20.5	6.9	4.85	1315	25.4	7.2	5.23	1910	28.5	7.4	5.45	2505	31.1	7.1	5.15
130	14.2	-1.7	0.68	725	20.6	6.8	4.81	1320	25.3	7.3	5.36	1915	28.5	7.3	5.38	2510	31.0	7.2	5.22
140	13.4	-0.3	0.94	735	20.9	6.7	4.65	1330	25.6	7.0	5.06	1925	28.6	7.3	5.35	2520	31.2	7.0	5.05
150	12.9	0.8	1.21	745	21.0	6.6	4.59	1340	25.7	7.1	5.09	1935	28.5	7.4	5.54	2530	31.0	7.3	5.37
160	12.7	1.6	1.44	755	21.0	6.8	4.74	1350	25.7	7.1	5.17	1945	28.5	7.5	5.59	2540	31.2	7.1	5.09
165	12.5	2.0	1.59	760	21.0	6.8	4.83	1355	25.8	7.0	5.06	1950	28.6	7.4	5.48	2545	31.0	7.3	5.43
170	12.2	2.6	1.83	765	21.1	6.8	4.73	1360	25.9	6.9	4.95	1955	28.6	7.5	5.57	2550	31.0	7.3	5.39
175	11.8	3.3	2.13	770	21.3	6.7	4.64	1365	26.0	6.9	4.95	1960	28.6	7.5	5.65	2555	31.1	7.2	5.30
180	11.6	3.7	2.36	775	21.3	6.7	4.68	1370	26.0	7.0	4.98	1965	28.7	7.4	5.47	2560	31.0	7.4	5.47
185	11.5	4.0	2.54	780	21.3	6.7	4.72	1375	26.0	7.0	5.01	1970	28.6	7.2	5.29	2565	30.8	7.6	5.70
190	11.6	4.2	2.61	785	21.3	6.8	4.77	1380	26.0	7.0	5.06	1975	28.9	7.2	5.22	2570	31.1	7.3	5.37
200	13.1	3.2	2.07	795	21.4	6.8	4.79	1390	26.1	6.9	4.92	1985	29.1	7.1	5.11	2580	31.6	6.9	4.87
205	12.0	4.4	2.76	800	21.5	6.8	4.77	1395	26.2	6.9	4.94	1990	29.1	7.0	5.06	2585	31.6	6.8	4.79
210	11.0	5.6	3.66	805	21.6	6.7	4.71	1400	26.2	7.0	4.96	1995	29.1	7.1	5.09	2590	31.6	6.9	4.88
215	11.3	5.6	3.59	810	21.7	6.7	4.65	1405	26.1	7.0	5.02	2000	29.1	7.1	5.11	2595	31.5	7.0	4.97
220	11.6	5.5	3.52	815	21.7	6.7	4.72	1410	26.1	7.1	5.09	2005	29.1	7.1	5.16	2600	31.6	6.9	4.86
225	11.7	5.5	3.35	820	21.7	6.8	4.80	1415	26.2	7.0	5.02	2010	29.2	7.1	5.15	2605	31.3	7.2	5.30
230	11.9	5.5	3.57	825	21.7	6.8	4.82	1420	26.3	7.0	4.96	2015	29.2	7.1	5.13	2610	31.4	7.1	5.15
235	12.1	5.5	3.56	830	21.7	6.9	4.85	1425	26.2	7.1	5.10	2020	29.2	7.1	5.18	2615	31.7	6.9	4.88
240	12.3	5.5	3.54	835	21.8	6.8	4.82	1430	26.1	7.2	5.25	2025	29.3	7.1	5.08	2620	31.6	7.0	4.97
245	12.3	5.7	3.71	840	21.9	6.8	4.80	1435	26.1	7.2	5.24	2030	29.3	7.0	5.05	2625	31.4	7.1	5.17
250	12.3	5.9	3.88	845	21.9	6.8	4.83	1440	26.2	7.2	5.24	2035	29.3	7.1	5.07	2630	31.6	7.0	5.00
255	12.5	5.9	3.85	850	21.9	6.9	4.86	1445	26.3	1	5.11	2040	29.3	7.1	5.13	2635	31.8	6.8	4.82
260	12.7	5.8	3.83	855	22.0	6.8	4.80	1450	26.5	7.0	4.98	2045	29.2	7.2	5.23	2640	31.7	7.0	4.98
265	13.2	5.5	3.54	860	22.0	6.8	4.74	1455	26.4	7.1	5.07	2050	29.2	7.2	5.27	2645	31.7	6.9	4.93
270	13.7	5.2	3.27	865	22.0	6.9	4.82	1460	26.4	7.1	5.17	2055	29.3	7.2	5.21	2650	31.8	6.9	4.85
275	13.7	5.3	3.39	870	21.9	7.1	5.11	1465	26.4	7.2	5.19	2060	29.5	7.0	5.02	2655	31.8	6.9	4.85
280	13.7	5.4	3.50	875	22.0	7.1	5.08	1470	26.4	7.2	5.22	2065	29.4	7.1	5.08	2660	31.7	7.0	5.02
285	13.7	5.6	3.61	880	22.1	7.0	5.05	1475	26.4	7.1	5.17	2070	29.4	7.1	5.10	2665	32.0	6.7	4.71
290	13.7	5.7	3.72	885	22.1	7.0	5.06	1480	26.5	7.1	5.12	2075	29.5	7.0	5.01	2670	32.0	6.7	4.67
295	13.8	5.8	3.77	890	22.1	7.0	5.06	1485	26.5	7.1	5.14	2080	29.6	6.8	4.76	2675	31.9	6.8	4.81
300	13.9	5.8	3.81	895	22.2	7.1	5.09	1490	26.5	7.1	5.17	2085	29.7	6.9	4.89	2680	31.7	7.0	5.04
305	14.0	5.9	3.85	900	22.2	7.1	5.12	1495	26.5	7.2	5.24	2090	29.7	6.9	4.86	2685	31.9	6.8	4.83
310	14.1	5.9	3.88	905	22.3	7.1	5.09	1500	26.5	7.2	5.31	2095	29.8	6.8	4.78	2690	32.1	6.7	4.72
315	14.3	5.8	3.89	910	22.3	7.0	5.05	1505	26.5	7.2	5.27	2100	29.8	6.8	4.75	2695	32.1	6.7	4.71
320	14.4	5.8	3.90	915	22.4	7.0	4.99	1510	26.6	7.2	5.23	2105	29.8	6.8	4.81	2700	32.0	6.8	4.81
325	14.5	5.9	3.92	920	22.6	6.9	4.92	1515	26.6	7.2	5.30	2110	29.9	6.8	4.78	2705	32.0	6.8	4.80
330	14.6	5.9	3.93	925	22.7	6.9	4.85	1520	26.5	7.3	5.38	2115	29.9	6.8	4.76	2710	32.1	6.8	4.79
335	14.7	6.0	4.02	930	22.8	6.8	4.77	1525	26.6	7.3	5.37	2120	29.9	6.8	4.84	2715	32.1	6.7	4.71
340	14.7	6.2	4.12	935	22.8	6.8	4.83	1530	26.6	7.3	5.36	2125	29.9	6.9	4.89	2720	32.4	6.5	4.47
345	14.9	6.1	4.06	940	22.8	6.9	4.89	1535	26.6	7.4	5.44	2130	29.9	6.9	4.90	2725	32.2	6.7	4.63
350	15.1	6.0	3.99	945	22.8	6.9	4.87	1540	26.5	7.4	5.53	2135	29.8	6.9	4.94	2730	31.9	7.0	5.05
355	15.3	5.9	3.88	950	22.9	6.9	4.85	1545	26.5	7.5	5.58	2140	29.8	7.1	5.08	2735	31.6	7.4	5.44
360	15.6	5.8	3.78	955	23.0	6.8	4.81	1550	26.5	7.5	5.63	2145	29.8	6.9	4.92	2740	31.8	7.1	5.40
365	15.5	5.8	3.89	960	23.1	6.8	4.77	1555	26.6	7.3	5.39	2150	29.9	7.0	4.98	2745	31.9	7.0	5.06
370	15.5	6.0	4.01	965	23.1	6.7	4.73	1560	26.9	7.1	5.18	2155	29.8	7.1	5.10	2750	32.0	6.9	4.94
375	15.6	6.1	4.03	970	23.2	6.7	4.69	1565	26.9	7.2	5.23	2160	29.8	7.1	5.09	2755	32.0	7.0	4.98
380	15.7	6.1	4.05	975	23.3	6.6	4.62	1570	26.9	7.2	5.30	2165	29.9	7.0	5.00	2760	32.0	7.0	5.06
385	15.7	6.2	4.15	980	23.5	6.6	4.54	1575	27.0	7.2	5.23	2170	29.9	7.1	5.07	2765	32.2	6.8	4.80
390	15.7	6.3	4.25	985	23.5	6.6	4.52												



14 APPENDIX F Abbreviations and acronyms

A	ampere
AC	alternating current
AM	amplitude modulation
AVRG	average (detector)
cm	centimeter
dB	decibel
dBm	decibel referred to one milliwatt
dB(μ V)	decibel referred to one microvolt
dB(μ V/m)	decibel referred to one microvolt per meter
dB(μ A)	decibel referred to one microampere
DC	direct current
EUT	equipment under test
F	frequency
GHz	gigahertz
GND	ground
H	height
HL	Hermon laboratories
Hz	hertz
k	kilo
kHz	kilohertz
m	meter
MHz	megahertz
min	minute
mm	millimeter
ms	millisecond
μ s	microsecond
NA	not applicable
OATS	open area test site
Ω	Ohm
QP	quasi-peak
RE	radiated emission
RF	radio frequency
rms	root mean square
Rx	receive
s	second
T	temperature
Tx	transmit
V	volt
WB	wideband

END OF DOCUMENT