

ABSTRACT

This user's guide describes the characteristics, operation, and use of the TMAG5170 evaluation module (EVM). This EVM is designed to evaluate the performance of the TMAG5170. Throughout this document, the terms evaluation board, evaluation module, and EVM are synonymous with the TMAG5170UEVM. This document includes a schematic, reference printed circuit board (PCB) layouts, and a complete bill of materials (BOM).

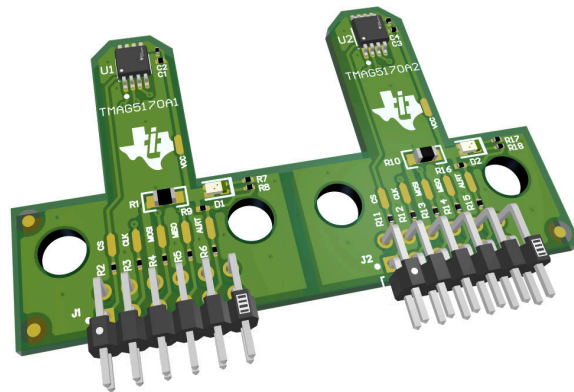

Table of Contents

1 Trademarks	1
2 Overview	2
2.1 Kit Contents.....	2
2.2 Related Documentation From Texas Instruments.....	2
3 Hardware	3
3.1 Features.....	3
4 Operation	3
4.1 Quick Start Setup.....	3
4.2 EVM Operation.....	4
5 Schematics, PCB Layout, and Bill of Materials	10
5.1 Schematics.....	10
5.2 PCB Layout.....	12
5.3 Bill of Materials.....	14
6 Revision History	15

1 Trademarks

All trademarks are the property of their respective owners.

2 Overview

The TMAG5170 is a 3-axis linear Hall effect sensor. This device integrates three independent Hall sensors in X, Y, and Z axes. A precision analog signal-chain along with integrated 12-bit ADC digitizes the measured analog magnetic field values. The device can be configured further to select one of three magnetic field ranges that suits the magnet strength and component placements during system calibration.

Table 2-1. TMAG5170 Device Summary

PRODUCT	SENSITIVITY RANGE OPTIONS
TMAG5170A1	±25 mT, ±50 mT, ±100 mT
TMAG5170A2	±75 mT, ±150 mT, ±300 mT

2.1 Kit Contents

Table 2-2 lists the contents of the EVM kit. Contact the nearest [Texas Instruments Product Information Center](#) if any component is missing.

Table 2-2. Kit Contents

ITEM	QUANTITY
TMAG5170UEVM	1
Rotate and push 3D print module	1
Handheld magnet	1

2.2 Related Documentation From Texas Instruments

This user's guide is available from the TI website under literature number [SBAU350](#). Any letter appended to the literature number corresponds to the document revision that is current at the time of the writing of this document. Newer revisions are available from [www.ti.com](#) or the Texas Instruments' Literature Response Center at (800) 477-8924 or the Product Information Center at (972) 644-5580. When ordering, identify the document by both title and literature number. Table 2-3 lists documentation related to the EVM. Click the links in Table 2-3 for further information. The device name links to the product web folder on [www.ti.com](#). The literature number links to the document PDF.

Table 2-3. Related Documentation

DOCUMENT TITLE	DOCUMENT LITERATURE NUMBER
TMAG5170 data sheet	SBASAF4
TMAG5170-Q1 data sheet	SBAS934
TI-SCB User's Guide	SLAU839
TMAG5170 EVM Quick Start Video	–

3 Hardware

The EVM is an easy-to-use platform for evaluating the main features and performance of the TMAG5170. The EVM includes a graphical user interface (GUI) used to read and write registers, as well as view and save measurement results. Also included is a 3D printed Rotate & Push Module to test the common functions of angle measurement and push button with a single device.

The EVM is intended to provide basic functional evaluation of the devices. The layout is not intended to be a model for the target circuit, nor is it laid out for electromagnetic compatibility (EMC) testing. The EVM has both sensitivity variations of the TMAG5170 installed, and may be broken into two separate boards as needed. It is intended to interface with the [TI-SCB](#), but may be used stand-alone if desired.

3.1 Features

- Snap Apart PCB for evaluation of both TMAG5170A1 and TMAG5170A2 sensitivities
- GUI support to read and write device registers, as well as view and save measurement results
- 3D print rotate and push module
- Detachable EVM for custom use cases
- Conveniently powered from a common micro-USB connector

4 Operation

4.1 Quick Start Setup

The following instructions describe how to set up and use the EVM.

1. Download and install this driver: <http://www.ti.com/lit/zip/sbac253>
2. Attach the EVM to the Sensor Control Board (TI-SCB) (see [Figure 4-1](#)).
3. Connect the EVM to a PC using a USB cable.
 - a. Insert the micro USB cable into the TI-SCB Controller onboard USB receptacle J2.
 - b. Plug the other end of the USB cable into a PC.
4. Access the GUI from the below link in either Chrome or Firefox:
 - a. TMAG5170EVM GUI: https://dev.ti.com/gallery/view/1253127/TMAG5170UEVM_GUI/
5. Configure the device through the register map settings:
 - a. Set OPERATING_MODE within the DEVICE_CONFIG register to "Active Measure Mode" (0b101)
 - b. Set MAG_CH_EN within the SENSOR_CONFIG register to "XYZ" (0b0111)
6. Navigate to the *Plots* panel and click *Collect Data*
7. Apply a magnetic field to the sensor by doing one of the following:
 - a. Wave the included handheld magnet around the sensor.
 - b. Use the Rotate & Push Module by attaching it to the EVM (see [Figure 4-10](#)). For more details on how to use this module, see [Section 4.2.2](#).
8. Observe the outputs in the GUI. See [Section 4.2.1.3](#) for more info on GUI setup and operation.

4.2 EVM Operation

To use the EVM with the included TI-SCB Controller, connect the EVM as shown in [Figure 4-1](#).

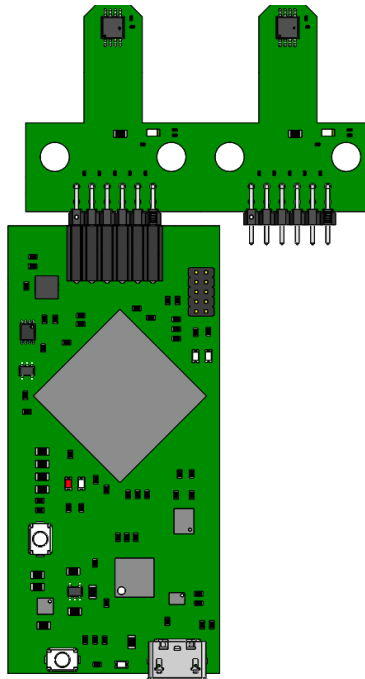

Figure 4-1. EVM on TI-SCB Controller

It is optional to snap apart the TMAG5170UEVM to separate the TMAG5170A1 and TMAG5170A2 halves. This may be done by flexing the PCB at the indicated boundary below

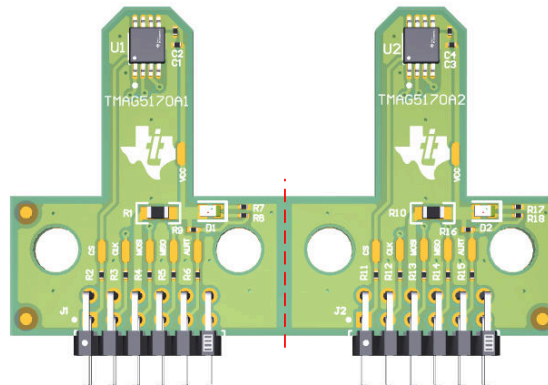

Figure 4-2. TMAG5170UEVM Snap Apart Edge

4.2.1 Setup

4.2.1.1 Driver Installation

Download and install this driver: <http://www.ti.com/lit/zip/sbac253>. This is a one-time step per computer. Unzip the folder and run the .exe file with administrator privileges.

4.2.1.2 Firmware

The GUI is capable of loading firmware onto the TI-SCB as described in [Section 4.2.1.3.1](#). Firmware updates will be pushed through the GUI (requires driver installation). Downloaded offline GUIs may check for GUI/Firmware updates depending on the version.

4.2.1.2.1 Firmware Debug

If the firmware gets corrupted or must be manually reinstalled for any reason, follow these steps to reinstall the firmware. This is demonstrated in the [TMAG5170 EVM Quick Start Video](#).

1. Configure the MCU on the TI-SCB Controller to be in Device Firmware Update (DFU) Mode.
 - a. It is possible that the MCU has already entered DFU mode. If so, the GUI will notify you and try to update the firmware to the latest version after the GUI is connected to the PC.
 - b. DFU mode can be entered manually through one of the following methods while the TI-SCB Controller is powered on:
 - Through software:
 - Send the command 'bsl' on the TI-SCB's USB Serial (COM) port.
 - Through the hardware:
 - Ensure TI-SCB is connected to the PC through a USB
 - Short the two test points near PK1 and PK2 of the header pins (see [Figure 4-3](#)) with a pair of tweezers (or wire) while pressing the RESET button.

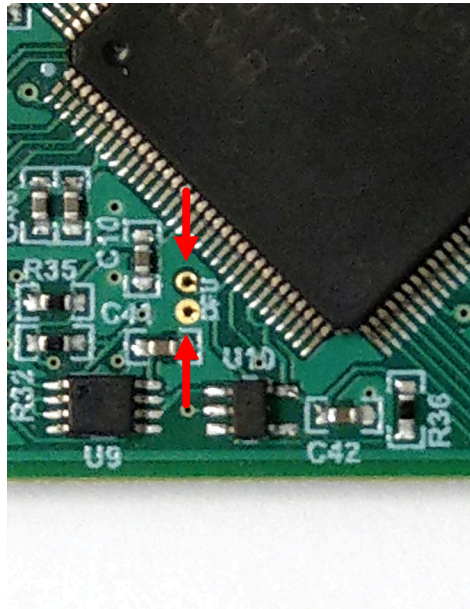

Figure 4-3. Test Points Used to Enter DFU Mode Manually

- c. LEDs D1 and D2 will be off if successful
2. With the MCU in DFU mode, the user can upload the firmware through one of the following methods:
 - Through the GUI:
 - In the *File* menu, select *Program Device*
 - The firmware update will initiate
 - After the GUI re-initializes, the TI-SCB should automatically connect
 - Through the USB Bootstrap Loader (BSL) scripser tool and batch file:
 - Download the firmware package and BSL scripser tool from the EVM page, or use the links below.
 - TMAG5170EVM: <http://www.ti.com/lit/zip/sbac268>
 - Unzip the firmware folder and run the .bat file.
 - If the firmware programming was unsuccessful, TI recommends to try repeating the above steps while using a different USB port on the machine.

4.2.1.3 GUI Setup and Usage

Access the GUI from the below link in either Chrome or Firefox:

- TMAG5170EVM GUI: https://dev.ti.com/gallery/view/1253127/TMAG5170UEVM_GUI

4.2.1.3.1 Initial Setup

To set up the GUI the first time, follow the below instructions:

1. Make sure that the above mentioned driver was installed successfully to ensure that everything works properly and that the GUI can update the EVM firmware, if necessary.
2. With the EVM/TI-SCB Controller unit plugged to the PC, go to the GUI link provided above.
3. To launch the GUI from the web browser, click the *GUI Composer* application to open the *GUI Composer* window (see [Figure 4-4](#)).

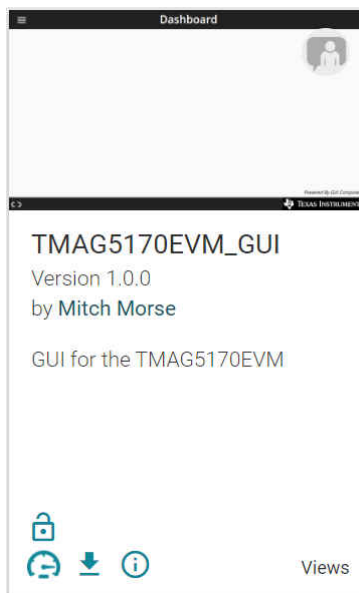

Figure 4-4. GUI Composer Application Window

- a. For first-time GUI Composer setup, follow the prompts to download the **TI Cloud Agent** and browser extension shown in [Figure 4-5](#). These prompts will appear after you close the README.md dialog.

TI Cloud Agent Installation

Hardware interaction requires additional one time set up. Please perform the actions listed below and try your operation again.(What's this?)

- Step 1: **INSTALL** browser extension
- Step 2: **DOWNLOAD** and install the TI Cloud Agent Application
- Help. I already did this

FINISH

Figure 4-5. TI Cloud Agent

4. Optionally, the GUI can be downloaded for offline use by clicking the  icon in the *GUI Composer* window shown in [Figure 4-4](#).

4.2.1.3.2 GUI Operation

To operate the GUI, follow these steps:

1. Connect to and launch the GUI as described in [Section 4.2.1.3.1](#).
2. With the EVM connected to the GUI, close the README.md file page. The text near the bottom-left hand corner of the GUI should read *Hardware Connected* (see [Figure 4-6](#)).

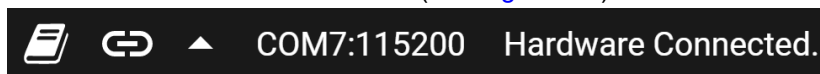

Figure 4-6. Hardware Connected

- a. If *Hardware Connected* does not show in the bottom-left hand corner of the GUI, check different hardware COM ports under *Options >> Serial Port* (see [Figure 4-7](#)).

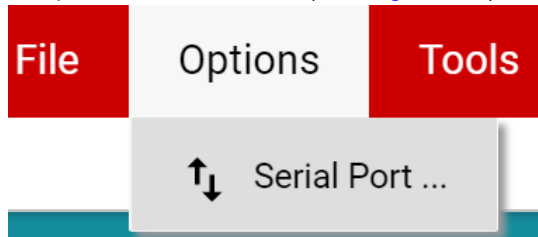



Figure 4-7. Change Serial Port

- b. If the hardware still does not connect, make sure you are using the correct GUI/EVM combination.
3. Click the *Registers* icon shown in [Figure 4-8](#) (also available on the left side menu) to view the register map, and change device settings, and enable automatic register read. For questions about a register or register bit field, select the  icon. For more questions about registers, check the data sheet.



Registers

Low level register read and write operations

Figure 4-8. Registers Page Icon

4. Click the *Plots* icon to view and save graphical data from the results registers (see [Figure 4-9](#)). This is also available on the left-side menu.



Plots

Plots for device outputs

Figure 4-9. Plots Page Icon

4.2.2 Rotate and Push Demo

To use the rotate and push demo:

1. Attach the Rotate & Push Module to the EVM as shown in [Figure 4-10](#).

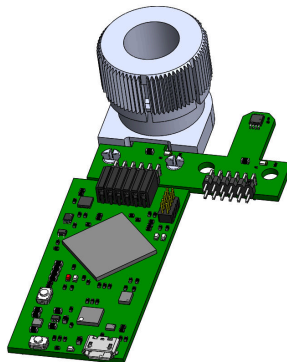

Figure 4-10. Rotate & Push Module on EVM

2. In the GUI register page:
 - a. Make sure that the DEVICE_CONFIG → OPERATING_MODE says (*TRIGGER_MODE Active*).
 - b. Make sure that SYSTEM_CONFIG → TRIGGER_MODE is set to the default value.
 - c. Under the SENSOR_CONFIG register:
 - i. Make sure both the x and y channels are enabled (MAG_CH_EN).
 - ii. Set X_RANGE and Y_RANGE to $\pm 100\text{mT}$ for A1 versions, and $\pm 133\text{mT}$ for A2 versions.
 - iii. Optional: Set ANGLE_EN to X-Y angle calculation.
 - d. At the top of the register map, set *Auto Read* to *As fast as possible*.
3. Go to the *Rotate & Push* tab inside the plots page (see [Figure 4-11](#)).

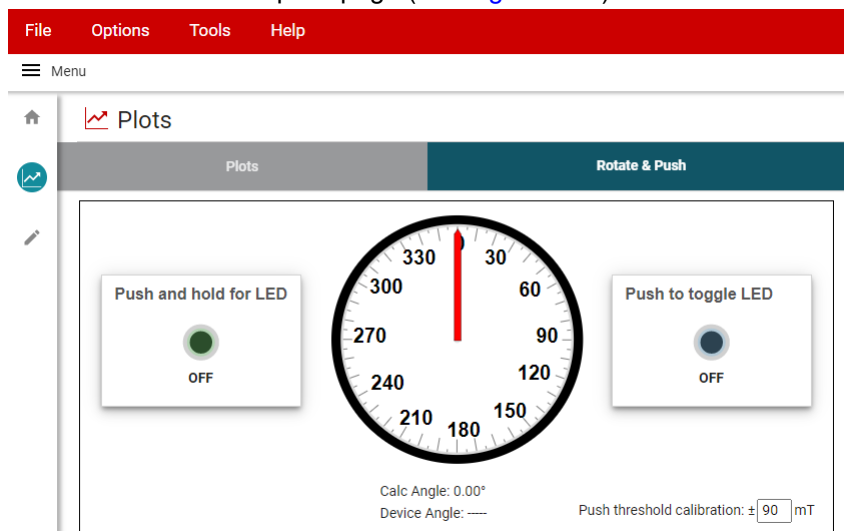

Figure 4-11. Rotate & Push GUI Page

4. If the push button LEDs are not triggering at every angle or trigger when they are not supposed to, calibrate the module by doing the following:
 - a. With the settings set to run the demo, slowly rotate the module 360° and use the plots page to record the absolute value of the minimum and maximum magnetic field measurements (in mT) for both the X and Y channels.
 - b. Adjust the *Push threshold calibration* value found in the *Rotate & Push* tab to be about 3-5mT larger than the maximum value recorded above.

4.2.3 Direct EVM Serial Communication

If desired, you can directly communicate with the TI-SCB without the use of the GUI through the USB serial (COM) port. Simply send the desired command string over the serial port and receive the results. This is useful for interfacing the EVM with custom setups/scripts/GUIs. To read and write registers, follow the below format:

- Read register format: rreg ADR
 - Where ADR is the address in hex, and rreg is always lower case
 - Register addresses can be in upper or lower case, and do not need to be led by '0x'. The 0 padding register addresses is also optional. For example, to read register address 0xA, some valid commands include:
 - rreg a
 - rreg 0A
 - rreg 0x0A
 - When '0x' is used, the 'x' must be lower case.
 - For the above example, the EVM would return the results in JSON format

```

{"acknowledge": "rreg 0x0A"}

{"register": {"address": 10, "value": 65488}}

{"evm_state": "idle"}
          
```
- Write register format: wreg ADR VAL
 - where ADR and VAL are in hex, and wreg is always lower case
 - Register addresses and values can be in upper or lower case, and do not need to be led by '0x'. The 0 padding register addresses and values is also optional. For example, to write register address 0x1 with the value 0x01c0, some valid commands include:
 - wreg 1 1c0
 - wreg 01 0x1c0
 - wreg 0x01 0x01C0
 - When '0x' is used, the 'x' must be lower case.
 - For the above example, the EVM would return the results in JSON format:

```

{"acknowledge": "wreg 0x01 0x01C0"}

{"console": "Writing 0x1c0 to SENSOR_CONFIG register"}

{"evm_state": "idle"}
          
```

5 Schematics, PCB Layout, and Bill of Materials

Note

Board layouts are not to scale. These figures are intended to show how the board is laid out. The figures are not intended to be used for manufacturing EVM PCBs.

5.1 Schematics

Figure 5-1 and Figure 5-2 show the schematic of the EVM. Figure 5-1 shows the circuitry for the EVM, and Figure 5-2 shows the mechanical components included with the EVM.

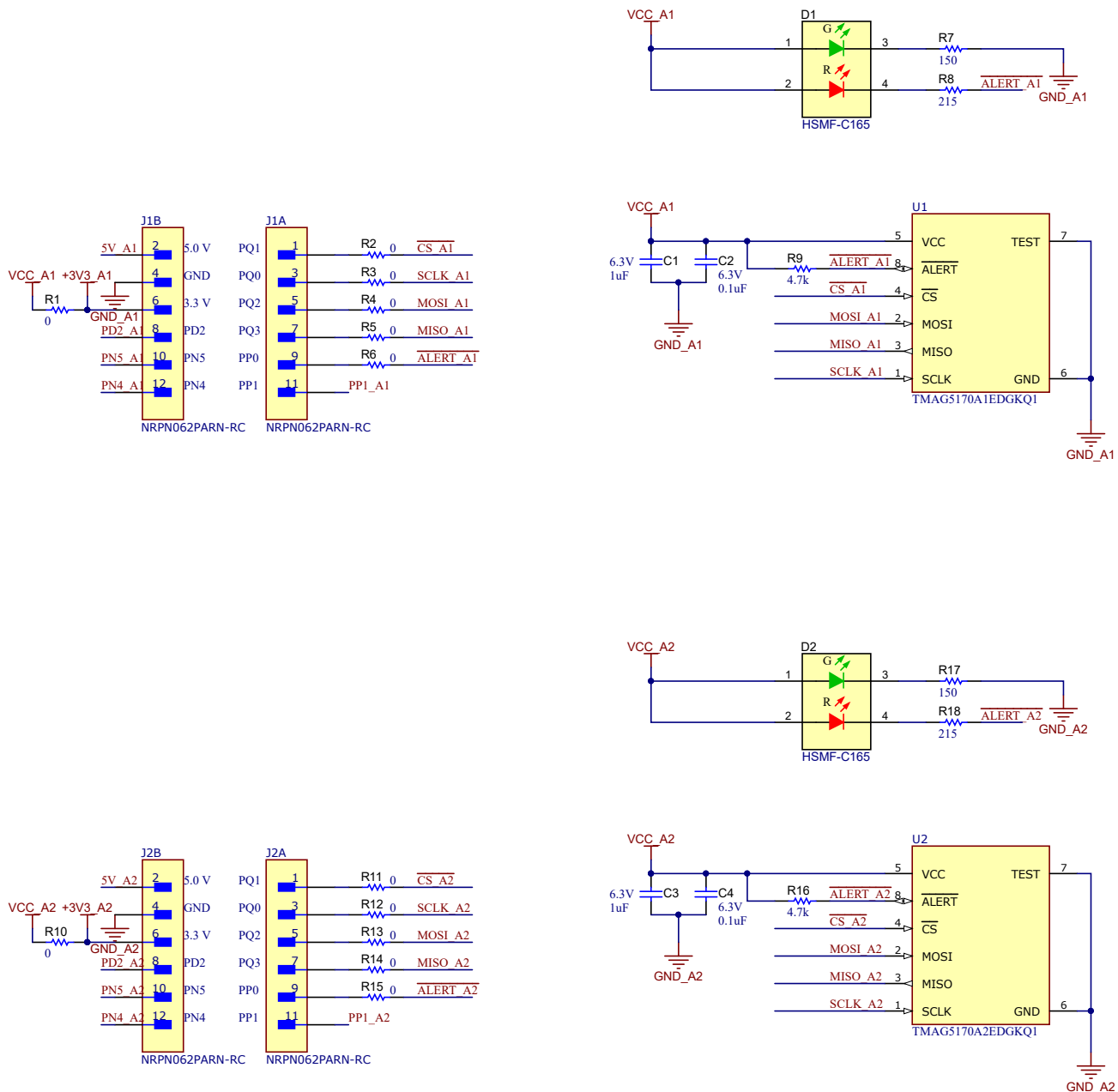

Figure 5-1. TMAG5170UEVM Schematic

H1 MECH SENS077	H2 MECH 6612041	H3 MECH D2X0	H4 MECH D82DIA	H5 MECH Rotate&PushModule	H6 MECH PC038-750-4500-SST-0598-C-N-IN
-----------------------	-----------------------	--------------------	----------------------	---------------------------------	--

FID1	FID2	FID3
-----------------	-----------------	-----------------

PCB Number: SENS083
PCB Rev: A

PCB
LOGO
Texas Instruments



PCB
LOGO
WEEE logo

PCB
LOGO
Texas Instruments



PCB
LOGO
WEEE logo

Figure 5-2. Hardware Schematic

5.2 PCB Layout

Figure 5-3 through Figure 5-6 show the PCB layers of the EVM.

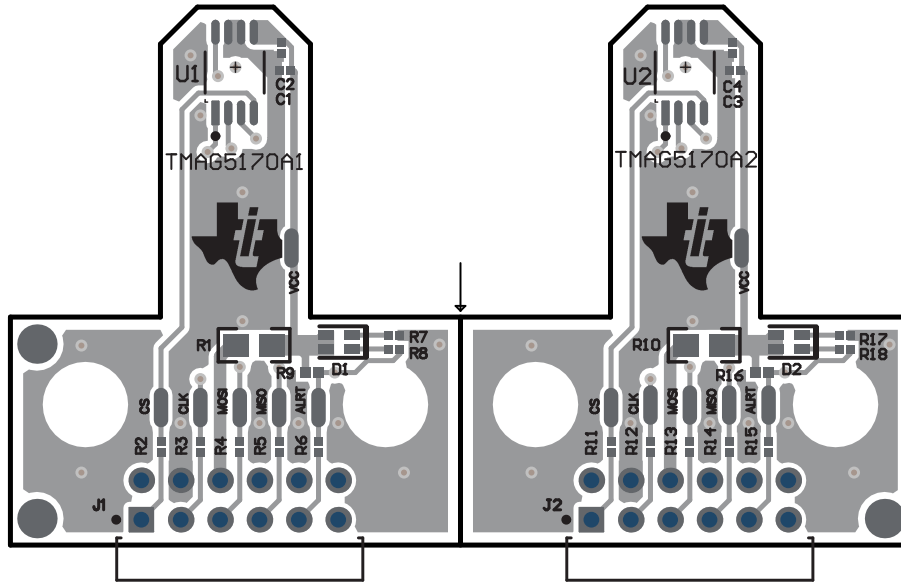

Figure 5-3. Top View

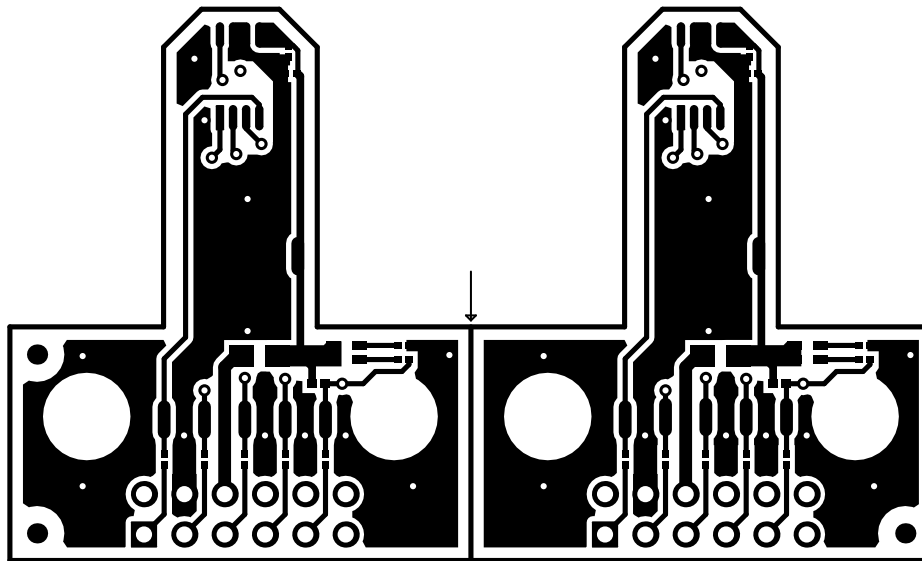

Figure 5-4. Top Layer

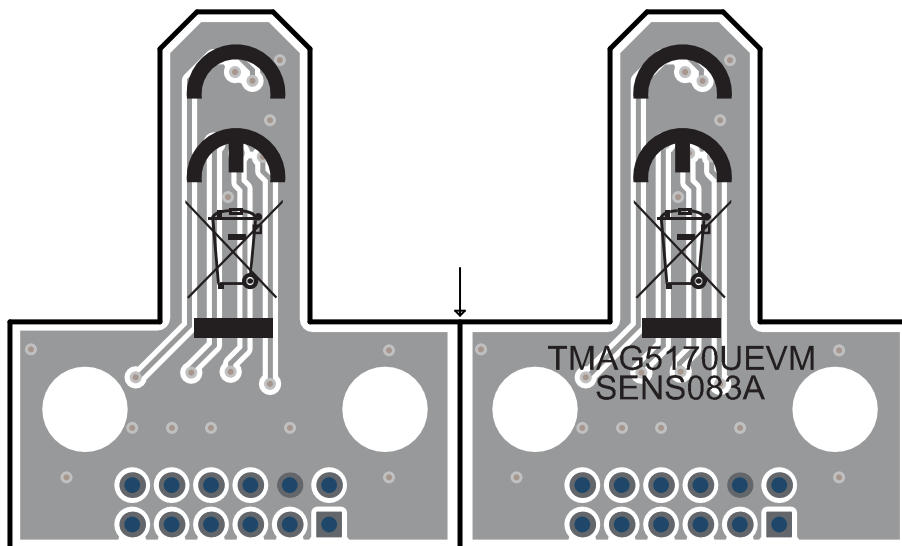

Figure 5-5. Bottom View

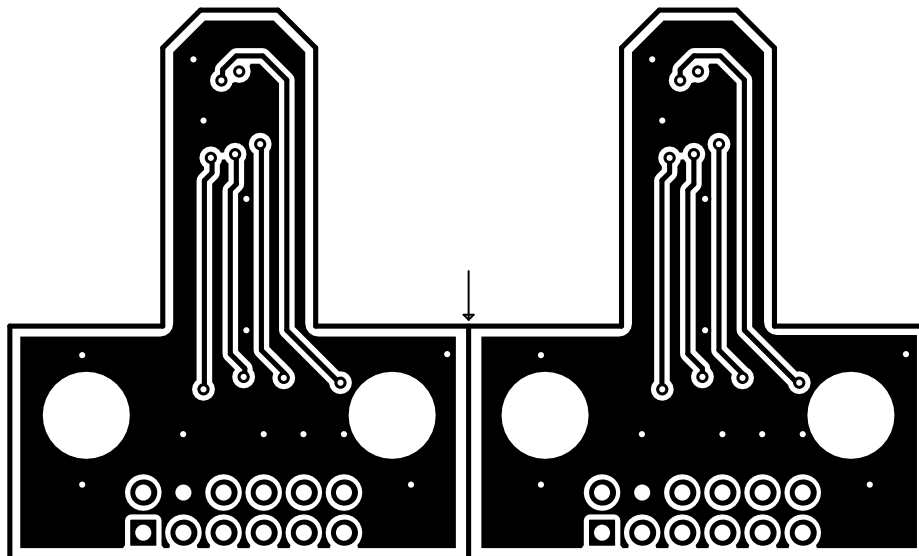

Figure 5-6. Bottom Layer

5.3 Bill of Materials

Table 5-1 provides the parts list for the EVM.

Table 5-1. Bill of Materials

Designator	Quantity	Value	Description	Package Reference	Part Number	Manufacturer
!PCB1	1		Printed Circuit Board		SENS083	Any
C1, C3	2	1uF	CAP, CERM, 1 uF, 6.3 V, +/- 20%, X5R, 0201	0201	GRM033R60J105MEA2D	MuRata
C2, C4	2	0.1uF	CAP, CERM, 0.1 uF, 6.3 V, +/- 10%, X5R, 0201	0201	GRM033R60J104KE19D	MuRata
D1, D2	2	Rg	LED, Rg, SMD	1.6x0.8mm	HSMF-C165	Avago
H1	1		Kitting Item: D2X0, 1/8" dia. x 1" thick, N42 magnet		D2X0	K&J Magnetics
H2	1		Kitting Item: D82DIA, 1/2" dia. x 1/8" thick, N42 diametric magnet		D82DIA	K&J Magnetics
H3	1		Kitting Item: Plastic module to test rotate and push setup.		Rotate&PushModule	Stratasys
H4	1		Spring for Rotate and Push Module https://www.thespringstore.com/pc038-750-4500-sst-0598-c-n-in.html		PC038-750-4500-SST-0598-C-N-IN	Access Spring
J1, J2	2			HDR12	NRPN062PARN-RC	Sullins Connector Solutions
R1, R10	2	0	RES, 0, 5%, 0.1 W, AEC-Q200 Grade 0, 0603	0603	CRCW06030000Z0EA	Vishay-Dale
R2, R3, R4, R5, R6, R11, R12, R13, R14, R15	10	0	RES, 0, 5%, 0.05 W, 0201	0201	CRCW02010000Z0ED	Vishay-Dale
R7, R17	2	150	RES, 150, 5%, 0.05 W, 0201	0201	RC0201JR-07150RL	Yageo America
R8, R18	2	215	RES, 215, 1%, 0.05 W, 0201	0201	RC0201FR-07215RL	Yageo America
R9, R16	2	4.7k	RES, 4.7 k, 5%, 0.05 W, 0201	0201	RC0201JR-7D4K7L	Yageo America
U1	1		Automotive, 3D high-precision linear Hall effect sensor with SPI bus interface 8-VSSOP -40 to 150	VSSOP8	TMAG5170A1E DGKQ1	Texas Instruments
U2	1		Automotive, 3D high-precision linear Hall effect sensor with SPI bus interface 8-VSSOP -40 to 150	VSSOP8	TMAG5170A2E DGKQ1	Texas Instruments

6 Revision History

NOTE: Page numbers for previous revisions may differ from page numbers in the current version.

Changes from Revision A (February 2022) to Revision B (August 2022) Page

- Added *TMAG5170 EVM Quick Start Video* links to the *Related Documentation* table.....2
 - Added steps to the *Quick Start Setup* instructions..... 3
 - Changed the *Firmware Debug* instructions..... 5
-

Changes from Revision * (September 2021) to Revision A (February 2022) Page

- Updated the *Kit Contents* to reflect removal of the [TI-SCB](#), which is now available independently from this device..... 2
 - Added [TI-SCB User's Guide](#) links to the *Related Documentation* table..... 2
 - Changed *Hardware* section..... 3
 - Changed *Firmware* section.....4
 - Changed hyperlink in the *GUI Setup and Usage* section..... 6
 - Changed *Bill of Materials* table..... 14
-

IMPORTANT NOTICE AND DISCLAIMER

TI PROVIDES TECHNICAL AND RELIABILITY DATA (INCLUDING DATA SHEETS), DESIGN RESOURCES (INCLUDING REFERENCE DESIGNS), APPLICATION OR OTHER DESIGN ADVICE, WEB TOOLS, SAFETY INFORMATION, AND OTHER RESOURCES "AS IS" AND WITH ALL FAULTS, AND DISCLAIMS ALL WARRANTIES, EXPRESS AND IMPLIED, INCLUDING WITHOUT LIMITATION ANY IMPLIED WARRANTIES OF MERCHANTABILITY, FITNESS FOR A PARTICULAR PURPOSE OR NON-INFRINGEMENT OF THIRD PARTY INTELLECTUAL PROPERTY RIGHTS.

These resources are intended for skilled developers designing with TI products. You are solely responsible for (1) selecting the appropriate TI products for your application, (2) designing, validating and testing your application, and (3) ensuring your application meets applicable standards, and any other safety, security, regulatory or other requirements.

These resources are subject to change without notice. TI grants you permission to use these resources only for development of an application that uses the TI products described in the resource. Other reproduction and display of these resources is prohibited. No license is granted to any other TI intellectual property right or to any third party intellectual property right. TI disclaims responsibility for, and you will fully indemnify TI and its representatives against, any claims, damages, costs, losses, and liabilities arising out of your use of these resources.

TI's products are provided subject to [TI's Terms of Sale](#) or other applicable terms available either on ti.com or provided in conjunction with such TI products. TI's provision of these resources does not expand or otherwise alter TI's applicable warranties or warranty disclaimers for TI products.

TI objects to and rejects any additional or different terms you may have proposed.

Mailing Address: Texas Instruments, Post Office Box 655303, Dallas, Texas 75265
Copyright © 2022, Texas Instruments Incorporated