

Series 2000 Reader System
Reader S251B RI-STU-251B

Reference Guide

April 2000

TIRIS *Technology by
Texas Instruments™*

Series 2000 Reader System

Reader S251B RI-STU-251B

Reference Guide

TIRIS *Technology by
Texas Instruments™*

Literature Number: SCBU035
April 2000



Preface	7
1 Introduction	9
1.1 General	10
1.2 System Description	10
1.3 Product Description	10
1.3.1 Interfaces	10
1.3.2 Communications Protocols.....	11
2 Hardware	13
2.1 General	14
2.2 Product Description	14
2.2.1 Connectors	14
2.2.2 Switches	22
2.2.3 Indicators	24
2.2.4 Potentiometers.....	24
2.3 Mechanical Information.....	24
3 Synchronization	25
3.1 Introduction.....	26
3.2 Types of Synchronization	26
3.2.1 No Synchronization	26
3.2.2 Wireless Synchronization	26
3.2.3 Wired Synchronization.....	27
3.2.4 Combined Wireless/Wired Synchronization.....	27
3.2.5 Master/Slave Synchronization	27
3.2.6 Carrier Phase Synchronization	28
4 Installation	31
4.1 Introduction.....	32
4.2 General	32
4.3 Mechanical Mounting	32
4.3.1 Power Supply	32
4.4 Communication	32
4.4.1 Configuration.....	33
4.4.2 RS232.....	33
4.4.3 RS422.....	34
4.4.4 RS485.....	34
4.5 Synchronization.....	34
4.5.1 Software Controlled	34
4.5.2 Wireless Synchronization	35
4.5.3 Wired and Combined Wireless/Wired Synchronization	35
4.5.4 Master/Slave (without acknowledgment) & Triggered Synch.....	35
4.5.5 Master/Slave (with acknowledgment).....	36
4.5.6 Transmitter Carrier Phase Synchronisation (CPS)	37
4.6 General Purpose Input/Outputs	38

4.7	LED Outputs	38
4.8	Reset.....	39
4.9	Antenna.....	39
4.10	RF Power Output Adjustment.....	39
4.11	EMI/Sync. Level Adjustment	39
5	Warnings, Cautions and Notices	41
5.1	FCC/PTT Regulations	42
5.2	Important note to Purchasers/Users of the S251B Reader in the U.S.A.....	42
5.3	WARNING.....	42

List of Figures

1-1	S251B Reader	10
2-1	S251B Front Panel (with connector covers removed).....	14
2-2	S251B Connector Locations	15
2-3	CTL Setup Switches	22
2-4	RS422/RS485/DAT Switches.....	23
2-5	Synchronization DIP Switches.....	23
3-1	Distance Between Antennas (top view)	29
4-1	Switch Settings for RS422	34
4-2	Switch Settings for RS485	34
4-3	Wired & Combined Wireless/Wired Sync. Interface	35
4-4	Master/Slave Sync. Interface Connection (without Ack.)	36
4-5	Master/Slave Synchronization Interface Connection	37
4-6	Carrier Phase Synchronisation Interface Connection	38
4-7	Connecting the LED Outputs	38
4-8	RESET Push-Button Wiring.....	39

List of Tables

2-1	List of Connectors	15
2-2	Power Range Settings.....	16
2-3	Supply Connector	16
2-4	Supply Connector – Specifications.....	16
2-5	General Purpose Inputs/Outputs	17
2-6	General Purpose Inputs/Outputs – Specifications	17
2-7	Synchronization Interface	18
2-8	Synchronization Interface – Specifications.....	18
2-9	Carrier Phase Synchronization Interface.....	18
2-10	CPS Interface – Specifications	19
2-11	Open Collector & I/Os	19
2-12	Open Collector & I/Os – Specifications.....	19
2-13	RS232 SUB-D Connector	20
2-14	RS232 WECO Connector	20
2-15	RS422/RS485 Connector	20
2-16	RS422/RS485 Communications Interface – Specifications.....	21
2-17	Indicator Outputs	21
2-18	Indicator Outputs – Specifications	21
2-19	Antenna	22
2-20	Antenna – Specifications	22
2-21	CTL Setup DIP Switches.....	22
2-22	I/O Setting Switches (6 & 7)	23
2-23	RS422/RS485/DAT Settings DIP Switches.....	23
2-24	Synchronization DIP Switches.....	23
2-25	Indicators	24
2-26	Mechanical Information.....	24
3-1	Distances Between Antennas	29
4-1	RS232 9-pin Connector	33
4-2	RS232 WECO Connector	33
4-3	RS422/RS485 Connector	34
4-4	Wired and Combined Wireless/Wired Synchronization	35
4-5	Master/Slave Synchronization Without Acknowledgment.....	36
4-6	Triggered Synchronization	36

4-7	Master/Slave Synchronization With Acknowledgment	37
4-8	General Purpose Inputs/Outputs	38
4-9	Antenna Specifications	39

Read This First

Edition One – April 2000

This is the first edition of this manual, it describes the following equipment:

TIRIS™ Reader S251B **RI-STU-251B**

About This Guide

This manual describes the TIRIS S251B Reader, its goal is to describe the reader, how it works, how to install it and how to use it.

Regulatory, safety and warranty notices that must be followed are given in Chapter 5.

Conventions

WARNING

A WARNING IS USED WHERE CARE MUST BE TAKEN, OR A CERTAIN PROCEDURE MUST BE FOLLOWED IN ORDER TO PREVENT INJURY OR HARM TO YOUR HEALTH.

CAUTION

This indicates information on conditions which must be met, or a procedure which must be followed, which if not heeded could cause permanent damage to the equipment or software.

Note: Indicates conditions which must be met, or procedures which must be followed, to ensure proper functioning of the equipment or software.

Note: Information:
Indicates information which makes usage of the equipment or software easier

If You Need Assistance

Application Centers are located in Europe, North and South America, the Far East and Australia to provide direct support. For more information, please contact your nearest TIRIS Sales and Application Center. The contact addresses can be found on our home page: <http://www.tiris.com>.

Introduction

This introduces you to the S251B Reader, what it is and what it does.

Topic	Page
1.1 General	10
1.2 System Description	10
1.3 Product Description	10

1.1 General

This document provides information about the S251B Reader. It describes the reader and how to install it.

1.2 System Description

A TIRIS system comprises a reader connected to a control device (usually a host computer) via an RS232, or an RS422/RS485 interface, an antenna and a transponder. It is used for wireless identification of TIRIS LF transponders.

The reader sends a 134.2 kHz power pulse to a transponder, the energy of the generated magnetic field is stored in the capacitor in the transponder and when the power pulse has finished the transponder immediately sends its data back to the reader.

1.3 Product Description

The Reader is an integral part of a TIRIS system, it provides all of the RF and control functions required to communicate with TIRIS LF transponders.

The main task of the Reader is to send a power pulse via the antenna to initialize the transponder, to demodulate the received identification signal and then send the data to a control device. It is also used to send programming data to Read/Write and Multipage transponders.

The Reader is housed in an IP20 Polycarbonate box as shown [Figure 1-1](#).



Figure 1-1. S251B Reader

If connected via an RS232 or an RS422/RS485 interface the computer sends commands to the reader using one of the two protocols used by the system (ASCII or TIRIS Bus Protocol), and the reader then communicates via its antenna with any transponders within that antenna's range. The antenna can be mounted up to 5 m (depending on the antenna) away from the reader.

1.3.1 Interfaces

The reader has the following connections/interfaces

- Communications interface: RS232, RS422 or RS485 (F & G)
- 8 general purpose I/O lines (B)
- 2 Open Collector outputs (E)

- Synchronization bus (C)
- Carrier Phase Synchronization bus (D)
- Power connector (A)
- Indicator outputs connector (H)
- Antenna connector (I)

1.3.2 Communications Protocols

There are two protocols that can be used with the S251B Reader, they are:

ASCII Protocol. This is a simple protocol that you can use to send ASCII character commands to the reader. It is possible to use a standard terminal emulator program to send ASCII commands. The ASCII protocol can only be used with RS232 or RS422.

TIRIS Bus Protocol. This is a binary protocol suitable for communication between a controlling device (for example: a PC) and one or more readers. For example with a single reader using an RS232 interface or up to 31 readers using RS422/485. The TIRIS Bus protocol can be used with RS232 or RS422/485.

If you are using one reader per controlling device you may choose the protocol that best suits your requirements. However, if you have more than one reader connected to a bus running under a controlling device then you must use the TIRIS Bus Protocol.

For details regarding these communications protocols, please refer to the relevant manual (11-06-21-037 [SCBU024] for the ASCII Protocol, 11-06-21-053 [SCBU026] for the TBP), available at the TIRIS home page: <http://www.tiris.com>.

Hardware

This chapter describes the hardware of the S251B Reader. It tells you which modules together comprise the reader. It also describes the front panel (switches connections etc.) and specifies the electrical inputs and outputs.

Topic	Page
2.1 General	14
2.2 Product Description	14
2.3 Mechanical Information.....	24

2.1 General

This chapter describes the hardware comprising the S251B Reader and provides the electrical specifications.

2.2 Product Description

The S251B Reader is contained in a IP20 polycarbonate box that enables easy integration into standard racks and cabinets.

The reader is shown in [Figure 1-1](#) and the front panel is shown in [Figure 2-1](#).

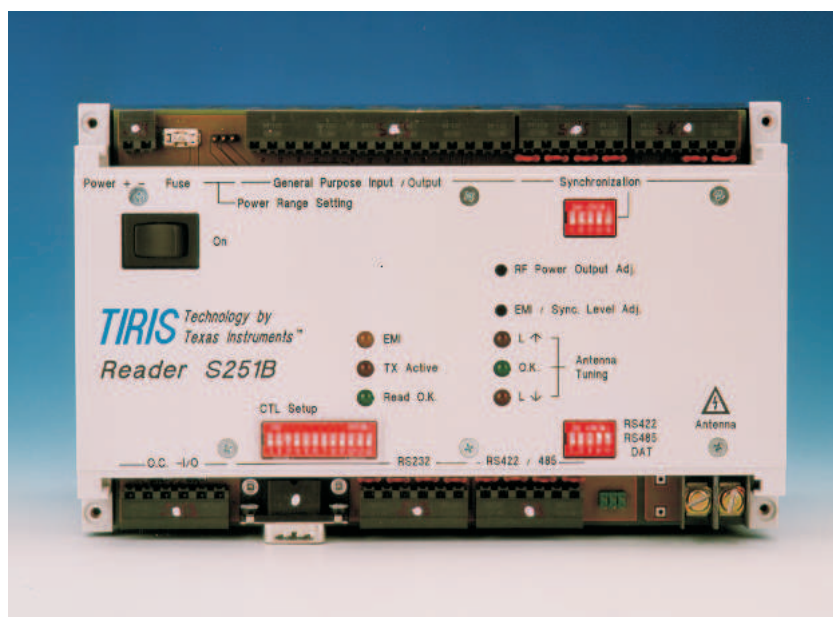

Figure 2-1. S251B Front Panel (with connector covers removed)

The reader comprises two modules assembled together in a housing. The modules are:

Control Module which contains all the circuitry required to communicate via the interface to the computer and external devices, to provide synchronization, and to control the RFM. It includes a **Dynamic Auto Tuning (DAT)** function to automatically tune the antenna to resonance.

Radio Frequency Module (RFM) which contains all the analog functions of a TIRIS reading unit that are needed to initialize a TIRIS transponder and to detect its return signal.

2.2.1 Connectors

There are 10 connectors on the S251B, 7 WECO connectors, the antenna connector, a 9-pin sub-D RS232 connector, a 6-pin connector for the indicator outputs and a 2-pin connector for the antenna. The function of each pin on each connector (except the RS232 sub-D connector) is described in the following paragraphs. Their location is shown in [Figure 2-2](#).

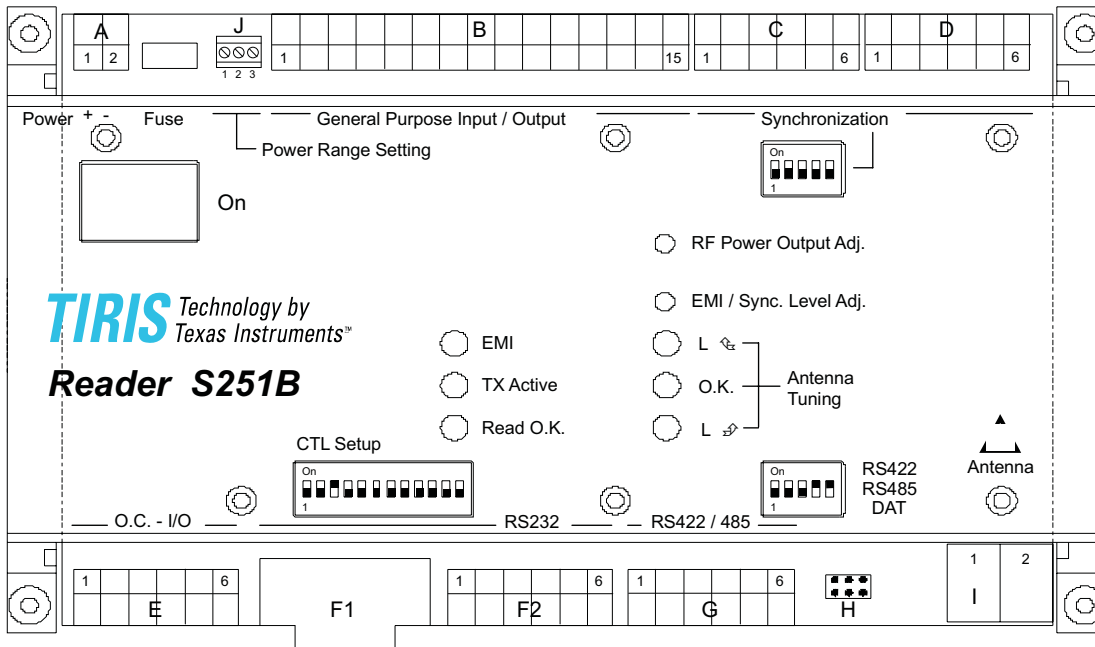

Figure 2-2. S251B Connector Locations

In order to gain access to the fuse and connector J you must first remove the upper two screws holding the front panel on, remove the plastic cover strip and then replace the two screws. To gain access to the connectors H and I you must first remove the lower two screws holding the front panel on, remove the plastic cover strip and then replace the two screws.

The pins are not individually numbered on the connectors themselves (just on [Figure 2-2](#) for your convenience).

The connectors are all marked on [Figure 2-2](#) with a letter (from A to I) and are listed in [Table 2-1](#) which also shows the section that describes them.

Table 2-1. List of Connectors

Identifying Letter	Function	Section
A	Supply Connector	2.2.1.1
B	General Purpose Inputs/Outputs	2.2.1.2
C	Synchronization Interface	2.2.1.3
D	Carrier Phase Synchronization Interface	2.2.1.4
E	Open Collector Inputs/Outputs	2.2.1.5
F1	RS232 Connector (9-pin SEB-D)	2.2.1.6
F2	RS232 Connector	2.2.1.6
G	RS422/RS485 Connector	2.2.1.7
H	Indicator Outputs	2.2.1.8
I	Antenna Connector	2.2.1.9

2.2.1.1 A – Supply Connector

The Reader requires a single DC supply voltage (10 to 24 V) through a 2-pin connector marked with + for positive and – for negative

The Power Range Setting wired jumpers (marked J in [Figure 2-2](#)) and the actual power supply have a direct consequence on the operating temperature of the reader as shown in [Table 2-2](#).

Table 2-2. Power Range Settings

Setting	Input Power	Operating Temperature Range
Pins 1 + 2 connected	10 – 15 V	–20° to +70°C
	15 – 24 V	–20° to +70°C (max. $I_{VSP} = 0.9 A_{peak}$ see caution 1).
Pins 2 + 3 connected	18 – 24 V	–20° to +70°C

CAUTION

1. In order to operate the reader over the full temperature range with pins 1 + 2 connected (15 to 24 V), the maximum current consumption must not exceed $0.9 A_{peak}$. Exceeding this value could result in unreliable functioning of the dynamic auto tuning, or sharp limitation of the transmitter output power because of internal protection. If either of these should occur, switch the device off and allow it time to recover; and then when it is switched on again it will revert to normal operation. Note that if either of these occur it is an indication that the reader is not being operated within its specifications.
2. The reader itself generates heat, therefore if it is incorporated into a housing you must ensure (by proper design and/or cooling) that the temperature immediately surrounding the reader does not exceed the operating temperature range.

Table 2-3. Supply Connector

Pin	Signal	Description	Direction
1	+	Positive supply	input
2	–	Ground	input

Table 2-4. Supply Connector – Specifications

Parameter	Minimum	Maximum
Logic Supply Voltage VSL	10 V	24 V
Logic Supply current ISL	–	2.5 A

2.2.1.2 B – General Purpose Inputs/Outputs

The Reader has eight general purpose TTL-Level Inputs/Outputs. By means of the configuration set-up, they can be set in groups of four to be Input or Output. Furthermore, there is a reset connection and a 5 V regulated output.

The pin assignment is given in [Table 2-5](#) and their specifications are given in [Table 2-6](#).

Table 2-5. General Purpose Inputs/Outputs

Pin	Signal	Description	Direction
1	GP IO 7	General Purpose I/O 7	Input/Output
2	GP IO 6	General Purpose I/O 6	Input/Output
3	GP IO 5	General Purpose I/O 5	Input/Output
4	GP IO 4	General Purpose I/O 4	Input/Output
5	GP IO 3	General Purpose I/O 3	Input/Output
6	GP IO 2	General Purpose I/O 2	Input/Output
7	GP IO 1	General Purpose I/O 1	Input/Output
8	GP IO 0	General Purpose I/O 0	Input/Output
9	–	not connected	–
10	IN1	Input 1	Input
11	IN0	Input 0	Input
12	RESET–	Reset	Input
13	VCC	Regulated 5 Volt dc Supply (see note)	Output
14	GND	Signal Ground	–
15	GND	Signal Ground	–

CAUTION

Do not connect any power supply to pin 13 as it would damage the reader. The total consumption of the two VCC outputs (General Purpose Inputs/Outputs pin 13 together with Open Collector & I/Os – pin 1) must not exceed 500 mA.

Table 2-6. General Purpose Inputs/Outputs – Specifications

Parameter	Minimum	Maximum
GP IO Output Voltage @ 6 mA		
Low level	–	0.9 V
High level	3.15 V	5.25 V
General Purpose IO Output Current		
Low level	–	25 mA
High level	–	16 mA
GP IO 1 to 4 total Output Current		10 mA
GP IO 5 to 8 total Output Current		10 mA
Regulated 5 V Output Current		100 mA

2.2.1.3 C – Synchronization Interface

The synchronization interface is used to establish hard wired synchronization with other readers through a single or double pair of wires. Its pin assignment is given in [Table 2-7](#) and its specifications are given in [Table 2-8](#).

Table 2-7. Synchronization Interface

Pin	Signal	Description	Direction
1	Sync Rx+	RS422/RS485 non-inverted synchronization data	Input
2	Sync Rx–	RS422/RS485 inverted synchronization data	Input
3	GND	Signal ground	–
4	Sync Tx+	RS422/RS485 non-inverted synchronization data	Output
5	Sync Tx–	RS422/RS485 inverted synchronization data	Output
6	GND	Signal ground	–

Table 2-8. Synchronization Interface – Specifications

Parameter	Specification
Mode of Operation	Differential
Number of Drivers On Line	32
Number of Receivers On Line	32
Maximum Cable Length	1200 m
Maximum Data Rate	10 Mbits/s
Maximum Common Mode Voltage	+12 V / –7 V
Driver Voltage	High > +1.5 V Low < –1.5 V
Driver Load	60 mA
Driver Output Short Circuit Limit	150mA to GND 250mA to VCC
Receiver Input	12 kΩ
Receiver Sensitivity	±200 mV
Receiver Hysteresis	60 mV

2.2.1.4 D – Carrier Phase Synchronization Interface

The carrier phase synchronization interface is used to establish hard wired carrier phase synchronization with other readers through a single pair of wires. Its pin assignment is given in [Table 2-9](#) and its specifications are given in [Table 2-10](#).

Table 2-9. Carrier Phase Synchronization Interface

Pin	Signal	Description	Direction
1	Sync Rx+	RS422/RS485 non-inverted synchronization data	Input
2	Sync Rx–	RS422/RS485 inverted synchronization data	Input
3	GND	Signal ground	–
4	Sync Tx+	RS422/RS485 non-inverted synchronization data	Output
5	Sync Tx–	RS422/RS485 inverted synchronization data	Output
6	GND	Signal ground	–

Table 2-10. CPS Interface – Specifications

Parameter	Specification
Mode of Operation	Differential
Number of Drivers On Line	32
Number of Receivers On Line	32
Maximum Cable Length	1200 m
Maximum Data Rate	10 Mbits/s
Maximum Common Mode Voltage	+12 V / -7 V
Driver Voltage	High > +1.5 V Low < -1.5 V
Driver Load	60 mA
Driver Output Short Circuit Limit	150mA to GND 250mA to VCC
Receiver Input	12 kΩ
Receiver Sensitivity	±200 mV
Receiver Hysteresis	60 mV

2.2.1.5 E – Open Collector & I/Os

This connector provide two open collector connections to and from the reader, plus the RXSS output (used to set the local noise level), another 5 V regulated output and an interrupt input. Its pin assignment is given in [Table 2-11](#) and its specifications are given in [Table 2-12](#).

Table 2-11. Open Collector & I/Os

Pin	Signal	Description	Direction
1	VCC	Regulated 5 Volt dc Supply (see note 1 below)	Output
2	OC1	Open collector 1	Output
3	OC0	Open collector 0	Output
4	GND	Signal ground	–
5	INT0	Interrupt 0 (see note 2 below)	Input
6	RXSS–	RXSS	Output

Notes:

1. The total consumption of the two VCC outputs (Open Collector & I/Os – pin 1 together with General Purpose Inputs/Outputs pin 13) must not exceed 500 mA.
2. This function is not used or supported by TIRIS standard firmware. It can however be used, if required, by customers who are providing their own software.

Table 2-12. Open Collector & I/Os – Specifications

Parameter	Minimum	Maximum
Open Collector Voltage to GND	1.3 V	80 V
Open Collector Current		500 mA
Regulated 5 V Output	4.75 V	5.25 V
Interrupt Input	4.75 V	5.25 V
RXSS	–	5.25 V

2.2.1.6 F1 & F2 – RS232 Communication Interface

Depending on the DIP-Switch configuration, the Reader will either communicate via the RS232, RS422 or RS485 interface.

There are two interface connectors either of which can be used for an RS232C connection. They are: a standard RS232 Interface 9-pin SUB-D male connector (F1 on [Figure 2-2](#)) and a 6-pin WECO connector (F2 on [Figure 2-2](#)). Both of these connectors allow communication between the reader and a controlling device. The pin assignment for the SUB-D connector is given in [Table 2-13](#) and the pin assignment for the WECO connector is given in [Table 2-14](#).

Both, the ASCII and TIRIS Bus protocol can be used with the RS232 interface.

Table 2-13. RS232 SUB-D Connector

Pin	Signal	Description	Direction
1	–	Not connected	–
2	TxD	Transmit Data	Output
3	RxD	Receive Data	Input
4	DTR	Data Terminal Ready	Input
5	GND	Signal Ground	–
6	DSR	Data Set Ready	Output
7	–	Not connected	–
8	–	Not connected	–
9	–	Not connected	–

Table 2-14. RS232 WECO Connector

Pin	Signal	Description	Direction
1	RxD	Receive Data	Input
2	DTR	Data Terminal Ready	Input
3	GND	Signal Ground	–
4	TxD	Transmit Data	Output
5	DSR	Data Set Ready	Output
6	GND	Signal Ground	–

All interface parameters are according to the RS232 Specification and are not given in detail in this manual. The DTR and DSR lines are currently not used for any purpose.

2.2.1.7 G – RS422/RS485 Communications Interface

Depending on the DIP-Switch configuration, the Reader will communicate via the RS232, RS422 or RS485 interface. RS422/485 connections are made via the 6-pin WECO connector (G in [Figure 2-2](#)). Its pin assignment is given in [Table 2-15](#) and its specifications are given in [Table 2-16](#).

Both, the ASCII and TIRIS Bus Protocol can be used with the RS422 interface.

The ASCII protocol (or any other full-duplex protocol) cannot be used with the RS485 interface.

Table 2-15. RS422/RS485 Connector

Pin	Signal	Description	Direction RS422	Direction RS485
1	Rx+/Tx+	RS422/RS485 non-inverted data	Input	Input/Output
2	Rx-/Tx-	RS422/RS485 inverted data	Input	Input/Output
3	GND	Signal Ground	–	–

Table 2-15. RS422/RS485 Connector (continued)

Pin	Signal	Description	Direction RS422	Direction RS485
4	Tx+	RS422 non-inverted data	Output/High Impedance	–
5	Tx–	RS422 inverted data	Output/High Impedance	–
6	GND	Signal Ground	–	–

Table 2-16. RS422/RS485 Communications Interface – Specifications

Parameter	Specification
Mode of Operation	Differential
Number of Drivers On Line	32
Number of Receivers On Line	32
Maximum Cable Length	1200 m
Maximum Data Rate	10 Mbits/s
Maximum Common Mode Voltage	+12 V / –7 V
Driver Voltage	High > +1.5 V Low < –1.5 V
Driver Load	60 mA
Driver Output Short Circuit Limit	150mA to GND 250mA to VCC
Receiver Input	12 kΩ
Receiver Sensitivity	±200 mV
Receiver Hysteresis	60 mV

2.2.1.8 H – Indicator Outputs

This connector (H in [Figure 2-2](#)) is a 2 × 3-pin (double row) pin header connection which provides the LED output signals. Its pin assignment is given in [Table 2-17](#) and its specifications are given in [Table 2-18](#).

Table 2-17. Indicator Outputs

Pin	Signal	Description	Direction
1	ACTIVE	Open collector output: RF Module transmitter signal	Output
2	V _{R270}	Current limited output: (270 Ω in series to VCC)	Output
3	O.K.	Open collector output: O.K. signal	Output
4	V _{R270}	Current limited output (270 Ω in series to VCC)	Output
5	RXSA	Receiver signal strength adjust output to monitor the receiver signal strength threshold level	Output
6	GND	Signal ground	–

Table 2-18. Indicator Outputs – Specifications

Parameter	Minimum	Maximum
Open Collector (voltage)	–	10 V
Open Collector (current)	–	80 mA
Maximum voltage at current limiting 270 Ω resistor	–	5 V
Receiver signal strength output voltage (RXSA)	0.7 V	1.7 V

2.2.1.9 I – Antenna Connector

The antenna must be connected to the reader via the antenna terminals. The pin assignment for the antenna connector is given in [Table 2-19](#). If a custom designed antenna is used, it must be within the specifications defined in [Table 2-20](#) in order to ensure that the dynamic autotuning facility functions correctly.

Table 2-19. Antenna

Pin	Signal	Description
1	ANT	Tx/Rx antenna
2	ANT	Tx/Rx antenna

Table 2-20. Antenna – Specifications

Parameter	Minimum	Maximum
Antenna Resonance Voltage	–	380 Vpeak
Antenna Inductance	26.0 μ H	27.9 μ H
Antenna Q-factor	40	350

2.2.2 Switches

There are three banks of DIP switches on the S251B Reader, one is for the Control Module set-up (12 switches), one is for the RS422/RS485/DAT settings (5 switches), and the third one is for the synchronization settings (5 switches). The Control Module set-up switches are listed in [Table 2-21](#), the RS422/RS485/DAT settings are listed in [Table 2-23](#), and the synchronization settings switches are listed in [Table 2-24](#). The ON position and switch 1 are always shown in the switch bank, the switch is on when the switch is set to the up position.

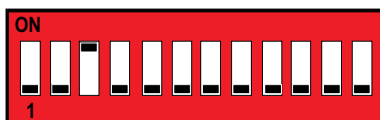

Figure 2-3. CTL Setup Switches

Table 2-21. CTL Setup DIP Switches

Switch	OFF	ON
1	RAM – VCC	–
2	Chip Select ROM for TIRIS Standard Firmware	Reserved for Software Development
3	Reserved for Software Development	Chip Select RAM for TIRIS Standard Firmware
4	Chip Select RAM for TIRIS Standard Firmware	Reserved for Software Development
5	PSEN	Reserved for Software Development
6	See Table 2-22	
7	See Table 2-22	
8	TIRIS Standard Configuration	Customer Specific Configuration
9	Reserved	
10	Reserved	

Table 2-21. CTL Setup DIP Switches (continued)

Switch	OFF	ON
11	TXCT-ON ⁽¹⁾	
12	Not Connected	

⁽¹⁾ When this switch (11) is switched either from ON-to-OFF or from OFF-to-ON the reader's transmitter is activated for 10 seconds.

Table 2-22. I/O Setting Switches (6 & 7)

SW6	SW7	Comment
OFF	OFF	No effect
ON	ON/OFF	Reset reader by switching RS232 DTR line
OFF	ON	Can be used by customer firmware for hardware handshake

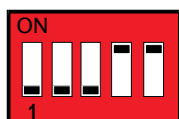

Figure 2-4. RS422/RS485/DAT Switches

Table 2-23. RS422/RS485/DAT Settings DIP Switches

Switch	OFF	ON
1	RS422	RS485
2	RS422	RS485
3	–	RS422/RS485 Rx+/Rx– line-to-line termination (120 Ω)
4	DAT Disabled	DAT Enabled
5	DAT LEDs Disabled	DAT LEDs Enabled

Note: SW1 and SW2 must always be in the same position as each other, either both OFF or both ON.

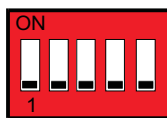

Figure 2-5. Synchronization DIP Switches

Table 2-24. Synchronization DIP Switches

Switch	OFF	ON
1	–	Synchronization Rx+ line pull-up (180 Ω)
2	–	Synchronization Rx– line pull-down (180 Ω)
3	–	RS422/RS485 Rx+/Rx– line-to-line termination (120 Ω)
4	Set the RFM to Master	Set the RFM to Slave in CPS Bus
5	–	CPS line-to-line termination (120 Ω)

2.2.3 Indicators

There are six LEDs on the front panel of the reader they are described in [Table 2-25](#).

Table 2-25. Indicators

Indicator		Description
EMI		Indicates the presence of Electro Magnetic interference
TX Active		Indicates activation of the RF transmitter
Read O.K.		Indicates a response from a valid transponder
Antenna Tuning	L↑	Antenna out of tune, inductance too high
	O.K.	The DAT has tuned the antenna to maximum resonance voltage
	L↓	Antenna out of tune, inductance too low

The TX Active and Read O.K. LED lines are also made available for external use if required, details are given in section 4.7.

2.2.4 Potentiometers

There are two potentiometers that can be adjusted through the reader front panel, they are: the RF Power Output adjustment potentiometer (2.2.4.1) and the EMI/Sync. Level adjustment potentiometer (2.2.4.2).

2.2.4.1 RF Power Adjustment

The potentiometer can be used to adjust the internal oscillator pulse width and thus the generated antenna voltage/field strength. Turning the potentiometer clockwise causes the field strength to be increased.

2.2.4.2 EMI/Sync. Level Adjustment

This potentiometer allows the receiver signal strength threshold level to be adjusted for wireless synchronization. Turning the potentiometer clockwise results in maximum sensitivity.

There is one fuse on the S251B that is: 2A Slow-blow. If the fuse should blow, replace it with the replacement fuse supplied with your reader.

2.3 Mechanical Information

The mechanical dimensions and weight are given in [Table 2-26](#).

Table 2-26. Mechanical Information

Parameter	Value
Height	120 mm
Width	120 mm
Length	200 mm
Weight	900 g

Synchronization

If you are using more than one reader in an application, it may mean that you need to synchronize their operation so that they do not interfere with each other. This chapter describes the various synchronization options.

Topic	Page
3.1 Introduction.....	26
3.2 Types of Synchronization	26

3.1 Introduction

Where multiple readers are operating in the same area, it is necessary to coordinate the activities of those readers to avoid mutual interference. This is known as synchronization. Synchronization in this context means that the readers in your application are controlled in such a way that they do not interfere with each other.

There are several types of synchronization that can be used depending on the situation in a particular application, for example: the type of transponder, the type of operation performed on that transponder (Charge-only read, General read, Program page, Lock page), the size of the antennas and the speed of the transponder. The different kinds of synchronization are described in section 3.2. How to actually set-up your system to use the synchronization you've chosen is described together with the other installation procedures in Chapter 5.

The distance that readers' antennas have to be separated before the need for some method of synchronization is required, varies with local conditions, for in addition to purely airborne (radiated) interference, signals can travel from one reader to another via metal structures (conducted). Metal structures can include the frames of metal buildings, reinforcing bars in concrete floors and power or data cables.

3.2 Types of Synchronization

The S251B Reader can be configured to synchronize in a number of different ways:

- No Synchronization (3.2.1)
- Wireless Synchronization (3.2.2)
- Wired (3.2.3)
- Combined Wireless/Wired (3.2.4)
- Master/Slave Synchronization (3.2.5)
- Carrier Phase Synchronization (3.2.6)

3.2.1 No Synchronization

This option is only used in conjunction with Software synchronization, or if there is only a single reader. No sync. and Master/Slave sync without acknowledgment are the fastest methods of reading transponders.

If all readers are connected by the same RS485 data network, coordination of the readers can be controlled directly by the Host Computer. For example, the Host Computer may issue a Broadcast command for all readers to simultaneously perform a read cycle and buffer the result. Another technique possible using the data network is to issue individual commands to each reader in turn. This technique is used when writing data to Multipage Transponders (MPTs). Where a PLC has a number of point-to-point connections to readers, it is also possible to coordinate the activities via the ladder logic. With Software synchronization all readers will be simultaneously transmitting or, each reader individually operating. In both cases the readers can be configured to have No Synchronization.

3.2.2 Wireless Synchronization

Wireless synchronization can be used to control the coordination of readers, with standard antennas, provided the electrical noise in the environment is low for the type of antenna in use and the noise levels are constant.

Wireless synchronization is only valid for charge-only reading of transponders.

During operation, when the reader detects noise above the adjusted background level it assumes that it is another reader and "backs-off" for a set period before commencing its own cycle. Wireless synchronized readers can read together or alternately.

Advantages:

1. There are no wires to run.
2. All readers are autonomous (no Master unit).
3. Enables Hand held readers to co-exist with fixed units (using wireless synchronization).

Disadvantages:

1. In noisy environments, there is too much sensitivity with larger antennas (G04 and larger custom antennas) to allow accurate setting of the background levels.
2. It is not suitable for operations other than Charge-only read.
3. It cannot be used when other readers are writing information to transponders.
4. Where the environmental conditions change, for example: a ground loop antenna's characteristics are changed by a vehicle over it, the synchronization adjustment could be wrong.

3.2.3 **Wired Synchronization**

Wired Synchronization works in the same way as wireless synchronization with the exception that the reader obtains its information about the presence of another reader through a hard wired connection and not via the antenna.

Advantages:

1. It is a Peer-to-Peer network and does not need a Master unit.
2. It use a single twisted pair cable.

Disadvantages:

1. It is only suitable for charge-only reading of transponders.
2. It cannot be used when other readers are writing information to transponders.
3. If the power fails at any of the readers the bus fails.

3.2.4 **Combined Wireless/Wired Synchronization**

When this option is selected, groups of reader connected by the wired synchronization cabling can synchronize with other groups of wired synchronization readers, or with individual readers, by using wireless synchronization.

The advantages and disadvantages of both wireless and wired synchronization as given above still apply.

3.2.5 **Master/Slave Synchronization**

Master/Slave Synchronization is probably the most commonly used form of synchronization. One reader is configured to be the **Master** and this reader then controls all the other readers, which are configured as **Slaves**.

There are three variants:

- Master/Slave Synchronization without Acknowledgment,
- Master/Slave Synchronization with Acknowledgment
- Triggered Synchronization.

3.2.5.1 **M/S Synchronization without Acknowledgment**

This method of synchronization is the fastest method of reading transponders and was originally developed for reading tagged vehicles at speed. It assumes that all readers are on the same synchronization bus and the readers would not, for example, recognize a handheld reader that is trying (probably unsuccessfully) to perform a reading.

Advantages:

1. Uses a single twisted pair cable.
2. Has the fastest read rate.
3. The Master can be used for Charge-only read or Write/Program.

Disadvantages:

1. All readers must be on the same synchronization bus.
2. If the Master fails, all units stop.
3. Slave units cannot be individually tested without the Master running.
4. Slaves must perform exactly the same RF-Task as the Master (read the same page, write the same data to a transponder).

3.2.5.2 M/S Synchronization with Acknowledgment

In Master/Slave Synchronization without acknowledgment, if a slave reads a transponder and the master doesn't, the slave may miss the next pulse while it is processing the reading from that transponder. In Master/Slave with Acknowledgment the Master has to wait until all slaves have completed their current cycle before initiating the next cycle. This is achieved by using a 4 wire synchronization bus (twin twisted pair) with the slave transmit lines coupled back to the Master receive lines.

This method has the following advantages over Master/Slave without Acknowledge

1. All units can Write/Program transponders (providing they do it together).
2. They wait for the slowest to complete.

Disadvantages:

1. The cable is a twin twisted pair.
2. The readers cannot be too close if writing is performed, because of the possibility of corrupted data. This restriction also includes the paged read of multipage transponders.

3.2.5.3 Triggered Synchronization

Triggered Synchronization is a Master/Slave Synchronization Bus where there is just a pulse signal. All readers are configured as masters, but it is only one unit or a trigger pulse source that issues the synchronization pulse at suitable intervals for the required operations on the transponder.

The more complex version of this is known as a Timing Bus, when different time windows are defined for different operations to be carried out, for example: If multiple readers are required to read addressed pages of Multipage transponders, then to write data back to the transponders, the timing bus would start a read window lasting 90 ms then initiate a time window of 320 ms for a write operation. In this way the differing times required for the two operations can be accommodated. At the same time the readers would be instructed thru the communication interface, about which command to execute during each window. Therefore the slaves have to receive their command before the master

Advantages:

1. The master unit has total control over the coordination of the connected devices and can allow 'windows' for particular operations.
2. Reading and Writing can be accommodated, if there is sufficient separation to prevent data corruption during the Write process.

Disadvantages:

1. Cannot be used for addressing MP transponders if readers are close together as addressing conflicts can arise.
2. Carrier Phase synchronization cannot be used.

3.2.6 Carrier Phase Synchronization

In some applications it is necessary to use several charge-up antennas close to each other. In these circumstance, the magnetic charge-up fields generated by different antennas superimpose on each other and may cause a beat effect on the magnetic charge-up field, due to the slightly different transmission phases of different Power readers. This effect will not occur when the transmitters of different readers are operated from the same oscillator signal.

This is Carrier Phase Synchronization where all of the readers in a system use the same oscillator. Carrier Phase synchronization must be used whenever Gate or Stick antennas are facing each other and if they are inside the distances D1 or D2 as given in Table 3-1 (Figure 3-1 shows the places to measure D1 and D2). This ensures that there will not be any “beat effect” between the antennas.

Note: Remember that putting two antennas close together also changes antenna inductance, so that the antennas may no longer be tuneable to resonance.

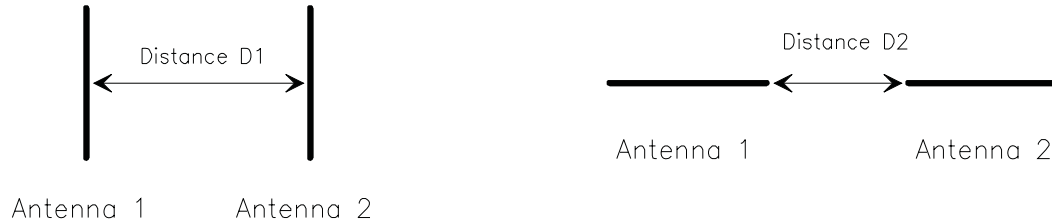

Figure 3-1. Distance Between Antennas (top view)

Table 3-1. Distances Between Antennas

Antenna Type	Distance D1 [m]	Distance D2 [m]
RI_ANT_S02 <=> RI_ANT_S02	0.8	1.0
RI_ANT_G01 <=> RI_ANT_G01	1.7	1.5
RI_ANT_G02 <=> RI_ANT_G02	1.3	1.0
RI_ANT_G04 <=> RI_ANT_G04	2.0	1.7

Installation

This chapter provides you with the information that you need to know in order to install the reader.

This chapter also describes how to incorporate the various synchronization options.

Topic	Page
4.1 Introduction.....	32
4.2 General.....	32
4.3 Mechanical Mounting.....	32
4.4 Communication.....	32
4.5 Synchronization.....	34
4.6 General Purpose Input/Outputs.....	38
4.7 LED Outputs.....	38
4.8 Reset.....	39
4.9 Antenna.....	39
4.10 RF Power Output Adjustment.....	39
4.11 EMI/Sync. Level Adjustment.....	39

4.1 Introduction

Note: Always ensure that the reader is switched off when making or breaking connections to it.

4.2 General

The S251B Reader has been designed with easy installation in mind. The following information provides you with any details such as switch settings and so on that you will need to know.

4.3 Mechanical Mounting

- a. If you are mounting the reader on a DIN rail TS35, clip the reader into the bottom of the rail and then snap it into the top.
- b. If you are mounting the reader onto a wall where there is No vibration, snap in the four mounting adapters and screw the reader to the wall using M4 screws.
or
- c. If you are mounting it onto a wall where it may be subject to vibration, open the reader, drill thru the marked mounting holes and screw the reader to the wall using M4 screws and the appropriate washers.

WARNING

CARE MUST BE TAKEN WHEN HANDLING THE S251B. HIGH VOLTAGE ACROSS THE ANTENNA TERMINALS COULD BE HARMFUL TO YOUR HEALTH. IF THE ANTENNA INSULATION IS DAMAGED THE ANTENNA SHOULD NOT BE CONNECTED TO THE S251B.

4.3.1 Power Supply

Connect a Regulated dc power supply (between 10 and 24 V providing a minimum of 2A) to the reader – the polarity of the connection is shown on the front panel of the reader.

Set the Power Range Setting wire bridge to match your input voltage (see [Table 2-2](#)).

We recommend that you use a linear power supply. If this is not possible and you wish to use a switched mode power supply, DO NOT use one that operates below 200 kHz. (switched mode power supplies that operate below 200 kHz. might interfere with transponder signals and thus reduce the reading range).

4.4 Communication

Follow the instructions given in the section that describes the communications set-up that you have decided to use in your system: Section 4.4.2 for RS232, Section 4.4.3 for RS422 and Section 4.4.4 for RS485.

4.4.1 Configuration

CTL Setup switch 8 determines the mode of operation of the control module when power is applied to the control module. When CTL Setup switch 8 is in the OFF position, standard TIRIS default parameters are used, these are:

- ASCII protocol
- 9600 baud, eight databits, no parity, one stop bit, X_{on}/X_{off} enabled
- Normal Mode
- Wireless synchronization
- I/O 0 to 3 defined as input
- I/O 4 to 7 defined as output and logic high
- Hardware interface RS232C

If CTL Setup switch 8 is in the ON position, customer specific parameters are used to operate the Control Module. These application specific parameters are stored in the serial EEPROM on the Control Module.

Note: The setting of CTL Setup switch 8 is only checked after power on.

You can use the Software Utility Program which is available on the internet at our site: <http://www.tiris.com> to configure your reader.

In order to configure the reader for customer specific parameters you must connect the reader via the RS232 port (connector F1 or F2) to your host and get connection using the TIRIS standard parameters (with CTL Setup switch 8 is in the OFF position). Change the default parameters to the customer specific parameters and save them. Set CTL Setup switch 8 to the ON position and reset the reader. The reader will then work with the customer specific parameters.

4.4.2 RS232

Either connect a 9-pin SUB-D female plug to the SUB-D connector, or connect up the 6-pin WECO connector marked "RS232" on the reader's front panel, the pin signals are given in [Table 4-1](#) or [Table 4-2](#).

Table 4-1. RS232 9-pin Connector

Pin	Signal	Description	Direction
1	–	Not connected	–
2	TxD	Transmit Data	Output
3	RxD	Receive Data	Input
4	DTR	Data Terminal Ready	Input
5	GND	Signal Ground	–
6	DSR	Data Set Ready	Output
7	–	Not connected	–
8	–	Not connected	–
9	–	Not connected	–

Table 4-2. RS232 WECO Connector

Pin	Signal	Description	Direction
1	RxD	Receive Data	Input
2	DTR	Data Terminal Ready	Input
3	GND	Signal Ground	–
4	TxD	Transmit Data	Output
5	DSR	Data Set Ready	Output
6	GND	Signal Ground	–

4.4.2.1 Activation

The Data Terminal Ready signal (DTR) is connected to the reset/watchdog circuit of the S251B Reader. This ensures a PC controlled microcomputer initialization before the default Read Mode is started.

When power is applied to the reader the Data Set Ready signal (DSR) of the RS232-C interface is activated.

4.4.3 RS422

Connect the WECO (marked RS422/485) connector as shown in [Table 4-3](#). Set the switches as shown in [Figure 4-1](#). If you are only using one reader the line terminal switch 3 must be switched to ON, if you are using more than one reader only the last reader in the line must be switched to ON (all other readers to OFF).

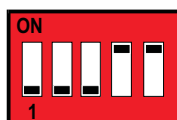

Figure 4-1. Switch Settings for RS422

Table 4-3. RS422/RS485 Connector

Pin	Signal	Description	Direction RS422	Direction RS485
1	Rx+/Tx+	RS422/RS485 non-inverted data	Input	Input/Output
2	Rx-/Tx-	RS422/RS485 inverted data	Input	Input/Output
3	GND	Signal Ground	–	–
4	Tx+	RS422 non-inverted data	Output/High Impedance	–
5	Tx-	RS422 inverted data	Output/High Impedance	–
6	GND	Signal Ground	–	–

4.4.4 RS485

Connect the WECO (marked RS422/485) connector as shown in [Table 4-3](#). Set the switches as shown in [Figure 4-2](#). If you are only using one reader the line terminal switch 3 must be switched to ON, if you are using more than one reader only the last reader in the line must be switched to ON (all other readers to OFF).

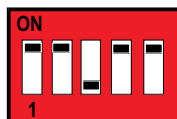

Figure 4-2. Switch Settings for RS485

4.5 Synchronization

4.5.1 Software Controlled

There is no special wiring required for this type of synchronization. Make sure that you set the software configuration to No Sync. when you are configuring the reader.

4.5.2 Wireless Synchronization

There are no switch or jumper settings for wireless synchronization. Make sure that you set the software configuration to wireless synchronization when you are configuring the reader.

4.5.3 Wired and Combined Wireless/Wired Synchronization

Figure 4-3 shows in which way the S251B Reader must be connected for a wired and a combined wireless/wired synchronization. Make sure that you set the software configuration to match when you are configuring the reader. Table 4-4 explains the setting of the Synchronization DIP switches 1, 2 & 3.

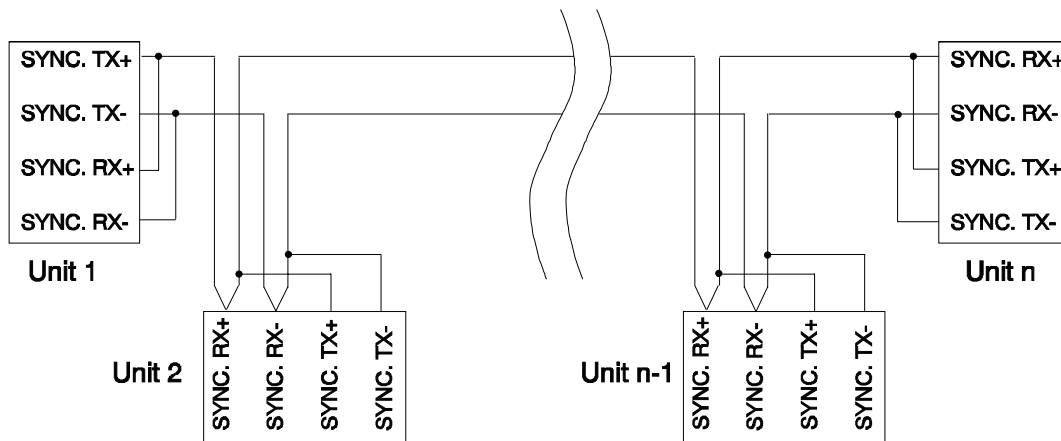

Figure 4-3. Wired & Combined Wireless/Wired Sync. Interface

Table 4-4. Wired and Combined Wireless/Wired Synchronization

Line Termination Dip Switch	UNIT 1:	UNIT 2...UNIT -1:	UNIT n:
SW1	ON	OFF	ON
SW2	ON	OFF	ON
SW3	ON	OFF	ON (see Note)

Note: If the distance between Unit 1 and Unit n is less than approximately 400 m, DIP switch SW3 can be left OFF.

4.5.4 Master/Slave (without acknowledgment) & Triggered Synch.

Figure 4-4 shows the way that the Readers have to be connected for master/slave synchronization without acknowledgment; and triggered synchronization. Make sure that you set the software configuration to Master or Slave (according to Table 4-5 and Table 4-6 acknowledgment) when you are configuring the reader.

Table 4-5 and Table 4-6 show the settings of the Line termination DIP switches.

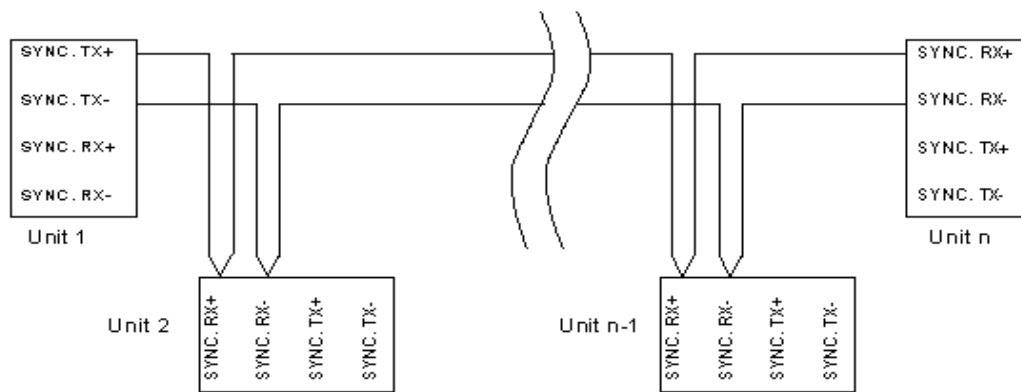
Figure 4-4. Master/Slave Sync. Interface Connection (without Ack.)
Table 4-5. Master/Slave Synchronization Without Acknowledgment

Line Termination Dip Switch	UNIT 1: (Master)	UNIT 2...UNIT -1: (Slaves)	UNIT n: (Slave)
SW1	ON	OFF	ON
SW2	ON	OFF	ON
SW3	ON	OFF	ON (see Note)

Note: If the distance between Unit 1 and Unit n is less than approximately 400 m, DIP switch SW3 can be left OFF.

Table 4-6. Triggered Synchronization

Line Termination Dip Switch	UNIT 1: Trigger Unit	UNIT 2...UNIT -1: (Master)	UNIT n: (Master)
SW1	Termination not required	OFF	ON
SW2	Termination not required	OFF	ON
SW3	Termination not required	OFF	ON (see Note)

4.5.5 Master/Slave (with acknowledgment)

Figure 4-5 shows the way that the Readers have to be connected for master/slave synchronization with acknowledgment. Make sure that you set the software configuration to Master or Slave (according to Table 4-7) when you are configuring the reader.

Table 4-7 shows the setting of DIP switch switches 1, 2 & 3.

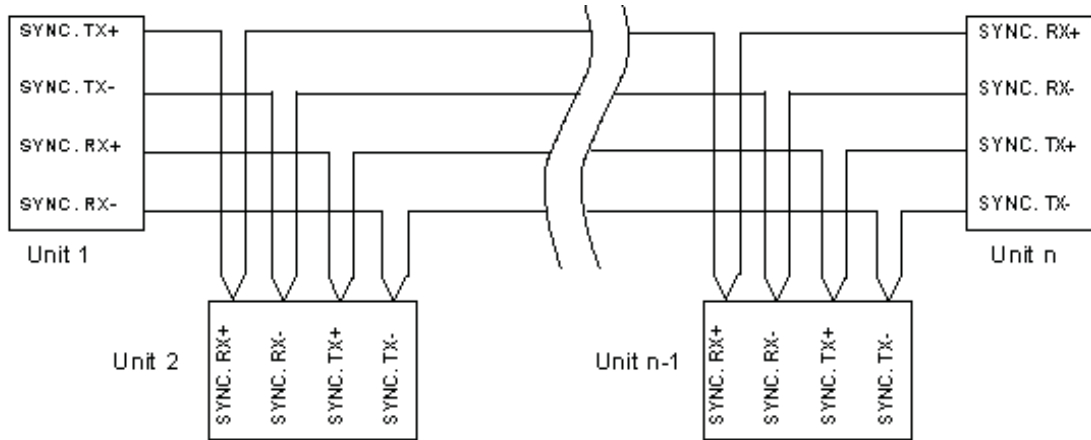

Figure 4-5. Master/Slave Synchronization Interface Connection

Table 4-7. Master/Slave Synchronization With Acknowledgment

Line Termination Dip Switch	UNIT 1: (Master)	UNIT 2...UNIT n-1: (Slaves)	UNIT n: (Slave)
SW1	ON	OFF	ON
SW2	ON	OFF	ON
SW3	ON	OFF	ON (see Note)

Note: If the distance between Unit 1 and Unit n is less than approximately 400 m, DIP switch SW3 can be left OFF.

4.5.6 Transmitter Carrier Phase Synchronisation (CPS)

To allow you to overcome the beat effect, the pulse width modulated oscillator signal is accessible at the CPS connector D. All readers to be driven by one oscillator must have their CPS connectors connected together as shown in [Figure 4-6](#).

DIP switch Synchronization-SW4 determines whether the internal oscillator or the external oscillator signal is used. When the DIP switch Synchronization-SW4 is OFF, the internal oscillator is used and the reader is referred to as an oscillator MASTER. When the DIP Switch Synchronization-SW4 is ON, the external oscillator signal is used and the reader is referred to as an oscillator SLAVE.

Note: Only one oscillator MASTER is allowed per synchronized system.

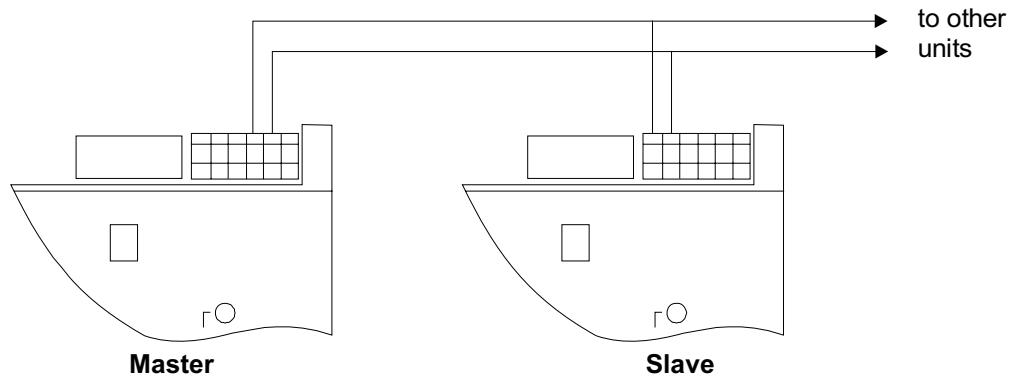

Figure 4-6. Carrier Phase Synchronisation Interface Connection

4.6 General Purpose Input/Outputs

The S251B Reader has 8 connections that can be defined as either inputs or outputs (TTL level). These input/outputs must be configured in groups of 4 as shown in [Table 4-8](#).

Table 4-8. General Purpose Inputs/Outputs

I/O ⁽¹⁾				I/O ⁽¹⁾			
0	1	2	3	4	5	6	7
I	I	I	I	I	I	I	I
I	I	I	I	O	O	O	O
O	O	O	O	I	I	I	I
O	O	O	O	O	O	O	O

(1) I = Input; O = Output

4.7 LED Outputs

The signals used for the indicator LEDs (Read O.K. and Transmitting) are available at Indicator Outputs connector (H), they can be used to drive external LEDs or buzzers, they must be connected as shown in [Figure 4-7](#). Ensure that the values given [Table 2-18](#) are not exceeded.

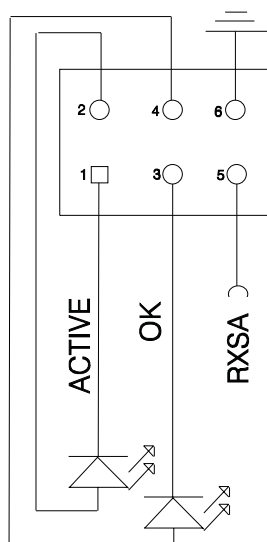

Figure 4-7. Connecting the LED Outputs

4.8 Reset

The S251B Reader provides a connection for an external reset on pin 12 of the General Purpose Input/Output connector (B). This pin can be used reset the S251B Reader externally. You can apply an external reset to the reader by connecting a push-button to the connectors as shown in Figure 4-8.

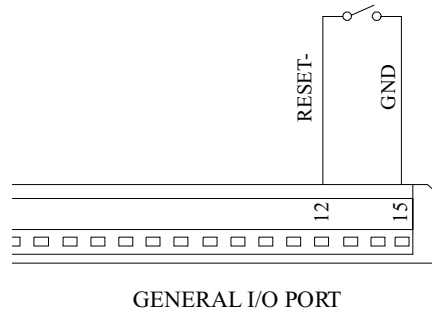

Figure 4-8. RESET Push-Button Wiring

4.9 Antenna

The S251B Reader can be used together with the TIRIS antennas RI-ANT-G01E, RI-ANT-G02E, RI-ANT-G04E and RI-ANT-S02C. If you wish to use it with your own design antenna that antenna must conform to the specifications given in Table 4-9.

Note: The Stick Antenna (RI-ANT-S02C) must only be used together with a reader supply voltage up to 12 V. If you use this antenna with a higher reader supply voltage the antenna becomes too warm which effects the antenna's Q.

Table 4-9. Antenna Specifications

Parameter	Minimum	Maximum
Antenna Resonance Voltage	–	380 V _{peak}
Antenna Inductance	26.0 μH	27.9 μH
Antenna Q-factor	40	350

The antenna must be connected to the terminals marked Antenna on the S251B.

4.10 RF Power Output Adjustment

Use the RF Power Output Adj. potentiometer to adjust the internal oscillator pulse width and subsequently the antenna output voltage to conform to your local regulations. Turning the potentiometer clockwise causes the field strength to increase.

4.11 EMI/Sync. Level Adjustment

EMI/Sync. Level Adj. potentiometer to adjust the receiver signal strength threshold for the wireless synchronization. Turning the potentiometer clockwise results in a maximum sensitivity.

If wireless synchronization is used, it is important that the EMI/Sync level Adj. potentiometer is correctly adjusted. This is one of the final adjustments to the reader and is done on site in the final location once the antenna has been tuned and ALL THE OTHER READER ARE SWITCHED OFF.

EMI/Sync. Level Adjustment

Turning the potentiometer adjusts the receiver signal level threshold and you must set the reader's 'base level noise' in its final location, so that any signal larger than the base level triggers the synchronization algorithm.

Send a single 'X' (execute command) to the reader to stop any continuous reading, and then turn the potentiometer clockwise until the yellow LED is fully lit. Slowly adjust the potentiometer back until the LED just goes out. Adjustment is then complete.

Warnings, Cautions and Notices

This chapter provides the Warnings, Cautions and Notices that are relevant to the S251B reader.

Topic	Page
5.1 FCC/PTT Regulations	42
5.2 Important note to Purchasers/Users of the S251B Reader in the U.S.A.	42
5.3 WARNING	42

5.1 FCC/PTT Regulations

The TIRIS Reader RF produces emissions at 134.2 kHz. The radiation of the fundamental and the harmonics will vary with the type of antenna and other devices or functions connected to the Reader.

Prior to operating the S251B Reader together with antenna(s) and power supply, the required FCC, PTT or relevant government agency approvals must be obtained. Sale, lease or operation in some countries may be subject to prior approval by the government or other organizations.

5.2 Important note to Purchasers/Users of the S251B Reader in the U.S.A.

The TIRIS Reader is considered by the Federal Communications Commission (FCC) to be a "subassembly". As such, no prior approval is required to import, sell or otherwise market the Reader in the United States. In order to form a functioning radio frequency (RF) device, the Reader must be connected to a suitable antenna and power supply. A radio frequency device may not be operated unless authorized by the FCC nor may a radio frequency device be marketed (i.e. sold, leased, imported, or advertised for sale or lease) without the prior grant of an FCC equipment authorization.

FCC authorization to operate an RF device may take one of two forms: first, the FCC may grant the user an experimental license; second, the FCC may issue an equipment authorization permitting use of the RF device on an unlicensed basis. TI can assist the user in obtaining an experimental license that will cover a specific installation of the S251B Reader in a specific site or sites. Experimental authorizations are appropriate to cover operations during the development of an RF device. A grant of equipment authorization (known as "certification") must be obtained from the FCC before RF devices are marketed or operated on a non development basis.

DEVICES CONSTRUCTED FOR EVALUATION INCORPORATING THIS Reader SHOULD BE OPERATED ONLY UNDER AN EXPERIMENTAL LICENSE ISSUED BY THE FCC AND MAY NOT BE MARKETED. BEFORE ANY DEVICE CONTAINING THIS Reader IS MARKETED, AN EQUIPMENT AUTHORIZATION FOR THE DEVICE MUST BE OBTAINED FROM THE FCC.

Prospective marketers of devices containing this Reader are responsible for obtaining the necessary equipment authorization. Upon request TI can provide assistance in obtaining FCC approval to market devices incorporating this Reader.

5.3 WARNING

Care must be taken when handling the S251B. High voltage across the antenna terminals could be harmful to your health. If the antenna insulation is damaged the antenna should not be connected to the Reader.

IMPORTANT NOTICE

Texas Instruments Incorporated and its subsidiaries (TI) reserve the right to make corrections, modifications, enhancements, improvements, and other changes to its products and services at any time and to discontinue any product or service without notice. Customers should obtain the latest relevant information before placing orders and should verify that such information is current and complete. All products are sold subject to TI's terms and conditions of sale supplied at the time of order acknowledgment.

TI warrants performance of its hardware products to the specifications applicable at the time of sale in accordance with TI's standard warranty. Testing and other quality control techniques are used to the extent TI deems necessary to support this warranty. Except where mandated by government requirements, testing of all parameters of each product is not necessarily performed.

TI assumes no liability for applications assistance or customer product design. Customers are responsible for their products and applications using TI components. To minimize the risks associated with customer products and applications, customers should provide adequate design and operating safeguards.

TI does not warrant or represent that any license, either express or implied, is granted under any TI patent right, copyright, mask work right, or other TI intellectual property right relating to any combination, machine, or process in which TI products or services are used. Information published by TI regarding third-party products or services does not constitute a license from TI to use such products or services or a warranty or endorsement thereof. Use of such information may require a license from a third party under the patents or other intellectual property of the third party, or a license from TI under the patents or other intellectual property of TI.

Reproduction of information in TI data books or data sheets is permissible only if reproduction is without alteration and is accompanied by all associated warranties, conditions, limitations, and notices. Reproduction of this information with alteration is an unfair and deceptive business practice. TI is not responsible or liable for such altered documentation.

Resale of TI products or services with statements different from or beyond the parameters stated by TI for that product or service voids all express and any implied warranties for the associated TI product or service and is an unfair and deceptive business practice. TI is not responsible or liable for any such statements.

Following are URLs where you can obtain information on other Texas Instruments products and application solutions:

Products		Applications	
Amplifiers	amplifier.ti.com	Audio	www.ti.com/audio
Data Converters	dataconverter.ti.com	Automotive	www.ti.com/automotive
DSP	dsp.ti.com	Broadband	www.ti.com/broadband
Interface	interface.ti.com	Digital Control	www.ti.com/digitalcontrol
Logic	logic.ti.com	Military	www.ti.com/military
Power Mgmt	power.ti.com	Optical Networking	www.ti.com/opticalnetwork
Microcontrollers	microcontroller.ti.com	Security	www.ti.com/security
Low Power Wireless	www.ti.com/lpw	Telephony	www.ti.com/telephony
		Video & Imaging	www.ti.com/video
		Wireless	www.ti.com/wireless

Mailing Address: Texas Instruments
Post Office Box 655303 Dallas, Texas 75265