

TPA032D01 Mono Class-D Audio Power Amplifier Evaluation Module

User's Guide

IMPORTANT NOTICE

Texas Instruments and its subsidiaries (TI) reserve the right to make changes to their products or to discontinue any product or service without notice, and advise customers to obtain the latest version of relevant information to verify, before placing orders, that information being relied on is current and complete. All products are sold subject to the terms and conditions of sale supplied at the time of order acknowledgment, including those pertaining to warranty, patent infringement, and limitation of liability.

TI warrants performance of its semiconductor products to the specifications applicable at the time of sale in accordance with TI's standard warranty. Testing and other quality control techniques are utilized to the extent TI deems necessary to support this warranty. Specific testing of all parameters of each device is not necessarily performed, except those mandated by government requirements.

Customers are responsible for their applications using TI components.

In order to minimize risks associated with the customer's applications, adequate design and operating safeguards must be provided by the customer to minimize inherent or procedural hazards.

TI assumes no liability for applications assistance or customer product design. TI does not warrant or represent that any license, either express or implied, is granted under any patent right, copyright, mask work right, or other intellectual property right of TI covering or relating to any combination, machine, or process in which such semiconductor products or services might be or are used. TI's publication of information regarding any third party's products or services does not constitute TI's approval, warranty or endorsement thereof.

Preface

Related Documentation From Texas Instruments

- ***TI Plug-N-Play Audio Amplifier Evaluation Platform*** (TI Literature Number SLOU011) provides detailed information on the evaluation platform and its use with TI audio evaluation modules.
- ***TPA032D01 Mono Class-D Audio Power Amplifier*** (TI Literature Number SLOS282) This is the data sheet for the TPA032D01 audio amplifier integrated circuit.
- ***Design Considerations for Class-D Audio Power Amplifiers***, (TI Literature Number SLOA031) This application report provides detailed information on designing audio power amplifier systems using TI class-D amplifier ICs
- ***Reducing and Eliminating the Class-D Output Filter***, (TI Literature Number SLOA023) This application report covers output filter theory and design for class-D audio power amplifiers.

FCC Warning

This equipment is intended for use in a laboratory test environment only. It generates, uses, and can radiate radio frequency energy and has not been tested for compliance with the limits of computing devices pursuant to subpart J of part 15 of FCC rules, which are designed to provide reasonable protection against radio frequency interference. Operation of this equipment in other environments may cause interference with radio communications, in which case the user at his own expense will be required to take whatever measures may be required to correct this interference.

Trademarks

PowerPAD is a trademark of Texas Instruments.



Contents

1	Introduction	1-1
1.1	Feature Highlights	1-2
1.2	Description	1-3
1.3	TPA032D01 Class-D EVM Specifications	1-4
1.3.1	Maximum	1-4
1.3.2	Typical	1-4
2	Quick Start	2-1
2.1	Precautions	2-2
2.2	Quick Start List for Platform	2-3
2.3	Quick Start List for Stand-Alone	2-4
3	Details	3-1
3.1	Precautions	3-2
3.2	Plug-N-Play Platform Power Requirements and Connections	3-3
3.3	Plug-N-Play Platform Inputs and Outputs	3-4
3.3.1	Inputs	3-4
3.3.2	Outputs	3-4
3.4	Control and Indicator Circuits	3-5
3.5	TPA032D01 Class-D EVM Test Points	3-5
3.6	Module Switches	3-6
3.6.1	S1 — Shutdown	3-6
3.6.2	S2 — Mute Switch	3-6
3.7	Using the TPA032D01 Class-D EVM Stand-Alone	3-7
3.7.1	Power Connections	3-7
3.7.2	Input Connections	3-8
3.7.3	Output Connections	3-8
3.7.4	Controls and Indicators	3-8
3.8	TPA032D01 Class-D EVM Bill of Materials	3-9
3.9	TPA032D01 Class-D EVM Schematic	3-10
3.10	TPA032D01 Class-D EVM PCB Layers	3-11

Figures

1-1	The TI TPA032D01 Mono Class-D Audio Power Amplifier EVM—Top View	1-3
1-2	The TI TPA032D01 Mono Class-D Audio Power Amplifier EVM—Bottom View	1-3
2-1	Quick Start Platform Map	2-2
3-1	The TI Plug-N-Play Audio Amplifier Evaluation Platform	3-2
3-2	Typical Headphone Plug	3-4
3-3	TPA032D01 Class-D EVM Stand-Alone Connections for Mono BTL Output	3-7
3-4	TPA032D01 Class-D EVM Schematic Diagram.	3-10
3-5	TPA032D01 Class-D EVM Top Assembly.	3-11
3-6	TPA032D01 Class-D EVM Bottom Assembly	3-11
3-7	TPA032D01 Class-D EVM Top Layer	3-12
3-8	TPA032D01 Class-D EVM Second Layer.	3-12
3-9	TPA032D01 Class-D EVM Third Layer.	3-13
3-10	TPA032D01 Class-D EVM Bottom Layer.	3-13

Tables

2-1	Typical TI Plug-N-Play Platform Jumper and Switch Settings for the TPA032D01 Class-D EVM	2-1
2-2	Platform Jumper and Switch Settings for the TPA032D01	2-3
3-1	Platform Jumper and Switch Settings for the TPA032D01 EVM Power Inputs	3-3
3-2	TPA032D01 Class-D EVM Fault Indicator Table	3-5
3-3	TPA032D01 Class-D EVM Test Points	3-5
3-4	TPA032D01 Class-D EVM Bill of Materials	3-9

Introduction

This chapter provides an overview of the Texas Instruments (TI) TPA032D01 mono class-D audio power amplifier evaluation module (SLOP309). It includes a list of EVM features, a brief description of the module illustrated with a pictorial diagram, and a list of EVM specifications.

Topic	Page
1.1 Feature Highlights	1-2
1.2 Description	1-3
1.3 TPA032D01 Class-D EVM Specifications	1-4

1.1 Feature Highlights

The TI TPA032D01 mono class-D audio power amplifier evaluation module and the TI plug-n-play audio amplifier evaluation platform include the following features:

- TPA032D01 mono class-D audio power amplifier evaluation module
 - Internal depop circuitry to greatly reduce turnon transients in outputs
 - Single channel, bridge-tied load (BTL) only operation
 - 12-V operation
 - 10 W BTL output into 4 Ω at 12 V
 - Low current consumption in shutdown/mute mode (97 μ A/2.5 mA)
 - Internal gain set to 25 dB
 - IC shutdown and mute control inputs—TTL logic level
 - High efficiency
 - CE tested and approved.

- Quick and Easy Configuration With the TI Plug-N-Play Audio Amplifier Evaluation Platform
 - Evaluation module is designed to simply plug into the platform, automatically making all signal, control, and power connections
 - Platform provides flexible power options
 - Jumpers on the platform select power and module control options
 - Switches on the platform route signals
 - Platform provides quick and easy audio input and output connections

- Platform Power Options
 - External 5-V – 15-V V_{CC} supply inputs
 - External regulated V_{DD} supply input
 - Socket for onboard 5 V/3.3 V V_{DD} voltage regulator EVM
 - Onboard overvoltage and reverse polarity power protection

- Platform Audio Input and Output Connections
 - Left and right RCA phono jack inputs
 - Miniature mono phone jack input
 - Left and right RCA phono jack outputs
 - Left and right compression speaker terminal outputs
 - Miniature stereo headphone jack output

1.2 Description

The TPA032D01 mono class-D audio power amplifier evaluation module is a complete, 10-W mono audio power amplifier. It consists of the TI TPA032D01 mono class-D audio power amplifier IC along with a small number of other parts mounted on a circuit board that measures approximately 2-1/4 inches by 1-3/4 inches (Figure 1–1 and 1–2).

Figure 1–1. The TI TPA032D01 Mono Class-D Audio Power Amplifier EVM—Top View

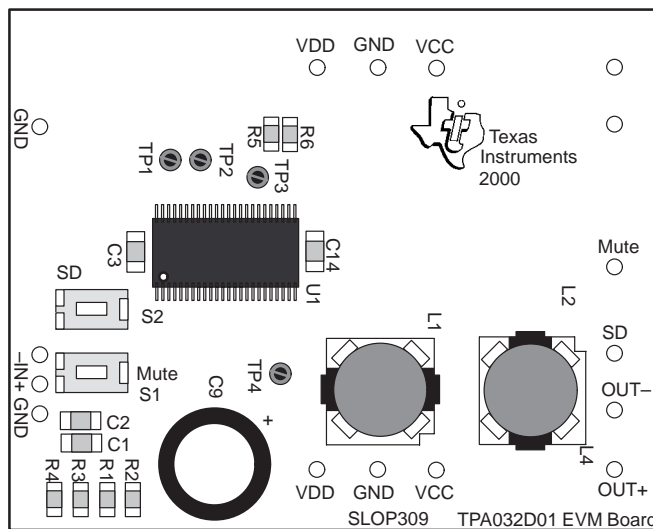

Note: Capacitor C9 is optional (not assembled) and a location for it on the EVM PCB has been provided to increase design flexibility and allow decoupling capacitance to be added.

Figure 1–2. The TI TPA032D01 Mono Class-D Audio Power Amplifier EVM—Bottom View

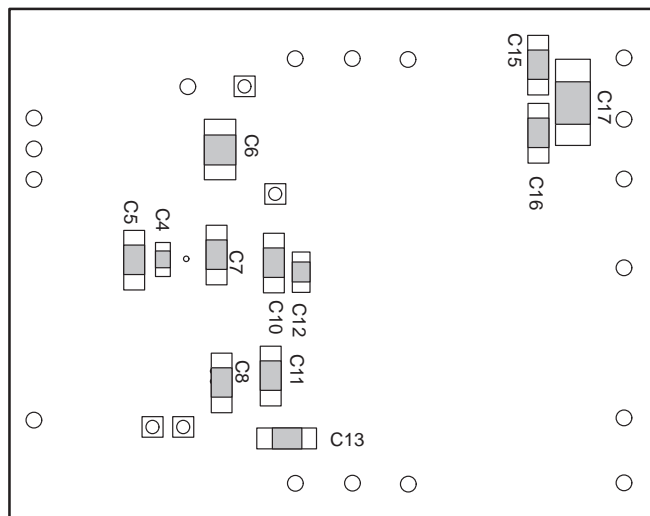

Single in-line header pins extend from the underside of the module circuit board to allow the EVM to either be plugged into the TI plug-n-play audio amplifier evaluation platform, or to be wired directly into existing circuits and equipment when used stand-alone.

The platform has room for a single TPA032D01 class-D evaluation module and is a convenient vehicle for demonstrating TI's audio power amplifier and related evaluation modules. The EVM simply plugs into the platform, which automatically provides power to the modules, interconnects them correctly, and connects them to a versatile array of standard audio input and output jacks and connectors. Easy-to-use configuration controls allow the platform and EVMs to quickly model many possible end-equipment configurations.

There is nothing to build, nothing to solder, and nothing but the speakers included with the platform to hook up.

1.3 TPA032D01 Class-D EVM Specifications

All measurements made with $V_{DD} = 12\text{ V}$ and $R_L = 4\ \Omega$, unless otherwise noted.

1.3.1 Maximum

Supply voltage range, V_{DD}	9 V to 14 V
Supply current, I_{DD}	4.6 A
Continuous output power per channel, BTL, P_O	10 W
Audio input voltage, V_I ($A_V = 25\text{ dB}$)	350 mVrms

1.3.2 Typical

Supply current, no input, I_{DD}	55 mA
Supply current, EVM mute, I_{DD}	2.5 mA
Supply current, EVM shutdown, I_{DD}	97 μA
Gain	25 dB
Total harmonic distortion + noise, $P_O = 1\text{ W @ } 1\text{ kHz}$	0.14 %

Quick Start

Follow the steps in this chapter to quickly prepare the TPA032D01 mono class-D audio amplifier EVM for use. Using the TPA032D01 class-D EVM with the TI plug-n-play audio amplifier evaluation platform is a quick and easy way to connect power, signal and control inputs, and signal outputs to the EVM using standard connectors. However, the audio amplifier evaluation module can be used stand-alone by making connections directly to the module pins, and it can be wired directly into existing circuits or equipment.

The platform switch and jumper settings shown in Table 2–1 are typical for the TPA032D01 class-D EVM. There are no jumpers or switches to set on the TPA032D01 class-D EVM board, itself.

Table 2–1. Typical TI Plug-N-Play Platform Jumper and Switch Settings for the TPA032D01 Class-D EVM

POWER TYPE (Note 2)	JP1	JP2	JP3	JP4	JP5	JP6	JP7	JP8	S1	S2 (Note 3)	S3
VCC (J1)	ON	OFF	OFF	ON	ON	Mute	X	Lo	ON	OFF	U5
AC/DC (J2)	OFF	ON	OFF	ON	ON	Mute	X	Lo	ON	OFF	U5

- Notes:**
- 1) ON = Jumper installed, OFF = Jumper **NOT** Installed, X = Don't care
 - 2) Install a voltage regulator EVM (SLVP097) in platform socket U6 for VDD power to EVM control inputs.
 - 3) Set to ON when tone control board SLOP109 is installed in U1, otherwise set to OFF.

Topic	Page
2.1 Precautions	2-2
2.2 Quick Start List for Platform	2-3
2.3 Quick Start List for Stand-Alone	2-4

2.1 Precautions

Power Supply Input Polarity and Maximum Voltage

Always ensure that the polarity and voltage of the external power connected to V_{CC} power input connector J1, J2, and/or V_{DD} power input connector J6 are correct. Overvoltage or reverse-polarity power applied to these terminals can open onboard soldered-in fuses and cause other damage to the platform, installed evaluation modules, and/or the power source.

Inserting or Removing EVM Boards

Do not insert or remove EVM boards with power applied—damage to the EVM board, the platform, or both may result.

Figure 2–1. Quick Start Platform Map

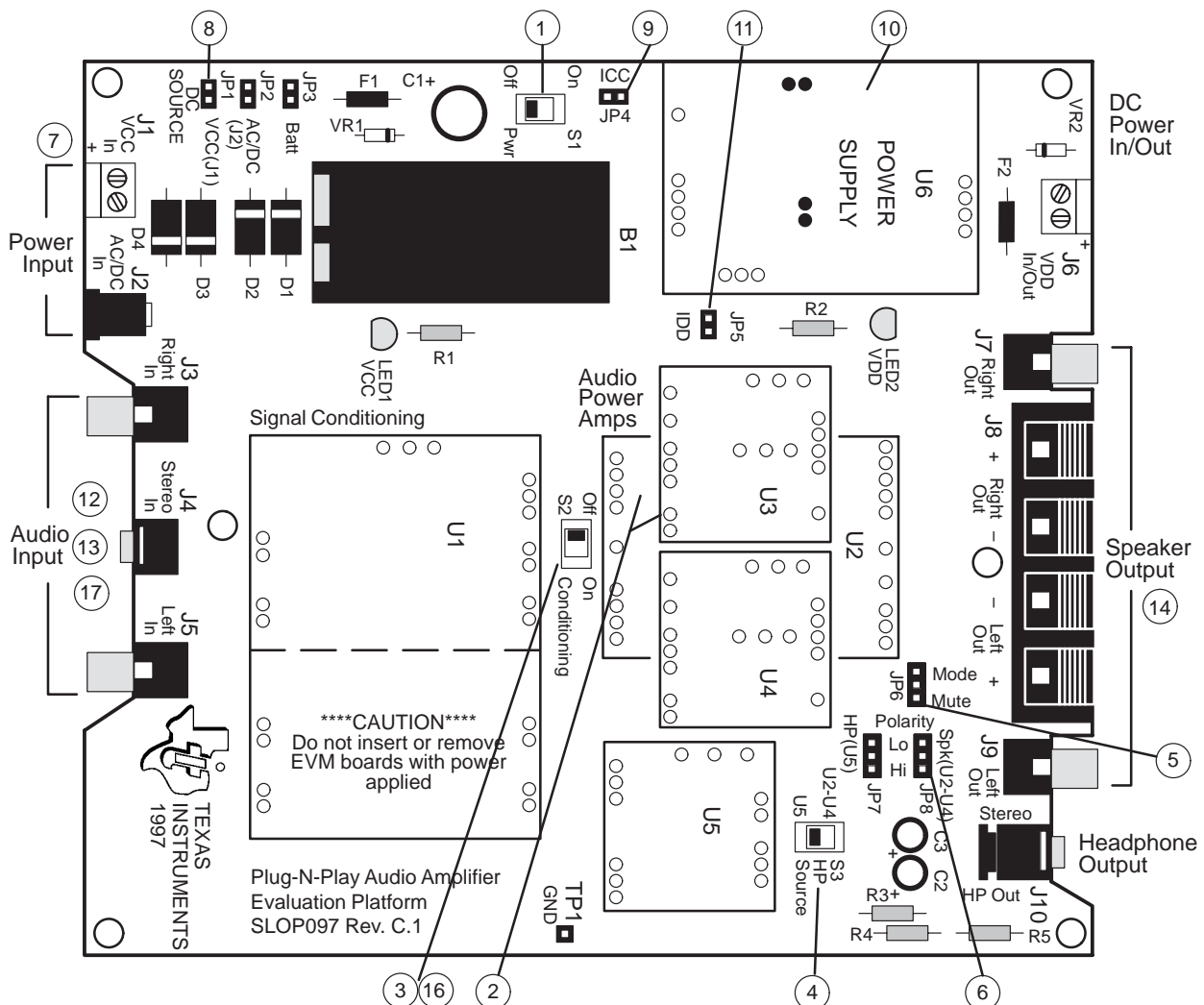

2.2 Quick Start List for Platform

Follow these steps when using the TPA032D01 class-D EVM with the TI plug-n-play audio amplifier evaluation platform (see the platform user's guide, SLOU011, for additional details). Numbered callouts for selected steps are shown in Figure 2–1 and details appear in Chapter 3.

□ Platform Preparations

- 1) Ensure that all external power sources and platform power switch **S1** are set to **OFF**.
- 2) Install a TPA032D01 module in platform socket **U2**, taking care to align the module pins correctly (EVM power pins engage sockets U2 and U3).
- 3) Set switch **S2** to **OFF**.
- 4) Set switch **S3** to **U5**.
- 5) Set jumper **JP6** to select the **Mute** control input.
- 6) Set control signal **Polarity** jumper **JP8** to **Lo**.

Table 2–2. Platform Jumper and Switch Settings for the TPA032D01

POWER TYPE (Note 2)	JP1	JP4	JP5	JP6	JP7	JP8	S1	S2 (Note3)	S3
VCC (J1)	ON	ON	ON	Mute	X	Lo	ON	OFF	U5

- Notes:**
- 1) ON = Jumper installed, OFF = Jumper **NOT** Installed, X = Don't care
 - 2) Install a voltage regulator EVM (SLVP097) in platform socket U6 for VDD power to EVM control inputs.
 - 3) Set to ON when tone control board SLOP109 is installed in U1.

□ Power supply

- 7) Connect a **12-V** regulated power supply (ensure power supply is set to **OFF**) to **J1**, taking care to observe marked polarity.
- 8) Set jumper **JP1** for dc source to be from input **J1**.
- 9) Set jumper **JP4** for VCC power to EVMs.
- 10) Install a voltage regulator EVM (SLVP097) in platform socket **U6**.
- 11) Set jumper **JP5** for VDD power to EVMs.

□ Inputs and outputs

- 12) Ensure that the audio signal source level is set to minimum.
- 13) Connect the audio source to left and right RCA phono jacks **J3** and **J5** or mono miniature phone jack **J4**.
- 14) Connect 4- Ω – 8- Ω speakers to left and right RCA jacks **J7** and **J9** or to stripped wire speaker connectors **J8**.

□ Power up

- 15) Verify correct voltage and input polarity and set the external power supply and platform power switch **S1** to **ON**.

Platform LED1 and LED2 should light indicating the presence of VCC and VDD, and the evaluation module(s) installed on the platform should begin operation.

- 16) Set switch S2 to ON if tone control board SLOP109 is installed in **U1**.
- 17) Adjust the signal source level as needed.

2.3 Quick Start List for Stand-Alone

Follow these steps to use the TPA032D01 class-D EVM stand-alone or to connect it into existing circuits or equipment. Connections to the TPA032D01 module header pins can be made via individual sockets, wire-wrapping, or soldering to the pins, either on the top or the bottom of the module circuit board.

Power supply

- 1) Ensure that all external power sources are set to **OFF**.
- 2) Connect an external regulated power supply set to **12 V** to the module **VCC** and **GND** pins taking care to observe marked polarity. It is only necessary to use the ground pins adjacent to the module power pins.
- 3) Connect an external regulated power supply set to **5 V** to the module **VDD** pin taking care to observe marked polarity.

Inputs and outputs

- 4) Ensure that audio signal source level adjustments are set to minimum.
- 5) Connect the audio source across the module **IN+** and **IN-** pins for class-D operation, taking care to observe marked polarity. For single-ended input, the negative input pin (**IN-**) should be connected to the ground of the audio signal source.
- 6) Connect a control signal to the module **Mute** pin, if necessary. The control signal should be high (2 V to 5 V or left floating) for normal operation, or low (tied to ground) to mute the output.
- 7) Connect a control signal to the module **SD** pin, if necessary. The control signal should be high (2 V to 5 V or left floating) for normal operation, or low (tied to ground) to shut down the TPA032D01 amplifier IC on the EVM.

Note that the control signals applied to the EVM Mute and SD inputs must have sufficient current capability to overcome the 100-k Ω pullup resistor on each input. Miniature pushbutton switches on the EVM allow manual shutdown (**S2**) and manual muting (**S1**) of the amplifier.

- 8) Connect a 4- Ω – 8- Ω speaker to the module **OUT+** and **OUT-** pins, taking care to observe marked polarity.

Power up

- 9) Verify correct voltage and input polarity and set the external power supply to **ON**.

The EVM should begin operation.

- 10) Adjust the signal source level as needed.

Details

This chapter provides details on the TPA032D01 IC evaluation module, a parts list for the TPA032D01 class-D evaluation module, and module PCB layer illustrations.

Topic	Page
3.1 Precautions	3-2
3.2 Plug-N-Play Platform Power Requirements and Connections	3-3
3.3 Plug-N-Play Platform Inputs and Outputs	3-4
3.4 Control and Indicator Circuits	3-5
3.5 TPA032D01 Class-D EVM Test Points	3-5
3.6 Module Switches	3-6
3.7 Using the TPA032D01 Class-D EVM Stand-Alone	3-7
3.8 TPA032D01 Bill of Materials	3-9
3.9 TPA032D01 Class-D EVM Schematic	3-10
3.10 TPA032D01 Class-D EVM PCB Layers	3-11

3.1 Precautions

Power Supply Input Polarity and Maximum Voltage

Always ensure that the polarity and voltage of the external power connected to V_{CC} power input connector J1, J2, and/or V_{DD} power input connector J6 are correct. Overvoltage or reverse-polarity power applied to these terminals can open onboard soldered-in fuses and cause other damage to the platform, installed evaluation modules, and/or the power source.

Inserting or Removing EVM Boards

Do not insert or remove EVM boards with power applied—damage to the EVM board, the platform, or both may result.

Figure 3–1. The TI Plug-N-Play Audio Amplifier Evaluation Platform

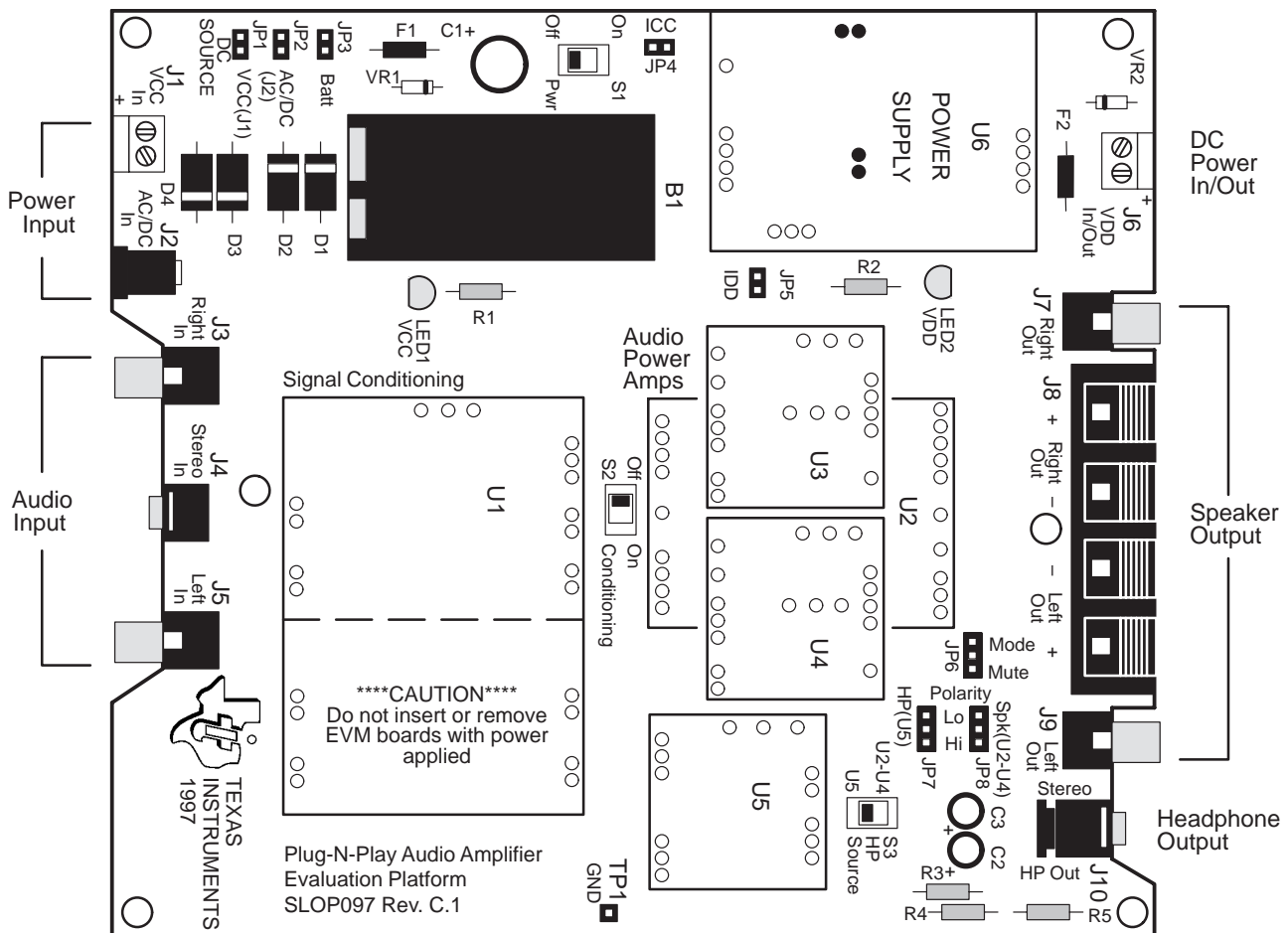

3.2 Plug-N-Play Platform Power Requirements and Connections

The TPA032D01 mono class-D audio power amplifier evaluation module is designed to operate from a supply voltage between 9 V and 14 V. For best performance, the module should be operated at 12 V.

The TI plug-n-play audio amplifier evaluation platform provides several options for powering the TPA032D01 class-D EVM. Table 3–1 shows the *platform* jumper and switch settings for each power source option (see the User’s Guide for the TI plug-n-play audio amplifier platform, TI Literature Number SLOU011 for more information). The TPA032D01 class-D EVM requires no setup for power source selection.

Table 3–1. Platform Jumper and Switch Settings for the TPA032D01 EVM Power Inputs

POWER TYPE (Note 2)	JP1	JP2	JP3	JP4	JP5	JP6	JP7	JP8	S1	S2 (Note 3)	S3
VCC (J1)	ON	OFF	OFF	ON	ON	Mute	X	Lo	ON	OFF	U5
AC/DC (J2)	OFF	ON	OFF	ON	ON	Mute	X	Lo	ON	OFF	U5

- Notes:**
- 1) ON = Jumper installed, OFF = Jumper **NOT** Installed, X = Don't care
 - 2) Install a voltage regulator EVM (SLVP097) in platform socket U6 for VDD power to EVM control inputs.
 - 3) Set to ON when tone control board SLOP109 is installed in U1, otherwise set to OFF.

Although the TPA032D01 amplifier IC draws approximately 1.6 A from the power supply during continuous full power output, peak current draw can be as high as 2.3 A. Any power supply connected to the platform should be capable of providing 2.3 A (peak) to avoid clipping of the output signal during voltage peaks. Current consumption driving speakers at normal listening levels is typically 0.1 A or less.

A V_{DD} supply of 5 V is required for normal operation of the TPA032D01 EVM. V_{DD} can either be applied to the platform V_{DD} power input terminals (J6) or a voltage regulator (SLVP097 or equiv.) can be installed in platform socket U6 to provide V_{DD} from the platform V_{CC} supply.

The platform is equipped with overvoltage and reverse-polarity supply voltage input protection in the form of fused crowbar circuits.

- V_{DD} voltage applied to platform screw terminals J6 **MUST NOT** exceed the absolute maximum rating for the TPA032D01 amplifier IC installed on the evaluation module (5.5 V) or damage to the IC may result. In no case should V_{DD} voltage of the incorrect polarity or in excess of 6.0 V be applied to screw terminals J6 of the platform, or the power protection circuit on the V_{DD} line will trip.
- V_{CC} voltage applied to the platform **MUST NOT** exceed the maximum voltage input specified for the voltage regulator module installed in socket U6 (12 V for the SLVP097), or damage to the voltage regulator module may result. In no case should V_{CC} voltage applied to the platform exceed 15 V, or the overvoltage protection circuit on the V_{CC} bus will trip.

3.3 Plug-N-Play Platform Inputs and Outputs

The TI plug-n-play audio amplifier evaluation platform is equipped with several standard connectors for audio inputs and outputs.

3.3.1 Inputs

In most cases, audio signals enter the platform through either a pair of RCA phono jacks (J3 and J5) or a miniature (1/8") mono phone jack (J4). Certain signal conditioning and amplifier EVMs, however, may have additional signal input connectors mounted on the module circuit board.

The platform audio signal input jacks (J3, J4, and J5) are of the closed-circuit type, grounding the signal input lines when no plugs are inserted.

3.3.2 Outputs

Amplified audio output signals leave the platform through left and right RCA phono jacks (J7 and J9), left and right pairs of compression connectors for stripped speaker wires (J8), and optionally, through a miniature (1/8") mono phone jack (J10), for headphones.

The audio output lines from the power amplifiers are separate all the way to the edge of the platform (output jacks J7, J8, and J9)—the OUT– lines from the power amplifier sockets are not tied to each other or to platform ground. This allows the TPA032D01 class-D power amplifier EVM to operate in the highly-efficient bridge-tied load configuration when driving speakers.

The headphone jack (J10) is capacitively coupled to source select switch S3, which connects J10 to the output lines of either the headphone amplifier socket or the power amplifier sockets (Figure 3–2).

Figure 3–2. Typical Headphone Plug

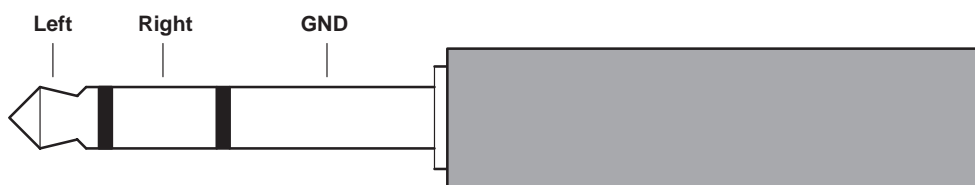

3.4 Control and Indicator Circuits

Two main control circuits are provided with the TPA032D01. The mute circuit grounds the output of the active amplifier, and the shutdown circuit places the entire device into a power-saving sleep mode to minimize current consumption. Each of these inputs is TTL compatible: less than 0.8 V applied to these pins is considered a logic low, and any voltage greater than 2 V is considered a logic high.

Two indicator pins are also provided for feedback when an under-voltage, over-current, or thermal fault exists. Module pins are provided for easy connection of off-board control and monitoring. There are two active low fault indicator pins on the TPA032D01 amplifier IC (IC pins 40 and 41) that provide feedback when a fault condition exists. Signals on these pins provide the status of the class-D amplifier: operational, over-current, thermal fault, and under-voltage lockout. Table 3–2 lists the possible output conditions of these pins and a description of the fault indicated.

Table 3–2. TPA032D01 Class-D EVM Fault Indicator Table

FAULT 0 (TP 1)	FAULT 1 (TP 2)	DESCRIPTION
1	1	No fault. The device is operating normally.
1	0	Charge pump under-voltage lockout (VCP-UV) fault. The charge pump voltage is $< (PVDD + 6V)$. All low-side transistors are turned on, shorting the load to ground. Normal operation resumes when the charge pump voltage is restored (not a latched fault), however the Fault <i>indication</i> remains active until cleared by cycling MUTE, SHUTDOWN, or the power supply.
0	1	Over-current fault. The output current limit has been exceeded. All output transistors are switched off, causing the load to see a high impedance state. This is a <i>latched</i> fault and is cleared by cycling MUTE, SHUTDOWN, or the power supply.
0	0	Thermal fault. The internal junction temperature has exceeded 125°C. All of the low-side transistors are turned on, shorting the load to ground. Once the junction temperature drops by 20°C and is below 125°C, normal operation resumes (not a latched fault). The Fault <i>indication</i> remains active until cleared by cycling MUTE, SHUTDOWN, or the power supply.

3.5 TPA032D01 Class-D EVM Test Points

Test points have been included on the TPA032D01 class-D EVM to facilitate user analysis of device performance and design adjustments. Table 3–3 lists each test point and its corresponding function.

Table 3–3. TPA032D01 Class-D EVM Test Points

TEST POINT	IC PIN or EVM FUNCTION	FUNCTION
1	FAULT_0	LSB for logic-level fault output signal, open drain
2	FAULT_1	MSB for logic-level fault output signal, open drain
3	VCCREG	Onboard 5-V supply
4	VCP	Charge pump storage capacitor

3.6 Module Switches

The TPA032D01 mono class-D audio amplifier evaluation module is equipped with two pushbutton switches that allow the module shutdown and mute functions to be manually activated.

3.6.1 S1 — Shutdown

To have the module amplifier IC enter the shutdown mode, press the Shutdown switch (S2) on the module. S2 connects the amplifier IC SHUTDOWN pin to ground, forcing it into a low-power state. This function can be controlled by an external control input to the SD module pin.

The shutdown mode reduces the amplifier IC current consumption to less than 1 μA compared to approximately 2.5 mA in the mute mode. The EVM shutdown current is based on V_{CC} , V_{DD} , R2, R5, and R6, and capacitor leakage currents, but will typically be 97 $\mu\text{A} \pm 5\%$ for $V_{CC} = 12\text{ V}$ and $V_{DD} = 5\text{ V}$. The plug-n-play platform typically draws 60 mA of current.

3.6.2 S2 — Mute Switch

Pushbutton switch S1 on the TPA032D01 class-D EVM allows manual muting of the amplifier IC. S1 connects the amplifier IC $\overline{\text{MUTE}}$ pin to ground, muting the output. The EVM Mute control input pin also allows external control of this function.

In the mute mode, the amplifier IC lowside output transistors are turned on, shorting the load to ground. This reduces the EVM current to 2.5 mA.

3.7 Using the TPA032D01 Class-D EVM Stand-Alone

Using the TPA032D01 mono class-D audio power amplifier evaluation module stand-alone is much the same as using it with the platform. The same 9-V to 14-V power supply range and the isolated OUT+ and OUT– lines for BTL operation requirements exist. Figure 3–3 shows the connections that are required for operation (with the exception of the fault monitor circuit, which is optional). The discussion in this section is in reference to this figure unless otherwise noted.

Figure 3–3. TPA032D01 Class-D EVM Stand-Alone Connections for Mono BTL Output

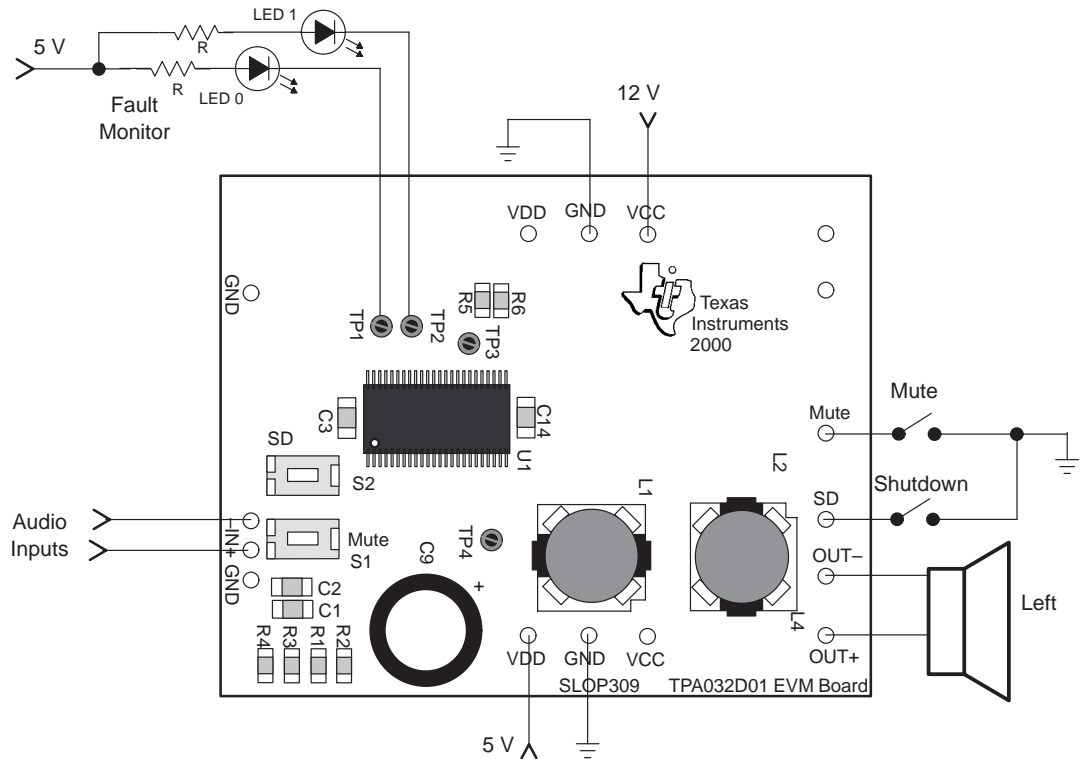

Note: Capacitor C9 is optional (not assembled) and a location for it on the EVM PCB has been provided to increase design flexibility and allow decoupling capacitance to be added.

3.7.1 Power Connections

Power must be connected to both the VCC and VDD module pins. Power supply ground can be connected to any module ground pin, although best results are achieved if power supply grounds are connected to the pins adjacent to the VCC, VCC2, and VDD module pins. The ground and power wires should be twisted to reduce inductance and noise pickup if they are long.

3.7.2 Input Connections

The class-D amplifier input signals can be connected in either of two ways: differential or single-ended. For differential operation, connect the signal source to the positive and negative inputs (IN+ and IN– module pins). For single-ended operation, the input signal line should be connected to the IN+ module pin and the signal source ground wire should be connected to the IN– module pin.

The input signal and ground wires should be twisted to reduce inductance and noise pickup if the lead lengths are long and the cable is not shielded.

3.7.3 Output Connections

The speaker should be connected between the OUT+ and the OUT– module pins.

3.7.4 Controls and Indicators

The mute and shutdown functions may be controlled externally via the module Mute and SD pins. An active-low input mutes the selected amplifier or shuts down the device. A signal of 2 V or higher allows normal operation.

Note that the mute and shutdown signals applied to the EVM control input pins must be able to supply enough current to overcome the pullup resistor on the module (100 k Ω).

The fault indicator circuit can be monitored at FAULT0 (TP1) and FAULT1 (TP2). These are open-drain outputs with 100-k Ω resistors connected to VDD (5 V). A fault table is shown in Section 3.2.1 and in the device data sheet.

3.8 TPA032D01 Class-D EVM Bill of Materials

The components in the bill of materials (Table 3–4) were selected for their common values, availability, and the smallest size available to meet these criteria.

Table 3–4. TPA032D01 Class-D EVM Bill of Materials

Reference	Description	Size	EVM Qty.	Manufacturer/ Part Number
C12	Capacitor, Ceramic Chip, 0.1 μ F, \pm 10%, 50 V, X7R	0805	1	Kemet C0805C104J5RAC
C1, C2, C5, C7, C8, C10 [†] , C11, C13, C17	Capacitor, Ceramic Chip, 1 μ F, \pm 10%, 25 V, X7R	1206	9	Kemet C1206C105K3RAC
C14	Capacitor, Ceramic Chip, 47 nF, \pm 10%, 50 V, X7R	0805	1	Kemet C0805V473K5RAC
C3, C4	Capacitor, Ceramic Chip, 1 nF, \pm 5%, 50 V, C0G,	0805	2	Kemet C0805C102J5GAC
C6	Capacitor, Ceramic Chip, 10 μ F, +80%–20%, 25 V, Y5V	1210	1	muRata GRM235Y5V106Z25
C9 [†]	Not assembled	0.492" \times 0.0236" \times 0.197"	1	
C15, C16	Capacitor, Ceramic Chip, 0.22 μ F, \pm 10%, 50 V, X7R	1206	2	Kemet C1206C224K5RAC
L1, L2	Inductor, SMT, 15 μ H, \pm 20%, 2.2 ADC, 47.2 m Ω @ 1 kHz, –20 to +90°C	0.398" \times 0.398" \times 0.236"	2	TDK SLF10145T–150M2R2
R1, R2, R3, R4	Resistor, Thick Film Chip, SMD, 100 k Ω , \pm 5%, 1/10 W, 100 V, –50 to 150°C, \pm 200 ppm/°C	0603	4	Vishay/Dale CRCW0603104J
R5	Resistor, Thick Film Chip, SMD, 500 k Ω , \pm 5%, 1/10 W, 100 V, –50 to 150°C, \pm 200 ppm/°C	0603	1	Vishay/Dale CRCW0603504J
R6	Resistor, Thick Film Chip, SMD, 150 k Ω , \pm 5%, 1/10 W, 100 V, –50 to 150°C, \pm 200 ppm/°C	0603	1	Vishay/Dale CRCW0603154J
TP1 – TP4	Test Points, Red		4	Farnell 240–345
	Header Pins, Gold, Single, 0.5" Long, 0.25" Wide, 0.100" centers	0.5", 0.25", 0.1"	16	Samtec TSW–19–8–G–S
S1, S2	Switch, Momentary, Push Button, 12 VDC, 50 mA	0.291" \times 0.138" \times 0.134"	2	Panasonic EVQ–PJS04K
U1	IC, Audio Amplifier, Class-D, 32 W, 48 pin, DCA pkg	TSSOP48	1	TI TPA032D01DCA

[†] Capacitor C9 is optional (not assembled) and a location for it on the EVM PCB has been provided to increase design flexibility and allow decoupling capacitance to be added.

3.9 TPA032D01 Class-D EVM Schematic

The TPA032D01 class-D EVM schematic is shown in Figure 3–4.

Figure 3–4. TPA032D01 Class-D EVM Schematic Diagram

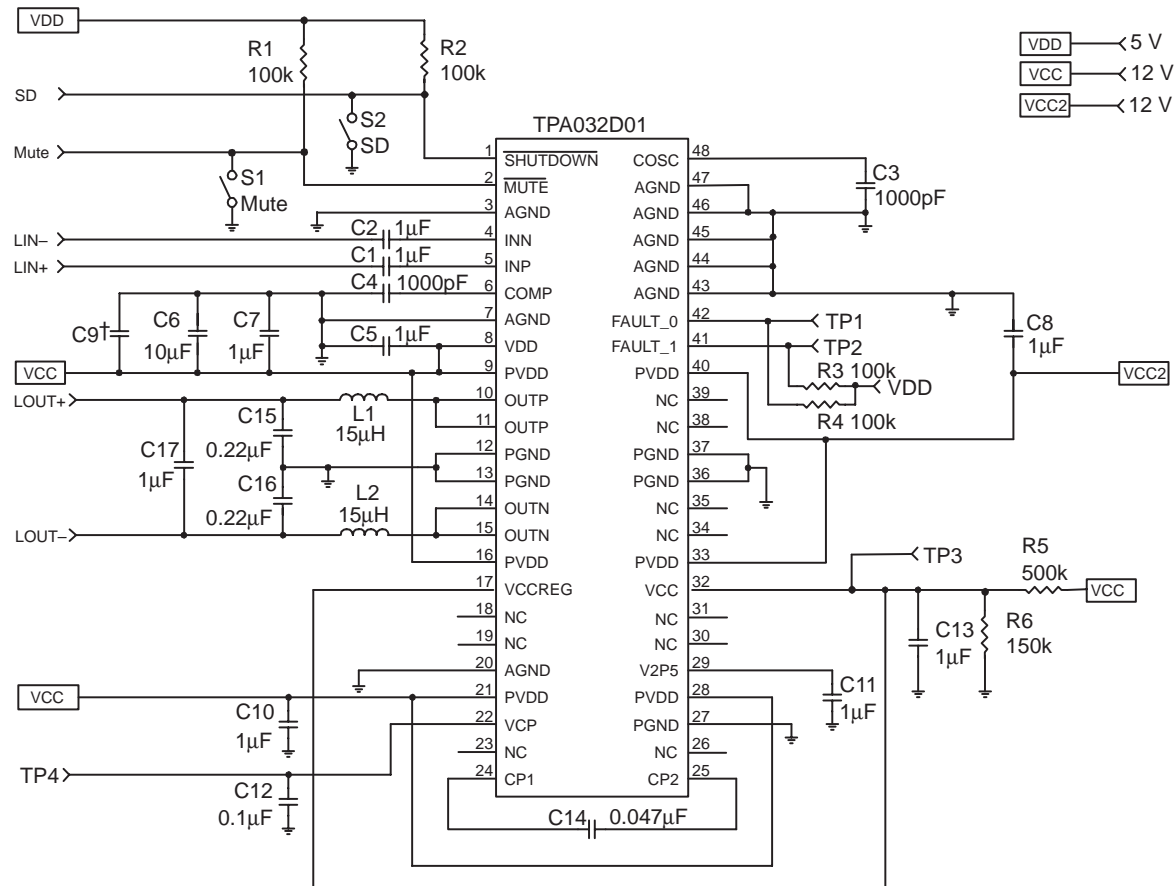

† Capacitor C9 is optional (not assembled) and a location for it on the EVM PCB has been provided to increase design flexibility and allow decoupling capacitance to be added.

3.10 TPA032D01 Class-D EVM PCB Layers

The following illustrations depict the TPA032D01 class-D EVM PCB assembly and layers. These drawings are not to scale. Gerber plots can be obtained from any TI Sales Office.

Figure 3–5. TPA032D01 Class-D EVM Top Assembly

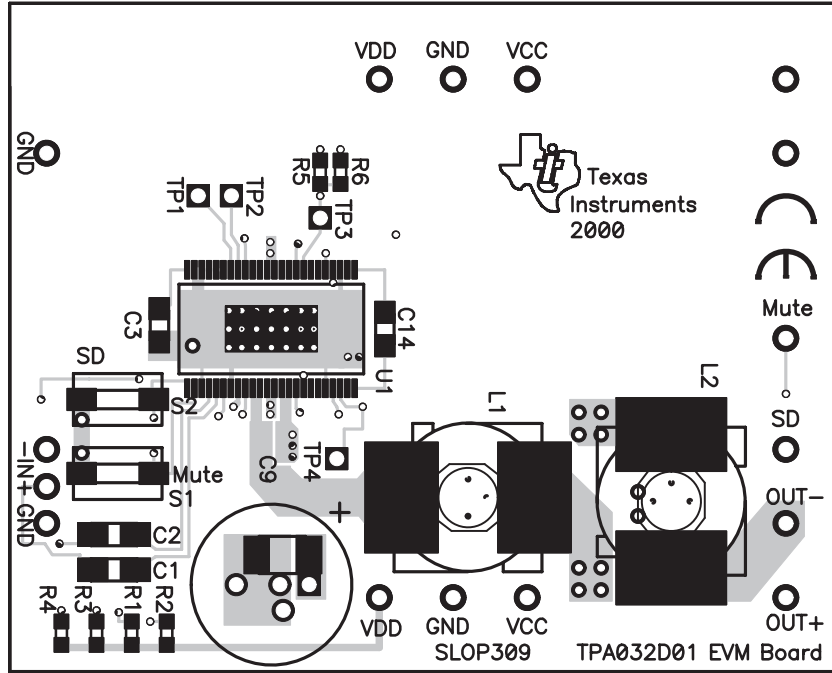

Figure 3–6. TPA032D01 Class-D EVM Bottom Assembly

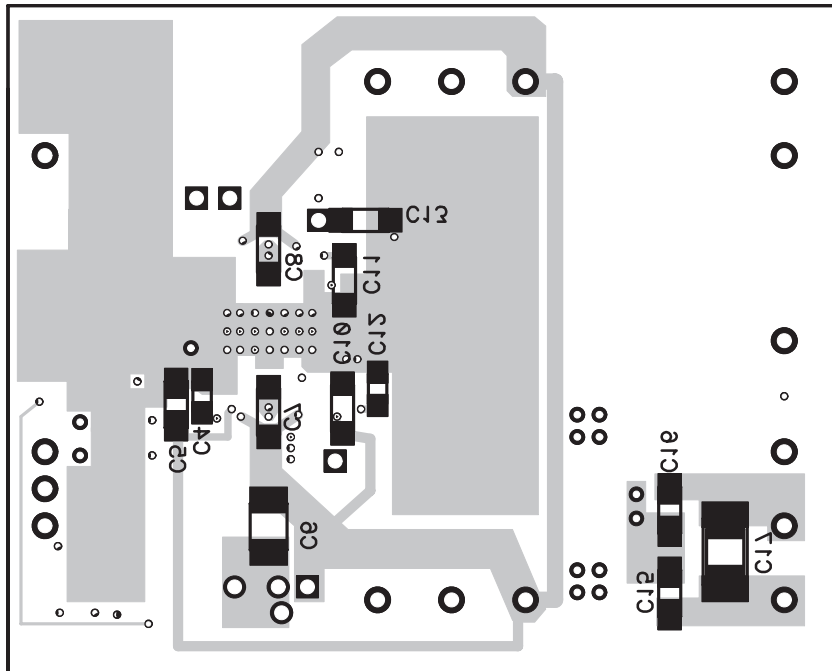

Figure 3–7. TPA032D01 Class-D EVM Top Layer

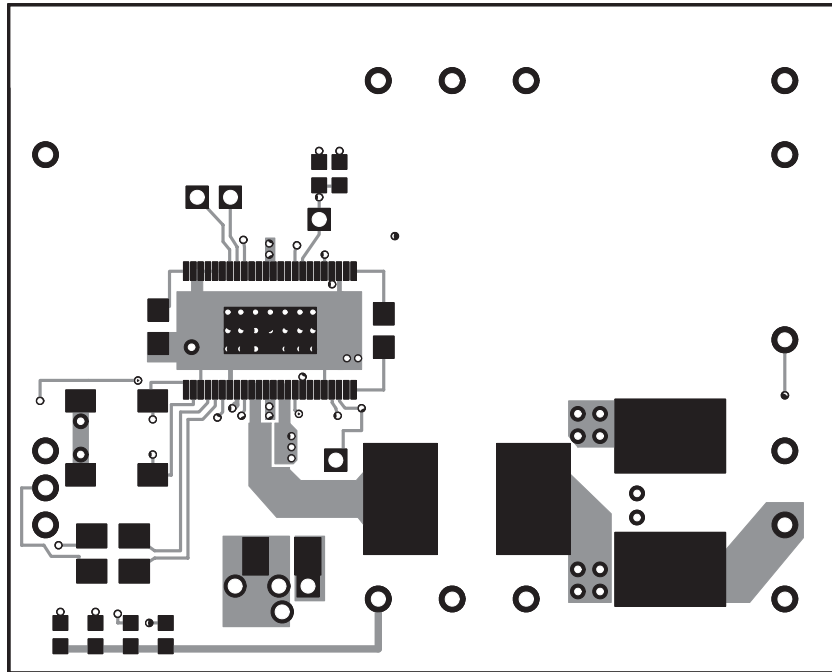

Figure 3–8. TPA032D01 Class-D EVM Second Layer

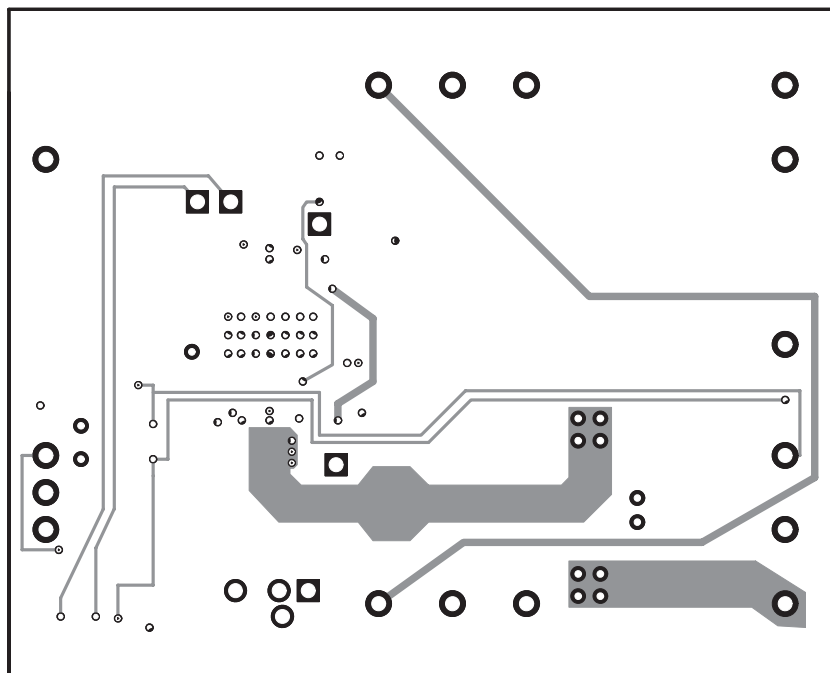

Figure 3–9. TPA032D01 Class-D EVM Third Layer

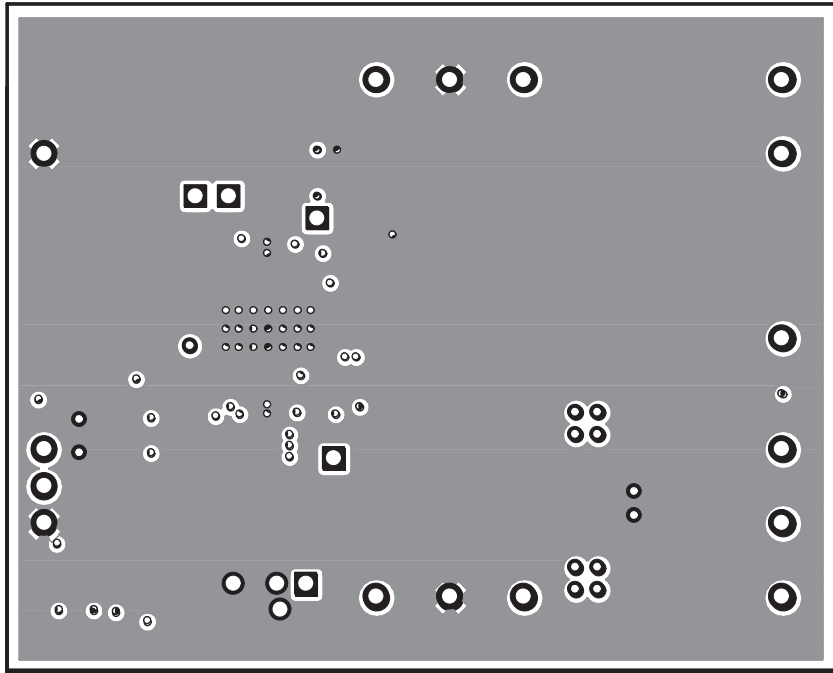

Figure 3–10. TPA032D01 Class-D EVM Bottom Layer

