

# Stellaris® Serial-to-Ethernet Reference Design Kit

## User's Manual



---

# Copyright

Copyright © 2008–2009 Texas Instruments, Inc. All rights reserved. Stellaris and StellarisWare are registered trademarks of Texas Instruments. ARM and Thumb are registered trademarks, and Cortex is a trademark of ARM Limited. Other names and brands may be claimed as the property of others.

Texas Instruments  
108 Wild Basin, Suite 350  
Austin, TX 78746  
Main: +1-512-279-8800  
Fax: +1-512-279-8879  
<http://www.luminarymicro.com>



# Table of Contents

<b>Chapter 1: Stellaris® Serial-to-Ethernet Reference Design Kit Overview .....</b>	<b>7</b>
Using the RDK .....	7
Features .....	8
Kit Contents .....	8
Description .....	8
Serial-to-Ethernet Module .....	8
Serial-to-Ethernet Connector Board .....	9
Flow Control .....	10
Installation .....	10
Specifications .....	11
Electrical .....	11
Mechanical .....	11
<b>Chapter 2: Serial-to-Ethernet Configuration and Firmware Update .....</b>	<b>13</b>
Accessing the Configuration Website .....	13
Using the Finder Utility .....	13
Using "My Network Places" .....	14
Using the LM S2E Browser Application .....	15
Home Page .....	15
Port 0 and Port 1 Settings Pages .....	16
Miscellaneous Settings Page .....	18
Firmware Update Page .....	19
<b>Chapter 3: Using the S2E Module as a Serial Extender over Ethernet .....</b>	<b>21</b>
<b>Chapter 4: Using Serial-to-Ethernet as a Virtual COM Port .....</b>	<b>23</b>
Overview .....	23
Install com0com .....	23
Install com2tcp .....	28
Install LM PC S2E Configuration .....	28
Configure VCP Using the LM S2E PC Configuration Application .....	29
Connection Creation .....	30
Edit port names .....	32
Manual VCP Configuration .....	32
Verify VCP Operation .....	33
<b>Chapter 5: Hardware Description .....</b>	<b>35</b>
Block Diagram .....	35
<b>Appendix A: Schematics .....</b>	<b>37</b>
<b>Appendix B: Bill of Materials (BOM) .....</b>	<b>39</b>

---

## List of Figures

Figure 1-1. Serial-to-Ethernet Module and S2E Connector Board .....	7
Figure 1-2. Serial-to-Ethernet Module .....	9
Figure 1-3. Serial-to-Ethernet Connector Board .....	9
Figure 1-4. S2E Module Connection to S2E-CKIT .....	11
Figure 2-1. LM S2E Browser Window.....	15
Figure 2-2. Home Page of the Configuration Website .....	16
Figure 2-3. Port 0 Configuration Window.....	18
Figure 2-4. Miscellaneous Settings Page .....	19
Figure 3-1. Implementing a Serial Extender over Ethernet.....	21
Figure 4-1. Typical S2E Module .....	23
Figure 4-2. Luminary Micro menu group.....	29
Figure 4-3. S2E module connection over Ethernet.....	30
Figure 4-4. Main LM S2E Configuration application window .....	31
Figure 4-5. Manual VCP configuration.....	33
Figure 4-6. Com2tcp communication shown in the command prompt window.....	33
Figure 4-7. HyperTerminal File Properties Dialog .....	34
Figure 5-1. Serial-to-Ethernet Block Diagram.....	35

## List of Tables

Table 1-1. J2 Header Signals .....	10
Table 1-2. J3 Header Signals .....	10
Table B-1. Serial-to-Ethernet Bill-of-Materials .....	39
Table B-2. Serial-to-Ethernet Connector Board Bill-of-Materials .....	40

---

# CHAPTER 1

## Stellaris® Serial-to-Ethernet Reference Design Kit Overview

Stellaris Reference Design Kits (RDks) accelerate product development by providing ready-to-run hardware. This kit includes all the necessary cables, S2E connector board, and software to run a demo application out of the box.

Figure 1-1. Serial-to-Ethernet Module and S2E Connector Board<sup>1</sup>



## Using the RDK

The recommended steps for using the RDK are:

- **Follow the *Quickstart Guide* included in the kit.**  
The Quickstart guide will help you get the S2E module up and running in minutes. It also contains important safety information that should be read before using the RDK.
- **Follow the appropriate chapters in this document** to configure the S2E module for a specific application.
- **If required, customize the S2E module hardware and software.** Texas Instruments provides full source code and design files.

1. Images are not shown to scale.

## Features

The S2E module is intended as a simple add-on product to existing systems to provide network connectivity. The RDK contains all the necessary hardware to quickly evaluate the module capabilities. The S2E module RDK has the following features:

- LM3S6432 Stellaris microcontroller with 96 kB of Flash memory and 32 kB of SRAM
- 10/100 Mbit Ethernet port
- Two serial ports
  - PORT0 is an asynchronous serial port with RS232 levels
    - Data rates up to 230,400 bits/sec
    - Includes RTS/CTS for flow control
  - PORT1 has 4 CMOS/TTL level signals that can be configured several ways
    - Data rates up to 1 Mbit/sec.
    - As an asynchronous serial port with RTS/CTS flow control or with 2 GPIOs
    - As 4 GPIOs
    - As a synchronous serial port (master or slave) with support for SPI, uWire, and other synchronous protocols
- RDK is USB-powered, no additional power supply required
- Ethernet boot loader for firmware upgrades
- JTAG 10-pin debug header

## Kit Contents

- S2E Module: Serial-to-Ethernet module
- S2E-CKIT: Serial-to-Ethernet connector board
- USB A to miniB cable: For powering the module
- Serial cable DB9M - DB9F: For connecting module to PC serial port
- Ethernet retractable cable: For connecting S2E module to the network
- 20-pin to fine-pitch 10-pin ARM JTAG debug adapter
- S2E-CKIT standoffs: For optional attachment to S2E-CKIT board

## Description

### Serial-to-Ethernet Module

Figure 1-2 shows the S2E module diagram. The S2E header connector provides the serial port signals and power signals to the module. For the RDK, this is connected to the S2E-CKIT (see Figure 1-3). For more information on the S2E module, see the Serial-to-Ethernet board data sheet.

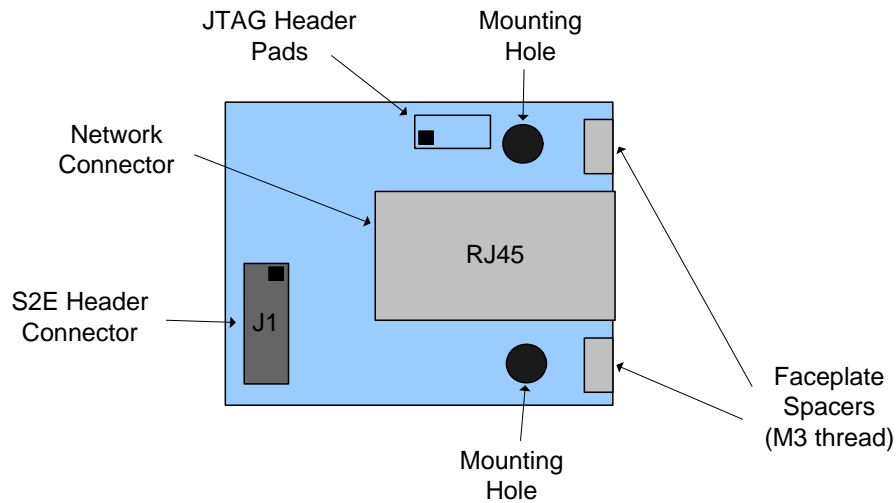

**Figure 1-2. Serial-to-Ethernet Module**

## Serial-to-Ethernet Connector Board

Figure 1-3 shows the Serial-to-Ethernet connector board. The board connects to the S2E module via the J1 connector, and provides connectors for power and serial port connections during RDK evaluation and development. Power can be provided by the USB connector (5 V) or by the J3 header (3.3 V). A power indicator LED turns on when power is applied. Header J2 provides the CMOS/TTL signals for the module Port1 signals, see Table 1-1. The J3 header signals are shown in Table 1-2.

**Figure 1-3. Serial-to-Ethernet Connector Board**

Table 1-1. J2 Header Signals

J2 Header Pin	Stellaris GPIO	Description
1	PD2/PA4	Serial data input to S2E module (UART or SPI)
2	PD3/PA5	Serial data output from S2E module (UART or SPI)
3	PA3	UART CTS output or SPI select signal
4	PA2	UART RTS input or SPI clock signal
5	RSTn	Reset input to S2E module (leave unconnected if unused)
6	GND	Ground signal

Table 1-2. J3 Header Signals

J3 Header Pin	Signal	Description
3.3 V	3.3 V	3.3 V power input. Use only if the USB power connector is not used, otherwise leave unconnected.
GND	GND	Ground signal

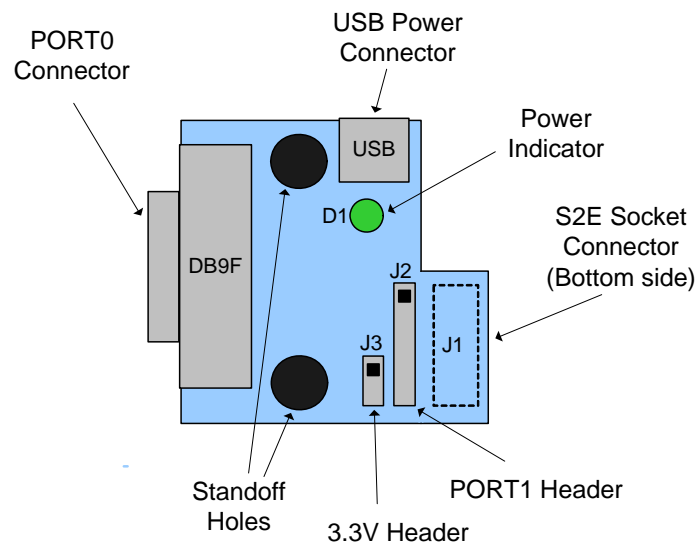
## Flow Control

The S2E module supports bidirectional RTS/CTS flow control, as defined in the RS-232 E standard.

For the receiver, in this mode of operation, the S2E asserts the CTS signal when it capable of receiving data, and it deasserts the signal when transmission by the remote serial device should be paused. In the S2E module, the CTS signal is asserted by setting the CTS output GPIO for the 0 (or low) level. The signal is deasserted by setting the GPIO output value to the 1 (or high) level.

For the transmitter, the RTS GPIO signal is monitored for state changes. When the state changes to asserted, transmission is allowed/resumed. When the state changes to deasserted, transmission is paused. The polarity of the RTS GPIO signal is interpreted in the same way as for the CTS GPIO signal. If the RTS GPIO signal is 1 (or high level), it is considered to be deasserted, and the UART transmitter is disabled (the current byte, if any, is completed). When the signal is 0 or low level), it is considered to be asserted, and the transmitter is re-enabled.

## Installation

The requirements for installation include a PC with an available serial port with a DB9 male connector and a USB port, and an available 10/100Mbit network port. The S2E-CKIT board contains the connectors required for powering and connecting the module, and sits on top of the S2E module. Use the following steps to connect the S2E module to the S2E-CKIT connector board (see Figure 1-4).

1. Attach the provided nylon standoffs to S2E-CKIT (optional).
2. Attach S2E-CKIT to the S2E module. Align the 12-pin socket to the 12-pin connector on the S2E module and press firmly.

3. Connect the serial cable: DB9M (male) side to the DB9F(female) connector on the S2E-CKIT and DB9F side to the serial port on the PC.
4. Connect the USB cable MiniAB plug to the S2E-CKIT and the other side to the PC. The green LED on the S2E-CKIT should turn on, indicating that the S2E module is now powered.
5. Connect the ethernet retractable cable to the S2E module and to a network port.

**Figure 1-4. S2E Module Connection to S2E-CKIT**

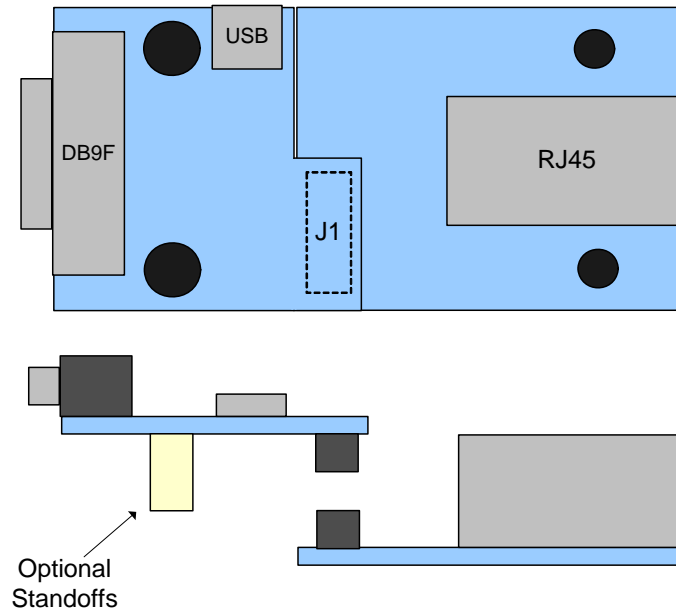

## Specifications

### Electrical

- USB power: 5V at 200mA

### Mechanical

- S2E module PCB size: 1.475 x 1.555" x 0.63" (39.5 mm x 37.5 mm x 16 mm)
- S2E-CKIT PCB size: 1.475 x 1.5" x 0.57" (39.5 mm x 38.1 mm x 14.5 mm)



# CHAPTER 2

---

## Serial-to-Ethernet Configuration and Firmware Update

The software in the S2E module includes an embedded web server that provides a convenient configuration interface.

### Accessing the Configuration Website

You can access the S2E module's web-based configuration interface:

- Using the Finder Utility
- Using "My Network Places"
- Using the LM S2E Browser Application

### Using the Finder Utility

**NOTE:** It is assumed that the StellarisWare Firmware Development Package for the S2E has already been installed and that the S2E module has been connected as described in the Installation section of this document.

To access the configuration website using the Finder utility:

1. Browse to the \StellarisWare\tools\bin directory.
2. Double click on the finder.exe icon. The Finder utility starts and you should see the S2E module in the list of available Stellaris® boards similar to the screen shot below.

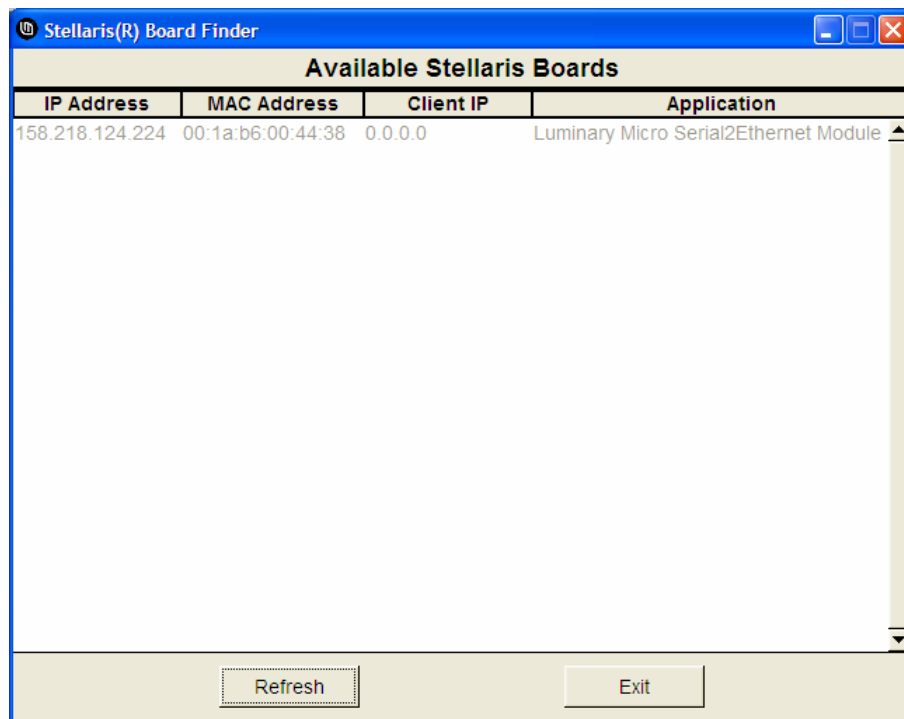

3. Start your web browser and type the IP address found in Step 2 into the address bar. The S2E configuration website loads.

## Using “My Network Places”

To access the configuration website without using the S2E configuration application, Windows must first be configured to show icons for networked UPnP devices. To do this in Windows XP, follow these steps:

1. Click **Start**, and then click **Control Panel**. Click **Add or Remove Programs**.
2. Click **Add/Remove Windows Components**.
3. In the **Components** list, click to select the **Networking Services** check box, and then click **Details**.
4. In the **Subcomponents of Networking Services** list, click to select **UPnP User Interface** check box and then click **OK**.

**NOTE:** To remove the UPnP UI components, click to clear the **UPnP User Interface** check box.

5. In the **Windows Components Wizard**, click **Next**.

For more information on Windows and UPnP, visit the Microsoft Help and Support website at <http://support.microsoft.com/>.

To find the UPnP icon for the S2E module, follow these steps:

1. Go to “My Network Places”. “My Network Places” can typically be found by simply clicking **Start** and then **My Network Places**.
2. Look for a UPnP icon labeled “Luminary Micro Serial2Ethernet Module”. The label should also include the IP address of the S2E module.

Double-clicking on the icon will bring up the configuration website served up by the S2E module in a web browser.

Figure 2-1. LM S2E Browser Window

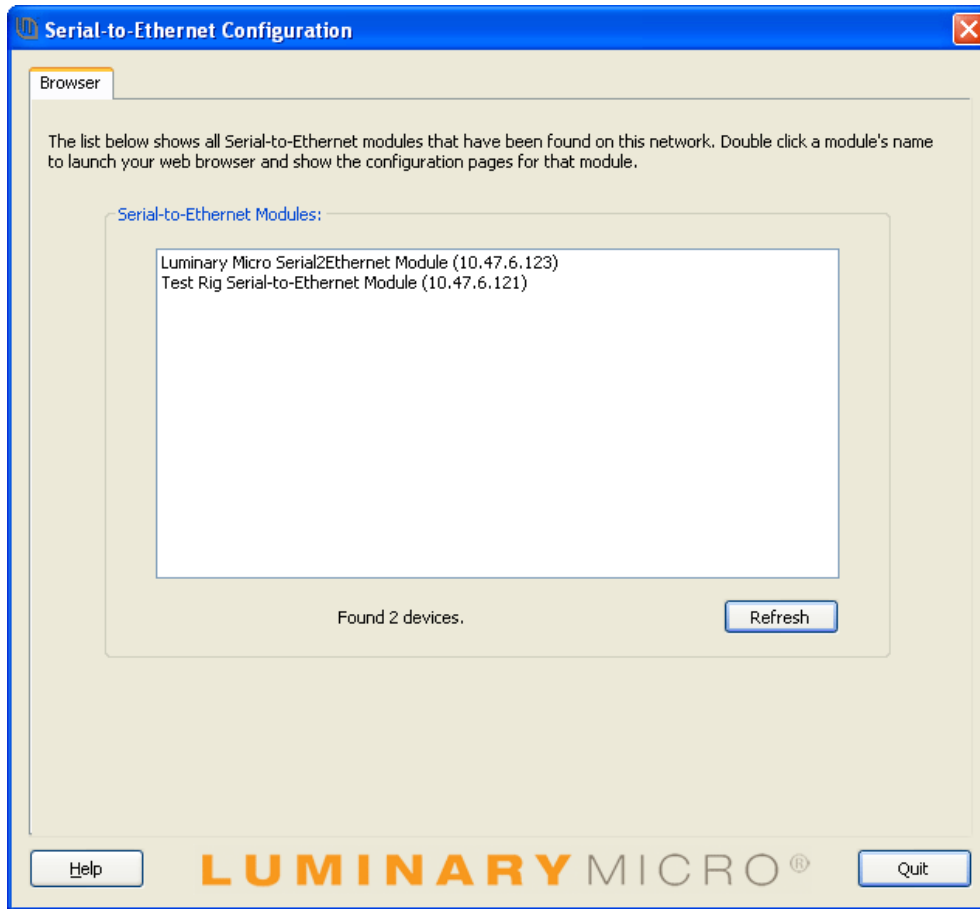

**NOTE:** If the “Luminary Micro Serial2Ethernet Module” UPnP icon is not present, ensure that you have configured Windows appropriately to show icons for networked UPnP devices.

## Using the LM S2E Browser Application

If you installed the S2E configuration applications, to access the module configuration website:

1. Click **Start**, and then select **All Programs > Luminary Micro > Serial-to-Ethernet Configuration > LM S2E Browser**.
2. The application shows a list of all the S2E modules on your network. If “Searching for devices...” appears below the list, wait a few seconds for the list to populate.
3. Double-click the desired module. Your default web browser launches and loads the selected configuration website.

## Home Page

The home page of the configuration website shows the current status and configuration information. Included are the name, IP address, and MAC address of the S2E module as well as the current port settings for both port 0 and port 1. Figure 2-2 shows the home page of the website hosted by the S2E module.

Figure 2-2. Home Page of the Configuration Website

The screenshot shows a web browser window titled "Luminary Micro S2E Module - Windows Internet Explorer" with the address bar showing "http://10.47.6.55/". The page content includes the Luminary Micro logo and the title "Luminary Micro S2E Module". Under the heading "Status & Configuration", there is a sidebar with links for "Home", "Port 0 Settings", "Port 1 Settings", "Miscellaneous Settings", and "Firmware Update". The main content area displays the following information:

**Name:** Luminary Micro Serial2Ethernet Module  
**Firmware Revision:** 0  
**IP Address:** 10.47.6.55  
**MAC Address:** 00-1a-b6-00-43-03

**Current port settings:**

	Port 0	Port 1
Baud Rate:	115200 bits/second	115200 bits/second
Data Size:	8 bits/character	8 bits/character
Parity:	None	None
Stop Bits:	1 bit(s)	1 bit(s)
Flow Control:	None	None
Local Telnet Port Number:	23	26
Remote Telnet Port Number:	N/A	N/A
Telnet Mode:	Server	Server
Telnet Protocol:	Telnet	Telnet
Telnet Server IP:	N/A	N/A
Telnet Timeout:	0mS	0mS

The footer of the page contains the Luminary Micro logo, the slogan "Outstanding in the field!", and the copyright notice "Copyright © 2008 Luminary Micro, Inc. All rights reserved." The browser status bar at the bottom shows "Done" and "Internet" with a 100% zoom level.

## Port 0 and Port 1 Settings Pages

The "Port 0 Settings" page allows configuration of port 0 of the S2E module. Similarly, the "Port 1 Settings" page allows configuration of port 1 of the S2E module. The following configuration options are provided:

- Baud Rate – specifies the baud rate to be used by the serial port. There are several options from 110 to 230400 bits/S.
- Data Size – configures the number of data bits per character. The options are 5 to 8 bits / character.
- Parity – specifies the generation and checking of the parity bit in the data frame and the type of parity used. The options are "None", "Odd", "Even", "Mark", and "Space".
- Stop Bits – specifies the number of stop bits at the end of a frame.
- Flow Control – specifies the use of flow control. The options are "None" and "Hardware".
- Local Telnet Port Number – specifies the local telnet port number to be used.



- Remote Telnet Port Number – specifies the remote telnet port number to be used when the “Telnet Mode” is set to “Client”.
- Telnet Mode – specifies whether the telnet mode for that port will be “Server” or “Client”.
- Telnet Protocol – specifies whether the data for the port will be “Telnet” or “Raw”.
- Telnet Server IP – specifies the IP address of the telnet server when the “Telnet Mode” is set to “Client”.
- Telnet Timeout – specifies the telnet timeout in seconds. The default is 0 and specifies that no timeout is to be used.

After changing the settings, click the “Apply Changes” button to cause the changes to take effect. If the “Make these the default settings” check box is checked before clicking the “Apply Changes” button, then the new settings are applied each time the S2E module is reset. Otherwise, the existing defaults are used whenever the module is next reset. Figure 2-3 shows the configuration page for Port 0.

Figure 2-3. Port 0 Configuration Window

**Port 0 Settings**

**Home**

Port 0 Settings

**Port 1 Settings**

**Miscellaneous Settings**

**Firmware Update**

**Settings:**

The current settings for port 0 may be changed using the form below. To make the new settings apply each time the S2E module is reset, ensure that "Make these the default settings" is checked before pressing the "Apply Changes" button. If this control is not checked, the changes are applied to the port but the existing defaults are used whenever the module is next reset.

	Current	Updated
Baud Rate:	115207 bits/second	230400 bits/S
Data Size:	8 bits/character	5 bits/character
Parity:	None	None
Stop Bits:	1 bit(s)	2 bit(s)
Flow Control:	None	None
Local Telnet Port Number:	23	23
Remote Telnet Port Number:	N/A	23
Telnet Mode:	Server	Server
Telnet Server IP:	N/A	0 . 0 . 0 . 0
Telnet Timeout:	0seconds	0 seconds (0 for no timeout)

Make these the default settings.

LUMINARY MICRO Outstanding in the field! Copyright © 2008 Luminary Micro, Inc. All rights reserved.

## Miscellaneous Settings Page

The Miscellaneous Settings page of the website is divided into three sections: "IP Address Selection", "General Configuration Settings", and "Restore Factory Defaults".

The "IP Address Selection" portion of the page allows configuration of the S2E module to automatically obtain an IP address or use a static IP address at start up. If the "DHCP/AutoIP" option is chosen, the S2E module will first attempt to get an IP address from a DHCP server. If a DHCP server cannot be located, the S2E module will obtain a link local IP address using the AutoIP protocol. If the "Static IP" option is chosen, then the "Static IP Address", "Subnet Mask", and "Default Gateway" fields need to be filled in. Clicking the "Update Settings" button will cause the settings to be saved.

The "General Configuration Settings" portion of the page allows modification of the "Module Name" and "UPnP port number". Clicking the "Update Settings" button will cause the settings to be saved.

The “Restore Factory Defaults” portion of the page allows restoring all of the options to their default states. Figure 2-4 shows the Miscellaneous Settings page of the website.

**Figure 2-4. Miscellaneous Settings Page**

The screenshot shows a web browser window titled "Luminary Micro S2E Module - Windows Internet Explorer" with the URL "http://10.47.6.82/". The page content includes the Luminary Micro logo and the title "Luminary Micro S2E Module".

**Miscellaneous Settings**

Home Name: Luminary Micro Serial2Ethernet Module  
 Port 0 Settings IP Address: 10.47.6.82  
 Port 1 Settings MAC Address: 00-1a-b6-00-43-0c

Miscellaneous Settings  
 Firmware Update

**IP Address Selection**

Address Type: DHCP/AutoIP  
 Static IP Address: 0 . 0 . 0 . 0  
 Subnet Mask: 255 . 255 . 255 . 0  
 Default Gateway: 0 . 0 . 0 . 0  
 Update Settings

**General Configuration Settings**

Module Name: Luminary Micro Serial2Ethernet Module  
 UPnP port number: 6432  
 Update Settings

**Restore Factory Defaults**

Restore all options to their factory default states: Restore Defaults

LUMINARY MICRO Outstanding in the field! Copyright © 2008 Luminary Micro, Inc. All rights reserved.

## Firmware Update Page

The Firmware Update page provides the capability for the application to call the boot loader to initiate a firmware update over Ethernet. Once the boot loader is executing, LM Flash Programmer can be used to update the firmware. LM Flash Programmer is provided on the CD that comes with the S2E RDK and can also be accessed from the website at [http://www.luminarymicro.com/products/software\\_updates.html](http://www.luminarymicro.com/products/software_updates.html).

The steps to complete the firmware update:

1. Using LM Flash Programmer
  - a. Start the LM Flash Programmer GUI.
  - b. On the Configuration tab, select “Manual Configuration” from the “Quick Set” pull-down menu.

- c. Select the "Ethernet Interface" option from the "Interface" pull-down menu.
  - d. Complete the "Client IP Address" field with the IP address shown on the Firmware Update page.
  - e. Complete the "Client MAC Address" field with the MAC address shown on the Firmware Update page.
  - f. Select the Ethernet Adapter of the PC to use.
  - g. Select to the Program tab. Click the "Browse" button and select the binary file for the updated firmware.
- 2.** Using LM Flash Programmer  
Click the "Program" button.
- 3.** If after a few seconds the LM Flash Programmer status bar does not indicate that the update is in progress, using the Firmware Update Page, click the "Update" button.

## Using the S2E Module as a Serial Extender over Ethernet

The application that comes preprogrammed into the S2E module is capable of implementing a serial extender over Ethernet using two S2E modules. This scenario is used to connect two serial devices over a network. This can be useful to overcome cable length limitations. Figure 3-1 shows a typical situation for doing this.

**Figure 3-1. Implementing a Serial Extender over Ethernet**

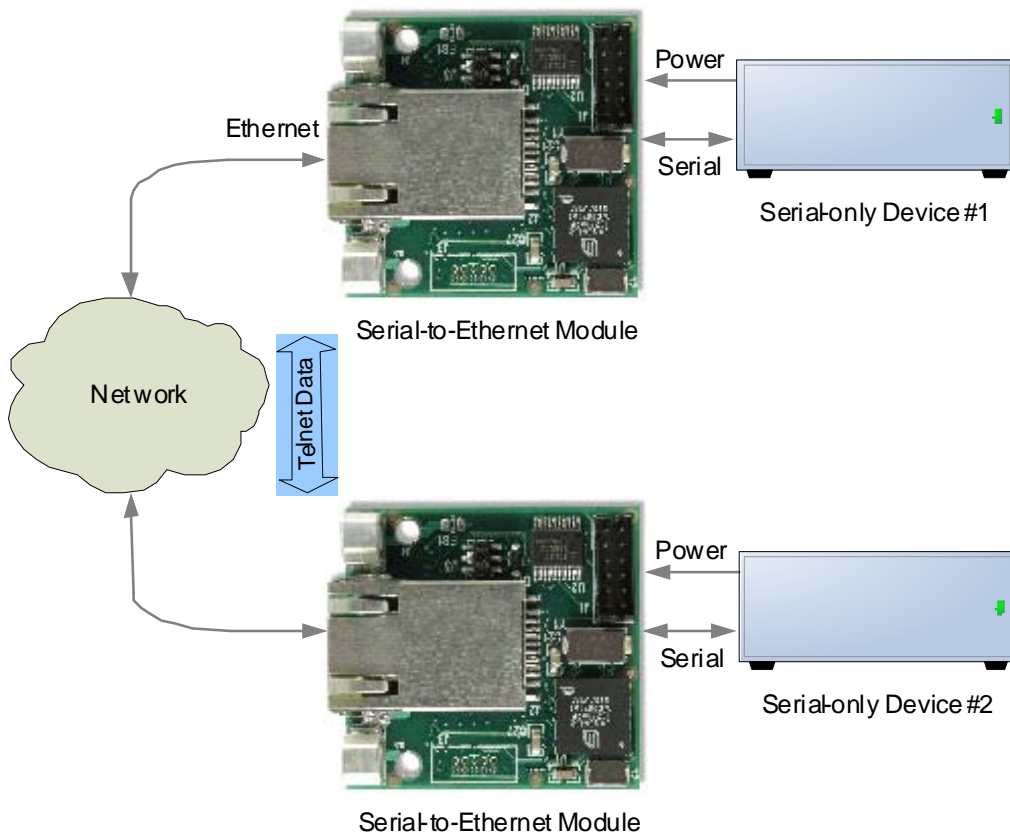

Below are the steps for creating a serial extender example. For this example, the two serial devices are two PCs. In addition, the following assumptions are made: the two S2E modules are connected to a network with a DHCP server so an IP address can be automatically acquired, the two S2E modules are connected to the same subnet as a PC that can be used to configure them, the S2E modules have the factory default settings, and that connector board port 0 is the serial port being used for both S2E modules.

**NOTE:** In a longer term situation, the two S2E modules would be configured to have static IP addresses since IP addresses can change over time when using DHCP.

1. Connect the serial port of one of the S2E modules to the serial port of a PC.
2. Connect the serial port of the other S2E module to the serial port of another PC.
3. Connect both S2E modules to a network with a DHCP server.
4. Power both S2E modules.
5. After the modules power up, both will automatically be configured as telnet servers by default. One will need to be configured to be a telnet client. Use a PC to double-click on one of the UPnP icons that corresponds to one of the S2E modules. This will load the configuration website for that S2E module. For details on accessing and using the configuration website, see the **S2E Configuration and Firmware Update** section.
6. Once the configuration page is loaded, click the link for "Port 0 Settings".
7. Configure the "Telnet Mode" to be "Client", the "Local Telnet Port Number" and "Remote Telnet Port Number" to be 23, and the "Telnet Server IP" to be the IP address of the other S2E module.
8. Open HyperTerminal on each of the PCs connected to the S2E modules. For each instance of HyperTerminal, select the COM port used by that PC to connect to the S2E module (most likely COM1) and configure it for 115200 bits per second, 8 data bits, no parity, 1 stop bit, and no flow control.
9. Once HyperTerminal is started and configured on each of the PCs, messages can be sent from one PC to the other by simply typing in the HyperTerminal window. Note that the default HyperTerminal settings will not display the typed characters in the transmitting window.

## Using Serial-to-Ethernet as a Virtual COM Port

The S2E module can be configured to appear as a virtual COM port (VCP) on a computer running Windows. VCP software is provided on the RDK Documentation and Software CD.

### Overview

The Virtual COM port (VCP) feature allows legacy software that only supports serial communication to communicate with a serial-only device over Ethernet.

Figure 4-1 shows a typical S2E module application. This section describes how to install the VCP software necessary to map the S2E module to a Windows COM port. VCP operation requires two separate applications. The first, com0com creates a virtual COM port pair. Then com2tcp links one half of the virtual COM port pair to the S2E module. The application software (for example, HyperTerminal) connects to the other half of the virtual COM port pair.

To easily set-up and configure com0com and com2tcp connections to specific modules, use the LM S2E Configuration application included on the software CD.

**Figure 4-1. Typical S2E Module**

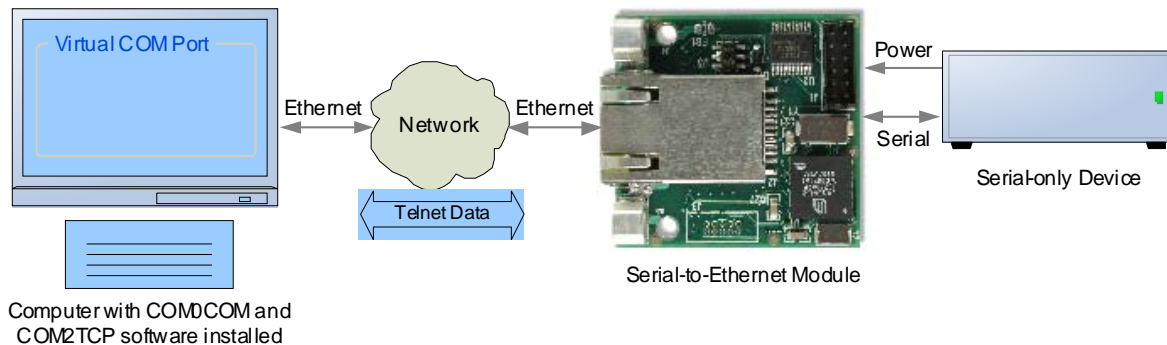

Before configuring VCP please complete all steps in the S2E Quickstart Guide and get familiar with using the web configuration interface.

### Install com0com

Com0com is an open source virtual serial port driver for Windows. Once installed it will configure one or more pairs of virtual COM ports each time Windows starts.

1. Insert the RDK Documentation and Software CD into the CD-ROM drive of your computer. If Autoplay is enabled on your PC, the index.htm file automatically opens in your default web browser. If not, use Windows Explorer or other browser to open the index.htm file manually.
2. From the CD menu, click the **Install com0com** button; this will start the installation process. If you prefer to manually install com0com, the setup.exe file is located in the /Software/com0com directory.
3. Com0com installation starts with the following dialog.

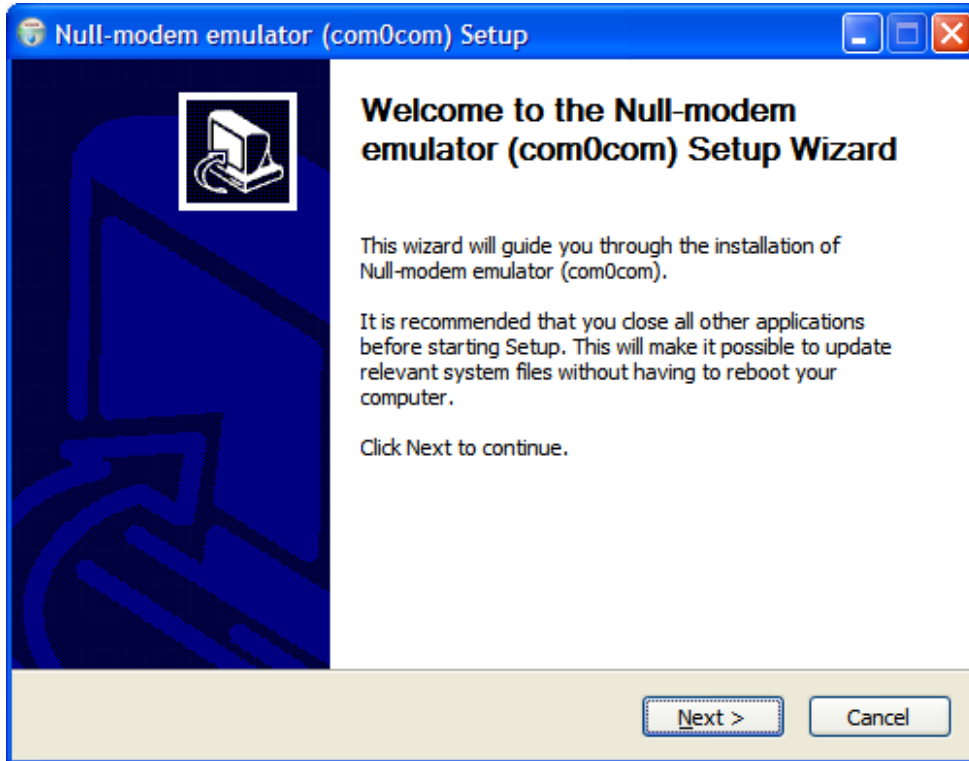

Click **Next**.

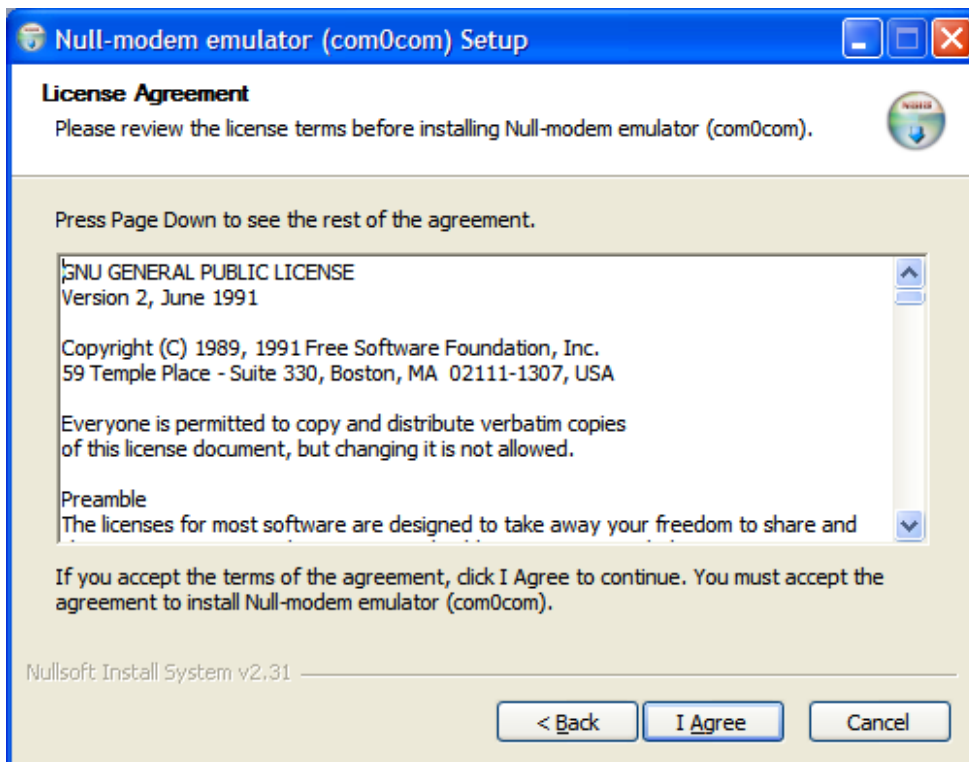

Click **I Agree**.



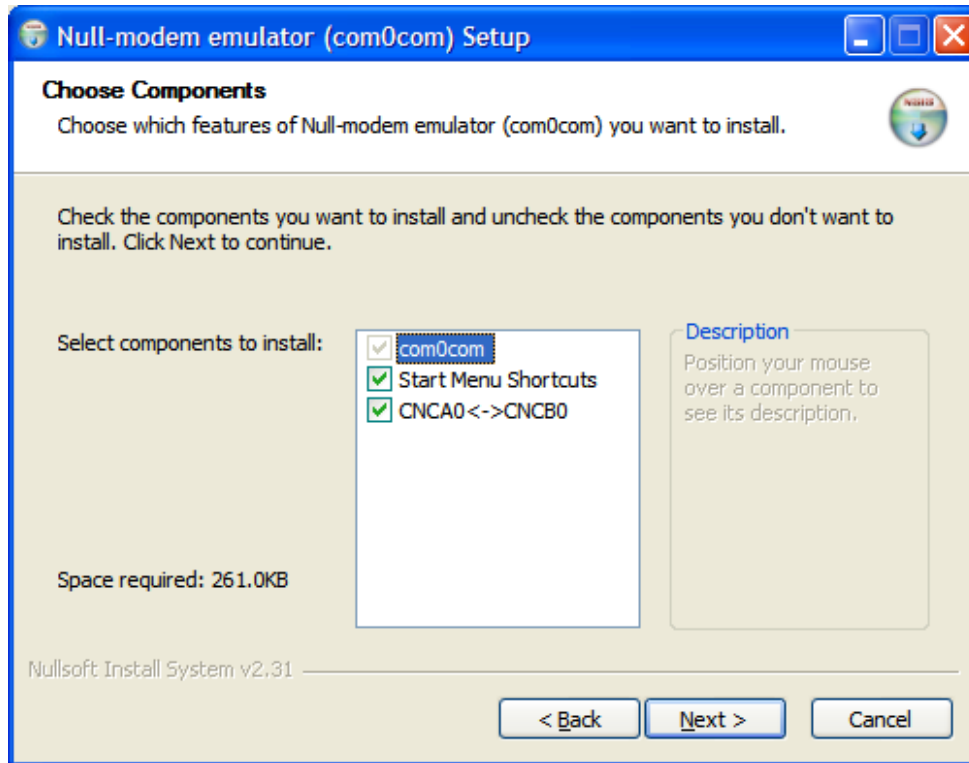

Leave the Component setup at the default settings. Click **Next**.

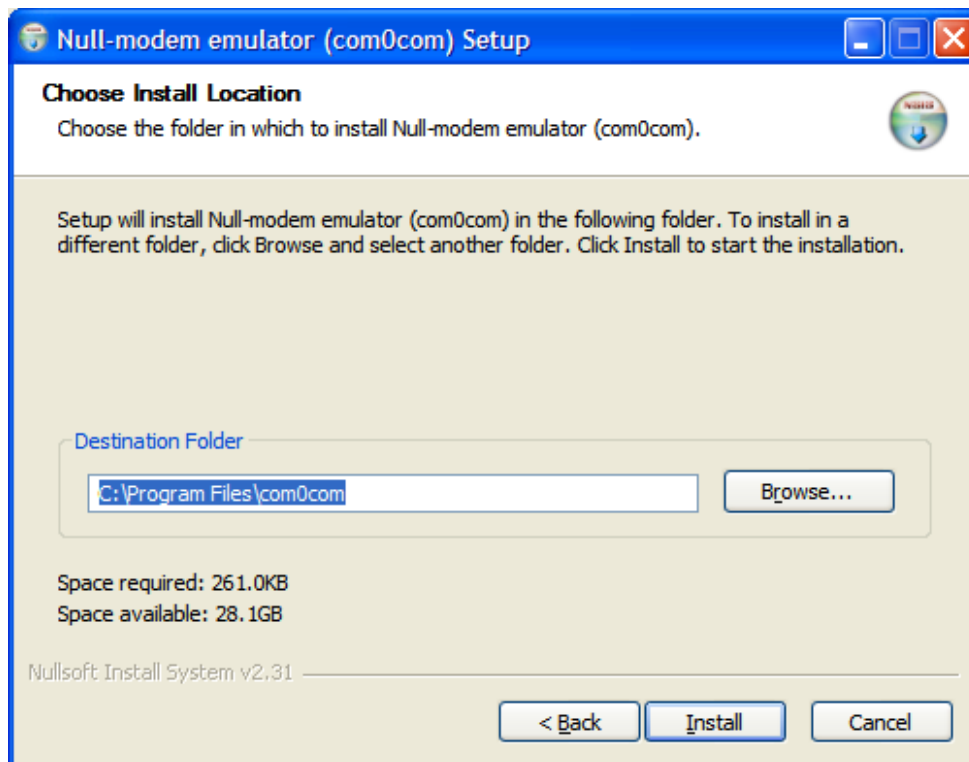

Choose the Install Location. Click **Install**.

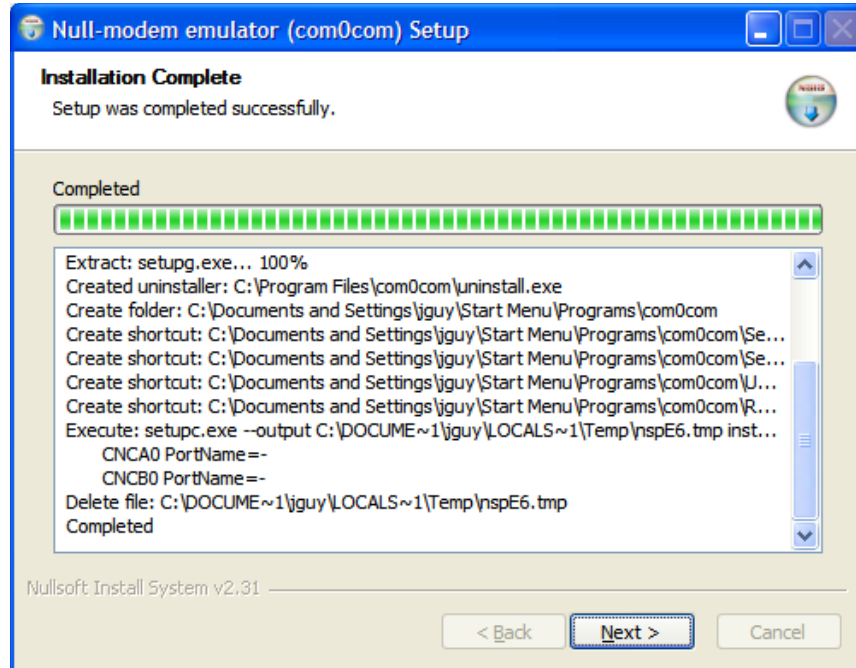

Installation will complete. When installation is done click **Next**.

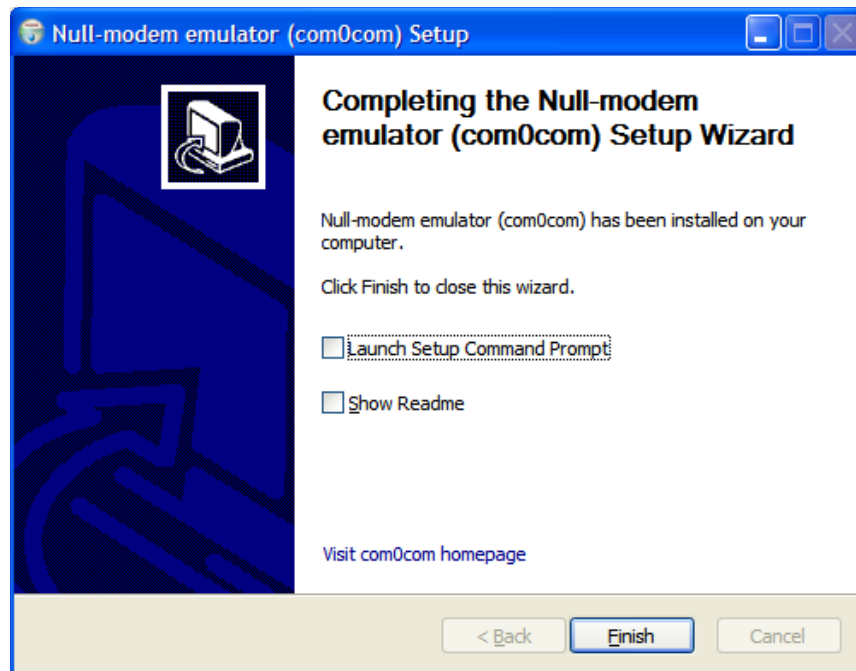

Click **Finish**.

The Windows New Hardware Wizard will now run automatically for each of the two new Virtual COM ports. Please complete the following steps twice.



Windows will detect the new Com port. When the New Hardware Wizard run, select **No, not this time** and click **Next**.

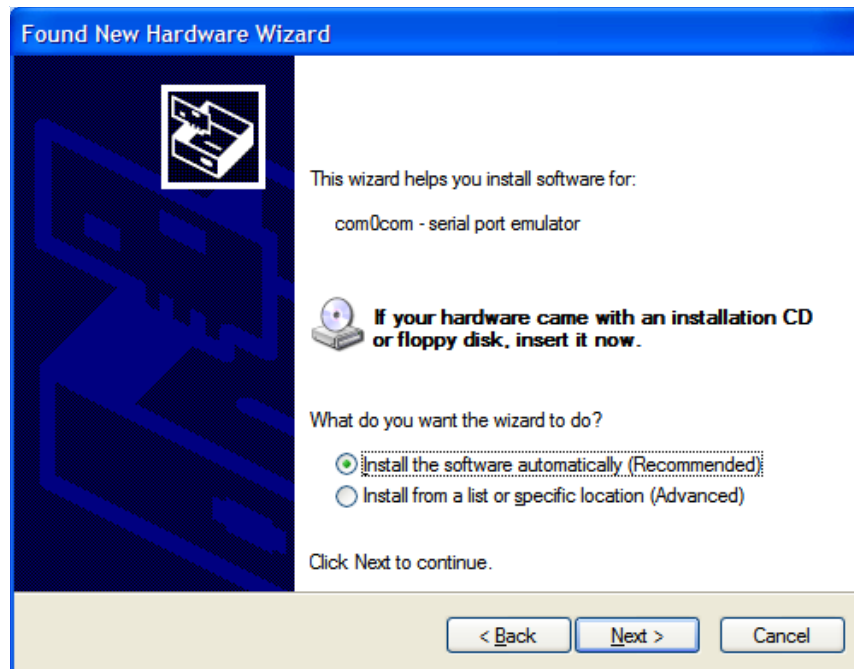

Select **Install the software automatically**. Click **Next**.

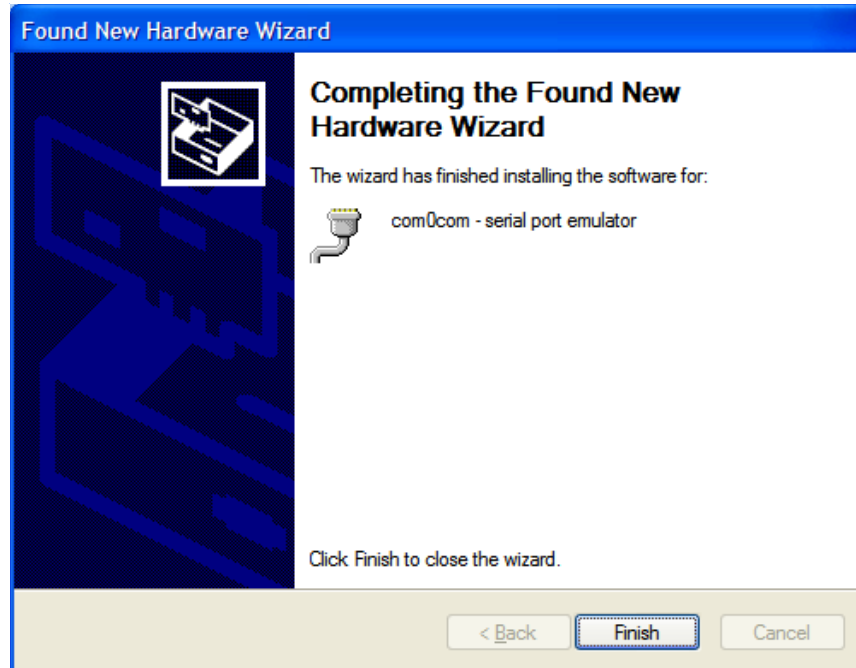

When the New Hardware Wizard completes, click **Finish**.

Repeat for the second half of the Virtual Com port pair.

Com0com has now created virtual Com ports CNCA0 and CNCB0. These ports will be visible to Windows serial applications such as HyperTerminal. The port names can be change by running the LM S2E Configuration application. For LM S2E Configuration application installation instructions, see "Install LM PC S2E Configuration" on page 28.

## Install com2tcp

Com2tcp is an open-source project used in conjunction with com0com to redirect data traffic from a virtual COM port on the PC to a telnet server or client on the Ethernet network. To install com2tcp:

1. In the RDK documentation and software CD menu, select **Install com2tcp**.
2. In the Install com2tcp page that appears, right-click **com2tcp application**.
3. When prompted, select **Save Target As** and navigate to your selected installation location. It is recommended that you install com2tcp in the same directory as com0com; by default this is `C:\Program Files\com0com`.

## Install LM PC S2E Configuration

The Serial-to-Ethernet PC Configuration application offers a convenient method of setting up VCP connections to S2E modules. It allows the creation of com0com virtual COM ports and their connection to particular S2E modules using com2tcp. To install the LM S2E Configuration application:

1. In the RDK documentation and software CD menu, select **Windows Configuration Utility - Download**.
2. When the Welcome window appears, click **Next**.

3. In the license agreement window, select **I Agree** and click **Next**.
4. In the Installation Options window, selecting **Start all connections automatically** (recommended) allows the application to automatically start all appropriately configured VCP connections when Windows boots and adds the option “LM S2E Launcher” under All Programs in the Windows Start menu.
5. Click **Next**.
6. Choose the desired installation location or use the default installation location indicated. Click **Next**.
7. Click **Next** to confirm the installation process and start copying application files.
8. When the Installation Complete window appears, click **Close**.

After installation completes, review the options available in your Windows Start menu. You should see the menu group highlighted in Figure 4-2.

**Figure 4-2. Luminary Micro menu group**

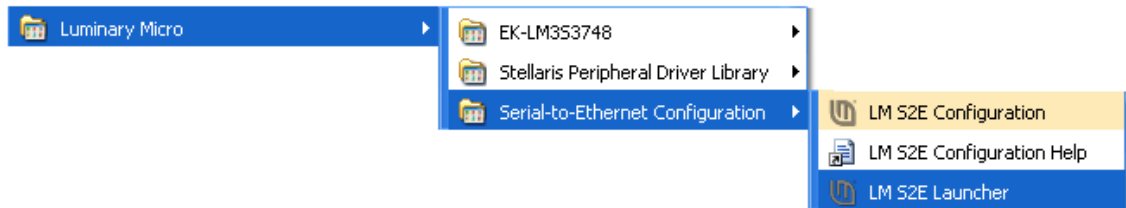

After selecting **Start > All Programs > Luminary Micro > Serial-to-Ethernet Configuration**:

- To start the PC Configuration application, select **LM S2E PC Configuration**. For instructions on how to do this, see “Configure VCP Using the LM S2E PC Configuration Application” on page 29.
- To view the application’s help file, select **LM S2E PC Configuration Help** or press the F1 key while the application is running.
- To start VCP connections to S2E modules, if not automatically started upon Windows boot (see step 4 of “Install LM PC S2E Configuration”), select the **LM S2E Launcher** companion application. To search for S2E modules on the network and access their configuration pages, select **LM S2E Browser**.

## Configure VCP Using the LM S2E PC Configuration Application

The LM S2E Configuration application offers easy creation and modification of VCP connections using a single application. Such connections contain several components:

- The legacy serial application connects to a virtual COM port on the PC. This port is one of a pair created using com0com. From within the LM S2E Configuration application you can create new port pairs and edit the names of existing ports to cater to serial applications that do not understand the default CNCA/CNCB naming convention used by com0com.
- The second port in the pair is opened by com2tcp, which creates a telnet connection to the remote S2E module over Ethernet. The Configuration application lists all S2E modules it finds and offers a convenient method for accessing their web-based configuration pages.

- The S2E module connects to the remote serial device, as shown in Figure 4-3.

Figure 4-3. S2E module connection over Ethernet

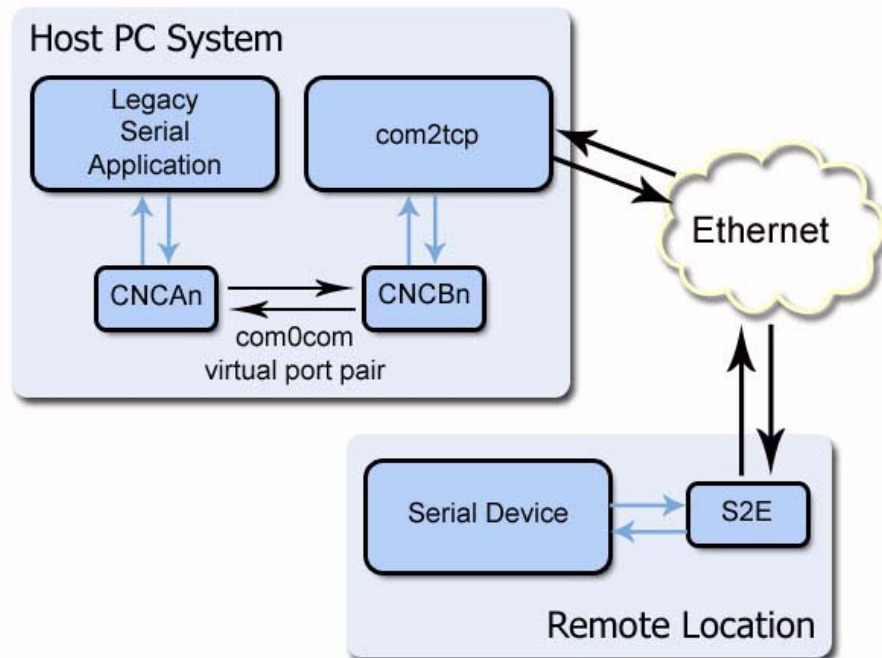

## Connection Creation

The LM S2E Configuration application gathers the information necessary for creating these connections using com0com and UPnP and then saves entries in the system registry, which are later read by the LM S2E Launcher companion application when it starts the connections.

The connections created here assume that the S2E module is running as a telnet server, which is the default for this module.

To create a new connection between a virtual COM port on the PC and remote device:

1. Select **Start > All Programs > Luminary Micro > Serial-to-Ethernet Configuration > LM S2E PC Configuration**.

The first time the application starts it ensures that com0com and com2tcp are present. If you did not install these in the default locations, the application prompts you for the location of each. You only have to provide this location information once and will not be reprompted unless you remove one or both packages or move one or both packages to a new location. If one or other of the packages is not installed, the application will continue to run but will offer the, "LM S2E Browser" functionality and not show any com0com/com2tcp options.

2. Once the application locates both the com0com and com2tcp packages, the main application window appears, as shown in Figure 4-4.

Figure 4-4. Main LM S2E Configuration application window

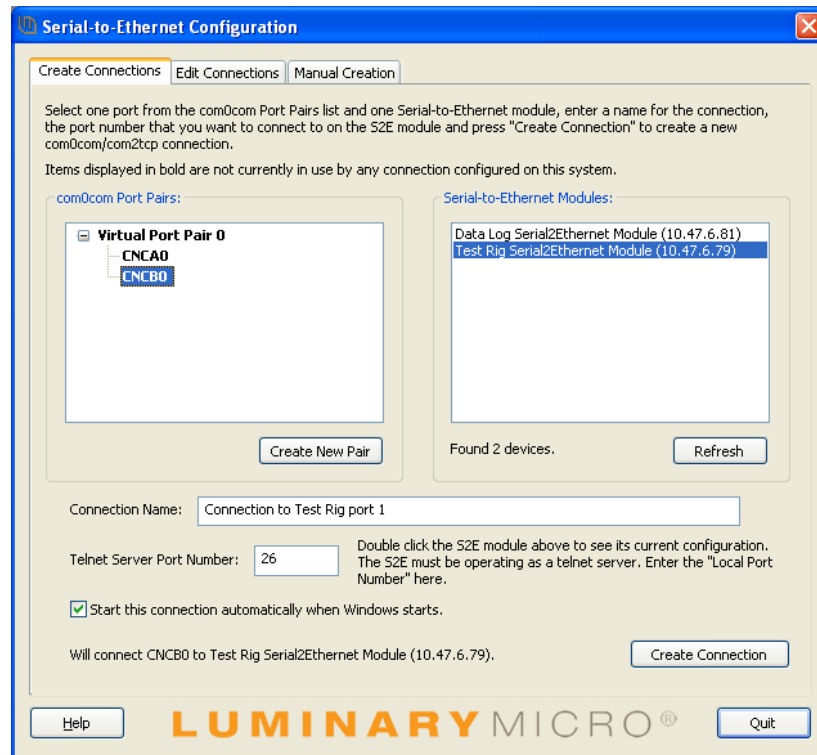

3. The application performs a UPnP query to discover all S2E modules on the network. Once this query completes, the Serial-to-Ethernet Modules pane of the main application window updates to show a complete list of the modules found. Once this list appears, select the module to which you want to set up a connection. Double-click a module to launch its configuration website.
4. In the com0com Port Pairs pane, click the **+** to the left of **Virtual Port Pair 0** to expand the listing. Select one of the two virtual COM ports listed. This is the port that com2tcp will use in the connection you are configuring.
5. Enter a **Connection Name** for this connection.
6. Enter the **Telnet Server Port Number** (TCP/IP port number) for the S2E module and serial port.  
To find the **Telnet Server Port Number**, double-click the configuration module's listing to go to its website. Then, go to the Status & Configuration page and locate the Local Telnet Port Number row, and select the number for the serial connection, Port 0 or Port 1, that you wish to use with this connection.
7. Select **Start this connection automatically when Windows starts**. This ensures that the LM S2E Launch companion application automatically starts the connection.  
If you do not select this option, the LM S2E Launcher application does not start the connection even if you run it manually, unless you provide the -a command line option that instructs the launcher to start all connections.
8. Click **Create Connection** to save the information on the newly configured connection for future use by the LM S2E Launcher.

Notice that **Virtual Port Pair 0** is no longer bolded, indicating that the port pair is already in use and you cannot configure another connection using the same pair.

To create another VCP pair for use by your second (or subsequent) connection, click **Create New Pair** and repeat the process, beginning with step 4, selecting newly created virtual port pair listing.

9. Select **Start > All Programs > Luminary Micro > Serial-to-Ethernet Configuration > LM S2E Launcher**. The launcher application reads the connection information you just configured and starts com2tcp to initiate a connection with the desired S2E module.
10. You can now start your legacy serial application and open virtual COM port CNCA0 and communicate with the remote serial device attached to the S2E module.

## Edit port names

Some serial applications are unable to connect to a serial port named using a form other than COMm, where m is the port number. Since com0com ports are named CNCA<sub>n</sub> and CNCB<sub>n</sub> by default, this can cause problems. If you encounter this problem, the LM S2E Configuration application allows you to change the names of virtual COM ports, as long as neither port in the pair is currently part of a configured connection.

To edit the port name, expand the virtual port pair listing that contains the port you want to change. Double-click the port name, edit the connection name, and press ENTER.

## Manual VCP Configuration

If you do not want to install the LM S2E Configuration application, you can manually configure and start com0com and com2tcp connections.

To manually create a virtual port pair, select **All Programs > com0com > setup**. Once you create a virtual port pair, com2tcp establishes a link between one of the two ports in the pair and the S2E module. You can select either port for use with com2tcp.

You must also know the following:

- The module's IP address

For information on determining the IP address using My Network Places, see the *S2E RDK Quickstart* document.

- The module's telnet port number

The default telnet port numbers are 23 and 26. For information on determining the specific telnet port numbers, see the *S2E RDK Quickstart* document.

The process for manual VCP configuration shown here assumes the creation of a com0com port pair with the default name, as occurs with initial installation of the com0com package, and that com2tcp will use CNCB0 and the legacy serial application will use CNCA0.

1. Open a command prompt window; to do this, select **Start > All Programs > Accessories > Command Prompt**.
2. Change to the installation location for com2tcp.
3. At the command prompt, enter

```
com2tcp --telnet \\.\<CNCB0> <IP address> <telnet port>
```

where

- <CNCB0> is the name of the VCP used by com2tcp, for which CNCB0 is the default name



- <IP address> is the actual S2E IP address; for example, 169.254.5.67
- <telnet port> is the actual telnet port number; for example, 23

For an example of this command string and the module's response, see Figure 4-5.

**Figure 4-5. Manual VCP configuration**

```

Command Prompt - com2tcp --telnet \\.\CNCB0 169.254.5.67 23
C:\Documents and Settings>cd c:\program files\com0com
C:\Program Files\com0com>com2tcp --telnet \\.\CNCB0 169.254.5.67 23
OpenC0C("\\.\CNCB0", baud=19200, data=8, parity=no, stop=1) - OK

```

Com0com now has an established link between the S2E module and virtual COM port CNCB0, allowing Windows applications to connect to the S2E module through the virtual COM port CNCA0 (the port used by the legacy serial application). When communication occurs, com2tcp provides status information in the command prompt window, as shown in Figure 4-6.

**Figure 4-6. Com2tcp communication shown in the command prompt window**

```

Command Prompt - com2tcp --telnet \\.\CNCB0 169.254.5.67 23
C:\>cd c:\program files\com0com
C:\Program Files\com0com>com2tcp --telnet \\.\CNCB0 169.254.5.67 23
OpenC0C("\\.\CNCB0", baud=19200, data=8, parity=no, stop=1) - OK
DSR is ON
WaitComReady() - OK
Connect("169.254.5.67", "23") - OK
InOut() START
DSR is ON
RECU: DO 3
SEND: WONT 3
RECU: DO 44
SEND: WONT 44

```

If you need to end com2tcp, click the command prompt window to be sure it is the active window and press CTRL+C.

## Verify VCP Operation

Connect the S2E hardware (as described in the *Quickstart Guide*). Open two HyperTerminal windows, one Virtual COM port and one standard COM port, as follows:

1. Open one HyperTerminal window. On Windows XP, HyperTerminal can be found by clicking **Start, Programs, Accessories**, and then **Communications**.
2. Enter a name for the terminal window and click **OK**.
3. In the **Connect Using** pull-down menu, select the COM port associated with the port that the DB9 cable is connected to on your PC and click **OK**.
4. Select 115200 for **Bits per second**, 8 for **Data bits**, None for **Parity**, 1 for **Stop Bits**, and None for **Flow Control**.
5. Open another HyperTerminal window.
6. Enter a name for the terminal window and click **OK**.
7. In the **Connect Using** pull-down menu, select **CNCA0**. Then click **OK**.

- Now you can type in one of the HyperTerminal windows and see the text displayed in the other HyperTerminal window. This demonstrates the S2E module converting serial data to Ethernet and vice versa.

Figure 4-7 show the HyperTerminal File **Properties Dialog** configuration. In this example, the connection was named S2E VCP.

**Figure 4-7. HyperTerminal File Properties Dialog**

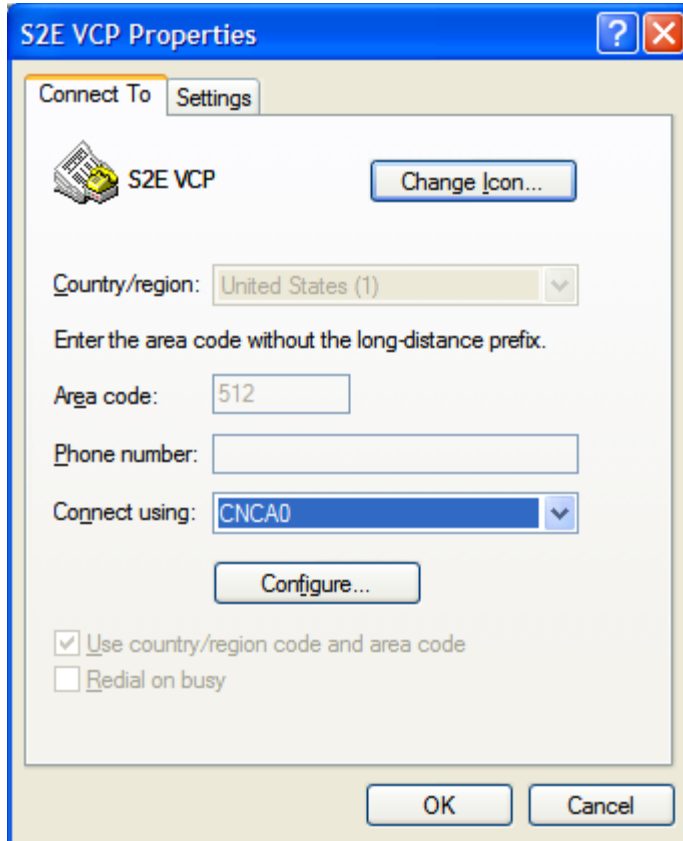

Com0com and com2tcp are open-source (GPL) projects. For additional information and source code for the com0com and com2tcp, refer to the S2E documentation and source code CD or search the Internet for the respective project name.

# CHAPTER 5

## Hardware Description

The Serial-to-Ethernet (S2E) board is a simple add-on product that provides serial UART to Ethernet communications. Existing systems that lack Ethernet connectivity but have a UART port can be easily upgraded by the addition of the S2E module. A simple web server is used for module configuration.

The Serial-to-Ethernet Reference Design Kit (RDK) adds a second board (S2E-CKIT) with connectors and cables for easy connection to a PC. All design files are provided on the RDK-S2E CD.

## Block Diagram

Figure 5-1 shows the S2E block diagram.

Figure 5-1. Serial-to-Ethernet Block Diagram

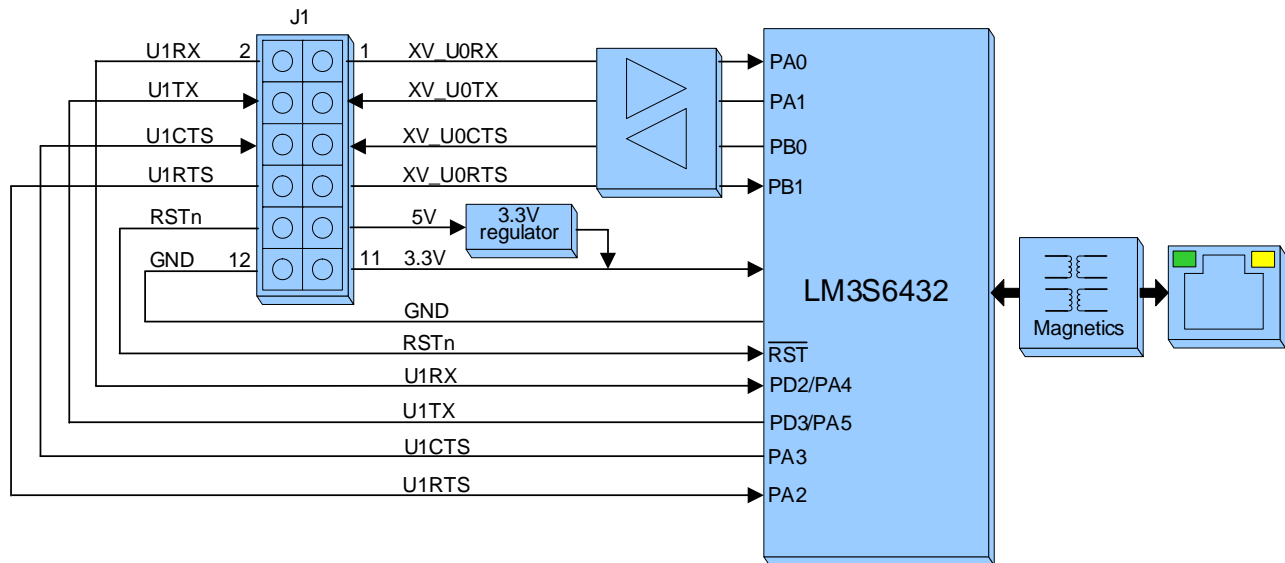



## **Schematics**

This sections contains the schematic diagram for the S2E Module.

- Serial-to-Ethernet module on page 38

Revision History

Revision	Date	Description
X0	1/16/2008	First release.
X1	1/18/2008	Second release.
X2	1/21/2008	Added JTAG pullups.
X3	1/25/2008	Added pulldown to U2 pin 1 to enable operation with ICL3223.
RA	1/26/2008	Released for manufacturing.
RB	2/12/2008	Fixed S1,S2 pads, rotated J3, fixed net names.
RC	4/2/2008	Added pulldown resistor to U1-K3, added pullups to U2 to enable transceiver after reset. Renamed GNDPHY (U1-K3) to ERBIAS, fixed termination for ethernet RX signals. Added JTAG test pads.

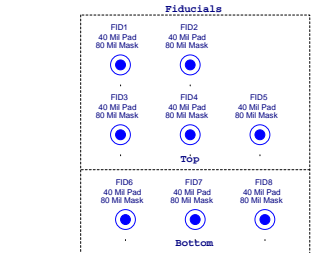
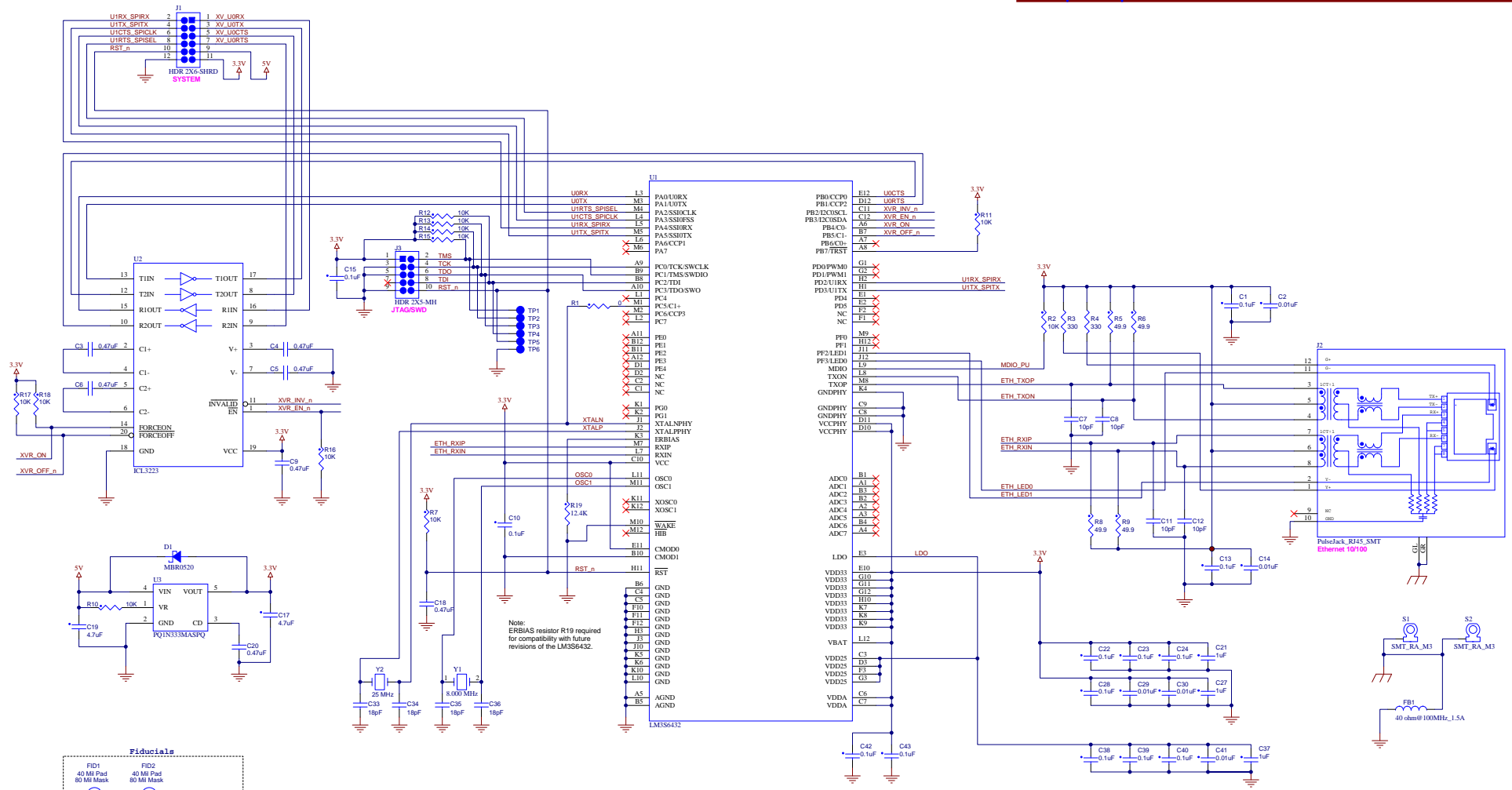

**TEXAS INSTRUMENTS**  
 100 Wood Basin Rd.  
 Two Wood Basin Suite 300  
 Austin, TX 78746

This document contains information proprietary to Texas Instruments, Inc. and shall not be used for engineering design, procurement of manufacture in whole or in part without the express written permission of Texas Instruments. Copyright © 2007 Texas Instruments, Inc. All rights reserved.

Designer: Arnaldo Cruz	Drawing Title: <b>SERIAL2ENET Module</b>
Drawn by: Arnaldo Cruz	Page Title: <b>FURY BGA108, UART Transceiver, RJ45 with Magnetics</b>
Approved: +	Size C Document Number: 0001 Rev RC
Date: 4/25/2008	Sheet 1 of 1

# A P P E N D I X B

## Bill of Materials (BOM)

Table B-1 provides the BOM for the Serial-to-Ethernet RDK and Table B-2 provides the BOM for the Serial-to-Ethernet connector board.

**Table B-1. Serial-to-Ethernet Bill-of-Materials**

Designator	Comment	Description	Footprint	MFG	Ordering	Qty
C1, C10, C13, C15, C22, C23, C24, C28, C38, C39, C40, C42, C43	0.1uF		1005[0402]	MURATA	GCM155R71C104KA55D	13
C2, C14, C29, C30, C41	0.01uF		1005[0402]	MURATA	GRM155R71E103KA01D	5
C3, C4, C5, C6, C9, C20	0.47uF	CAP, 0603, 0.47uF, 10%, 16V, X7R	1608[0603]	Murata	GRM188R71C474KA88D	6
C7, C8, C11, C12	10pF	CAP, 0603, 10 pF, 10%, 25V, COG	1608[0603]	AVX	06033A100KAT2A	4
C17, C19	4.7uF	CAP, 0805, X7R, 4.7uF, 20%, 10V	C0805	Murata	GRM21BR61A475MA73L	2
C21, C27, C37	1uF	CAP, 0805, X7R, 1uF, 10%, 10V	C0805	Murata	GRM21BR71A105KA01L	3
C33, C34, C35, C36	18pF	CAP, 0402, C0G, 18pF, 50V	1005[0402]	MURATA	GRM1555C1H180JZ01D	4
D1	MBR0520	DIODE SCHOTTKY 0.5A 20V	SOD-123	Fairchild Semiconductor	MBR0520L	1
J1	HDR 2X6-SHRD	HDR, SHROUDED 2x6, 2mm CTR	HDR2X6 - 2mm	Hirose Electric Co	DF11-12DP-2DSA(24)	1
J2	PulseJack_RJ45_SMT	PulseJack RJ45 with XFMR 1CT:1, TX, RX SMT	RJ45-SMT-J30	Pulse Engineering	J3011G21DNL	1
J3	HDR 2x5-MH	MICRO HDR, 2x5, 0.050" CTR	HDR 2x5_SHRD_.050	HARWIN	M50-3500542	1
R2, R7, R10, R16	10K	RES, SO, 0603, 10K, 1%, 1/10W	J1-0603	Vishay/Dale	CRCW060310K0FKEA	4
R3, R4	330	RES, SO, 0603, 330 Ohm, 1%, 1/10W	J1-0603	Vishay/Dale	CRCW0603330RFEA	2
R5, R6, R8, R9	49.9	RES, SO, 0603, 49.9, 1%, 1/10W	J1-0603	Vishay/Dale	CRCW060349R9FEA	4

**Table B-1. Serial-to-Ethernet Bill-of-Materials (Continued)**

Designator	Comment	Description	Footprint	MFG	Ordering	Qty
S1, S2	SMT_RA_M3	SMT right angle fastener, M3 thread	SMT_RA_M3	Penn Engineering & Manufacturing (PEM)	SMTRAM3-7-5ET	2
U1	ARM Cortex M3 Microcontroller	ARM Cortex-M3 Microcontroller	BGA108C80P12X12_1000X1000X150	Texas Instruments	LM3S6432-IBZ50	1
U2	ICL3223	RS-232 Transceiver, 2 TX, 2 RX, 250Kbit	SSOP-20	Intersil	ICL3223ECAZ	1
U3	PQ1N333MASPQ	IC, 350mA LDO regulator	SOT89-5	Sharp Microelectronics	PQ1N333MASPQ	1
Y1	8.000 MHz	XTAL 8.000MHz	Crystal_NX8045	NDK	NX8045GB-8.000000MHZ	1
Y2	25 MHz	XTAL 25MHz SMT, 50ppm	Crystal_NX5032	NDK	NX5032GA-25.000000MHZ	1

**Table B-2. Serial-to-Ethernet Connector Board Bill-of-Materials**

Designator	Comment	Description	Footprint	MFG	Ordering	Qty
D1	GREEN_LED	LED GREEN SGL 20mA TH	LED-T1-3mm	KINGBRIGHT	WP132XGD	1
J1	SKT 2X6-2mm	SKT 2x6, 2mm CTR	SKT2X6 - 2mm	Hirose Electric Co	DF11-12DS-2DSA	1
J2	HDR 1X6	HDR, 1x6 0.025" PIN, 0.1" CTR	HDR1X6	Molex	22-28-4063	1
J3	HDR 1X2	HDR, 2x1, 0.025" PIN, 0.1" CTR	HDR1X2	Molex	22-28-4023	1
J4	DB9_F	DB9_F	DB9[47X70]-FEMALE	Tyco Electronics/AMP	5747844-4	1
J5	USB Mini AB Socket	CONN USB Min-AB Socket through hole	USB-miniAB	Molex	56579-0519	1
R1	330	RES, SO, 0603, 330 Ohm, 1%, 1/4W	AXIAL-0.4	KOA/Speer	MF1/4DCT52R3300F	1



## IMPORTANT NOTICE

Texas Instruments Incorporated and its subsidiaries (TI) reserve the right to make corrections, modifications, enhancements, improvements, and other changes to its products and services at any time and to discontinue any product or service without notice. Customers should obtain the latest relevant information before placing orders and should verify that such information is current and complete. All products are sold subject to TI's terms and conditions of sale supplied at the time of order acknowledgment.

TI warrants performance of its hardware products to the specifications applicable at the time of sale in accordance with TI's standard warranty. Testing and other quality control techniques are used to the extent TI deems necessary to support this warranty. Except where mandated by government requirements, testing of all parameters of each product is not necessarily performed.

TI assumes no liability for applications assistance or customer product design. Customers are responsible for their products and applications using TI components. To minimize the risks associated with customer products and applications, customers should provide adequate design and operating safeguards.

TI does not warrant or represent that any license, either express or implied, is granted under any TI patent right, copyright, mask work right, or other TI intellectual property right relating to any combination, machine, or process in which TI products or services are used. Information published by TI regarding third-party products or services does not constitute a license from TI to use such products or services or a warranty or endorsement thereof. Use of such information may require a license from a third party under the patents or other intellectual property of the third party, or a license from TI under the patents or other intellectual property of TI.

Reproduction of TI information in TI data books or data sheets is permissible only if reproduction is without alteration and is accompanied by all associated warranties, conditions, limitations, and notices. Reproduction of this information with alteration is an unfair and deceptive business practice. TI is not responsible or liable for such altered documentation. Information of third parties may be subject to additional restrictions.

Resale of TI products or services with statements different from or beyond the parameters stated by TI for that product or service voids all express and any implied warranties for the associated TI product or service and is an unfair and deceptive business practice. TI is not responsible or liable for any such statements.

TI products are not authorized for use in safety-critical applications (such as life support) where a failure of the TI product would reasonably be expected to cause severe personal injury or death, unless officers of the parties have executed an agreement specifically governing such use. Buyers represent that they have all necessary expertise in the safety and regulatory ramifications of their applications, and acknowledge and agree that they are solely responsible for all legal, regulatory and safety-related requirements concerning their products and any use of TI products in such safety-critical applications, notwithstanding any applications-related information or support that may be provided by TI. Further, Buyers must fully indemnify TI and its representatives against any damages arising out of the use of TI products in such safety-critical applications.

TI products are neither designed nor intended for use in military/aerospace applications or environments unless the TI products are specifically designated by TI as military-grade or "enhanced plastic." Only products designated by TI as military-grade meet military specifications. Buyers acknowledge and agree that any such use of TI products which TI has not designated as military-grade is solely at the Buyer's risk, and that they are solely responsible for compliance with all legal and regulatory requirements in connection with such use.

TI products are neither designed nor intended for use in automotive applications or environments unless the specific TI products are designated by TI as compliant with ISO/TS 16949 requirements. Buyers acknowledge and agree that, if they use any non-designated products in automotive applications, TI will not be responsible for any failure to meet such requirements.

Following are URLs where you can obtain information on other Texas Instruments products and application solutions:

### Products

Amplifiers	<a href="http://amplifier.ti.com">amplifier.ti.com</a>
Data Converters	<a href="http://dataconverter.ti.com">dataconverter.ti.com</a>
DLP® Products	<a href="http://www.dlp.com">www.dlp.com</a>
DSP	<a href="http://dsp.ti.com">dsp.ti.com</a>
Clocks and Timers	<a href="http://www.ti.com/clocks">www.ti.com/clocks</a>
Interface	<a href="http://interface.ti.com">interface.ti.com</a>
Logic	<a href="http://logic.ti.com">logic.ti.com</a>
Power Mgmt	<a href="http://power.ti.com">power.ti.com</a>
Microcontrollers	<a href="http://microcontroller.ti.com">microcontroller.ti.com</a>
RFID	<a href="http://www.ti-rfid.com">www.ti-rfid.com</a>
RF/IF and ZigBee® Solutions	<a href="http://www.ti.com/lprf">www.ti.com/lprf</a>

### Applications

Audio	<a href="http://www.ti.com/audio">www.ti.com/audio</a>
Automotive	<a href="http://www.ti.com/automotive">www.ti.com/automotive</a>
Broadband	<a href="http://www.ti.com/broadband">www.ti.com/broadband</a>
Digital Control	<a href="http://www.ti.com/digitalcontrol">www.ti.com/digitalcontrol</a>
Medical	<a href="http://www.ti.com/medical">www.ti.com/medical</a>
Military	<a href="http://www.ti.com/military">www.ti.com/military</a>
Optical Networking	<a href="http://www.ti.com/opticalnetwork">www.ti.com/opticalnetwork</a>
Security	<a href="http://www.ti.com/security">www.ti.com/security</a>
Telephony	<a href="http://www.ti.com/telephony">www.ti.com/telephony</a>
Video & Imaging	<a href="http://www.ti.com/video">www.ti.com/video</a>
Wireless	<a href="http://www.ti.com/wireless">www.ti.com/wireless</a>

Mailing Address: Texas Instruments, Post Office Box 655303, Dallas, Texas 75265  
Copyright © 2009, Texas Instruments Incorporated