

AM1806 ARM Microprocessor System

Reference Guide



Literature Number: SPRUGU4A
May 2011

Preface	19
1 Overview	21
1.1 Introduction	22
1.2 Block Diagram	22
1.3 ARM Subsystem	22
2 ARM Subsystem	23
2.1 Introduction	24
2.2 Operating States/Modes	25
2.3 Processor Status Registers	25
2.4 Exceptions and Exception Vectors	26
2.5 The 16-BIS/32-BIS Concept	27
2.6 16-BIS/32-BIS Advantages	27
2.7 Co-Processor 15 (CP15)	28
2.7.1 Addresses in an ARM926EJ-S System	28
2.7.2 Memory Management Unit	28
2.7.3 Caches and Write Buffer	29
3 System Interconnect	31
3.1 Introduction	32
3.2 System Interconnect Block Diagram	33
4 System Memory	35
4.1 Introduction	36
4.2 ARM Memories	36
4.3 On-Chip RAM Memory	36
4.4 External Memories	36
4.5 Internal Peripherals	36
4.6 Peripherals	36
5 Memory Protection Unit (MPU)	37
5.1 Introduction	38
5.1.1 Purpose of the MPU	38
5.1.2 Features	38
5.1.3 Block Diagram	38
5.1.4 MPU Default Configuration	39
5.2 Architecture	39
5.2.1 Privilege Levels	39
5.2.2 Memory Protection Ranges	40
5.2.3 Permission Structures	41
5.2.4 Protection Check	42
5.2.5 MPU Register Protection	42
5.2.6 Invalid Accesses and Exceptions	42
5.2.7 Reset Considerations	42
5.2.8 Interrupt Support	43
5.2.9 Emulation Considerations	43
5.3 MPU Registers	44
5.3.1 Revision Identification Register (REVID)	46

5.3.2	Configuration Register (CONFIG)	46
5.3.3	Interrupt Raw Status/Set Register (IRAWSTAT)	47
5.3.4	Interrupt Enable Status/Clear Register (IENSTAT)	48
5.3.5	Interrupt Enable Set Register (IENSET)	49
5.3.6	Interrupt Enable Clear Register (IENCLR)	49
5.3.7	Fixed Range Start Address Register (FXD_MPSAR)	50
5.3.8	Fixed Range End Address Register (FXD_MPEAR)	50
5.3.9	Fixed Range Memory Protection Page Attributes Register (FXD_MPPA)	51
5.3.10	Programmable Range <i>n</i> Start Address Registers (PROG _{<i>n</i>} _MPSAR)	52
5.3.11	Programmable Range <i>n</i> End Address Registers (PROG _{<i>n</i>} _MPEAR)	53
5.3.12	Programmable Range <i>n</i> Memory Protection Page Attributes Register (PROG _{<i>n</i>} _MPPA)	54
5.3.13	Fault Address Register (FLTADDRR)	55
5.3.14	Fault Status Register (FLTSTAT)	56
5.3.15	Fault Clear Register (FLTCLR)	57
6	Device Clocking	59
6.1	Overview	60
6.2	Frequency Flexibility	62
6.3	Peripheral Clocking	63
6.3.1	USB Clocking	63
6.3.2	DDR2/mDDR Memory Controller Clocking	64
6.3.3	EMIFA Clocking	66
6.3.4	uPP Clocking	67
6.3.5	McASP Clocking	68
6.3.6	I/O Domains	69
7	Phase-Locked Loop Controller (PLL)	71
7.1	Introduction	72
7.2	PLL Controllers	72
7.2.1	Device Clock Generation	74
7.2.2	Steps for Programming the PLLs	75
7.3	PLL Registers	77
7.3.1	PLL0 Revision Identification Register (REVID)	78
7.3.2	PLL1 Revision Identification Register (REVID)	79
7.3.3	Reset Type Status Register (RSTYPE)	79
7.3.4	PLL0 Reset Control Register (RCTRL)	80
7.3.5	PLL0 Control Register (PLLCTL)	81
7.3.6	PLL1 Control Register (PLLCTL)	82
7.3.7	PLL0 OBSCLK Select Register (OCSEL)	83
7.3.8	PLL1 OBSCLK Select Register (OCSEL)	84
7.3.9	PLL Multiplier Control Register (PLLM)	85
7.3.10	PLL0 Pre-Divider Control Register (PREDIV)	85
7.3.11	PLL0 Divider 1 Register (PLLDIV1)	86
7.3.12	PLL1 Divider 1 Register (PLLDIV1)	86
7.3.13	PLL0 Divider 2 Register (PLLDIV2)	87
7.3.14	PLL1 Divider 2 Register (PLLDIV2)	87
7.3.15	PLL0 Divider 3 Register (PLLDIV3)	88
7.3.16	PLL1 Divider 3 Register (PLLDIV3)	88
7.3.17	PLL0 Divider 4 Register (PLLDIV4)	89
7.3.18	PLL0 Divider 5 Register (PLLDIV5)	89
7.3.19	PLL0 Divider 6 Register (PLLDIV6)	90
7.3.20	PLL0 Divider 7 Register (PLLDIV7)	90
7.3.21	PLL0 Oscillator Divider 1 Register (OSCDIV)	91
7.3.22	PLL1 Oscillator Divider 1 Register (OSCDIV)	91
7.3.23	PLL Post-Divider Control Register (POSTDIV)	92

7.3.24	PLL Controller Command Register (PLLCMD)	92
7.3.25	PLL Controller Status Register (PLLSTAT)	93
7.3.26	PLL0 Clock Align Control Register (ALNCTL)	94
7.3.27	PLL1 Clock Align Control Register (ALNCTL)	95
7.3.28	PLL0 PLLDIV Ratio Change Status Register (DCHANGE)	96
7.3.29	PLL1 PLLDIV Ratio Change Status Register (DCHANGE)	97
7.3.30	PLL0 Clock Enable Control Register (CKEN)	98
7.3.31	PLL1 Clock Enable Control Register (CKEN)	98
7.3.32	PLL0 Clock Status Register (CKSTAT)	99
7.3.33	PLL1 Clock Status Register (CKSTAT)	100
7.3.34	PLL0 SYSCLK Status Register (SYSTAT)	101
7.3.35	PLL1 SYSCLK Status Register (SYSTAT)	102
7.3.36	Emulation Performance Counter 0 Register (EMUCNT0)	103
7.3.37	Emulation Performance Counter 1 Register (EMUCNT1)	103
8	Power and Sleep Controller (PSC)	105
8.1	Introduction	106
8.2	Power Domain and Module Topology	106
8.2.1	Power Domain States	108
8.2.2	Module States	109
8.3	Executing State Transitions	111
8.3.1	Power Domain State Transitions	111
8.3.2	Module State Transitions	111
8.4	IcePick Emulation Support in the PSC	112
8.5	PSC Interrupts	112
8.5.1	Interrupt Events	112
8.5.2	Interrupt Registers	113
8.5.3	Interrupt Handling	114
8.6	PSC Registers	115
8.6.1	Revision Identification Register (REVID)	116
8.6.2	Interrupt Evaluation Register (INTEVAL)	116
8.6.3	PSC0 Module Error Pending Register 0 (modules 0-15) (MERRPR0)	117
8.6.4	PSC1 Module Error Pending Register 0 (modules 0-31) (MERRPR0)	117
8.6.5	PSC0 Module Error Clear Register 0 (modules 0-15) (MERRCR0)	118
8.6.6	PSC1 Module Error Clear Register 0 (modules 0-31) (MERRCR0)	118
8.6.7	Power Error Pending Register (PERRPR)	119
8.6.8	Power Error Clear Register (PERRCR)	119
8.6.9	Power Domain Transition Command Register (PTCMD)	120
8.6.10	Power Domain Transition Status Register (PTSTAT)	121
8.6.11	Power Domain 0 Status Register (PDSTAT0)	122
8.6.12	Power Domain 1 Status Register (PDSTAT1)	123
8.6.13	Power Domain 0 Control Register (PDCTL0)	124
8.6.14	Power Domain 1 Control Register (PDCTL1)	125
8.6.15	Power Domain 0 Configuration Register (PDCFG0)	126
8.6.16	Power Domain 1 Configuration Register (PDCFG1)	127
8.6.17	Module Status <i>n</i> Register (MDSTAT n)	128
8.6.18	PSC0 Module Control <i>n</i> Register (modules 0-15) (MDCTL n)	129
8.6.19	PSC1 Module Control <i>n</i> Register (modules 0-31) (MDCTL n)	130
9	Power Management	131
9.1	Introduction	132
9.2	Power Consumption Overview	132
9.3	PSC and PLLC Overview	132
9.4	Features	133
9.5	Clock Management	134

9.5.1	Module Clock ON/OFF	134
9.5.2	Module Clock Frequency Scaling	134
9.5.3	PLL Bypass and Power Down	134
9.6	ARM Sleep Mode Management	135
9.6.1	ARM Wait-For-Interrupt Sleep Mode	135
9.6.2	ARM Clock OFF	136
9.6.3	ARM Subsystem Clock ON	136
9.7	RTC-Only Mode	137
9.8	Dynamic Voltage and Frequency Scaling (DVFS)	137
9.8.1	Frequency Scaling Considerations	138
9.8.2	Voltage Scaling Considerations	138
9.9	Deep Sleep Mode	139
9.9.1	Entering/Exiting Deep Sleep Mode Using Externally Controlled Wake-Up	139
9.9.2	Entering/Exiting Deep Sleep Mode Using RTC Controlled Wake-Up	140
9.9.3	Deep Sleep Sequence	141
9.9.4	Entering/Exiting Deep Sleep Mode Using Software Handshaking	142
9.10	Additional Peripheral Power Management Considerations	142
9.10.1	USB PHY Power Down Control	142
9.10.2	DDR2/mDDR Memory Controller Clock Gating and Self-Refresh Mode	143
9.10.3	LVC MOS I/O Buffer Receiver Disable	143
9.10.4	Pull-Up/Pull-Down Disable	143
10	System Configuration (SYSCFG) Module	145
10.1	Introduction	146
10.2	Protection	146
10.2.1	Privilege Mode Protection	146
10.2.2	Kicker Mechanism Protection	147
10.3	Master Priority Control	147
10.4	SYSCFG Registers	149
10.4.1	Revision Identification Register (REVID)	150
10.4.2	Device Identification Register 0 (DEVIDR0)	151
10.4.3	Boot Configuration Register (BOOTCFG)	151
10.4.4	Kick Registers (KICK0R-KICK1R)	152
10.4.5	Host 0 Configuration Register (HOST0CFG)	153
10.4.6	Interrupt Registers	154
10.4.7	Fault Registers	157
10.4.8	Master Priority Registers (MSTPRI0-MSTPRI2)	159
10.4.9	Pin Multiplexing Control Registers (PINMUX0-PINMUX19)	162
10.4.10	Suspend Source Register (SUSPSRC)	202
10.4.11	Chip Signal Register (CHIPSIG)	205
10.4.12	Chip Signal Clear Register (CHIPSIG_CLR)	206
10.4.13	Chip Configuration 0 Register (CFGCHIP0)	207
10.4.14	Chip Configuration 1 Register (CFGCHIP1)	208
10.4.15	Chip Configuration 2 Register (CFGCHIP2)	210
10.4.16	Chip Configuration 3 Register (CFGCHIP3)	212
10.4.17	Chip Configuration 4 Register (CFGCHIP4)	213
10.4.18	VTP I/O Control Register (VTPIO_CTL)	214
10.4.19	DDR Slew Register (DDR_SLEW)	216
10.4.20	Deep Sleep Register (DEEPSLEEP)	217
10.4.21	Pullup/Pulldown Enable Register (PUPD_ENA)	218
10.4.22	Pullup/Pulldown Select Register (PUPD_SEL)	218
10.4.23	RXACTIVE Control Register (RXACTIVE)	220
11	ARM Interrupt Controller (AINTC)	221
11.1	Introduction	222

11.2	Interrupt Mapping	222
11.3	AINTC Methodology	225
11.3.1	Interrupt Processing	225
11.3.2	Interrupt Enabling	226
11.3.3	Interrupt Status Checking	226
11.3.4	Interrupt Channel Mapping	226
11.3.5	Host Interrupt Mapping Interrupts	226
11.3.6	Interrupt Prioritization	227
11.3.7	Interrupt Nesting	227
11.3.8	Interrupt Vectorization	228
11.3.9	Interrupt Status Clearing	229
11.3.10	Interrupt Disabling	229
11.4	AINTC Registers	229
11.4.1	Revision Identification Register (REVID)	230
11.4.2	Control Register (CR)	231
11.4.3	Global Enable Register (GER)	232
11.4.4	Global Nesting Level Register (GNLR)	232
11.4.5	System Interrupt Status Indexed Set Register (SISR)	233
11.4.6	System Interrupt Status Indexed Clear Register (SICR)	233
11.4.7	System Interrupt Enable Indexed Set Register (EISR)	234
11.4.8	System Interrupt Enable Indexed Clear Register (EICR)	234
11.4.9	Host Interrupt Enable Indexed Set Register (HIEISR)	235
11.4.10	Host Interrupt Enable Indexed Clear Register (HIEICR)	235
11.4.11	Vector Base Register (VBR)	236
11.4.12	Vector Size Register (VSR)	236
11.4.13	Vector Null Register (VNR)	237
11.4.14	Global Prioritized Index Register (GPIR)	237
11.4.15	Global Prioritized Vector Register (GPVR)	238
11.4.16	System Interrupt Status Raw/Set Register 1 (SRSR1)	238
11.4.17	System Interrupt Status Raw/Set Register 2 (SRSR2)	239
11.4.18	System Interrupt Status Raw/Set Register 3 (SRSR3)	239
11.4.19	System Interrupt Status Raw/Set Register 4 (SRSR4)	240
11.4.20	System Interrupt Status Enabled/Clear Register 1 (SECR1)	240
11.4.21	System Interrupt Status Enabled/Clear Register 2 (SECR2)	241
11.4.22	System Interrupt Status Enabled/Clear Register 3 (SECR3)	241
11.4.23	System Interrupt Status Enabled/Clear Register 4 (SECR4)	242
11.4.24	System Interrupt Enable Set Register 1 (ESR1)	242
11.4.25	System Interrupt Enable Set Register 2 (ESR2)	243
11.4.26	System Interrupt Enable Set Register 3 (ESR3)	243
11.4.27	System Interrupt Enable Set Register 4 (ESR4)	244
11.4.28	System Interrupt Enable Clear Register 1 (ECR1)	244
11.4.29	System Interrupt Enable Clear Register 2 (ECR2)	245
11.4.30	System Interrupt Enable Clear Register 3 (ECR3)	245
11.4.31	System Interrupt Enable Clear Register 4 (ECR4)	246
11.4.32	Channel Map Registers (CMR0-CMR25)	246
11.4.33	Host Interrupt Prioritized Index Register 1 (HIPIR1)	247
11.4.34	Host Interrupt Prioritized Index Register 2 (HIPIR2)	247
11.4.35	Host Interrupt Nesting Level Register 1 (HINLR1)	248
11.4.36	Host Interrupt Nesting Level Register 2 (HINLR2)	248
11.4.37	Host Interrupt Enable Register (HIER)	249
11.4.38	Host Interrupt Prioritized Vector Register 1 (HIPVR1)	250
11.4.39	Host Interrupt Prioritized Vector Register 2 (HIPVR2)	250
12	Boot Considerations	251

12.1	Introduction	252
A	Revision History	253

List of Figures

1-1.	AM1806 ARM Microprocessor Block Diagram	22
3-1.	System Interconnect Block Diagram	33
5-1.	MPU Block Diagram.....	38
5-2.	Permission Fields.....	41
5-3.	Revision ID Register (REVID)	46
5-4.	Configuration Register (CONFIG)	46
5-5.	Interrupt Raw Status/Set Register (IRAWSTAT)	47
5-6.	Interrupt Enable Status/Clear Register (IENSTAT)	48
5-7.	Interrupt Enable Set Register (IENSET).....	49
5-8.	Interrupt Enable Clear Register (IENCLR)	49
5-9.	Fixed Range Start Address Register (FXD_MPSAR)	50
5-10.	Fixed Range End Address Register (FXD_MPEAR)	50
5-11.	Fixed Range Memory Protection Page Attributes Register (FXD_MPPA).....	51
5-12.	MPU1 Programmable Range <i>n</i> Start Address Register (PROG _{<i>n</i>} _MPSAR).....	52
5-13.	MPU2 Programmable Range <i>n</i> Start Address Register (PROG _{<i>n</i>} _MPSAR).....	52
5-14.	MPU1 Programmable Range <i>n</i> End Address Register (PROG _{<i>n</i>} _MPEAR).....	53
5-15.	MPU2 Programmable Range <i>n</i> End Address Register (PROG _{<i>n</i>} _MPEAR).....	53
5-16.	Programmable Range Memory Protection Page Attributes Register (PROG _{<i>n</i>} _MPPA).....	54
5-17.	Fault Address Register (FLTADDR)	55
5-18.	Fault Status Register (FLTSTAT)	56
5-19.	Fault Clear Register (FLTCLR)	57
6-1.	Overall Clocking Diagram	61
6-2.	USB Clocking Diagram	63
6-3.	DDR2/mDDR Memory Controller Clocking Diagram.....	65
6-4.	EMIFA Clocking Diagram.....	66
6-5.	uPP Clocking Diagram.....	67
6-6.	McASP Clocking Diagram.....	68
7-1.	PLL Structure	73
7-2.	PLL0 Revision Identification Register (REVID)	78
7-3.	PLL1 Revision Identification Register (REVID)	79
7-4.	Reset Type Status Register (RSTYPE)	79
7-5.	Reset Control Register (RSCTRL)	80
7-6.	PLL0 Control Register (PLLCTL).....	81
7-7.	PLL1 Control Register (PLLCTL).....	82
7-8.	PLL0 OBSCLK Select Register (OCSEL)	83
7-9.	PLL1 OBSCLK Select Register (OCSEL)	84
7-10.	PLL Multiplier Control Register (PLLM).....	85
7-11.	PLL0 Pre-Divider Control Register (PREDIV)	85
7-12.	PLL0 Divider 1 Register (PLLDIV1)	86
7-13.	PLL1 Divider 1 Register (PLLDIV1)	86
7-14.	PLL0 Divider 2 Register (PLLDIV2)	87
7-15.	PLL1 Divider 2 Register (PLLDIV2)	87
7-16.	PLL0 Divider 3 Register (PLLDIV3)	88
7-17.	PLL1 Divider 3 Register (PLLDIV3)	88
7-18.	PLL0 Divider 4 Register (PLLDIV4)	89
7-19.	PLL0 Divider 5 Register (PLLDIV5)	89
7-20.	PLL0 Divider 6 Register (PLLDIV6)	90

7-21.	PLLC0 Divider 7 Register (PLLDIV7)	90
7-22.	PLLC0 Oscillator Divider 1 Register (OSCDIV)	91
7-23.	PLLC1 Oscillator Divider 1 Register (OSCDIV)	91
7-24.	PLL Post-Divider Control Register (POSTDIV)	92
7-25.	PLL Controller Command Register (PLLCMD)	92
7-26.	PLL Controller Status Register (PLLSTAT)	93
7-27.	PLLC0 Clock Align Control Register (ALNCTL)	94
7-28.	PLLC1 Clock Align Control Register (ALNCTL)	95
7-29.	PLLC0 PLLDIV Ratio Change Status Register (DCHANGE)	96
7-30.	PLLC1 PLLDIV Ratio Change Status Register (DCHANGE)	97
7-31.	PLLC0 Clock Enable Control Register (CKEN)	98
7-32.	PLLC1 Clock Enable Control Register (CKEN)	98
7-33.	PLLC0 Clock Status Register (CKSTAT).....	99
7-34.	PLLC1 Clock Status Register (CKSTAT)	100
7-35.	PLLC0 SYSCLK Status Register (SYSTAT)	101
7-36.	PLLC1 SYSCLK Status Register (SYSTAT)	102
7-37.	Emulation Performance Counter 0 Register (EMUCNT0)	103
7-38.	Emulation Performance Counter 1 Register (EMUCNT1)	103
8-1.	Revision Identification Register (REVID)	116
8-2.	Interrupt Evaluation Register (INTEVAL)	116
8-3.	PSC0 Module Error Pending Register 0 (MERRPR0)	117
8-4.	PSC1 Module Error Pending Register 0 (MERRPR0)	117
8-5.	PSC0 Module Error Clear Register 0 (MERRCR0).....	118
8-6.	PSC1 Module Error Clear Register 0 (MERRCR0).....	118
8-7.	Power Error Pending Register (PERRPR).....	119
8-8.	Power Error Clear Register (PERRCR)	119
8-9.	Power Domain Transition Command Register (PTCMD).....	120
8-10.	Power Domain Transition Status Register (PTSTAT).....	121
8-11.	Power Domain 0 Status Register (PDSTAT0)	122
8-12.	Power Domain 1 Status Register (PDSTAT1)	123
8-13.	Power Domain 0 Control Register (PDCTL0)	124
8-14.	Power Domain 1 Control Register (PDCTL1)	125
8-15.	Power Domain 0 Configuration Register (PDCFG0)	126
8-16.	Power Domain 1 Configuration Register (PDCFG1)	127
8-17.	Module Status <i>n</i> Register (MDSTAT <i>n</i>)	128
8-18.	PSC0 Module Control <i>n</i> Register (MDCTL <i>n</i>).....	129
8-19.	PSC1 Module Control <i>n</i> Register (MDCTL <i>n</i>).....	130
9-1.	Deep Sleep Mode Sequence	141
10-1.	Revision Identification Register (REVID)	150
10-2.	Device Identification Register 0 (DEVIDR0).....	151
10-3.	Boot Configuration Register (BOOTCFG)	151
10-4.	Kick 0 Register (KICK0R).....	152
10-5.	Kick 1 Register (KICK1R).....	152
10-6.	Host 0 Configuration Register (HOST0CFG).....	153
10-7.	Interrupt Raw Status/Set Register (IRAWSTAT).....	154
10-8.	Interrupt Enable Status/Clear Register (IENSTAT).....	155
10-9.	Interrupt Enable Register (IENSET)	156
10-10.	Interrupt Enable Clear Register (IENCLR).....	156
10-11.	End of Interrupt Register (EOI).....	157

10-12. Fault Address Register (FLTADDRR)	157
10-13. Fault Status Register (FLTSTAT)	158
10-14. Master Priority 0 Register (MSTPRI0).....	159
10-15. Master Priority 1 Register (MSTPRI1).....	160
10-16. Master Priority 2 Register (MSTPRI2).....	161
10-17. Pin Multiplexing Control 0 Register (PINMUX0)	162
10-18. Pin Multiplexing Control 1 Register (PINMUX1)	164
10-19. Pin Multiplexing Control 2 Register (PINMUX2)	166
10-20. Pin Multiplexing Control 3 Register (PINMUX3)	168
10-21. Pin Multiplexing Control 4 Register (PINMUX4)	170
10-22. Pin Multiplexing Control 5 Register (PINMUX5)	172
10-23. Pin Multiplexing Control 6 Register (PINMUX6)	174
10-24. Pin Multiplexing Control 7 Register (PINMUX7)	176
10-25. Pin Multiplexing Control 8 Register (PINMUX8)	178
10-26. Pin Multiplexing Control 9 Register (PINMUX9)	180
10-27. Pin Multiplexing Control 10 Register (PINMUX10)	182
10-28. Pin Multiplexing Control 11 Register (PINMUX11)	184
10-29. Pin Multiplexing Control 12 Register (PINMUX12)	186
10-30. Pin Multiplexing Control 13 Register (PINMUX13)	188
10-31. Pin Multiplexing Control 14 Register (PINMUX14)	190
10-32. Pin Multiplexing Control 15 Register (PINMUX15)	192
10-33. Pin Multiplexing Control 16 Register (PINMUX16)	194
10-34. Pin Multiplexing Control 17 Register (PINMUX17)	196
10-35. Pin Multiplexing Control 18 Register (PINMUX18)	198
10-36. Pin Multiplexing Control 19 Register (PINMUX19)	200
10-37. Suspend Source Register (SUSPSRC)	202
10-38. Chip Signal Register (CHIPSIG)	205
10-39. Chip Signal Clear Register (CHIPSIG_CLR)	206
10-40. Chip Configuration 0 Register (CFGCHIP0).....	207
10-41. Chip Configuration 1 Register (CFGCHIP1).....	208
10-42. Chip Configuration 2 Register (CFGCHIP2).....	210
10-43. Chip Configuration 3 Register (CFGCHIP3).....	212
10-44. Chip Configuration 4 Register (CFGCHIP4).....	213
10-45. VTP I/O Control Register (VTPIO_CTL)	214
10-46. DDR Slew Register (DDR_SLEW).....	216
10-47. Deep Sleep Register (DEEPSLEEP).....	217
10-48. Pullup/Pulldown Enable Register (PUPD_ENA)	218
10-49. Pullup/Pulldown Select Register (PUPD_SEL)	218
10-50. RXACTIVE Control Register (RXACTIVE).....	220
11-1. AINTC Interrupt Mapping	222
11-2. Flow of System Interrupts to Host	225
11-3. Revision Identification Register (REVID)	230
11-4. Control Register (CR)	231
11-5. Global Enable Register (GER)	232
11-6. Global Nesting Level Register (GNLR)	232
11-7. System Interrupt Status Indexed Set Register (SISR)	233
11-8. System Interrupt Status Indexed Clear Register (SICR).....	233
11-9. System Interrupt Enable Indexed Set Register (EISR)	234
11-10. System Interrupt Enable Indexed Clear Register (EICR).....	234

11-11. Host Interrupt Enable Indexed Set Register (HEISR)	235
11-12. Host Interrupt Enable Indexed Clear Register (HIEICR).....	235
11-13. Vector Base Register (VBR).....	236
11-14. Vector Size Register (VSR).....	236
11-15. Vector Null Register (VNR)	237
11-16. Global Prioritized Index Register (GPIR)	237
11-17. Global Prioritized Vector Register (GPVR)	238
11-18. System Interrupt Status Raw/Set Register 1 (SRSR1)	238
11-19. System Interrupt Status Raw/Set Register 2 (SRSR2)	239
11-20. System Interrupt Status Raw/Set Register 3 (SRSR3)	239
11-21. System Interrupt Status Raw/Set Register 4 (SRSR4)	240
11-22. System Interrupt Status Enabled/Clear Register 1 (SECR1)	240
11-23. System Interrupt Status Enabled/Clear Register 2 (SECR2)	241
11-24. System Interrupt Status Enabled/Clear Register 3 (SECR3)	241
11-25. System Interrupt Status Enabled/Clear Register 4 (SECR4)	242
11-26. System Interrupt Enable Set Register 1 (ESR1).....	242
11-27. System Interrupt Enable Set Register 2 (ESR2).....	243
11-28. System Interrupt Enable Set Register 3 (ESR3).....	243
11-29. System Interrupt Enable Set Register 4 (ESR4).....	244
11-30. System Interrupt Enable Clear Register 1 (ECR1)	244
11-31. System Interrupt Enable Clear Register 2 (ECR2)	245
11-32. System Interrupt Enable Clear Register 3 (ECR3)	245
11-33. System Interrupt Enable Clear Register 4 (ECR4)	246
11-34. Channel Map Registers (CMR _n)	246
11-35. Host Interrupt Prioritized Index Register 1 (HIPIR1)	247
11-36. Host Interrupt Prioritized Index Register 2 (HIPIR2)	247
11-37. Host Interrupt Nesting Level Register 1 (HINLR1)	248
11-38. Host Interrupt Nesting Level Register 2 (HINLR2)	248
11-39. Host Interrupt Enable Register (HIER)	249
11-40. Host Interrupt Prioritized Vector Register 1 (HIPVR1)	250
11-41. Host Interrupt Prioritized Vector Register 2 (HIPVR2)	250

List of Tables

2-1.	Exception Vector Table for ARM	26
2-2.	Different Address Types in ARM System	28
3-1.	AM1806 ARM Microprocessor System Interconnect Matrix	32
5-1.	MPU Memory Regions.....	39
5-2.	MPU Default Configuration.....	39
5-3.	Device Master Settings	40
5-4.	Request Type Access Controls.....	41
5-5.	MPU_BOOTCFG_ERR Interrupt Sources	43
5-6.	Memory Protection Unit 1 (MPU1) Registers	44
5-7.	Memory Protection Unit 2 (MPU2) Registers	44
5-8.	Revision ID Register (REVID) Field Descriptions	46
5-9.	Configuration Register (CONFIG) Field Descriptions.....	46
5-10.	Interrupt Raw Status/Set Register (IRAWSTAT) Field Descriptions.....	47
5-11.	Interrupt Enable Status/Clear Register (IENSTAT) Field Descriptions	48
5-12.	Interrupt Enable Set Register (IENSET) Field Descriptions	49
5-13.	Interrupt Enable Clear Register (IENCLR) Field Descriptions.....	49
5-14.	Fixed Range Memory Protection Page Attributes Register (FXD_MPPA) Field Descriptions	51
5-15.	MPU1 Programmable Range <i>n</i> Start Address Register (PROG _{<i>n</i>} _MPSAR) Field Descriptions	52
5-16.	MPU2 Programmable Range <i>n</i> Start Address Register (PROG _{<i>n</i>} _MPSAR) Field Descriptions	52
5-17.	MPU1 Programmable Range <i>n</i> End Address Register (PROG _{<i>n</i>} _MPEAR) Field Descriptions	53
5-18.	MPU2 Programmable Range <i>n</i> End Address Register (PROG _{<i>n</i>} _MPEAR) Field Descriptions	53
5-19.	Programmable Range Memory Protection Page Attributes Register (PROG _{<i>n</i>} _MPPA) Field Descriptions ...	54
5-20.	Fault Address Register (FLTADDR) Field Descriptions	55
5-21.	Fault Status Register (FLTSTAT) Field Descriptions	56
5-22.	Fault Clear Register (FLTCLR) Field Descriptions.....	57
6-1.	Device Clock Inputs	60
6-2.	System Clock Domains	60
6-3.	Example PLL Frequencies	63
6-4.	USB Clock Multiplexing Options.....	63
6-5.	DDR2/mDDR Memory Controller MCLK Frequencies.....	65
6-6.	EMIFA Frequencies	66
6-7.	uPP Transmit Clock Selection	67
6-8.	Peripherals	69
7-1.	System PLLC Output Clocks.....	74
7-2.	PLL Controller 0 (PLLC0) Registers	77
7-3.	PLL Controller 1 (PLLC1) Registers	78
7-4.	PLLC0 Revision Identification Register (REVID) Field Descriptions.....	78
7-5.	PLLC1 Revision Identification Register (REVID) Field Descriptions.....	79
7-6.	Reset Type Status Register (RSTYPE) Field Descriptions	79
7-7.	Reset Control Register (RSCTRL) Field Descriptions	80
7-8.	PLLC0 Control Register (PLLCTL) Field Descriptions.....	81
7-9.	PLLC1 Control Register (PLLCTL) Field Descriptions.....	82
7-10.	PLLC0 OBSCLK Select Register (OCSEL) Field Descriptions.....	83
7-11.	PLLC1 OBSCLK Select Register (OCSEL) Field Descriptions.....	84
7-12.	PLL Multiplier Control Register (PLLM) Field Descriptions	85
7-13.	PLLC0 Pre-Divider Control Register (PREDIV) Field Descriptions	85
7-14.	PLLC0 Divider 1 Register (PLLDIV1) Field Descriptions.....	86

7-15.	PLLC1 Divider 1 Register (PLLDIV1) Field Descriptions.....	86
7-16.	PLLC0 Divider 2 Register (PLLDIV2) Field Descriptions.....	87
7-17.	PLLC1 Divider 2 Register (PLLDIV2) Field Descriptions.....	87
7-18.	PLLC0 Divider 3 Register (PLLDIV3) Field Descriptions.....	88
7-19.	PLLC1 Divider 3 Register (PLLDIV3) Field Descriptions.....	88
7-20.	PLLC0 Divider 4 Register (PLLDIV4) Field Descriptions.....	89
7-21.	PLLC0 Divider 5 Register (PLLDIV5) Field Descriptions.....	89
7-22.	PLLC0 Divider 6 Register (PLLDIV6) Field Descriptions.....	90
7-23.	PLLC0 Divider 7 Register (PLLDIV7) Field Descriptions.....	90
7-24.	PLLC0 Oscillator Divider 1 Register (OSCDIV) Field Descriptions	91
7-25.	PLLC1 Oscillator Divider 1 Register (OSCDIV) Field Descriptions	91
7-26.	PLL Post-Divider Control Register (POSTDIV) Field Descriptions.....	92
7-27.	PLL Controller Command Register (PLLCMD) Field Descriptions.....	92
7-28.	PLL Controller Status Register (PLLSTAT) Field Descriptions.....	93
7-29.	PLLC0 Clock Align Control Register (ALNCTL) Field Descriptions.....	94
7-30.	PLLC1 Clock Align Control Register (ALNCTL) Field Descriptions.....	95
7-31.	PLLC0 PLLDIV Ratio Change Status Register (DCHANGE) Field Descriptions.....	96
7-32.	PLLC1 PLLDIV Ratio Change Status Register (DCHANGE) Field Descriptions.....	97
7-33.	PLLC0 Clock Enable Control Register (CKEN) Field Descriptions	98
7-34.	PLLC1 Clock Enable Control Register (CKEN) Field Descriptions	98
7-35.	PLLC0 Clock Status Register (CKSTAT) Field Descriptions	99
7-36.	PLLC1 Clock Status Register (CKSTAT) Field Descriptions.....	100
7-37.	PLLC0 SYSCLK Status Register (SYSTAT) Field Descriptions	101
7-38.	PLLC1 SYSCLK Status Register (SYSTAT) Field Descriptions	102
7-39.	Emulation Performance Counter 0 Register (EMUCNT0) Field Descriptions.....	103
7-40.	Emulation Performance Counter 1 Register (EMUCNT1) Field Descriptions.....	103
8-1.	PSC0 Default Module Configuration.....	107
8-2.	PSC1 Default Module Configuration.....	107
8-3.	Module States	110
8-4.	IcePick Emulation Commands	112
8-5.	PSC Interrupt Events	112
8-6.	Power and Sleep Controller 0 (PSC0) Registers	115
8-7.	Power and Sleep Controller 1 (PSC1) Registers	115
8-8.	Revision Identification Register (REVID) Field Descriptions	116
8-9.	Interrupt Evaluation Register (INTEVAL) Field Descriptions	116
8-10.	PSC0 Module Error Pending Register 0 (MERRPR0) Field Descriptions	117
8-11.	PSC0 Module Error Clear Register 0 (MERRCR0) Field Descriptions	118
8-12.	Power Error Pending Register (PERRPR) Field Descriptions	119
8-13.	Power Error Clear Register (PERRCR) Field Descriptions.....	119
8-14.	Power Domain Transition Command Register (PTCMD) Field Descriptions	120
8-15.	Power Domain Transition Status Register (PTSTAT) Field Descriptions	121
8-16.	Power Domain 0 Status Register (PDSTAT0) Field Descriptions	122
8-17.	Power Domain 1 Status Register (PDSTAT1) Field Descriptions	123
8-18.	Power Domain 0 Control Register (PDCTL0) Field Descriptions.....	124
8-19.	Power Domain 1 Control Register (PDCTL1) Field Descriptions.....	125
8-20.	Power Domain 0 Configuration Register (PDCFG0) Field Descriptions.....	126
8-21.	Power Domain 1 Configuration Register (PDCFG1) Field Descriptions.....	127
8-22.	Module Status <i>n</i> Register (MDSTAT <i>n</i>) Field Descriptions	128
8-23.	PSC0 Module Control <i>n</i> Register (MDCTL <i>n</i>) Field Descriptions	129

8-24.	PSC1 Module Control n Register (MDCTL n) Field Descriptions	130
9-1.	Power Management Features.....	133
10-1.	Master IDs	147
10-2.	Default Master Priority.....	148
10-3.	System Configuration Module 0 (SYSCFG0) Registers	149
10-4.	System Configuration Module 1 (SYSCFG1) Registers	150
10-5.	Revision Identification Register (REVID) Field Descriptions	150
10-6.	Device Identification Register 0 (DEVIDR0) Field Descriptions	151
10-7.	Boot Configuration Register (BOOTCFG) Field Descriptions	151
10-8.	Kick 0 Register (KICK0R) Field Descriptions.....	152
10-9.	Kick 1 Register (KICK1R) Field Descriptions.....	152
10-10.	Host 0 Configuration Register (HOST0CFG) Field Descriptions	153
10-11.	Interrupt Raw Status/Set Register (IRAWSTAT) Field Descriptions	154
10-12.	Interrupt Enable Status/Clear Register (IENSTAT) Field Descriptions	155
10-13.	Interrupt Enable Register (IENSET) Field Descriptions.....	156
10-14.	Interrupt Enable Clear Register (IENCLR) Field Descriptions	156
10-15.	End of Interrupt Register (EOI) Field Descriptions	157
10-16.	Fault Address Register (FLTADDRR) Field Descriptions.....	157
10-17.	Fault Status Register (FLTSTAT) Field Descriptions.....	158
10-18.	Master Priority 0 Register (MSTPRI0) Field Descriptions	159
10-19.	Master Priority 1 Register (MSTPRI1) Field Descriptions	160
10-20.	Master Priority 2 Register (MSTPRI2) Field Descriptions	161
10-21.	Pin Multiplexing Control 0 Register (PINMUX0) Field Descriptions	162
10-22.	Pin Multiplexing Control 1 Register (PINMUX1) Field Descriptions	164
10-23.	Pin Multiplexing Control 2 Register (PINMUX2) Field Descriptions	166
10-24.	Pin Multiplexing Control 3 Register (PINMUX3) Field Descriptions	168
10-25.	Pin Multiplexing Control 4 Register (PINMUX4) Field Descriptions	170
10-26.	Pin Multiplexing Control 5 Register (PINMUX5) Field Descriptions	172
10-27.	Pin Multiplexing Control 6 Register (PINMUX6) Field Descriptions	174
10-28.	Pin Multiplexing Control 7 Register (PINMUX7) Field Descriptions	176
10-29.	Pin Multiplexing Control 8 Register (PINMUX8) Field Descriptions	178
10-30.	Pin Multiplexing Control 9 Register (PINMUX9) Field Descriptions	180
10-31.	Pin Multiplexing Control 10 Register (PINMUX10) Field Descriptions	182
10-32.	Pin Multiplexing Control 11 Register (PINMUX11) Field Descriptions	184
10-33.	Pin Multiplexing Control 12 Register (PINMUX12) Field Descriptions	186
10-34.	Pin Multiplexing Control 13 Register (PINMUX13) Field Descriptions	188
10-35.	Pin Multiplexing Control 14 Register (PINMUX14) Field Descriptions	190
10-36.	Pin Multiplexing Control 15 Register (PINMUX15) Field Descriptions	192
10-37.	Pin Multiplexing Control 16 Register (PINMUX16) Field Descriptions	194
10-38.	Pin Multiplexing Control 17 Register (PINMUX17) Field Descriptions	196
10-39.	Pin Multiplexing Control 18 Register (PINMUX18) Field Descriptions	198
10-40.	Pin Multiplexing Control 19 Register (PINMUX19) Field Descriptions	200
10-41.	Suspend Source Register (SUSPSRC) Field Descriptions.....	202
10-42.	Chip Signal Register (CHIPSIG) Field Descriptions.....	205
10-43.	Chip Signal Clear Register (CHIPSIG_CLR) Field Descriptions.....	206
10-44.	Chip Configuration 0 Register (CFGCHIP0) Field Descriptions	207
10-45.	Chip Configuration 1 Register (CFGCHIP1) Field Descriptions	208
10-46.	Chip Configuration 2 Register (CFGCHIP2) Field Descriptions	210
10-47.	Chip Configuration 3 Register (CFGCHIP3) Field Descriptions	212

10-48. Chip Configuration 4 Register (CFGCHIP4) Field Descriptions	213
10-49. VTP I/O Control Register (VTPIO_CTL) Field Descriptions	214
10-50. DDR Slew Register (DDR_SLEW) Field Descriptions	216
10-51. Deep Sleep Register (DEEPSLEEP) Field Descriptions	217
10-52. Pullup/Pulldown Enable Register (PUPD_ENA) Field Descriptions	218
10-53. Pullup/Pulldown Select Register (PUPD_SEL) Field Descriptions	218
10-54. Pullup/Pulldown Select Register (PUPD_SEL) Default Values	219
10-55. RXACTIVE Control Register (RXACTIVE) Field Descriptions	220
11-1. AINTC System Interrupt Assignments	223
11-2. ARM Interrupt Controller (AINTC) Registers	229
11-3. Revision Identification Register (REVID) Field Descriptions	230
11-4. Control Register (CR) Field Descriptions	231
11-5. Global Enable Register (GER) Field Descriptions	232
11-6. Global Nesting Level Register (GNLR) Field Descriptions	232
11-7. System Interrupt Status Indexed Set Register (SISR) Field Descriptions	233
11-8. System Interrupt Status Indexed Clear Register (SICR) Field Descriptions	233
11-9. System Interrupt Enable Indexed Set Register (EISR) Field Descriptions	234
11-10. System Interrupt Enable Indexed Clear Register (EICR) Field Descriptions.....	234
11-11. Host Interrupt Enable Indexed Set Register (HEISR) Field Descriptions.....	235
11-12. Host Interrupt Enable Indexed Clear Register (HIEICR) Field Descriptions	235
11-13. Vector Base Register (VBR) Field Descriptions	236
11-14. Vector Size Register (VSR) Field Descriptions	236
11-15. Vector Null Register (VNR) Field Descriptions.....	237
11-16. Global Prioritized Index Register (GPIR) Field Descriptions	237
11-17. Global Prioritized Vector Register (GPVR) Field Descriptions.....	238
11-18. System Interrupt Status Raw/Set Register 1 (SRSR1) Field Descriptions	238
11-19. System Interrupt Status Raw/Set Register 2 (SRSR2) Field Descriptions	239
11-20. System Interrupt Status Raw/Set Register 3 (SRSR3) Field Descriptions	239
11-21. System Interrupt Status Raw/Set Register 4 (SRSR4) Field Descriptions	240
11-22. System Interrupt Status Enabled/Clear Register 1 (SECR1) Field Descriptions	240
11-23. System Interrupt Status Enabled/Clear Register 2 (SECR2) Field Descriptions	241
11-24. System Interrupt Status Enabled/Clear Register 3 (SECR3) Field Descriptions	241
11-25. System Interrupt Status Enabled/Clear Register 4 (SECR4) Field Descriptions	242
11-26. System Interrupt Enable Set Register 1 (ESR1) Field Descriptions	242
11-27. System Interrupt Enable Set Register 2 (ESR2) Field Descriptions	243
11-28. System Interrupt Enable Set Register 3 (ESR3) Field Descriptions	243
11-29. System Interrupt Enable Set Register 4 (ESR4) Field Descriptions	244
11-30. System Interrupt Enable Clear Register 1 (ECR1) Field Descriptions	244
11-31. System Interrupt Enable Clear Register 2 (ECR2) Field Descriptions	245
11-32. System Interrupt Enable Clear Register 3 (ECR3) Field Descriptions	245
11-33. System Interrupt Enable Clear Register 4 (ECR4) Field Descriptions	246
11-34. Channel Map Registers (CMR _n) Field Descriptions.....	246
11-35. Host Interrupt Prioritized Index Register 1 (HIPIR1) Field Descriptions	247
11-36. Host Interrupt Prioritized Index Register 2 (HIPIR2) Field Descriptions	247
11-37. Host Interrupt Nesting Level Register 1 (HINLR1) Field Descriptions	248
11-38. Host Interrupt Nesting Level Register 2 (HINLR2) Field Descriptions	248
11-39. Host Interrupt Enable Register (HIER) Field Descriptions.....	249
11-40. Host Interrupt Prioritized Vector Register 1 (HIPVR1) Field Descriptions.....	250
11-41. Host Interrupt Prioritized Vector Register 2 (HIPVR2) Field Descriptions.....	250

A-1. Document Revision History 253

Read This First

About This Manual

Describes the System-on-Chip (SoC) system. This document provides an overview of the system and the following considerations associated with it:

- ARM subsystem
- System interconnect
- System memory
- Memory protection unit (MPU)
- Device clocking
- Phase-locked loop controller (PLL)
- Power and sleep controller (PSC)
- Power management
- System configuration (SYSCFG) module
- ARM interrupt controller (AINTC)
- Boot considerations

Notational Conventions

This document uses the following conventions.

- Hexadecimal numbers are shown with the suffix h. For example, the following number is 40 hexadecimal (decimal 64): 40h.
- Registers in this document are shown in figures and described in tables.
 - Each register figure shows a rectangle divided into fields that represent the fields of the register. Each field is labeled with its bit name, its beginning and ending bit numbers above, and its read/write properties below. A legend explains the notation used for the properties.
 - Reserved bits in a register figure designate a bit that is used for future device expansion.

Related Documentation From Texas Instruments

The following documents describe the AM18x ARM Microprocessors. Copies of these documents are available on the Internet at www.ti.com. *Tip:* Enter the literature number in the search box provided at www.ti.com.

The current documentation that describes the related peripherals, and other technical collateral, is available in the C6000 DSP product folder at: www.ti.com/c6000.

[SPRUFU0](#) — *AM17x/AM18x ARM Microprocessors Peripherals Overview Reference Guide.*

Provides an overview and briefly describes the peripherals available on the AM17x/AM18x ARM Microprocessors.

Overview

Topic	Page
1.1 Introduction	22
1.2 Block Diagram	22
1.3 ARM Subsystem	22

1.1 Introduction

The AM1806 ARM microprocessor contains an ARM RISC CPU for general-purpose processing and systems control. The AM1806 ARM microprocessor consists of the following primary components:

- ARM926 RISC CPU core and associated memories
- A set of I/O peripherals
- A powerful DMA subsystem and SDRAM EMIF interface

1.2 Block Diagram

A block diagram for the AM1806 ARM microprocessor is shown in [Figure 1-1](#).

1.3 ARM Subsystem

The ARM926EJ 32-bit RISC CPU in the ARM subsystem (ARMSS) acts as the overall system controller. The ARM CPU performs general system control tasks, such as system initialization, configuration, power management, user interface, and user command implementation. [Chapter 2](#) describes the ARMSS components and system control functions that the ARM core performs.

Figure 1-1. AM1806 ARM Microprocessor Block Diagram

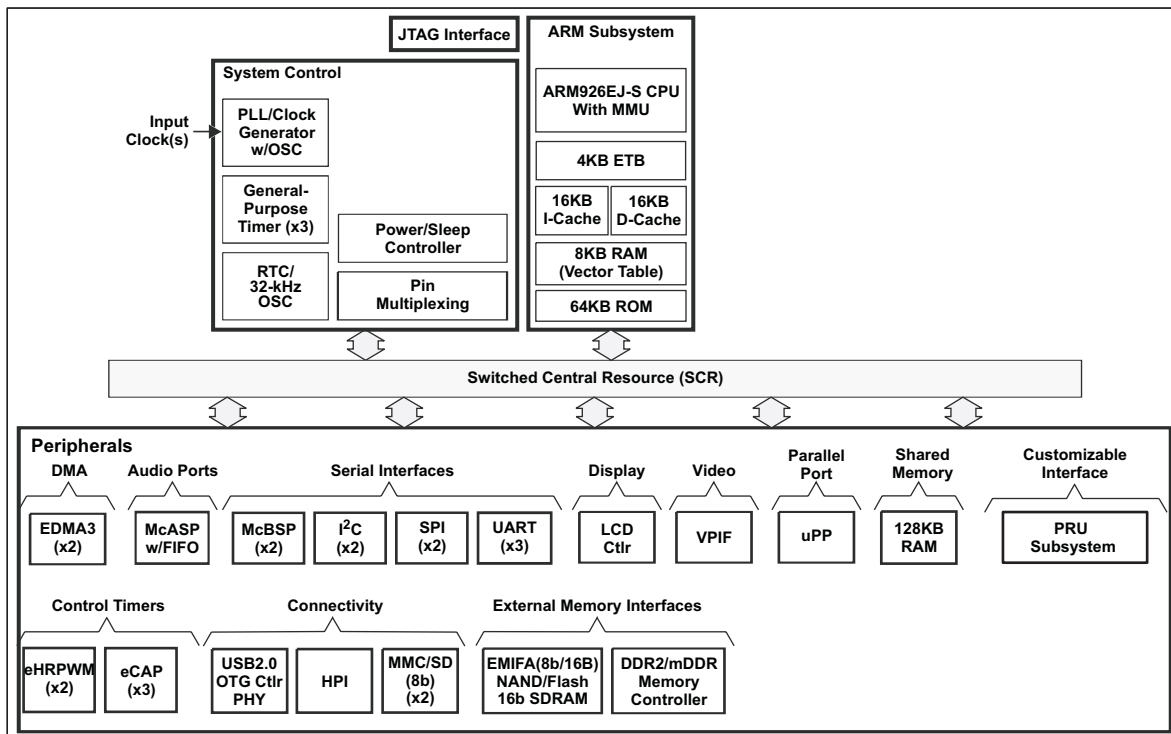

Note: Not all peripherals are available at the same time due to multiplexing.

ARM Subsystem

Topic	Page
2.1 Introduction	24
2.2 Operating States/Modes	25
2.3 Processor Status Registers	25
2.4 Exceptions and Exception Vectors	26
2.5 The 16-BIS/32-BIS Concept	27
2.6 16-BIS/32-BIS Advantages	27
2.7 Co-Processor 15 (CP15)	28

2.1 Introduction

This chapter describes the ARM subsystem and its associated memories. The ARM subsystem consists of the following components:

- ARM926EJ-S - 32-bit RISC processor
- 16-KB Instruction cache
- 16-KB Data cache
- MMU
- CP15 to control MMU, cache, etc.
- Java accelerator
- ARM Internal Memory
 - 8 KB RAM
 - 64 KB built-in ROM
- Embedded Trace Module and Embedded Trace Buffer (ETM/ETB)
- Features:
 - The main write buffer has a 16-word data buffer and a 4-address buffer
 - Support for 32/16-bit instruction sets
 - Fixed little-endian memory format

The ARM926EJ-S processor is a member of the ARM9 family of general-purpose microprocessors. The ARM926EJ-S processor targets multi-tasking applications where full memory management, high performance, low die size, and low power are all important.

The ARM926EJ-S processor supports the 32-bit ARM and the 16-bit THUMB instruction sets, enabling you to trade off between high performance and high code density. This includes features for efficient execution of Java byte codes and providing Java performance similar to Just in Time (JIT) Java interpreter without associated code overhead.

The ARM926EJ-S processor supports the ARM debug architecture and includes logic to assist in both hardware and software debugging. The ARM926EJ-S processor has a Harvard architecture and provides a complete high performance subsystem, including the following:

- An ARM926EJ-S integer core
- A Memory Management Unit (MMU)
- Separate instruction and data AMBA AHB bus interfaces

NOTE: There is no TCM memory and interface on this device.

The ARM926EJ-S processor implements ARM architecture version 5TEJ.

The ARM926EJ-S core includes new signal processing extensions to enhance 16-bit fixed-point performance using a single-cycle 32×16 multiply-accumulate (MAC) unit. The ARM core also has 8 KB RAM (typically used for vector table) and 64 KB ROM (for boot images) associated with it. The RAM/ROM locations are not accessible by any other master peripherals. Furthermore, the ARM has DMA and CFG bus master ports via the AHB interface.

2.2 Operating States/Modes

The ARM can operate in two states: ARM (32-bit) mode and Thumb (16-bit) mode. You can switch the ARM926EJ-S processor between ARM mode and Thumb mode using the BX instruction.

The ARM can operate in the following modes:

- User mode (USR): Non-privileged mode, usually for the execution of most application programs.
- Fast interrupt mode (FIQ): Fast interrupt processing
- Interrupt mode (IRQ): Normal interrupt processing
- Supervisor mode (SVC): Protected mode of execution for operating systems
- Abort mode (ABT): Mode of execution after a data abort or a pre-fetch abort
- System mode (SYS): Privileged mode of execution for operating systems
- Undefined mode (UND): Executing an undefined instruction causes the ARM to enter undefined mode.

You can only enter privileged modes (system or supervisor) from other privileged modes.

To enter supervisor mode from user mode, generate a software interrupt (SWI). An IRQ interrupt causes the processor to enter the IRQ mode. An FIQ interrupt causes the processor to enter the FIQ mode.

Different stacks must be set up for different modes. The stack pointer (SP) automatically changes to the SP of the mode that was entered.

2.3 Processor Status Registers

The processor status register (PSR) controls the enabling and disabling of interrupts and setting the mode of operation of the processor. The 8 least-significant bits PSR[7:0] are the control bits of the processor. PSR[27:8] are reserved bits and PSR[31:28] are status registers. The details of the control bits are:

- Bit 7 - I bit: Disable IRQ (I = 1) or enable IRQ (I = 0)
- Bit 6 - F bit: Disable FIQ (F = 1) or enable FIQ (F = 0)
- Bit 5 - T bit: Controls whether the processor is in thumb mode (T = 1) or ARM mode (T = 0)
- Bits 4:0 Mode: Controls the mode of operation of the processor
 - PSR [4:0] = 10000 : User mode
 - PSR [4:0] = 10001 : FIQ mode
 - PSR [4:0] = 10010 : IRQ mode
 - PSR [4:0] = 10011 : Supervisor mode
 - PSR [4:0] = 10111 : Abort mode
 - PSR [4:0] = 11011 : Undefined mode
 - PSR [4:0] = 11111 : System mode

Status bits show the result of the most recent ALU operation. The details of status bits are:

- Bit 31 - N bit: Negative or less than
- Bit 30 - Z bit: Zero
- Bit 29 - C bit: Carry or borrow
- Bit 28 - V bit: Overflow or underflow

NOTE: See the Programmer's Model of the ARM926EJ-S Technical Reference Manual (TRM), downloadable from <http://infocenter.arm.com/help/index.jsp> for more detailed information.

2.4 Exceptions and Exception Vectors

Exceptions arise when the normal flow of the program must be temporarily halted. The exceptions that occur in an ARM system are given below:

- Reset exception: processor reset
- FIQ interrupt: fast interrupt
- IRQ interrupt: normal interrupt
- Abort exception: abort indicates that the current memory access could not be completed. The abort could be a pre-fetch abort or a data abort.
- SWI interrupt: use software interrupt to enter supervisor mode.
- Undefined exception: occurs when the processor executes an undefined instruction

The exceptions in the order of highest priority to lowest priority are: reset, data abort, FIQ, IRQ, pre-fetch abort, undefined instruction, and SWI. SWI and undefined instruction have the same priority. The ARM is configured with the VINTH signal set high (VINTH = 1), such that the vector table is located at address FFFF 0000h. This address maps to the beginning of the ARM local RAM (8 KB).

NOTE: The VINTH signal is configurable by way of the register setting in CP15. However, it is not recommended to set VINTH = 0, as the device has no physical memory in the 0000 0000h address region.

The default vector table is shown in [Table 2-1](#).

Table 2-1. Exception Vector Table for ARM

Vector Offset Address	Exception	Mode on entry	I Bit State on Entry	F Bit State on Entry
0h	Reset	Supervisor	Set	Set
4h	Undefined instruction	Undefined	Set	Unchanged
8h	Software interrupt	Supervisor	Set	Unchanged
Ch	Pre-fetch abort	Abort	Set	Unchanged
10h	Data abort	Abort	Set	Unchanged
14h	Reserved	—	—	—
18h	IRQ	IRQ	Set	Unchanged
1Ch	FIQ	FIQ	Set	Set

2.5 The 16-BIS/32-BIS Concept

The key idea behind 16-BIS is that of a super-reduced instruction set. Essentially, the ARM926EJ processor has two instruction sets:

- ARM mode or 32-BIS: the standard 32-bit instruction set
- Thumb mode or 16-BIS: a 16-bit instruction set

The 16-bit instruction length (16-BIS) allows the 16-BIS to approach twice the density of standard 32-BIS code while retaining most of the 32-BIS's performance advantage over a traditional 16-bit processor using 16-bit registers. This is possible because 16-BIS code operates on the same 32-bit register set as 32-BIS code. 16-bit code can provide up to 65% of the code size of the 32-bit code and 160% of the performance of an equivalent 32-BIS processor connected to a 16-bit memory system.

2.6 16-BIS/32-BIS Advantages

16-bit instructions operate with the standard 32-bit register configuration, allowing excellent inter-operability between 32-BIS and 16-BIS states. Each 16-bit instruction has a corresponding 32-bit instruction with the same effect on the processor model. The major advantage of a 32-bit architecture over a 16-bit architecture is its ability to manipulate 32-bit integers with single instructions, and to address a large address space efficiently. When processing 32-bit data, a 16-bit architecture takes at least two instructions to perform the same task as a single 32-bit instruction. However, not all of the code in a program processes 32-bit data (for example, code that performs character string handling), and some instructions (like branches) do not process any data at all. If a 16-bit architecture only has 16-bit instructions, and a 32-bit architecture only has 32-bit instructions, then the 16-bit architecture has better code density overall, and has better than one half of the performance of the 32-bit architecture. Clearly, 32-bit performance comes at the cost of code density. The 16-bit instruction breaks this constraint by implementing a 16-bit instruction length on a 32-bit architecture, making the processing of 32-bit data efficient with compact instruction coding. This provides far better performance than a 16-bit architecture, with better code density than a 32-bit architecture. The 16-BIS also has a major advantage over other 32-bit architectures with 16-bit instructions. The advantage is the ability to switch back to full 32-bit code and execute at full speed. Thus, critical loops for applications such as fast interrupts can be coded using the full 32-BIS and linked with 16-BIS code. The overhead of switching from 16-bit code to 32-bit code is folded into sub-routine entry time. Various portions of a system can be optimized for speed or for code density by switching between 16-BIS and 32-BIS execution, as appropriate.

2.7 Co-Processor 15 (CP15)

The system control coprocessor (CP15) is used to configure and control instruction and data caches, Tightly-Coupled Memories (TCMs), Memory Management Units (MMUs), and many system functions. The CP15 registers are only accessible with MRC and MCR instructions by the ARM in a privileged mode like supervisor mode or system mode.

2.7.1 Addresses in an ARM926EJ-S System

Three different types of addresses exist in an ARM926EJ-S system. They are listed in [Table 2-2](#).

Table 2-2. Different Address Types in ARM System

Domain	ARM9EJ-S	Caches and MMU	TCM and AMBA Bus
Address type	Virtual Address (VA)	Modified Virtual Address (MVA)	Physical Address (PA)

An example of the address manipulation that occurs when the ARM9EJ-S core requests an instruction is shown in [Example 2-1](#)

Example 2-1. Address Manipulation

The VA of the instruction is issued by the ARM9EJ-S core.

The VA is translated to the MVA. The Instruction Cache (Icache) and Memory Management Unit (MMU) detect the MVA.

If the protection check carried out by the MMU on the MVA does not abort and the MVA tag is in the Icache, the instruction data is returned to the ARM9EJ-S core.

If the protection check carried out by the MMU on the MVA does not abort, and the MVA tag is not in the cache, then the MMU translates the MVA to produce the PA.

NOTE: See the Programmers Model of the ARM926EJ-S Technical Reference Manual (TRM), downloadable from <http://infocenter.arm.com/help/index.jsp> for more detailed information.

2.7.2 Memory Management Unit

The ARM926EJ-S MMU provides virtual memory features required by operating systems such as SymbianOS, WindowsCE, and Linux. A single set of two level page tables stored in main memory controls the address translation, permission checks, and memory region attributes for both data and instruction accesses. The MMU uses a single unified Translation Lookaside Buffer (TLB) to cache the information held in the page tables.

The MMU features are as follows:

- Standard ARM architecture v4 and v5 MMU mapping sizes, domains, and access protection scheme.
- Mapping sizes are 1 MB (sections), 64 KB (large pages), 4 KB (small pages) and 1 KB (tiny pages)
- Access permissions for large pages and small pages can be specified separately for each quarter of the page (subpage permissions)
- Hardware page table walks
- Invalidate entire TLB, using CP15 register 8
- Invalidate TLB entry, selected by MVA, using CP15 register 8
- Lockdown of TLB entries, using CP15 register 10

NOTE: See the Memory Management Unit of the ARM926EJ-S Technical Reference Manual (TRM), downloadable from <http://infocenter.arm.com/help/index.jsp> for more detailed information.

2.7.3 Caches and Write Buffer

The ARM926EJ-S processor includes:

- An Instruction cache (Icache)
- A Data cache (Dcache)
- A write buffer

The size of the data cache is 16 KB, instruction cache is 16 KB, and write buffer is 17 bytes.

The caches have the following features:

- Virtual index, virtual tag, addressed using the Modified Virtual Address (MVA)
- Four-way set associative, with a cache line length of eight words per line (32 bytes per line), and two dirty bits in the Dcache
- Dcache supports write-through and write-back (or copy back) cache operation, selected by memory region using the C and B bits in the MMU translation tables
- Perform critical-word first cache refilling
- Cache lockdown registers enable control over which cache ways are used for allocation on a line fill, providing a mechanism for both lockdown and controlling cache pollution.
- Dcache stores the Physical Address TAG (PA TAG) corresponding to each Dcache entry in the TAGRAM for use during the cache line write-backs, in addition to the Virtual Address TAG stored in the TAG RAM. This means that the MMU is not involved in Dcache write-back operations, removing the possibility of TLB misses related to the write-back address.
- Cache maintenance operations to provide efficient invalidation of the following:
 - The entire Dcache or Icache
 - Regions of the Dcache or Icache
 - The entire Dcache
 - Regions of virtual memory
- They also provide operations for efficient cleaning and invalidation of the following:
 - The entire Dcache
 - Regions of the Dcache
 - Regions of virtual memory

The write buffer is used for all writes to a non-cachable bufferable region, write-through region, and write misses to a write-back region. A separate buffer is incorporated in the Dcache for holding write-back for cache line evictions or cleaning of dirty cache lines.

The main write buffer has a 16-word data buffer and a four-address buffer.

The Dcache write-back has eight data word entries and a single address entry.

The MCR drain write buffer enables both write buffers to be drained under software control.

The MCR wait for interrupt causes both write buffers to be drained and the ARM926EJ-S processor to be put into a low power state until an interrupt occurs.

NOTE: See the Caches and Write Buffer of the ARM926EJ-S Technical Reference Manual (TRM), downloadable from <http://infocenter.arm.com/help/index.jsp> for more detailed information.

System Interconnect

Topic	Page
3.1 Introduction	32
3.2 System Interconnect Block Diagram	33

3.1 Introduction

The ARM, the PRU, the EDMA3 transfer controllers, and the device peripherals are interconnected through a switch fabric architecture (see [Section 3.2](#)). The switch fabric is composed of multiple switched central resources (SCRs) and multiple bridges. The SCRs establish low-latency connectivity between master peripherals and slave peripherals. Additionally, the SCRs provide priority-based arbitration and facilitate concurrent data movement between master and slave peripherals. Bridges are mainly used to perform bus-width conversion as well as bus operating frequency conversion.

The ARM, the PRU, the EDMA3 transfer controllers, and the various device peripherals can be classified into two categories: master peripherals and slave peripherals. Master peripherals are typically capable of initiating read and write transfers in the system and do not rely on the EDMA3 or on a CPU to perform transfers to and from them. The system master peripherals include the ARM, the EDMA3 transfer controllers, HPI, LCDC, PRUs, USB2.0, uPP, and VPIF. Not all master peripherals may connect to all slave peripherals. The supported connections are designated by an X in [Table 3-1](#).

Table 3-1. AM1806 ARM Microprocessor System Interconnect Matrix

Masters		Slaves							
Master	Default Priority	ARM ROM, AINTC	ARM RAM	EMIFA	DDR2/ mDDR	128K RAM	EDMA3_0_ TC0/TC1	EDMA3_1_ TC0	Peripheral Group ⁽¹⁾
EDMA3_0_CC0	0						X		
EDMA3_1_CC0	0							X	
EDMA3_0_TC0	0			X	X	X	X	X	X
EDMA3_0_TC1	0			X	X	X	X	X	X
PRU0	0		X	X	X	X	X	X	X
PRU1	0			X	X	X	X	X	X
ARM I	2	X	X	X	X	X			
ARM D	2	X	X	X	X	X	X	X	X
EDMA3_1_TC0	4			X	X	X	X	X	X
uPP	4			X	X	X			
USB2.0	4			X	X	X			
VPIF	4			X	X	X			
LCDC	5				X				
HPI	6			X	X	X			X ⁽²⁾

⁽¹⁾ Peripheral group: SYSCFG, eCAP0, eCAP1, eCAP2, eHRPWM0, eHRPWM1, GPIO, I2C0, I2C1, LCDC, McASP0, McBSP0, McBSP1, MDIO, MMC/SD0, MMC/SD1, PLLC0, PLLC1, PRU RAM0, PRU RAM1, PRU Config, PSC0, PSC1, RTC, SPI0, SPI1, TIMER64P0, TIMER64P1, TIMER64P2, TIMER64P3, EDMA3_0_CC0, EDMA3_1_CC0, UART0, UART1, UART2, HPI, USB0 (USB2.0), uPP, VPIF.

⁽²⁾ The HPI does not have access to all registers in the SYSCFG module because it operates with the User Privilege Level.

3.2 System Interconnect Block Diagram

Figure 3-1 shows a system interconnect block diagram.

Figure 3-1. System Interconnect Block Diagram

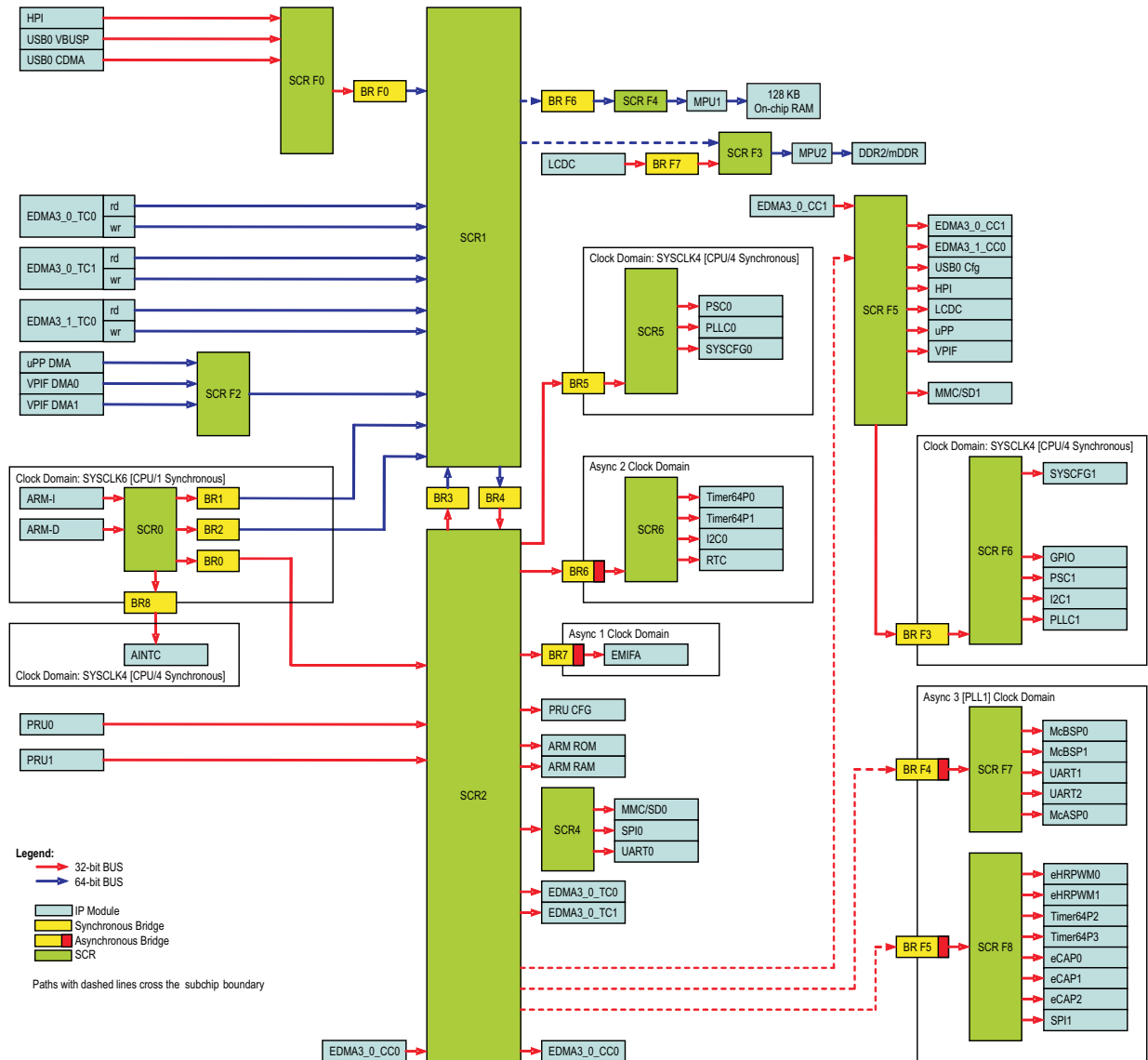

System Memory

Topic	Page
4.1 Introduction	36
4.2 ARM Memories	36
4.3 On-Chip RAM Memory	36
4.4 External Memories	36
4.5 Internal Peripherals	36
4.6 Peripherals	36

4.1 Introduction

This device has multiple on-chip/off-chip memories and several external device interfaces associated with the ARM and various subsystems. To help simplify software development, a unified memory-map is used wherever possible to maintain a consistent view of device resources across all masters (CPU and master peripherals).

For details on the memory addresses, actual memory supported and accessibility by various bus masters, see the detailed memory-map information in the device-specific data manual.

4.2 ARM Memories

The configuration for the ARM internal memory is:

- 8 KB ARM local RAM
- 64 KB ARM local ROM
- 16 KB Instruction Cache and 16 KB Data cache

The ARM RAM/ROM are only accessible by ARM.

4.3 On-Chip RAM Memory

This device also offers an on-chip 128-KB RAM, apart from the ARM internal memories. This on-chip RAM is accessible by the ARM, and also is accessible by several master peripherals.

4.4 External Memories

This device has two external memory interfaces that provide multiple external memory options accessible by the CPU and master peripherals:

- EMIFA:
 - 8/16-bit wide asynchronous EMIF module that supports asynchronous devices such as ASRAM, NAND Flash, and NOR Flash (up to 4 devices)
 - 8/16-bit wide NAND Flash with 4-bit ECC (up to 4 devices)
 - 16-bit SDRAM with 128-MB address space
- DDR2/mDDR memory controller:
 - 16-bit DDR2 with up to 512-MB memory address space
 - 16-bit mDDR with up to 256-MB memory address space

4.5 Internal Peripherals

The peripheral only accessible by the ARM is the ARM interrupt controller (AINTC). For more information on the AINTC, see [Chapter 11](#).

4.6 Peripherals

The ARM has access to all peripherals on the device. This also includes system modules like the PLL controller (PLL), the power and sleep controller (PSC), and the system configuration module (SYSCFG). See the device-specific data manual for the complete list of peripherals supported on your device.

Memory Protection Unit (MPU)

Topic	Page
5.1 Introduction	38
5.2 Architecture	39
5.3 MPU Registers	44

5.1 Introduction

This device supports two memory protection units (MPU1 and MPU2). MPU1 supports the 128KB on-chip RAM and MPU2 supports the DDR2/mDDR SDRAM.

5.1.1 Purpose of the MPU

The memory protection unit (MPU) is provided to manage access to memory. The MPU allows you to define multiple ranges and limit access to system masters based on their privilege ID. The MPU can record a detected fault, or invalid access, and notify the system through an interrupt.

5.1.2 Features

The MPU supports the following features:

- Supports multiple programmable address ranges
- Supports 0 or 1 fixed range
- Supports read, write, and execute access privileges
- Supports privilege ID associations with ranges
- Generates an interrupt when there is a protection violation, and saves violating transfer parameters
- Supports protection of its own registers

5.1.3 Block Diagram

Figure 5-1 shows a block diagram of the MPU. An access to a protected memory must pass through the MPU. During an access, the MPU checks the memory address on the input data bus against fixed and programmable ranges. If allowed, the transfer is passed unmodified to the output data bus. If the transfer fails the protection check then the MPU does not pass the transfer to the output bus but rather services the transfer internally back to the input bus (to prevent a hang) returning the fault status to the requestor as well as generating an interrupt about the fault. The MPU generates two interrupts: an address error interrupt (MPU_ADDR_ERR_INT) and a protection interrupt (MPU_PROT_ERR_INT).

Figure 5-1. MPU Block Diagram

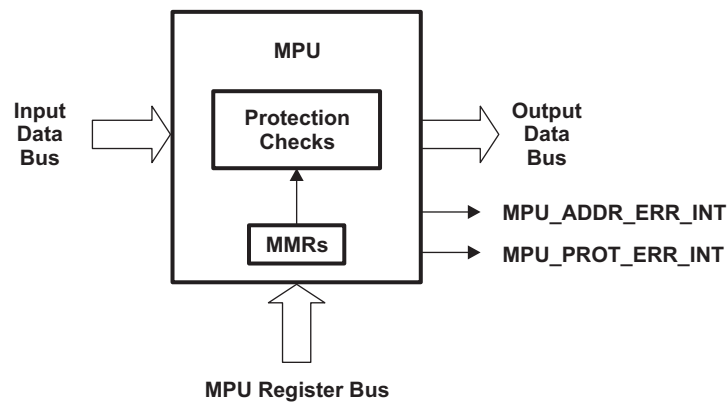

5.1.4 MPU Default Configuration

Two MPUs are supported on the device, one for the 128KB on-chip RAM and one for the DDR2/mDDR SDRAM. Table 5-1 shows the memory regions protected by each MPU. Table 5-2 shows the configuration of each MPU.

Table 5-1. MPU Memory Regions

Unit	Memory Protection	Memory Region	
		Start Address	End Address
MPU1	128KB On-chip RAM	8000 0000h	8001 FFFFh
MPU2	DDR2/mDDR SDRAM	C000 0000h	DFFF FFFFh

Table 5-2. MPU Default Configuration

Setting	MPU1	MPU2
Default permission	Assume allowed	Assume allowed
Number of allowed IDs supported	12	12
Number of fixed ranges supported	1	0
Number of programmable ranges supported	6	12
Compare width	1 KB granularity	64 KB granularity

5.2 Architecture

5.2.1 Privilege Levels

The privilege level of a memory access determines what level of permissions the originator of the memory access might have. Two privilege levels are supported: supervisor and user.

Supervisor level is generally granted access to peripheral registers and the memory protection configuration. User level is generally confined to the memory spaces that the OS specifically designates for its use.

ARM CPU instruction and data accesses have a privilege level associated with them. See the ARM926EJ-S Technical Reference Manual (TRM), downloadable from <http://infocenter.arm.com/help/index.jsp> for more details on privilege levels of the ARM CPU.

Although master peripherals like the HPI do not execute code, they still have a privilege level associated with them. Unlike the ARM CPU, the privilege level of this peripheral is fixed.

Table 5-3 shows the privilege ID of the CPU and every mastering peripheral. Table 5-3 also shows the privilege level (supervisor vs. user) and access type (instruction read vs. data/DMA read or write) of each master on the device. In some cases, a particular setting depends on software being executed at the time of the access or the configuration of the master peripheral.

Table 5-3. Device Master Settings

Master	Privilege ID	Privilege Level	Access Type
EDMA3_0_CC0	Inherited	Inherited	DMA
EDMA3_0_TC0 and EDMA3_0_TC1	Inherited	Inherited	DMA
EDMA3_1_CC0	Inherited	Inherited	DMA
EDMA3_1_TC0	Inherited	Inherited	DMA
ARM (instruction access)	0	Software dependant	Instruction
ARM (data access)	0	Software dependant	Data
PRU0/PRU1	2	Supervisor	DMA
HPI	3	User	DMA
USB2.0	6	Supervisor	DMA
LCD Controller	7	Supervisor	DMA
uPP	8	Supervisor	DMA
VPIF DMA0	10	Supervisor	DMA
VPIF DMA1	11	Supervisor	DMA

5.2.2 Memory Protection Ranges

NOTE: In some cases the amount of physical memory in actual use may be less than the maximum amount of memory supported by the device. For example, the device may support a total of 512 Mbytes of SDRAM memory, but your design may only populate 128 Mbytes. In such cases, the unpopulated memory range must be protected in order to prevent unintended/disallowed aliased access to protected memory. One of the programmable address ranges could be used to detect accesses to this unpopulated memory.

The MPU divides its assigned memory into address ranges. Each MPU can support one fixed address range and multiple programmable address ranges. The fixed address range is configured to an exact address. The programmable address range allows software to program the start and end addresses.

Each address range has the following set of registers:

- Range start and end address registers (MPSAR and MPEAR): Specifies the starting and ending address of the address range.
- Memory protection page attribute register (MPPA): Use to program the permission settings of the address range.

It is allowed to configure ranges such that they overlap each other. In this case, all the overlapped ranges must allow the access, otherwise the access is not allowed. The final permissions given to the access are the lowest of each type of permission from any hit range.

Addresses not covered by a range are either allowed or disallowed based on the configuration of the MPU. The MPU can be configured for assumed allowed or assumed disallowed mode as dictated by the ASSUME_ALLOWED bit in the configuration register (CONFIG).

5.2.3 Permission Structures

The MPU defines a per-range permission structure with three permission fields in a 32-bit permission entry. Figure 5-2 shows the structure of a permission entry.

Figure 5-2. Permission Fields

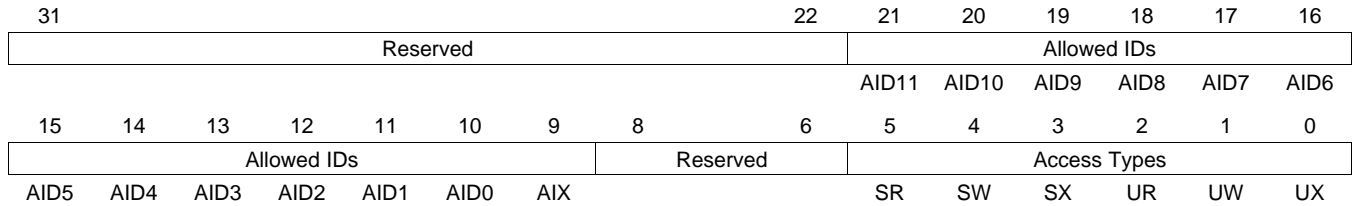

5.2.3.1 Requestor-ID Based Access Controls

Each master on the device has an N-bit code associated with it that identifies it for privilege purposes. This privilege ID accompanies all memory accesses made on behalf of that master. That is, when a master triggers a memory access command, the privilege ID will be carried alongside the command.

Each memory protection range has an allowed ID (AID) field associated with it that indicates which requestors may access the given address range. The MPU maps the privilege IDs of all the possible requestors to bits in the allowed IDs field in the memory protection page attribute registers (MPPA).

- AID0 through AID11 are used to specify the allowed privilege IDs.
- An additional allowed ID bit, AIDX, captures access made by all privilege IDs not covered by AID0 through AID11.

When set to 1, the AID bit grants access to the corresponding ID. When cleared to 0, the AID bit denies access to the corresponding requestor.

5.2.3.2 Request-Type Based Permissions

The memory protection model defines three fundamental functional access types: read, write, and execute. Read and write refer to data accesses -- accesses originating via the load/store units on the CPU or via a master peripheral. Execute refers to accesses associated with an instruction fetch.

The memory protection model allows controlling read, write, and execute permissions independently for both user and supervisor mode. This results in six permission bits, listed in Table 5-4. For each bit, a 1 permits the access type and a 0 denies access. For example, UX = 1 means that User Mode may execute from the given page. The memory protection unit allows you to specify all six of these bits separately; 64 different encodings are permitted altogether, although programs might not use all of them.

Table 5-4. Request Type Access Controls

Bit	Field	Description
5	SR	Supervisor may read
4	SW	Supervisor may write
3	SX	Supervisor may execute
2	UR	User may read
1	UW	User may write
0	UX	User may execute

5.2.4 Protection Check

During a memory access, the MPU checks if the address range of the input transfer overlaps one of the address ranges. When the input transfer address is within a range the transfer parameters are checked against the address range permissions.

The MPU first checks the transfers privilege ID against the AID settings. If the AID bit is 0, then the range will not be checked; if the AID bit is 1, then the transfer parameters are checked against the memory protection page attribute register (MPPA) values to detect an allowed access.

For non-debug accesses, the read, write, and execute permissions are also checked. There is a set of permissions for supervisor mode and a set for user mode. For supervisor mode accesses, the SR, SW, and SX bits are checked. For user mode accesses, the UR, UW, and UX bits are checked.

If the transfer address range does not match any address range then the transfer is either allowed or disallowed based on the configuration of the MPU. The MPU can be configured for assumed allowed or assumed disallowed mode as dictated by the ASSUME_ALLOWED bit in the configuration register (CONFIG).

In the case that a transfer spans multiple address ranges, all the overlapped ranges must allow the access, otherwise the access is not allowed. The final permissions given to the access are the lowest of each type of permission from any hit range. Therefore, if a transfer matches 2 ranges, one that is RW and one that is RX, then the final permission is just R.

5.2.5 MPU Register Protection

Access to the range start and end address registers (MPSAR and MPEAR) and memory protection page attribute registers (MPPA) is also protected. All non-debug writes must be by a supervisor entity. A protection fault can occur from a register write with invalid permissions and this triggers an interrupt just like a memory access.

Faults are not recorded (nor interrupts generated) for debug accesses.

5.2.6 Invalid Accesses and Exceptions

When a transfer fails the protection check, the MPU does not pass the transfer to the output bus. The MPU instead services the transfer locally to prevent a hang and returns a protection error to the requestor. The behavior of the MPU depends on whether the access was a read or a write:

- For a read: The MPU returns 0s, a permission value is 0 (no access allowed), a protection error status.
- For a write: The MPU receives all the write data and returns a protection error status.

The MPU captures system faults due to addressing or protection violations in its registers. The MPU can store the fault information for only one fault, so the first detected fault is recorded into the fault registers and an interrupt is generated. Software must use the fault clear register (FLTCLR) to clear the fault status so that another fault can be recorded. The MPU will not record another fault nor generate another interrupt until the existing fault has been cleared. Also, additional faults will be ignored. Faults are not recorded (no interrupts generated) for debug accesses.

5.2.7 Reset Considerations

After reset, the memory protection page attribute registers (MPPA) default to 0. This disables all protection features.

5.2.8 Interrupt Support

5.2.8.1 Interrupt Events and Requests

The MPU generates two interrupts: an address error interrupt (MPU_ADDR_ERR_INT) and a protection interrupt (MPU_PROT_ERR_INT). The MPU_ADDR_ERR_INT is generated when there is an addressing violation due to an access to a non-existent location in the MPU register space. The MPU_PROT_ERR_INT interrupt is generated when there is a protection violation of either in the defined ranges or to the MPU registers.

The transfer parameters that caused the violation are saved in the MPU registers.

5.2.8.2 Interrupt Multiplexing

The interrupts from both MPUs are combined with the boot configuration module into a single interrupt called MPU_BOOTCFG_ERR. The combined interrupt is routed to the ARM interrupt controller. [Table 5-5](#) shows the interrupt sources that are combined to make MPU_BOOTCFG_ERR.

Table 5-5. MPU_BOOTCFG_ERR Interrupt Sources

Interrupt	Source
MPU1_ADDR_ERR_INT	MPU1 address error interrupt
MPU1_PROT_ERR_INT	MPU1 protection interrupt
MPU2_ADDR_ERR_INT	MPU2 address error interrupt
MPU2_PROT_ERR_INT	MPU2 protection interrupt
BOOTCFG_ADDR_ERR	Boot configuration address error
BOOTCFG_PROT_ERR	Boot configuration protection error

5.2.9 Emulation Considerations

Memory and MPU registers are not protected against emulation accesses.

5.3 MPU Registers

There are two MPUs on the device. Each MPU contains a set of memory-mapped registers.

Table 5-7 lists the memory-mapped registers for the MPU2.

Table 5-6. Memory Protection Unit 1 (MPU1) Registers

Address	Acronym	Register Description	Section
01E1 4000h	REVID	Revision identification register	Section 5.3.1
01E1 4004h	CONFIG	Configuration register	Section 5.3.2
01E1 4010h	IRAWSTAT	Interrupt raw status/set register	Section 5.3.3
01E1 4014h	IENSTAT	Interrupt enable status/clear register	Section 5.3.4
01E1 4018h	IENSET	Interrupt enable set register	Section 5.3.5
01E1 401Ch	IENCLR	Interrupt enable clear register	Section 5.3.6
01E1 4200h	PROG1_MPSAR	Programmable range 1 start address register	Section 5.3.10.1
01E1 4204h	PROG1_MPEAR	Programmable range 1 end address register	Section 5.3.11.1
01E1 4208h	PROG1_MPPA	Programmable range 1 memory protection page attributes register	Section 5.3.12
01E1 4210h	PROG2_MPSAR	Programmable range 2 start address register	Section 5.3.10.1
01E1 4214h	PROG2_MPEAR	Programmable range 2 end address register	Section 5.3.11.1
01E1 4218h	PROG2_MPPA	Programmable range 2 memory protection page attributes register	Section 5.3.12
01E1 4220h	PROG3_MPSAR	Programmable range 3 start address register	Section 5.3.10.1
01E1 4224h	PROG3_MPEAR	Programmable range 3 end address register	Section 5.3.11.1
01E1 4228h	PROG3_MPPA	Programmable range 3 memory protection page attributes register	Section 5.3.12
01E1 4230h	PROG4_MPSAR	Programmable range 4 start address register	Section 5.3.10.1
01E1 4234h	PROG4_MPEAR	Programmable range 4 end address register	Section 5.3.11.1
01E1 4238h	PROG4_MPPA	Programmable range 4 memory protection page attributes register	Section 5.3.12
01E1 4240h	PROG5_MPSAR	Programmable range 5 start address register	Section 5.3.10.1
01E1 4244h	PROG5_MPEAR	Programmable range 5 end address register	Section 5.3.11.1
01E1 4248h	PROG5_MPPA	Programmable range 5 memory protection page attributes register	Section 5.3.12
01E1 4250h	PROG6_MPSAR	Programmable range 6 start address register	Section 5.3.10.1
01E1 4254h	PROG6_MPEAR	Programmable range 6 end address register	Section 5.3.11.1
01E1 4258h	PROG6_MPPA	Programmable range 6 memory protection page attributes register	Section 5.3.12
01E1 4300h	FLTADDRR	Fault address register	Section 5.3.13
01E1 4304h	FLTSTAT	Fault status register	Section 5.3.14
01E1 4308h	FLTCLR	Fault clear register	Section 5.3.15

Table 5-7. Memory Protection Unit 2 (MPU2) Registers

Address	Acronym	Register Description	Section
01E1 5000h	REVID	Revision identification register	Section 5.3.1
01E1 5004h	CONFIG	Configuration register	Section 5.3.2
01E1 5010h	IRAWSTAT	Interrupt raw status/set register	Section 5.3.3
01E1 5014h	IENSTAT	Interrupt enable status/clear register	Section 5.3.4
01E1 5018h	IENSET	Interrupt enable set register	Section 5.3.5
01E1 501Ch	IENCLR	Interrupt enable clear register	Section 5.3.6
01E1 5100h	FXD_MPSAR	Fixed range start address register	Section 5.3.7
01E1 5104h	FXD_MPEAR	Fixed range end address register	Section 5.3.8
01E1 5108h	FXD_MPPA	Fixed range memory protection page attributes register	Section 5.3.9
01E1 5200h	PROG1_MPSAR	Programmable range 1 start address register	
01E1 5204h	PROG1_MPEAR	Programmable range 1 end address register	

Table 5-7. Memory Protection Unit 2 (MPU2) Registers (continued)

Address	Acronym	Register Description	Section
01E1 5208h	PROG1_MPPA	Programmable range 1 memory protection page attributes register	Section 5.3.12
01E1 5210h	PROG2_MPSAR	Programmable range 2 start address register	
01E1 5214h	PROG2_MPEAR	Programmable range 2 end address register	
01E1 5218h	PROG2_MPPA	Programmable range 2 memory protection page attributes register	Section 5.3.12
01E1 5220h	PROG3_MPSAR	Programmable range 3 start address register	
01E1 5224h	PROG3_MPEAR	Programmable range 3 end address register	
01E1 5228h	PROG3_MPPA	Programmable range 3 memory protection page attributes register	Section 5.3.12
01E1 5230h	PROG4_MPSAR	Programmable range 4 start address register	
01E1 5234h	PROG4_MPEAR	Programmable range 4 end address register	
01E1 5238h	PROG4_MPPA	Programmable range 4 memory protection page attributes register	Section 5.3.12
01E1 5240h	PROG5_MPSAR	Programmable range 5 start address register	
01E1 5244h	PROG5_MPEAR	Programmable range 5 end address register	
01E1 5248h	PROG5_MPPA	Programmable range 5 memory protection page attributes register	Section 5.3.12
01E1 5250h	PROG6_MPSAR	Programmable range 6 start address register	
01E1 5254h	PROG6_MPEAR	Programmable range 6 end address register	
01E1 5258h	PROG6_MPPA	Programmable range 6 memory protection page attributes register	Section 5.3.12
01E1 5260h	PROG7_MPSAR	Programmable range 7 start address register	
01E1 5274h	PROG7_MPEAR	Programmable range 7 end address register	
01E1 5268h	PROG7_MPPA	Programmable range 7 memory protection page attributes register	Section 5.3.12
01E1 5270h	PROG8_MPSAR	Programmable range 8 start address register	
01E1 5274h	PROG8_MPEAR	Programmable range 8 end address register	
01E1 5278h	PROG8_MPPA	Programmable range 8 memory protection page attributes register	Section 5.3.12
01E1 5280h	PROG9_MPSAR	Programmable range 9 start address register	
01E1 5284h	PROG9_MPEAR	Programmable range 9 end address register	
01E1 5288h	PROG9_MPPA	Programmable range 9 memory protection page attributes register	Section 5.3.12
01E1 5290h	PROG10_MPSAR	Programmable range 10 start address register	
01E1 5294h	PROG10_MPEAR	Programmable range 10 end address register	
01E1 5298h	PROG10_MPPA	Programmable range 10 memory protection page attributes register	Section 5.3.12
01E1 52A0h	PROG11_MPSAR	Programmable range 11 start address register	
01E1 52A4h	PROG11_MPEAR	Programmable range 11 end address register	
01E1 52A8h	PROG11_MPPA	Programmable range 11 memory protection page attributes register	Section 5.3.12
01E1 52B0h	PROG12_MPSAR	Programmable range 12 start address register	
01E1 52B4h	PROG12_MPEAR	Programmable range 12 end address register	
01E1 52B8h	PROG12_MPPA	Programmable range 12 memory protection page attributes register	Section 5.3.12
01E1 5300h	FLTADDRR	Fault address register	Section 5.3.13
01E1 5304h	FLTSTAT	Fault status register	Section 5.3.14
01E1 5308h	FLTCLR	Fault clear register	Section 5.3.15

5.3.1 Revision Identification Register (REVID)

The revision ID register (REVID) contains the MPU revision. The REVID is shown in [Figure 5-3](#) and described in [Table 5-8](#).

Figure 5-3. Revision ID Register (REVID)

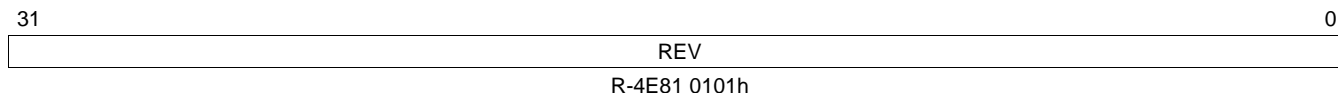

LEGEND: R = Read only; -n = value after reset

Table 5-8. Revision ID Register (REVID) Field Descriptions

Bit	Field	Value	Description
31-0	REV	4E81 0101h	Revision ID of the MPU.

5.3.2 Configuration Register (CONFIG)

The configuration register (CONFIG) contains the configuration value of the MPU. The CONFIG is shown in [Figure 5-4](#) and described in [Table 5-9](#).

NOTE: Although the NUM_AIDS bit defaults to 12 (Ch), not all AIDs may be supported on your device. Unsupported AIDs should be cleared to 0 in the memory page protection attributes registers (MPPA). See for a list of AIDs supported on your device.

Figure 5-4. Configuration Register (CONFIG)

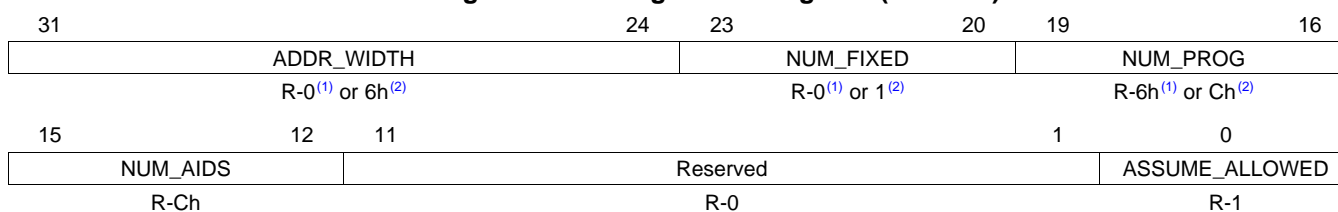

LEGEND: R = Read only; -n = value after reset

⁽¹⁾ For MPU1.

⁽²⁾ For MPU2.

Table 5-9. Configuration Register (CONFIG) Field Descriptions

Bit	Field	Value	Description
31-24	ADDR_WIDTH	0-FFh	Address alignment (2 ⁿ KByte alignment) for range checking.
23-20	NUM_FIXED	0-Fh	Number of fixed address ranges.
19-16	NUM_PROG	0-Fh	Number of programmable address ranges.
15-12	NUM_AIDS	0-Fh	Number of supported AIDs.
11-1	Reserved	0	Reserved
0	ASSUME_ALLOWED	0 1	Assume allowed. When an address is not covered by any MPU protection range, this bit determines whether the transfer is assumed to be allowed or not allowed. Assume is disallowed. Assume is allowed.

5.3.3 Interrupt Raw Status/Set Register (IRAWSTAT)

Reading the interrupt raw status/set register (IRAWSTAT) returns the status of all interrupts. Software can write to IRAWSTAT to manually set an interrupt; however, an interrupt is generated only if the interrupt is enabled in the interrupt enable set register (IENSET). Writes of 0 have no effect. The IRAWSTAT is shown in Figure 5-5 and described in Table 5-10.

Figure 5-5. Interrupt Raw Status/Set Register (IRAWSTAT)

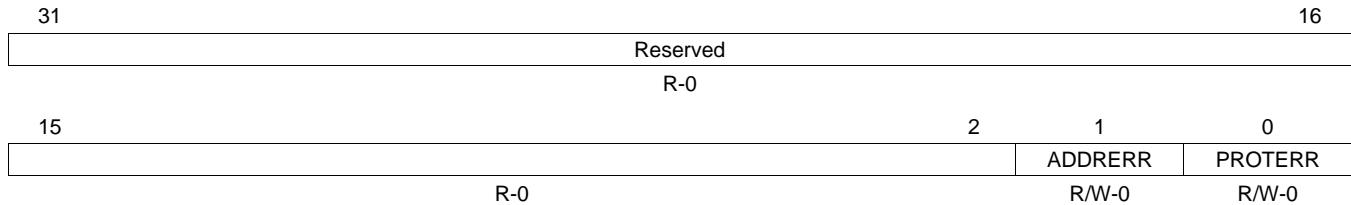

LEGEND: R/W = Read/Write; R = Read only; -n = value after reset

Table 5-10. Interrupt Raw Status/Set Register (IRAWSTAT) Field Descriptions

Bit	Field	Value	Description
31-2	Reserved	0	Reserved
1	ADDRERR	0	Address violation error. Reading this bit reflects the status of the interrupt. Writing 1 sets the status; writing 0 has no effect.
		1	Interrupt is not set.
		1	Interrupt is set.
0	PROTERR	0	Protection violation error. Reading this bit reflects the status of the interrupt. Writing 1 sets the status; writing 0 has no effect.
		1	Interrupt is not set.
		1	Interrupt is set.

5.3.4 Interrupt Enable Status/Clear Register (IENSTAT)

Reading the interrupt enable status/clear register (IENSTAT) returns the status of only those interrupts that are enabled in the interrupt enable set register (IENSET). Software can write to IENSTAT to clear an interrupt; the interrupt is cleared from both IENSTAT and the interrupt raw status/set register (IRAWSTAT). Writes of 0 have no effect. The IENSTAT is shown in Figure 5-6 and described in Table 5-11.

Figure 5-6. Interrupt Enable Status/Clear Register (IENSTAT)

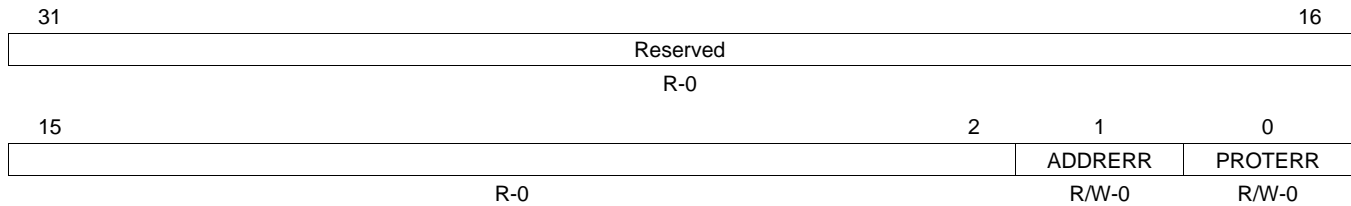

LEGEND: R/W = Read/Write; R = Read only; -n = value after reset

Table 5-11. Interrupt Enable Status/Clear Register (IENSTAT) Field Descriptions

Bit	Field	Value	Description
31-2	Reserved	0	Reserved
1	ADDRERR	0 1	Address violation error. If the interrupt is enabled, reading this bit reflects the status of the interrupt. If the interrupt is disabled, reading this bit returns 0. Writing 1 sets the status; writing 0 has no effect. Interrupt is not set. Interrupt is set.
0	PROTERR	0 1	Protection violation error. If the interrupt is enabled, reading this bit reflects the status of the interrupt. If the interrupt is disabled, reading this bit returns 0. Writing 1 sets the status; writing 0 has no effect. Interrupt is not set. Interrupt is set.

5.3.5 Interrupt Enable Set Register (IENSET)

Reading the interrupt enable set register (IENSET) returns the interrupts that are enabled. Software can write to IENSET to enable an interrupt. Writes of 0 have no effect. The IENSET is shown in Figure 5-7 and described in Table 5-12.

Figure 5-7. Interrupt Enable Set Register (IENSET)

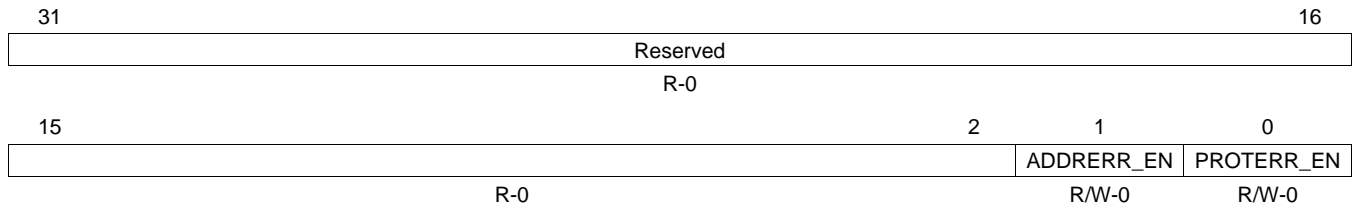

LEGEND: R/W = Read/Write; R = Read only; -n = value after reset

Table 5-12. Interrupt Enable Set Register (IENSET) Field Descriptions

Bit	Field	Value	Description
31-2	Reserved	0	Reserved
1	ADDRERR_EN	0	Address violation error enable. Writing 0 has no effect.
		1	Interrupt is enabled.
0	PROTERR_EN	0	Protection violation error enable. Writing 0 has no effect.
		1	Interrupt is enabled.

5.3.6 Interrupt Enable Clear Register (IENCLR)

Reading the interrupt enable clear register (IENCLR) returns the interrupts that are enabled. Software can write to IENCLR to clear/disable an interrupt. Writes of 0 have no effect. The IENCLR is shown in Figure 5-8 and described in Table 5-13.

Figure 5-8. Interrupt Enable Clear Register (IENCLR)

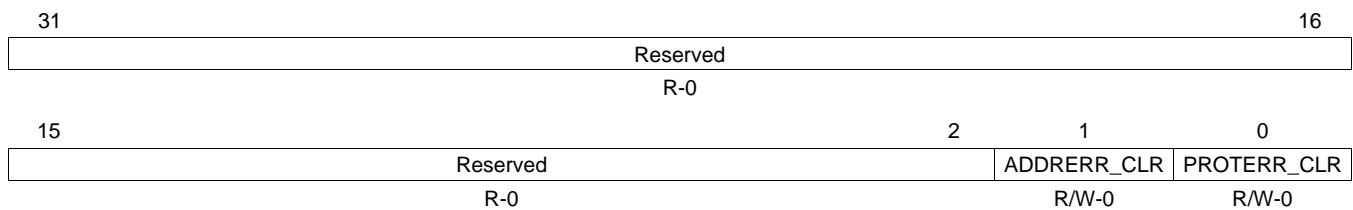

LEGEND: R/W = Read/Write; R = Read only; -n = value after reset

Table 5-13. Interrupt Enable Clear Register (IENCLR) Field Descriptions

Bit	Field	Value	Description
31-2	Reserved	0	Reserved
1	ADDRERR_CLR	0	Address violation error disable. Writing 0 has no effect.
		1	Interrupt is cleared/disabled.
0	PROTERR_CLR	0	Protection violation error disable. Writing 0 has no effect.
		1	Interrupt is cleared/disabled.

5.3.7 Fixed Range Start Address Register (FXD_MPSAR)

The fixed range start address register (FXD_MPSAR) holds the start address for the fixed range. The fixed address range manages access to the DDR2/mDDR SDRAM control registers (B000 0000h–B000 7FFFh). However, these addresses are *not* indicated in FXD_MPSAR and the fixed range end address register (FXD_MPEAR), which instead read as 0. The FXD_MPSAR is shown in [Figure 5-9](#).

Figure 5-9. Fixed Range Start Address Register (FXD_MPSAR)

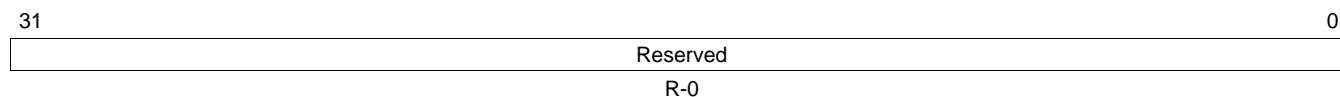

LEGEND: R = Read only; -n = value after reset

5.3.8 Fixed Range End Address Register (FXD_MPEAR)

The fixed range end address register (FXD_MPEAR) holds the end address for the fixed range. The fixed address range manages access to the DDR2/mDDR SDRAM control registers (B000 0000h–B000 7FFFh). However, these addresses are *not* indicated in FXD_MPEAR and the fixed range start address register (FXD_MPSAR), which instead read as 0. The FXD_MPEAR is shown in [Figure 5-10](#).

Figure 5-10. Fixed Range End Address Register (FXD_MPEAR)

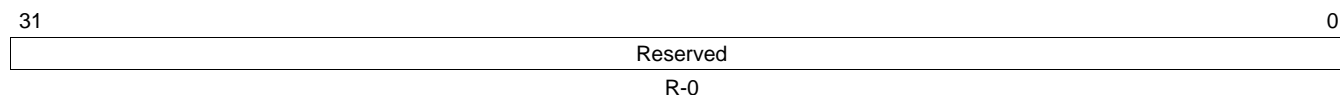

LEGEND: R = Read only; -n = value after reset

5.3.9 Fixed Range Memory Protection Page Attributes Register (FXD_MPPA)

The fixed range memory protection page attributes register (FXD_MPPA) holds the permissions for the fixed region. This register is writeable by a supervisor entity only. The FXD_MPPA is shown in [Figure 5-11](#) and described in [Table 5-14](#).

Figure 5-11. Fixed Range Memory Protection Page Attributes Register (FXD_MPPA)

31	Reserved						26	Reserved			25	R/W-1			22	R/W-1			21	R/W-1			20	R/W-1			19	R/W-1			18	R/W-1			17	R/W-1			16	R/W-1		
R-0						R-Fh			R/W-1			R/W-1			R/W-1			R/W-1			R/W-1			R/W-1			R/W-1			R/W-1			R/W-1									
15	AID5	AID4	AID3	AID2	AID1	AID0	AIDX	Rsvd	Rsvd	Rsvd	SR	SW	SX	UR	UW	UX	0	15	AID5	AID4	AID3	AID2	AID1	AID0	AIDX	Rsvd	Rsvd	Rsvd	SR	SW	SX	UR	UW	UX								
R/W-1						R/W-1			R/W-1			R/W-1			R/W-1			R/W-1			R/W-1			R/W-1			R/W-1			R/W-1												

LEGEND: R/W = Read/Write; R = Read only; -n = value after reset

Table 5-14. Fixed Range Memory Protection Page Attributes Register (FXD_MPPA) Field Descriptions

Bit	Field	Value	Description
31-26	Reserved	0	Reserved
25-22	Reserved	Fh	Reserved
21-10	AID _n	0 1	Controls access from ID = n. Access is denied. Access is granted.
9	AIDX	0 1	Controls access from ID > 11. Access is denied. Access is granted.
8	Reserved	0	Reserved
7	Reserved	1	Reserved. This bit must be written as 1.
6	Reserved	1	Reserved. This bit must be written as 1.
5	SR	0 1	Supervisor Read permission. Access is denied. Access is allowed.
4	SW	0 1	Supervisor Write permission. Access is denied. Access is allowed.
3	SX	0 1	Supervisor Execute permission. Access is denied. Access is allowed.
2	UR	0 1	User Read permission. Access is denied. Access is allowed.
1	UW	0 1	User Write permission. Access is denied. Access is allowed.
0	UX	0 1	User Execute permission. Access is denied. Access is allowed.

5.3.10 Programmable Range n Start Address Registers (PROG $_n$ _MPSAR)

NOTE: In some cases the amount of physical memory in actual use may be less than the maximum amount of memory supported by the device. For example, the device may support a total of 512 Mbytes of SDRAM memory, but your design may only populate 128 Mbytes. In such cases, the unpopulated memory range must be protected in order to prevent unintended/disallowed aliased access to protected memory, especially memory. One of the programmable address ranges could be used to detect accesses to this unpopulated memory.

The programmable range n start address register (PROG $_n$ _MPSAR) holds the start address for the range n . The PROG $_n$ _MPSAR is writeable by a supervisor entity only.

The start address must be aligned on a page boundary. The size of the page depends on the MPU: the page size for MPU1 is 1 KByte; the page size for MPU2 is 64 KBytes. The size of the page determines the width of the address field in PROG $_n$ _MPSAR and the programmable range n end address register (PROG $_n$ _MPEAR). For example, to protect a 64-KB page starting at byte address 8001 0000h, write 8001 0000h to PROG $_n$ _MPSAR and 8001 FFFFh to PROG $_n$ _MPEAR.

5.3.10.1 MPU1 Programmable Range n Start Address Register (PROG1_MPSAR-PROG6_MPSAR)

The PROG $_n$ _MPSAR for MPU1 is shown in [Figure 5-12](#) and described in [Table 5-15](#).

Figure 5-12. MPU1 Programmable Range n Start Address Register (PROG $_n$ _MPSAR)

31	10 9	0
START_ADDR	Reserved	
R/W-20 0000h	R-0	

LEGEND: R/W = Read/Write; R = Read only; - n = value after reset

Table 5-15. MPU1 Programmable Range n Start Address Register (PROG $_n$ _MPSAR) Field Descriptions

Bit	Field	Value	Description
31-10	START_ADDR	20 0000h– 20 007Fh	Start address for range N .
9-0	Reserved	0	Reserved

5.3.10.2 MPU2 Programmable Range n Start Address Register (PROG1_MPSAR-PROG12_MPSAR)

The PROG $_n$ _MPSAR for MPU2 is shown in [Figure 5-13](#) and described in [Table 5-16](#).

Figure 5-13. MPU2 Programmable Range n Start Address Register (PROG $_n$ _MPSAR)

31	16 15	0
START_ADDR	Reserved	
R/W-C000h	R-0	

LEGEND: R/W = Read/Write; R = Read only; - n = value after reset

Table 5-16. MPU2 Programmable Range n Start Address Register (PROG $_n$ _MPSAR) Field Descriptions

Bit	Field	Value	Description
31-16	START_ADDR	C000h–DFFFh	Start address for range N.
15-0	Reserved	0	Reserved

5.3.11 Programmable Range n End Address Registers (PROG $_n$ _MPEAR)

The programmable range n end address register (PROG $_n$ _MPEAR) holds the end address for the range n . This register is writeable by a supervisor entity only.

The end address must be aligned on a page boundary. The size of the page depends on the MPU: the page size for MPU1 is 1 KByte; the page size for MPU2 is 64 KBytes. The size of the page determines the width of the address field in the programmable range n start address register (PROG $_n$ _MPSAR) and PROG $_n$ _MPEAR. For example, to protect a 64-KB page starting at byte address 8001 0000h, write 8001 0000h to PROG $_n$ _MPSAR and 8001 FFFFh to PROG $_n$ _MPEAR.

5.3.11.1 MPU1 Programmable Range n End Address Register (PROG1_MPEAR-PROG6_MPEAR)

The PROG $_n$ _MPEAR for MPU1 is shown in [Figure 5-14](#) and described in [Table 5-17](#).

Figure 5-14. MPU1 Programmable Range n End Address Register (PROG $_n$ _MPEAR)

31	END_ADDR	10 9	0
	R/W-20 007Fh		Reserved R-3FFh

LEGEND: R/W = Read/Write; R = Read only; - n = value after reset

Table 5-17. MPU1 Programmable Range n End Address Register (PROG $_n$ _MPEAR) Field Descriptions

Bit	Field	Value	Description
31-10	END_ADDR	20 0000h– 20 007Fh	End address for range N.
9-0	Reserved	3FFh	Reserved

5.3.11.2 MPU2 Programmable Range n End Address Register (PROG1_MPEAR-PROG12_MPEAR)

The PROG $_n$ _MPEAR for MPU2 is shown in [Figure 5-15](#) and described in [Table 5-18](#).

Figure 5-15. MPU2 Programmable Range n End Address Register (PROG $_n$ _MPEAR)

31	END_ADDR	16 15	0
	R/W-DFFFh		Reserved R-FFFFh

LEGEND: R/W = Read/Write; R = Read only; - n = value after reset

Table 5-18. MPU2 Programmable Range n End Address Register (PROG $_n$ _MPEAR) Field Descriptions

Bit	Field	Value	Description
31-16	END_ADDR	C000h–DFFFh	Start address for range N.
15-0	Reserved	FFFFh	Reserved

5.3.12 Programmable Range n Memory Protection Page Attributes Register (PROG $_n$ MPPA)

The programmable range n memory protection page attributes register (PROG $_n$ MPPA) holds the permissions for the region n . This register is writeable only by a supervisor entity. The PROG $_n$ MPPA is shown in Figure 5-16 and described in Table 5-19.

Figure 5-16. Programmable Range Memory Protection Page Attributes Register (PROG $_n$ MPPA)

31						26		25		22		21	20	19	18	17	16														
Reserved						Reserved		AID11	AID10	AID9	AID8	AID7	AID6																		
R-0						R-Fh		R/W-1	R/W-1	R/W-1	R/W-1	R/W-1	R/W-1																		
15		14		13		12		11		10		9		8		7		6		5		4		3		2		1		0	
AID5	AID4	AID3	AID2	AID1	AID0	AIDX	Rsvd	Rsvd	Rsvd	SR	SW	SX	UR	UW	UX																
R/W-1	R/W-1	R/W-1	R/W-1	R/W-1	R/W-1	R/W-1	R-0	R/W-1	R/W-1	R/W-1	R/W-1	R/W-1	R/W-1	R/W-1	R/W-1	R/W-1	R/W-1	R/W-1	R/W-1	R/W-1	R/W-1	R/W-1	R/W-1	R/W-1	R/W-1	R/W-1	R/W-1	R/W-1			

LEGEND: R/W = Read/Write; R = Read only; - n = value after reset

Table 5-19. Programmable Range Memory Protection Page Attributes Register (PROG $_n$ MPPA) Field Descriptions

Bit	Field	Value	Description
31-26	Reserved	0	Reserved
25-22	Reserved	Fh	Reserved
21-10	AID n	0 1	Controls access from ID = n . Access is denied. Access is granted.
9	AIDX	0 1	Controls access from ID > 11. Access is denied. Access is granted.
8	Reserved	0	Reserved
7	Reserved	1	Reserved. This bit must be written as 1.
6	Reserved	1	Reserved. This bit must be written as 1.
5	SR	0 1	Supervisor Read permission. Access is denied. Access is allowed.
4	SW	0 1	Supervisor Write permission. Access is denied. Access is allowed.
3	SX	0 1	Supervisor Execute permission. Access is denied. Access is allowed.
2	UR	0 1	User Read permission. Access is denied. Access is allowed.
1	UW	0 1	User Write permission. Access is denied. Access is allowed.
0	UX	0 1	User Execute permission. Access is denied. Access is allowed.

5.3.13 Fault Address Register (FLTADDR)

The fault address register (FLTADDR) holds the address of the first protection fault transfer. The FLTADDR is shown in [Figure 5-17](#) and described in [Table 5-20](#).

Figure 5-17. Fault Address Register (FLTADDR)

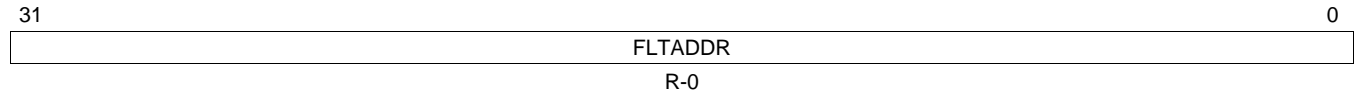

LEGEND: R = Read only; -n = value after reset

Table 5-20. Fault Address Register (FLTADDR) Field Descriptions

Bit	Field	Value	Description
31-0	FLTADDR	0-FFFF FFFFh	Memory address of fault.

5.3.14 Fault Status Register (FLTSTAT)

The fault status register (FLTSTAT) holds the status and attributes of the first protection fault transfer. The FLTSTAT is shown in [Figure 5-18](#) and described in [Table 5-21](#).

Figure 5-18. Fault Status Register (FLTSTAT)

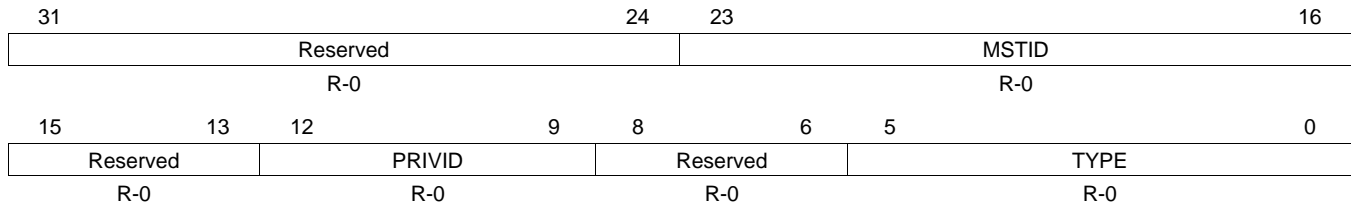

LEGEND: R = Read only; -n = value after reset

Table 5-21. Fault Status Register (FLTSTAT) Field Descriptions

Bit	Field	Value	Description
31-24	Reserved	0	Reserved
23-16	MSTID	0-FFh	Master ID of fault transfer.
15-13	Reserved	0	Reserved
12-9	PRIVID	0-Fh	Privilege ID of fault transfer.
8-6	Reserved	0	Reserved
5-0	TYPE	0-3Fh	Fault type. The TYPE bit field is cleared when a 1 is written to the CLEAR bit in the fault clear register (FLTCLR).
		0	No fault.
		1h	User execute fault.
		2h	User write fault.
		3h	Reserved
		4h	User read fault.
		5h-7h	Reserved
		8h	Supervisor execute fault.
		9h-Fh	Reserved
		10h	Supervisor write fault.
		11h	Reserved
		12h	Relaxed cache write back fault.
		13h-1Fh	Reserved
		20h	Supervisor read fault.
		21h-3Eh	Reserved
		3Fh	Relaxed cache line fill fault.

5.3.15 Fault Clear Register (FLTCLR)

The fault clear register (FLTCLR) allows software to clear the current fault so that another can be captured in the fault status register (FLTSTAT) as well as produce an interrupt. Only the TYPE bit field in FLTSTAT is cleared when a 1 is written to the CLEAR bit. The FLTCLR is shown in [Figure 5-19](#) and described in [Table 5-22](#).

Figure 5-19. Fault Clear Register (FLTCLR)

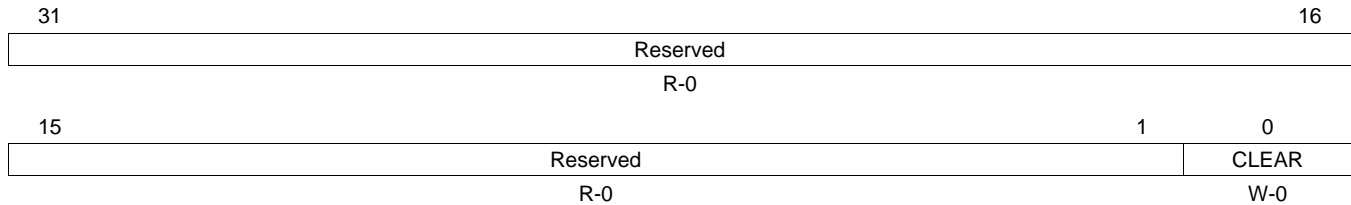

LEGEND: R = Read only; W = Write only; -n = value after reset

Table 5-22. Fault Clear Register (FLTCLR) Field Descriptions

Bit	Field	Value	Description
31-1	Reserved	0	Reserved
0	CLEAR	0	Command to clear the current fault. Writing 0 has no effect.
		0	No effect.
		1	Clear the current fault.

Device Clocking

Topic	Page
6.1 Overview	60
6.2 Frequency Flexibility	62
6.3 Peripheral Clocking	63

6.1 Overview

This device requires two primary reference clocks:

- One reference clock is required for the phase-locked loop controllers (PLLs)
- One reference clock is required for the real-time clock (RTC) module.

These reference clocks may be sourced from either a crystal input or by an external oscillator. For detailed specifications on clock frequency and voltage requirements, see the device-specific data manual.

In addition to the reference clocks required for the PLLs and RTC module, some peripherals, such as the USB, may also require an input reference clock to be supplied. All possible input clocks are described in [Table 6-1](#). The CPU and the majority of the device peripherals operate at fixed ratios of the primary system/ARM clock frequency, as listed in [Table 6-2](#). However, there are two system clock domains that do not require a fixed ratio to the ARM, these are PLL0_SYSClk3 and PLL0_SYSClk7. [Figure 6-1](#) shows the clocking architecture.

Table 6-1. Device Clock Inputs

Peripheral	Input Clock Signal Name
Oscillator/PLL	OSCIN
RTC	RTC_XI
JTAG	TCK, RTCK
USB2.0	USB_REFCLKIN
I2Cs	I2Cn_SCL
Timers	TM64Pn_IN12
SPIs	SPIIn_CLK
uPP	UPP_CHn_CLK
VPIF	VPIF_CLKINn
McBSPs	CLKSn, CLKRn, CLKXn
McASP0	ACLKR, AHCLKR, ACLKX, AHCLKX

Table 6-2. System Clock Domains

CPU/Device Peripherals	System Clock Domain	Fixed Ratio to ARM Clock Required?	Default Ratio to ARM Clock
ARM RAM/ROM, On-chip RAM, UART0, EDMA, SPI0, MMC/SDs, VPIF, LCD, uPP, DDR2/mDDR (bus ports), USB2.0, HPI, PRU	PLL0_SYSClk2	Yes	1:2
EMIFA	PLL0_SYSClk3	No	1:3
System configuration (SYSCFG), GPIO, PLLs, PSCs, I2C1, ARM INT	PLL0_SYSClk4	Yes	1:4
ARM	PLL0_SYSClk6	Yes	1:1
I2C0, Timer64P0/P1, RTC, McASP0 serial clock	PLL0_AUXCLK	Not Applicable	Not Applicable
DDR2/mDDR PHY	PLL1_SYSClk1	Not Applicable	Not Applicable
PLL0 input reference clock (not configured by default)	PLL1_SYSClk3	Not Applicable	Not Applicable
ECAPs, UART1/2, Timer64P2/3, eHRPWMs, McBSPs, McASP0, SPI1	ASYNC3	Not Applicable	Not Applicable

Figure 6-1. Overall Clocking Diagram

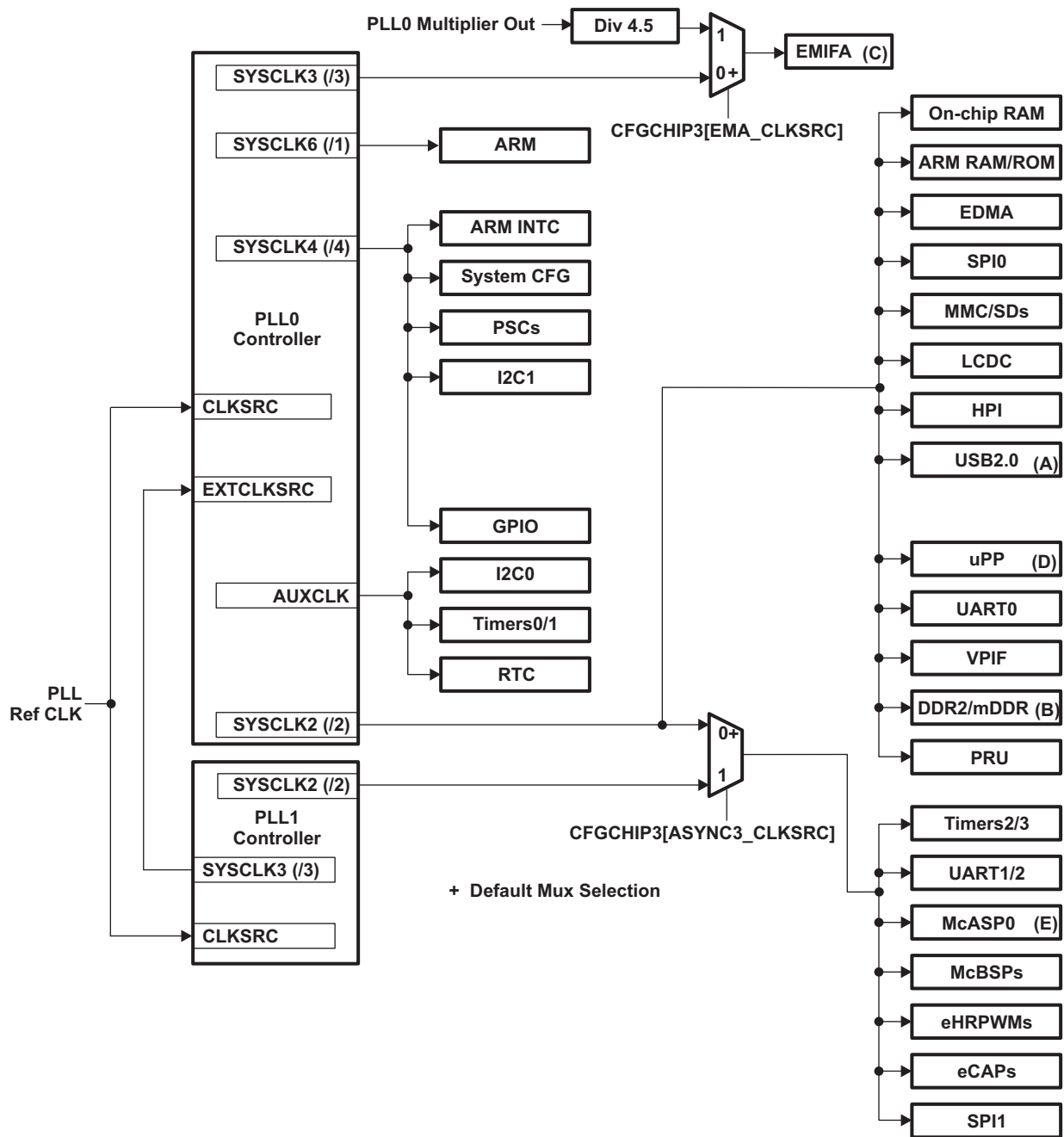

- A See Section 6.3.1 for USB clocking.
- B See Section 6.3.2 for DDR2/mDDR clocking.
- C See Section 6.3.3 for EMIFA clocking.
- D See Section 6.3.4 for uPP clocking.
- E See Section 6.3.5 for McASP clocking.

6.2 Frequency Flexibility

There are two PLLs on the device with similar architecture and behavior. Each PLL has two clocking modes:

- PLL Bypass that can serve as a power savings mode
- PLL Active where the PLL is enabled and multiplies the input clock up to the desired operating frequency

When the PLL is in Bypass mode, the reference clock supplied on OSCIN serves as the clock source from which all of the system clocks (SYSCLK1 to SYSCLK7) are derived. This means that when the PLL is in Bypass mode, the reference clock supplied on OSCIN passes directly to the system of PLLDIV blocks that creates each of the system clocks. For PLL0 only, the EXTCLKSRC bit in PLLCTL can be configured to use PLL1_SYSClk3 as the Bypass mode reference clock.

When the PLL operates in Active mode, the PLL is enabled and the PLL multiplier setting is used to multiply the input clock frequency supplied on the OSCIN pin up to the desired frequency. It is this multiplied frequency that all system clocks are derived from in PLL Active mode.

The output of the PLL multiplier passes through a post divider (POSTDIV) block and then is applied to the system of PLLDIV blocks that creates each of the system clock domains (SYSCLK1 to SYSCLK7). Each SYSCLK n has a PLLDIV n block associated with it. See [Chapter 7](#) for more details on the PLL.

The combination of the PLL multiplier, POSTDIV, and PLLDIV blocks provides flexibility in the frequencies that the system clock domains support. This flexibility does have limitations, as follows:

- OSCIN input frequency is limited to a supported range.
- The output of the PLL Multiplier must be within the range specified in the device-specific data manual.
- The output of each PLLDIV block must be less than or equal to the maximum device frequency specified in the device-specific data manual.

NOTE: The above limitations are provided here as an example and are used to illustrate the recommended configuration of the PLL controller. These limitations may vary based on core voltage and between devices. See the device-specific data manual for more details.

[Table 6-3](#) shows examples of possible PLL multiplier settings, along with the available PLL post-divider modes. The PLL post-divider modes are defined by the value programmed in the RATIO field of the PLL post-divider control register (POSTDIV). For Div1, Div2, Div3, and Div4 modes, the RATIO field would be programmed to 0, 1, 2, and 3, respectively. The Div1, Div2, Div3, and Div4 modes are shown here as an example. Additional post-divider modes are supported and are documented in [Chapter 7](#).

As shown in [Table 6-3](#), the Div1 mode is not supported. The RATIO field in POSTDIV must always be programmed to a value greater than or equal to 1.

NOTE: PLL power consumption increases as the output frequency of the PLL multiplier increases. To decrease PLL power consumption, the lowest PLL multiplier (PLLM) setting should be chosen that achieves the desired frequency. For example, if 200 MHz is the desired CPU operating frequency and the OSCIN frequency is 25 MHz; lower power consumption is achieved by choosing a PLLM setting of $\times 16$ and a post-divider (POSTDIV) setting of $/2$ instead of a PLLM setting of $\times 24$ and a POSTDIV setting of $/3$, even though both of these modes would result in a CPU frequency of 200 MHz.

Table 6-3. Example PLL Frequencies

OSCIN Frequency	PLL Multiplier	Multiplier Frequency	Div1	Div2	Div3	Div4
20	30	600 MHz	Not Supported	300	200	150
24	25	600 MHz	Not Supported	300	200	150
25	24	600 MHz	Not Supported	300	200	150
30	20	600 MHz	Not Supported	300	200	150
20	25	500 MHz	Not Supported	250	167	125
24	20	480 MHz	Not Supported	240	160	120
25	18	450 MHz	Not Supported	225	150	112.5
30	14	420 MHz	Not Supported	210	140	105
25	16	400 MHz	Not Supported	200	133	100

6.3 Peripheral Clocking

6.3.1 USB Clocking

Figure 6-2 shows the clock connections for the USB2.0 module. Note that there is no built-in oscillator. The USB2.0 subsystem requires a reference clock for its internal PLL. This reference clock can be sourced from either the USB_REFCLKIN pin or from the AUXCLK of the system PLL. The reference clock input to the USB2.0 subsystem is selected by programming the USB0PHYCLKMUX bit in the chip configuration 2 register (CFGCHIP2) of the System Configuration Module. The USB_REFCLKIN source should be selected when it is not possible (such as when specific audio rates are required) to operate the device at one of the allowed input frequencies to the USB2.0 subsystem. The USB2.0 subsystem peripheral bus clock is sourced from PLL0_SYSCLK2. Table 6-4 determines the source origination as well as the source input frequency to the USB 2.0 PHY. Once the clock source origination (internal/external) and its frequency is determined, the firmware should program the PHY PLL with the correct input frequency via CFGCHIP2.USB0REF_FREQ.

Figure 6-2. USB Clocking Diagram

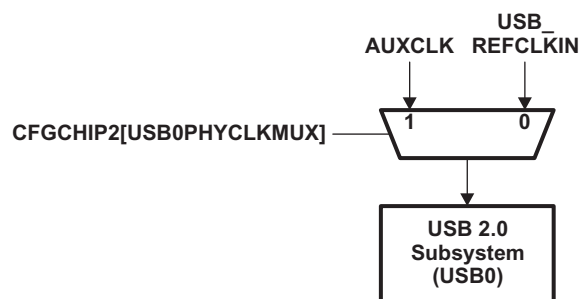

Table 6-4. USB Clock Multiplexing Options

CFGCHIP2. USB0PHYCLKMUX bit	USB2.0 Clock Source	Additional Conditions
0	USB_REFCLKIN	USB_REFCLKIN must be 12, 24, 48, 19.2, 38.4, 13, 26, 20, or 40 MHz. The PLL inside the USB2.0 PHY can be configured to accept any of these input clock frequencies.
1	PLL0_AUXCLK	PLL0_AUXCLK must be 12, 24, 48, 19.2, 38.4, 13, 26, 20, or 40 MHz. The PLL inside the USB2.0 PHY can be configured to accept any of these input clock frequencies.

6.3.2 DDR2/mDDR Memory Controller Clocking

The DDR2/mDDR memory controller requires two input clocks to source VCLK and 2X_CLK (see [Figure 6-3](#)):

- VCLK is sourced from PLL0_SYSCLK2/2 that clocks the command FIFO, write FIFO, and read FIFO of the DDR2/mDDR memory controller. From this, VCLK drives the interface to the peripheral bus.
- 2X_CLK is sourced from PLL1_SYSCLK1.

2X_CLK clock is again divided down by 2 in the DDR PHY controller to generate a clock called MCLK. The MCLK domain consists of the DDR2/mDDR memory controller state machine and memory-mapped registers. This clock domain is clocked at the rate of the external DDR2/mDDR memory, 2X_CLK/2.

[Table 6-5](#) shows example PLL register settings based on the OSCIN reference clock frequency of 25 MHz. From these example configurations, the following observations are made:

- To achieve the maximum frequency (150 MHz) supported by the DDR2/mDDR memory controller and the typical CPU frequency of 300 MHz, the output of the PLL multiplier should be set to be 300 MHz and the DDR_CLK source should be set to PLL1_SYSCLK1.
- The frequency of the PLL1 direct output clock is fixed at the output frequency of the PLL1 multiplier block.
- The PLLDIV1 block that sets the divider ratio for SYSCLK1 can be changed to achieve various clock frequencies.
- For certain PLL1 multiplier and PLL1 post-divider control register (POSTDIV) settings, a higher clock frequency can be achieved by selecting SYSCLK1 as the clock source for 2X_CLK.

If the DDR2/mDDR memory controller is not in use and the DDR_CLK and $\overline{\text{DDR_CLK}}$ are used in the application as a free running clock that could be used by an FPGA or for some other purpose, then 2X_CLK should be used as the source for DDR_CLK and $\overline{\text{DDR_CLK}}$ and VCLK should be gated off. This allows clock gating of the majority of the logic in the DDR2/mDDR memory controller via the LPSC while still providing a clock on the DDR_CLK and $\overline{\text{DDR_CLK}}$.

NOTE: DDR_CLK and $\overline{\text{DDR_CLK}}$ are output clock signals.

Figure 6-3. DDR2/mDDR Memory Controller Clocking Diagram

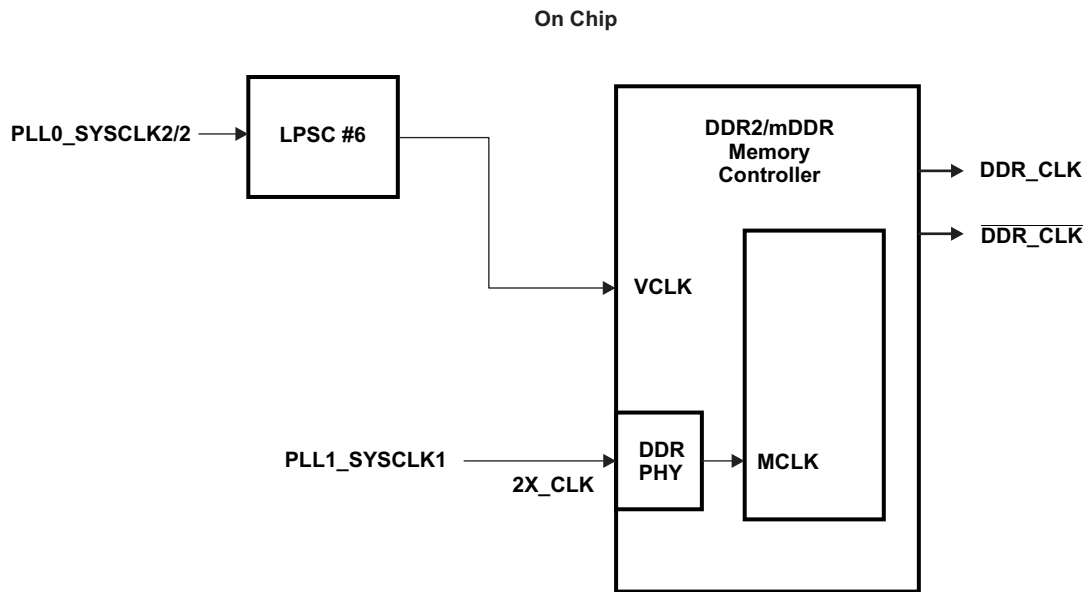

Table 6-5. DDR2/mDDR Memory Controller MCLK Frequencies

OSCIN Frequency	PLL1 Multiplier Register Setting	PLL1 Multiplier Frequency	PLL1 Post Divider Mode ⁽¹⁾	PLL1 POSTDIV Output Frequency	PLL1 PLLDIV1 Register Setting	PLL1_SYSCLK1	MCLK
24	18h	600 MHz	Div2	300 MHz	8000h	300 MHz	150 MHz
24	15h	528 MHz	Div2	264 MHz	8000h	264 MHz	132 MHz
24	14h	504 MHz	Div2	252 MHz	8000h	252 MHz	126 MHz

⁽¹⁾ See Section 6.2 for explanation of POSTDIV divider modes.

6.3.3 EMIFA Clocking

EMIFA requires a single input clock source. The EMIFA clock can be sourced from either PLL0_SYSCLK3 or DIV4P5 (see Figure 6-4). The EMA_CLKSRC bit in the chip configuration 3 register (CFGCHIP3) of the System Configuration Module controls whether PLL0_SYSCLK3 or DIV4P5 is selected as the clock source for EMIFA.

Selecting the appropriate clock source for EMIFA is determined by the desired clock rate. Table 6-6 shows example PLL register settings and the resulting DIV4P5 and PLL0_SYSCLK3 frequencies based on the OSCIN reference clock frequency of 25 MHz. From these example configurations, the following observations can be made:

- To achieve the maximum frequency (100 MHz) supported by EMIFA and the typical CPU frequency of 300 MHz, the output of the PLL multiplier should be set to 600 MHz and the EMA_CLK source should be set to PLL0_SYSCLK3 with the PLLDIV3 register set to 3.
- The frequency of the DIV4P5 clock is fixed at the output frequency of the PLL multiplier block divided by 4.5.
- The PLLDIV3 block that sets the divider ratio for PLL0_SYSCLK3 can be changed to achieve various clock frequencies.

Figure 6-4. EMIFA Clocking Diagram

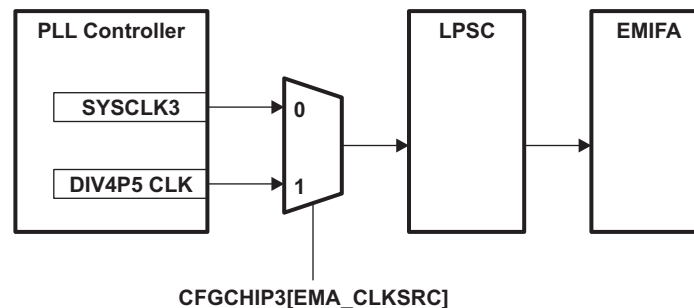

Table 6-6. EMIFA Frequencies

OSCIN Frequency	PLL Multiplier Register Setting	Multiplier Frequency	Post Divider Mode ⁽¹⁾	POSTDIV Output Frequency	DIV4P5	PLLDIV3 Register Setting	PLL0_SYSCLK3
25	24	600 MHz	Div2	300 MHz	133 MHz ⁽²⁾	2	100 MHz
			Div3	200 MHz	133 MHz ⁽²⁾	2	66.6 MHz
						1	100 MHz
			Div4	150 MHz	133 MHz ⁽²⁾	1	75 MHz
25	18	450 MHz	Div2	225 MHz	100 MHz	3	56.3 MHz
						2	75 MHz
			Div3	150 MHz	100 MHz	1	75 MHz
				Div4	112.5 MHz	100 MHz	1
			0	112.5 MHz			
25	16	400 MHz	Div2	200 MHz	89 MHz	2	66.6 MHz
						1	100 MHz
			Div3	133 MHz	89 MHz	1	66.5 MHz
				Div4	100 MHz	89 MHz	0

⁽¹⁾ See Section 6.2 for explanation of POSTDIV divider modes.

⁽²⁾ The maximum frequency supported by EMIFA is 100 MHz. The 133 MHz is outside of the supported frequency range for EMIFA and, therefore, is not supported.

6.3.4 uPP Clocking

Figure 6-5 displays the clock connections for the uPP module. The uPP subsystem requires a module clock to drive its internal logic and a transmit clock to drive I/O signals in transmit mode. The module clock is always sourced by PLL0_SYSCLK2. The transmit clock is sourced by three different clocks: PLL0_SYSCLK2 (default), PLL1_SYSCLK2, or the externally driven UPP_2xTXCLK pin. The transmit clock source is selected by the UPP_TX_CLKSRC and ASYNC3_CLKSRC bits in the chip configuration 3 register (CFGCHIP3) of the System Configuration Module. Table 6-7 lists the register values that select each of the three possible clock sources.

Regardless of the source, the uPP transmit clock speed cannot exceed the uPP module clock speed. The module clock speed must be greater than or equal to the transmit clock speed.

Figure 6-5. uPP Clocking Diagram

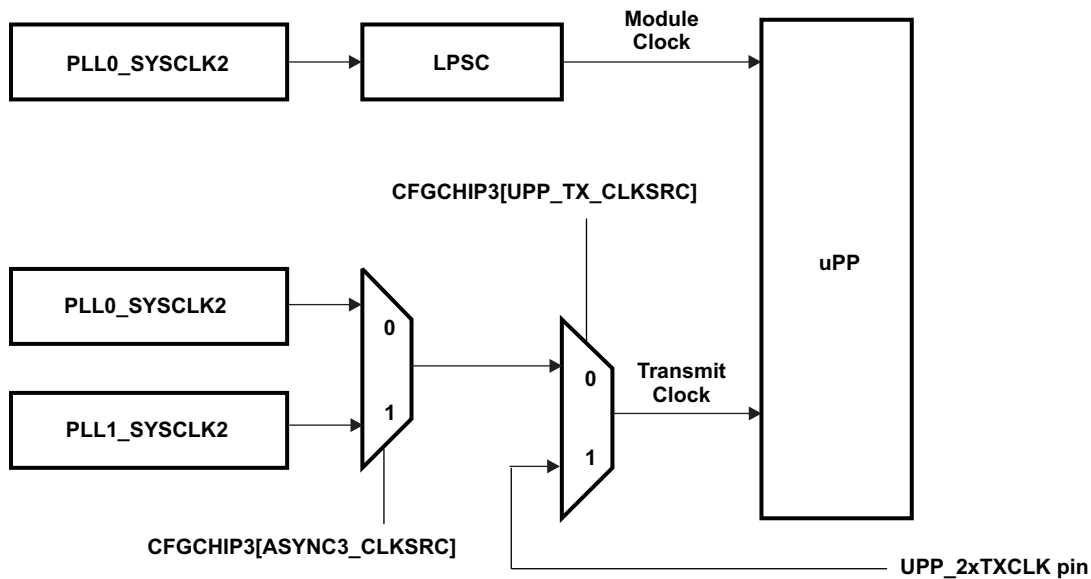

Table 6-7. uPP Transmit Clock Selection

CFGCHIP3.UPP_TX_CLKSRC bit	CFGCHIP3.ASYNC3_CLKSRC bit	uPP Transmit Clock Source
0	0	PLL0_SYSCLK2
0	1	PLL1_SYSCLK2
1	x	UPP_2xTXCLK pin

6.3.5 McASP Clocking

As shown in Figure 6-6, the McASP peripheral requires multiple clock sources. Internally, the module clock is selected to be either PLL0_SYSCLK2 or PLL1_SYSCLK2 by configuring the ASYNC3_CLKSRC bit in the chip configuration 3 register (CFGCHIP3) of the System Configuration Module.

The transmit and receive clocks are sourced internally or externally by configuring the McASP clock control registers ACLKCTL, AHCLKCTL, ACLKXCTL, and AHCLKXCTL. If an external clock is driven into a high-frequency master clock (AHCLKX or AHCLKR), the McASP module allows for a mixed clock mode where the associated lower frequency clock (ACLKX or ACLKR) can be derived from the high-frequency master clock through a programmable divider.

When the internal clock source option is selected, the transmit and receive clocks are derived from the PLL0_AUXCLK clock through programmable dividers.

Figure 6-6. McASP Clocking Diagram

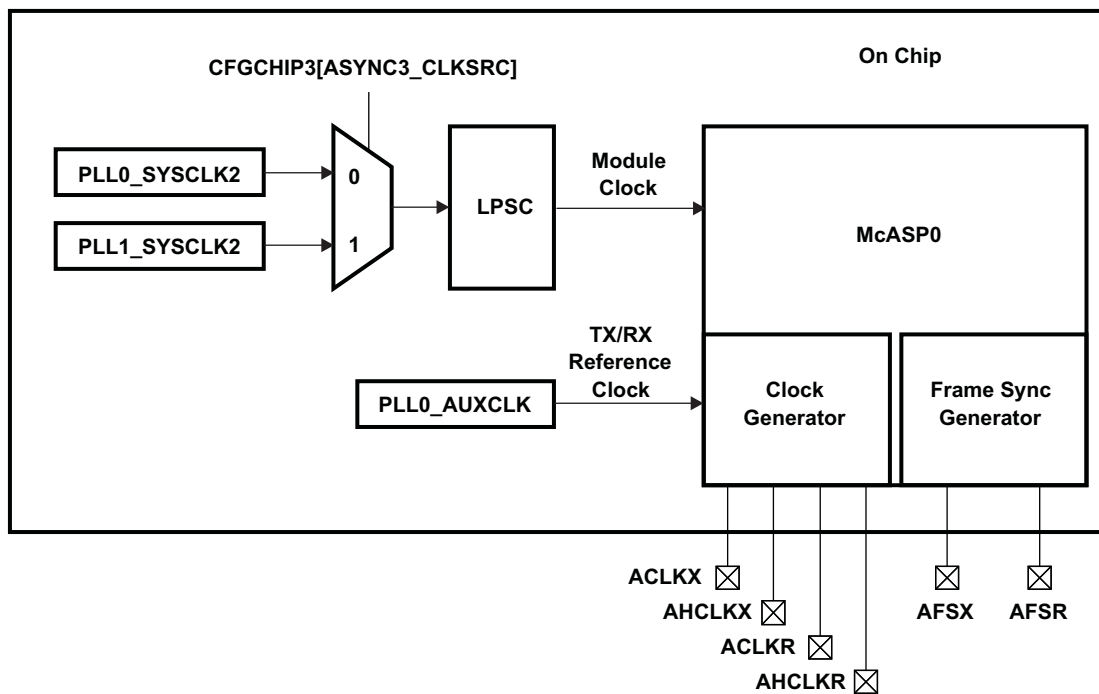

6.3.6 I/O Domains

The I/O domains refer to the frequencies of the peripherals that communicate through device pins. In many cases, there are frequency requirements for a peripheral pin interface that are set by an outside standard and must be met. It is not necessarily possible to obtain these frequencies from the on-chip clock generation circuitry, so the frequencies must be obtained from external sources and are asynchronous to the CPU frequency by definition.

The peripherals can be divided into the following groups, depending upon their clock requirements, as shown in [Table 6-8](#).

Table 6-8. Peripherals

Peripheral Group	Peripheral Group Definition	Peripherals Contained within Group	Source of Peripheral Clock
RTC	Operates off of a dedicated 32 kHz crystal oscillator.	RTC	—
Fixed-Frequency Peripherals	As the name suggests, fixed-frequency peripherals have a fixed-frequency. They are fed the AUXCLK directly from the oscillator input.	Timer64P0/P1	—
		I2C0	—
Synchronous Peripherals	Synchronous peripherals have their frequencies derived from the ARM clock frequency. The peripheral system clock frequency changes accordingly, if the PLL0 frequency changes. Most synchronous peripherals have internal dividers so they can generate their required clock frequencies.	MMC/SDs	PLL0_SYSCLK2
		HPI	PLL0_SYSCLK2
		UART0	PLL0_SYSCLK2
		LCDC	PLL0_SYSCLK2
		GPIO	PLL0_SYSCLK4
Asynchronous Peripherals	Asynchronous peripherals are not required to operate at a fixed ratio of the ARM clock.	eCAPs	ASYNC3
		eHRPWMs	ASYNC3
		UART1/2	ASYNC3
		Timer64P2/P3	ASYNC3
		EMIFA	DIV_4P5 or PLL0_SYSCLK3
		DDR2/mDDR	PLL1_SYSCLK1 or PLL1 Direct Output
Synchronous/Asynchronous Peripherals	Synchronous/asynchronous peripherals can be run with either internally generated synchronous clocks, or externally generated asynchronous clocks.	McASP0	ASYNC3 or Peripheral Serial Clock
		McBSPs	ASYNC3 or Peripheral Serial Clock
		SPI0	PLL0_SYSCLK2 or Peripheral Serial Clock
		SPI1	ASYNC3 or Peripheral Serial Clock
		I2C1	PLL0_SYSCLK4 or Peripheral Serial Clock
		uPP	PLL0_SYSCLK2 or Peripheral Serial Clock
		VPIF	PLL0_SYSCLK2 or Peripheral Serial Clock
		USB2.0	USB_REFCLKIN or AUXCLK

Phase-Locked Loop Controller (PLL)

Topic	Page
7.1 Introduction	72
7.2 PLL Controllers	72
7.3 PLLC Registers	77

7.1 Introduction

This device has two phase-locked loop (PLL) controllers, PLLC0 and PLLC1. These PLL controllers provide clock signals to most of the components of the device through various clock dividers.

Both PLL0 and PLL1 provide the following:

- Glitch-free transitions when clock settings are changed
- Domain clock alignment
- Clock gating
- PLL power-down

The clock outputs generated by the PLL controllers are:

- Domain clocks: PLL0_SYSCLK[1-7] and PLL1_SYSCLK[1-3]
- Auxiliary clock (PLL0_AUXCLK) from the PLLC0 reference clock source

Dividers that can be used for the PLL controllers are:

- Pre-PLL divider: PREDIV
- Post-PLL divider: POSTDIV
- SYSCLK divider: D1, ..., Dn

Various other control signals supported are:

- PLL multiplier: PLLM
- Software-programmable PLL bypass: PLEN

7.2 PLL Controllers

PLL0 and PLL1 share the same internal architecture so they also share the same approach for mode configuration.

PLL0 provides the primary system clock to the device. PLL0 operations are software programmable through the PLL controller 0 (PLLC0) registers.

PLL1 provides the reference clocks to various peripherals (including DDR2/mDDR) and may generate clocks that are asynchronous to the PLL0 clocks. PLL1 operations are software programmable through the PLL controller 1 (PLLC1) registers.

[Figure 7-1](#) shows the PLLC0 and PLLC1 architecture.

The PLL0 and PLL1 multipliers are controlled by their respective PLL multiplier control register (PLLM). The PLLM defaults to a multiplier value of 13h at power-up, which results in a PLL multiplier of 20×. The PLL0 and PLL1 output clocks may be divided-down for slower device operation using the PLL post-divider control register (POSTDIV). The POSTDIV has a default value of /2, but may be modified through software (using the RATIO field in POSTDIV) to achieve lower device operation frequencies. The default PLLM and POSTDIV settings produce a 300-MHz PLL output clock when given a 30-MHz clock source.

At power-up, PLL0 and PLL1 are powered-down/disabled and must be powered-up by software through the PLLPWRDN bit in their respective PLL control register (PLLCTL). Before each PLL completes the power-up and frequency-lock sequence, the system operates in bypass mode by default and the system clock (OSCIN) is provided directly from an input reference clock (square wave or internal oscillator) selected by the CLKMODE bit in PLLCTL. After the power-up and frequency-lock sequences are complete, software can switch the device to PLL mode operation (set the PLEN bit in PLLCTL to 1).

The PLL controller registers are listed in [Section 7.3](#).

Figure 7-1. PLLC Structure

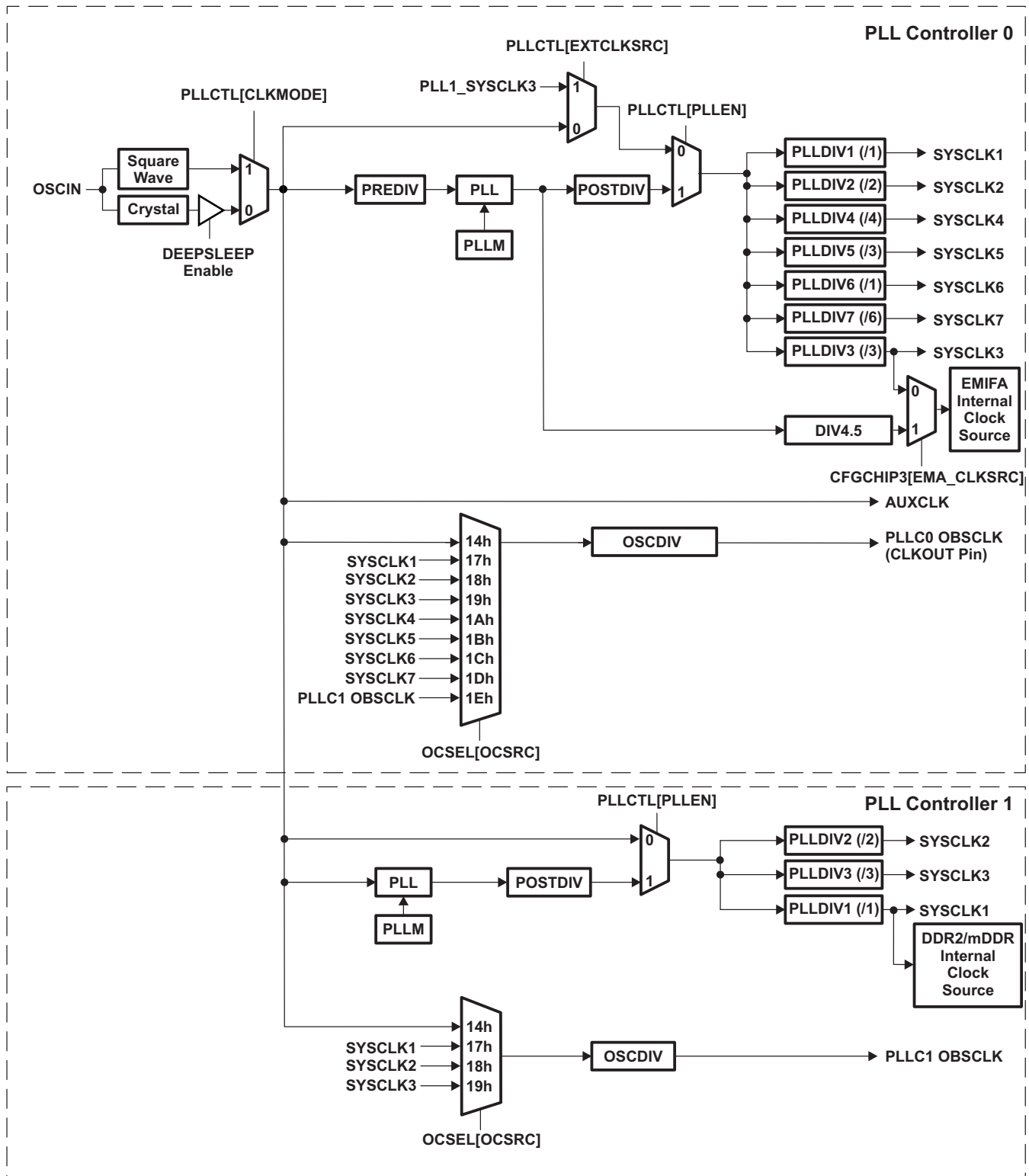

7.2.1 Device Clock Generation

The PLL controllers (PLL0 and PLL1) manage the clock ratios, alignment, and gating for the device system clocks. Various PLL mode attributes such as pre-division, multiplier, and post-division are software programmable through the PLL controller registers. Additionally, the reset controller in PLL0 manages reset propagation through the device, clock alignment, and test points.

The PLL0 stage in PLL0 and PLL1 is capable of providing frequencies greater than what the SYSCLK dividers can handle. The POSTDIV stage should be programmed to keep the input to the SYSCLK dividers within operating limits. See the device datasheet for the maximum operating frequencies.

PLL0 and PLL1 generate several clocks for use by the various processors and modules. These reference clocks are summarized in [Table 7-1](#). Some output clock dividers require fixed values so that clock ratios between various device components are maintained regardless of PLL or bypass frequency.

Table 7-1. System PLLC Output Clocks

Output Clock	Used by	Default Ratio (relative to PLL _n _SYSCLK1)	Fixed Clock Ratio
PLL0⁽¹⁾			
PLL0_SYSCLK1	Not used	/1	Yes
PLL0_SYSCLK2	ARM RAM/ROM, On-chip RAM, UART0, EDMA, SPI0, MMC/SDs, VPIF, LCD, uPP, DDR2/mDDR (bus ports), USB2.0, HPI, PRU	/2	Yes
PLL0_SYSCLK3 ⁽²⁾	EMIFA	/3	No
PLL0_SYSCLK4	System configuration (SYSCFG), GPIO, PLLCs, PSCs, I2C1, ARM INTC	/4	Yes
PLL0_SYSCLK5	Not used	/3	No
PLL0_SYSCLK6	ARM	/1	Yes
PLL0_AUXCLK	I2C0, Timer64P0/P1, RTC, USB2.0 PHY, McASP0 serial clock	PLL bypass clock	No
PLL0_OBSCLK	Observation clock (OBSCLK) source	Pin configurable	No
PLL1			
PLL1_SYSCLK1	DDR2/mDDR PHY	/1 or disabled	No
PLL1_SYSCLK2 ⁽³⁾	ECAPs, UART1/2, Timer64P2/3, eHRPWMs, McBSPs, McASP0, SPI1 (all these modules use PLL0_SYSCLK2 by default)	/2 or disabled	No
PLL1_SYSCLK3 ⁽⁴⁾	PLL0 input reference clock (not configured by default)	/3 or disabled	No

⁽¹⁾ The divide values in PLL0 for PLL0_SYSCLK1/PLL0_SYSCLK6, PLL0_SYSCLK2, and PLL0_SYSCLK4 can be changed for power savings, but the device must maintain the 1:2:4 clock ratios between the clock domains.

⁽²⁾ PLL0 supports an additional post-divider value of /4.5 that can be used for EMIFA clock generation. When this /4.5 value is used, the resulting clock will not have a 50% duty cycle. Instead, the duty cycle will be 44.4%. The EMIFA uses PLL0_SYSCLK3 by default, but can be configured to use a /4.5 divide-down of PLL0_PLOUT instead of PLL0_SYSCLK3 by programming the EMA_CLKSRC and DIV45PEN bits in the chip configuration 3 register (CFGCHIP3) of the system configuration (SYSCFG) module.

⁽³⁾ The ASYNC3 modules use PLL0_SYSCLK2 by default, but all these modules can be configured as a group to use PLL1_SYSCLK2 by programming the ASYNC3_CLKSRC bit in the chip configuration 3 register (CFGCHIP3) of the system configuration (SYSCFG) module.

⁽⁴⁾ The PLL0 input clock source can be configured to use PLL1_SYSCLK3 instead of OSCIN by programming the EXTCLKSRC bit in the PLL0 PLL control register (PLLCTL). The PLL1 input clock source will also be OSCIN.

7.2.2 Steps for Programming the PLLs

Note that there is a lock mechanism implemented to protect the PLL controller registers. See [Section 7.2.2.1](#) for information on unlocking the PLL controller registers.

Refer to the appropriate subsection on how to program the PLL clocks:

- If the PLL is powered down (PLL_PWRDN bit in PLL_CTL is set to 1), follow the full PLL initialization procedure in [Section 7.2.2.2](#).
- If the PLL is not powered down (PLL_PWRDN bit in PLL_CTL is cleared to 0), follow the sequence in [Section 7.2.2.3](#) to change the PLL multiplier.
- If the PLL is already running at a desired multiplier and only the SYSCLK dividers will be updated, follow the sequence in [Section 7.2.2.4](#).

Note that the PLLs are powered down after a Power-on Reset (POR). The PLLs are not powered down after a Warm Reset (RESET), but the PLEN bit in PLL_CTL is cleared to 0 (bypass mode) and the PLLDIVx registers are reset to default values.

7.2.2.1 Locking/Unlocking PLL Register Access

A lock mechanism is implemented on the device to prevent inadvertent writes to the PLL controller registers. This provides protection from stopping modules when the module clocks are disabled. For example, the watchdog timer that runs on the PLL0_AUXCLK will stop if this PLL clock is unintentionally disabled.

The PLL lock bits are located within the system configuration (SYSCFG) module:

- When set, the PLL_MASTER_LOCK bit in the chip configuration 0 register (CFGCHIP0) locks PLLC0.
- When set, the PLL1_MASTER_LOCK bit in the chip configuration 3 register (CFGCHIP3) locks PLLC1.

Because the SYSCFG module has its own lock mechanism, the SYSCFG module must be unlocked first by writing to the KICK0R and KICK1R registers before the PLL lock bits can be cleared. Like the KICK registers, the PLL lock bits can only be modified while in a privileged mode. See [Chapter 10](#) for information on privilege type and the KICK0R and KICK1R registers.

NOTE: The PLL_MASTER_LOCK bit in CFGCHIP0 and the PLL1_MASTER_LOCK bit in CFGCHIP3 default to unlocked after reset, so the following procedure is only required if the PLLs have been locked (set to 1).

To modify the PLL controller registers, use the following sequence:

1. Write the correct key values to KICK0R and KICK1R registers.
2. Clear the PLL_MASTER_LOCK bit in CFGCHIP0 and/or the PLL1_MASTER_LOCK bit in CFGCHIP3, as required.
3. Configure the desired PLL controller register values.
4. Set the PLL_MASTER_LOCK bit in CFGCHIP0 and/or the PLL1_MASTER_LOCK bit in CFGCHIP3, as required.
5. Write an incorrect key value to the KICK0R and KICK1R registers.

7.2.2.2 Initializing PLL Mode from PLL Power Down

If the PLL is powered down (PLL_PWRDN bit in PLL_CTL is set to 1), perform the following procedure to initialize the PLL:

1. Program the CLKMODE bit in PLLC0 PLL_CTL.
2. Switch the PLL to bypass mode:
 - (a) Clear the PLENSRC bit in PLL_CTL to 0 (allows PLEN bit to take effect).
 - (b) For PLL0 only, select the clock source by programming the EXTCLKSRC bit in PLL_CTL.
 - (c) Clear the PLEN bit in PLL_CTL to 0 (PLL in bypass mode).
 - (d) Wait for 4 OSCIN cycles to ensure that the PLLC has switched to bypass mode.
3. Clear the PLLRST bit in PLL_CTL to 0 (resets PLL).
4. Clear the PLL_PWRDN bit in PLL_CTL to 0 (brings PLL out of power-down mode).
5. Program the desired multiplier value in PLLM. Program the POSTDIV, as needed.
6. If desired, program PLLDIV n registers to change the SYSCLK n divide values:
 - (a) Wait for the GOSTAT bit in PLL_STAT to clear to 0 (indicates that no operation is currently in progress).
 - (b) Program the RATIO field in PLLDIV n .
 - (c) Set the GOSET bit in PLL_CMD to 1 (initiates a new divider transition).
 - (d) Wait for the GOSTAT bit in PLL_STAT to clear to 0 (completion of divider change).
7. Set the PLLRST bit in PLL_CTL to 1 (brings PLL out of reset).
8. Wait for the PLL to lock. See the device-specific data manual for PLL lock time.
9. Set the PLEN bit in PLL_CTL to 1 (removes PLL from bypass mode).

7.2.2.3 Changing PLL Multiplier

If the PLL is not powered down (PLL_PWRDN bit in PLL_CTL is cleared to 0), perform the following procedure to change the PLL multiplier:

1. Switch the PLL to bypass mode:
 - (a) Clear the PLENSRC bit in PLL_CTL to 0 (allows PLEN bit to take effect).
 - (b) For PLL0 only, select the clock source by programming the EXTCLKSRC bit in PLL_CTL.
 - (c) Clear the PLEN bit in PLL_CTL to 0 (PLL in bypass mode).
 - (d) Wait for 4 OSCIN cycles to ensure that the PLLC has switched to bypass mode.
2. Clear the PLLRST bit in PLL_CTL to 0 (resets PLL).
3. Program the desired multiplier value in PLLM. Program the POSTDIV, as needed.
4. If desired, program PLLDIV n registers to change the SYSCLK n divide values:
 - (a) Wait for the GOSTAT bit in PLL_STAT to clear to 0 (indicates that no operation is currently in progress).
 - (b) Program the RATIO field in PLLDIV n .
 - (c) Set the GOSET bit in PLL_CMD to 1 (initiates a new divider transition).
 - (d) Wait for the GOSTAT bit in PLL_STAT to clear to 0 (completion of divider change).
5. Set the PLLRST bit in PLL_CTL to 1 (brings PLL out of reset).
6. Wait for the PLL to lock. See the device-specific data manual for PLL lock time.
7. Set the PLEN bit in PLL_CTL to 1 (removes PLL from bypass mode).

7.2.2.4 Changing SYSCLK Dividers

If the PLL is already operating at the desired multiplier mode, perform the following procedure to change the SYSCLK divider values:

1. Wait for the GOSTAT bit in PLLSTAT to clear to 0 (indicates that no operation is currently in progress).
2. Program the RATIO field in PLLDIV n .
3. Set the GOSET bit in PLLCMD to 1 (initiates a new divider transition).
4. Wait for the GOSTAT bit in PLLSTAT to clear to 0 (completion of divider change).

7.3 PLLC Registers

[Table 7-2](#) lists the memory-mapped registers for the PLLC0 and [Table 7-3](#) lists the memory-mapped registers for the PLLC1.

Table 7-2. PLL Controller 0 (PLLC0) Registers

Address	Acronym	Register Description	Section
01C1 1000h	REVID	PLLC0 Revision Identification Register	Section 7.3.1
01C1 10E4h	RSTYPE	PLLC0 Reset Type Status Register	Section 7.3.3
01C1 10E8h	RSCTRL	PLLC0 Reset Control Register	Section 7.3.4
01C1 1100h	PLLCTL	PLLC0 Control Register	Section 7.3.5
01C1 1104h	OCSEL	PLLC0 OBSCLK Select Register	Section 7.3.7
01C1 1110h	PLLM	PLLC0 PLL Multiplier Control Register	Section 7.3.9
01C1 1114h	PREDIV	PLLC0 Pre-Divider Control Register	Section 7.3.10
01C1 1118h	PLLDIV1	PLLC0 Divider 1 Register	Section 7.3.11
01C1 111Ch	PLLDIV2	PLLC0 Divider 2 Register	Section 7.3.13
01C1 1120h	PLLDIV3	PLLC0 Divider 3 Register	Section 7.3.15
01C1 1124h	OSCDIV	PLLC0 Oscillator Divider 1 Register	Section 7.3.21
01C1 1128h	POSTDIV	PLLC0 PLL Post-Divider Control Register	Section 7.3.23
01C1 1138h	PLLCMD	PLLC0 PLL Controller Command Register	Section 7.3.24
01C1 113Ch	PLLSTAT	PLLC0 PLL Controller Status Register	Section 7.3.25
01C1 1140h	ALNCTL	PLLC0 Clock Align Control Register	Section 7.3.26
01C1 1144h	DCHANGE	PLLC0 PLLDIV Ratio Change Status Register	Section 7.3.28
01C1 1148h	CKEN	PLLC0 Clock Enable Control Register	Section 7.3.30
01C1 114Ch	CKSTAT	PLLC0 Clock Status Register	Section 7.3.32
01C1 1150h	SYSTAT	PLLC0 SYSCLK Status Register	Section 7.3.34
01C1 1160h	PLLDIV4	PLLC0 Divider 4 Register	Section 7.3.17
01C1 1164h	PLLDIV5	PLLC0 Divider 5 Register	Section 7.3.18
01C1 1168h	PLLDIV6	PLLC0 Divider 6 Register	Section 7.3.19
01C1 116Ch	PLLDIV7	PLLC0 Divider 7 Register	Section 7.3.20
01C1 11F0h	EMUCNT0	PLLC0 Emulation Performance Counter 0 Register	Section 7.3.36
01C1 11F4h	EMUCNT1	PLLC0 Emulation Performance Counter 1 Register	Section 7.3.37

Table 7-3. PLL Controller 1 (PLL1) Registers

Address	Acronym	Register Description	Section
01E1 A00h	REVID	PLL1 Revision Identification Register	Section 7.3.2
01E1 A100h	PLLCTL	PLL1 Control Register	Section 7.3.6
01E1 A104h	OCSEL	PLL1 OBSCLK Select Register	Section 7.3.8
01E1 A110h	PLLM	PLL1 PLL Multiplier Control Register	Section 7.3.9
01E1 A118h	PLLDIV1	PLL1 Divider 1 Register	Section 7.3.12
01E1 A11Ch	PLLDIV2	PLL1 Divider 2 Register	Section 7.3.14
01E1 A120h	PLLDIV3	PLL1 Divider 3 Register	Section 7.3.16
01E1 A124h	OSCDIV	PLL1 Oscillator Divider 1 Register	Section 7.3.22
01E1 A128h	POSTDIV	PLL1 PLL Post-Divider Control Register	Section 7.3.23
01E1 A138h	PLLCMD	PLL1 PLL Controller Command Register	Section 7.3.24
01E1 A13Ch	PLLSTAT	PLL1 PLL Controller Status Register	Section 7.3.25
01E1 A140h	ALNCTL	PLL1 Clock Align Control Register	Section 7.3.27
01E1 A144h	DCHANGE	PLL1 PLLDIV Ratio Change Status Register	Section 7.3.29
01E1 A148h	CKEN	PLL1 Clock Enable Control Register	Section 7.3.31
01E1 A14Ch	CKSTAT	PLL1 Clock Status Register	Section 7.3.33
01E1 A150h	SYSTAT	PLL1 SYSCLK Status Register	Section 7.3.35
01E1 A1F0h	EMUCNT0	PLL1 Emulation Performance Counter 0 Register	Section 7.3.36
01E1 A1F4h	EMUCNT1	PLL1 Emulation Performance Counter 1 Register	Section 7.3.37

7.3.1 PLLC0 Revision Identification Register (REVID)

The PLLC0 revision identification register (REVID) is shown in [Figure 7-2](#) and described in [Table 7-4](#).

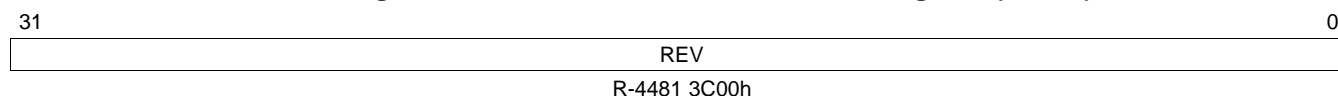
Figure 7-2. PLLC0 Revision Identification Register (REVID)

LEGEND: R = Read only; -n = value after reset

Table 7-4. PLLC0 Revision Identification Register (REVID) Field Descriptions

Bit	Field	Value	Description
31-0	REV	4481 3C00h	Peripheral revision ID for PLLC0.

7.3.2 PLLC1 Revision Identification Register (REVID)

The PLLC1 revision identification register (REVID) is shown in [Figure 7-3](#) and described in [Table 7-5](#).

Figure 7-3. PLLC1 Revision Identification Register (REVID)



LEGEND: R = Read only; -n = value after reset

Table 7-5. PLLC1 Revision Identification Register (REVID) Field Descriptions

Bit	Field	Value	Description
31-0	REV	4481 4400h	Peripheral revision ID for PLLC1.

7.3.3 Reset Type Status Register (RSTYPE)

The reset type status register (RSTYPE) latches the cause of the last reset. If multiple reset sources are asserted simultaneously, RSTYPE records the reset source that deasserts last. If multiple reset sources are asserted and deasserted simultaneously, RSTYPE latches the highest priority reset source. RSTYPE is shown in [Figure 7-4](#) and described in [Table 7-6](#).

Figure 7-4. Reset Type Status Register (RSTYPE)

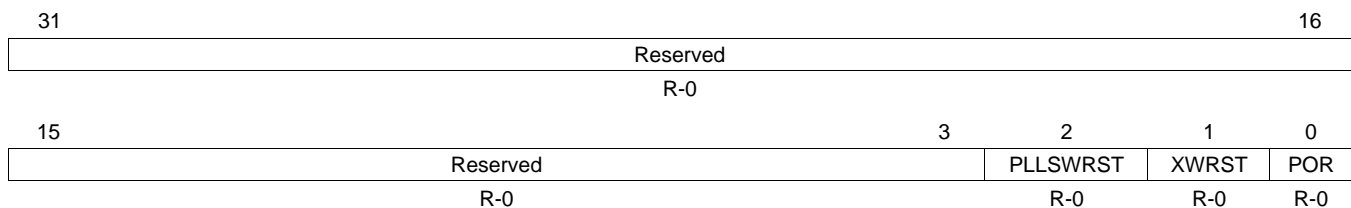

LEGEND: R = Read only; -n = value after reset

Table 7-6. Reset Type Status Register (RSTYPE) Field Descriptions

Bit	Field	Value	Description
31-3	Reserved	0	Reserved
2	PLLSWRST	0	PLL software reset. PLL soft reset was not the last reset to occur.
		1	PLL soft was the last reset to occur.
1	XWRST	0	External warm reset. External warm reset was not the last reset to occur.
		1	External warm reset was the last reset to occur.
0	POR	0	Power on reset. Power On Reset (POR) was not the last reset to occur.
		1	Power On Reset (POR) was the last reset to occur.

7.3.4 PLLC0 Reset Control Register (RSCTRL)

The reset control register (RSCTRL) allows the device to perform a software-initiated reset. Before writing to the SWRST bit, the register must be unlocked by writing the key value of 5A69h to the KEY bit field. The KEY bit field reads back as Ch when the register is unlocked; any other key value is invalid and indicates that the register is locked. Any write to the register following a successful unlock relocks the register. RSCTRL is shown in [Figure 7-5](#) and described in [Table 7-7](#).

Figure 7-5. Reset Control Register (RSCTRL)

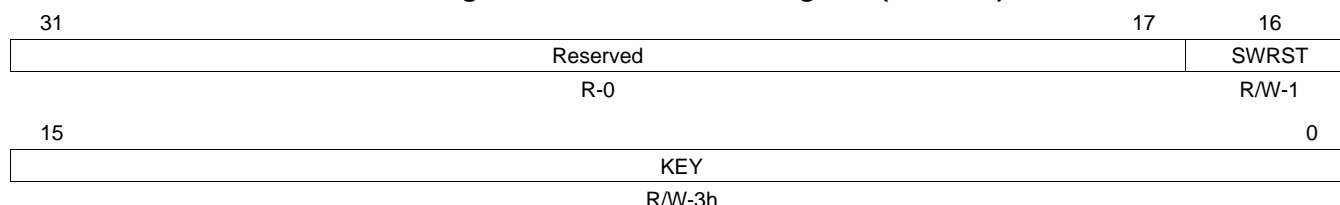

LEGEND: R/W = Read/Write; R = Read only; -n = value after reset

Table 7-7. Reset Control Register (RSCTRL) Field Descriptions

Bit	Field	Value	Description
31-17	Reserved	0	Reserved
16	SWRST	0	PLL software reset. Register must be unlocked before writing to this bit. Writes are possible only when qualified with a valid key.
		1	In software reset
			Not in software reset
15-0	KEY	0-FFFFh	RSCTRL unlock key. Key used to enable writes to RSCTRL.
		3h	Register is locked when read value is 3h.
		Ch	Register is unlocked when read value is Ch.
		5A69h	RSCTRL unlock key

7.3.5 PLLC0 Control Register (PLLCTL)

The PLLC0 control register (PLLCTL) is shown in [Figure 7-6](#) and described in [Table 7-8](#).

Figure 7-6. PLLC0 Control Register (PLLCTL)

31	Reserved						16
R-0							
15	Reserved				10	9	8
R-0					R/W-0	R/W-0	
7	6	5	4	3	2	1	0
Reserved	PLEN	PWRDN	RST	Reserved	SRC	MODE	LEN
R-1		R/W-1	R/W-1	R/W-0	R-0	R/W-1	R/W-0

LEGEND: R/W = Read/Write; R = Read only; -n = value after reset

Table 7-8. PLLC0 Control Register (PLLCTL) Field Descriptions

Bit	Field	Value	Description
31-10	Reserved	0	Reserved
9	EXTCLKSRC	0	Use OSCIN for the PLL bypass clock.
		1	Use PLL1_SYSCLK3 for the PLL bypass clock.
8	CLKMODE	0	Internal oscillator (crystal)
		1	Square wave
7-6	Reserved	1	Reserved
5	PLENSRC	0	This bit must be cleared before the PLEN bit will have any effect.
4	Reserved	1	Reserved. Write the default value when modifying this register.
3	PLL RST	0	PLL0 reset is asserted.
		1	PLL0 reset is not asserted.
2	Reserved	0	Reserved
1	PLL PWRDN	0	PLL0 is operating.
		1	PLL0 is powered-down.
0	P L L E N	0	PLL0 is in bypass mode.
		1	PLL0 mode is enabled, not bypassed.

7.3.6 PLLC1 Control Register (PLLCTL)

The PLLC1 control register (PLLCTL) is shown in [Figure 7-7](#) and described in [Table 7-9](#).

Figure 7-7. PLLC1 Control Register (PLLCTL)

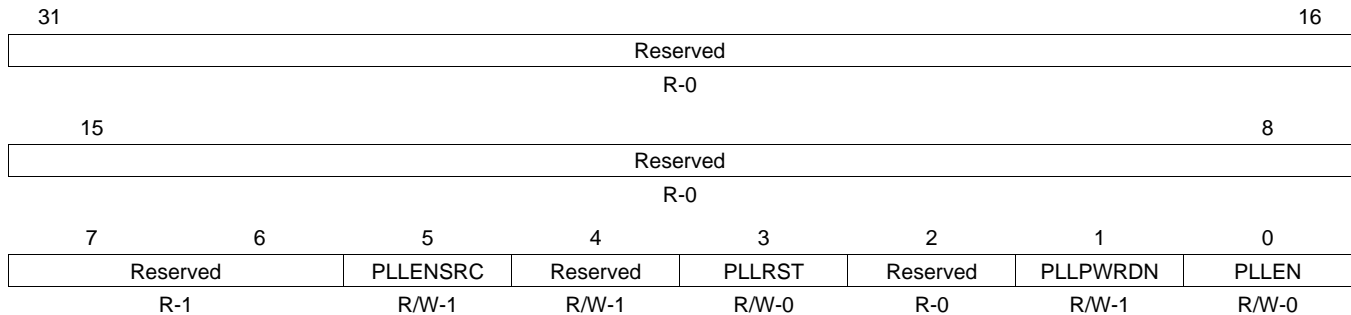

LEGEND: R/W = Read/Write; R = Read only; -n = value after reset

Table 7-9. PLLC1 Control Register (PLLCTL) Field Descriptions

Bit	Field	Value	Description
31-8	Reserved	0	Reserved
7-6	Reserved	1	Reserved
5	PPLENSRC	0	This bit must be cleared before the PLL1LEN bit will have any effect.
4	Reserved	1	Reserved. Write the default value when modifying this register.
3	PLL1RST	0	PLL1 reset is asserted.
		1	PLL1 reset is not asserted.
2	Reserved	0	Reserved
1	PLL1PWRDN	0	PLL1 is operating.
		1	PLL1 is powered-down.
0	PLL1LEN	0	PLL1 mode enables.
		0	PLL1 is in bypass mode.
		1	PLL1 mode is enabled, not bypassed.

7.3.7 PLLC0 OBSCLK Select Register (OCSEL)

The PLLC0 OBSCLK select register (OCSEL) controls which clock is output on the CLKOUT pin so that it may be used for test and debug purposes (in addition to its normal function of being a direct input clock divider). The OCSEL is shown in [Figure 7-8](#) and described in [Table 7-10](#).

Figure 7-8. PLLC0 OBSCLK Select Register (OCSEL)

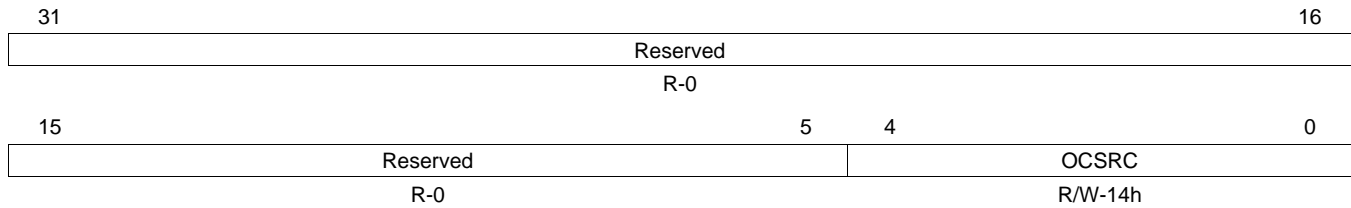

LEGEND: R/W = Read/Write; R = Read only; -n = value after reset

Table 7-10. PLLC0 OBSCLK Select Register (OCSEL) Field Descriptions

Bit	Field	Value	Description
31-5	Reserved	0	Reserved
4-0	OCSRC	0-1Fh	PLLC0 OBSCLK source. Output on CLKOUT pin.
		0-13h	Reserved
		14h	OSCIN
		15h-16h	Reserved
		17h	PLL0_SYSCLK1
		18h	PLL0_SYSCLK2
		19h	PLL0_SYSCLK3
		1Ah	PLL0_SYSCLK4
		1Bh	PLL0_SYSCLK5
		1Ch	PLL0_SYSCLK6
		1Dh	PLL0_SYSCLK7
		1Eh	PLL1 OBSCLK
		1Fh	Disabled

7.3.8 PLLC1 OBSCLK Select Register (OCSEL)

The PLLC1 OBSCLK select register (OCSEL) controls which clock is output on PLLC1 OBSCLK so that it may be used for test and debug purposes (in addition to its normal function of being a direct input clock divider). The OCSEL is shown in [Figure 7-9](#) and described in [Table 7-11](#).

Figure 7-9. PLLC1 OBSCLK Select Register (OCSEL)

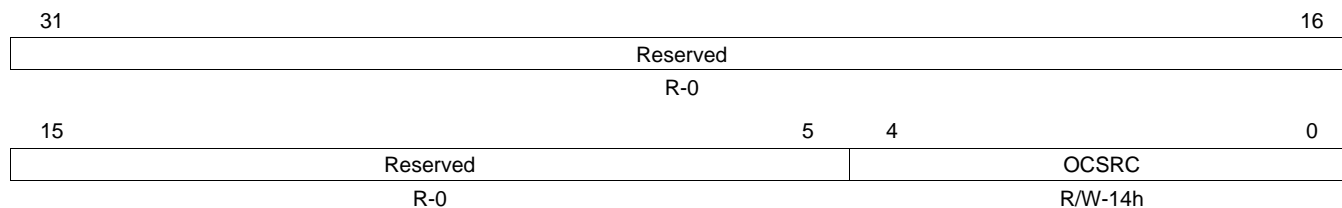

LEGEND: R/W = Read/Write; R = Read only; -n = value after reset

Table 7-11. PLLC1 OBSCLK Select Register (OCSEL) Field Descriptions

Bit	Field	Value	Description
31-5	Reserved	0	Reserved
4-0	OCSRC	0-1Fh	PLLC1 OBSCLK source.
		0-13h	Reserved
		14h	OSCIN
		15h-16h	Reserved
		17h	PLL1_SYSCLK1
		18h	PLL1_SYSCLK2
		19h	PLL1_SYSCLK3
		1A-1Fh	Reserved

7.3.9 PLL Multiplier Control Register (PLLM)

The PLL multiplier control register (PLLM) is shown in [Figure 7-10](#) and described in [Table 7-12](#).

Figure 7-10. PLL Multiplier Control Register (PLLM)

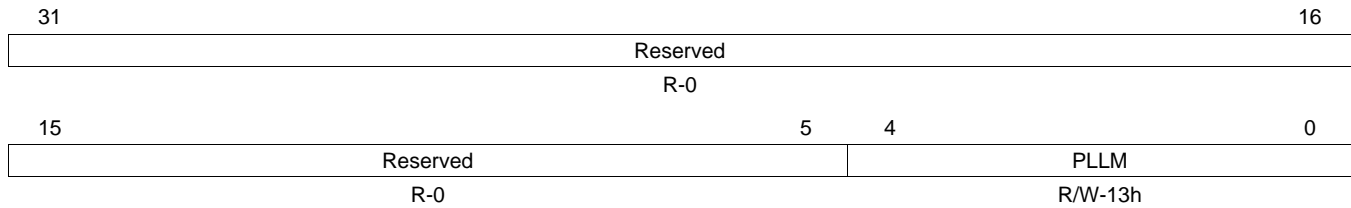

LEGEND: R/W = Read/Write; R = Read only; -n = value after reset

Table 7-12. PLL Multiplier Control Register (PLLM) Field Descriptions

Bit	Field	Value	Description
31-5	Reserved	0	Reserved
4-0	PLLM	0-1Fh	PLL multiplier select. Multiplier Value = PLLM + 1. The valid range of multiplier values for a given OSCIN is defined by the minimum and maximum frequency limits on the PLL VCO frequency. See the device-specific data manual for PLL VCO frequency specification limits.

7.3.10 PLLC0 Pre-Divider Control Register (PREDIV)

The PLLC0 pre-divider control register (PREDIV) is shown in [Figure 7-11](#) and described in [Table 7-13](#).

Figure 7-11. PLLC0 Pre-Divider Control Register (PREDIV)

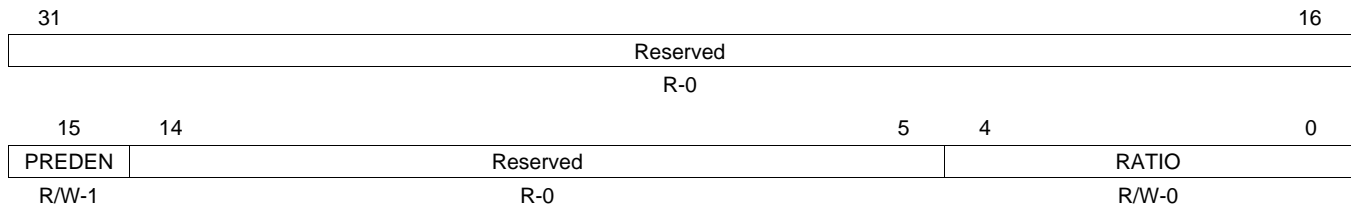

LEGEND: R/W = Read/Write; R = Read only; -n = value after reset

Table 7-13. PLLC0 Pre-Divider Control Register (PREDIV) Field Descriptions

Bit	Field	Value	Description
31-14	Reserved	0	Reserved
15	PREDEN	0	PLLC0 pre-divider enable.
		0	PLLC0 pre-divider is disabled. Clock output from the PREDIV stage is disabled.
		1	PLLC0 pre-divider is enabled.
14-5	Reserved	0	Reserved
4-0	RATIO	0-1Fh	Divider ratio. Divider Value = RATIO + 1. RATIO defaults to 0 (PLL pre-divide by 1).

7.3.11 PLLC0 Divider 1 Register (PLLDIV1)

The PLLC0 divider 1 register (PLLDIV1) controls the divider for PLL0_SYSCLK1. PLLDIV1 is shown in [Figure 7-12](#) and described in [Table 7-14](#).

Figure 7-12. PLLC0 Divider 1 Register (PLLDIV1)

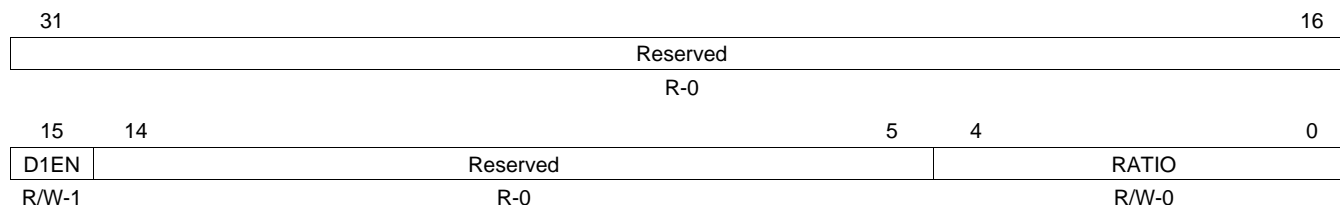

LEGEND: R/W = Read/Write; R = Read only; -n = value after reset

Table 7-14. PLLC0 Divider 1 Register (PLLDIV1) Field Descriptions

Bit	Field	Value	Description
31-16	Reserved	0	Reserved
15	D1EN	0 1	Divider 1 enable. Divider 1 is disabled. Divider 1 is enabled.
14-5	Reserved	0	Reserved
4-0	RATIO	0-1Fh	Divider ratio. Divider Value = RATIO + 1. RATIO defaults to 0 (PLL divide by 1).

7.3.12 PLLC1 Divider 1 Register (PLLDIV1)

The PLLC1 divider 1 register (PLLDIV1) controls the divider for PLL1_SYSCLK1. PLLDIV1 is shown in [Figure 7-13](#) and described in [Table 7-15](#).

Figure 7-13. PLLC1 Divider 1 Register (PLLDIV1)

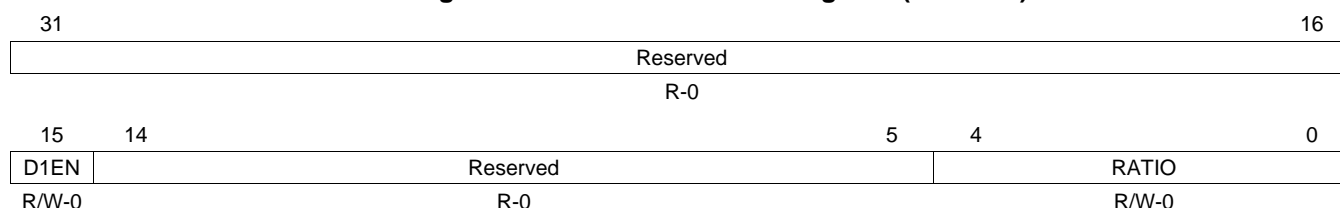

LEGEND: R/W = Read/Write; R = Read only; -n = value after reset

Table 7-15. PLLC1 Divider 1 Register (PLLDIV1) Field Descriptions

Bit	Field	Value	Description
31-16	Reserved	0	Reserved
15	D1EN	0 1	Divider 1 enable. Divider 1 is disabled. Divider 1 is enabled.
14-5	Reserved	0	Reserved
4-0	RATIO	0-1Fh	Divider ratio. Divider Value = RATIO + 1. RATIO defaults to 0 (PLL divide by 1).

7.3.13 PLLC0 Divider 2 Register (PLLDIV2)

The PLLC0 divider 2 register (PLLDIV2) controls the divider for PLL0_SYSCLK2. PLLDIV2 is shown in [Figure 7-14](#) and described in [Table 7-16](#).

Figure 7-14. PLLC0 Divider 2 Register (PLLDIV2)

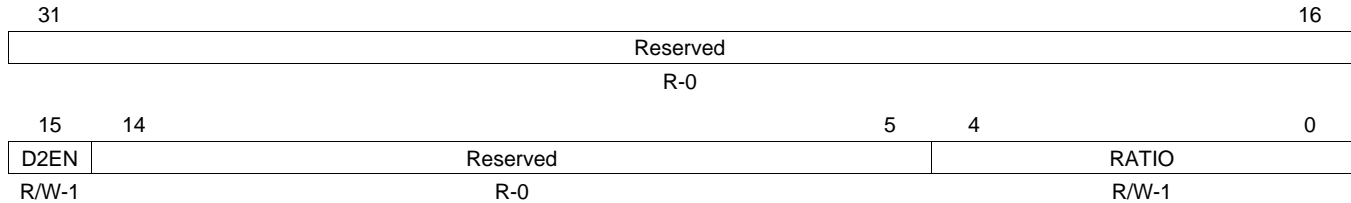

LEGEND: R/W = Read/Write; R = Read only; -n = value after reset

Table 7-16. PLLC0 Divider 2 Register (PLLDIV2) Field Descriptions

Bit	Field	Value	Description
31-16	Reserved	0	Reserved
15	D2EN	0	Divider 2 enable.
		0	Divider 2 is disabled.
		1	Divider 2 is enabled.
14-5	Reserved	0	Reserved
4-0	RATIO	0-1Fh	Divider ratio. Divider Value = RATIO + 1. RATIO defaults to 1 (PLL divide by 2).

7.3.14 PLLC1 Divider 2 Register (PLLDIV2)

The PLLC1 divider 2 register (PLLDIV2) controls the divider for PLL1_SYSCLK2. PLLDIV2 is shown in [Figure 7-15](#) and described in [Table 7-17](#).

Figure 7-15. PLLC1 Divider 2 Register (PLLDIV2)

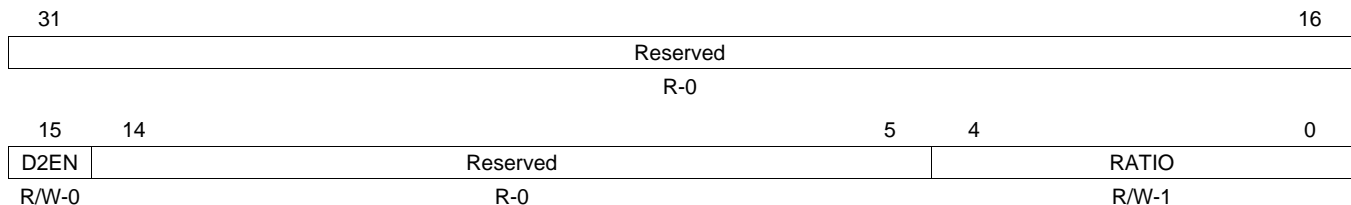

LEGEND: R/W = Read/Write; R = Read only; -n = value after reset

Table 7-17. PLLC1 Divider 2 Register (PLLDIV2) Field Descriptions

Bit	Field	Value	Description
31-16	Reserved	0	Reserved
15	D2EN	0	Divider 2 enable.
		0	Divider 2 is disabled.
		1	Divider 2 is enabled.
14-5	Reserved	0	Reserved
4-0	RATIO	0-1Fh	Divider ratio. Divider Value = RATIO + 1. RATIO defaults to 1 (PLL divide by 2).

7.3.15 PLLC0 Divider 3 Register (PLLDIV3)

The PLLC0 divider 3 register (PLLDIV3) controls the divider for PLL0_SYSCLK3. PLLDIV3 is shown in Figure 7-16 and described in Table 7-18.

Figure 7-16. PLLC0 Divider 3 Register (PLLDIV3)

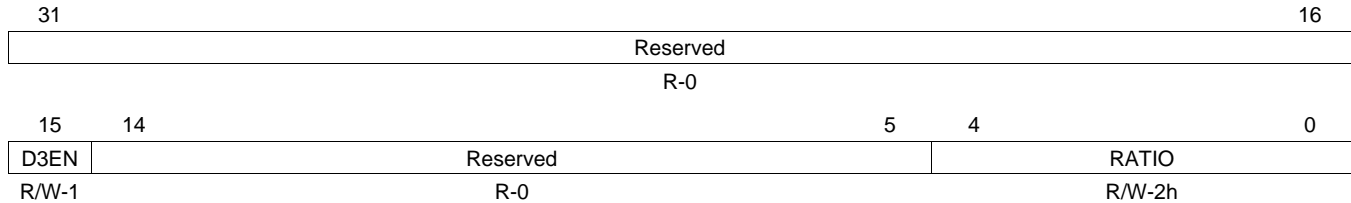

LEGEND: R/W = Read/Write; R = Read only; -n = value after reset

Table 7-18. PLLC0 Divider 3 Register (PLLDIV3) Field Descriptions

Bit	Field	Value	Description
31-16	Reserved	0	Reserved
15	D3EN		Divider 3 enable.
		0	Divider 3 is disabled.
		1	Divider 3 is enabled.
14-5	Reserved	0	Reserved
4-0	RATIO	0-1Fh	Divider ratio. Divider Value = RATIO + 1. RATIO defaults to 2h (PLL divide by 3).

7.3.16 PLLC1 Divider 3 Register (PLLDIV3)

The PLLC1 divider 3 register (PLLDIV3) controls the divider for PLL1_SYSCLK3. PLLDIV3 is shown in Figure 7-17 and described in Table 7-19.

Figure 7-17. PLLC1 Divider 3 Register (PLLDIV3)

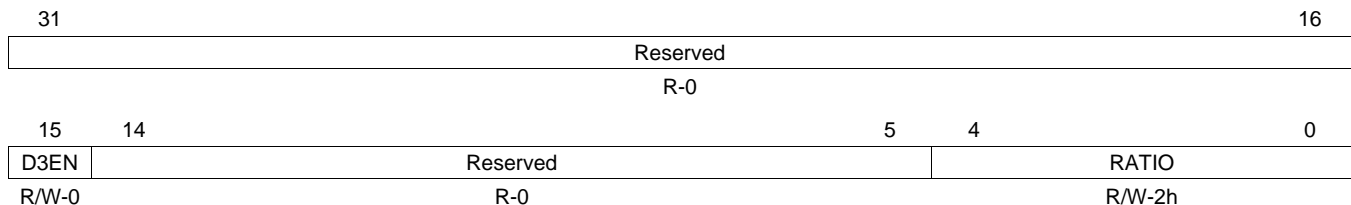

LEGEND: R/W = Read/Write; R = Read only; -n = value after reset

Table 7-19. PLLC1 Divider 3 Register (PLLDIV3) Field Descriptions

Bit	Field	Value	Description
31-16	Reserved	0	Reserved
15	D3EN		Divider 3 enable.
		0	Divider 3 is disabled.
		1	Divider 3 is enabled.
14-5	Reserved	0	Reserved
4-0	RATIO	0-1Fh	Divider ratio. Divider Value = RATIO + 1. RATIO defaults to 2h (PLL divide by 3).

7.3.17 PLLC0 Divider 4 Register (PLLDIV4)

The PLLC0 divider 4 register (PLLDIV4) controls the divider for PLL0_SYSCLK4. PLLDIV4 is shown in [Figure 7-18](#) and described in [Table 7-20](#).

Figure 7-18. PLLC0 Divider 4 Register (PLLDIV4)

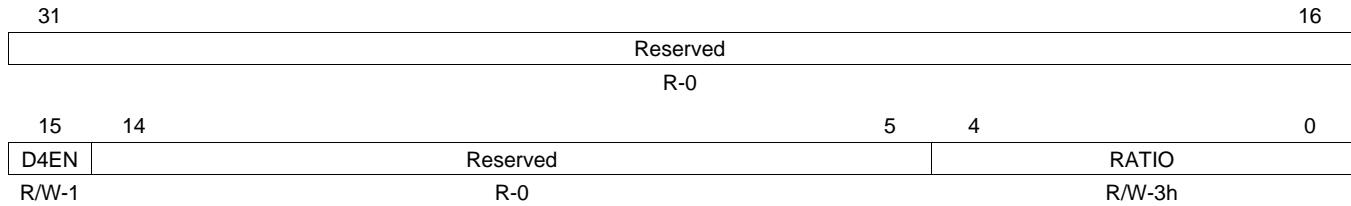

LEGEND: R/W = Read/Write; R = Read only; -n = value after reset

Table 7-20. PLLC0 Divider 4 Register (PLLDIV4) Field Descriptions

Bit	Field	Value	Description
31-16	Reserved	0	Reserved
15	D4EN	0	Divider 4 enable.
		0	Divider 4 is disabled.
		1	Divider 4 is enabled.
14-5	Reserved	0	Reserved
4-0	RATIO	0-1Fh	Divider ratio. Divider Value = RATIO + 1. RATIO defaults 3 (PLL divide by 4).

7.3.18 PLLC0 Divider 5 Register (PLLDIV5)

The PLLC0 divider 5 register (PLLDIV5) controls the divider for PLL0_SYSCLK5. PLLDIV5 is shown in [Figure 7-19](#) and described in [Table 7-21](#).

Figure 7-19. PLLC0 Divider 5 Register (PLLDIV5)

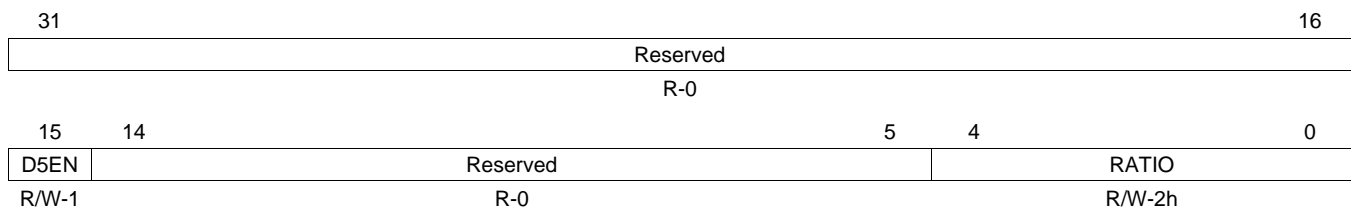

LEGEND: R/W = Read/Write; R = Read only; -n = value after reset

Table 7-21. PLLC0 Divider 5 Register (PLLDIV5) Field Descriptions

Bit	Field	Value	Description
31-16	Reserved	0	Reserved
15	D5EN	0	Divider 5 enable.
		0	Divider 5 is disabled.
		1	Divider 5 is enabled.
14-5	Reserved	0	Reserved
4-0	RATIO	0-1Fh	Divider ratio. Divider Value = RATIO + 1. RATIO defaults 2 (PLL divide by 3).

7.3.19 PLLC0 Divider 6 Register (PLLDIV6)

The PLLC0 divider 6 register (PLLDIV6) controls the divider for PLL0_SYSCLK6. PLLDIV6 is shown in [Figure 7-20](#) and described in [Table 7-22](#).

Figure 7-20. PLLC0 Divider 6 Register (PLLDIV6)

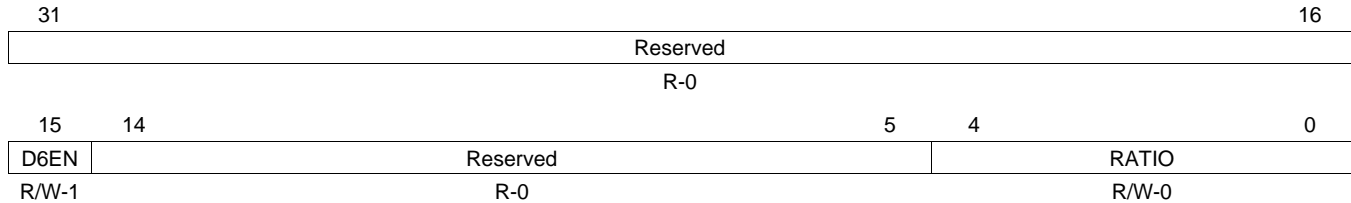

LEGEND: R/W = Read/Write; R = Read only; -n = value after reset

Table 7-22. PLLC0 Divider 6 Register (PLLDIV6) Field Descriptions

Bit	Field	Value	Description
31-16	Reserved	0	Reserved
15	D6EN	0 1	Divider 6 enable. Divider 6 is disabled. Divider 6 is enabled.
14-5	Reserved	0	Reserved
4-0	RATIO	0-1Fh	Divider ratio. Divider Value = RATIO + 1. RATIO defaults to 0 (PLL divide by 1).

7.3.20 PLLC0 Divider 7 Register (PLLDIV7)

The PLLC0 divider 7 register (PLLDIV7) controls the divider for PLL0_SYSCLK7. PLLDIV7 is shown in [Figure 7-21](#) and described in [Table 7-23](#).

Figure 7-21. PLLC0 Divider 7 Register (PLLDIV7)

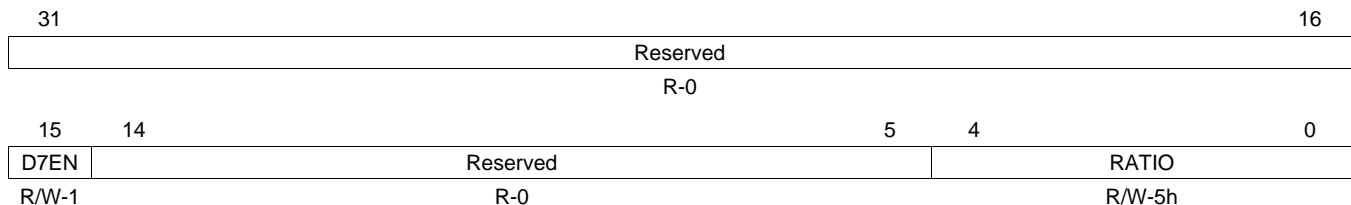

LEGEND: R/W = Read/Write; R = Read only; -n = value after reset

Table 7-23. PLLC0 Divider 7 Register (PLLDIV7) Field Descriptions

Bit	Field	Value	Description
31-16	Reserved	0	Reserved
15	D7EN	0 1	Divider 7 enable. Divider 7 is disabled. Divider 7 is enabled.
14-5	Reserved	0	Reserved
4-0	RATIO	0-1Fh	Divider ratio. Divider Value = RATIO + 1. RATIO defaults to 5 (PLL divide by 6).

7.3.21 PLLC0 Oscillator Divider 1 Register (OSCDIV)

The PLLC0 oscillator divider 1 register (OSCDIV) controls the divider for PLLC0 OBSCLK, dividing down the clock selected as the PLLC0 OBSCLK source. The PLLC0 OBSCLK is connected to the CLKOUT pin. The OSDIV is shown in [Figure 7-22](#) and described in [Table 7-24](#).

Figure 7-22. PLLC0 Oscillator Divider 1 Register (OSCDIV)

31	Reserved				16
R-0					
15	14			5	4
OD1EN	Reserved			RATIO	
R/W-1	R-0			R/W-0	

LEGEND: R/W = Read/Write; R = Read only; -n = value after reset

Table 7-24. PLLC0 Oscillator Divider 1 Register (OSCDIV) Field Descriptions

Bit	Field	Value	Description
31-16	Reserved	0	Reserved
15	OD1EN	0	Oscillator divider 1 is disabled.
		1	Oscillator divider 1 is enabled. For PLLC0 OBSCLK to toggle, both the OD1EN bit and the OBSEN bit in the PLLC0 clock enable control register (CKEN) must be set to 1.
14-5	Reserved	0	Reserved
4-0	RATIO	0-1Fh	Divider ratio. Divider value = RATIO + 1. For example, RATIO = 0 means divide by 1.

7.3.22 PLLC1 Oscillator Divider 1 Register (OSCDIV)

The PLLC1 oscillator divider 1 register (OSCDIV) controls the divider for PLLC1 OBSCLK, dividing down the clock selected as the PLLC1 OBSCLK source. The PLLC1 OBSCLK signal may be selected as the output on the CLKOUT pin. The OSDIV is shown in [Figure 7-23](#) and described in [Table 7-25](#).

Figure 7-23. PLLC1 Oscillator Divider 1 Register (OSCDIV)

31	Reserved				16
R-0					
15	14			5	4
OD1EN	Reserved			RATIO	
R/W-1	R-0			R/W-0	

LEGEND: R/W = Read/Write; R = Read only; -n = value after reset

Table 7-25. PLLC1 Oscillator Divider 1 Register (OSCDIV) Field Descriptions

Bit	Field	Value	Description
31-16	Reserved	0	Reserved
15	OD1EN	0	Oscillator divider 1 is disabled.
		1	Oscillator divider 1 is enabled. For PLLC1 OBSCLK to toggle, both the OD1EN bit and the OBSEN bit in the PLLC1 clock enable control register (CKEN) must be set to 1.
14-5	Reserved	0	Reserved
4-0	RATIO	0-1Fh	Divider ratio. Divider value = RATIO + 1. For example, RATIO = 0 means divide by 1.

7.3.23 PLL Post-Divider Control Register (POSTDIV)

The PLL post-divider control register (POSTDIV) is shown in [Figure 7-24](#) and described in [Table 7-26](#).

Figure 7-24. PLL Post-Divider Control Register (POSTDIV)

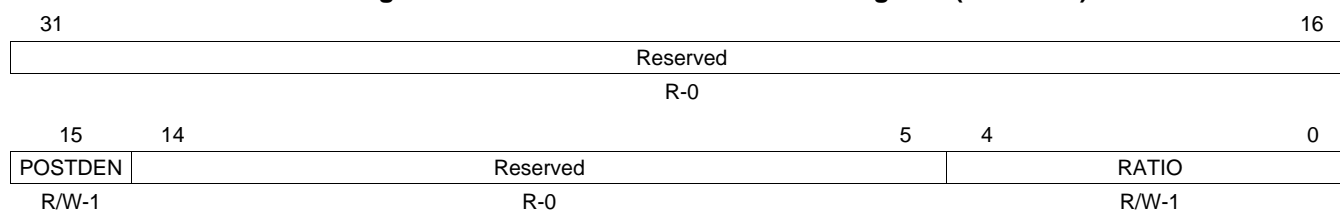

LEGEND: R/W = Read/Write; R = Read only; -n = value after reset

Table 7-26. PLL Post-Divider Control Register (POSTDIV) Field Descriptions

Bit	Field	Value	Description
31-16	Reserved	0	Reserved
15	POSTDEN	0	Post-divider is disabled.
		1	Post-divider is enabled.
14-5	Reserved	0	Reserved
4-0	RATIO	0-1Fh	Divider ratio. Divider Value = RATIO + 1. RATIO defaults to 1 (PLL post-divide by 2).

7.3.24 PLL Controller Command Register (PLLCMD)

The PLL controller command register (PLLCMD) contains the command bit for phase alignment. A write of 1 initiates the command; a write of 0 clears the bit, but has no effect. PLLCMD is shown in [Figure 7-25](#) and described in [Table 7-27](#).

Figure 7-25. PLL Controller Command Register (PLLCMD)

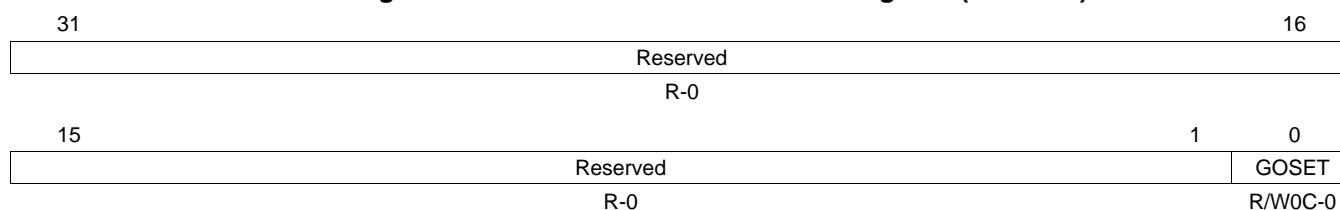

LEGEND: R/W = Read/Write; R = Read only; W0C = Write 0 to clear bit; -n = value after reset

Table 7-27. PLL Controller Command Register (PLLCMD) Field Descriptions

Bit	Field	Value	Description
31-1	Reserved	0	Reserved
0	GOSET	0	Clear bit (no effect)
		1	Phase alignment

7.3.25 PLL Controller Status Register (PLLSTAT)

The PLL controller status register (PLLSTAT) is shown in [Figure 7-26](#) and described in [Table 7-28](#).

Figure 7-26. PLL Controller Status Register (PLLSTAT)

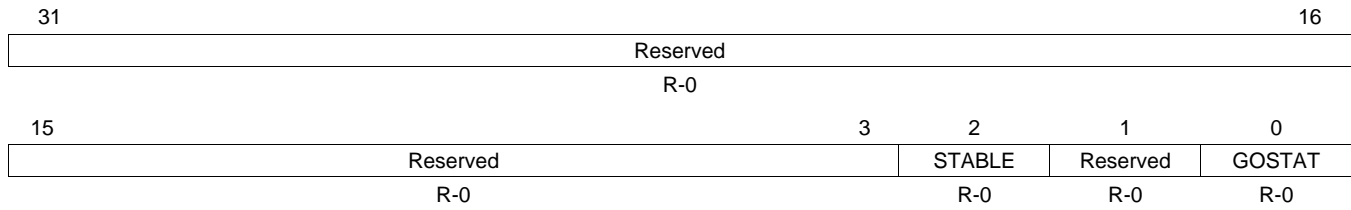

LEGEND: R = Read only; -n = value after reset

Table 7-28. PLL Controller Status Register (PLLSTAT) Field Descriptions

Bit	Field	Value	Description
31-3	Reserved	0	Reserved
2	STABLE	0 1	OSC counter done, oscillator assumed to be stable. By the time the device comes out of reset, this bit should become 1. No Yes
1	Reserved	0	Reserved
0	GOSTAT	0 1	Status of GO operation. If 1, indicates GO operation is in progress. GO operation is not in progress. GO operation is in progress.

7.3.26 PLLC0 Clock Align Control Register (ALNCTL)

The PLLC0 clock align control register (ALNCTL) indicates which PLL0_SYSCLK n needs to be aligned for proper device operation. ALNCTL is shown in [Figure 7-27](#) and described in [Table 7-29](#).

Figure 7-27. PLLC0 Clock Align Control Register (ALNCTL)

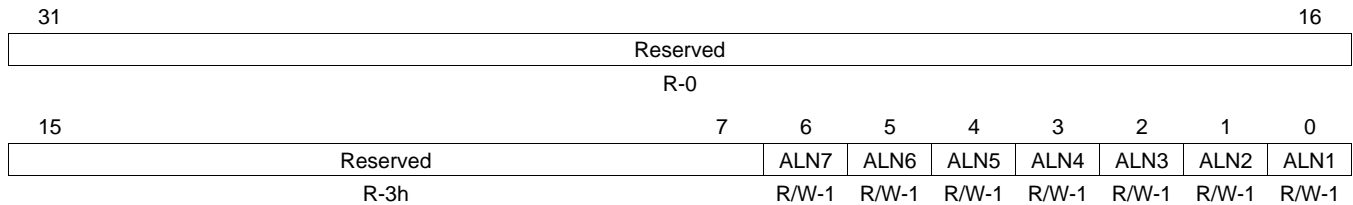

LEGEND: R/W = Read/Write; R = Read only; - n = value after reset

Table 7-29. PLLC0 Clock Align Control Register (ALNCTL) Field Descriptions

Bit	Field	Value	Description
31-7	Reserved	3h	Reserved
6	ALN7	0 1	PLL0_SYSCLK7 needs to be aligned to others selected in this register. No Yes
5	ALN6	0 1	PLL0_SYSCLK6 needs to be aligned to others selected in this register. No Yes
4	ALN5	0 1	PLL0_SYSCLK5 needs to be aligned to others selected in this register. No Yes
3	ALN4	0 1	PLL0_SYSCLK4 needs to be aligned to others selected in this register. No Yes
2	ALN3	0 1	PLL0_SYSCLK3 needs to be aligned to others selected in this register. No Yes
1	ALN2	0 1	PLL0_SYSCLK2 needs to be aligned to others selected in this register. No Yes
0	ALN1	0 1	PLL0_SYSCLK1 needs to be aligned to others selected in this register. No Yes

7.3.27 PLLC1 Clock Align Control Register (ALNCTL)

The PLLC1 clock align control register (ALNCTL) indicates which PLL1_SYSCLK n needs to be aligned for proper device operation. ALNCTL is shown in [Figure 7-28](#) and described in [Table 7-30](#).

Figure 7-28. PLLC1 Clock Align Control Register (ALNCTL)

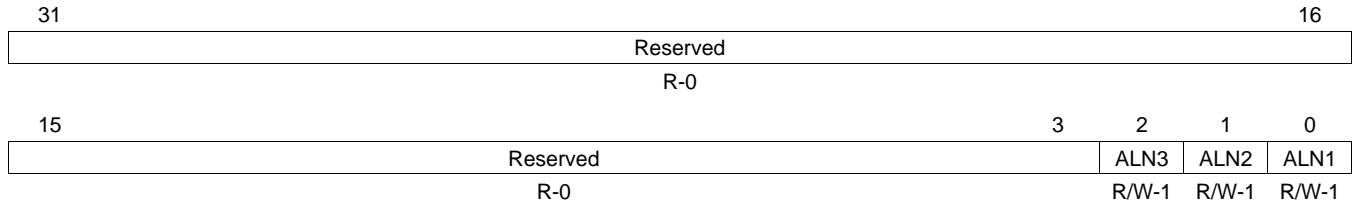

LEGEND: R/W = Read/Write; R = Read only; - n = value after reset

Table 7-30. PLLC1 Clock Align Control Register (ALNCTL) Field Descriptions

Bit	Field	Value	Description
31-3	Reserved	0	Reserved
2	ALN3	0 1	PLL1_SYSCLK3 needs to be aligned to others selected in this register. No Yes
1	ALN2	0 1	PLL1_SYSCLK2 needs to be aligned to others selected in this register. No Yes
0	ALN1	0 1	PLL1_SYSCLK1 needs to be aligned to others selected in this register. No Yes

7.3.28 PLLC0 PLLDIV Ratio Change Status Register (DCHANGE)

The PLLC0 PLLDIV ratio change status register (DCHANGE) indicates if the PLL0_SYSCCLK n divide ratio has been modified. DCHANGE is shown in [Figure 7-29](#) and described in [Table 7-31](#).

Figure 7-29. PLLC0 PLLDIV Ratio Change Status Register (DCHANGE)

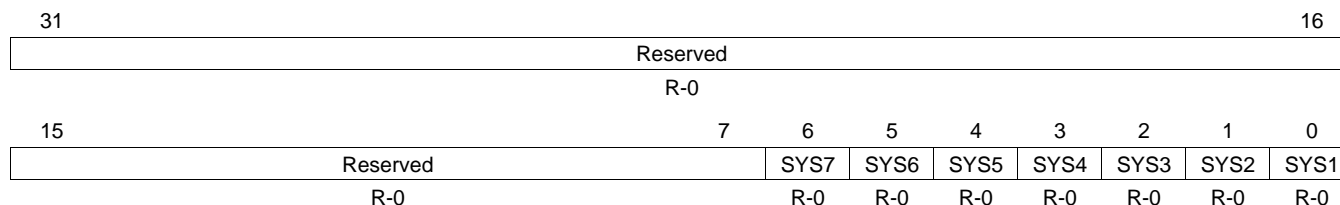

LEGEND: R = Read only; - n = value after reset

Table 7-31. PLLC0 PLLDIV Ratio Change Status Register (DCHANGE) Field Descriptions

Bit	Field	Value	Description
31-7	Reserved	0	Reserved
6	SYS7	0	PLL0_SYSCCLK7 divide ratio is modified. Ratio is not modified.
		1	Ratio is modified.
5	SYS6	0	PLL0_SYSCCLK6 divide ratio is modified. Ratio is not modified.
		1	Ratio is modified.
4	SYS5	0	PLL0_SYSCCLK5 divide ratio is modified. Ratio is not modified.
		1	Ratio is modified.
3	SYS4	0	PLL0_SYSCCLK4 divide ratio is modified. Ratio is not modified.
		1	Ratio is modified.
2	SYS3	0	PLL0_SYSCCLK3 divide ratio is modified. Ratio is not modified.
		1	Ratio is modified.
1	SYS2	0	PLL0_SYSCCLK2 divide ratio is modified. Ratio is not modified.
		1	Ratio is modified.
0	SYS1	0	PLL0_SYSCCLK1 divide ratio is modified. Ratio is not modified.
		1	Ratio is modified.

7.3.29 PLLC1 PLLDIV Ratio Change Status Register (DCHANGE)

The PLLC1 PLLDIV ratio change status register (DCHANGE) indicates if the PLL1_SYSCCLK n divide ratio has been modified. DCHANGE is shown in [Figure 7-30](#) and described in [Table 7-32](#).

Figure 7-30. PLLC1 PLLDIV Ratio Change Status Register (DCHANGE)

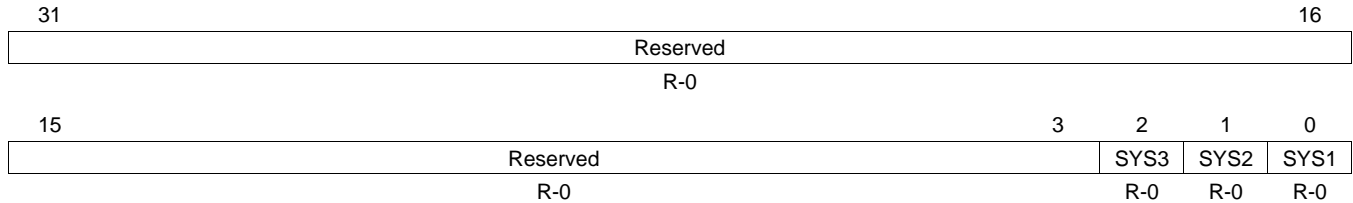

LEGEND: R = Read only; - n = value after reset

Table 7-32. PLLC1 PLLDIV Ratio Change Status Register (DCHANGE) Field Descriptions

Bit	Field	Value	Description
31-3	Reserved	0	Reserved
2	SYS3	0	PLL1_SYSCCLK3 divide ratio is modified.
		1	Ratio is not modified.
1	SYS2	0	PLL1_SYSCCLK2 divide ratio is modified.
		1	Ratio is not modified.
0	SYS1	0	PLL1_SYSCCLK1 divide ratio is modified.
		1	Ratio is not modified.

7.3.30 PLLC0 Clock Enable Control Register (CKEN)

The PLLC0 clock enable control register (CKEN) controls the PLLC0 OBSCLK and AUXCLK clock. CKEN is shown in [Figure 7-31](#) and described in [Table 7-33](#).

Figure 7-31. PLLC0 Clock Enable Control Register (CKEN)

31	Reserved			16	
R-0					
15	Reserved		2	1	0
R-0			R/W-1	R/W-1	R/W-1

LEGEND: R/W = Read/Write; R = Read only; -n = value after reset

Table 7-33. PLLC0 Clock Enable Control Register (CKEN) Field Descriptions

Bit	Field	Value	Description
31-2	Reserved	0	Reserved
1	OBSEN	0 1	OBSCLK enable. Actual PLLC0 OBSCLK status is shown in the PLLC0 clock status register (CKSTAT). PLL0 OBSCLK is disabled. PLL0 OBSCLK is enabled. For PLLC0 OBSCLK to toggle, both the OBSEN bit and the OD1EN bit in the PLLC0 oscillator divider 1 register (OSCDIV) must be set to 1.
0	AUXEN	0 1	AUXCLK enable. Actual PLLC0 AUXCLK status is shown in the PLLC0 clock status register (CKSTAT). PLL0 AUXCLK is disabled. PLL0 AUXCLK is enabled.

7.3.31 PLLC1 Clock Enable Control Register (CKEN)

The PLLC1 clock enable control register (CKEN) controls the PLLC1 OBSCLK clock. CKEN is shown in [Figure 7-32](#) and described in [Table 7-34](#).

Figure 7-32. PLLC1 Clock Enable Control Register (CKEN)

31	Reserved			16	
R-0					
15	Reserved		2	1	0
R-0			R/W-0	R-0	R-0

LEGEND: R/W = Read/Write; R = Read only; -n = value after reset

Table 7-34. PLLC1 Clock Enable Control Register (CKEN) Field Descriptions

Bit	Field	Value	Description
31-2	Reserved	0	Reserved
1	OBSEN	0 1	OBSCLK enable. Actual PLLC1 OBSCLK status is shown in the PLLC1 clock status register (CKSTAT). PLL1 OBSCLK is disabled. PLL1 OBSCLK is enabled. For PLLC1 OBSCLK to toggle, both the OBSEN bit and the OD1EN bit in the PLLC1 oscillator divider 1 register (OSCDIV) must be set to 1.
0	Reserved	0	Reserved

7.3.32 PLLC0 Clock Status Register (CKSTAT)

The PLLC0 clock status register (CKSTAT) indicates the PLLC0 OBSCLK and AUXCLK on/off status. The PLL0_SYSCLK status is shown in the PLLC0 SYSCLK status register (SYSTAT). CKSTAT is shown in [Figure 7-33](#) and described in [Table 7-35](#).

Figure 7-33. PLLC0 Clock Status Register (CKSTAT)

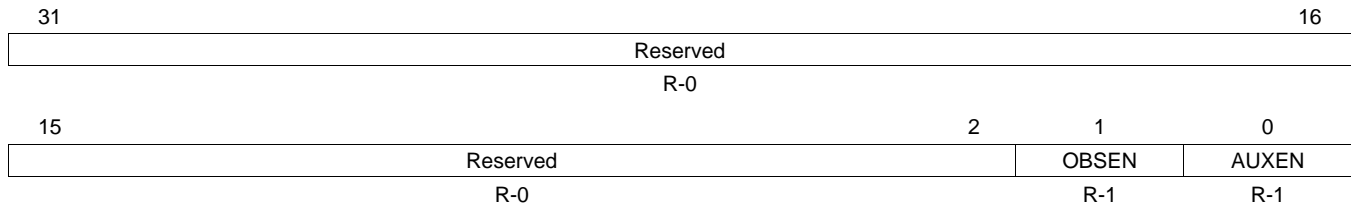

LEGEND: R = Read only; -n = value after reset

Table 7-35. PLLC0 Clock Status Register (CKSTAT) Field Descriptions

Bit	Field	Value	Description
31-2	Reserved	0	Reserved
1	OBSEN	0	OBSCCLK on status. PLLC0 OBSCCLK is controlled in the PLLC0 oscillator divider 1 register (OSCDIV) by the OBSEN bit in the PLLC0 clock enable control register (CKEN). PLL0 OBSCCLK is off.
		1	PLL0 OBSCCLK is on.
0	AUXEN	0	AUXCLK on status. PLLC0 AUXCLK is controlled by the AUXEN bit in the PLLC0 clock enable control register (CKEN). PLL0 AUXCLK is off.
		1	PLL0 AUXCLK is on.

7.3.33 PLLC1 Clock Status Register (CKSTAT)

The PLLC1 clock status register (CKSTAT) indicates the PLLC1 OBSCLK on/off status. The PLL1_SYSCLK status is shown in the PLLC1 SYSCLK status register (SYSTAT). CKSTAT is shown in [Figure 7-34](#) and described in [Table 7-36](#).

Figure 7-34. PLLC1 Clock Status Register (CKSTAT)

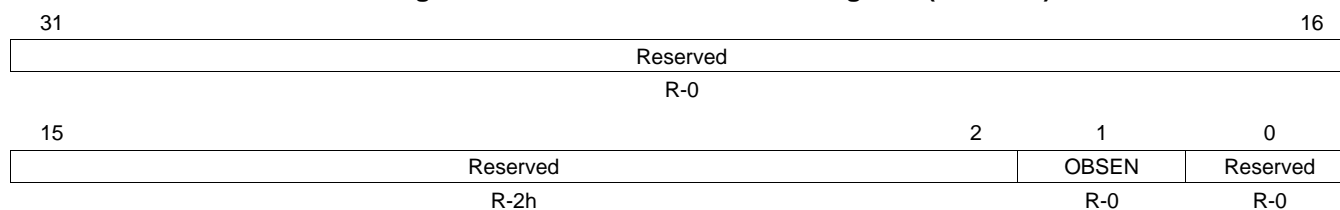

LEGEND: R = Read only; -n = value after reset

Table 7-36. PLLC1 Clock Status Register (CKSTAT) Field Descriptions

Bit	Field	Value	Description
31-2	Reserved	0	Reserved
1	OBSEN	0	OBSClk on status. PLLC1 OBSClk is controlled in the PLLC1 oscillator divider 1 register (OSCDIV) by the OBSEN bit in the PLLC1 clock enable control register (CKEN).
		1	OBSClk is off.
		1	OBSClk is on.
0	Reserved	0	Reserved

7.3.34 PLLC0 SYSCLK Status Register (SYSTAT)

The PLLC0 SYSCLK status register (SYSTAT) indicates the PLL0_SYSCLK_n on/off status. The actual default is determined by the actual clock on/off status, which depends on the D_nEN bit in PLLC0 PLLDIV_n. SYSTAT is shown in [Figure 7-35](#) and described in [Table 7-37](#).

Figure 7-35. PLLC0 SYSCLK Status Register (SYSTAT)

	Reserved						
	R-1						
7	6	5	4	3	2	1	0
Reserved	SYS7ON	SYS6ON	SYS5ON	SYS4ON	SYS3ON	SYS2ON	SYS1ON
R-1	R-1	R-1	R-1	R-1	R-1	R-1	R-1

LEGEND: R/W = Read/Write; R = Read only; -n = value after reset

Table 7-37. PLLC0 SYSCLK Status Register (SYSTAT) Field Descriptions

Bit	Field	Value	Description
31-7	Reserved	3h	Reserved
6	SYS7ON	0 1	PLL0_SYSCLK7 on status. Off On
5	SYS6ON	0 1	PLL0_SYSCLK6 on status. Off On
4	SYS5ON	0 1	PLL0_SYSCLK5 on status. Off On
3	SYS4ON	0 1	PLL0_SYSCLK4 on status. Off On
2	SYS3ON	0 1	PLL0_SYSCLK3 on status. Off On
1	SYS2ON	0 1	PLL0_SYSCLK2 on status. Off On
0	SYS1ON	0 1	PLL0_SYSCLK1 on status. Off On

7.3.35 PLLC1 SYSCLK Status Register (SYSTAT)

The PLLC1 SYSCLK status register (SYSTAT) indicates the PLL1_SYSCLK n on/off status. The actual default is determined by the actual clock on/off status, which depends on the D n EN bit in PLLC1 PLLDIV n . SYSTAT is shown in [Figure 7-36](#) and described in [Table 7-38](#).

Figure 7-36. PLLC1 SYSCLK Status Register (SYSTAT)

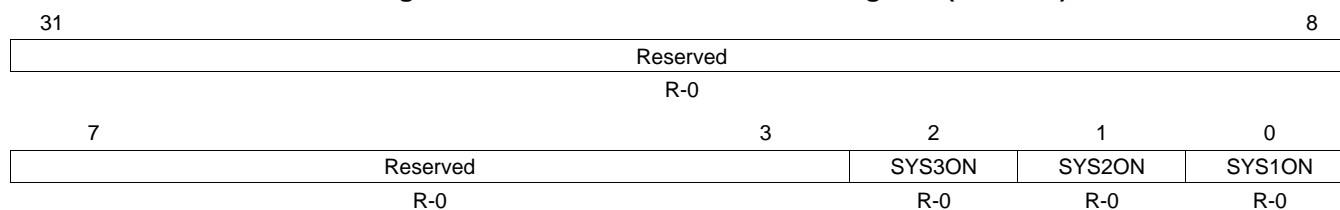

LEGEND: R/W = Read/Write; R = Read only; - n = value after reset

Table 7-38. PLLC1 SYSCLK Status Register (SYSTAT) Field Descriptions

Bit	Field	Value	Description
31-3	Reserved	0	Reserved
2	SYS3ON	0 1	PLL1_SYSCLK3 on status. Off On
1	SYS2ON	0 1	PLL1_SYSCLK2 on status. Off On
0	SYS1ON	0 1	PLL1_SYSCLK1 on status. Off On

7.3.36 Emulation Performance Counter 0 Register (EMUCNT0)

The emulation performance counter 0 register (EMUCNT0) is shown in [Figure 7-37](#) and described in [Table 7-39](#). EMUCNT0 is for emulation performance profiling. It counts in a divide-by-4 of the system clock. To start the counter, a write must be made to EMUCNT0. This register is not writable, but only used to start the register. After the register is started, it can not be stopped except for power on reset. When EMUCNT0 is read, it snapshots EMUCNT0 and EMUCNT1. The snapshot version is what is read. It is important to read the EMUCNT0 followed by EMUCNT1 or else the snapshot version may not get updated correctly.

Figure 7-37. Emulation Performance Counter 0 Register (EMUCNT0)

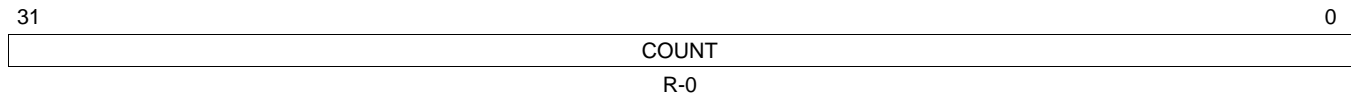

LEGEND: R = Read only; -n = value after reset

Table 7-39. Emulation Performance Counter 0 Register (EMUCNT0) Field Descriptions

Bit	Field	Value	Description
31-0	COUNT	0-FFFF FFFFh	Counter value for lower 64-bits.

7.3.37 Emulation Performance Counter 1 Register (EMUCNT1)

The emulation performance counter 1 register (EMUCNT1) is shown in [Figure 7-38](#) and described in [Table 7-40](#). EMUCNT1 is for emulation performance profiling. To start the counter, a write must be made to EMUCNT0. This register is not writable, but only used to start the register. After the register is started, it can not be stopped except for power on reset. When EMUCNT0 is read, it snapshots EMUCNT0 and EMUCNT1. The snapshot version is what is read. It is important to read the EMUCNT0 followed by EMUCNT1 or else the snapshot version may not get updated correctly.

Figure 7-38. Emulation Performance Counter 1 Register (EMUCNT1)

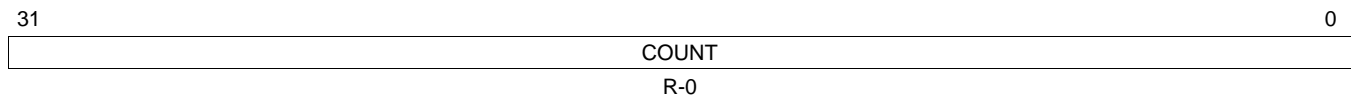

LEGEND: R = Read only; -n = value after reset

Table 7-40. Emulation Performance Counter 1 Register (EMUCNT1) Field Descriptions

Bit	Field	Value	Description
31-0	COUNT	0-FFFF FFFFh	Counter value for upper 64-bits.

Power and Sleep Controller (PSC)

Topic	Page
8.1 Introduction	106
8.2 Power Domain and Module Topology	106
8.3 Executing State Transitions	111
8.4 IcePick Emulation Support in the PSC	112
8.5 PSC Interrupts	112
8.6 PSC Registers	115

8.1 Introduction

The Power and Sleep Controllers (PSC) are responsible for managing transitions of system power on/off, clock on/off, resets (device level and module level). It is used primarily to provide granular power control for on chip modules (peripherals and CPU). A PSC module consists of a Global PSC (GPSC) and a set of Local PSCs (LPSCs). The GPSC contains memory mapped registers, PSC interrupts, a state machine for each peripheral/module it controls. An LPSC is associated with every module that is controlled by the PSC and provides clock and reset control. Many of the operations of the PSC are transparent to user (software), such as power on and reset control. However, the PSC module(s) also provide you with interface to control several important power, clock and reset operations. The module level power, clock and reset operations managed and controlled by the PSC are the focus of this chapter.

The PSC includes the following features:

- Manages chip power-on/off
- Provides a software interface to:
 - Control module clock enable/disable
 - Control module reset
 - Control CPU local reset
- Manages on-chip RAM sleep modes (for L3 RAM)
- Supports IcePick emulation features: power, clock and reset

8.2 Power Domain and Module Topology

This device includes two PSC modules. Each PSC module consists of an Always On power domain and an additional pseudo/internal power domain that manages the sleep modes for the RAMs present in the L3 RAM.

Each PSC module controls clock states for several on the on chip modules, controllers and interconnect components. [Table 8-1](#) and [Table 8-2](#) lists the set of peripherals/modules that are controlled by the PSC, the power domain they are associated with, the LPSC assignment and the default (power-on reset) module states. See the device-specific data manual for the peripherals available on a given device. The module states and terminology are defined in [Section 8.2.2](#).

Even though there are 2 PSC modules with 2 power domains each on the device, both PSC modules and all the power domains are powered by the CVDD pins of the device. All power domains are on when the chip is powered on. There is no provision to remove power externally for the non Always On domains, that is, the pseudo/internal power domains.

There are a few modules/peripherals on the device that do not have an LPSC assigned to them. These modules do not have their module reset/clocks controlled by the PSC module. The decision to assign an LPSC to a module on a device is primarily based on whether or not disabling the clocks to a module will result in significant power savings. This typically depends on the size and the frequency of operation of the module.

NOTE: There are no LPSCs for peripherals in the Async2 clock domain (this includes RTC, Timer64P0/P1, and I2C0); from a power savings stand point, clock-gating these peripherals does not result in significant power savings.

Table 8-1. PSC0 Default Module Configuration

LPSC Number	Module Name	Power Domain	Default Module State	Auto Sleep/Wake Only
0	EDMA3_0 Channel Controller 0	AlwaysON (PD0)	SwRstDisable	—
1	EDMA3_0 Transfer Controller 0	AlwaysON (PD0)	SwRstDisable	—
2	EDMA3_0 Transfer Controller 1	AlwaysON (PD0)	SwRstDisable	—
3	EMIFA (BR7)	AlwaysON (PD0)	SwRstDisable	—
4	SPI0	AlwaysON (PD0)	SwRstDisable	—
5	MMC/SD0	AlwaysON (PD0)	SwRstDisable	—
6	ARM Interrupt Controller	AlwaysON (PD0)	Enable	—
7	ARM RAM/ROM	AlwaysON (PD0)	Enable	Yes
8	Not Used	—	—	—
9	UART0	AlwaysON (PD0)	SwRstDisable	—
10	SCR0 (BR0, BR1, BR2, BR8)	AlwaysON (PD0)	Enable	Yes
11	SCR1 (BR4)	AlwaysON (PD0)	Enable	Yes
12	SCR2 (BR3, BR5, BR6)	AlwaysON (PD0)	Enable	Yes
13	PRU	AlwaysON (PD0)	SwRstDisable	—
14	ARM	AlwaysON (PD0)	SwRstDisable	—
15	Not Used	—	—	—

Table 8-2. PSC1 Default Module Configuration

LPSC Number	Module Name	Power Domain	Default Module State	Auto Sleep/Wake Only
0	EDMA3_1 Channel Controller 0	AlwaysON (PD0)	SwRstDisable	—
1	USB0 (USB2.0)	AlwaysON (PD0)	SwRstDisable	—
2	Not Used	—	—	—
3	GPIO	AlwaysON (PD0)	SwRstDisable	—
4	HPI	AlwaysON (PD0)	SwRstDisable	—
5	Not Used	—	—	—
6	DDR2/mDDR	AlwaysON (PD0)	SwRstDisable	—
7	McASP0 (+ McASP0 FIFO)	AlwaysON (PD0)	SwRstDisable	—
8	Not Used	—	—	—
9	VPIF	AlwaysON (PD0)	SwRstDisable	—
10	SPI1	AlwaysON (PD0)	SwRstDisable	—
11	I2C1	AlwaysON (PD0)	SwRstDisable	—
12	UART1	AlwaysON (PD0)	SwRstDisable	—
13	UART2	AlwaysON (PD0)	SwRstDisable	—
14	McBSP0 (+ McBSP0 FIFO)	AlwaysON (PD0)	SwRstDisable	—
15	McBSP1 (+ McBSP1 FIFO)	AlwaysON (PD0)	SwRstDisable	—
16	LCDC	AlwaysON (PD0)	SwRstDisable	—
17	eHRPWM0/1	AlwaysON (PD0)	SwRstDisable	—
18	MMC/SD1	AlwaysON (PD0)	SwRstDisable	—
19	uPP	AlwaysON (PD0)	SwRstDisable	—
20	eCAP0/1/2	AlwaysON (PD0)	SwRstDisable	—
21	EDMA3_1 Transfer Controller 0	AlwaysON (PD0)	SwRstDisable	—
22-23	Not Used	—	—	—
24	SCR F0	AlwaysON (PD0)	Enable	Yes
25	SCR F1	AlwaysON (PD0)	Enable	Yes

Table 8-2. PSC1 Default Module Configuration (continued)

LPSC Number	Module Name	Power Domain	Default Module State	Auto Sleep/Wake Only
26	SCR F2	AlwaysON (PD0)	Enable	Yes
27	SCR F6	AlwaysON (PD0)	Enable	Yes
28	SCR F7	AlwaysON (PD0)	Enable	Yes
29	SCR F8	AlwaysON (PD0)	Enable	Yes
30	BR F7	AlwaysON (PD0)	Enable	Yes
31	On-chip RAM	PD_SHRAM	Enable	—

8.2.1 Power Domain States

A power domain can only be in one of the two states: ON or OFF, defined as follows:

- ON: power to the domain is on
- OFF: power to the domain is off

In this device, for both PSC0 and PSC1, the Always ON domain (or PD0 power domain), is always in the ON state when the chip is powered-on. This domain is not programmable to OFF state (See details on PDCTL register).

Additionally, for both PSC0 and PSC1, the PD1 power domains, the internal/pseudo power domain can either be in the ON state or OFF state. Furthermore, for these power domains the transition from ON to OFF state is further qualified by the PSC0/1.PDCTL1.PDMODE settings. The PDCTL1.PDMODE settings determines the various sleep mode for the on-chip RAM associated with module in the PD1 domain.

- On PSC1 PD1/PD_SHRAM Domain: Controls the sleep state for the 128KB On-chip RAM

NOTE: Currently programming the PD1 power domain state to OFF is not supported. You should leave both the PDCTL1.NEXT and PDCTL1.PDMODE values at default/power on reset values.

Both PD0 and PD1 power domains in PSC0 and PSC1 are powered by the CVDD pins of the device. There is no capability to individually remove voltage/power from the on-chip RAM power domains.

8.2.2 Module States

The PSC defines several possible states for a module. These various states are essentially a combination of the module reset asserted or de-asserted and module clock on/enabled or off/disabled. The various module states are defined in [Table 8-3](#).

The key difference between the Auto Sleep and Auto Wake states is that once the module is configured in Auto Sleep mode, it will transition back to the clock disabled state (automatically sleep) after servicing the internal read/write access request where as in Auto Wake mode, on receiving the first internal read/write access request, the module will permanently transition from the clock disabled to clock enabled state (automatically wake).

When the module state is programmed to Disable, SwRstDisable, Auto Sleep or Auto Wake modes, where in the module clocks are off/disabled, an external event or I/O request cannot enable the clocks. For the module to appropriately respond to such external request, it would need to be reconfigured to the Enable state.

8.2.2.1 Auto Sleep/Wake Only Configurations and Limitation

NOTE: Currently no modules should be configured in Auto Sleep or Auto Wake modes. If the module clocks need to be gated/disabled for power savings, you should program the module state to Disable. For Auto Sleep/Auto Wake Only modules, disabling the clock is not supported and they should be kept in their default "Enable" state.

[Table 8-1](#) and [Table 8-2](#) each have a column to indicate whether or not the LPSC configuration for a module is Auto Sleep/Wake Only. Modules that have a "Yes" marked for the Auto Sleep/Wake Only column can be programmed in software to be in Enable, Auto Sleep and Auto Wake states only; that is, if the software tries to program these modules to Disable, SyncReset, or SwRstDisable state the power sleep controller ignores these transition requests and transitions the module state to Enable.

8.2.2.2 Local Reset

In addition to module reset, the following module can be reset using a special local reset that is also a part of the PSC module control for resets.

- **ARM:** When the ARM local reset is asserted the entire ARM processor is reset, including cache etc. This does not include the ARM RAM/ROM or ARM interrupt controller module as these exist outside the ARM core. The local reset for ARM additionally ensures that any outstanding requests are completed before ARM is reset, therefore for scenarios where it is needed to just reset the ARM locally but not change the state of clocks, user can use ARM local reset feature.

The procedures for asserting and de-asserting the local reset are as follows (where n corresponds to the module that supports local reset):

1. Clear the LRST bit in the module control register (MDCTL n) to 0 to assert the module's local reset.
2. Set the LRST bit in the module control register (MDCTL n) to 1 to de-assert module's local reset.

If the CPU is in the enable state, it immediately executes program instructions after reset is de-asserted.

Table 8-3. Module States

Module State	Module Reset	Module Clock	Module State Definition
Enable	De-asserted	On	A module in the enable state has its module reset de-asserted and it has its clock on. This is the normal operational state for a given module
Disable	De-asserted	Off	A module in the disabled state has its module reset de-asserted and it has its module clock off. This state is typically used for disabling a module clock to save power. This device is designed in full static CMOS, so when you stop a module clock, it retains the module's state. When the clock is restarted, the module resumes operating from the stopping point.
SyncReset	Asserted	On	A module state in the SyncReset state has its module reset asserted and it has its clock on. Generally, software is not expected to initiate this state
SwRstDisable	Asserted	Off	A module in the SwResetDisable state has its module reset asserted and it has its clock disabled. After initial power-on, several modules come up in the SwRstDisable state. Generally, software is not expected to initiate this state
Auto Sleep	De-asserted	Off	A module in the Auto Sleep state also has its module reset de-asserted and its module clock disabled, similar to the Disable state. However this is a special state, once a module is configured in this state by software, it can "automatically" transition to "Enable" state whenever there is an internal read/write request made to it, and after servicing the request it will "automatically" transition into the sleep state (with module reset re de-asserted and module clock disabled), without any software intervention. The transition from sleep to enabled and back to sleep state has some cycle latency associated with it. It is not envisioned to use this mode when peripherals are fully operational and moving data. See Section 8.2.2.1 for additional considerations, constraints, limitations around this mode.
Auto Wake	De-asserted	Off	A module in the Auto Wake state also has its module reset de-asserted and its module clock disabled, similar to the Disable state. However this is a special state, once a module is configured in this state by software, it will "automatically" transition to "Enable" state whenever there is an internal read/write request made to it, and will remain in the "Enabled" state from then on (with module reset re de-asserted and module clock on), without any software intervention. The transition from sleep to enabled state has some cycle latency associated with it. It is not envisioned to use this mode when peripherals are fully operational and moving data. See Section 8.2.2.1 for additional considerations, constraints, limitations around this mode.

8.3 Executing State Transitions

This section describes how to execute the state transitions modules.

8.3.1 Power Domain State Transitions

This device consists of 2 types of domain (in each PSC controller): the Always On Domain(s) and the pseudo/RAM power domain(s). The Always On power domains are always in the ON state when the chip is powered on. You are not allowed to change the power domain state to OFF.

The pseudo/RAM power domains allow internally powering down the state of the RAMs associated with these domains (On-chip RAM for PD_SHRAM in PSC1) so that these RAMs can run in lower power sleep modes via the power sleep controller.

NOTE: Currently powering down the RAMs via the pseudo/RAM power domain is not supported; therefore, these domains and the RAM should be left in their default power on state.

As mentioned in [Section 8.2](#), the pseudo/RAM power domains are powered down internally, and in this context powering down does not imply removing the core voltage from pins externally.

8.3.2 Module State Transitions

This section describes the procedure for transitioning the module state (clock and reset control). Note that some peripherals have special programming requirements and additional recommended steps you must take before you can invoke the PSC module state transition. See the individual peripheral user guides for more details. For example, the external memory controller requires that you first place the SDRAM memory in self-refresh mode before you invoke the PSC module state transitions, if you want to maintain the memory contents.

The following procedure is directly applicable for all modules that are controlled via the PSC (shown in [Table 8-1](#) and [Table 8-2](#)), except for the core(s). To transition the ARM module state, there are additional system considerations and constraints that you should be aware of. These system considerations and the procedure for transitioning the ARM module state are described in details in [Chapter 9](#).

NOTE: In the following procedure, x is 0 for modules in PD0 (Power Domain 0 or Always On domain) and x is 1 for modules in PD1 (Power Domain 1). See [Table 8-1](#) and [Table 8-2](#) for power domain associations.

The procedure for module state transitions is:

1. Wait for the GOSTAT[x] bit in PTSTAT to clear to 0. You must wait for any previously initiated transitions to finish before initiating a new transition.
2. Set the NEXT bit in MDCTL_n to SwRstDisable (0), SyncReset (1), Disable (2h), Enable (3h), Auto Sleep (4h) or Auto Wake (5h).

NOTE: You may set transitions in multiple NEXT bits in MDCTL_n in this step. Transitions do not actually take place until you set the GO[x] bit in PTCMD in a later step.

3. Set the GO[x] bit in PTCMD to 1 to initiate the transition(s).
4. Wait for the GOSTAT[x] bit in PTSTAT to clear to 0. The modules are safely in the new states only after the GOSTAT[x] bit in PTSTAT is cleared to 0.

8.4 IcePick Emulation Support in the PSC

The PSC supports IcePick commands that allow IcePick emulation tools to have some control over the state of power domains and modules.

- ARM [MDCTL14]

In particular, [Table 8-4](#) shows IcePick emulation commands recognized by the PSC.

Table 8-4. IcePick Emulation Commands

Power On and Enable Features	Power On and Enable Descriptions	Reset Features	Reset Descriptions
Inhibit Sleep	Allows emulation to prevent software from transitioning the module out of the enable state.	Assert Reset	Allows emulation to assert the module's local reset.
Force Power	Allows emulation to force the power domain into an on state. Not applicable as AlwaysOn power domain is always on.	Wait Reset	Allows emulation to keep local reset asserted for an extended period of time after software initiates local reset de-assert.
Force Active	Allows emulation to force the module into the enable state.	Block Reset	Allows emulation to block software initiated local and module resets.

NOTE: When emulation tools remove the above commands, the PSC immediately executes a state transition based on the current values in the NEXT bit in PDCTL0 and the NEXT bit in MDCTL n , as set by software.

8.5 PSC Interrupts

The PSC has an interrupt that is tied to the core interrupt controller. This interrupt is named PSCINT in the interrupt map. The PSC interrupt is generated when certain IcePick emulation events occur.

8.5.1 Interrupt Events

The PSC interrupt is generated when any of the following events occur:

- Power Domain Emulation Event (applies to pseudo/RAM power domain only)
- Module State Emulation event
- Module Local Reset Emulation event

These interrupt events are summarized in [Table 8-5](#) and described in more detail in this section.

Table 8-5. PSC Interrupt Events

Interrupt Enable Bits		
Control Register	Enable Bit	Interrupt Condition
PDCTL n	EMUHIBIE	Interrupt occurs when the emulation alters the power domain state
MDCTL n	EMUHIBIE	Interrupt occurs when the emulation alters the module state
MDCTL n	EMURSTIE	Interrupt occurs when the emulation tries to alter the module's local reset

The PSC interrupt events only apply when IcePick emulation alters the state of the module from the user-programmed state in the NEXT bit in the MDCTL/PDCTL registers. IcePick support only applies to the modules listed in [Section 8.4](#); therefore, the PSC interrupt conditions only apply to those modules listed.

8.5.1.1 Power Domain Emulation Events

A power domain emulation event occurs when emulation alters the state of a power domain (does not apply to the Always On domain). Status is reflected in the EMUIHB bit in PDSTAT n . In particular, a power domain emulation event occurs under the following conditions:

- When inhibit sleep is asserted by emulation and software attempts to transition the module out of the on state
- When force power is asserted by emulation and power domain is not already in the on state
- When force active is asserted by emulation and power domain is not already in the on state

8.5.1.2 Module State Emulation Events

A module state emulation event occurs when emulation alters the state of a module. Status is reflected in the EMUIHB bit in the module status register (MDSTAT n). In particular, a module state emulation event occurs under the following conditions:

- When inhibit sleep is asserted by emulation and software attempts to transition the module out of the enable state
- When force active is asserted by emulation and module is not already in the enable state

8.5.1.3 Local Reset Emulation Events

A local reset emulation event occurs when emulation alters the local reset of a module. Status is reflected in the EMURST bit in the module status register (MDSTAT n). In particular, a module local reset emulation event occurs under the following conditions:

- When assert reset is asserted by emulation although software de-asserted the local reset
- When wait reset is asserted by emulation
- When block reset is asserted by emulation and software attempts to change the state of local reset

8.5.2 Interrupt Registers

The PSC interrupt enable bits are: the EMUIHBIE bit in PDCTL1 (PSC0), the EMUIHBIE and the EMURSTIE bits in MDCTL n (where n is the modules that have IcePick emulation support, as specified in [Section 8.4](#)).

NOTE: To interrupt the CPU, the power sleep controller interrupt (PSC0_ALLINT and PSC1_ALLINT) must also be enabled appropriately in the ARM interrupt controller. For details on the ARM interrupt controller, see [Chapter 11](#).

The PSC interrupt status bits are:

- For ARM:
 - The M[14] bit in the module error pending register 0 (MERRPR0) in PSC0 module.
 - The EMUIHB and the EMURST bits in the module status register for ARM (MDSTAT14).

The status bit in MERRPR0 and PERRPR registers is read by software to determine which module or power domain has generated an emulation interrupt and then software can read the corresponding status bits in MDSTAT register or the PDSTAT n (PDCTL1 for pseudo/RAM power domain in PSC0) to determine which event caused the interrupt.

The PSC interrupt can be cleared by writing to bit corresponding to the module number in the module error clear register (MERRCR0), or the bit corresponding to the power domain number in the power error clear register (PERRCR) in PSC0 module.

The PSC interrupt evaluation bit is the ALLEV bit in the INTEVAL register. When set, this bit forces the PSC interrupt logic to re-evaluate event status. If any events are still active (if any status bits are set) when the ALLEV bit in the INTEVAL is set to 1, the PSC interrupt is re-asserted to the interrupt controller. Set the ALLEV bit in the INTEVAL before exiting your PSC interrupt service routine to ensure that you do not miss any PSC interrupts.

See [Section 8.6](#) for a description of the PSC registers.

8.5.3 Interrupt Handling

Handle the PSC interrupts as described in the following procedure:

First, enable the interrupt:

1. Set the EMUIHBIE bit in PDCTL n , the EMUIHBIE and the EMURSTIE bits in MDCTL n to enable the interrupt events that you want.

NOTE: The PSC interrupt is sent to the device interrupt controller when at least one enabled event becomes active.

2. Enable the power sleep controller interrupt (PSC n _ALLINT) in the device interrupt controller. To interrupt the CPU, PSC n _ALLINT must be enabled in the device interrupt controller. See for more information on interrupts.

The CPU enters the interrupt service routine (ISR) when it receives the interrupt.

1. Read the P[n] bit in PERRPR, and/or the M[n] bit in MERRPR0, the M[n] bit in MERRPR1, to determine the source of the interrupt(s).
2. For each active event that you want to service:
 - (a) Read the event status bits in PDSTAT n and MDSTAT n , depending on the status bits read in the previous step to determine the event that caused the interrupt.
 - (b) Service the interrupt as required by your application.
 - (c) Write the M[n] bit in MERRCR n and the P[n] bit in PERRCR to clear corresponding status.
 - (d) Set the ALLEV bit in INTEVAL. Setting this bit reasserts the PSC interrupt to the device interrupt controller, if there are still any active interrupt events.

8.6 PSC Registers

Table 8-6 lists the memory-mapped registers for the PSC0 and Table 8-7 lists the memory-mapped registers for the PSC1.

Table 8-6. Power and Sleep Controller 0 (PSC0) Registers

Address	Acronym	Register Description	Section
01C1 0000h	REVID	Revision Identification Register	Section 8.6.1
01C1 0018h	INTEVAL	Interrupt Evaluation Register	Section 8.6.2
01C1 0040h	MERRPR0	Module Error Pending Register 0 (module 0-15)	Section 8.6.3
01C1 0050h	MERRCR0	Module Error Clear Register 0 (module 0-15)	Section 8.6.5
01C1 0060h	PERRPR	Power Error Pending Register	Section 8.6.7
01C1 0068h	PERRCR	Power Error Clear Register	Section 8.6.8
01C1 0120h	PTCMD	Power Domain Transition Command Register	Section 8.6.9
01C1 0128h	PTSTAT	Power Domain Transition Status Register	Section 8.6.10
01C1 0200h	PDSTAT0	Power Domain 0 Status Register	Section 8.6.11
01C1 0204h	PDSTAT1	Power Domain 1 Status Register	Section 8.6.12
01C1 0300h	PDCTL0	Power Domain 0 Control Register	Section 8.6.13
01C1 0304h	PDCTL1	Power Domain 1 Control Register	Section 8.6.14
01C1 0400h	PDCFG0	Power Domain 0 Configuration Register	Section 8.6.15
01C1 0404h	PDCFG1	Power Domain 1 Configuration Register	Section 8.6.16
01C1 0800h- 01C1 083Ch	MDSTAT0- MDSTAT15	Module Status <i>n</i> Register (modules 0-15)	Section 8.6.17
01C1 0A00h- 01C1 0A3Ch	MDCTL0- MDCTL15	Module Control <i>n</i> Register (modules 0-15)	Section 8.6.18

Table 8-7. Power and Sleep Controller 1 (PSC1) Registers

Address	Acronym	Register Description	Section
01E2 7000h	REVID	Revision Identification Register	Section 8.6.1
01E2 7018h	INTEVAL	Interrupt Evaluation Register	Section 8.6.2
01E2 7040h	MERRPR0	Module Error Pending Register 0 (module 0-31)	Section 8.6.4
01E2 7050h	MERRCR0	Module Error Clear Register 0 (module 0-31)	Section 8.6.6
01E2 7060h	PERRPR	Power Error Pending Register	Section 8.6.7
01E2 7068h	PERRCR	Power Error Clear Register	Section 8.6.8
01E2 7120h	PTCMD	Power Domain Transition Command Register	Section 8.6.9
01E2 7128h	PTSTAT	Power Domain Transition Status Register	Section 8.6.10
01E2 7200h	PDSTAT0	Power Domain 0 Status Register	Section 8.6.11
01E2 7204h	PDSTAT1	Power Domain 1 Status Register	Section 8.6.12
01E2 7300h	PDCTL0	Power Domain 0 Control Register	Section 8.6.13
01E2 7304h	PDCTL1	Power Domain 1 Control Register	Section 8.6.14
01E2 7400h	PDCFG0	Power Domain 0 Configuration Register	Section 8.6.15
01E2 7404h	PDCFG1	Power Domain 1 Configuration Register	Section 8.6.16
01E2 7800h- 01E2 787Ch	MDSTAT0- MDSTAT31	Module Status <i>n</i> Register (modules 0-31)	Section 8.6.17
01E2 7A00h- 01E2 7A7Ch	MDCTL0- MDCTL31	Module Control <i>n</i> Register (modules 0-31)	Section 8.6.19

8.6.1 Revision Identification Register (REVID)

The revision identification register (REVID) is shown in [Figure 8-1](#) and described in [Table 8-8](#).

Figure 8-1. Revision Identification Register (REVID)

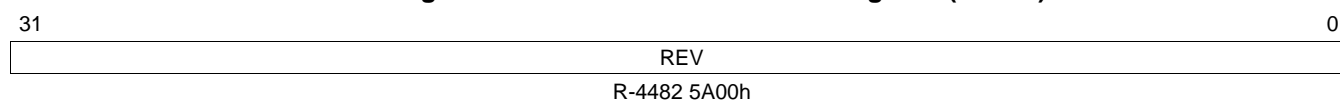

LEGEND: R = Read only; -n = value after reset

Table 8-8. Revision Identification Register (REVID) Field Descriptions

Bit	Field	Value	Description
31-0	REV	4482 5A00h	Peripheral revision ID.

8.6.2 Interrupt Evaluation Register (INTEVAL)

The interrupt evaluation register (INTEVAL) is shown in [Figure 8-2](#) and described in [Table 8-9](#).

Figure 8-2. Interrupt Evaluation Register (INTEVAL)

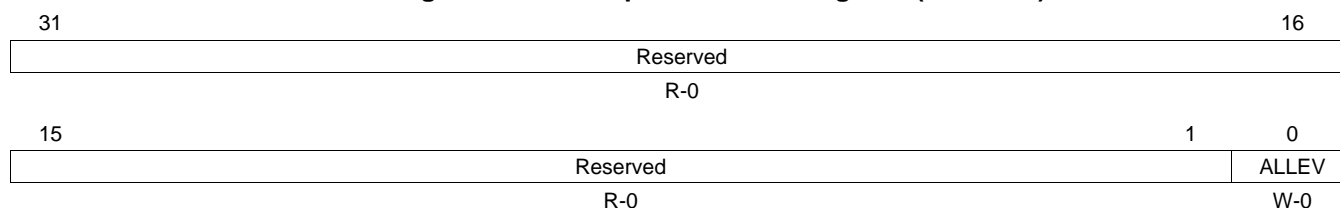

LEGEND: R = Read only; W= Write only; -n = value after reset

Table 8-9. Interrupt Evaluation Register (INTEVAL) Field Descriptions

Bit	Field	Value	Description
31-1	Reserved	0	Reserved
0	ALLEV	0	Evaluate PSC interrupt (PSCn_ALLINT).
		0	A write of 0 has no effect.
		1	A write of 1 re-evaluates the interrupt condition.

8.6.3 PSC0 Module Error Pending Register 0 (modules 0-15) (MERRPR0)

The PSC0 module error pending register 0 (MERRPR0) is shown in [Figure 8-3](#) and described in [Table 8-10](#).

Figure 8-3. PSC0 Module Error Pending Register 0 (MERRPR0)

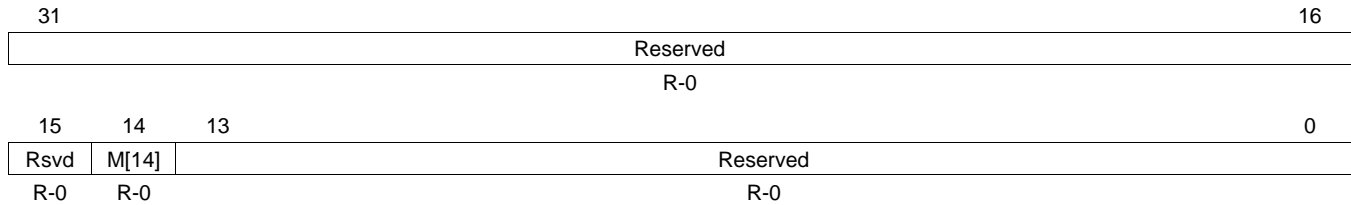

LEGEND: R = Read only; -n = value after reset

Table 8-10. PSC0 Module Error Pending Register 0 (MERRPR0) Field Descriptions

Bit	Field	Value	Description
31-15	Reserved	0	Reserved
14	M[14]	0	Module interrupt status bit for module 14 (ARM). Module 14 does not have an error condition.
		1	Module 14 has an error condition. See the module status 14 register (MDSTAT14) for the error condition.
13-0	Reserved	0	Reserved

8.6.4 PSC1 Module Error Pending Register 0 (modules 0-31) (MERRPR0)

The PSC1 module error pending register 0 (MERRPR0) is shown in [Figure 8-4](#).

Figure 8-4. PSC1 Module Error Pending Register 0 (MERRPR0)

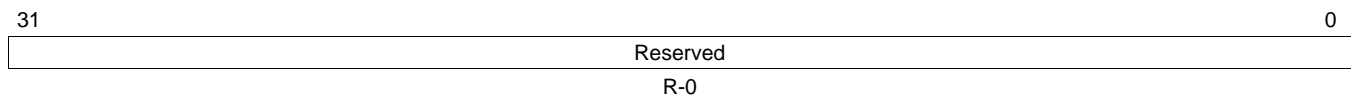

LEGEND: R = Read only; -n = value after reset

8.6.5 PSC0 Module Error Clear Register 0 (modules 0-15) (MERRCR0)

The PSC0 module error clear register 0 (MERRCR0) is shown in [Figure 8-5](#) and described in [Table 8-11](#).

Figure 8-5. PSC0 Module Error Clear Register 0 (MERRCR0)

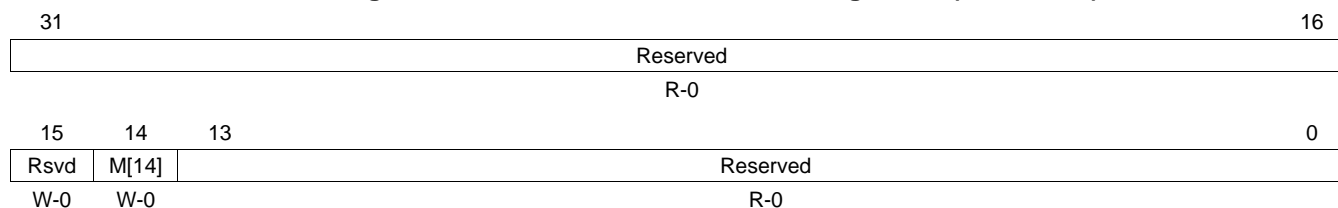

LEGEND: R = Read only; W = Write only; -n = value after reset

Table 8-11. PSC0 Module Error Clear Register 0 (MERRCR0) Field Descriptions

Bit	Field	Value	Description
31-16	Reserved	0	Reserved
15	Reserved	0	Reserved. Write the default value when modifying this register.
14	M[14]	0	Clears the interrupt status bit (M[14]) set in the PSC0 module error pending register 0 (MERRPR0) and the interrupt status bits set in the module status 14 register (MDSTAT14). A write of 0 has no effect.
		1	A write of 1 clears the M[14] bit in MERRPR0 and the EMUIHB and EMURST bits in MDSTAT14.
13-0	Reserved	0	Reserved

8.6.6 PSC1 Module Error Clear Register 0 (modules 0-31) (MERRCR0)

The PSC1 module error clear register 0 (MERRCR0) is shown in [Figure 8-6](#).

Figure 8-6. PSC1 Module Error Clear Register 0 (MERRCR0)

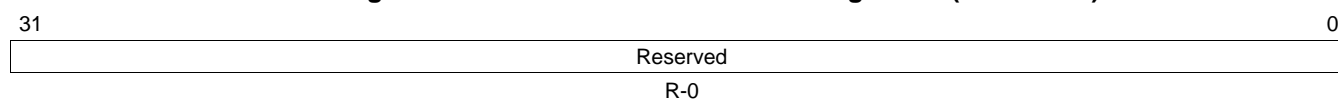

LEGEND: R = Read only; -n = value after reset

8.6.7 Power Error Pending Register (PERRPR)

The power error pending register (PERRPR) is shown in [Figure 8-7](#) and described in [Table 8-12](#).

Figure 8-7. Power Error Pending Register (PERRPR)

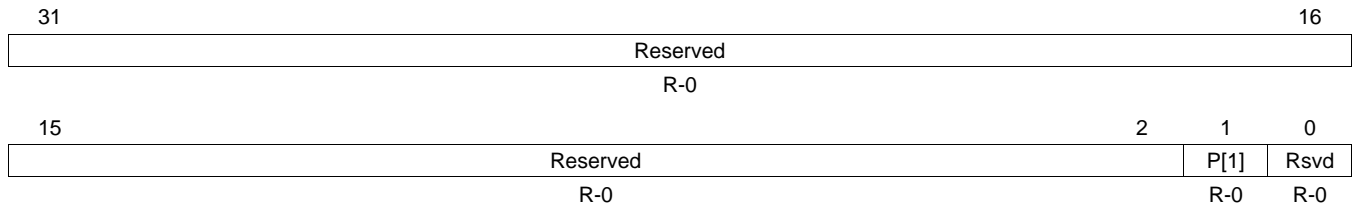

LEGEND: R = Read only; -n = value after reset

Table 8-12. Power Error Pending Register (PERRPR) Field Descriptions

Bit	Field	Value	Description
31-2	Reserved	0	Reserved
1	P[1]	0	RAM/Pseudo (PD1) power domain interrupt status. RAM/Pseudo power domain does not have an error condition.
		1	RAM/Pseudo power domain has an error condition. See the power domain 1 status register (PDSTAT1) for the error condition.
0	Reserved	0	Reserved

8.6.8 Power Error Clear Register (PERRCR)

The power error clear register (PERRCR) is shown in [Figure 8-8](#) and described in [Table 8-13](#).

Figure 8-8. Power Error Clear Register (PERRCR)

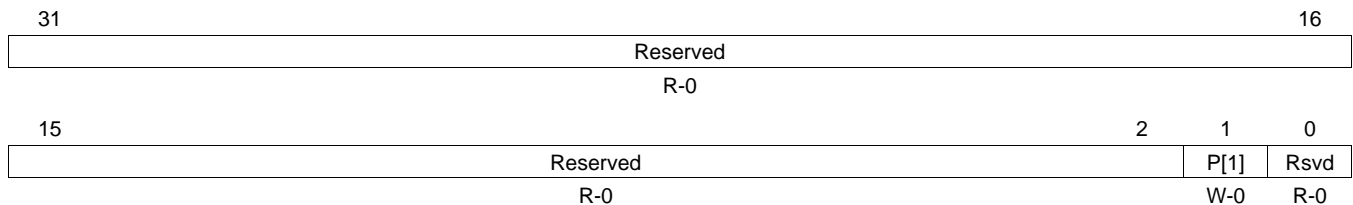

LEGEND: R = Read only; W = Write only; -n = value after reset

Table 8-13. Power Error Clear Register (PERRCR) Field Descriptions

Bit	Field	Value	Description
31-2	Reserved	0	Reserved
1	P[1]	0	Clears the interrupt status bit (P) set in the power error pending register (PERRPR) and the interrupt status bits set in the power domain 1 status register (PDSTAT1). A write of 0 has no effect.
		1	A write of 1 clears the P bit in PERRPR and the interrupt status bits in PDSTAT1.
0	Reserved	0	Reserved

8.6.9 Power Domain Transition Command Register (PTCMD)

The power domain transition command register (PTCMD) is shown in [Figure 8-9](#) and described in [Table 8-14](#).

Figure 8-9. Power Domain Transition Command Register (PTCMD)

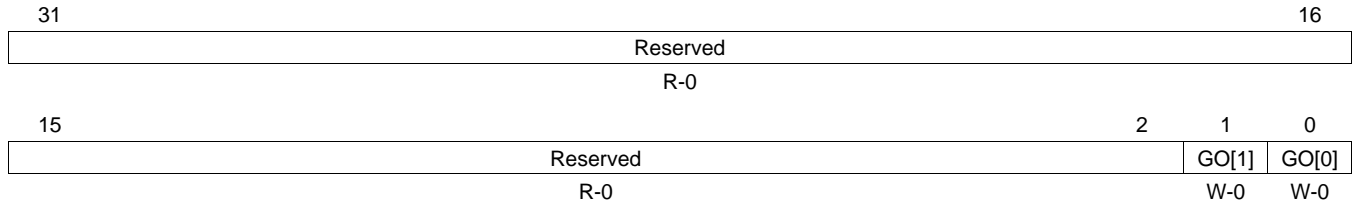

LEGEND: R = Read only; W = Write only; -n = value after reset

Table 8-14. Power Domain Transition Command Register (PTCMD) Field Descriptions

Bit	Field	Value	Description
31-2	Reserved	0	Reserved
1	GO[1]	0 1	RAM/Pseudo (PD1) power domain GO transition command. A write of 0 has no effect. A write of 1 causes the PSC to evaluate all the NEXT fields relevant to this power domain (including PDCTL.NEXT for this domain, and MDCTL.NEXT for all the modules residing on this domain). If any of the NEXT fields are not matching the corresponding current state (PDSTAT.STATE, MDSTAT.STATE), the PSC will transition those respective domain/modules to the new NEXT state.
0	GO[0]	0 1	Always ON (PD0) power domain GO transition command. A write of 0 has no effect. A write of 1 causes the PSC to evaluate all the NEXT fields relevant to this power domain (including MDCTL.NEXT for all the modules residing on this domain). If any of the NEXT fields are not matching the corresponding current state (MDSTAT.STATE), the PSC will transition those respective domain/modules to the new NEXT state.

8.6.10 Power Domain Transition Status Register (PTSTAT)

The power domain transition status register (PTSTAT) is shown in [Figure 8-10](#) and described in [Table 8-15](#).

Figure 8-10. Power Domain Transition Status Register (PTSTAT)

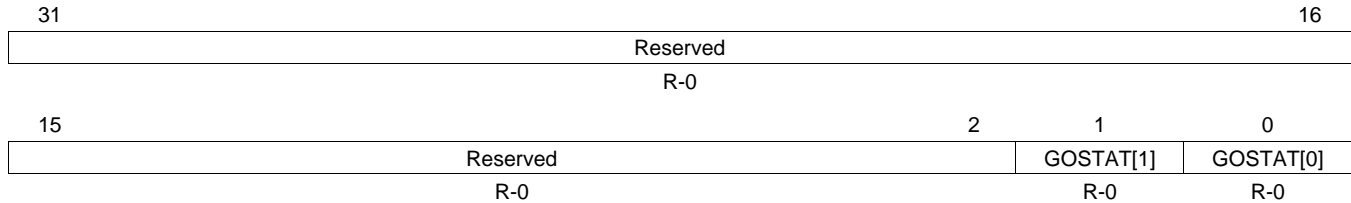

LEGEND: R = Read only; -n = value after reset

Table 8-15. Power Domain Transition Status Register (PTSTAT) Field Descriptions

Bit	Field	Value	Description
31-2	Reserved	0	Reserved
1	GOSTAT[1]	0	RAM/Pseudo (PD1) power domain transition status. No transition in progress.
		1	RAM/Pseudo power domain is transitioning (that is, either the power domain is transitioning or modules in this power domain are transitioning).
0	GOSTAT[0]	0	Always ON (PD0) power domain transition status. No transition in progress.
		1	Modules in Always ON power domain are transitioning. Always On power domain is transitioning.

8.6.11 Power Domain 0 Status Register (PDSTAT0)

The power domain 0 status register (PDSTAT0) is shown in [Figure 8-11](#) and described in [Table 8-16](#).

Figure 8-11. Power Domain 0 Status Register (PDSTAT0)

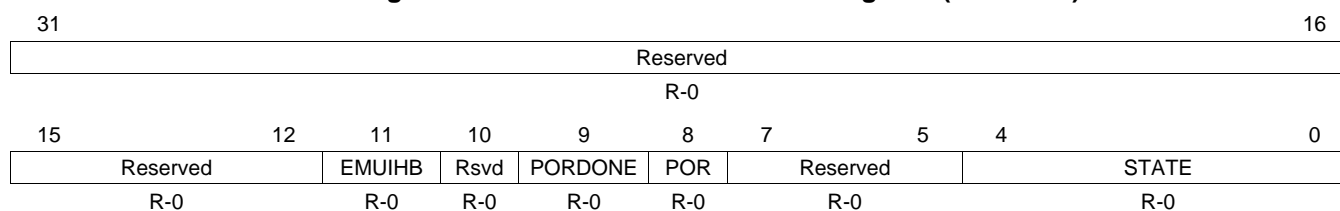

LEGEND: R = Read only; -n = value after reset

Table 8-16. Power Domain 0 Status Register (PDSTAT0) Field Descriptions

Bit	Field	Value	Description
31-12	Reserved	0	Reserved
11	EMUIHB	0	Emulation alters domain state. Interrupt is not active. No emulation altering user-desired power domain states.
		1	Interrupt is active. Emulation alters user-desired power domain state.
10	Reserved	0	Reserved
9	PORDONE	0	Power_On_Reset (POR) Done status Power domain POR is not done.
		1	Power domain POR is done.
8	POR	0	Power Domain Power_On_Reset (POR) status. This bit reflects the POR status for this power domain including all modules in the domain. Power domain POR is asserted.
		1	Power domain POR is de-asserted.
7-5	Reserved	0	Reserved
4-0	STATE	0-1Fh	Power Domain Status.
		0	Power domain is in the off state.
		1h	Power domain is in the on state.
		2h-Fh	Reserved
		10h-1Ah	Power domain is in transition.
		1Bh-1Fh	Reserved

8.6.12 Power Domain 1 Status Register (PDSTAT1)

The power domain 1 status register (PDSTAT1) is shown in [Figure 8-12](#) and described in [Table 8-17](#).

Figure 8-12. Power Domain 1 Status Register (PDSTAT1)

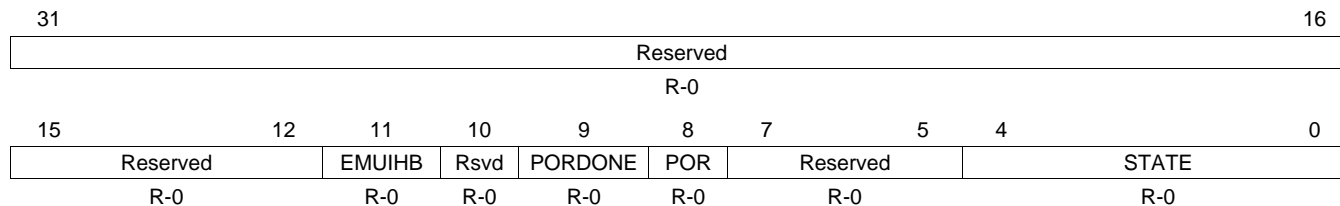

LEGEND: R = Read only; -n = value after reset

Table 8-17. Power Domain 1 Status Register (PDSTAT1) Field Descriptions

Bit	Field	Value	Description
31-12	Reserved	0	Reserved
11	EMUIHB	0	Emulation alters domain state. Interrupt is not active. No emulation altering user-desired power domain states.
		1	Interrupt is active. Emulation alters user-desired power domain state.
10	Reserved	0	Reserved
9	PORDONE	0	Power_On_Reset (POR) Done status Power domain POR is not done.
		1	Power domain POR is done.
8	POR	0	Power Domain Power_On_Reset (POR) status. This bit reflects the POR status for this power domain including all modules in the domain. Power domain POR is asserted.
		1	Power domain POR is de-asserted.
7-5	Reserved	0	Reserved
4-0	STATE	0-1Fh	Power Domain Status.
		0	Power domain is in the off state.
		1h	Power domain is in the on state.
		2h-Fh	Reserved
		10h-1Ah	Power domain is in transition.
		1Bh-1Fh	Reserved

8.6.13 Power Domain 0 Control Register (PDCTL0)

The power domain 0 control register (PDCTL0) is shown in [Figure 8-13](#) and described in [Table 8-18](#).

Figure 8-13. Power Domain 0 Control Register (PDCTL0)

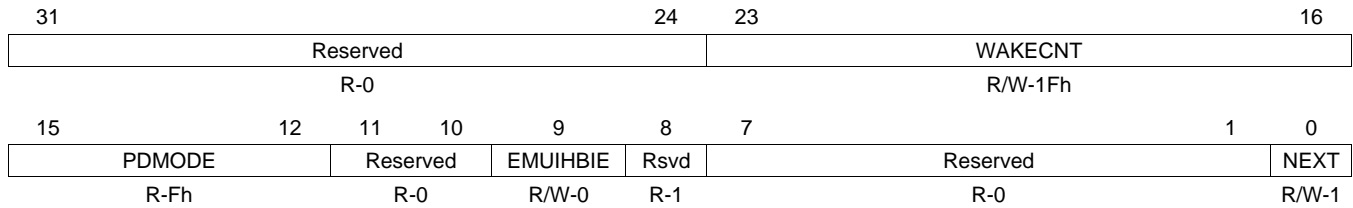

LEGEND: R/W = Read/Write; R = Read only; -n = value after reset

Table 8-18. Power Domain 0 Control Register (PDCTL0) Field Descriptions

Bit	Field	Value	Description
31-24	Reserved	0	Reserved
23-16	WAKECNT	0-FFh	RAM wake count delay value. Not recommended to change the default value (1Fh). Bits 23-30: GOOD2ACCESS wake delay. Bits 19-16: ON2GOOD wake delay.
15-12	PDMODE	0-Fh 0-Eh Fh	Power down mode. Reserved Core on, RAM array on, RAM periphery on.
11-10	Reserved	0	Reserved
9	EMUIHBIE	0 1	Emulation alters power domain state interrupt enable. Disable interrupt. Enable interrupt.
8	Reserved	1	Reserved
7-1	Reserved	0	Reserved
0	NEXT	0 1	Power domain next state. For Always ON power domain this bit is read/write, but writes have no effect since internally this power domain always remains in the on state. Power domain off. Power domain on.

8.6.14 Power Domain 1 Control Register (PDCTL1)

The power domain 1 control register (PDCTL1) is shown in [Figure 8-14](#) and described in [Table 8-19](#).

Figure 8-14. Power Domain 1 Control Register (PDCTL1)

31											24	23			16
Reserved										WAKECNT					
R-0										R/W-1Fh					
15			12	11	10	9	8	7				1	0		
PDMODE			Reserved		EMUIHBIE		Rsvd		Reserved			NEXT			
R-Fh			R-0		R/W-0		R-1		R-0			R/W-1			

LEGEND: R/W = Read/Write; R = Read only; -n = value after reset

Table 8-19. Power Domain 1 Control Register (PDCTL1) Field Descriptions

Bit	Field	Value	Description
31-24	Reserved	0	Reserved
23-16	WAKECNT	0-FFh	RAM wake count delay value. Not recommended to change the default value (1Fh). Bits 23-30: GOOD2ACCESS wake delay. Bits 19-16: ON2GOOD wake delay.
15-12	PDMODE	0-Fh	Power down mode. 0 Core off, RAM array off, RAM periphery off. 1h Core off, RAM array retention, RAM periphery off (deep sleep). 2h-3h Reserved 4h Core retention, RAM array off, RAM periphery off. 5h Core retention, RAM array retention, RAM periphery off (deep sleep). 6h-7h Reserved 8h Core on, RAM array off, RAM periphery off. 9h Core on, RAM array retention, RAM periphery off (deep sleep). Ah Core on, RAM array retention, RAM periphery off (light sleep). Bh Core on, RAM array retention, RAM periphery on. Ch-Eh Reserved Fh Core on, RAM array on, RAM periphery on.
11-10	Reserved	0	Reserved
9	EMUIHBIE	0 1	Emulation alters power domain state interrupt enable. 0 Disable interrupt. 1 Enable interrupt.
8	Reserved	1	Reserved
7-1	Reserved	0	Reserved
0	NEXT	0 1	User-desired power domain next state. 0 Power domain off. 1 Power domain on.

8.6.15 Power Domain 0 Configuration Register (PDCFG0)

The power domain 0 configuration register (PDCFG0) is shown in [Figure 8-15](#) and described in [Table 8-20](#).

Figure 8-15. Power Domain 0 Configuration Register (PDCFG0)

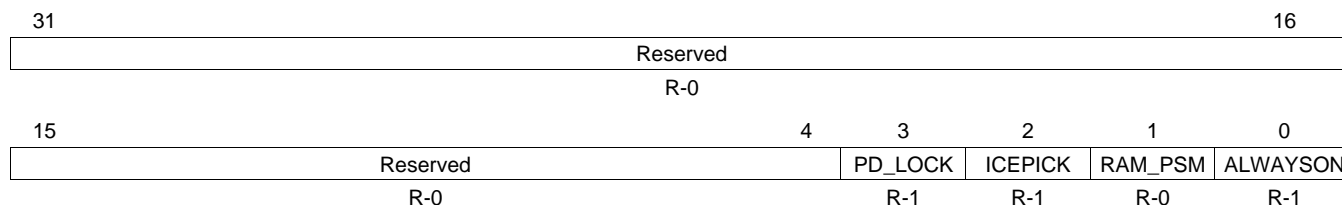

LEGEND: R = Read only; -n = value after reset

Table 8-20. Power Domain 0 Configuration Register (PDCFG0) Field Descriptions

Bit	Field	Value	Description
31-4	Reserved	0	Reserved
3	PD_LOCK	0	PDCTL.NEXT lock. For Always ON power domain this bit is a don't care.
		1	PDCTL.NEXT bit is locked and cannot be changed in software.
		1	PDCTL.NEXT bit is not locked.
2	ICEPICK	0	IcePick support.
		1	Not present
		1	Present
1	RAM_PSM	0	RAM power domain.
		1	Not a RAM power domain.
		1	RAM power domain.
0	ALWAYSON	0	Always ON power domain.
		1	Not an Always ON power domain.
		1	Always ON power domain.

8.6.16 Power Domain 1 Configuration Register (PDCFG1)

The power domain 1 configuration register (PDCFG1) is shown in [Figure 8-16](#) and described in [Table 8-21](#).

Figure 8-16. Power Domain 1 Configuration Register (PDCFG1)

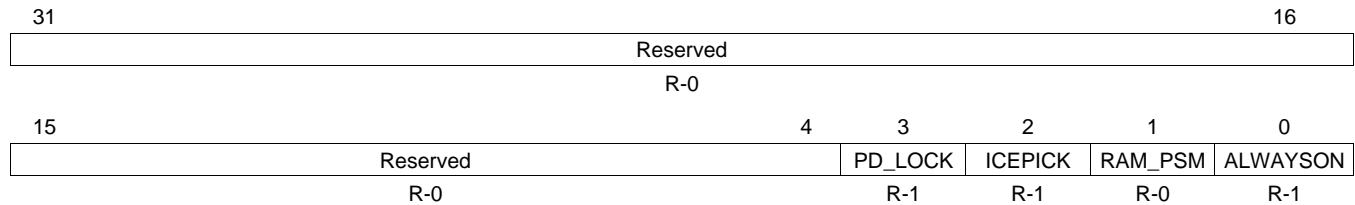

LEGEND: R = Read only; -n = value after reset

Table 8-21. Power Domain 1 Configuration Register (PDCFG1) Field Descriptions

Bit	Field	Value	Description
31-4	Reserved	0	Reserved
3	PD_LOCK	0	PDCTL.NEXT lock. For Always ON power domain this bit is a don't care.
		1	PDCTL.NEXT bit is locked and cannot be changed in software.
		1	PDCTL.NEXT bit is not locked.
2	ICEPICK	0	IcePick support.
		1	Not present
		1	Present
1	RAM_PSM	0	RAM power domain.
		1	Not a RAM power domain.
		1	RAM power domain.
0	ALWAYSON	0	Always ON power domain.
		1	Not an Always ON power domain.
		1	Always ON power domain.

8.6.17 Module Status n Register (MDSTAT n)

The module status n register (MDSTAT n) is shown in [Figure 8-17](#) and described in [Table 8-22](#).

Figure 8-17. Module Status n Register (MDSTAT n)

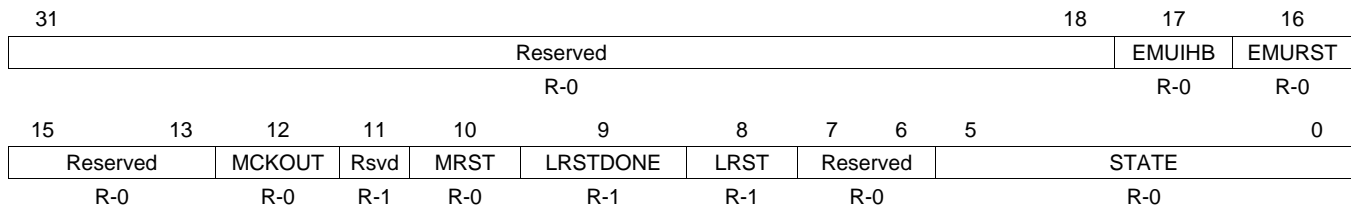

LEGEND: R = Read only; - n = value after reset

Table 8-22. Module Status n Register (MDSTAT n) Field Descriptions

Bit	Field	Value	Description
31-18	Reserved	0	Reserved
17	EMUIHB	0 1	Emulation alters module state. This bit applies to ARM module (module 14). This field is 0 for all other modules. 0 No emulation altering user-desired module state programmed in the NEXT bit in the module control 14 register (MDCTL14). 1 Emulation altered user-desired state programmed in the NEXT bit in MDCTL14. If you desire to generate a PSCINT upon this event, you must set the EMUIHBIE bit in MDCTL14.
16	EMURST	0 1	Emulation alters module reset. This bit applies to ARM module (module 14). This field is 0 for all other modules. 0 No emulation altering user-desired module reset state. 1 Emulation altered user-desired module reset state. If you desire to generate a PSCINT upon this event, you must set the EMURSTIE bit in the module control 14 register (MDCTL14).
15-13	Reserved	0	Reserved
12	MCKOUT	0 1	Module clock output status. Shows status of module clock. 0 Module clock is off. 1 Module clock is on.
11	Reserved	1	Reserved
10	MRST	0 1	Module reset status. Reflects actual state of module reset. 0 Module reset is asserted. 1 Module reset is de-asserted.
9	LRSTDONE	0 1	Local reset done. Software is responsible for checking if local reset is done before accessing this module. This bit applies to ARM module (module 14). This field is 1 for all other modules. 0 Local reset is not done. 1 Local reset is done.
8	LRST	0 1	Module local reset status. This bit applies to ARM module (module 14). 0 Local reset is asserted. 1 Local reset is de-asserted.
7-6	Reserved	0	Reserved
5-0	STATE	0-3Fh 0 1h 2h 3h 4h-3Fh	Module state status: indicates current module status. 0 SwRstDisable state 1h SyncReset state 2h Disable state 3h Enable state 4h-3Fh Indicates transition

8.6.18 PSC0 Module Control n Register (modules 0-15) (MDCTL n)

The PSC0 module control n register (MDCTL n) is shown in [Figure 8-18](#) and described in [Table 8-23](#).

Figure 8-18. PSC0 Module Control n Register (MDCTL n)

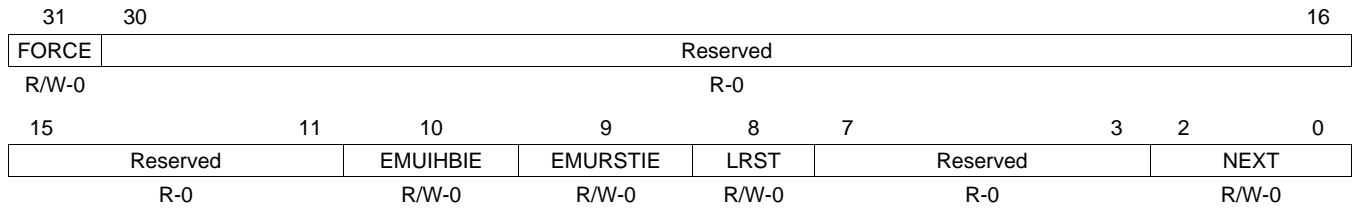

LEGEND: R/W = Read/Write; R = Read only; - n = value after reset

Table 8-23. PSC0 Module Control n Register (MDCTL n) Field Descriptions

Bit	Field	Value	Description
31	FORCE	0 1	Force enable. This bit forces the module state programmed in the NEXT bit in the module control 14 register (MDCTL14), ignoring and bypassing all the clock stop request handshakes managed by the PSC to change the state of the clocks to the module. Note: It is not recommended to use the FORCE bit to disable the module clock, unless specified. Force is disabled. Force is enabled.
30-11	Reserved	0	Reserved
10	EMUIHBIE	0 1	Interrupt enable for emulation alters module state. This bit applies to ARM module (module 14). Disable interrupt. Enable interrupt.
9	EMURSTIE	0 1	Interrupt enable for emulation alters reset. This bit applies to ARM module (module 14). Disable interrupt. Enable interrupt.
8	LRST	0 1	Module local reset control. This bit applies to ARM module (module 14). Assert local reset De-assert local reset
7-3	Reserved	0	Reserved
2-0	NEXT	0-3h 0 1h 2h 3h	Module next state. SwRstDisable state SyncReset state Disable state Enable state

8.6.19 PSC1 Module Control n Register (modules 0-31) (MDCTL n)

The PSC1 module control n register (MDCTL n) is shown in [Figure 8-19](#) and described in [Table 8-24](#).

Figure 8-19. PSC1 Module Control n Register (MDCTL n)

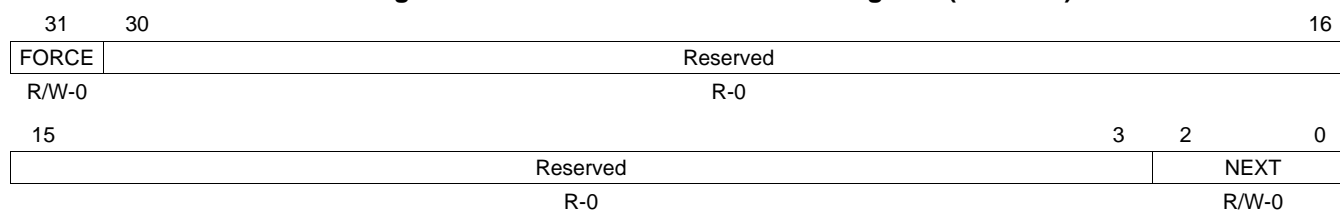

LEGEND: R/W = Read/Write; R = Read only; - n = value after reset

Table 8-24. PSC1 Module Control n Register (MDCTL n) Field Descriptions

Bit	Field	Value	Description
31	FORCE	0 1	Force enable. This bit forces the module state programmed in the NEXT bit in the , ignoring and bypassing all the clock stop request handshakes managed by the PSC to change the state of the clocks to the module. Note: It is not recommended to use the FORCE bit to disable the module clock, unless specified. Force is disabled. Force is enabled.
30-3	Reserved	0	Reserved
2-0	NEXT	0-3h 0 1h 2h 3h	Module next state. SwRstDisable state SyncReset state Disable state Enable state

Power Management

Topic	Page
9.1 Introduction	132
9.2 Power Consumption Overview	132
9.3 PSC and PLLC Overview	132
9.4 Features	133
9.5 Clock Management	134
9.6 ARM Sleep Mode Management	135
9.7 RTC-Only Mode	137
9.8 Dynamic Voltage and Frequency Scaling (DVFS)	137
9.9 Deep Sleep Mode	139
9.10 Additional Peripheral Power Management Considerations	142

9.1 Introduction

Power management is an important aspect for most embedded applications. For several applications and target markets, there may be a specific power budget and requirements to minimize power consumption for both power supply sizing and battery life considerations. Additionally, lower power consumption results in more optimal and efficient designs from cost, design, and energy perspectives. This device has several means of managing the power consumption. This chapter discusses the various power management features.

9.2 Power Consumption Overview

Power consumed by semiconductor devices has two components: dynamic and static. This can be shown as:

$$P_{total} = P_{dynamic} + P_{static}$$

The dynamic power is the power consumed to perform work when the device is in active modes (clocks applied, busses, and I/O switching), that is, analog circuits changing states. The dynamic power is defined by:

$$P_{dynamic} = \text{Capacitance} \times \text{Voltage}^2 \times \text{Frequency}$$

From the above formula, the dynamic power scales with the clock frequency (device/module frequency for core operations and switching frequency for I/O). Dynamic power can be reduced by controlling the clocks in such a way as to either operate at a clock setting just high enough to complete the required operation in the required timeline or to run at a clock setting until the work is complete and then drastically reduce the clock frequency or cut off the clocks until additional work must be performed.

In the formula, the dynamic power varies with the voltage squared, so the voltage of operations has significant impact on overall power consumption and, thus, on the battery life. Dynamic power can be reduced by scaling the operating voltage, when the performance requirements are not that high and the device can be operated at a corresponding lower frequency.

The capacitance is the capacitance of the switching nodes, or the load capacitances on the switching I/O pins.

The static power, as the name suggests, is independent of the switching frequency of the logic. It can be shown as:

$$P_{static} = f_{(leakage\ current)}$$

It is essentially a function of the “leakage”, or the power consumed by the logic when it is not switching or is not performing any work. Leakage current is dependent mostly on the manufacturing process used, the size of the die, etc. Leakage current is unavoidable while power is applied and scales roughly with the operating junction temperatures. Leakage power can only be avoided by removing power completely from a device or subsystem. The static power consumption plays a significant role in the Standby Modes (when the application is not running and in a dormant state) and plays an important role in the battery life for portable applications, etc.

9.3 PSC and PLLC Overview

The power and sleep controller (PSC) module plays an important role in managing the enabling/disabling of the clocks to the core and various peripheral modules. The PSC provides a granular support to turn on/off clocks on a module by module basis. Similarly, the two PLL controllers (PLLC0 and PLLC1) play an important role in device and module clock generation, and manage the frequency scaling operations for the device. Together these modules play a significant role in managing the clocks from a power management feature standpoint. For detailed information on the PSC, see [Chapter 8](#). For detailed information on the PLLC0 and PLLC1, see [Chapter 6](#) and [Chapter 7](#).

9.4 Features

This device has several means of managing power consumption, as detailed in the subsequent sections. This device uses the state-of-the-art 65 nm process, which provides a good balance on power and performance, providing high-performance transistors with relatively less leakage current and, thereby, low standby-power consumption modes.

There are several features in design as well as user driven software control to reduce dynamic power consumption. The design features (not under user control) include a power optimized clock tree design to reduce overall clock tree power consumption and automatic clock gating in several modules when the logic in the modules is not active.

The on-chip power and sleep controller (PSC) module provides granular software controlled module level clock gating, which reduces both clock tree and module power by basically disabling the clocks when the modules are not being used. Clock management also allows you to slow down the clocks, to reduce the dynamic power.

Table 9-1 describes the power management features.

Table 9-1. Power Management Features

Power Management	Description	Features
Clock Management		
PLL bypass and power-down	Both PLLs can be powered-down and run in bypass mode when not in use.	Reduces the dynamic power consumption of the core.
Module clock ON	Module clocks can be turned on/off without requiring reconfiguring the registers.	Reduces the dynamic power consumption of the core and I/O (if any free running I/O clocks).
Core Sleep Management		
ARM subsystem sleep modes	The ARM CPU can be put in sleep mode. Additionally, the ARM subsystem clock can be completely gated when not in use.	Reduces the dynamic power consumption.
Voltage Management		
RTC-only mode	Allows removing power from all core and I/O supply and just have the real-time clock (RTC) running.	Reduces the dynamic and static power for standby modes that require only the RTC to be functional.
Dynamic Voltage and Frequency Scaling		
Dynamic Voltage and Frequency Scaling (DVFS)	The operating voltage and frequency of the device can be dynamically scaled to meet the requirements of the application.	Reduces the dynamic power consumption of the core and I/O as well as standby power
System/Device Sleep Management		
Deep Sleep Mode	All internal clocks of the device can be turned on/off at the OSCIN level. The deep sleep function can be controlled externally through the DEESLEEP pin or internally through the RTC_ALARM pin.	Reduces the dynamic power consumption of the core and I/O.
Peripheral I/O Power Management		
USB PHY power-down	The USB2.0 PHY can be powered-down.	Minimizes the USB2.0 I/O power consumption when not in use.
DDR2/mDDR self-refresh mode	Allows memory to retain its contents while the rest of the system is powered down.	mDDR and DDR2 can be clock gated to reduce the dynamic power consumption or the entire device can be powered down to reduce the static power consumption.
LVC MOS I/O buffer receiver disable	LVC MOS I/O buffer receivers are disabled.	Minimizes the I/O power consumption.
Internal pull-up and pull-down resistor control	The internal pull-ups and pull-downs are enabled/disabled by groups.	Reduces the I/O leakage power.

9.5 Clock Management

9.5.1 Module Clock ON/OFF

The module clock on/off feature allows software to disable clocks to module individually, in order to reduce the module's dynamic/switching power consumption down to zero. This device is designed in full static CMOS; thus, when a module clock stops, the module's state is preserved and retained. When the clock is restarted, the module resumes operating from the stopping point.

NOTE: Stopping clocks to a module only affects dynamic power consumption, it does not affect static power consumption of the module or the device.

The power and sleep controller (PSC) module controls module clock gating. If a module's clock(s) is stopped while being accessed, the access may not occur, and it can potentially result in unexpected behavior. The PSC provides some protection against such erroneous conditions by monitoring the internal bus activity to ensure there are no accesses to the module from the internal bus, before allowing module's internal clock to be gated. However, it is still recommended that software must ensure that all of the transactions to the module are finished prior to disabling the clocks.

The procedure to turn module clocks on/off using the PSC is described in [Chapter 8](#).

NOTE: To preserve the state of the module, the module state in the PSC must be set to Disable. In this state, the module reset is not asserted and only the module clock is turned off.

Additionally some peripherals implement additional power saving features by automatically shutting off clock to components within the module, when the logic is not active. This is transparent to you, but reduces overall dynamic power consumption when modules are not active.

9.5.2 Module Clock Frequency Scaling

Module clock frequency is scalable by programming the PLL multiply and divide parameters. Additionally, some modules might also have internal clock dividers. Reducing the clock frequency reduces the dynamic/switching power consumption, which scales linearly with frequency.

[Chapter 6](#) details the clocking structure of the device. [Chapter 7](#) describes how to program the PLL0 and PLL1 frequency and the frequency constraints.

9.5.3 PLL Bypass and Power Down

You can bypass each PLL in this device. Bypassing the PLL sends a bypass clock instead of the PLL VCO output (PLLOUT) to the system clocks of the PLLC. For PLLC0, the bypass clock is selected from either the PLL reference clock (OSCIN) or PLL1_SYSCCLK3. For PLLC1, the bypass clock is always OSCIN. The OSCIN frequency is typically, at most, up to 50 MHz.

You can use the OSCIN bypass mode to reduce the core and module clock frequencies to very low maintenance levels without using the PLL during periods of very low system activity. This can lower the overall dynamic power consumption, which is linearly proportional to the frequency.

When the PLL controller is placed in bypass mode, the PLL retains its frequency lock. This allows you to switch between bypass mode and PLL mode without having to wait for the PLL to relock. However, keeping the PLL locked consumes power. You can also power-down the PLL when bypassing it to minimize the overall power consumed by the PLL module. The advantage of bypassing the PLL without powering it down is that you do not have to incur the PLL lock time when switching back to a normal operating level.

[Chapter 6](#) and [Chapter 7](#) describe PLL bypass and PLL power down.

9.6 ARM Sleep Mode Management

9.6.1 ARM Wait-For-Interrupt Sleep Mode

The ARM module can be put into a low-power state using a special sleep mode called wait-for-interrupt (WFI). When the wait-for-interrupt mode is enabled, all internal clocks within the ARM9 module are shut off, the core is completely inactive and only resumes operation after receiving an interrupt. This is a feature for dynamic power management of the ARM processor itself, it does not impact the static power.

NOTE: To enable the WFI mode, the ARM needs to be in supervisor mode.

You can enable the WFI mode via the CP15 register #7 using the following instruction:

- MCR p15, #0, <Rd>, c7, c0, #4

Once the ARM module transitions into the WFI mode, it will remain in this state until an interrupt request (IRQ/FIQ) occurs.

The following sequence exemplifies how to enter the WFI mode:

- Enable any interrupt (for example, an external interrupt) that you plan to use as the wake-up interrupt to exit from the WFI mode.
- Enable the WFI mode using the following CP15 instruction:
 - MCR p15, #0, r3, c7, c0, #4

The following sequence describes the procedure to wake-up from the WFI mode:

- To wake-up from the WFI mode, trigger any enabled interrupt (for example, an external interrupt).
- The ARM's PC jumps to the IRQ/FIQ vector and you must handle the interrupt in an interrupt service routine (ISR).

Exit the ISR and continue normal program execution starting from the instruction immediately following the instruction that enabled the WFI mode.

NOTE: The ARM interrupt controller (AINTC) and the module sourcing the wake-up interrupt (for example, GPIO or watchdog timer) must not be disabled, or the device will never wake up.

For more information on this sleep mode, see the ARM926EJ-S Technical Reference Manual (TRM), downloadable from <http://infocenter.arm.com/help/index.jsp>.

9.6.2 ARM Clock OFF

The software must be structured such that no peripheral is allowed to access the ARM resources before disabling the clocks to the ARM subsystem. The ARM must check for the completion of all its master peripheral initiated requests (that is, CFG and DMA port operations, etc.).

ARM module clock off sequence:

1. The ARM must have the ARM Clock Stop Request interrupt (ARMCLKSTOPREQ, ARM interrupt # 90) enabled and the associated interrupt service routine (ISR) set up before the following ARM clock shutdown procedure.
 - (a) Initiate the ARM clock off sequence by issuing the ARM clock stop command (PSC DISABLE Command) to the ARM subsystem by writing a 2h to the NEXT bit field in the ARM local power sleep controller (LPSC) module control register (PSC0.MDCTL14).
 - (b) Write a 1 to the GO[0] bit (ARM subsystem is part of the PD_ALWAYS ON domain) in the power domain transition command register (PSC0.PTCMD) to start the state transition sequence for the ARM module. This generates the ARMCLKSTOPREQ interrupt to the ARM.
 - (c) Check (poll for 0) the GOSTAT[0] bit in the power domain transition status register (PSC0.PTSTAT) for power transition sequence completion. The GOSTAT[0] bit transitions to 0 when the ARM executes the wait-for-interrupt instruction from inside its interrupt service routine (ISR).
 - (d) Check (poll for 2h) the STATE bit field in the ARM LPSC module status register (PSC0.MDSTAT14) indicating the ARM clock stop sequence completion (STATE: Disable).

The following sequence should be executed by the ARM within the ARM Clock Stop Request interrupt ISR:

1. Check for completion of all ARM master requests (the ARM polls transfer completion statuses of all Master peripherals).
2. Enable the interrupt to be used as the “wake-up” interrupt (for example, one of the CHIPSIG interrupts controlled by the chip signal register (CHIPSIG) in the system configuration (SYSCFG) module—CHIPSIG[0], CHIPSIG[1], etc.) that will be used to wake-up the ARM during the ARM clock-on sequence.
3. Execute the wait-for-interrupt (WFI) ARM instruction.

9.6.3 ARM Subsystem Clock ON

The ARM module defaults to the SwRstDisable state; therefore, the software is responsible for enabling the clock and releasing the reset to the ARM at power-on reset.

1. Wait for the GOSTAT[0] bit in the power domain transition status register (PSC0.PTSTAT) to clear to 0. You must wait for the power domain to finish any previously initiated transitions before initiating a new transition.
2. Write a 3h to the NEXT bit in the ARM local power sleep controller (LPSC) module control register (PSC0.MDCTL14) to prepare the ARM module for an enable transition.
3. Write a 1 to the GO[0] bit (ARM subsystem is part of the PD_ALWAYS ON domain) in the power domain transition command register (PSC0.PTCMD) to start the state transition sequence for the ARM module.
4. Check (poll for 0) the GOSTAT[0] bit in PSC0.PTSTAT for power transition sequence completion. The domain is only safely in the new state after the GOSTAT[0] bit is cleared to 0.
5. Wait for the STATE bit field in the ARM LPSC module status register (PSC0.MDSTAT14) to change to 3h. The module is only safely in the new state after the STATE bit field changes to reflect the new state.

NOTE: This only applies if you are transitioning from the Disable state. If previously in the Disable state, a wake-up interrupt must be triggered in order to wake the ARM (to exit the wait-for-interrupt mode). This example assumes that the ARM enabled this interrupt before entering its wait-for-interrupt sleep mode state.

9.7 RTC-Only Mode

In real-time clock (RTC)-only mode, the RTC is powered on and the rest of the device is completely powered off (all supplies except the RTC supply are removed). In this mode, the RTC is fully functional and keeps track of date, hours, minutes, and seconds. In this mode, the overall power consumption would be significantly lower, as voltage from the rest of the core and I/O logic can be completely removed, eliminating most of the active and static power of the device, except for what is consumed by the RTC module, running at 32 kHz.

NOTE: To put the device in RTC-only mode, there is no software control sequence. You can put the device in the RTC-only mode by removing the power supply from all core and I/O logic, except for the RTC core logic supply (RTC_CVDD). During wake up, all power sequencing requirements described in the device-specific data manual must be followed.

Some limitations apply in the RTC-only mode. First, the RTC_ALARM pin is not available as an option for use as a control to signal an external power supply to reapply power to the rest of the device. This is because the RTC_ALARM pin is powered by the I/O supply that is powered down in RTC-only mode. Second, in RTC-only mode, only the RTC register contents are preserved, all other internal memory and register contents are lost. Mobile DDR and DDR2 contents can be preserved through the use of self-refresh (see [Section 9.9.2](#)). However, software must be in place to restore the context of the device, for example, reinitialize internal registers, setup cache memory configurations, interrupt vectors, etc.

9.8 Dynamic Voltage and Frequency Scaling (DVFS)

Dynamic voltage and frequency scaling (DVFS) consists of minimizing the idle time of the system. The DVFS technique uses dynamic selection of the optimal frequency and voltage to allow a task to be performed in the required amount of time. This reduces the total power consumption of the device while still meeting task requirements. DVFS requires control over the clock frequency and the operating voltage of the device elements. By intelligently switching these elements to their optimal operating points, it is possible to minimize the power consumption of the device for a given task.

For reasons related to the device (clock architecture, process, etc.), DVFS is used only for a few discrete steps, not over a continuum of voltage and frequency values. Each step, or operating performance point (OPP), is composed of a voltage and frequency pair. For an OPP, the frequency corresponds to the maximum frequency allowed at a voltage, or reciprocally; the voltage corresponds to the minimum voltage allowed for a frequency. See your device data manual for a list of the OPPs supported by the device.

When applying DVFS, a processor or system always runs at the lowest OPP that meets the performance requirement at a given time. You determine the optimal OPP for a given task and then switch to that OPP to save power.

9.8.1 Frequency Scaling Considerations

The operating frequency of the device is controlled through its two PLL controllers (PLLC0 and PLLC1). Through a series of multipliers and dividers you can change the frequencies of various clocks throughout the device. See [Chapter 6](#) for information on the clock architecture of the device and see [Chapter 7](#) for information on the PLL controllers. A few things must be noted when changing the various internal frequencies of the device:

- Changing the SYSCLK frequency

The PLL_VCO (PLLOUT) frequency can be programmed through a PLL multiplier. A series of dividers divide PLLOUT to generate the various device SYSCLKs.

To change the SYSCLK frequency you can change the PLL multiplier or you can change the SYSCLK divider ratio. When changing the PLL multiplier, you must put the PLL controller in bypass mode while the PLL multiplier value is modified and a lock on the new frequency is reached. The lock time is given in the device data manual. When changing the divider ratios it is not required to put the PLL controller in bypass mode.

Changing the SYSCLK frequency through the dividers is faster as there is no need to reprogram the PLL. However, the SYSCLK frequency will depend solely on the divider ratios used.

- SYSCLK domain fixed ratios

Certain SYSCLK domains need to operate at a fixed ratio with respect to the ARM clock. Care should be taken to ensure that these fixed ratios are maintained. For additional details, see [Chapter 6](#).

- PLLC0 bypass clock

When switching the PLL multiplier, the PLL controller must be placed in bypass mode. Bypassing the PLL sends a bypass clock instead of the PLL VCO output (PLLOUT) to the system clock dividers of the PLL controller.

For PLLC0 the bypass clock is selected from either the PLL reference clock (OSCIN) or PLL1_SYSCLK3. For PLLC1, the bypass clock is always OSCIN. The OSCIN frequency is typically, at most, up to 50 MHz.

You can use the OSCIN bypass mode to reduce the core and module clock frequencies to very low maintenance levels without using the PLL during periods of very low system activity.

It may be desirable for the bypass clock to not revert to OSCIN in some situations to preserved bandwidth during frequency scaling transitions. For this reason, the PLLC0 bypass clock can be set to PLL1_SYSCLK3. This selection is made through the EXTCLKSRC bit in the PLLCTL register of PLLC0.

- Peripheral immunity from ARM clock frequency changes

Peripherals that are clocked by the PLL0_AUXCLK are immune to changes in the PLL0 frequency. The PLL0_AUXCLK is derived from OSCIN.

Peripherals in the ASYNC3 domain are clocked off from either PLL1_SYSCLK2 or PLL0_SYSCLK2. Furthermore, PLL0_SYSCLK2 must always be /2 of the ARM clock frequency. To keep these peripherals immune from changes in PLL0 frequency (such as when the ARM frequency is modified), you can configure the ASYNC3 domain to be clocked from PLL1_SYSCLK2. PLL1 is mainly used to clock the DDR2/mDDR memory controller.

When peripherals are immune to changes in the ARM clock frequency, their internal clock dividers do not have to be adjusted for changes in their input clock frequencies.

9.8.2 Voltage Scaling Considerations

The operating voltage of the device must be totally controlled through mechanisms outside the device. I2C ports on the device can be used to communicate with external power management chips. A few things must be noted when changing the operating voltage of the device:

- Voltage ramp rate: The ramp rate of the operating voltage must be observed during operating performance point (OPP) transitions. See the device data manual for ramp rate specifications.
- Switching to a lower voltage: When switching to a lower voltage, the maximum operating frequency changes. Care must be taken such that the maximum operating frequency supported at the new voltage is not violated. For this reason, it is recommended to change the operating frequency before switching the operating voltage.

9.9 Deep Sleep Mode

This device supports a Deep Sleep mode where all device clocks are stopped and the on-chip oscillator is shut down to save power. Registers and memory contents are preserved, thus, upon recovery, the program may continue from where it left off with minimal overhead involved.

The Deep Sleep mode is initiated when the $\overline{\text{DEEPSLEEP}}$ pin is driven low. The device wakes up from Deep Sleep mode when the $\overline{\text{DEEPSLEEP}}$ pin is driven high. The $\overline{\text{DEEPSLEEP}}$ pin can be driven by an external controller or it can be driven internally by the real-time clock (RTC). The RTC method allows for automatic wake-up at a programmed time.

9.9.1 Entering/Exiting Deep Sleep Mode Using Externally Controlled Wake-Up

9.9.1.1 Entering Deep Sleep Mode

Use the following procedure to enter the Deep Sleep mode if an external signal is used to wake-up the device:

1. To preserve DDR2/mDDR memory contents, activate the self-refresh mode and gate the clocks to the DDR2/mDDR memory controller. You can use partial array self-refresh (PASR) for additional power savings for mDDR memory.
2. The USB2.0 (USB0) PHY should be disabled, if this interface is used and internal clocks are selected (see [Section 9.10.1](#)).
3. PLL/PLLC0 and PLL/PLLC1 should be placed in bypass mode (clear the PLEN bit in the PLL control register (PLLCTL) of each PLLC to 0).
4. PLL/PLLC0 and PLL/PLLC1 should be powered down (set the PLLPWRDN bit in PLLCTL of each PLLC to 1).
5. Configure the $\overline{\text{DEEPSLEEP}}$ pin as input-only using the PINMUX0_31_28 bits in the PINMUX0 register.
6. The external controller should drive the $\overline{\text{DEEPSLEEP}}$ pin high (not in Deep Sleep).
7. Configure the desired delay in the SLEEP_COUNT bit field in the deep sleep register (DEEPSLEEP) in the System Configuration Module. This count determines the delay before the Deep Sleep logic releases the clocks to the device during wake up (allowing the oscillator to stabilize).
8. Set the SLEEPENABLE bit in DEEPSLEEP to 1. This automatically clears the SLEEPCOMPLETE bit.
9. Begin polling the SLEEPCOMPLETE bit until it is set to 1. This bit is set once the device is woken up from Deep Sleep mode.
10. The external controller drives the $\overline{\text{DEEPSLEEP}}$ pin low to initiate Deep Sleep mode.

For more details on the clock stop procedure of the DDR2/mDDR memory controller, see the *AM17x/AM18x ARM Microprocessor DDR2/mDDR Memory Controller User's Guide* ([SPRUFU3](#)).

9.9.1.2 Exiting Deep Sleep Mode

Use the following procedure to exit the Deep Sleep state if an external signal is used to wake-up the device:

1. The external controller drives the $\overline{\text{DEEPSLEEP}}$ pin high.
2. When the SLEEP_COUNT delay is complete, the Deep Sleep logic releases the clock to the device and sets the SLEEPCOMPLETE bit in the deep sleep register (DEEPSLEEP) in the System Configuration Module.
3. Clear the SLEEPENABLE bit in DEEPSLEEP to 0. This automatically clears the SLEEPCOMPLETE bit.
4. Initialize the PLL controllers as described in [Section 7.2.2.2](#). Note that the state of the PLL controller registers is preserved during Deep Sleep mode. Therefore, it is not necessary to reprogram all the PLL controller registers unless a new setting is desired. At minimum, steps 3, 4, and 7-10 of the PLL initialization procedure must be followed.
5. Enable the clocks to the DDR2/mDDR memory controller, reset the DDR PHY, and then take the DDR2/mDDR out of self-refresh mode.
6. Configure the desired states to the peripherals and enable as required.

For more details on the clock enable procedure of the DDR2/mDDR memory controller, see the *AM17x/AM18x ARM Microprocessor DDR2/mDDR Memory Controller User's Guide* ([SPRUFU3](#)).

9.9.2 Entering/Exiting Deep Sleep Mode Using RTC Controlled Wake-Up

9.9.2.1 Entering Deep Sleep Mode

Use the following procedure to enter the Deep Sleep state if the RTC is used to wake-up the device:

1. To preserve DDR2/mDDR memory contents, activate the self-refresh mode and gate the clocks to the DDR2/mDDR memory controller. You can use partial array self-refresh (PASR) for additional power savings for mDDR memory.
2. The USB2.0 (USB0) PHY should be disabled, if this interface is used and internal clocks are selected (see [Section 9.10.1](#)).
3. PLL/PLLC0 and PLL/PLLC1 should be placed in bypass mode (clear the PLEN bit in the PLL control register (PLLCTL) of each PLLC to 0).
4. PLL/PLLC0 and PLL/PLLC1 should be powered down (set the PLLPWRDN bit in PLLCTL of each PLLC to 1).
5. Configure the desired wake-up time as an alarm in the RTC.
6. Configure the DEEPSLEEP/RTC_ALARM pin to output RTC_ALARM using the PINMUX0_31_28 bits in the PINMUX0 register. The pin is driven low since the alarm has not yet occurred.
7. Configure the desired delay in the SLEEP_COUNT bit field in the deep sleep register (DEEPSLEEP) in the System Configuration Module. This count determines the delay before the Deep Sleep logic releases the clocks to the device during wake up (allowing the oscillator to stabilize).
8. Set the SLEEPENABLE bit in DEEPSLEEP to 1. This automatically clears the SLEEP_COMPLETE bit. Also, the device now enters the Deep Sleep mode since the DEEPSLEEP pin is low.

For more details on the clock stop procedure of the DDR2/mDDR memory controller, see the *AM17x/AM18x ARM Microprocessor DDR2/mDDR Memory Controller User's Guide* ([SPRUFU3](#)).

9.9.2.2 Exiting Deep Sleep Mode

Use the following procedure to exit the Deep Sleep state if the RTC is used to wake-up the device:

1. The RTC alarm occurs and the RTC_ALARM pin is driven high (which is internally connected to the DEEPSLEEP pin). This causes the Deep Sleep logic to exit the Deep Sleep mode.
2. When the SLEEP_COUNT delay is complete, the Deep Sleep logic releases the clock to the device and sets the SLEEP_COMPLETE bit in the deep sleep register (DEEPSLEEP) in the System Configuration Module.
3. Clear the SLEEPENABLE bit in DEEPSLEEP to 0. This automatically clears the SLEEP_COMPLETE bit.
4. Initialize the PLL controllers as described in [Section 7.2.2.2](#). Note that the state of the PLL controller registers is preserved during Deep Sleep mode. Therefore, it is not necessary to reprogram all the PLL controller registers unless a new setting is desired. At minimum, steps 3, 4, and 7-10 of the PLL initialization procedure must be followed.
5. Enable the clocks to the DDR2/mDDR memory controller, reset the DDR PHY, and then take the DDR2/mDDR out of self-refresh mode.
6. Configure the desired states to the peripherals and enable as required.

For more details on the clock enable procedure of the DDR2/mDDR memory controller, see the *AM17x/AM18x ARM Microprocessor DDR2/mDDR Memory Controller User's Guide* ([SPRUFU3](#)).

9.9.3 Deep Sleep Sequence

Figure 9-1 illustrates the Deep Sleep sequence:

1. Software sets the SLEEPENABLE bit in the deep sleep register (DEEPSLEEP) in the System Configuration Module.
2. The DEEPSLEEP pin is driven low by either an external device or the RTC_ALARM pin. The Deep Sleep mode begins.
3. The PLL controller reference clock is gated.
4. The on-chip oscillator is disabled. If the device is being clocked by an external source, this clock may stay enabled; the power savings from turning off this clock is minimal.
5. The DEEPSLEEP pin is driven high and the on-chip oscillator is enabled.
6. The Deep Sleep counter begins counting valid clock cycles.
7. The count has reached the number specified in the SLEEP_COUNT bit field and the SLEEP_COMPLETE bit is set. The PLL reference clock is enabled and the Deep Sleep mode ends.
8. Software clears the SLEEPENABLE bit. The SLEEP_COMPLETE bit is automatically cleared.

Figure 9-1. Deep Sleep Mode Sequence

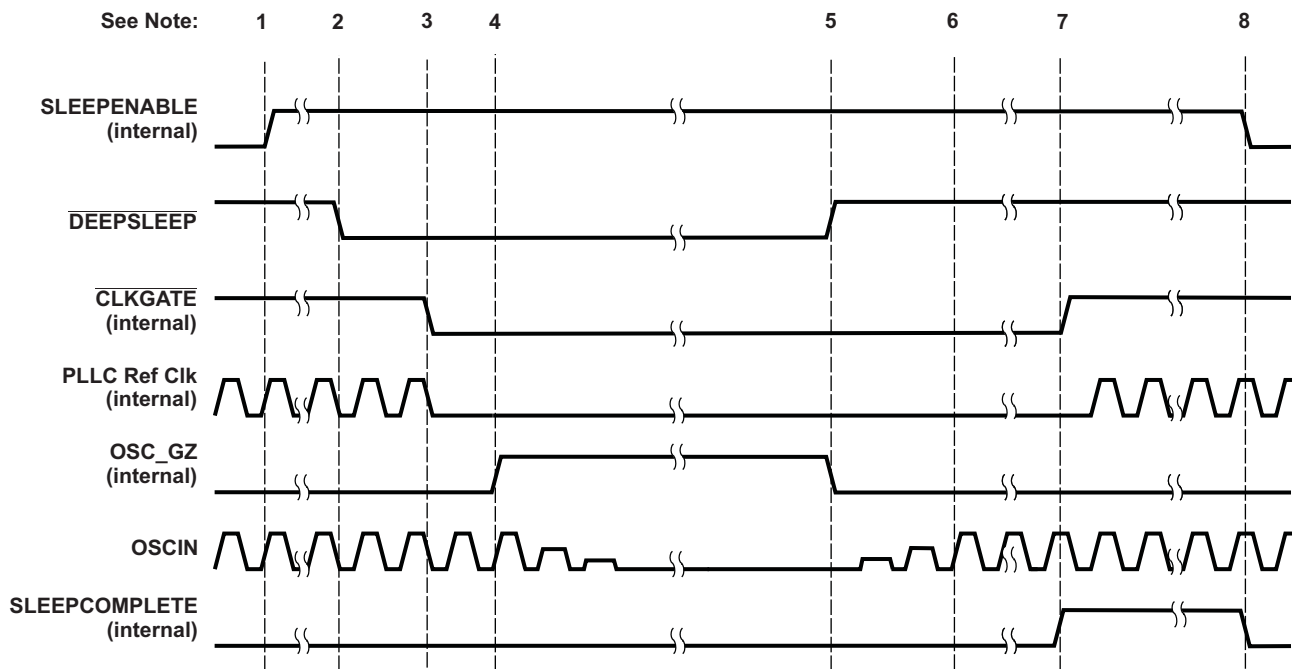

9.9.4 Entering/Exiting Deep Sleep Mode Using Software Handshaking

Entering the Deep Sleep mode stops all of the clocks to the device so it is the responsibility of the software to ensure that all peripheral accesses have been completed and peripheral interfaces appropriately configured for clocks to stop. Therefore, before an external controller drives the DEEPSLEEP pin, a handshaking mechanism must be in place to give software time to prepare the device for Deep Sleep mode. The implementation of the handshake mechanism is up to the system designer.

9.9.4.1 Entering Deep Sleep Mode

The following example sequence can be used to activate the Deep Sleep mode using a handshaking mechanism between your device and an external device:

1. Clear the SLEEPENABLE bit in the deep sleep register (DEEPSLEEP) in the System Configuration Module to 0. The DEEPSLEEP pin has no effect until software running on the device sets this bit.
2. Configure the GP0[8]/DEEPSLEEP/RTC_ALARM pin to output GP0[8] using the PINMUX0_31_28 bits in the PINMUX0 register. When the pin is configured for GPIO functionality, the internal DEEPSLEEP signal is still driven by the value on the pin.
3. Configure the GP0[8] pin to generate interrupts on the falling edge of the GPIO signal.
4. An external device drives the GP0[8] pin low.
5. Software prepares the device for Deep Sleep mode.
6. Set the SLEEPENABLE bit in DEEPSLEEP to 1. The Deep Sleep mode is immediately started and all device clocks are stopped. Also, the SLEEPCOMPLETE bit is automatically cleared.

9.9.4.2 Exiting Deep Sleep Mode

To exit the Deep Sleep mode, follow this sequence:

1. An external device drives the GP0[8] pin high.
2. The device exits the Deep Sleep mode. When the SLEEPDELAY delay is complete, the Deep Sleep logic releases the clock to the device and sets the SLEEPCOMPLETE bit in the deep sleep register (DEEPSLEEP) in the System Configuration Module.
3. Clear the SLEEPENABLE bit in DEEPSLEEP to 0.

9.10 Additional Peripheral Power Management Considerations

This section lists additional power management features and considerations that might be part of other chip-level or peripheral logic, apart from the features supported by the core, PLL controller (PLL), and power and sleep controller (PSC).

9.10.1 USB PHY Power Down Control

The USB modules can be clock gated using the PSC; however, this does not power down/clock gate the PHY logic. You can put the USB2.0 PHY and OTG module in the lowest power state, when not in use, by writing to the USB0PHYPWDN and the USB0OTGPWRDN bits in the chip configuration 2 register (CFGCHIP2) of the system configuration (SYSCFG) module.

9.10.2 DDR2/mDDR Memory Controller Clock Gating and Self-Refresh Mode

The DDR2/mDDR memory controller supports different methods for reducing its power consumption including self-refresh mode, power-down mode, and clock gating. Additionally, the DDR2/mDDR memory controller DLL, PHY, and the receivers at the I/O pins can be disabled. Even if the PHY is active, the receivers can be configured to disable whenever writes are in progress and the receivers are not needed.

Self-refresh mode can be used to preserve the contents of DDR2/mDDR memory when the DDR2/mDDR memory controller is clock gated or when the device is placed in RTC-only mode. However, in the RTC-only mode, care must be taken to correctly take the DDR2/mDDR out of self-refresh mode.

NOTE: To preserve the contents of the external memory while the DDR2/mDDR memory controller is clock gated, its self-refresh mode must be enabled before the DDR2/mDDR memory controller clock is turned off.

In RTC-only mode, all portions of the device except for the RTC are powered down, including the DDR2/mDDR memory controller. During power-up, the DDR2/mDDR memory controller defaults to its reset state. When the DDR2/mDDR memory controller is taken out of reset, it automatically runs its memory initialization routine; the self-refresh state of the memory is ignored. This hardware sequence cannot be stopped by software running on the device.

To correctly take the memory out of self-refresh after coming back from RTC-only mode, follow these steps:

1. Before going into RTC-only mode, disconnect the DDR2/mDDR memory controller CKE output pin from the memory; ensure the memory's CKE input pin continues to be driven low.
2. After coming back from RTC-only mode, configure the device to the desired operating state.
3. Program the DDR2/mDDR memory controller following the normal sequence.
4. Enable the self-refresh mode of the DDR2/mDDR memory controller.
5. Connect the DDR2/mDDR memory controller CKE output pin to the memory.
6. Disable the self-refresh mode of the DDR2/mDDR memory controller.

After this sequence, the DDR2/mDDR memory controller is ready for use. Note that hardware logic is needed to disconnect the CKE output pin from the memory and to drive the memory's CKE input pin low.

For more details on the power management features of the DDR2/mDDR memory controller, see the *AM17x/AM18x ARM Microprocessor DDR2/mDDR Memory Controller User's Guide* ([SPRUFU3](#)).

9.10.3 LVCMOS I/O Buffer Receiver Disable

This device supports two types of LVCMOS I/Os: 1.8V I/Os and low-static current dual-voltage I/Os that operate at either 1.8V or 3.3V. The receivers on the LVCMOS I/Os are enabled and disabled by software (see the RXACTIVE Control Register (RXACTIVE) in the System Configuration Module, [Chapter 10](#)). In the event that certain receivers are not used (such as in a low-power state), they can be disabled to conserve power.

9.10.4 Pull-Up/Pull-Down Disable

In general, you must ensure that all input pins are always pulled to a logic-high or a logic-low voltage level. A floating input pin can consume a small amount of I/O leakage current. The I/O leakage current can be greatly multiplied in the case of several floating inputs pins.

This device includes internal pull-up and pull-down resistors that prevent floating input pins. These internal resistors are generally very weak and their use is intended for pins that are not connected on the board design. For pins that are connected, external pull-up and pull-down resistors are recommended.

When an input pin is externally driven to a valid logic level, through an external pull-up resistor or by an external device for example, it is recommended to disable the internal resistor. Opposing an internal pull-up or pull-down resistor can consume a small amount of current. Internal resistors are disabled through the pullup/pulldown enable register (PUPD_ENA) in the system configuration module ([Chapter 10](#)).

System Configuration (SYSCFG) Module

Topic	Page
10.1 Introduction	146
10.2 Protection	146
10.3 Master Priority Control	147
10.4 SYSCFG Registers	149

10.1 Introduction

The system configuration (SYSCFG) module is a system-level module containing status and top level control logic required by the device. The system configuration module consists of a set of memory-mapped status and control registers, accessible by the CPU, supporting all of the following system features, and miscellaneous functions and operations.

- Device Identification
- Device Configuration
 - Pin multiplexing control
 - Device Boot Configuration Status
- Master Priority Control
 - Controls the system priority for all master peripherals (including EDMA3TC)
- Emulation Control
 - Emulation suspend control for peripherals that support the feature
- Special Peripheral Status and Control
 - Locking of PLL control settings
 - Default burst size configuration for EDMA3 transfer controllers
 - Event source selection for the eCAP peripheral input capture
 - McASP0 AMUTEIN selection and clearing of AMUTE
 - USB PHY Control
 - Clock source selection for EMIFA and DDR2/mDDR
 - HPI Control

The system configuration module controls several global operations of the device; therefore, the module supports protection against erroneous and illegal accesses to the registers in its memory-map. The protection mechanisms that are present in the module are:

- A special key sequence that needs to be written into a set of registers in the system configuration module, to allow write ability to the rest of registers in the system configuration module.
- Several registers in the module are only accessible when the CPU requesting read/write access is in privileged mode.

10.2 Protection

The SYSCFG module controls several global operations of the device; therefore, it has a protection mechanism that prevents spurious and illegal accesses to the registers in its memory map. The protection mechanism enables accesses to these registers only if certain conditions are met.

10.2.1 Privilege Mode Protection

The CPU supports two privilege levels: Supervisor and User. Several registers in the SYSCFG memory-map can only be accessed when the accessing host (CPU or master peripheral) is operating in privileged mode, that is, in Supervisor mode. The registers that can only be accessed in privileged mode are listed in [Section 10.4](#). See the ARM926EJ-S Technical Reference Manual (TRM), downloadable from <http://infocenter.arm.com/help/index.jsp> for details on privilege levels.

10.2.2 Kicker Mechanism Protection

NOTE: The Kick registers are disabled in silicon revision 2 and later. The SYSCFG registers are always unlocked and writes to the Kick registers have no functional effect.

The Kick registers (KICK0R and KICK1R) can only be accessed in privileged mode (the host needs to be in Supervisor mode). Any number of accesses may be performed to the SYSCFG module, while the module is unlocked.

The SYSCFG module remains unlocked after the unlock sequence, until locked again. Locking the module is accomplished by writing any value other than the key values to either KICK0R or KICK1R.

To access any registers in the SYSCFG module, it is required to follow a special sequence of writes to the Kick registers (KICK0R and KICK1R) with correct key values. Writing the correct key value to the kick registers unlocks the registers in the SYSCFG memory-map. In order to access the SYSCFG registers, the following unlock sequence needs to be executed in software:

1. Write the key value of 83E7 0B13h to KICK0R.
2. Write the key value of 95A4 F1E0h to KICK1R.

After steps 1 and 2, the SYSCFG module registers are accessible and can be configured as per the application requirements.

10.3 Master Priority Control

The on-chip peripherals/modules are essentially divided into two broad categories, masters and slaves. The master peripherals are typically capable of initiating their own read/write data access requests, this includes the ARM, EDMA3 transfer controllers, and peripherals that do not rely on the CPU or EDMA3 for initiating the data transfer to/from them. In order to determine allowed connection between masters and slave, each master request source must have a unique master ID (mstid) associated with it. The master ID is shown in [Table 10-1](#). See the device-specific data manual to determine the masters present on your device.

Each switched central resource (SCR) performs prioritization based on priority level of the master that sends the read/write requests. For all peripherals/ports classified as masters on the device, the priority is programmed in the master priority registers (MSTPRI0-3) in the SYSCFG modules. The default priority levels for each bus master is shown in [Table 10-2](#). Application software is expected to modify these values to obtain the desired performance.

Table 10-1. Master IDs

Master ID	Peripheral
0	ARM - Instruction
1	ARM - Data
2-7	Reserved
8	PRU0
9	PRU1
10	EDMA3_0_CC0
11	EDMA3_1_CC0
12-15	Reserved
16	EDMA3_0_TC0 - read
17	EDMA3_0_TC0 - write
18	EDMA3_0_TC1 - read
19	EDMA3_0_TC1 - write
20	EDMA3_1_TC0 - read
21	EDMA3_1_TC0 - write
22-33	Reserved

Table 10-1. Master IDs (continued)

Master ID	Peripheral
34	USB2.0 CFG
35	USB2.0 DMA
36	Reserved
37	HPI
38-65	Reserved
66	uPP
67	Reserved
68	VPIF DMA0
69	VPIF DMA1
70-95	Reserved
96	LCDC
97-255	Reserved

Table 10-2. Default Master Priority

Master	Default Priority ⁽¹⁾	Master Priority Register
PRU0	0	MSTPRI1
PRU1	0	MSTPRI1
EDMA3_0_TC0 ⁽²⁾	0	MSTPRI1
EDMA3_0_TC1 ⁽²⁾	0	MSTPRI1
ARM - Instruction	2	MSTPRI0
ARM - Data	2	MSTPRI0
uPP	4	MSTPRI0
EDMA3_1_TC0 ⁽²⁾	4	MSTPRI1
VPIF DMA0	4	MSTPRI1
VPIF DMA1	4	MSTPRI1
USB2.0 CFG	4	MSTPRI2
USB2.0 DMA	4	MSTPRI2
LCDC ⁽³⁾	5	MSTPRI2
HPI	6	MSTPRI2

⁽¹⁾ The default priority settings might not be optimal for all applications. The master priority should be changed from default based on application specific requirement, in order to get optimal performance and prioritization for masters moving data that is real time sensitive.

⁽²⁾ The priority for EDMA3_0_TC0, EDMA3_0_TC1, and EDMA3_1_TC0 is configurable through fields in the master priority 1 register (MSTPRI1), not the EDMA3CC QUEPRI register.

⁽³⁾ LCDC traffic is typically real-time sensitive, therefore, the default priority of 5, which is lower as compared to the default priority of several masters, is not recommended. You should reconfigure the LCDC priority to the highest or equal to other high-priority masters in an application to ensure that the throughput/latency requirements for the LCDC are met.

10.4 SYSCFG Registers

Table 10-3 lists the memory-mapped registers for the system configuration module 0 (SYSCFG0) and Table 10-4 lists the memory-mapped registers for the system configuration module 1 (SYSCFG1). These tables also indicate whether a particular register can be accessed only when the CPU is in privileged mode.

Table 10-3. System Configuration Module 0 (SYSCFG0) Registers

Address	Acronym	Register Description	Access	Section
01C1 4000h	REVID	Revision Identification Register	—	Section 10.4.1
01C1 4008h	DIEIDR0 ⁽¹⁾	Die Identification Register 0	—	—
01C1 400Ch	DIEIDR1 ⁽¹⁾	Die Identification Register 1	—	—
01C1 4010h	DIEIDR2 ⁽¹⁾	Die Identification Register 2	—	—
01C1 4014h	DIEIDR3 ⁽¹⁾	Die Identification Register 3	—	—
01C1 4018h	DEVIDR0	Device Identification Register 0	Privileged mode	Section 10.4.2
01C1 4020h	BOOTCFG	Boot Configuration Register	Privileged mode	Section 10.4.3
01C1 4038h	KICK0R	Kick 0 Register	Privileged mode	Section 10.4.4.1
01C1 403Ch	KICK1R	Kick 1 Register	Privileged mode	Section 10.4.4.2
01C1 4040h	HOST0CFG	Host 0 Configuration Register	—	Section 10.4.5
01C1 40E0h	IRAWSTAT	Interrupt Raw Status/Set Register	Privileged mode	Section 10.4.6.1
01C1 40E4h	IENSTAT	Interrupt Enable Status/Clear Register	Privileged mode	Section 10.4.6.2
01C1 40E8h	IENSET	Interrupt Enable Register	Privileged mode	Section 10.4.6.3
01C1 40ECh	IENCLR	Interrupt Enable Clear Register	Privileged mode	Section 10.4.6.4
01C1 40F0h	EOI	End of Interrupt Register	Privileged mode	Section 10.4.6.5
01C1 40F4h	FLTADDRR	Fault Address Register	Privileged mode	Section 10.4.7.1
01C1 40F8h	FLTSTAT	Fault Status Register	—	Section 10.4.7.2
01C1 4110h	MSTPRI0	Master Priority 0 Register	Privileged mode	Section 10.4.8.1
01C1 4114h	MSTPRI1	Master Priority 1 Register	Privileged mode	Section 10.4.8.2
01C1 4118h	MSTPRI2	Master Priority 2 Register	Privileged mode	Section 10.4.8.3
01C1 4120h	PINMUX0	Pin Multiplexing Control 0 Register	Privileged mode	Section 10.4.9.1
01C1 4124h	PINMUX1	Pin Multiplexing Control 1 Register	Privileged mode	Section 10.4.9.2
01C1 4128h	PINMUX2	Pin Multiplexing Control 2 Register	Privileged mode	Section 10.4.9.3
01C1 412Ch	PINMUX3	Pin Multiplexing Control 3 Register	Privileged mode	Section 10.4.9.4
01C1 4130h	PINMUX4	Pin Multiplexing Control 4 Register	Privileged mode	Section 10.4.9.5
01C1 4134h	PINMUX5	Pin Multiplexing Control 5 Register	Privileged mode	Section 10.4.9.6
01C1 4138h	PINMUX6	Pin Multiplexing Control 6 Register	Privileged mode	Section 10.4.9.7
01C1 413Ch	PINMUX7	Pin Multiplexing Control 7 Register	Privileged mode	Section 10.4.9.8
01C1 4140h	PINMUX8	Pin Multiplexing Control 8 Register	Privileged mode	Section 10.4.9.9
01C1 4144h	PINMUX9	Pin Multiplexing Control 9 Register	Privileged mode	Section 10.4.9.10
01C1 4148h	PINMUX10	Pin Multiplexing Control 10 Register	Privileged mode	Section 10.4.9.11
01C1 414Ch	PINMUX11	Pin Multiplexing Control 11 Register	Privileged mode	Section 10.4.9.12
01C1 4150h	PINMUX12	Pin Multiplexing Control 12 Register	Privileged mode	Section 10.4.9.13
01C1 4154h	PINMUX13	Pin Multiplexing Control 13 Register	Privileged mode	Section 10.4.9.14
01C1 4158h	PINMUX14	Pin Multiplexing Control 14 Register	Privileged mode	Section 10.4.9.15
01C1 415Ch	PINMUX15	Pin Multiplexing Control 15 Register	Privileged mode	Section 10.4.9.16
01C1 4160h	PINMUX16	Pin Multiplexing Control 16 Register	Privileged mode	Section 10.4.9.17
01C1 4164h	PINMUX17	Pin Multiplexing Control 17 Register	Privileged mode	Section 10.4.9.18
01C1 4168h	PINMUX18	Pin Multiplexing Control 18 Register	Privileged mode	Section 10.4.9.19
01C1 416Ch	PINMUX19	Pin Multiplexing Control 19 Register	Privileged mode	Section 10.4.9.20

⁽¹⁾ This register is for internal-use only.

Table 10-3. System Configuration Module 0 (SYSCFG0) Registers (continued)

Address	Acronym	Register Description	Access	Section
01C1 4170h	SUSPSRC	Suspend Source Register	Privileged mode	Section 10.4.10
01C1 4174h	CHIPSIG	Chip Signal Register	—	Section 10.4.11
01C1 4178h	CHIPSIG_CLR	Chip Signal Clear Register	—	Section 10.4.12
01C1 417Ch	CFGCHIP0	Chip Configuration 0 Register	Privileged mode	Section 10.4.13
01C1 4180h	CFGCHIP1	Chip Configuration 1 Register	Privileged mode	Section 10.4.14
01C1 4188h	CFGCHIP3	Chip Configuration 3 Register	Privileged mode	Section 10.4.16
01C1 418Ch	CFGCHIP4	Chip Configuration 4 Register	Privileged mode	Section 10.4.17

Table 10-4. System Configuration Module 1 (SYSCFG1) Registers

Address	Acronym	Register Description	Access	Section
01E2 C000h	VTPIO_CTL	VTP I/O Control Register	Privileged mode	Section 10.4.18
01E2 C004h	DDR_SLEW	DDR Slew Register	Privileged mode	Section 10.4.19
01E2 C008h	DEEPSLEEP	Deep Sleep Register	Privileged mode	Section 10.4.20
01E2 C00Ch	PUPD_ENA	Pullup/Pulldown Enable Register	Privileged mode	Section 10.4.21
01E2 C010h	PUPD_SEL	Pullup/Pulldown Selection Register	Privileged mode	Section 10.4.22
01E2 C014h	RXACTIVE	RXACTIVE Control Register	Privileged mode	Section 10.4.23

10.4.1 Revision Identification Register (REVID)

The revision identification register (REVID) provides the revision information for the SYSCFG module. The REVID is shown in [Figure 10-1](#) and described in [Table 10-5](#).

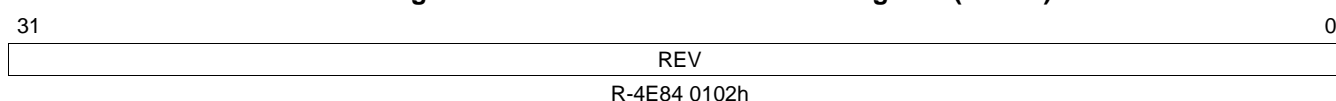
Figure 10-1. Revision Identification Register (REVID)

LEGEND: R = Read only; -n = value after reset

Table 10-5. Revision Identification Register (REVID) Field Descriptions

Bit	Field	Value	Description
31-0	REV	4E84 0102h	Revision ID. Revision information for the SYSCFG module.

10.4.2 Device Identification Register 0 (DEVIDR0)

The device identification register 0 (DEVIDR0) contains a software readable version of the JTAG ID device. Software can use this register to determine the version of the device on which it is executing. The DEVIDR0 is shown in [Figure 10-2](#) and described in [Table 10-6](#).

Figure 10-2. Device Identification Register 0 (DEVIDR0)

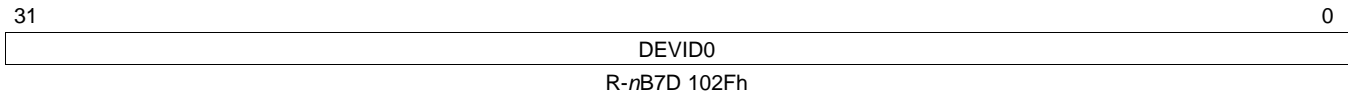

LEGEND: R = Read only; -*n* = value after reset

Table 10-6. Device Identification Register 0 (DEVIDR0) Field Descriptions

Bit	Field	Value	Description
31-0	DEVID0	<i>n</i> B7D 102Fh	Device identification. For silicon revision 1.0, <i>n</i> = 0. For silicon revision 1.1, <i>n</i> = 0. For silicon revision 2.0, <i>n</i> = 1.

10.4.3 Boot Configuration Register (BOOTCFG)

The device boot and configuration settings are latched at device reset, and captured in the boot configuration register (BOOTCFG). See the device-specific data manual and [Chapter 12](#) for details on boot and configuration settings. The BOOTCFG is shown in [Figure 10-3](#) and described in [Table 10-7](#).

Figure 10-3. Boot Configuration Register (BOOTCFG)

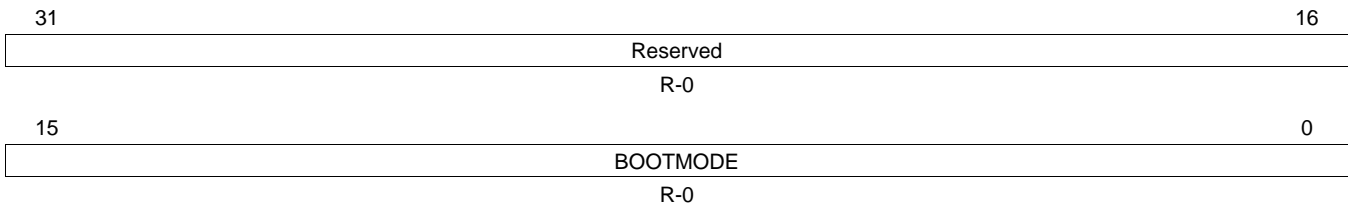

LEGEND: R = Read only; -*n* = value after reset

Table 10-7. Boot Configuration Register (BOOTCFG) Field Descriptions

Bit	Field	Value	Description
31-16	Reserved	0	Reserved
15-0	BOOTMODE	0-FFFFh	Boot Mode. This reflects the state of the boot mode pins.

10.4.4 Kick Registers (KICK0R-KICK1R)

NOTE: The kick registers are disabled in silicon revision 2 and later. The SYSCFG registers are always unlocked and writes to the kick registers have no functional effect.

The SYSCFG module has a protection mechanism to prevent any spurious writes from changing any of the modules memory-mapped registers. At power-on reset, none of the SYSCFG module registers are writeable (they are readable). To allow writing to the registers in the module, it is required to “unlock” the registers by writing to two memory-mapped registers in the SYSCFG module, Kick0 and Kick1, with exact data values. Once these values are written, then all the registers in the SYSCFG module that are writeable can be written to. See [Section 10.2.2](#) for the exact key values and sequence of steps. Writing any other data value to either of these kick registers will cause the memory mapped registers to be “locked” again and block out any write accesses to registers in the SYSCFG module.

10.4.4.1 Kick 0 Register (KICK0R)

The KICK0R is shown in [Figure 10-4](#) and described in [Table 10-8](#).

Figure 10-4. Kick 0 Register (KICK0R)

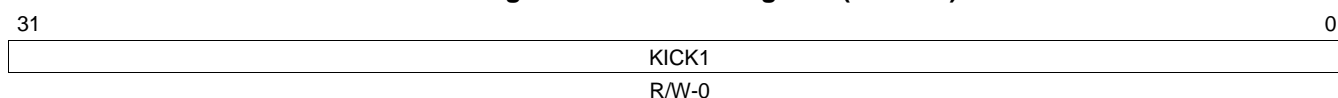

LEGEND: R/W = Read/Write; -n = value after reset

Table 10-8. Kick 0 Register (KICK0R) Field Descriptions

Bit	Field	Value	Description
31-0	KICK0	0-FFFF FFFFh	KICK0R allows writing to unlock the kick0 data. The written data must be 83E7 0B13h to unlock this register. It must be written before writing to the kick1 register. Writing any other value will lock the other MMRs.

10.4.4.2 Kick 1 Register (KICK1R)

The KICK1R is shown in [Figure 10-5](#) and described in [Table 10-9](#).

Figure 10-5. Kick 1 Register (KICK1R)



LEGEND: R/W = Read/Write; -n = value after reset

Table 10-9. Kick 1 Register (KICK1R) Field Descriptions

Bit	Field	Value	Description
31-0	KICK1	0-FFFF FFFFh	KICK1R allows writing to unlock the kick1 data and the kicker mechanism to write to other MMRs. The written data must be 95A4 F1E0h to unlock this register. KICK0R must be written before writing to the kick1 register. Writing any other value will lock the other MMRs.

10.4.5 Host 0 Configuration Register (HOST0CFG)

The ARM subsystem is held in reset when 0 is written to the BOOTRDY bit in the host 0 configuration register (HOST0CFG). In a typical application, the BOOTRDY bit should not be cleared.

The HOST0CFG is shown in [Figure 10-6](#) and described in [Table 10-10](#).

Figure 10-6. Host 0 Configuration Register (HOST0CFG)

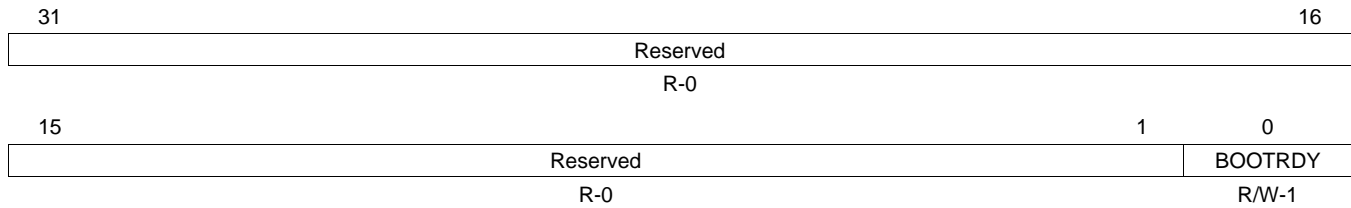

LEGEND: R/W = Read/Write; R = Read only; -n = value after reset

Table 10-10. Host 0 Configuration Register (HOST0CFG) Field Descriptions

Bit	Field	Value	Description
31-1	Reserved	0	Reserved
0	BOOTRDY	0	ARM boot ready bit allowing ARM to boot. ARM held in reset mode.
		1	ARM released from wait in reset mode.

10.4.6 Interrupt Registers

The interrupt registers are a set of registers that provide control for the address and protection violation error interrupt generated by the SYSCFG module when there is an address or protection violation to the module's memory-mapped register address space. This includes enable control, interrupt set and clear control, and end of interrupt (EOI) control.

10.4.6.1 Interrupt Raw Status/Set Register (IRAWSTAT)

The interrupt raw status/set register (IRAWSTAT) shows the interrupt status before enabling the interrupt and allows setting of the interrupt status. The IRAWSTAT is shown in [Figure 10-7](#) and described in [Table 10-11](#).

Figure 10-7. Interrupt Raw Status/Set Register (IRAWSTAT)

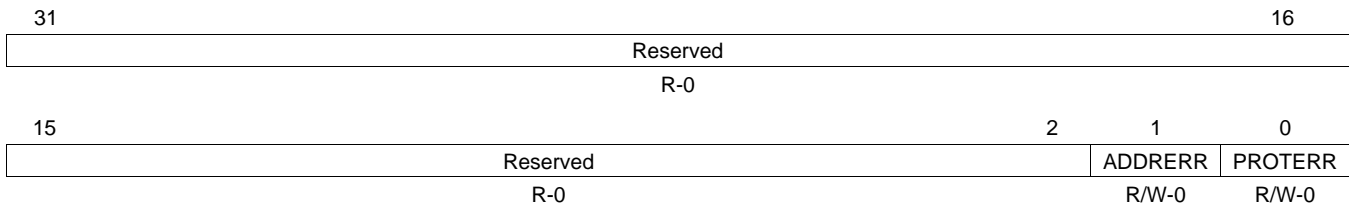

LEGEND: R/W = Read/Write; R = Read only; -n = value after reset

Table 10-11. Interrupt Raw Status/Set Register (IRAWSTAT) Field Descriptions

Bit	Field	Value	Description
31-2	Reserved	0	Reserved. Always read 0.
1	ADDRERR	0	Addressing violation error. Reading this bit field reflects the raw status of the interrupt before enabling. Indicates the interrupt is not set. Writing 0 has no effect.
		1	Indicates the interrupt is set. Writing 1 sets the status.
0	PROTERR	0	Protection violation error. Reading this bit field reflects the raw status of the interrupt before enabling. Indicates the interrupt is not set. Writing 0 has no effect.
		1	Indicates the interrupt is set. Writing 1 sets the status.

10.4.6.2 Interrupt Enable Status/Clear Register (IENSTAT)

The interrupt enable status/clear register (IENSTAT) shows the status of enabled interrupt and allows clearing of the interrupt status. The IENSTAT is shown in [Figure 10-8](#) and described in [Table 10-12](#).

Figure 10-8. Interrupt Enable Status/Clear Register (IENSTAT)

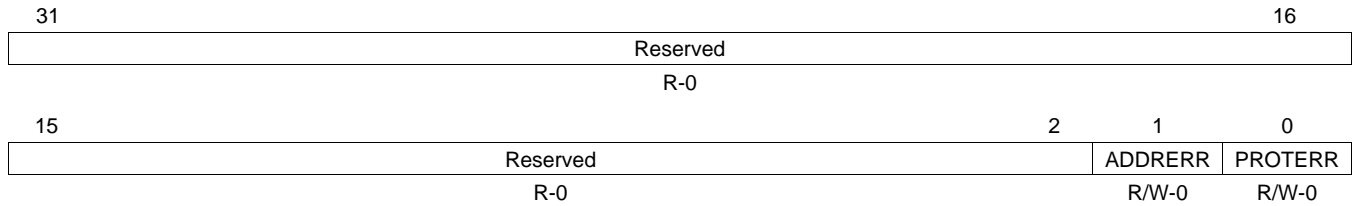

LEGEND: R/W = Read/Write; R = Read only; -n = value after reset

Table 10-12. Interrupt Enable Status/Clear Register (IENSTAT) Field Descriptions

Bit	Field	Value	Description
31-2	Reserved	0	Reserved. Always read 0.
1	ADDRERR	0	Addressing violation error. Reading this bit field reflects the interrupt enabled status. Indicates the interrupt is not set. Writing 0 has no effect.
		1	Indicates the interrupt is set. Writing 1 clears the status.
0	PROTERR	0	Protection violation error. Reading this bit field reflects the interrupt enabled status. Indicates the interrupt is not set. Writing 0 has no effect.
		1	Indicates the interrupt is set. Writing 1 clears the status.

10.4.6.3 Interrupt Enable Register (IENSET)

The interrupt enable register (IENSET) allows setting/enabling the interrupt for address and/or protection violation condition. It also shows the value of the register (whether or not interrupt is enabled). The IENSET is shown in [Figure 10-9](#) and described in [Table 10-13](#).

Figure 10-9. Interrupt Enable Register (IENSET)

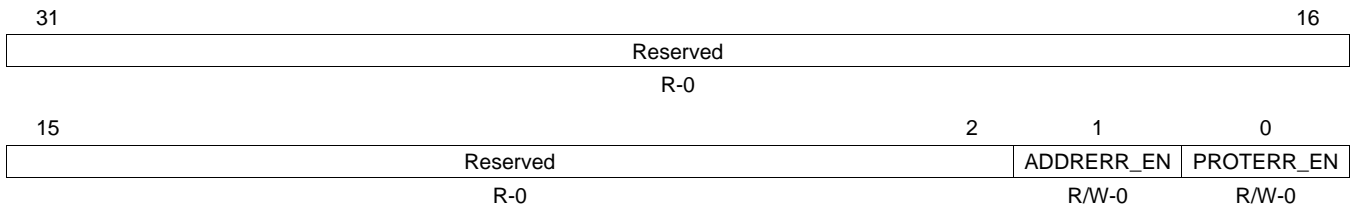

LEGEND: R/W = Read/Write; R = Read only; -n = value after reset

Table 10-13. Interrupt Enable Register (IENSET) Field Descriptions

Bit	Field	Value	Description
31-2	Reserved	0	Reserved. Always read 0.
1	ADDRERR_EN	0	Addressing violation error. Writing a 0 has not effect.
		1	Writing a 1 enables this interrupt.
0	PROTERR_EN	0	Protection violation error. Writing a 0 has not effect.
		1	Writing a 1 enables this interrupt.

10.4.6.4 Interrupt Enable Clear Register (IENCLR)

The interrupt enable clear register (IENCLR) allows clearing/disable the interrupt for address and/or protection violation condition. It also shows the value of the interrupt enable register (IENSET). The IENCLR is shown in [Figure 10-10](#) and described in [Table 10-14](#).

Figure 10-10. Interrupt Enable Clear Register (IENCLR)

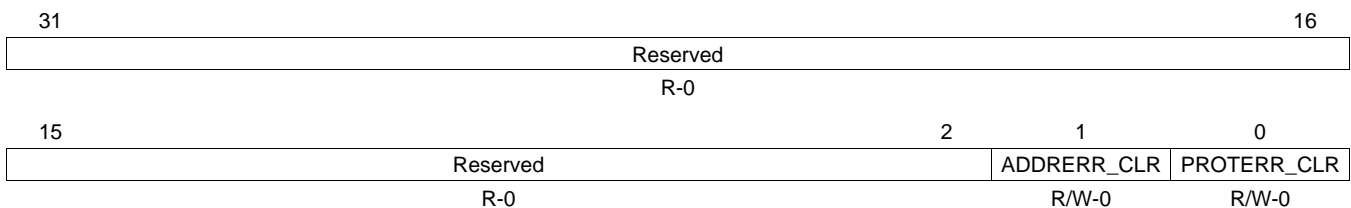

LEGEND: R/W = Read/Write; R = Read only; -n = value after reset

Table 10-14. Interrupt Enable Clear Register (IENCLR) Field Descriptions

Bit	Field	Value	Description
31-2	Reserved	0	Reserved. Always read 0.
1	ADDRERR_CLR	0	Addressing violation error. Writing a 0 has not effect.
		1	Writing a 1 clears/disables this interrupt.
0	PROTERR_CLR	0	Protection violation error. Writing a 0 has not effect.
		1	Writing a 1 clears/disables this interrupt.

10.4.6.5 End of Interrupt Register (EOI)

The end of interrupt register (EOI) is used in software to indicate completion of the interrupt servicing of the SYSCFG interrupt (for address/protection violation). You should write a value of 0 to the EOI register bit 0 after the software has processed the SYSCFG interrupt, this acts as an acknowledgement of completion of the SYSCFG interrupt so that the module can reliably generate the subsequent interrupts. The EOI is shown in [Figure 10-11](#) and described in [Table 10-15](#).

Figure 10-11. End of Interrupt Register (EOI)

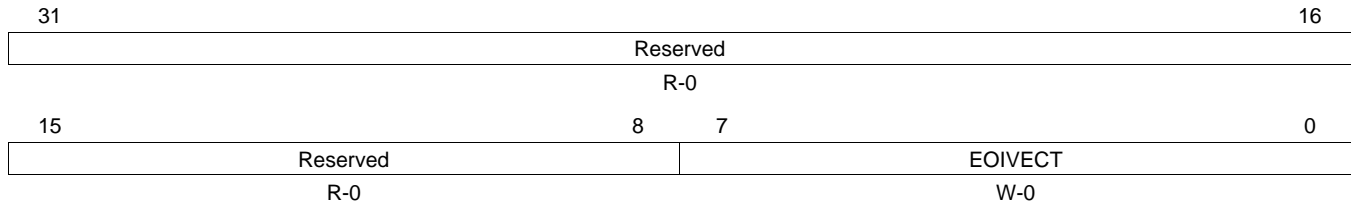

LEGEND: R = Read only; W = Write only; -n = value after reset

Table 10-15. End of Interrupt Register (EOI) Field Descriptions

Bit	Field	Value	Description
31-8	Reserved	0	Reserved. Always read 0.
7-0	EOIVECT	0-FFh	EOI vector value. Write the interrupt distribution value of the chip.

10.4.7 Fault Registers

The fault registers are a group of registers responsible for capturing the details on the faulty (address/protection violation errors) accesses, such as address and type of error.

10.4.7.1 Fault Address Register (FLTADDR)

The fault address register (FLTADDR) captures the address of the first transfer that causes the address or memory violation error. The FLTADDR is shown in [Figure 10-12](#) and described in [Table 10-16](#).

Figure 10-12. Fault Address Register (FLTADDR)

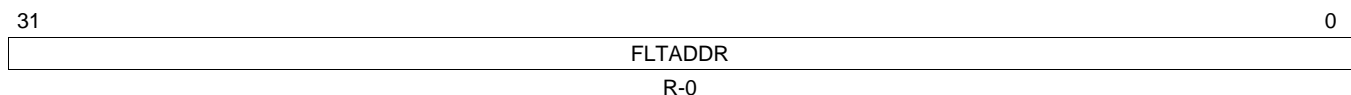

LEGEND: R = Read only; -n = value after reset

Table 10-16. Fault Address Register (FLTADDR) Field Descriptions

Bit	Field	Value	Description
31-0	FLTADDR	0-FFFF FFFFh	Fault address for the first fault transfer.

10.4.7.2 Fault Status Register (FLTSTAT)

The fault status register (FLTSTAT) holds/captures additional attributes and status of the first erroneous transaction. This includes things like the master id for the master that caused the address/memory violation error, details on whether it is a user or supervisor level read/write or execute fault. The FLTSTAT is shown in [Figure 10-13](#) and described in [Table 10-17](#).

Figure 10-13. Fault Status Register (FLTSTAT)

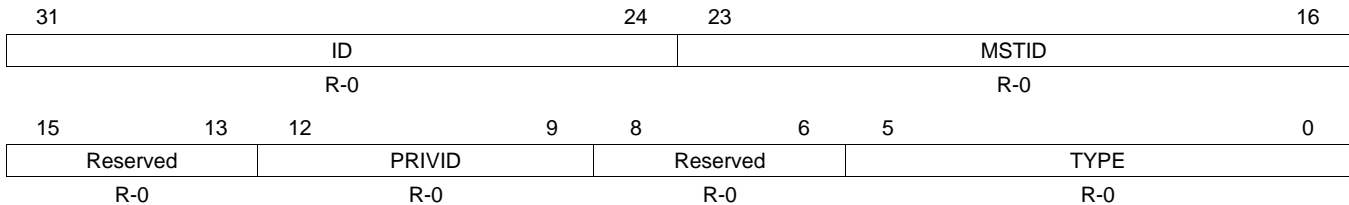

LEGEND: R = Read only; -n = value after reset

Table 10-17. Fault Status Register (FLTSTAT) Field Descriptions

Bit	Field	Value	Description
31-24	ID	0-FFh	Transfer ID of the first fault transfer.
23-16	MSTID	0-FFh	Master ID of the first fault transfer.
15-13	Reserved	0	Reserved. Always read 0
12-9	PRIVID	0-Fh	Privilege ID of the first fault transfer.
8-6	Reserved	0	Reserved. Always read 0
5-0	TYPE		Fault type of first fault transfer.
		0	No transfer fault
		1h	User execute fault
		2h	User write fault
		3h	<i>Reserved</i>
		4h	User read fault
		5h-7h	<i>Reserved</i>
		8h	Supervisor execute fault
		9h-Fh	<i>Reserved</i>
		10h	Supervisor write fault
		11h-1Fh	<i>Reserved</i>
		20h	Supervisor read fault
		21h-3Fh	<i>Reserved</i>

10.4.8 Master Priority Registers (MSTPRI0-MSTPRI2)

10.4.8.1 Master Priority 0 Register (MSTPRI0)

The master priority 0 register (MSTPRI0) is shown in [Figure 10-14](#) and described in [Table 10-18](#).

Figure 10-14. Master Priority 0 Register (MSTPRI0)

31	30	28	27	26	24	23	22	20	19	18	16
Rsvd	Reserved		Rsvd	Reserved		Rsvd	Reserved		Rsvd	UPP	
R/W-0	R/W-4h		R/W-0	R/W-4h		R/W-0	R/W-4h		R/W-0	R/W-4h	
15	14	12	11	10	8	7	6	4	3	2	0
Rsvd	Reserved		Rsvd	Reserved		Rsvd	ARM_D		Rsvd	ARM_I	
R/W-0	R/W-2h		R-0	R/W-2h		R-0	R/W-2h		R-0	R/W-2h	

LEGEND: R/W = Read/Write; R = Read only; -n = value after reset

Table 10-18. Master Priority 0 Register (MSTPRI0) Field Descriptions

Bit	Field	Value	Description
31	Reserved	0	Reserved. Write the default value when modifying this register.
30-28	Reserved	4h	Reserved. Write the default value when modifying this register.
27	Reserved	0	Reserved. Write the default value when modifying this register.
26-24	Reserved	4h	Reserved. Write the default value when modifying this register.
23	Reserved	0	Reserved. Write the default value when modifying this register.
22-20	Reserved	4h	Reserved. Write the default value when modifying this register.
19	Reserved	0	Reserved. Write the default value when modifying this register.
18-16	UPP	0-7h	uPP port priority. Bit = 0 = priority 0 (highest); bit = 7h = priority 7 (lowest).
15	Reserved	0	Reserved. Write the default value when modifying this register.
14-12	Reserved	2h	Reserved. Write the default value when modifying this register.
11	Reserved	0	Reserved. Always read as 0.
10-8	Reserved	2h	Reserved. Write the default value when modifying this register.
7	Reserved	0	Reserved. Always read as 0.
6-4	ARM_D	0-7h	ARM_D port priority. Bit = 0 = priority 0 (highest); bit = 7h = priority 7 (lowest).
3	Reserved	0	Reserved. Always read as 0.
2-0	ARM_I	0-7h	ARM_I port priority. Bit = 0 = priority 0 (highest); bit = 7h = priority 7 (lowest).

10.4.8.2 Master Priority 1 Register (MSTPRI1)

The master priority 1 register (MSTPRI1) is shown in [Figure 10-15](#) and described in [Table 10-19](#).

Figure 10-15. Master Priority 1 Register (MSTPRI1)

31	30	28	27	26	24	23	22	20	19	18	16
Rsvd	VPIF_DMA_1		Rsvd	VPIF_DMA_0		Rsvd	Reserved		Rsvd	EDMA31TC0	
R/W-0	R/W-4h		R/W-0	R/W-4h		R/W-0	R/W-4h		R/W-0	R/W-4h	
15	14	12	11	10	8	7	6	4	3	2	0
Rsvd	EDMA30TC1		Rsvd	EDMA30TC0		Rsvd	PRU1		Rsvd	PRU0	
R/W-0	R/W-0		R-0	R/W-0		R-0	R/W-0		R-0	R/W-0	

LEGEND: R/W = Read/Write; R = Read only; -n = value after reset

Table 10-19. Master Priority 1 Register (MSTPRI1) Field Descriptions

Bit	Field	Value	Description
31	Reserved	0	Reserved. Write the default value when modifying this register.
30-28	VPIF_DMA_1	0-7h	VPIF DMA1 port priority. Bit = 0 = priority 0 (highest); bit = 7h = priority 7 (lowest).
27	Reserved	0	Reserved. Write the default value when modifying this register.
26-24	VPIF_DMA_0	0-7h	VPIF DMA0 port priority. Bit = 0 = priority 0 (highest); bit = 7h = priority 7 (lowest).
23	Reserved	0	Reserved. Write the default value when modifying this register.
22-20	Reserved	4h	Reserved. Write the default value when modifying this register.
19	Reserved	0	Reserved. Write the default value when modifying this register.
18-16	EDMA31TC0	0-7h	EDMA3_1_TC0 port priority. Bit = 0 = priority 0 (highest); bit = 7h = priority 7 (lowest).
15	Reserved	0	Reserved. Write the default value when modifying this register.
14-12	EDMA30TC1	0-7h	EDMA3_0_TC1 port priority. Bit = 0 = priority 0 (highest); bit = 7h = priority 7 (lowest).
11	Reserved	0	Reserved. Always read as 0.
10-8	EDMA30TC0	0-7h	EDMA3_0_TC0 port priority. Bit = 0 = priority 0 (highest); bit = 7h = priority 7 (lowest).
7	Reserved	0	Reserved. Always read as 0.
6-4	PRU1	0-7h	PRU1 port priority. Bit = 0 = priority 0 (highest); bit = 7h = priority 7 (lowest).
3	Reserved	0	Reserved. Always read as 0.
2-0	PRU0	0-7h	PRU0 port priority. Bit = 0 = priority 0 (highest); bit = 7h = priority 7 (lowest).

10.4.8.3 Master Priority 2 Register (MSTPRI2)

The master priority 2 register (MSTPRI2) is shown in [Figure 10-16](#) and described in [Table 10-20](#).

Figure 10-16. Master Priority 2 Register (MSTPRI2)

31	30	28	27	26	24	23	22	20	19	18	16
Rsvd	LCDC		Rsvd	Reserved		Rsvd	UHPI		Rsvd	Reserved	
R/W-0	R/W-5h		R/W-0	R/W-4h		R/W-0	R/W-6h		R/W-0	R/W-0	
15	14	12	11	10	8	7	6	4	3	2	0
Rsvd	USB0CDMA		Rsvd	USB0CFG		Rsvd	Reserved		Rsvd	Reserved	
R/W-0	R/W-4h		R/W-0	R/W-4h		R/W-0	R/W-0		R/W-0	R/W-4h	

LEGEND: R/W = Read/Write; -n = value after reset

Table 10-20. Master Priority 2 Register (MSTPRI2) Field Descriptions

Bit	Field	Value	Description
31	Reserved	0	Reserved. Write the default value when modifying this register.
30-28	LCDC	0-7h	LCDC port priority. Bit = 0 = priority 0 (highest); bit = 7h = priority 7 (lowest).
27	Reserved	0	Reserved. Write the default value when modifying this register.
26-24	Reserved	4h	Reserved. Write the default value when modifying this register.
23	Reserved	0	Reserved. Write the default value when modifying this register.
22-20	UHPI	0-7h	HPI port priority. Bit = 0 = priority 0 (highest); bit = 7h = priority 7 (lowest).
19	Reserved	0	Reserved. Write the default value when modifying this register.
18-16	Reserved	0	Reserved. Write the default value to all bits when modifying this register.
15	Reserved	0	Reserved. Write the default value when modifying this register.
14-12	USB0CDMA	0-7h	USB0 (USB2.0) CDMA port priority. Bit = 0 = priority 0 (highest); bit = 7h = priority 7 (lowest).
11	Reserved	0	Reserved. Write the default value when modifying this register.
10-8	USB0CFG	0-7h	USB0 (USB2.0) CFG port priority. Bit = 0 = priority 0 (highest); bit = 7h = priority 7 (lowest).
7	Reserved	0	Reserved. Write the default value to all bits when modifying this register.
6-4	Reserved	0	Reserved. Write the default value to all bits when modifying this register.
3	Reserved	0	Reserved. Write the default value when modifying this register.
2-0	Reserved	4h	Reserved. Write the default value when modifying this register.

10.4.9 Pin Multiplexing Control Registers (PINMUX0-PINMUX19)

Extensive use of pin multiplexing is used to accommodate the large number of peripheral functions in the smallest possible package. On the device, pin multiplexing can be controlled on a pin by pin basis. This is done by the pin multiplexing registers (PINMUX0-PINMUX19). Each pin that is multiplexed with several different peripheral functions has a corresponding 4-bit field in PINMUX n . Pin multiplexing selects which of several peripheral pin functions control the pins I/O buffer output data and output enable values only. Note that the input from each pin is always routed to all of the peripherals that share the pin; the PINMUX registers have no effect on input from a pin. Hardware does not attempt to ensure that the proper pin multiplexing is selected for the peripherals or that interface mode is being used. Detailed information about the pin multiplexing and control is covered in the device-specific data manual. Access to the pin multiplexing utility is available in *AM18xx Pin Multiplexing Utility Application Report* ([SPRABA2](#)).

10.4.9.1 Pin Multiplexing Control 0 Register (PINMUX0)

Figure 10-17. Pin Multiplexing Control 0 Register (PINMUX0)

31	28	27	24	23	20	19	16
PINMUX0_31_28		PINMUX0_27_24		PINMUX0_23_20		PINMUX0_19_16	
R/W-0		R/W-0		R/W-0		R/W-0	
15	12	11	8	7	4	3	0
PINMUX0_15_12		PINMUX0_11_8		PINMUX0_7_4		PINMUX0_3_0	
R/W-0		R/W-0		R/W-0		R/W-0	

LEGEND: R/W = Read/Write; - n = value after reset

Table 10-21. Pin Multiplexing Control 0 Register (PINMUX0) Field Descriptions

Bit	Field	Value	Description	Type ⁽¹⁾
31-28	PINMUX0_31_28		RTC_ALARM/UART2_CTS/GP0[8]/DEEPSLEEP Control	
		0	Selects Function DEEPSLEEP	I
		1h	Reserved	X
		2h	Selects Function RTC_ALARM	O
		3h	Reserved	X
		4h	Selects Function UART2_CTS	I
		5h-7h	Reserved	X
		8h	Selects Function GP0[8]	I/O
		9h-Fh	Reserved	X
27-24	PINMUX0_27_24		AMUTE/PRU0_R30[16]/UART2_RTS/GP0[9]/PRU0_R31[16] Control	
		0	Selects Function PRU0_R31[16]	I
		1h	Selects Function AMUTE	I/O
		2h	Selects Function PRU0_R30[16]	O
		3h	Reserved	X
		4h	Selects Function UART2_RTS	O
		5h-7h	Reserved	X
		8h	Selects Function GP0[9]	I/O
		9h-Fh	Reserved	X

⁽¹⁾ I = Input, O = Output, I/O = Bidirectional, X = Undefined

Table 10-21. Pin Multiplexing Control 0 Register (PINMUX0) Field Descriptions (continued)

Bit	Field	Value	Description	Type ⁽¹⁾
23-20	PINMUX0_23_20	0 1h 2h 3h 4h 5h-7h 8h 9h-Fh	AHCLKX/USB_REFCLKIN/UART1_CTS/GP0[10]/PRU0_R31[17] Control Selects Function PRU0_R31[17] Selects Function AHCLKX Selects Function USB_REFCLKIN <i>Reserved</i> Selects Function <u>UART1_CTS</u> <i>Reserved</i> Selects Function GP0[10] <i>Reserved</i>	I I/O I X I X I/O X
19-16	PINMUX0_19_16	0 1h 2h 3h 4h 5h-7h 8h 9h-Fh	AHCLKR/PRU0_R30[18]/UART1_RTS/GP0[11]/PRU0_R31[18] Control Selects Function PRU0_R31[18] Selects Function AHCLKR Selects Function PRU0_R30[18] <i>Reserved</i> Selects Function <u>UART1_RTS</u> <i>Reserved</i> Selects Function GP0[11] <i>Reserved</i>	I I/O O X O X I/O X
15-12	PINMUX0_15_12	0 1h 2h-7h 8h 9h-Fh	AFSX/GP0[12]/PRU0_R31[19] Control Selects Function PRU0_R31[19] Selects Function AFSX <i>Reserved</i> Selects Function GP0[12] <i>Reserved</i>	I I/O X I/O X
11-8	PINMUX0_11_8	0 1h 2h-7h 8h 9h-Fh	AFSR/GP0[13]/PRU0_R31[20] Control Selects Function PRU0_R31[20] Selects Function AFSR <i>Reserved</i> Selects Function GP0[13] <i>Reserved</i>	I I/O X I/O X
7-4	PINMUX0_7_4	0 1h 2h-3h 4h 5h-7h 8h 9h-Fh	ACLKX/PRU0_R30[19]/GP0[14]/PRU0_R31[21] Control Selects Function PRU0_R31[21] Selects Function ACLKX <i>Reserved</i> Selects Function PRU0_R30[19] <i>Reserved</i> Selects Function GP0[14] <i>Reserved</i>	I I/O X O X I/O X
3-0	PINMUX0_3_0	0 1h 2h-3h 4h 5h-7h 8h 9h-Fh	ACLKR/PRU0_R30[20]/GP0[15]/PRU0_R31[22] Control Selects Function PRU0_R31[22] Selects Function ACLKR <i>Reserved</i> Selects Function PRU0_R30[20] <i>Reserved</i> Selects Function GP0[15] <i>Reserved</i>	I I/O X O X I/O X

10.4.9.2 Pin Multiplexing Control 1 Register (PINMUX1)
Figure 10-18. Pin Multiplexing Control 1 Register (PINMUX1)

31	28	27	24	23	20	19	16
PINMUX1_31_28		PINMUX1_27_24		PINMUX1_23_20		PINMUX1_19_16	
R/W-0		R/W-0		R/W-0		R/W-0	
15	12	11	8	7	4	3	0
PINMUX1_15_12		PINMUX1_11_8		PINMUX1_7_4		PINMUX1_3_0	
R/W-0		R/W-0		R/W-0		R/W-0	

LEGEND: R/W = Read/Write; -n = value after reset

Table 10-22. Pin Multiplexing Control 1 Register (PINMUX1) Field Descriptions

Bit	Field	Value	Description	Type ⁽¹⁾
31-28	PINMUX1_31_28		AXR8/CLKS1/ECAP1_APWM1/GP0[0]/PRU0_R31[8] Control	
		0	Selects Function PRU0_R31[8]	I
		1h	Selects Function AXR8	I/O
		2h	Selects Function CLKS1	I
		3h	<i>Reserved</i>	X
		4h	Selects Function ECAP1_APWM1	I/O
		5h-7h	<i>Reserved</i>	X
		8h	Selects Function GP0[0]	I/O
9h-Fh	<i>Reserved</i>	X		
27-24	PINMUX1_27_24		AXR9/DX1/GP0[1] Control	
		0	Pin is 3-stated.	Z
		1h	Selects Function AXR9	I/O
		2h	Selects Function DX1	O
		3h-7h	<i>Reserved</i>	X
		8h	Selects Function GP0[1]	I/O
9h-Fh	<i>Reserved</i>	X		
23-20	PINMUX1_23_20		AXR10/DR1/GP0[2] Control	
		0	Pin is 3-stated.	Z
		1h	Selects Function AXR10	I/O
		2h	Selects Function DR1	I
		3h-7h	<i>Reserved</i>	X
		8h	Selects Function GP0[2]	I/O
9h-Fh	<i>Reserved</i>	X		
19-16	PINMUX1_19_16		AXR11/FSX1/GP0[3] Control	
		0	Pin is 3-stated.	Z
		1h	Selects Function AXR11	I/O
		2h	Selects Function FSX1	I/O
		3h-7h	<i>Reserved</i>	X
		8h	Selects Function GP0[3]	I/O
9h-Fh	<i>Reserved</i>	X		

⁽¹⁾ I = Input, O = Output, I/O = Bidirectional, X = Undefined, Z = High-impedance state

Table 10-22. Pin Multiplexing Control 1 Register (PINMUX1) Field Descriptions (continued)

Bit	Field	Value	Description	Type ⁽¹⁾
15-12	PINMUX1_15_12		AXR12/FSR1/GP0[4] Control	
		0	Pin is 3-stated.	Z
		1h	Selects Function AXR12	I/O
		2h	Selects Function FSR1	I/O
		3h-7h	<i>Reserved</i>	X
		8h	Selects Function GP0[4]	I/O
		9h-Fh	<i>Reserved</i>	X
11-8	PINMUX1_11_8		AXR13/CLKX1/GP0[5] Control	
		0	Pin is 3-stated.	Z
		1h	Selects Function AXR13	I/O
		2h	Selects Function CLKX1	I/O
		3h-7h	<i>Reserved</i>	X
		8h	Selects Function GP0[5]	I/O
		9h-Fh	<i>Reserved</i>	X
7-4	PINMUX1_7_4		AXR14/CLKR1/GP0[6] Control	
		0	Pin is 3-stated.	Z
		1h	Selects Function AXR14	I/O
		2h	Selects Function CLKR1	I/O
		3h-7h	<i>Reserved</i>	X
		8h	Selects Function GP0[6]	I/O
		9h-Fh	<i>Reserved</i>	X
3-0	PINMUX1_3_0		AXR15/EPWM0TZ[0]/ECAP2_APWM2/GP0[7] Control	
		0	Pin is 3-stated.	Z
		1h	Selects Function AXR15	I/O
		2h	Selects Function EPWM0TZ[0]	I
		3h	<i>Reserved</i>	X
		4h	Selects Function ECAP2_APWM2	I/O
		5h-7h	<i>Reserved</i>	X
		8h	Selects Function GP0[7]	I/O
		9h-Fh	<i>Reserved</i>	X

10.4.9.3 Pin Multiplexing Control 2 Register (PINMUX2)
Figure 10-19. Pin Multiplexing Control 2 Register (PINMUX2)

31	28	27	24	23	20	19	16
PINMUX2_31_28		PINMUX2_27_24		PINMUX2_23_20		PINMUX2_19_16	
R/W-0		R/W-0		R/W-0		R/W-0	
15	12	11	8	7	4	3	0
PINMUX2_15_12		PINMUX2_11_8		PINMUX2_7_4		PINMUX2_3_0	
R/W-0		R/W-0		R/W-0		R/W-0	

LEGEND: R/W = Read/Write; -n = value after reset

Table 10-23. Pin Multiplexing Control 2 Register (PINMUX2) Field Descriptions

Bit	Field	Value	Description	Type ⁽¹⁾
31-28	PINMUX2_31_28		AXR0/ECAP0_APWM0/GP8[7]/CLKS0 Control	
		0	Selects Function CLKS0	I
		1h	Selects Function AXR0	I/O
		2h	Selects Function ECAP0_APWM0	I/O
		3h	<i>Reserved</i>	X
		4h	Selects Function GP8[7]	I/O
5h-Fh	<i>Reserved</i>	X		
27-24	PINMUX2_27_24		AXR1/DX0/GP1[9] Control	
		0	Pin is 3-stated.	Z
		1h	Selects Function AXR1	I/O
		2h	Selects Function DX0	O
		3h	<i>Reserved</i>	X
		4h	Selects Function GP1[9]	I/O
5h-Fh	<i>Reserved</i>	X		
23-20	PINMUX2_23_20		AXR2/DR0/GP1[10] Control	
		0	Pin is 3-stated.	Z
		1h	Selects Function AXR2	I/O
		2h	Selects Function DR0	I
		3h	<i>Reserved</i>	X
		4h	Selects Function GP1[10]	I/O
5h-Fh	<i>Reserved</i>	X		
19-16	PINMUX2_19_16		AXR3/FSX0/GP1[11] Control	
		0	Pin is 3-stated.	Z
		1h	Selects Function AXR3	I/O
		2h	Selects Function FSX0	I/O
		3h	<i>Reserved</i>	X
		4h	Selects Function GP1[11]	I/O
5h-Fh	<i>Reserved</i>	X		
15-12	PINMUX2_15_12		AXR4/FSR0/GP1[12] Control	
		0	Pin is 3-stated.	Z
		1h	Selects Function AXR4	I/O
		2h	Selects Function FSR0	I/O
		3h	<i>Reserved</i>	X
		4h	Selects Function GP1[12]	I/O
5h-Fh	<i>Reserved</i>	X		

⁽¹⁾ I = Input, O = Output, I/O = Bidirectional, X = Undefined, Z = High-impedance state

Table 10-23. Pin Multiplexing Control 2 Register (PINMUX2) Field Descriptions (continued)

Bit	Field	Value	Description	Type ⁽¹⁾
11-8	PINMUX2_11_8		AXR5/CLKX0/GP1[13] Control	
		0	Pin is 3-stated.	Z
		1h	Selects Function AXR5	I/O
		2h	Selects Function CLKX0	I/O
		3h	<i>Reserved</i>	X
		4h	Selects Function GP1[13]	I/O
	5h-Fh	<i>Reserved</i>	X	
7-4	PINMUX2_7_4		AXR6/CLKR0/GP1[14]/PRU0_R31[6] Control	
		0	Selects Function PRU0_R31[6]	I
		1h	Selects Function AXR6	I/O
		2h	Selects Function CLKR0	I/O
		3h	<i>Reserved</i>	X
		4h	Selects Function GP1[14]	I/O
	5h-Fh	<i>Reserved</i>	X	
3-0	PINMUX2_3_0		AXR7/EPWM1TZ[0]/PRU0_R30[17]/GP1[15]/PRU0_R31[7] Control	
		0	Selects Function PRU0_R31[7]	I
		1h	Selects Function AXR7	I/O
		2h	Selects Function EPWM1TZ[0]	I
		3h	<i>Reserved</i>	X
		4h	Selects Function PRU0_R30[17]	O
		5h-7h	<i>Reserved</i>	X
		8h	Selects Function GP1[15]	I/O
	9h-Fh	<i>Reserved</i>	X	

10.4.9.4 Pin Multiplexing Control 3 Register (PINMUX3)
Figure 10-20. Pin Multiplexing Control 3 Register (PINMUX3)

31	28	27	24	23	20	19	16
PINMUX3_31_28		PINMUX3_27_24		PINMUX3_23_20		PINMUX3_19_16	
R/W-0		R/W-0		R/W-0		R/W-0	
15	12	11	8	7	4	3	0
PINMUX3_15_12		PINMUX3_11_8		PINMUX3_7_4		PINMUX3_3_0	
R/W-0		R/W-0		R/W-0		R/W-0	

LEGEND: R/W = Read/Write; -n = value after reset

Table 10-24. Pin Multiplexing Control 3 Register (PINMUX3) Field Descriptions

Bit	Field	Value	Description	Type ⁽¹⁾
31-28	PINMUX3_31_28		SPI0_SCS[2]/UART0_RTS/GP8[1] Control	
		0	Reserved	X
		1h	Selects Function <u>SPI0_SCS[2]</u>	I/O
		2h	Selects Function <u>UART0_RTS</u>	O
		3h	Reserved	X
		4h	Selects Function GP8[1]	I/O
27-24	PINMUX3_27_24	5h-Fh	Reserved	X
			SPI0_SCS[3]/UART0_CTS/GP8[2] Control	
		0	Reserved	X
		1h	Selects Function <u>SPI0_SCS[3]</u>	I/O
		2h	Selects Function <u>UART0_CTS</u>	I
		3h	Reserved	X
23-20	PINMUX3_23_20	4h	Selects Function GP8[2]	I/O
		5h-Fh	Reserved	X
			SPI0_SCS[4]/UART0_TXD/GP8[3] Control	
		0	Pin is 3-stated.	Z
		1h	Selects Function <u>SPI0_SCS[4]</u>	I/O
		2h	Selects Function <u>UART0_TXD</u>	O
19-16	PINMUX3_19_16	3h	Reserved	X
		4h	Selects Function GP8[3]	I/O
		5h-Fh	Reserved	X
			SPI0_SCS[5]/UART0_RXD/GP8[4] Control	
		0	Pin is 3-stated.	Z
		1h	Selects Function <u>SPI0_SCS[5]</u>	I/O
15-12	PINMUX3_15_12	2h	Selects Function <u>UART0_RXD</u>	I
		3h	Reserved	X
		4h	Selects Function GP8[4]	I/O
		5h-Fh	Reserved	X
			SPI0_SIMO/EPWMSYNCO/GP8[5] Control	
		0	Pin is 3-stated.	Z
1h	Selects Function <u>SPI0_SIMO</u>	I/O		
2h	Selects Function <u>EPWMSYNCO</u>	O		
3h	Reserved	X		
4h	Selects Function GP8[5]	I/O		
5h-Fh	Reserved	X		

⁽¹⁾ I = Input, O = Output, I/O = Bidirectional, X = Undefined, Z = High-impedance state

Table 10-24. Pin Multiplexing Control 3 Register (PINMUX3) Field Descriptions (continued)

Bit	Field	Value	Description	Type ⁽¹⁾
11-8	PINMUX3_11_8		SPI0_SOMI/EPWMSYNCI/GP8[6] Control	
		0	Pin is 3-stated.	Z
		1h	Selects Function SPI0_SOMI	I/O
		2h	Selects Function EPWMSYNCI	I
		3h	<i>Reserved</i>	X
		4h	Selects Function GP8[6]	I/O
	5h-Fh	<i>Reserved</i>	X	
7-4	PINMUX3_7_4		SPI0_ENA/EPWM0B/PRU0_R30[6] Control	
		0	Pin is 3-stated.	Z
		1h	Selects Function SPI0_ENA	I/O
		2h	Selects Function EPWM0B	I/O
		3h	<i>Reserved</i>	X
		4h	Selects Function PRU0_R30[6]	O
	5h-Fh	<i>Reserved</i>	X	
3-0	PINMUX3_3_0		SPI0_CLK/EPWM0A/GP1[8] Control	
		0	Pin is 3-stated.	Z
		1h	Selects Function SPI0_CLK	I/O
		2h	Selects Function EPWM0A	I/O
		3h	<i>Reserved</i>	X
		4h	Selects Function GP1[8]	I/O
	5h-Fh	<i>Reserved</i>	X	

10.4.9.5 Pin Multiplexing Control 4 Register (PINMUX4)
Figure 10-21. Pin Multiplexing Control 4 Register (PINMUX4)

31	28	27	24	23	20	19	16
PINMUX4_31_28		PINMUX4_27_24		PINMUX4_23_20		PINMUX4_19_16	
R/W-0		R/W-0		R/W-0		R/W-0	
15	12	11	8	7	4	3	0
PINMUX4_15_12		PINMUX4_11_8		PINMUX4_7_4		PINMUX4_3_0	
R/W-0		R/W-0		R/W-0		R/W-0	

LEGEND: R/W = Read/Write; -n = value after reset

Table 10-25. Pin Multiplexing Control 4 Register (PINMUX4) Field Descriptions

Bit	Field	Value	Description	Type ⁽¹⁾
31-28	PINMUX4_31_28		SPI1_SCS[2]/UART1_TXD/GP1[0] Control	
		0	Pin is 3-stated.	Z
		1h	Selects Function $\overline{\text{SPI1_SCS}}[2]$	I/O
		2h	Selects Function UART1_TXD	O
		3h-7h	Reserved	X
		8h	Selects Function GP1[0]	I/O
27-24	PINMUX4_27_24		SPI1_SCS[3]/UART1_RXD/GP1[1] Control	
		0	Pin is 3-stated.	Z
		1h	Selects Function $\overline{\text{SPI1_SCS}}[3]$	I/O
		2h	Selects Function UART1_RXD	I
		3h-7h	Reserved	X
		8h	Selects Function GP1[1]	I/O
23-20	PINMUX4_23_20		SPI1_SCS[4]/UART2_TXD/I2C1_SDA/GP1[2] Control	
		0	Pin is 3-stated.	Z
		1h	Selects Function $\overline{\text{SPI1_SCS}}[4]$	I/O
		2h	Selects Function UART2_TXD	O
		3h	Reserved	X
		4h	Selects Function I2C1_SDA	I/O
19-16	PINMUX4_19_16		SPI1_SCS[5]/UART2_RXD/I2C1_SCL/GP1[3] Control	
		0	Pin is 3-stated.	Z
		1h	Selects Function $\overline{\text{SPI1_SCS}}[5]$	I/O
		2h	Selects Function UART2_RXD	I
		3h	Reserved	X
		4h	Selects Function I2C1_SCL	I/O
	5h-7h	Reserved	X	
	8h	Selects Function GP1[3]	I/O	
	9h-Fh	Reserved	X	

⁽¹⁾ I = Input, O = Output, I/O = Bidirectional, X = Undefined, Z = High-impedance state

Table 10-25. Pin Multiplexing Control 4 Register (PINMUX4) Field Descriptions (continued)

Bit	Field	Value	Description	Type ⁽¹⁾
15-12	PINMUX4_15_12	0 1h 2h 3h 4h 5h-7h 8h 9h-Fh	SPI1_SCS[6]/I2C0_SDA/TM64P3_OUT12/GP1[4] Control Pin is 3-stated. Selects Function <u>SPI1_SCS[6]</u> Selects Function I2C0_SDA <i>Reserved</i> Selects Function TM64P3_OUT12 <i>Reserved</i> Selects Function GP1[4] <i>Reserved</i>	Z I/O I/O X O X I/O X
11-8	PINMUX4_11_8	0 1h 2h 3h 4h 5h-7h 8h 9h-Fh	SPI1_SCS[7]/I2C0_SCL/TM64P2_OUT12/GP1[5] Control Pin is 3-stated. Selects Function <u>SPI1_SCS[7]</u> Selects Function I2C0_SCL <i>Reserved</i> Selects Function TM64P2_OUT12 <i>Reserved</i> Selects Function GP1[5] <i>Reserved</i>	Z I/O I/O X O X I/O X
7-4	PINMUX4_7_4	0 1h 2h 3h 4h 5h-Fh	SPI0_SCS[0]/TM64P1_OUT12/GP1[6]/TM64P1_IN12 Control Selects Function TM64P1_IN12 Selects Function <u>SPI0_SCS[0]</u> Selects Function TM64P1_OUT12 <i>Reserved</i> Selects Function GP1[6] <i>Reserved</i>	I I/O O X I/O X
3-0	PINMUX4_3_0	0 1h 2h 3h 4h 5h-Fh	SPI0_SCS[1]/TM64P0_OUT12/GP1[7]/TM64P0_IN12 Control Selects Function TM64P0_IN12 Selects Function <u>SPI0_SCS[1]</u> Selects Function TM64P0_OUT12 <i>Reserved</i> Selects Function GP1[7] <i>Reserved</i>	I I/O O X I/O X

10.4.9.6 Pin Multiplexing Control 5 Register (PINMUX5)

Figure 10-22. Pin Multiplexing Control 5 Register (PINMUX5)

31	28	27	24	23	20	19	16
PINMUX5_31_28		PINMUX5_27_24		PINMUX5_23_20		PINMUX5_19_16	
R/W-0		R/W-0		R/W-0		R/W-0	
15	12	11	8	7	4	3	0
PINMUX5_15_12		PINMUX5_11_8		PINMUX5_7_4		PINMUX5_3_0	
R/W-0		R/W-0		R/W-0		R/W-0	

LEGEND: R/W = Read/Write; -n = value after reset

Table 10-26. Pin Multiplexing Control 5 Register (PINMUX5) Field Descriptions

Bit	Field	Value	Description	Type ⁽¹⁾
31-28	PINMUX5_31_28	0	EMA_BA[0]/GP2[8] Control Pin is 3-stated.	Z
		1h	Selects Function EMA_BA[0]	O
		2h-7h	<i>Reserved</i>	X
		8h	Selects Function GP2[8]	I/O
		9h-Fh	<i>Reserved</i>	X
27-24	PINMUX5_27_24	0	EMA_BA[1]/GP2[9] Control Pin is 3-stated.	Z
		1h	Selects Function EMA_BA[1]	O
		2h-7h	<i>Reserved</i>	X
		8h	Selects Function GP2[9]	I/O
		9h-Fh	<i>Reserved</i>	X
23-20	PINMUX5_23_20	0	SPI1_SIMO/GP2[10] Control Pin is 3-stated.	Z
		1h	Selects Function SPI1_SIMO	I/O
		2h-7h	<i>Reserved</i>	X
		8h	Selects Function GP2[10]	I/O
		9h-Fh	<i>Reserved</i>	X
19-16	PINMUX5_19_16	0	SPI1_SOMI/GP2[11] Control Pin is 3-stated.	Z
		1h	Selects Function SPI1_SOMI	I/O
		2h-7h	<i>Reserved</i>	X
		8h	Selects Function GP2[11]	I/O
		9h-Fh	<i>Reserved</i>	X
15-12	PINMUX5_15_12	0	SPI1_ENA/GP2[12] Control Pin is 3-stated.	Z
		1h	Selects Function $\overline{\text{SPI1_ENA}}$	I/O
		2h-7h	<i>Reserved</i>	X
		8h	Selects Function GP2[12]	I/O
		9h-Fh	<i>Reserved</i>	X

⁽¹⁾ I = Input, O = Output, I/O = Bidirectional, X = Undefined, Z = High-impedance state

Table 10-26. Pin Multiplexing Control 5 Register (PINMUX5) Field Descriptions (continued)

Bit	Field	Value	Description	Type ⁽¹⁾
11-8	PINMUX5_11_8		SPI1_CLK/GP2[13] Control	
		0	Pin is 3-stated.	Z
		1h	Selects Function SPI1_CLK	I/O
		2h-7h	<i>Reserved</i>	X
		8h	Selects Function GP2[13]	I/O
		9h-Fh	<i>Reserved</i>	X
7-4	PINMUX5_7_4		SPI1_SCS[0]/EPWM1B/PRU0_R30[7]/GP2[14]/TM64P3_IN12 Control	
		0	Selects Function TM64P3_IN12	I
		1h	Selects Function SPI1_SCS[0]	I/O
		2h	Selects Function EPWM1B	I/O
		3h	<i>Reserved</i>	X
		4h	Selects Function PRU0_R30[7]	O
		5h-7h	<i>Reserved</i>	X
		8h	Selects Function GP2[14]	I/O
		9h-Fh	<i>Reserved</i>	X
3-0	PINMUX5_3_0		SPI1_SCS[1]/EPWM1A/PRU0_R30[8]/GP2[15]/TM64P2_IN12 Control	
		0	Selects Function TM64P2_IN12	I
		1h	Selects Function SPI1_SCS[1]	I/O
		2h	Selects Function EPWM1A	I/O
		3h	<i>Reserved</i>	X
		4h	Selects Function PRU0_R30[8]	O
		5h-7h	<i>Reserved</i>	X
		8h	Selects Function GP2[15]	I/O
		9h-Fh	<i>Reserved</i>	X

10.4.9.7 Pin Multiplexing Control 6 Register (PINMUX6)
Figure 10-23. Pin Multiplexing Control 6 Register (PINMUX6)

31	28	27	24	23	20	19	16
PINMUX6_31_28		PINMUX6_27_24		PINMUX6_23_20		PINMUX6_19_16	
R/W-0		R/W-0		R/W-0		R/W-0	
15	12	11	8	7	4	3	0
PINMUX6_15_12		PINMUX6_11_8		PINMUX6_7_4		PINMUX6_3_0	
R/W-0		R/W-0		R/W-0		R/W-0	

LEGEND: R/W = Read/Write; -n = value after reset

Table 10-27. Pin Multiplexing Control 6 Register (PINMUX6) Field Descriptions

Bit	Field	Value	Description	Type ⁽¹⁾
31-28	PINMUX6_31_28		EMA_CS[0]/GP2[0] Control	
		0	Pin is 3-stated.	Z
		1h	Selects Function EMA_CS[0]	O
		2h-7h	Reserved	X
		8h	Selects Function GP2[0]	I/O
9h-Fh	Reserved	X		
27-24	PINMUX6_27_24		EMA_WAIT[1]/PRU0_R30[1]/GP2[1]/PRU0_R31[1] Control	
		0	Selects Function PRU0_R31[1]	I
		1h	Selects Function EMA_WAIT[1]	I
		2h-3h	Reserved	X
		4h	Selects Function PRU0_R30[1]	O
		5h-7h	Reserved	X
8h	Selects Function GP2[1]	I/O		
9h-Fh	Reserved	X		
23-20	PINMUX6_23_20		EMA_WE_DQM[1]/GP2[2] Control	
		0	Pin is 3-stated.	Z
		1h	Selects Function EMA_WE_DQM[1]	O
		2h-7h	Reserved	X
		8h	Selects Function GP2[2]	I/O
9h-Fh	Reserved	X		
19-16	PINMUX6_19_16		EMA_WE_DQM[0]/GP2[3] Control	
		0	Pin is 3-stated.	Z
		1h	Selects Function EMA_WE_DQM[0]	O
		2h-7h	Reserved	X
		8h	Selects Function GP2[3]	I/O
9h-Fh	Reserved	X		
15-12	PINMUX6_15_12		EMA_CAS/PRU0_R30[2]/GP2[4]/PRU0_R31[2] Control	
		0	Selects Function PRU0_R31[2]	I
		1h	Selects Function EMA_CAS	O
		2h-3h	Reserved	X
		4h	Selects Function PRU0_R30[2]	O
		5h-7h	Reserved	X
8h	Selects Function GP2[4]	I/O		
9h-Fh	Reserved	X		

⁽¹⁾ I = Input, O = Output, I/O = Bidirectional, X = Undefined, Z = High-impedance state

Table 10-27. Pin Multiplexing Control 6 Register (PINMUX6) Field Descriptions (continued)

Bit	Field	Value	Description	Type ⁽¹⁾
11-8	PINMUX6_11_8		EMA_RAS/PRU0_R30[3]/GP2[5]/PRU0_R31[3] Control	
		0	Selects Function PRU0_R31[3]	I
		1h	Selects Function EMA_RAS	O
		2h-3h	<i>Reserved</i>	X
		4h	Selects Function PRU0_R30[3]	O
		5h-7h	<i>Reserved</i>	X
		8h	Selects Function GP2[5]	I/O
		9h-Fh	<i>Reserved</i>	X
7-4	PINMUX6_7_4		EMA_SDCKE/PRU0_R30[4]/GP2[6]/PRU0_R31[4] Control	
		0	Selects Function PRU0_R31[4]	I
		1h	Selects Function EMA_SDCKE	O
		2h-3h	<i>Reserved</i>	X
		4h	Selects Function PRU0_R30[4]	O
		5h-7h	<i>Reserved</i>	X
		8h	Selects Function GP2[6]	I/O
		9h-Fh	<i>Reserved</i>	X
3-0	PINMUX6_3_0		EMA_CLK/PRU0_R30[5]/GP2[7]/PRU0_R31[5] Control	
		0	Selects Function PRU0_R31[5]	I
		1h	Selects Function EMA_CLK	O
		2h-3h	<i>Reserved</i>	X
		4h	Selects Function PRU0_R30[5]	O
		5h-7h	<i>Reserved</i>	X
		8h	Selects Function GP2[7]	I/O
		9h-Fh	<i>Reserved</i>	X

10.4.9.8 Pin Multiplexing Control 7 Register (PINMUX7)
Figure 10-24. Pin Multiplexing Control 7 Register (PINMUX7)

31	28	27	24	23	20	19	16
PINMUX7_31_28		PINMUX7_27_24		PINMUX7_23_20		PINMUX7_19_16	
R/W-0		R/W-0		R/W-0		R/W-0	
15	12	11	8	7	4	3	0
PINMUX7_15_12		PINMUX7_11_8		PINMUX7_7_4		PINMUX7_3_0	
R/W-0		R/W-0		R/W-0		R/W-0	

LEGEND: R/W = Read/Write; -n = value after reset

Table 10-28. Pin Multiplexing Control 7 Register (PINMUX7) Field Descriptions

Bit	Field	Value	Description	Type ⁽¹⁾
31-28	PINMUX7_31_28		EMA_WAIT[0]/PRU0_R30[0]/GP3[8]/PRU0_R31[0] Control	
		0	Selects Function PRU0_R31[0]	I
		1h	Selects Function EMA_WAIT[0]	I
		2h-3h	Reserved	X
		4h	Selects Function PRU0_R30[0]	O
		5h-7h	Reserved	X
		8h	Selects Function GP3[8]	I/O
27-24	PINMUX7_27_24		EMA_A_R\bar{W}/GP3[9] Control	
		0	Pin is 3-stated.	Z
		1h	Selects Function EMA_A_R \bar{W}	O
		2h-7h	Reserved	X
		8h	Selects Function GP3[9]	I/O
23-20	PINMUX7_23_20		EMA_OE/GP3[10] Control	
		0	Pin is 3-stated.	Z
		1h	Selects Function EMA_OE	O
		2h-7h	Reserved	X
		8h	Selects Function GP3[10]	I/O
19-16	PINMUX7_19_16		EMA_WE/GP3[11] Control	
		0	Pin is 3-stated.	Z
		1h	Selects Function EMA_WE	O
		2h-7h	Reserved	X
		8h	Selects Function GP3[11]	I/O
15-12	PINMUX7_15_12		EMA_CS[5]/GP3[12] Control	
		0	Pin is 3-stated.	Z
		1h	Selects Function EMA_CS[5]	O
		2h-7h	Reserved	X
		8h	Selects Function GP3[12]	I/O
		9h-Fh	Reserved	X

⁽¹⁾ I = Input, O = Output, I/O = Bidirectional, X = Undefined, Z = High-impedance state

Table 10-28. Pin Multiplexing Control 7 Register (PINMUX7) Field Descriptions (continued)

Bit	Field	Value	Description	Type ⁽¹⁾
11-8	PINMUX7_11_8		EMA_CS[4]/GP3[13] Control	
		0	Pin is 3-stated.	Z
		1h	Selects Function <u>EMA_CS[4]</u>	O
		2h-7h	<i>Reserved</i>	X
		8h	Selects Function GP3[13]	I/O
		9h-Fh	<i>Reserved</i>	X
7-4	PINMUX7_7_4		EMA_CS[3]/GP3[14] Control	
		0	Pin is 3-stated.	Z
		1h	Selects Function <u>EMA_CS[3]</u>	O
		2h-7h	<i>Reserved</i>	X
		8h	Selects Function GP3[14]	I/O
		9h-Fh	<i>Reserved</i>	X
3-0	PINMUX7_3_0		EMA_CS[2]/GP3[15] Control	
		0	Pin is 3-stated.	Z
		1h	Selects Function <u>EMA_CS[2]</u>	O
		2h-7h	<i>Reserved</i>	X
		8h	Selects Function GP3[15]	I/O
		9h-Fh	<i>Reserved</i>	X

10.4.9.9 Pin Multiplexing Control 8 Register (PINMUX8)
Figure 10-25. Pin Multiplexing Control 8 Register (PINMUX8)

31	28	27	24	23	20	19	16
PINMUX8_31_28		PINMUX8_27_24		PINMUX8_23_20		PINMUX8_19_16	
R/W-0		R/W-0		R/W-0		R/W-0	
15	12	11	8	7	4	3	0
PINMUX8_15_12		PINMUX8_11_8		PINMUX8_7_4		PINMUX8_3_0	
R/W-0		R/W-0		R/W-0		R/W-0	

LEGEND: R/W = Read/Write; -n = value after reset

Table 10-29. Pin Multiplexing Control 8 Register (PINMUX8) Field Descriptions

Bit	Field	Value	Description	Type ⁽¹⁾
31-28	PINMUX8_31_28	0	EMA_D[8]/GP3[0] Control Pin is 3-stated.	Z
		1h	Selects Function EMA_D[8]	I/O
		2h-7h	<i>Reserved</i>	X
		8h	Selects Function GP3[0]	I/O
		9h-Fh	<i>Reserved</i>	X
27-24	PINMUX8_27_24	0	EMA_D[9]/GP3[1] Control Pin is 3-stated.	Z
		1h	Selects Function EMA_D[9]	I/O
		2h-7h	<i>Reserved</i>	X
		8h	Selects Function GP3[1]	I/O
		9h-Fh	<i>Reserved</i>	X
23-20	PINMUX8_23_20	0	EMA_D[10]/GP3[2] Control Pin is 3-stated.	Z
		1h	Selects Function EMA_D[10]	I/O
		2h-7h	<i>Reserved</i>	X
		8h	Selects Function GP3[2]	I/O
		9h-Fh	<i>Reserved</i>	X
19-16	PINMUX8_19_16	0	EMA_D[11]/GP3[3] Control Pin is 3-stated.	Z
		1h	Selects Function EMA_D[11]	I/O
		2h-7h	<i>Reserved</i>	X
		8h	Selects Function GP3[3]	I/O
		9h-Fh	<i>Reserved</i>	X
15-12	PINMUX8_15_12	0	EMA_D[12]/GP3[4] Control Pin is 3-stated.	Z
		1h	Selects Function EMA_D[12]	I/O
		2h-7h	<i>Reserved</i>	X
		8h	Selects Function GP3[4]	I/O
		9h-Fh	<i>Reserved</i>	X

⁽¹⁾ I = Input, O = Output, I/O = Bidirectional, X = Undefined, Z = High-impedance state

Table 10-29. Pin Multiplexing Control 8 Register (PINMUX8) Field Descriptions (continued)

Bit	Field	Value	Description	Type ⁽¹⁾
11-8	PINMUX8_11_8		EMA_D[13]/GP3[5] Control	
		0	Pin is 3-stated.	Z
		1h	Selects Function EMA_D[13]	I/O
		2h-7h	<i>Reserved</i>	X
		8h	Selects Function GP3[5]	I/O
		9h-Fh	<i>Reserved</i>	X
7-4	PINMUX8_7_4		EMA_D[14]/GP3[6] Control	
		0	Pin is 3-stated.	Z
		1h	Selects Function EMA_D[14]	I/O
		2h-7h	<i>Reserved</i>	X
		8h	Selects Function GP3[6]	I/O
		9h-Fh	<i>Reserved</i>	X
3-0	PINMUX8_3_0		EMA_D[15]/GP3[7] Control	
		0	Pin is 3-stated.	Z
		1h	Selects Function EMA_D[15]	I/O
		2h-7h	<i>Reserved</i>	X
		8h	Selects Function GP3[7]	I/O
		9h-Fh	<i>Reserved</i>	X

10.4.9.10 Pin Multiplexing Control 9 Register (PINMUX9)
Figure 10-26. Pin Multiplexing Control 9 Register (PINMUX9)

31	28	27	24	23	20	19	16
PINMUX9_31_28		PINMUX9_27_24		PINMUX9_23_20		PINMUX9_19_16	
R/W-0		R/W-0		R/W-0		R/W-0	
15	12	11	8	7	4	3	0
PINMUX9_15_12		PINMUX9_11_8		PINMUX9_7_4		PINMUX9_3_0	
R/W-0		R/W-0		R/W-0		R/W-0	

LEGEND: R/W = Read/Write; -n = value after reset

Table 10-30. Pin Multiplexing Control 9 Register (PINMUX9) Field Descriptions

Bit	Field	Value	Description	Type ⁽¹⁾
31-28	PINMUX9_31_28	0	EMA_D[0]/GP4[8] Control Pin is 3-stated.	Z
		1h	Selects Function EMA_D[0]	I/O
		2h-7h	<i>Reserved</i>	X
		8h	Selects Function GP4[8]	I/O
		9h-Fh	<i>Reserved</i>	X
27-24	PINMUX9_27_24	0	EMA_D[1]/GP4[9] Control Pin is 3-stated.	Z
		1h	Selects Function EMA_D[1]	I/O
		2h-7h	<i>Reserved</i>	X
		8h	Selects Function GP4[9]	I/O
		9h-Fh	<i>Reserved</i>	X
23-20	PINMUX9_23_20	0	EMA_D[2]/GP4[10] Control Pin is 3-stated.	Z
		1h	Selects Function EMA_D[2]	I/O
		2h-7h	<i>Reserved</i>	X
		8h	Selects Function GP4[10]	I/O
		9h-Fh	<i>Reserved</i>	X
19-16	PINMUX9_19_16	0	EMA_D[3]/GP4[11] Control Pin is 3-stated.	Z
		1h	Selects Function EMA_D[3]	I/O
		2h-7h	<i>Reserved</i>	X
		8h	Selects Function GP4[11]	I/O
		9h-Fh	<i>Reserved</i>	X
15-12	PINMUX9_15_12	0	EMA_D[4]/GP4[12] Control Pin is 3-stated.	Z
		1h	Selects Function EMA_D[4]	I/O
		2h-7h	<i>Reserved</i>	X
		8h	Selects Function GP4[12]	I/O
		9h-Fh	<i>Reserved</i>	X

⁽¹⁾ I = Input, O = Output, I/O = Bidirectional, X = Undefined, Z = High-impedance state

Table 10-30. Pin Multiplexing Control 9 Register (PINMUX9) Field Descriptions (continued)

Bit	Field	Value	Description	Type ⁽¹⁾
11-8	PINMUX9_11_8		EMA_D[5]/GP4[13] Control	
		0	Pin is 3-stated.	Z
		1h	Selects Function EMA_D[5]	I/O
		2h-7h	<i>Reserved</i>	X
		8h	Selects Function GP4[13]	I/O
		9h-Fh	<i>Reserved</i>	X
7-4	PINMUX9_7_4		EMA_D[6]/GP4[14] Control	
		0	Pin is 3-stated.	Z
		1h	Selects Function EMA_D[6]	I/O
		2h-7h	<i>Reserved</i>	X
		8h	Selects Function GP4[14]	I/O
		9h-Fh	<i>Reserved</i>	X
3-0	PINMUX9_3_0		EMA_D[7]/GP4[15] Control	
		0	Pin is 3-stated.	Z
		1h	Selects Function EMA_D[7]	I/O
		2h-7h	<i>Reserved</i>	X
		8h	Selects Function GP4[15]	I/O
		9h-Fh	<i>Reserved</i>	X

10.4.9.11 Pin Multiplexing Control 10 Register (PINMUX10)
Figure 10-27. Pin Multiplexing Control 10 Register (PINMUX10)

31	28	27	24	23	20	19	16
PINMUX10_31_28		PINMUX10_27_24		PINMUX10_23_20		PINMUX10_19_16	
R/W-0		R/W-0		R/W-0		R/W-0	
15	12	11	8	7	4	3	0
PINMUX10_15_12		PINMUX10_11_8		PINMUX10_7_4		PINMUX10_3_0	
R/W-0		R/W-0		R/W-0		R/W-0	

LEGEND: R/W = Read/Write; -n = value after reset

Table 10-31. Pin Multiplexing Control 10 Register (PINMUX10) Field Descriptions

Bit	Field	Value	Description	Type ⁽¹⁾
31-28	PINMUX10_31_28		EMA_A[16]/MMCSO0_DAT[5]/PRU1_R30[24]/GP4[0] Control	
		0	Pin is 3-stated.	Z
		1h	Selects Function EMA_A[16]	O
		2h	Selects Function MMCSO0_DAT[5]	I/O
		3h	<i>Reserved</i>	X
		4h	Selects Function PRU1_R30[24]	O
		5h-7h	<i>Reserved</i>	X
		8h	Selects Function GP4[0]	I/O
	9h-Fh	<i>Reserved</i>	X	
27-24	PINMUX10_27_24		EMA_A[17]/MMCSO0_DAT[4]/PRU1_R30[25]/GP4[1] Control	
		0	Pin is 3-stated.	Z
		1h	Selects Function EMA_A[17]	O
		2h	Selects Function MMCSO0_DAT[4]	I/O
		3h	<i>Reserved</i>	X
		4h	Selects Function PRU1_R30[25]	O
		5h-7h	<i>Reserved</i>	X
		8h	Selects Function GP4[1]	I/O
	9h-Fh	<i>Reserved</i>	X	
23-20	PINMUX10_23_20		EMA_A[18]/MMCSO0_DAT[3]/PRU1_R30[26]/GP4[2] Control	
		0	Pin is 3-stated.	Z
		1h	Selects Function EMA_A[18]	O
		2h	Selects Function MMCSO0_DAT[3]	I/O
		3h	<i>Reserved</i>	X
		4h	Selects Function PRU1_R30[26]	O
		5h-7h	<i>Reserved</i>	X
		8h	Selects Function GP4[2]	I/O
	9h-Fh	<i>Reserved</i>	X	

⁽¹⁾ I = Input, O = Output, I/O = Bidirectional, X = Undefined, Z = High-impedance state

Table 10-31. Pin Multiplexing Control 10 Register (PINMUX10) Field Descriptions (continued)

Bit	Field	Value	Description	Type ⁽¹⁾
19-16	PINMUX10_19_16	0 1h 2h 3h 4h 5h-7h 8h 9h-Fh	EMA_A[19]/MMCSO0_DAT[2]/PRU1_R30[27]/GP4[3] Control Pin is 3-stated. Selects Function EMA_A[19] Selects Function MMCSO0_DAT[2] <i>Reserved</i> Selects Function PRU1_R30[27] <i>Reserved</i> Selects Function GP4[3] <i>Reserved</i>	Z O I/O X O X I/O X
15-12	PINMUX10_15_12	0 1h 2h 3h 4h 5h-7h 8h 9h-Fh	EMA_A[20]/MMCSO0_DAT[1]/PRU1_R30[28]/GP4[4] Control Pin is 3-stated. Selects Function EMA_A[20] Selects Function MMCSO0_DAT[1] <i>Reserved</i> Selects Function PRU1_R30[28] <i>Reserved</i> Selects Function GP4[4] <i>Reserved</i>	Z O I/O X O X I/O X
11-8	PINMUX10_11_8	0 1h 2h 3h 4h 5h-7h 8h 9h-Fh	EMA_A[21]/MMCSO0_DAT[0]/PRU1_R30[29]/GP4[5] Control Pin is 3-stated. Selects Function EMA_A[21] Selects Function MMCSO0_DAT[0] <i>Reserved</i> Selects Function PRU1_R30[29] <i>Reserved</i> Selects Function GP4[5] <i>Reserved</i>	Z O I/O X O X I/O X
7-4	PINMUX10_7_4	0 1h 2h 3h 4h 5h-7h 8h 9h-Fh	EMA_A[22]/MMCSO0_CMD/PRU1_R30[30]/GP4[6] Control Pin is 3-stated. Selects Function EMA_A[22] Selects Function MMCSO0_CMD <i>Reserved</i> Selects Function PRU1_R30[30] <i>Reserved</i> Selects Function GP4[6] <i>Reserved</i>	Z O I/O X O X I/O X
3-0	PINMUX10_3_0	0 1h 2h 3h 4h 5h-7h 8h 9h-Fh	MMCSO0_CLK/PRU1_R30[31]/GP4[7] Control Pin is 3-stated. <i>Reserved</i> Selects Function MMCSO0_CLK <i>Reserved</i> Selects Function PRU1_R30[31] <i>Reserved</i> Selects Function GP4[7] <i>Reserved</i>	Z X O X O X I/O X

10.4.9.12 Pin Multiplexing Control 11 Register (PINMUX11)
Figure 10-28. Pin Multiplexing Control 11 Register (PINMUX11)

31	28	27	24	23	20	19	16
PINMUX11_31_28		PINMUX11_27_24		PINMUX11_23_20		PINMUX11_19_16	
R/W-0		R/W-0		R/W-0		R/W-0	
15	12	11	8	7	4	3	0
PINMUX11_15_12		PINMUX11_11_8		PINMUX11_7_4		PINMUX11_3_0	
R/W-0		R/W-0		R/W-0		R/W-0	

LEGEND: R/W = Read/Write; -n = value after reset

Table 10-32. Pin Multiplexing Control 11 Register (PINMUX11) Field Descriptions

Bit	Field	Value	Description	Type ⁽¹⁾
31-28	PINMUX11_31_28		EMA_A[8]/PRU1_R30[16]/GP5[8] Control	
		0	Pin is 3-stated.	Z
		1h	Selects Function EMA_A[8]	O
		2h-3h	Reserved	X
		4h	Selects Function PRU1_R30[16]	O
		5h-7h	Reserved	X
		8h	Selects Function GP5[8]	I/O
27-24	PINMUX11_27_24		EMA_A[9]/PRU1_R30[17]/GP5[9] Control	
		0	Pin is 3-stated.	Z
		1h	Selects Function EMA_A[9]	O
		2h-3h	Reserved	X
		4h	Selects Function PRU1_R30[17]	O
		5h-7h	Reserved	X
		8h	Selects Function GP5[9]	I/O
23-20	PINMUX11_23_20		EMA_A[10]/PRU1_R30[18]/GP5[10]/PRU1_R31[18] Control	
		0	Selects Function PRU1_R31[18]	I
		1h	Selects Function EMA_A[10]	O
		2h-3h	Reserved	X
		4h	Selects Function PRU1_R30[18]	O
		5h-7h	Reserved	X
		8h	Selects Function GP5[10]	I/O
19-16	PINMUX11_19_16		EMA_A[11]/PRU1_R30[19]/GP5[11]/PRU1_R31[19] Control	
		0	Selects Function PRU1_R31[19]	I
		1h	Selects Function EMA_A[11]	O
		2h-3h	Reserved	X
		4h	Selects Function PRU1_R30[19]	O
		5h-7h	Reserved	X
		8h	Selects Function GP5[11]	I/O
	9h-Fh	Reserved	X	

⁽¹⁾ I = Input, O = Output, I/O = Bidirectional, X = Undefined, Z = High-impedance state

Table 10-32. Pin Multiplexing Control 11 Register (PINMUX11) Field Descriptions (continued)

Bit	Field	Value	Description	Type ⁽¹⁾
15-12	PINMUX11_15_12	0 1h 2h-3h 4h 5h-7h 8h 9h-Fh	EMA_A[12]/PRU1_R30[20]/GP5[12]/PRU1_R31[20] Control Selects Function PRU1_R31[20] Selects Function EMA_A[12] <i>Reserved</i> Selects Function PRU1_R30[20] <i>Reserved</i> Selects Function GP5[12] <i>Reserved</i>	I O X O X I/O X
11-8	PINMUX11_11_8	0 1h 2h 3h 4h 5h-7h 8h 9h-Fh	EMA_A[13]/PRU0_R30[21]/PRU1_R30[21]/GP5[13]/PRU1_R31[21] Control Selects Function PRU1_R31[21] Selects Function EMA_A[13] Selects Function PRU0_R30[21] <i>Reserved</i> Selects Function PRU1_R30[21] <i>Reserved</i> Selects Function GP5[13] <i>Reserved</i>	I O O X O X I/O X
7-4	PINMUX11_7_4	0 1h 2h 3h 4h 5h-7h 8h 9h-Fh	EMA_A[14]/MMCSO_DAT[7]/PRU1_R30[22]/GP5[14]/PRU1_R31[22] Control Selects Function PRU1_R31[22] Selects Function EMA_A[14] Selects Function MMCSO_DAT[7] <i>Reserved</i> Selects Function PRU1_R30[22] <i>Reserved</i> Selects Function GP5[14] <i>Reserved</i>	I O I/O X O X I/O X
3-0	PINMUX11_3_0	0 1h 2h 3h 4h 5h-7h 8h 9h-Fh	EMA_A[15]/MMCSO_DAT[6]/PRU1_R30[23]/GP5[15]/PRU1_R31[23] Control Selects Function PRU1_R31[23] Selects Function EMA_A[15] Selects Function MMCSO_DAT[6] <i>Reserved</i> Selects Function PRU1_R30[23] <i>Reserved</i> Selects Function GP5[15] <i>Reserved</i>	I O I/O X O X I/O X

10.4.9.13 Pin Multiplexing Control 12 Register (PINMUX12)

Figure 10-29. Pin Multiplexing Control 12 Register (PINMUX12)

31	28	27	24	23	20	19	16
PINMUX12_31_28		PINMUX12_27_24		PINMUX12_23_20		PINMUX12_19_16	
R/W-0		R/W-0		R/W-0		R/W-0	
15	12	11	8	7	4	3	0
PINMUX12_15_12		PINMUX12_11_8		PINMUX12_7_4		PINMUX12_3_0	
R/W-0		R/W-0		R/W-0		R/W-0	

LEGEND: R/W = Read/Write; -n = value after reset

Table 10-33. Pin Multiplexing Control 12 Register (PINMUX12) Field Descriptions

Bit	Field	Value	Description	Type ⁽¹⁾
31-28	PINMUX12_31_28	0	EMA_A[0]/GP5[0] Control Pin is 3-stated.	Z
		1h	Selects Function EMA_A[0]	O
		2h-7h	<i>Reserved</i>	X
		8h	Selects Function GP5[0]	I/O
		9h-Fh	<i>Reserved</i>	X
27-24	PINMUX12_27_24	0	EMA_A[1]/GP5[1] Control Pin is 3-stated.	Z
		1h	Selects Function EMA_A[1]	O
		2h-7h	<i>Reserved</i>	X
		8h	Selects Function GP5[1]	I/O
		9h-Fh	<i>Reserved</i>	X
23-20	PINMUX12_23_20	0	EMA_A[2]/GP5[2] Control Pin is 3-stated.	Z
		1h	Selects Function EMA_A[2]	O
		2h-7h	<i>Reserved</i>	X
		8h	Selects Function GP5[2]	I/O
		9h-Fh	<i>Reserved</i>	X
19-16	PINMUX12_19_16	0	EMA_A[3]/GP5[3] Control Pin is 3-stated.	Z
		1h	Selects Function EMA_A[3]	O
		2h-7h	<i>Reserved</i>	X
		8h	Selects Function GP5[3]	I/O
		9h-Fh	<i>Reserved</i>	X
15-12	PINMUX12_15_12	0	EMA_A[4]/GP5[4] Control Pin is 3-stated.	Z
		1h	Selects Function EMA_A[4]	O
		2h-7h	<i>Reserved</i>	X
		8h	Selects Function GP5[4]	I/O
		9h-Fh	<i>Reserved</i>	X

⁽¹⁾ I = Input, O = Output, I/O = Bidirectional, X = Undefined, Z = High-impedance state

Table 10-33. Pin Multiplexing Control 12 Register (PINMUX12) Field Descriptions (continued)

Bit	Field	Value	Description	Type ⁽¹⁾
11-8	PINMUX12_11_8	0 1h 2h-7h 8h 9h-Fh	EMA_A[5]/GP5[5] Control Pin is 3-stated. Selects Function EMA_A[5] <i>Reserved</i> Selects Function GP5[5] <i>Reserved</i>	Z O X I/O X
7-4	PINMUX12_7_4	0 1h 2h-7h 8h 9h-Fh	EMA_A[6]/GP5[6] Control Pin is 3-stated. Selects Function EMA_A[6] <i>Reserved</i> Selects Function GP5[6] <i>Reserved</i>	Z O X I/O X
3-0	PINMUX12_3_0	0 1h 2h-3h 4h 5h-7h 8h 9h-Fh	EMA_A[7]/PRU1_R30[15]/GP5[7] Control Pin is 3-stated. Selects Function EMA_A[7] <i>Reserved</i> Selects Function PRU1_R30[15] <i>Reserved</i> Selects Function GP5[7] <i>Reserved</i>	Z O X O X I/O X

10.4.9.14 Pin Multiplexing Control 13 Register (PINMUX13)
Figure 10-30. Pin Multiplexing Control 13 Register (PINMUX13)

31	28	27	24	23	20	19	16
PINMUX13_31_28		PINMUX13_27_24		PINMUX13_23_20		PINMUX13_19_16	
R/W-0		R/W-0		R/W-0		R/W-0	
15	12	11	8	7	4	3	0
PINMUX13_15_12		PINMUX13_11_8		PINMUX13_7_4		PINMUX13_3_0	
R/W-0		R/W-0		R/W-0		R/W-0	

LEGEND: R/W = Read/Write; -n = value after reset

Table 10-34. Pin Multiplexing Control 13 Register (PINMUX13) Field Descriptions

Bit	Field	Value	Description	Type ⁽¹⁾
31-28	PINMUX13_31_28		PRU0_R30[26]/UHPI_HRW/UPP_CHA_WAIT/GP6[8]/PRU1_R31[17] Control	
		0	Selects Function PRU1_R31[17]	I
		1h	Selects Function PRU0_R30[26]	O
		2h	Selects Function UHPI_HRW	I
		3h	Reserved	X
		4h	Selects Function UPP_CHA_WAIT	I/O
		5h-7h	Reserved	X
		8h	Selects Function GP6[8]	I/O
		9h-Fh	Reserved	X
27-24	PINMUX13_27_24		PRU0_R30[27]/UHPI_HHWIL/UPP_CHA_ENABLE/GP6[9] Control	
		0	Pin is 3-stated.	Z
		1h	Selects Function PRU0_R30[27]	O
		2h	Selects Function UHPI_HHWIL	I
		3h	Reserved	X
		4h	Selects Function UPP_CHA_ENABLE	I/O
		5h-7h	Reserved	X
		8h	Selects Function GP6[9]	I/O
		9h-Fh	Reserved	X
23-20	PINMUX13_23_20		PRU0_R30[28]/UHPI_HCNTL1/UPP_CHA_START/GP6[10] Control	
		0	Pin is 3-stated.	Z
		1h	Selects Function PRU0_R30[28]	O
		2h	Selects Function UHPI_HCNTL1	I
		3h	Reserved	X
		4h	Selects Function UPP_CHA_START	I/O
		5h-7h	Reserved	X
		8h	Selects Function GP6[10]	I/O
		9h-Fh	Reserved	X

⁽¹⁾ I = Input, O = Output, I/O = Bidirectional, X = Undefined, Z = High-impedance state

Table 10-34. Pin Multiplexing Control 13 Register (PINMUX13) Field Descriptions (continued)

Bit	Field	Value	Description	Type ⁽¹⁾
19-16	PINMUX13_19_16		PRU0_R30[29]/UHPI_HCNTL0/UPP_CHA_CLOCK/GP6[11] Control	
		0	Pin is 3-stated.	Z
		1h	Selects Function PRU0_R30[29]	O
		2h	Selects Function UHPI_HCNTL0	I
		3h	<i>Reserved</i>	X
		4h	Selects Function UPP_CHA_CLOCK	I/O
		5h-7h	<i>Reserved</i>	X
		8h	Selects Function GP6[11]	I/O
		9h-Fh	<i>Reserved</i>	X
15-12	PINMUX13_15_12		PRU0_R30[30]/UHPI_HINT/PRU1_R30[11]/GP6[12] Control	
		0	Pin is 3-stated.	Z
		1h	Selects Function PRU0_R30[30]	O
		2h	Selects Function UHPI_HINT	O
		3h	<i>Reserved</i>	X
		4h	Selects Function PRU1_R30[11]	O
		5h-7h	<i>Reserved</i>	X
		8h	Selects Function GP6[12]	I/O
		9h-Fh	<i>Reserved</i>	X
11-8	PINMUX13_11_8		PRU0_R30[31]/UHPI_HRDY/PRU1_R30[12]/GP6[13] Control	
		0	Pin is 3-stated.	Z
		1h	Selects Function PRU0_R30[31]	O
		2h	Selects Function UHPI_HRDY	O
		3h	<i>Reserved</i>	X
		4h	Selects Function PRU1_R30[12]	O
		5h-7h	<i>Reserved</i>	X
		8h	Selects Function GP6[13]	I/O
		9h-Fh	<i>Reserved</i>	X
7-4	PINMUX13_7_4		CLKOUT/UHPI_HDS2/PRU1_R30[13]/GP6[14] Control	
		0	Pin is 3-stated.	Z
		1h	Selects Function CLKOUT	O
		2h	Selects Function UHPI_HDS2	I
		3h	<i>Reserved</i>	X
		4h	Selects Function PRU1_R30[13]	O
		5h-7h	<i>Reserved</i>	X
		8h	Selects Function GP6[14]	I/O
		9h-Fh	<i>Reserved</i>	X
3-0	PINMUX13_3_0		RESETOUT/UHPI_HAS/PRU1_R30[14]/GP6[15] Control	
		0	Selects Function RESETOUT	O
		1h	Selects Function RESETOUT	O
		2h	Selects Function UHPI_HAS	I
		3h	<i>Reserved</i>	X
		4h	Selects Function PRU1_R30[14]	O
		5h-7h	<i>Reserved</i>	X
		8h	Selects Function GP6[15]	I/O
		9h-Fh	<i>Reserved</i>	X

10.4.9.15 Pin Multiplexing Control 14 Register (PINMUX14)
Figure 10-31. Pin Multiplexing Control 14 Register (PINMUX14)

31	28	27	24	23	20	19	16
PINMUX14_31_28		PINMUX14_27_24		PINMUX14_23_20		PINMUX14_19_16	
R/W-0		R/W-0		R/W-0		R/W-0	
15	12	11	8	7	4	3	0
PINMUX14_15_12		PINMUX14_11_8		PINMUX14_7_4		PINMUX14_3_0	
R/W-0		R/W-0		R/W-0		R/W-0	

LEGEND: R/W = Read/Write; -n = value after reset

Table 10-35. Pin Multiplexing Control 14 Register (PINMUX14) Field Descriptions

Bit	Field	Value	Description	Type ⁽¹⁾
31-28	PINMUX14_31_28		VP_DIN[2]/UHPI_HD[10]/UPP_D[10]/PRU0_R31[24] Control	
		0	Selects Function PRU0_R31[24]	I
		1h	Selects Function VP_DIN[2]	I
		2h	Selects Function UHPI_HD[10]	I/O
		3h	<i>Reserved</i>	X
		4h	Selects Function UPP_D[10]	I/O
	5h-Fh	<i>Reserved</i>	X	
27-24	PINMUX14_27_24		VP_DIN[3]/UHPI_HD[11]/UPP_D[11]/PRU0_R31[25] Control	
		0	Selects Function PRU0_R31[25]	I
		1h	Selects Function VP_DIN[3]	I
		2h	Selects Function UHPI_HD[11]	I/O
		3h	<i>Reserved</i>	X
		4h	Selects Function UPP_D[11]	I/O
	5h-Fh	<i>Reserved</i>	X	
23-20	PINMUX14_23_20		VP_DIN[4]/UHPI_HD[12]/UPP_D[12]/PRU0_R31[26] Control	
		0	Selects Function PRU0_R31[26]	I
		1h	Selects Function VP_DIN[4]	I
		2h	Selects Function UHPI_HD[12]	I/O
		3h	<i>Reserved</i>	X
		4h	Selects Function UPP_D[12]	I/O
	5h-Fh	<i>Reserved</i>	X	
19-16	PINMUX14_19_16		VP_DIN[5]/UHPI_HD[13]/UPP_D[13]/PRU0_R31[27] Control	
		0	Selects Function PRU0_R31[27]	I
		1h	Selects Function VP_DIN[5]	I
		2h	Selects Function UHPI_HD[13]	I/O
		3h	<i>Reserved</i>	X
		4h	Selects Function UPP_D[13]	I/O
	5h-Fh	<i>Reserved</i>	X	
15-12	PINMUX14_15_12		VP_DIN[6]/UHPI_HD[14]/UPP_D[14]/PRU0_R31[28] Control	
		0	Selects Function PRU0_R31[28]	I
		1h	Selects Function VP_DIN[6]	I
		2h	Selects Function UHPI_HD[14]	I/O
		3h	<i>Reserved</i>	X
		4h	Selects Function UPP_D[14]	I/O
	5h-Fh	<i>Reserved</i>	X	

⁽¹⁾ I = Input, O = Output, I/O = Bidirectional, X = Undefined

Table 10-35. Pin Multiplexing Control 14 Register (PINMUX14) Field Descriptions (continued)

Bit	Field	Value	Description	Type ⁽¹⁾
11-8	PINMUX14_11_8		VP_DIN[7]/UHPI_HD[15]/UPP_D[15]/PRU0_R31[29] Control	
		0	Selects Function PRU0_R31[29]	I
		1h	Selects Function VP_DIN[7]	I
		2h	Selects Function UHPI_HD[15]	I/O
		3h	<i>Reserved</i>	X
		4h	Selects Function UPP_D[15]	I/O
		5h-Fh	<i>Reserved</i>	X
7-4	PINMUX14_7_4		VP_CLKIN1/UHPI_HDS1/PRU1_R30[9]/GP6[6]/PRU1_R31[16] Control	
		0	Selects Function PRU1_R31[16]	I
		1h	Selects Function VP_CLKIN1	I
		2h	Selects Function UHPI_HDS1	I
		3h	<i>Reserved</i>	X
		4h	Selects Function PRU1_R30[9]	O
		5h-7h	<i>Reserved</i>	X
8h	Selects Function GP6[6]	I/O		
9h-Fh	<i>Reserved</i>	X		
3-0	PINMUX14_3_0		VP_CLKIN0/UHPI_HCS/PRU1_R30[10]/GP6[7]/UPP_2xTXCLK Control	
		0	Selects Function UPP_2xTXCLK	I
		1h	Selects Function VP_CLKIN0	I
		2h	Selects Function UHPI_HCS	I
		3h	<i>Reserved</i>	X
		4h	Selects Function PRU1_R30[10]	O
		5h-7h	<i>Reserved</i>	X
8h	Selects Function GP6[7]	I/O		
9h-Fh	<i>Reserved</i>	X		

10.4.9.16 Pin Multiplexing Control 15 Register (PINMUX15)
Figure 10-32. Pin Multiplexing Control 15 Register (PINMUX15)

31	28	27	24	23	20	19	16
PINMUX15_31_28		PINMUX15_27_24		PINMUX15_23_20		PINMUX15_19_16	
R/W-0		R/W-0		R/W-0		R/W-0	
15	12	11	8	7	4	3	0
PINMUX15_15_12		PINMUX15_11_8		PINMUX15_7_4		PINMUX15_3_0	
R/W-0		R/W-0		R/W-0		R/W-0	

LEGEND: R/W = Read/Write; -n = value after reset

Table 10-36. Pin Multiplexing Control 15 Register (PINMUX15) Field Descriptions

Bit	Field	Value	Description	Type ⁽¹⁾
31-28	PINMUX15_31_28		VP_DIN[10]/UHPI_HD[2]/UPP_D[2]/PRU0_R30[10]/PRU0_R31[10] Control	
		0	Selects Function PRU0_R31[10]	I
		1h	Selects Function VP_DIN[10]	I
		2h	Selects Function UHPI_HD[2]	I/O
		3h	<i>Reserved</i>	X
		4h	Selects Function UPP_D[2]	I/O
		5h-7h	<i>Reserved</i>	X
		8h	Selects Function PRU0_R30[10]	O
		9h-Fh	<i>Reserved</i>	X
27-24	PINMUX15_27_24		VP_DIN[11]/UHPI_HD[3]/UPP_D[3]/PRU0_R30[11]/PRU0_R31[11] Control	
		0	Selects Function PRU0_R31[11]	I
		1h	Selects Function VP_DIN[11]	I
		2h	Selects Function UHPI_HD[3]	I/O
		3h	<i>Reserved</i>	X
		4h	Selects Function UPP_D[3]	I/O
		5h-7h	<i>Reserved</i>	X
		8h	Selects Function PRU0_R30[11]	O
		9h-Fh	<i>Reserved</i>	X
23-20	PINMUX15_23_20		VP_DIN[12]/UHPI_HD[4]/UPP_D[4]/PRU0_R30[12]/PRU0_R31[12] Control	
		0	Selects Function PRU0_R31[12]	I
		1h	Selects Function VP_DIN[12]	I
		2h	Selects Function UHPI_HD[4]	I/O
		3h	<i>Reserved</i>	X
		4h	Selects Function UPP_D[4]	I/O
		5h-7h	<i>Reserved</i>	X
		8h	Selects Function PRU0_R30[12]	O
		9h-Fh	<i>Reserved</i>	X

⁽¹⁾ I = Input, O = Output, I/O = Bidirectional, X = Undefined

Table 10-36. Pin Multiplexing Control 15 Register (PINMUX15) Field Descriptions (continued)

Bit	Field	Value	Description	Type ⁽¹⁾
19-16	PINMUX15_19_16	0 1h 2h 3h 4h 5h-7h 8h 9h-Fh	VP_DIN[13]_FIELD/UHPI_HD[5]/UPP_D[5]/PRU0_R30[13]/PRU0_R31[13] Control Selects Function PRU0_R31[13] Selects Function VP_DIN[13]_FIELD Selects Function UHPI_HD[5] <i>Reserved</i> Selects Function UPP_D[5] <i>Reserved</i> Selects Function PRU0_R30[13] <i>Reserved</i>	I I I/O X I/O X O X
15-12	PINMUX15_15_12	0 1h 2h 3h 4h 5h-7h 8h 9h-Fh	VP_DIN[14]_HSYNC/UHPI_HD[6]/UPP_D[6]/PRU0_R30[14]/PRU0_R31[14] Control Selects Function PRU0_R31[14] Selects Function VP_DIN[14]_HSYNC Selects Function UHPI_HD[6] <i>Reserved</i> Selects Function UPP_D[6] <i>Reserved</i> Selects Function PRU0_R30[14] <i>Reserved</i>	I I I/O X I/O X O X
11-8	PINMUX15_11_8	0 1h 2h 3h 4h 5h-7h 8h 9h-Fh	VP_DIN[15]_VSYNC/UHPI_HD[7]/UPP_D[7]/PRU0_R30[15]/PRU0_R31[15] Control Selects Function PRU0_R31[15] Selects Function VP_DIN[15]_VSYNC Selects Function UHPI_HD[7] <i>Reserved</i> Selects Function UPP_D[7] <i>Reserved</i> Selects Function PRU0_R30[15] <i>Reserved</i>	I I I/O X I/O X O X
7-4	PINMUX15_7_4	0 1h 2h 3h 4h 5h-Fh	VP_DIN[0]/UHPI_HD[8]/UPP_D[8]/PRU1_R31[29] Control Selects Function PRU1_R31[29] Selects Function VP_DIN[0] Selects Function UHPI_HD[8] <i>Reserved</i> Selects Function UPP_D[8] <i>Reserved</i>	I I I/O X I/O X
3-0	PINMUX15_3_0	0 1h 2h 3h 4h 5h-Fh	VP_DIN[1]/UHPI_HD[9]/UPP_D[9]/PRU0_R31[23] Control Selects Function PRU0_R31[23]. Selects Function VP_DIN[1] Selects Function UHPI_HD[9] <i>Reserved</i> Selects Function UPP_D[9] <i>Reserved</i>	I I I/O X I/O X

10.4.9.17 Pin Multiplexing Control 16 Register (PINMUX16)
Figure 10-33. Pin Multiplexing Control 16 Register (PINMUX16)

31	28	27	24	23	20	19	16
PINMUX16_31_28		PINMUX16_27_24		PINMUX16_23_20		PINMUX16_19_16	
R/W-0		R/W-0		R/W-0		R/W-0	
15	12	11	8	7	4	3	0
PINMUX16_15_12		PINMUX16_11_8		PINMUX16_7_4		PINMUX16_3_0	
R/W-0		R/W-0		R/W-0		R/W-0	

LEGEND: R/W = Read/Write; -n = value after reset

Table 10-37. Pin Multiplexing Control 16 Register (PINMUX16) Field Descriptions

Bit	Field	Value	Description	Type ⁽¹⁾
31-28	PINMUX16_31_28		VP_DOUT[2]/LCD_D[2]/UPP_XD[10]/GP7[10]/PRU1_R31[10] Control	
		0	Selects Function PRU1_R31[10]	I
		1h	Selects Function VP_DOUT[2]	O
		2h	Selects Function LCD_D[2]	I/O
		3h	<i>Reserved</i>	X
		4h	Selects Function UPP_XD[10]	I/O
		5h-7h	<i>Reserved</i>	X
		8h	Selects Function GP7[10]	I/O
	9h-Fh	<i>Reserved</i>	X	
27-24	PINMUX16_27_24		VP_DOUT[3]/LCD_D[3]/UPP_XD[11]/GP7[11]/PRU1_R31[11] Control	
		0	Selects Function PRU1_R31[11]	I
		1h	Selects Function VP_DOUT[3]	O
		2h	Selects Function LCD_D[3]	I/O
		3h	<i>Reserved</i>	X
		4h	Selects Function UPP_XD[11]	I/O
		5h-7h	<i>Reserved</i>	X
		8h	Selects Function GP7[11]	I/O
	9h-Fh	<i>Reserved</i>	X	
23-20	PINMUX16_23_20		VP_DOUT[4]/LCD_D[4]/UPP_XD[12]/GP7[12]/PRU1_R31[12] Control	
		0	Selects Function PRU1_R31[12]	I
		1h	Selects Function VP_DOUT[4]	O
		2h	Selects Function LCD_D[4]	I/O
		3h	<i>Reserved</i>	X
		4h	Selects Function UPP_XD[12]	I/O
		5h-7h	<i>Reserved</i>	X
		8h	Selects Function GP7[12]	I/O
	9h-Fh	<i>Reserved</i>	X	

⁽¹⁾ I = Input, O = Output, I/O = Bidirectional, X = Undefined

Table 10-37. Pin Multiplexing Control 16 Register (PINMUX16) Field Descriptions (continued)

Bit	Field	Value	Description	Type ⁽¹⁾
19-16	PINMUX16_19_16	0 1h 2h 3h 4h 5h-7h 8h 9h-Fh	VP_DOUT[5]/LCD_D[5]/UPP_XD[13]/GP7[13]/PRU1_R31[13] Control Selects Function PRU1_R31[13] Selects Function VP_DOUT[5] Selects Function LCD_D[5] <i>Reserved</i> Selects Function UPP_XD[13] <i>Reserved</i> Selects Function GP7[13] <i>Reserved</i>	I O I/O X I/O X I/O X
15-12	PINMUX16_15_12	0 1h 2h 3h 4h 5h-7h 8h 9h-Fh	VP_DOUT[6]/LCD_D[6]/UPP_XD[14]/GP7[14]/PRU1_R31[14] Control Selects Function PRU1_R31[14] Selects Function VP_DOUT[6] Selects Function LCD_D[6] <i>Reserved</i> Selects Function UPP_XD[14] <i>Reserved</i> Selects Function GP7[14] <i>Reserved</i>	I O I/O X I/O X I/O X
11-8	PINMUX16_11_8	0 1h 2h 3h 4h 5h-7h 8h 9h-Fh	VP_DOUT[7]/LCD_D[7]/UPP_XD[15]/GP7[15]/PRU1_R31[15] Control Selects Function PRU1_R31[15] Selects Function VP_DOUT[7] Selects Function LCD_D[7] <i>Reserved</i> Selects Function UPP_XD[15] <i>Reserved</i> Selects Function GP7[15] <i>Reserved</i>	I O I/O X I/O X I/O X
7-4	PINMUX16_7_4	0 1h 2h 3h 4h 5h-7h 8h 9h-Fh	VP_DIN[8]/UHPI_HD[0]/UPP_D0/GP6[5]/PRU1_R31[0] Control Selects Function PRU1_R31[0] Selects Function VP_DIN[8] Selects Function UHPI_HD[0] <i>Reserved</i> Selects Function UPP_D[0] <i>Reserved</i> Selects Function GP6[5] <i>Reserved</i>	I I I/O X I/O X I/O X
3-0	PINMUX16_3_0	0 1h 2h 3h 4h 5h-7h 8h 9h-Fh	VP_DIN[9]/UHPI_HD[1]/UPP_D[1]/PRU0_R30[9]/PRU0_R31[9] Control Selects Function PRU0_R31[9] Selects Function VP_DIN[9] Selects Function UHPI_HD[1] <i>Reserved</i> Selects Function UPP_D[1] <i>Reserved</i> Selects Function PRU0_R30[9] <i>Reserved</i>	I I I/O X I/O X O X

10.4.9.18 Pin Multiplexing Control 17 Register (PINMUX17)
Figure 10-34. Pin Multiplexing Control 17 Register (PINMUX17)

31	28	27	24	23	20	19	16
PINMUX17_31_28		PINMUX17_27_24		PINMUX17_23_20		PINMUX17_19_16	
R/W-0		R/W-0		R/W-0		R/W-0	
15	12	11	8	7	4	3	0
PINMUX17_15_12		PINMUX17_11_8		PINMUX17_7_4		PINMUX17_3_0	
R/W-0		R/W-0		R/W-0		R/W-0	

LEGEND: R/W = Read/Write; -n = value after reset

Table 10-38. Pin Multiplexing Control 17 Register (PINMUX17) Field Descriptions

Bit	Field	Value	Description	Type ⁽¹⁾
31-28	PINMUX17_31_28		VP_DOUT[10]/LCD_D[10]/UPP_XD[2]/GP7[2]/BOOT[2] Control	
		0	Selects Function BOOT[2]	I
		1h	Selects Function VP_DOUT[10]	O
		2h	Selects Function LCD_D[10]	I/O
		3h	<i>Reserved</i>	X
		4h	Selects Function UPP_XD[2]	I/O
		5h-7h	<i>Reserved</i>	X
		8h	Selects Function GP7[2]	I/O
		9h-Fh	<i>Reserved</i>	X
27-24	PINMUX17_27_24		VP_DOUT[11]/LCD_D[11]/UPP_XD[3]/GP7[3]/BOOT[3] Control	
		0	Selects Function BOOT[3]	I
		1h	Selects Function VP_DOUT[11]	O
		2h	Selects Function LCD_D[11]	I/O
		3h	<i>Reserved</i>	X
		4h	Selects Function UPP_XD[3]	I/O
		5h-7h	<i>Reserved</i>	X
		8h	Selects Function GP7[3]	I/O
		9h-Fh	<i>Reserved</i>	X
23-20	PINMUX17_23_20		VP_DOUT[12]/LCD_D[12]/UPP_XD[4]/GP7[4]/BOOT[4] Control	
		0	Selects Function BOOT[4]	I
		1h	Selects Function VP_DOUT[12]	O
		2h	Selects Function LCD_D[12]	I/O
		3h	<i>Reserved</i>	X
		4h	Selects Function UPP_XD[4]	I/O
		5h-7h	<i>Reserved</i>	X
		8h	Selects Function GP7[4]	I/O
		9h-Fh	<i>Reserved</i>	X

⁽¹⁾ I = Input, O = Output, I/O = Bidirectional, X = Undefined

Table 10-38. Pin Multiplexing Control 17 Register (PINMUX17) Field Descriptions (continued)

Bit	Field	Value	Description	Type ⁽¹⁾
19-16	PINMUX17_19_16		VP_DOUT[13]/LCD_D[13]/UPP_XD[5]/GP7[5]/BOOT[5] Control	
		0	Selects Function BOOT[5]	I
		1h	Selects Function VP_DOUT[13]	O
		2h	Selects Function LCD_D[13]	I/O
		3h	<i>Reserved</i>	X
		4h	Selects Function UPP_XD[5]	I/O
		5h-7h	<i>Reserved</i>	X
		8h	Selects Function GP7[5]	I/O
		9h-Fh	<i>Reserved</i>	X
15-12	PINMUX17_15_12		VP_DOUT[14]/LCD_D[14]/UPP_XD[6]/GP7[6]/BOOT[6] Control	
		0	Selects Function BOOT[6]	I
		1h	Selects Function VP_DOUT[14]	O
		2h	Selects Function LCD_D[14]	I/O
		3h	<i>Reserved</i>	X
		4h	Selects Function UPP_XD[6]	I/O
		5h-7h	<i>Reserved</i>	X
		8h	Selects Function GP7[6]	I/O
		9h-Fh	<i>Reserved</i>	X
11-8	PINMUX17_11_8		VP_DOUT[15]/LCD_D[15]/UPP_XD[7]/GP7[7]/BOOT[7] Control	
		0	Selects Function BOOT[7]	I
		1h	Selects Function VP_DOUT[15]	O
		2h	Selects Function LCD_D[15]	I/O
		3h	<i>Reserved</i>	X
		4h	Selects Function UPP_XD[7]	I/O
		5h-7h	<i>Reserved</i>	X
		8h	Selects Function GP7[7]	I/O
		9h-Fh	<i>Reserved</i>	X
7-4	PINMUX17_7_4		VP_DOUT[0]/LCD_D[0]/UPP_XD[8]/GP7[8]/PRU1_R31[8] Control	
		0	Selects Function PRU1_R31[8]	I
		1h	Selects Function VP_DOUT[0]	O
		2h	Selects Function LCD_D[0]	I/O
		3h	<i>Reserved</i>	X
		4h	Selects Function UPP_XD[8]	I/O
		5h-7h	<i>Reserved</i>	X
		8h	Selects Function GP7[8]	I/O
		9h-Fh	<i>Reserved</i>	X
3-0	PINMUX17_3_0		VP_DOUT[1]/LCD_D[1]/UPP_XD[9]/GP7[9]/PRU1_R31[9] Control	
		0	Selects Function PRU1_R31[9]	I
		1h	Selects Function VP_DOUT[1]	O
		2h	Selects Function LCD_D[1]	I/O
		3h	<i>Reserved</i>	X
		4h	Selects Function UPP_XD[9]	I/O
		5h-7h	<i>Reserved</i>	X
		8h	Selects Function GP7[9]	I/O
		9h-Fh	<i>Reserved</i>	X

10.4.9.19 Pin Multiplexing Control 18 Register (PINMUX18)
Figure 10-35. Pin Multiplexing Control 18 Register (PINMUX18)

31	28	27	24	23	20	19	16
PINMUX18_31_28		PINMUX18_27_24		PINMUX18_23_20		PINMUX18_19_16	
R/W-0		R/W-0		R/W-0		R/W-0	
15	12	11	8	7	4	3	0
PINMUX18_15_12		PINMUX18_11_8		PINMUX18_7_4		PINMUX18_3_0	
R/W-0		R/W-0		R/W-0		R/W-0	

LEGEND: R/W = Read/Write; -n = value after reset

Table 10-39. Pin Multiplexing Control 18 Register (PINMUX18) Field Descriptions

Bit	Field	Value	Description	Type ⁽¹⁾
31-28	PINMUX18_31_28		MMCS1_DAT[6]/LCD_MCLK/PRU1_R30[6]/GP8[10]/PRU1_R31[7] Control	
		0	Selects Function PRU1_R31[7]	I
		1h	Selects Function MMCS1_DAT[6]	I/O
		2h	Selects Function LCD_MCLK	O
		3h	<i>Reserved</i>	X
		4h	Selects Function PRU1_R30[6]	O
		5h-7h	<i>Reserved</i>	X
		8h	Selects Function GP8[10]	I/O
	9h-Fh	<i>Reserved</i>	X	
27-24	PINMUX18_27_24		MMCS1_DAT[7]/LCD_PCLK/PRU1_R30[7]/GP8[11] Control	
		0	Pin is 3-stated.	Z
		1h	Selects Function MMCS1_DAT[7]	I/O
		2h	Selects Function LCD_PCLK	O
		3h	<i>Reserved</i>	X
		4h	Selects Function PRU1_R30[7]	O
		5h-7h	<i>Reserved</i>	X
		8h	Selects Function GP8[11]	I/O
	9h-Fh	<i>Reserved</i>	X	
23-20	PINMUX18_23_20		PRU0_R30[22]/PRU1_R30[8]/UPP_CHB_WAIT/GP8[12]/PRU1_R31[24] Control	
		0	Selects Function PRU1_R31[24]	I
		1h	Selects Function PRU0_R30[22]	O
		2h	Selects Function PRU1_R30[8]	O
		3h	<i>Reserved</i>	X
		4h	Selects Function UPP_CHB_WAIT	I/O
		5h-7h	<i>Reserved</i>	X
		8h	Selects Function GP8[12]	I/O
	9h-Fh	<i>Reserved</i>	X	

⁽¹⁾ I = Input, O = Output, I/O = Bidirectional, X = Undefined, Z = High-impedance state

Table 10-39. Pin Multiplexing Control 18 Register (PINMUX18) Field Descriptions (continued)

Bit	Field	Value	Description	Type ⁽¹⁾
19-16	PINMUX18_19_16		PRU0_R30[23]/MMCSD1_CMD/UPP_CHB_ENABLE/GP8[13]/PRU1_R31[25] Control	
		0	Selects Function PRU1_R31[25]	I
		1h	Selects Function PRU0_R30[23]	O
		2h	Selects Function MMCSD1_CMD	I/O
		3h	Reserved	X
		4h	Selects Function UPP_CHB_ENABLE	I/O
		5h-7h	Reserved	X
		8h	Selects Function GP8[13]	I/O
		9h-Fh	Reserved	X
15-12	PINMUX18_15_12		PRU0_R30[24]/MMCSD1_CLK/UPP_CHB_START/GP8[14]/PRU1_R31[26] Control	
		0	Selects Function PRU1_R31[26]	I
		1h	Selects Function PRU0_R30[24]	O
		2h	Selects Function MMCSD1_CLK	O
		3h	Reserved	X
		4h	Selects Function UPP_CHB_START	I/O
		5h-7h	Reserved	X
		8h	Selects Function GP8[14]	I/O
		9h-Fh	Reserved	X
11-8	PINMUX18_11_8		PRU0_R30[25]/MMCSD1_DAT[0]/UPP_CHB_CLOCK/GP8[15]/PRU1_R31[27] Control	
		0	Selects Function PRU1_R31[27]	I
		1h	Selects Function PRU0_R30[25]	O
		2h	Selects Function MMCSD1_DAT[0]	I/O
		3h	Reserved	X
		4h	Selects Function UPP_CHB_CLOCK	I/O
		5h-7h	Reserved	X
		8h	Selects Function GP8[15]	I/O
		9h-Fh	Reserved	X
7-4	PINMUX18_7_4		VP_DOUT[8]/LCD_D[8]/UPP_XD[0]/GP7[0]/BOOT[0] Control	
		0	Selects Function BOOT[0]	I
		1h	Selects Function VP_DOUT[8]	O
		2h	Selects Function LCD_D[8]	I/O
		3h	Reserved	X
		4h	Selects Function UPP_XD[0]	I/O
		5h-7h	Reserved	X
		8h	Selects Function GP7[0]	I/O
		9h-Fh	Reserved	X
3-0	PINMUX18_3_0		VP_DOUT[9]/LCD_D[9]/UPP_XD[1]/GP7[1]/BOOT[1] Control	
		0	Selects Function BOOT[1]	I
		1h	Selects Function VP_DOUT[9]	O
		2h	Selects Function LCD_D[9]	I/O
		3h	Reserved	X
		4h	Selects Function UPP_XD[1]	I/O
		5h-7h	Reserved	X
		8h	Selects Function GP7[1]	I/O
		9h-Fh	Reserved	X

10.4.9.20 Pin Multiplexing Control 19 Register (PINMUX19)
Figure 10-36. Pin Multiplexing Control 19 Register (PINMUX19)

31	28	27	24	23	20	19	16
PINMUX19_31_28		PINMUX19_27_24		PINMUX19_23_20		PINMUX19_19_16	
R/W-0		R/W-0		R/W-0		R/W-0	
15	12	11	8	7	4	3	0
PINMUX19_15_12		PINMUX19_11_8		PINMUX19_7_4		PINMUX19_3_0	
R/W-0		R/W-0		R/W-0		R/W-0	

LEGEND: R/W = Read/Write; -n = value after reset

Table 10-40. Pin Multiplexing Control 19 Register (PINMUX19) Field Descriptions

Bit	Field	Value	Description	Type ⁽¹⁾
31-28	PINMUX19_31_28		RTCK/GP8[0] Control	
		0	Selects Function RTCK	O
		1h	Selects Function RTCK	O
		2h-7h	Reserved	X
		8h	Selects Function GP8[0]	I/O
		9h-Fh	Reserved	X
27-24	PINMUX19_27_24		LCD_AC_ENB_CS/GP6[0]/PRU1_R31[28] Control	
		0	Selects Function PRU1_R31[28]	I
		1h	Reserved	X
		2h	Selects Function LCD_AC_ENB_CS	O
		3h-7h	Reserved	X
		8h	Selects Function GP6[0]	I/O
		9h-Fh	Reserved	X
23-20	PINMUX19_23_20		VP_CLKOUT3/PRU1_R30[0]/GP6[1]/PRU1_R31[1] Control	
		0	Selects Function PRU1_R31[1]	I
		1h	Selects Function VP_CLKOUT3	O
		2h-3h	Reserved	X
		4h	Selects Function PRU1_R30[0]	O
		5h-7h	Reserved	X
		8h	Selects Function GP6[1]	I/O
		9h-Fh	Reserved	X
19-16	PINMUX19_19_16		VP_CLKIN3/MMCSD1_DAT[1]/PRU1_R30[1]/GP6[2]/PRU1_R31[2] Control	
		0	Selects Function PRU1_R31[2]	I
		1h	Selects Function VP_CLKIN3	I
		2h	Selects Function MMCSD1_DAT[1]	I/O
		3h	Reserved	X
		4h	Selects Function PRU1_R30[1]	O
		5h-7h	Reserved	X
		8h	Selects Function GP6[2]	I/O
		9h-Fh	Reserved	X

⁽¹⁾ I = Input, O = Output, I/O = Bidirectional, X = Undefined

Table 10-40. Pin Multiplexing Control 19 Register (PINMUX19) Field Descriptions (continued)

Bit	Field	Value	Description	Type ⁽¹⁾
15-12	PINMUX19_15_12		VP_CLKOUT2/MMCSD1_DAT[2]/PRU1_R30[2]/GP6[3]/PRU1_R31[3] Control	
		0	Selects Function PRU1_R31[3]	I
		1h	Selects Function VP_CLKOUT2	O
		2h	Selects Function MMCSD1_DAT[2]	I/O
		3h	<i>Reserved</i>	X
		4h	Selects Function PRU1_R30[2]	O
		5h-7h	<i>Reserved</i>	X
		8h	Selects Function GP6[3]	I/O
		9h-Fh	<i>Reserved</i>	X
11-8	PINMUX19_11_8		VP_CLKIN2/MMCSD1_DAT[3]/PRU1_R30[3]/GP6[4]/PRU1_R31[4] Control	
		0	Selects Function PRU1_R31[4]	I
		1h	Selects Function VP_CLKIN2	I
		2h	Selects Function MMCSD1_DAT[3]	I/O
		3h	<i>Reserved</i>	X
		4h	Selects Function PRU1_R30[3]	O
		5h-7h	<i>Reserved</i>	X
		8h	Selects Function GP6[4]	I/O
		9h-Fh	<i>Reserved</i>	X
7-4	PINMUX19_7_4		MMCSD1_DAT[4]/LCD_VSYNC/PRU1_R30[4]/GP8[8]/PRU1_R31[5] Control	
		0	Selects Function PRU1_R31[5]	I
		1h	Selects Function MMCSD1_DAT[4]	I/O
		2h	Selects Function LCD_VSYNC	O
		3h	<i>Reserved</i>	X
		4h	Selects Function PRU1_R30[4]	O
		5h-7h	<i>Reserved</i>	X
		8h	Selects Function GP8[8]	I/O
		9h-Fh	<i>Reserved</i>	X
3-0	PINMUX19_3_0		MMCSD1_DAT[5]/LCD_HSYNC/PRU1_R30[5]/GP8[9]/PRU1_R31[6] Control	
		0	Selects Function PRU1_R31[6]	I
		1h	Selects Function MMCSD1_DAT[5]	I/O
		2h	Selects Function LCD_HSYNC	O
		3h	<i>Reserved</i>	X
		4h	Selects Function PRU1_R30[5]	O
		5h-7h	<i>Reserved</i>	X
		8h	Selects Function GP8[9]	I/O
		9h-Fh	<i>Reserved</i>	X

10.4.10 Suspend Source Register (SUSPSRC)

The suspend source register (SUSPSRC) indicates the emulation suspend source for those peripherals that support emulation suspend. A value of 0 for a SUSPSRC bit corresponding to the peripheral, indicates that the ARM emulator controls the peripheral's emulation suspend signal.

The SUSPSRC is shown in [Figure 10-37](#) and described in [Table 10-41](#).

Figure 10-37. Suspend Source Register (SUSPSRC)

31	30	29	28	27	26	25	24
Reserved	Reserved	TIMER64P_2SRC	TIMER64P_1SRC	TIMER64P_0SRC	Reserved	Reserved	EPWM1SRC
R/W-1	R/W-1	R/W-1	R/W-1	R/W-1	R/W-1	R/W-1	R/W-1
23	22	21	20	19	18	17	16
EPWM0SRC	SPI1SRC	SPI0SRC	UART2SRC	UART1SRC	UART0SRC	I2C1SRC	I2C0SRC
R/W-1	R/W-1	R/W-1	R/W-1	R/W-1	R/W-1	R/W-1	R/W-1
15	14	13	12	11	10	9	8
Reserved	VPIFSRC	Reserved	HPISRC	Reserved	Reserved	USB0SRC	MCBSP1SRC
R/W-1	R/W-1	R/W-1	R/W-1	R/W-1	R/W-1	R/W-1	R/W-1
7	6	5	4	3	2	1	0
MCBSP0SRC	PRUSRC	Reserved	UPPSRC	TIMER64P_3SRC	ECAP2SRC	ECAP1SRC	ECAP0SRC
R/W-1	R/W-1	R/W-1	R/W-1	R/W-1	R/W-1	R/W-1	R/W-1

LEGEND: R/W = Read/Write; -n = value after reset

Table 10-41. Suspend Source Register (SUSPSRC) Field Descriptions

Bit	Field	Value	Description
31-30	Reserved	1	Reserved. Write the default value to all bits when modifying this register.
29	TIMER64P_2SRC	0 1	Timer2 64 Emulation Suspend Source. 0 ARM is the source of the emulation suspend. 1 No emulation suspend.
28	TIMER64P_1SRC	0 1	Timer1 64 Emulation Suspend Source. 0 ARM is the source of the emulation suspend. 1 No emulation suspend.
27	TIMER64P_0SRC	0 1	Timer0 64 Emulation Suspend Source. 0 ARM is the source of the emulation suspend. 1 No emulation suspend.
26-25	Reserved	1	Reserved. Write the default value to all bits when modifying this register.
24	EPWM1SRC	0 1	EPWM1 Emulation Suspend Source. 0 ARM is the source of the emulation suspend. 1 No emulation suspend.
23	EPWM0SRC	0 1	EPWM0 Emulation Suspend Source. 0 ARM is the source of the emulation suspend. 1 No emulation suspend.
22	SPI1SRC	0 1	SPI1 Emulation Suspend Source. 0 ARM is the source of the emulation suspend. 1 No emulation suspend.
21	SPI0SRC	0 1	SPI0 Emulation Suspend Source. 0 ARM is the source of the emulation suspend. 1 No emulation suspend.

Table 10-41. Suspend Source Register (SUSPSRC) Field Descriptions (continued)

Bit	Field	Value	Description
20	UART2SRC	0	UART2 Emulation Suspend Source. ARM is the source of the emulation suspend.
		1	No emulation suspend.
19	UART1SRC	0	UART1 Emulation Suspend Source. ARM is the source of the emulation suspend.
		1	No emulation suspend.
18	UART0SRC	0	UART0 Emulation Suspend Source. ARM is the source of the emulation suspend.
		1	No emulation suspend.
17	I2C1SRC	0	I2C1 Emulation Suspend Source. ARM is the source of the emulation suspend.
		1	No emulation suspend.
16	I2C0SRC	0	I2C0 Emulation Suspend Source. ARM is the source of the emulation suspend.
		1	No emulation suspend.
15	Reserved	1	Reserved. Write the default value to all bits when modifying this register.
14	VPIFSRC	0	VPIF Emulation Suspend Source. ARM is the source of the emulation suspend.
		1	No emulation suspend.
13	Reserved	1	Reserved. Write the default value to all bits when modifying this register.
12	HPISRC	0	HPI Emulation Suspend Source. ARM is the source of the emulation suspend.
		1	No emulation suspend.
11-10	Reserved	1	Reserved. Write the default value to all bits when modifying this register.
9	USB0SRC	0	USB0 (USB 2.0) Emulation Suspend Source. ARM is the source of the emulation suspend.
		1	No emulation suspend.
8	MCBSP1SRC	0	McBSP1 Emulation Suspend Source. ARM is the source of the emulation suspend.
		1	No emulation suspend.
7	MCBSP0SRC	0	McBSP0 Emulation Suspend Source. ARM is the source of the emulation suspend.
		1	No emulation suspend.
6	PRUSRC	0	PRU Emulation Suspend Source. ARM is the source of the emulation suspend.
		1	No emulation suspend.
5	Reserved	1	Reserved. Write the default value to all bits when modifying this register.
4	UPPSRC	0	uPP Emulation Suspend Source. ARM is the source of the emulation suspend.
		1	No emulation suspend.
3	TIMER64P_3SRC	0	Timer3 64 Emulation Suspend Source. ARM is the source of the emulation suspend.
		1	No emulation suspend.
2	ECAP2SRC	0	ECAP2 Emulation Suspend Source. ARM is the source of the emulation suspend.
		1	No emulation suspend.

Table 10-41. Suspend Source Register (SUSPSRC) Field Descriptions (continued)

Bit	Field	Value	Description
1	ECAP1SRC	0	ARM is the source of the emulation suspend.
		1	No emulation suspend.
0	ECAP0SRC	0	ARM is the source of the emulation suspend.
		1	No emulation suspend.

10.4.11 Chip Signal Register (CHIPSIG)

Interrupts to the ARM may be generated by setting one of the four CHIPSIG[3-0] bits in the chip signal register (CHIPSIG). Writing a 1 to these bits sets the interrupts, writing a 0 has no effect. Reads return the value of these bits and can also be used as status bits. The CHIPSIG is shown in [Figure 10-38](#) and described in [Table 10-42](#).

Figure 10-38. Chip Signal Register (CHIPSIG)

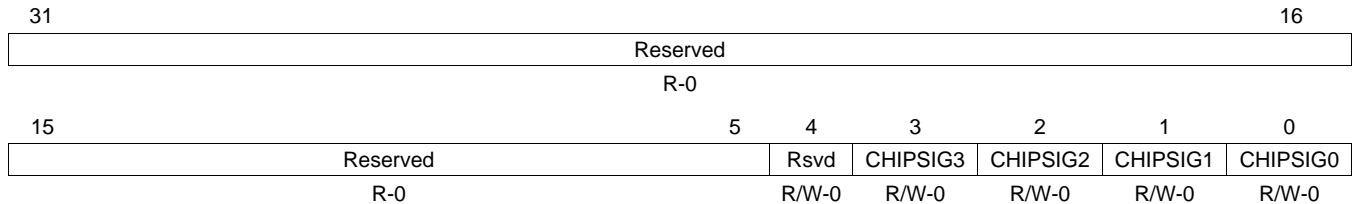

LEGEND: R/W = Read/Write; R = Read only; -n = value after reset

Table 10-42. Chip Signal Register (CHIPSIG) Field Descriptions

Bit	Field	Value	Description
31-5	Reserved	0	Reserved
4	Reserved	0	Reserved. Write the default value when modifying this register.
3	CHIPSIG3	0	Asserts SYSCFG_CHIPINT3 interrupt. No effect
		1	Asserts interrupt
2	CHIPSIG2	0	Asserts SYSCFG_CHIPINT2 interrupt. No effect
		1	Asserts interrupt
1	CHIPSIG1	0	Asserts SYSCFG_CHIPINT1 interrupt. No effect
		1	Asserts interrupt
0	CHIPSIG0	0	Asserts SYSCFG_CHIPINT0 interrupt. No effect
		1	Asserts interrupt

10.4.12 Chip Signal Clear Register (CHIPSIG_CLR)

The chip signal clear register (CHIPSIG_CLR) is used to clear the bits set in the chip signal register (CHIPSIG). Writing a 1 to a CHIPSIG[*n*] bit in CHIPSIG_CLR clears the corresponding CHIPSIG[*n*] bit in CHIPSIG; writing a 0 has no effect. After servicing the interrupt, the interrupted processor can clear the bits set in CHIPSIG by writing 1 to the corresponding bits in CHIPSIG_CLR. The other processor may poll the CHIPSIG[*n*] bit to determine when the interrupted processor has completed the interrupt service. The CHIPSIG_CLR is shown in Figure 10-39 and described in Table 10-43.

For more information on ARM interrupts, see Chapter 11.

Figure 10-39. Chip Signal Clear Register (CHIPSIG_CLR)

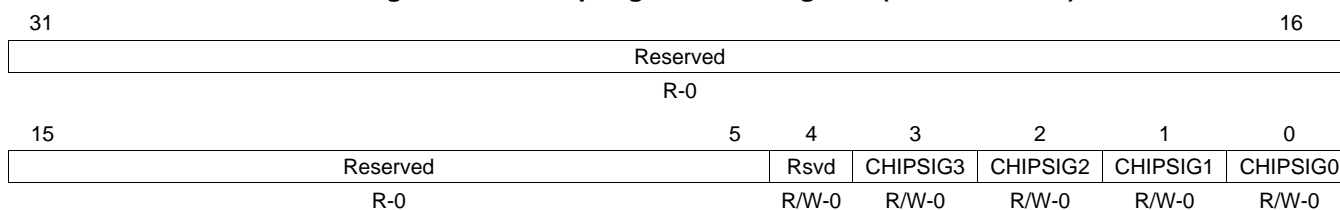

LEGEND: R/W = Read/Write; R = Read only; -*n* = value after reset

Table 10-43. Chip Signal Clear Register (CHIPSIG_CLR) Field Descriptions

Bit	Field	Value	Description
31-5	Reserved	0	Reserved
4	Reserved	0	Reserved. Write the default value when modifying this register.
3	CHIPSIG3	0	Clears SYSCFG_CHIPINT3 interrupt. No effect
		1	Clears interrupt
2	CHIPSIG2	0	Clears SYSCFG_CHIPINT2 interrupt. No effect
		1	Clears interrupt
1	CHIPSIG1	0	Clears SYSCFG_CHIPINT1 interrupt. No effect
		1	Clears interrupt
0	CHIPSIG0	0	Clears SYSCFG_CHIPINT0 interrupt. No effect
		1	Clears interrupt

10.4.13 Chip Configuration 0 Register (CFGCHIP0)

The chip configuration 0 register (CFGCHIP0) controls the following functions:

- PLL Controller 0 memory-mapped register lock: Used to lock out writes to the PLLC0 memory-mapped registers (MMRs) to prevent any erroneous writes in software to the PLLC0 register space.
- EDMA3_0 Transfer Controller Default Burst Size (DBS) Control: This controls the maximum number of bytes issued per read/write command or the burst size for the individual transfer controllers (TCs) on the device. By default for all transfer controllers, the burst size is set to 16 bytes. However, CFGCHIP0 allows configurability of this parameter so that the TC can have a burst size of 16, 32, or 64 bytes. The burst size determines the intra packet efficiency for the EDMA3_0 transfers. Additionally, it also facilitates preemption at a system level, as all transfer requests are internally broken down by the transfer controller up to DBS size byte chunks and on a system level, each master's priority (configured by the MSTPRI register) is evaluated at burst size boundaries. The DBS value can significantly impact the standalone throughput performance depending on the source and destination (bus width/frequency/burst support etc) and the TC FIFO size, etc. Therefore, the DBS size configuration should be carefully analyzed to meet the system's throughput/performance requirements.

The CFGCHIP0 is shown in [Figure 10-40](#) and described in [Table 10-44](#).

Figure 10-40. Chip Configuration 0 Register (CFGCHIP0)

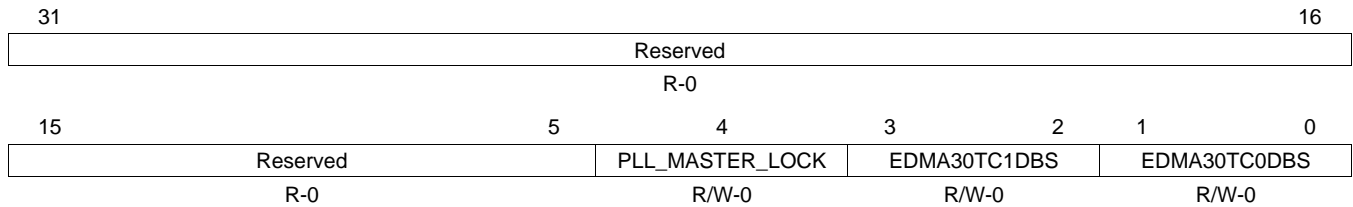

LEGEND: R/W = Read/Write; R = Read only; -n = value after reset

Table 10-44. Chip Configuration 0 Register (CFGCHIP0) Field Descriptions

Bit	Field	Value	Description
31-5	Reserved	0	Reserved.
4	PLL_MASTER_LOCK	0 1	PLLC0 MMRs lock. 0 PLLC0 MMRs are freely accessible. 1 All PLLC0 MMRs are locked.
3-2	EDMA30TC1DBS	0 1h 2h 3h	EDMA3_0_TC1 Default Burst Size (DBS). 0 16 bytes 1h 32 bytes 2h 64 bytes 3h <i>Reserved</i>
1-0	EDMA30TC0DBS	0 1h 2h 3h	EDMA3_0_TC0 Default Burst Size (DBS). 0 16 bytes 1h 32 bytes 2h 64 bytes 3h <i>Reserved</i>

10.4.14 Chip Configuration 1 Register (CFGCHIP1)

The chip configuration 1 register (CFGCHIP1) controls the following functions:

- eCAP0/1/2 event input source: Allows using McASP0 TX/RX events as eCAP event input sources.
- HPI Control: Allows HPIEN bit control that determines whether or not the HPI module has control over the HPI pins (multiplexed with other peripheral pins). It also provides configurability to select whether the host address is a word address or a byte address mode.
- EDMA3_1 Transfer Controller Default Burst Size (DBS) Control: This controls the maximum number of bytes issued per read/write command or the burst size for the individual transfer controllers (TCs) on the device. By default for all transfer controllers, the burst size is set to 16 bytes. However, CFGCHIP1 allows configurability of this parameter so that the TC can have a burst size of 16, 32, or 64 bytes. The burst size determines the intra packet efficiency for the EDMA3_1 transfers. Additionally, it also facilitates preemption at a system level, as all transfer requests are internally broken down by the transfer controller up to DBS size byte chunks and on a system level, each master's priority (configured by the MSTPRI register) is evaluated at burst size boundaries. The DBS value can significantly impact the standalone throughput performance depending on the source and destination (bus width/frequency/burst support etc) and the TC FIFO size, etc. Therefore, the DBS size configuration should be carefully analyzed to meet the system's throughput/performance requirements.
- eHRPWM Time Base Clock (TBCLK) Synchronization: Allows the software to globally synchronize all enabled eHRPWM modules to the time base clock (TBCLK).
- McASP0 AMUTEIN signal source control: Allows selecting GPIO interrupt from different banks as source for the McASP0 AMUTEIN signal.

The CFGCHIP1 is shown in [Figure 10-41](#) and described in [Table 10-45](#).

Figure 10-41. Chip Configuration 1 Register (CFGCHIP1)

31	27	26	22	21	17	16
CAP2SRC		CAP1SRC		CAP0SRC		HPIBYTEAD
R/W-0		R/W-0		R/W-0		R/W-0
15	14	13	12	11	8	
HPIENA	EDMA31TC0DBS		TBCLKSYNC	Reserved		
R/W-0	R/W-0		R/W-0	R/W-0		
7	4			3	0	
Reserved				AMUTESEL0		
R/W-0				R/W-0		

LEGEND: R/W = Read/Write; R = Read only; -n = value after reset

Table 10-45. Chip Configuration 1 Register (CFGCHIP1) Field Descriptions

Bit	Field	Value	Description
31-27	CAP2SRC	0	eCAP2 Pin input
		1h	McASP0 TX DMA Event
		2h	McASP0 RX DMA Event
		3h-1Fh	Reserved
26-22	CAP1SRC	0	eCAP1 Pin input
		1h	McASP0 TX DMA Event
		2h	McASP0 RX DMA Event
		3h-1Fh	Reserved

Table 10-45. Chip Configuration 1 Register (CFGCHIP1) Field Descriptions (continued)

Bit	Field	Value	Description
21-17	CAP0SRC		Selects the eCAP0 module event input.
		0	eCAP0 Pin input
		1h	McASP0 TX DMA Event
		2h	McASP0 RX DMA Event
		3h-1Fh	<i>Reserved</i>
16	HPIBYTEAD		HPI Byte/Word Address Mode select.
		0	Host address is a word address.
		1	Host address is a byte address.
15	HPIENA		HPI Enable Bit.
		0	HPI is disabled.
		1	HPI is enabled.
14-13	EDMA31TC0DBS		EDMA3_1_TC0 Default Burst Size.
		0	16 bytes
		1h	32 bytes
		2h	64 bytes
		3h	<i>Reserved</i>
12	TBCLKSYNC		eHRPWM Module Time Base Clock Synchronization. Allows you to globally synchronize all enabled eHRPWM modules to the time base clock (TBCLK).
		0	Time base clock (TBCLK) within each enabled eHRPWM module is stopped.
		1	All enabled eHRPWM module clocks are started with the first rising edge of TBCLK aligned. For perfectly synchronized TBCLKs, the prescaler bits in the TBCTL register of each eHRPWM module must be set identically.
11-4	Reserved	0	Reserved. Write the default value to all bits when modifying this register.
3-0	AMUTESELO		Selects the source of McASP0 AMUTEIN signal.
		0	Drive McASP0 AMUTEIN signal low.
		1h	GPIO Interrupt from Bank 0
		2h	GPIO Interrupt from Bank 1
		3h	GPIO Interrupt from Bank 2
		4h	GPIO Interrupt from Bank 3
		5h	GPIO Interrupt from Bank 4
		6h	GPIO Interrupt from Bank 5
		7h	GPIO Interrupt from Bank 6
		8h	GPIO Interrupt from Bank 7
		9h-Fh	<i>Reserved</i>

10.4.15 Chip Configuration 2 Register (CFGCHIP2)

The chip configuration 2 register (CFGCHIP2) controls the following functions:

- USB2.0 OTG PHY

The CFGCHIP2 is shown in [Figure 10-42](#) and described in [Table 10-46](#).

Figure 10-42. Chip Configuration 2 Register (CFGCHIP2)

31							24								
Reserved															
R-0															
23							18			17		16			
Reserved										USB0PHYCLKGD		USB0VBUSSENSE			
R-0										R-0		R-0			
15		14		13		12		11		10		9		8	
RESET		USB0OTGMODE		Reserved		USB0PHYCLKMUX		USB0PHYPWDN		USB0OTGPWRDN		USB0DATPOL			
R/W-1		R/W-3h		R/W-0		R/W-1		R/W-1		R/W-1		R/W-1		R/W-1	
7		6		5		4		3		0					
Reserved		USB0PHY_PLLON		USB0SESNDEN		USB0BDTCTEN		USB0REF_FREQ							
R/W-0		R/W-0		R/W-0		R/W-0		R/W-0							

LEGEND: R/W = Read/Write; R = Read only; -n = value after reset

Table 10-46. Chip Configuration 2 Register (CFGCHIP2) Field Descriptions

Bit	Field	Value	Description
31-18	Reserved	0	Reserved
17	USB0PHYCLKGD	0 1	Status of USB2.0 PHY. 0 Clock is not present, power is not good, and PLL has not locked. 1 Clock is present, power is good, and PLL has locked.
16	USB0VBUSSENSE	0 1	Status of USB2.0 PHY VBUS sense. 0 PHY is not sensing voltage presence on the VBUS pin. 1 PHY is sensing voltage presence on the VBUS pin.
15	RESET	0 1	USB2.0 PHY reset. 0 Not in reset. 1 USB2.0 PHY in reset.
14-13	USB0OTGMODE	0 1h 2h 3h	USB2.0 OTG subsystem mode. 0 No override. PHY drive signals to controller based on its comparators for VBUS and ID pins. 1h Override phy values to force USB host operation. 2h Override phy values to force USB device operation. 3h Override phy values to force USB host operation with VBUS low.
12	Reserved	0	Reserved. Write the default value when modifying this register.
11	USB0PHYCLKMUX	0 1	USB2.0 PHY reference clock input mux. 0 USB2.0 PHY reference clock (USB_REFCLKIN) is sourced by an external pin. 1 USB2.0 PHY reference clock (AUXCLK) is internally generated from the PLL.
10	USB0PHYPWDN	0 1	USB2.0 PHY operation state control. 0 USB2.0 PHY is enabled and is in operating state (normal operation). 1 USB2.0 PHY is disabled and powered down.
9	USB0OTGPWRDN	0 1	USB2.0 OTG subsystem (SS) operation state control. 0 OTG SS is enabled and is in operating state (normal operation). 1 OTG SS is disabled and is powered down.

Table 10-46. Chip Configuration 2 Register (CFGCHIP2) Field Descriptions (continued)

Bit	Field	Value	Description
8	USB0DATPOL	0	USB2.0 differential data lines polarity selector. Differential data polarities are inverted (USB_DP is connected to D- and USB_DM is connected to D+).
		1	Differential data polarity are not altered (USB_DP is connected to D+ and USB_DM is connected to D-).
7	Reserved	0	Reserved. Write the default value when modifying this register.
6	USB0PHY_PLLON	0	Drives USB2.0 PHY, allowing or preventing it from stopping the 48 MHz clock during USB SUSPEND. USB2.0 PHY is allowed to stop the 48 MHz clock during USB SUSPEND.
		1	USB2.0 PHY is prevented from stopping the 48 MHz clock during USB SUSPEND
5	USB0SESNDEN	0	USB2.0 Session End comparator enable. Session End comparator is disabled.
		1	Session End comparator is enabled.
4	USB0VB DTCTEN	0	USB2.0 VBUS line comparators enable. All VBUS line comparators are disabled.
		1	All VBUS line comparators are enabled.
3-0	USB0REF_FREQ	0	USB2.0 PHY reference clock input frequencies. <i>Reserved</i>
		1h	12 MHz
		2h	24 MHz
		3h	48 MHz
		4h	19.2 MHz
		5h	38.4 MHz
		6h	13 MHz
		7h	26 MHz
		8h	20 MHz
		9h	40 MHz
		Ah-Fh	<i>Reserved</i>

10.4.16 Chip Configuration 3 Register (CFGCHIP3)

The chip configuration 3 register (CFGCHIP3) controls the following peripheral/module functions:

- uPP Clock Source Control: Allows control for the source of the uPP 2x transmit clock.
- PLL Controller 1 memory-mapped register lock: Used to lock out writes to the PLLC1 memory-mapped registers (MMRs) to prevent any erroneous writes in software to the PLLC1 register space.
- ASYNC3 Clock Source Control: Allows control for the source of the ASYNC3 clock.
- PRU Event Input Select.
- DIV4p5 Clock Enable/Disable: The DIV4p5 (/4.5) hardware clock divider is provided to generate 133 MHz from the 600 MHz PLL clock for use as clocks to the EMIFs. Allows enabling/disabling this clock divider.
- EMIFA Module Clock Source Control: Allows control for the source of the EMIFA module clock.

The CFGCHIP3 is shown in [Figure 10-43](#) and described in [Table 10-47](#).

Figure 10-43. Chip Configuration 3 Register (CFGCHIP3)

31				16				15				8			
Reserved								Reserved							
R-0								R/W-FFh							
7		6		5		4		3		2		1		0	
Reserved	UPP_TX_CLKSRC	PLL1_MASTER_LOCK	ASYNC3_CLKSRC	PRUEVTSEL	DIV45PENA	EMA_CLKSRC	Reserved	Reserved	UPP_TX_CLKSRC	PLL1_MASTER_LOCK	ASYNC3_CLKSRC	PRUEVTSEL	DIV45PENA	EMA_CLKSRC	Reserved
R/W-0	R/W-0	R/W-0	R/W-0	R/W-0	R/W-0	R/W-0	R/W-0	R/W-0	R/W-0	R/W-0	R/W-0	R/W-0	R/W-0	R/W-0	R/W-0

LEGEND: R/W = Read/Write; R = Read only; -n = value after reset

Table 10-47. Chip Configuration 3 Register (CFGCHIP3) Field Descriptions

Bit	Field	Value	Description
31-16	Reserved	0	Reserved
15-8	Reserved	FFh	Reserved. Write the default value to all bits when modifying this register.
7	Reserved	0	Reserved. Write the default value when modifying this register.
6	UPP_TX_CLKSRC	0 1	Clock source for uPP 2x transmit clock. 0 Clock driven by ASYNC3. 1 Clock driven by external signal, 2xTXCLK.
5	PLL1_MASTER_LOCK	0 1	PLLC1 MMRs lock. 0 PLLC1 MMRs are freely accessible. 1 All PLLC1 MMRs are locked.
4	ASYNC3_CLKSRC	0 1	Clock source for ASYNC3. 0 Clock driven by PLL0_SYSCLK2. 1 Clock driven by PLL1_SYSCLK2.
3	PRUEVTSEL	0 1	PRU event input select. 0 Normal mode 1 Alternate mode
2	DIV45PENA	0 1	Controls the fixed DIV4.5 divider in the PLL controller. 0 Divide by 4.5 is disabled. 1 Divide by 4.5 is enabled.
1	EMA_CLKSRC	0 1	Clock source for EMIFA clock domain. 0 Clock driven by PLL0_SYSCLK3 1 Clock driven by DIV4.5 PLL output
0	Reserved	0	Reserved. Write the default value when modifying this register.

10.4.17 Chip Configuration 4 Register (CFGCHIP4)

The chip configuration 4 register (CFGCHIP4) is used for clearing the AMUNTEIN signal for McASP0. Writing a 1 causes a single pulse that clears the latched GPIO interrupt for AMUTEIN of McASP0, if it was previously set; reads always return a value of 0. The CFGCHIP4 is shown in [Figure 10-44](#) and described in [Table 10-48](#).

Figure 10-44. Chip Configuration 4 Register (CFGCHIP4)

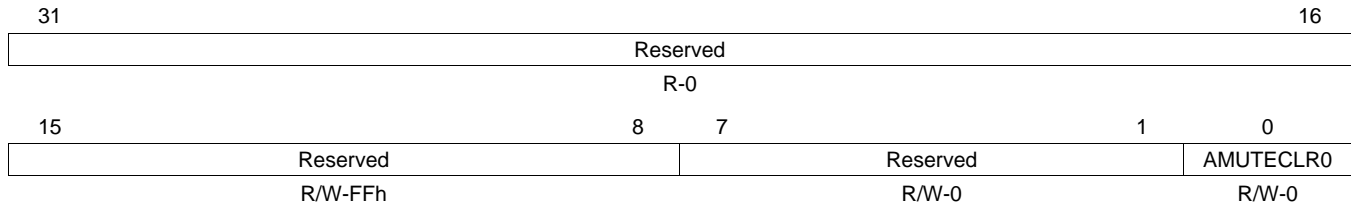

LEGEND: R/W = Read/Write; R = Read only; -n = value after reset

Table 10-48. Chip Configuration 4 Register (CFGCHIP4) Field Descriptions

Bit	Field	Value	Description
31-16	Reserved	0	Reserved
15-8	Reserved	FFh	Reserved. Write the default value to all bits when modifying this register.
7-1	Reserved	0	Reserved. Write the default value to all bits when modifying this register.
0	AMUTECLR0	0	Clears the latched GPIO interrupt for AMUTEIN of McASP0 when set to 1. No effect
		1	Clears interrupt

10.4.18 VTP I/O Control Register (VTPIO_CTL)

The VTP I/O control register (VTPIO_CTL) is used to control the calibration of the DDR2/mDDR memory controller I/Os with respect to voltage, temperature, and process (VTP). The voltage, temperature, and process information is used to control the IO's output impedance. The VTPIO_CTL is shown in Figure 10-45 and described in Table 10-49.

Figure 10-45. VTP I/O Control Register (VTPIO_CTL)

31	Reserved								24
	R-0								
23	Reserved				19	18	17	16	
	R-0				R/W-0		R/W-0		
15	14	13	12	11	10	9	8		
READY	IOPWRDN	CLKRZ	FORCEDNP	FORCEDNN	FORCEUPP	FORCEUPN	PWRSAVE		
R-0	R/W-0	R/W-0	R/W-0	R/W-0	R/W-0	R/W-0	R/W-0		
7	6	5	4	3	2	1	0		
LOCK	POWERDN	D0	D1	D2	F0	F1	F2		
R/W-0	R/W-1	R/W-1	R/W-1	R/W-0	R/W-1	R/W-1	R/W-1		

LEGEND: R/W = Read/Write; R = Read only; -n = value after reset

Table 10-49. VTP I/O Control Register (VTPIO_CTL) Field Descriptions

Bit	Field	Value	Description
31-19	Reserved	0	Reserved
18	VREFEN	0 1	Internal DDR I/O Vref enable. 0 Connected to pad, external reference. 1 Connected to internal reference.
17-16	VREFTAP	0 1h 2h 3h	Selection for internal reference voltage level. 0 Vref = 50.0% of VDD5 1h Vref = 47.5% of VDD5 2h Vref = 52.5% of VDD5 3h <i>Reserved</i>
15	READY	0 1	VTP Ready status. 0 VTP is not ready. 1 VTP is ready.
14	IOPWRDN	0 1	Power down enable for DDR input buffer. 0 Disable power down control by the PWRDNEN bit in the DDR PHY control register 1 (DRPYC1R). 1 Enable power down control by the PWRDNEN bit in the DDR PHY control register 1 (DRPYC1R).
13	CLKRZ	0	VTP clear. Write 0 to clear VTP flops.
12	FORCEDNP	0	Force decrease PFET drive.
11	FORCEDNN	0	Force decrease NFET drive.
10	FORCEUPP	0	Force increase PFET drive.
9	FORCEUPN	0	Force increase PFET drive.
8	PWRSAVE	0 1	VTP power save mode. Turn off power to the external resistor when it is not needed. The PWRSAVE bit setting is only valid when the POWERDN bit is cleared to 0. 0 Disable power save mode. 1 Enable power save mode.
7	LOCK	0 1	VTP impedance lock. Lock impedance value so that the VTP controller can be powered down. 0 Unlock impedance. 1 Lock impedance.

Table 10-49. VTP I/O Control Register (VTPIO_CTL) Field Descriptions (continued)

Bit	Field	Value	Description
6	POWERDN		VTP power down. Power down the VTP controller. The PWRSAVE bit setting is only valid when the POWERDN bit is cleared to 0.
		0	Disable power down.
		1	Enable power down.
5	D0	1	Drive strength control bit.
4	D1	1	Drive strength control bit.
3	D2	0	Drive strength control bit.
2	F0	1	Digital filter control bit.
1	F1	1	Digital filter control bit.
0	F2	1	Digital filter control bit.

10.4.19 DDR Slew Register (DDR_SLEW)

The DDR slew register (DDR_SLEW) reflects the DDR I/O timing as programmed in the device eFuse. The CMOSEN field configures the DDR I/O cells into an LVCMOS buffer (this makes it mDDR compatible). The DDR_SLEW is shown in [Figure 10-46](#) and described in [Table 10-50](#).

Figure 10-46. DDR Slew Register (DDR_SLEW)

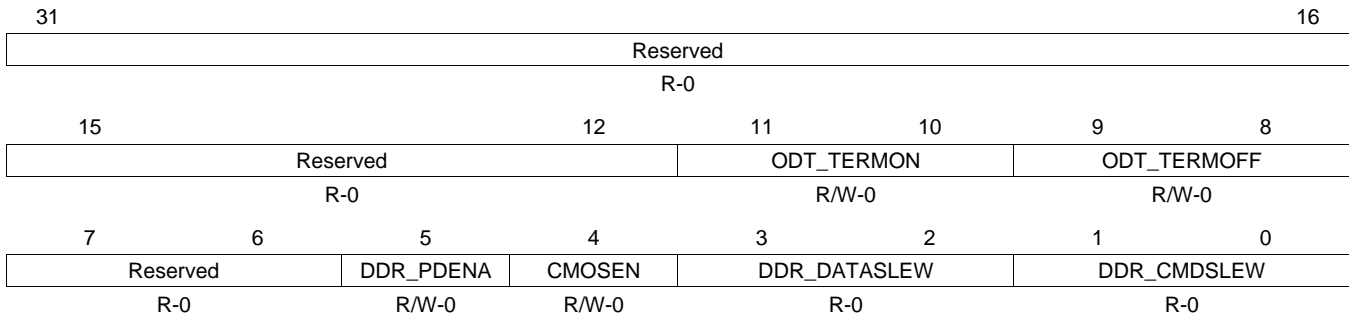

LEGEND: R/W = Read/Write; R = Read only; -n = value after reset

Table 10-50. DDR Slew Register (DDR_SLEW) Field Descriptions

Bit	Field	Value	Description
31-12	Reserved	0	Reserved
11-10	ODT_TERMON	0 <i>1h-3h</i>	Controls Thevenin termination mode while I/O is in read or write mode. Termination is not supported on this device. No termination <i>Reserved</i>
9-8	ODT_TERMOFF	0 <i>1h-3h</i>	Controls Thevenin termination mode while I/O is not in read or write mode. Termination is not supported on this device. No termination <i>Reserved</i>
7-6	Reserved	0	Reserved
5	DDR_PDENA	0 1	Enables pull downs for mDDR mode (should be disabled for DDR2). 0 Pull downs are disabled. Disable pull downs when using DDR2. 1 Pull downs are enabled. Enable pull downs when using mDDR.
4	CMOSEN	0 1	Selects mDDR LVCMOS RX / SSTL18 differential RX. 0 SSTL Receiver. Select SSTL when using DDR2. 1 LVCMOS Receiver. Select LVCMOS when using mDDR.
3-2	DDR_DATASLEW	0 <i>1h-3h</i>	Slew rate mode control status for data macro. Slew rate control is not supported on this device. 0 Slew rate control is off. <i>Reserved</i>
1-0	DDR_CMDSLEW	0 <i>1h-3h</i>	Slew rate mode control status for command macro. Slew rate control is not supported on this device. 0 Slew rate control is off. <i>Reserved</i>

10.4.20 Deep Sleep Register (DEEPSLEEP)

The deep sleep register (DEEPSLEEP) control the Deep Sleep logic. See the device-specific data manual and [Chapter 12](#) for details on boot and configuration settings. The DEEPSLEEP is shown in [Figure 10-47](#) and described in [Table 10-51](#).

Figure 10-47. Deep Sleep Register (DEEPSLEEP)

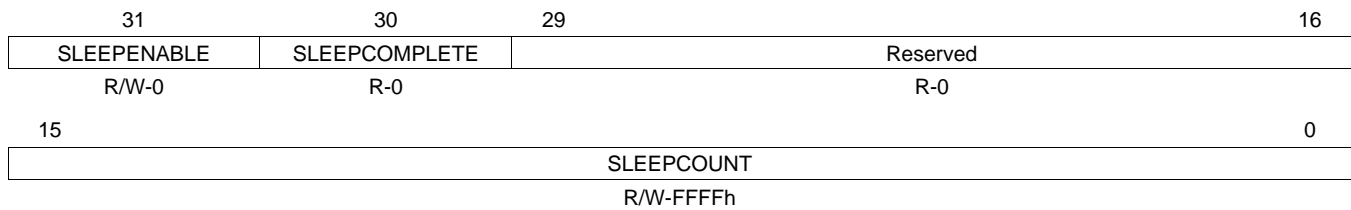

LEGEND: R/W = Read/Write; R = Read only; -n = value after reset

Table 10-51. Deep Sleep Register (DEEPSLEEP) Field Descriptions

Bit	Field	Value	Description
31	SLEEPENABLE	0 1	<p>Deep sleep enable. The software must clear this bit to 0 when the device is awakened from deep sleep.</p> <p>Device is in normal operating mode; <u>DEEPSLEEP</u> pin has no effect.</p> <p>Deep sleep mode is enabled; setting <u>DEEPSLEEP</u> pin low initiates oscillator shut down.</p>
30	SLEEPCOMPLETE	0 1	<p>Deep sleep complete. Once the deep sleep process starts, the software must poll the SLEEPCOMPLETE bit; when the SLEEPCOMPLETE bit is read as 1, the software should clear the SLEEPENABLE bit and continue operation.</p> <p>SLEEPCOUNT delay is not complete.</p> <p>SLEEPCOUNT delay is complete.</p>
29-16	Reserved	0	Reserved
15-0	SLEEPCOUNT	0-FFFFh	<p>Deep sleep counter. Number of cycles to count prior to the oscillator being stable. All 16 bits are tied directly to the counter in the Deep Sleep logic.</p>

10.4.21 Pullup/Pulldown Enable Register (PUPD_ENA)

The pullup/pulldown enable register (PUPD_ENA) enables the pull-up or pull-down functionality for the pin group n defined in your device-specific data manual. The PUPD_ENA is shown in [Figure 10-48](#) and described in [Table 10-52](#).

Figure 10-48. Pullup/Pulldown Enable Register (PUPD_ENA)

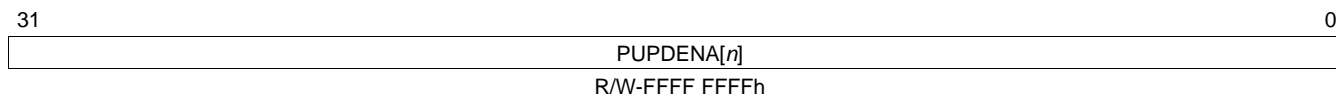

LEGEND: R/W = Read/Write; - n = value after reset

Table 10-52. Pullup/Pulldown Enable Register (PUPD_ENA) Field Descriptions

Bit	Field	Value	Description
31-0	PUPDENA[n]		Enables internal pull-up or pull-down functionality for pin group CP[n]. See your device-specific data manual for pin group information. The internal pull-up or pull-down functionality selection for bit position n in PUPD_ENA is set in the same bit position n of the pullup/pulldown select register (PUPD_SEL).
		0	Internal pull-up or pull-down functionality for pin group n is disabled.
		1	Internal pull-up or pull-down functionality for pin group n is enabled.

10.4.22 Pullup/Pulldown Select Register (PUPD_SEL)

The pullup/pulldown select register (PUPD_SEL) selects between the pull-up or pull-down functionality for the pin group n defined in your device-specific data manual. The PUPD_SEL is shown in [Figure 10-49](#) and described in [Table 10-53](#) and [Table 10-54](#).

NOTE: The PUPD_SEL settings are not active until the device is out of reset. During reset, all of the CP[n] pins are weakly pulled down. If the application requires a pull-up during reset, an external pull-up should be used.

Figure 10-49. Pullup/Pulldown Select Register (PUPD_SEL)

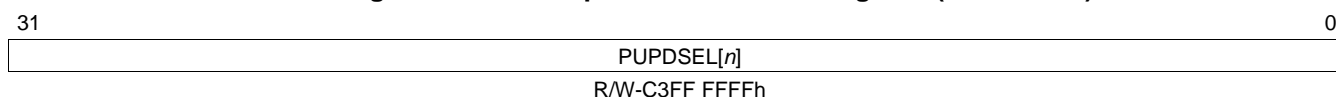

LEGEND: R/W = Read/Write; - n = value after reset

Table 10-53. Pullup/Pulldown Select Register (PUPD_SEL) Field Descriptions

Bit	Field	Value	Description
31-0	PUPDSEL[n]		Selects between the internal pull-up or pull-down functionality for pin group CP[n]. See your device-specific data manual for pin group information. The selection for bit position n in PUPD_SEL is only valid when the same bit position n is set in the pullup/pulldown enable register (PUPD_ENA).
		0	Internal pull-down functionality for pin group n is enabled.
		1	Internal pull-up functionality for pin group n is enabled.

Table 10-54. Pullup/Pulldown Select Register (PUPD_SEL) Default Values

Bit	Field	Default Value	Description
31	PUPDSEL[31]	1	Pin Group CP[31] is configured for pull-up by default.
30	PUPDSEL[30]	1	Pin Group CP[30] is configured for pull-up by default.
29	PUPDSEL[29]	0	Pin Group CP[29] is configured for pull-down by default.
28	PUPDSEL[28]	0	Pin Group CP[28] is configured for pull-down by default.
27	PUPDSEL[27]	0	Pin Group CP[27] is configured for pull-down by default.
26	PUPDSEL[26]	0	Pin Group CP[26] is configured for pull-down by default.
25	PUPDSEL[25]	1	Pin Group CP[25] is configured for pull-up by default.
24	PUPDSEL[24]	1	Pin Group CP[24] is configured for pull-up by default.
23	PUPDSEL[23]	1	Pin Group CP[23] is configured for pull-up by default.
22	PUPDSEL[22]	1	Pin Group CP[22] is configured for pull-up by default.
21	PUPDSEL[21]	1	Pin Group CP[21] is configured for pull-up by default.
20	PUPDSEL[20]	1	Pin Group CP[20] is configured for pull-up by default.
19	PUPDSEL[19]	1	Pin Group CP[19] is configured for pull-up by default.
18	PUPDSEL[18]	1	Pin Group CP[18] is configured for pull-up by default.
17	PUPDSEL[17]	1	Pin Group CP[17] is configured for pull-up by default.
16	PUPDSEL[16]	1	Pin Group CP[16] is configured for pull-up by default.
15	PUPDSEL[15]	1	Pin Group CP[15] is configured for pull-up by default.
14	PUPDSEL[14]	1	Pin Group CP[14] is configured for pull-up by default.
13	PUPDSEL[13]	1	Pin Group CP[13] is configured for pull-up by default.
12	PUPDSEL[12]	1	Pin Group CP[12] is configured for pull-up by default.
11	PUPDSEL[11]	1	Pin Group CP[11] is configured for pull-up by default.
10	PUPDSEL[10]	1	Pin Group CP[10] is configured for pull-up by default.
9	PUPDSEL[9]	1	Pin Group CP[9] is configured for pull-up by default.
8	PUPDSEL[8]	1	Pin Group CP[8] is configured for pull-up by default.
7	PUPDSEL[7]	1	Pin Group CP[7] is configured for pull-up by default.
6	PUPDSEL[6]	1	Pin Group CP[6] is configured for pull-up by default.
5	PUPDSEL[5]	1	Pin Group CP[5] is configured for pull-up by default.
4	PUPDSEL[4]	1	Pin Group CP[4] is configured for pull-up by default.
3	PUPDSEL[3]	1	Pin Group CP[3] is configured for pull-up by default.
2	PUPDSEL[2]	1	Pin Group CP[2] is configured for pull-up by default.
1	PUPDSEL[1]	1	Pin Group CP[1] is configured for pull-up by default.
0	PUPDSEL[0]	1	Pin Group CP[0] is configured for pull-up by default.

10.4.23 RXACTIVE Control Register (RXACTIVE)

The RXACTIVE control register (RXACTIVE) enables or disables the LVCMOS receivers for the for the pin group n defined in your device-specific data manual. The RXACTIVE is shown in [Figure 10-50](#) and described in [Table 10-55](#).

Figure 10-50. RXACTIVE Control Register (RXACTIVE)

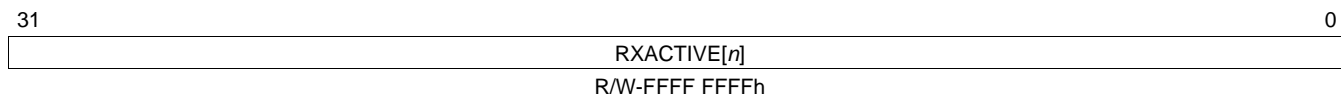

LEGEND: R/W = Read/Write; - n = value after reset

Table 10-55. RXACTIVE Control Register (RXACTIVE) Field Descriptions

Bit	Field	Value	Description
31-0	RXACTIVE[n]	0	Enables the LVCMOS receivers on pin group n. See your device-specific data manual for pin group information. Receivers should only be disabled if the associated pin group is not being used. LVCMOS receivers for pin group n are disabled.
		1	LVCMOS receivers for pin group n are enabled.

ARM Interrupt Controller (AINTC)

Topic	Page
11.1 Introduction	222
11.2 Interrupt Mapping	222
11.3 AINTC Methodology	225
11.4 AINTC Registers	229

11.1 Introduction

The ARM interrupt controller (AINTC) is an interface between interrupts coming from different parts of the system (these are referred to as system interrupts in the document), and the ARM9 interrupt interface. ARM9 supports two types of interrupts: FIQ and IRQ. These are referred to as host interrupts in this document. The AINTC has the following features:

- Supports up to 101 system interrupts.
- Supports up to 32 interrupt channels.
- Channels 0 and 1 are mapped (hard-wired) to the FIQ ARM interrupt and channels 2-31 are mapped to IRQ ARM interrupt.
- Each system interrupt can be enabled and disabled.
- Each host interrupt can be enabled and disabled.
- Hardware prioritization of interrupts.
- Combining of interrupts from IPs to a single system interrupt.
- Supports two active low debug interrupts.

See the ARM926EJ Technical Reference Manual for information about the ARM's FIQ and IRQ interrupts.

11.2 Interrupt Mapping

The AINTC supports up to 101 system interrupts from different peripherals to be mapped to 32 channels inside the AINTC (see [Figure 11-1](#)). Interrupts from these 32 channels are further mapped to either an ARM FIQ interrupt or an ARM IRQ interrupt.

- Any of the 101 system interrupts can be mapped to any of the 32 channels.
- Multiple interrupts can be mapped to a single channel.
- An interrupt should not be mapped to more than one channel.
- Interrupts from channels 0 and 1 are mapped to FIQ ARM interrupt on host side.
- Interrupts from channels 2 to 31 are mapped to IRQ ARM interrupt on host side.
- For $I < k$, interrupts on channel-I have higher priority than interrupts on channel-k.
- For interrupts on same channel, priority is determined by the hardware interrupt number. The lower the interrupt number, the higher the priority.

[Table 11-1](#) shows the system interrupt assignments for the AINTC.

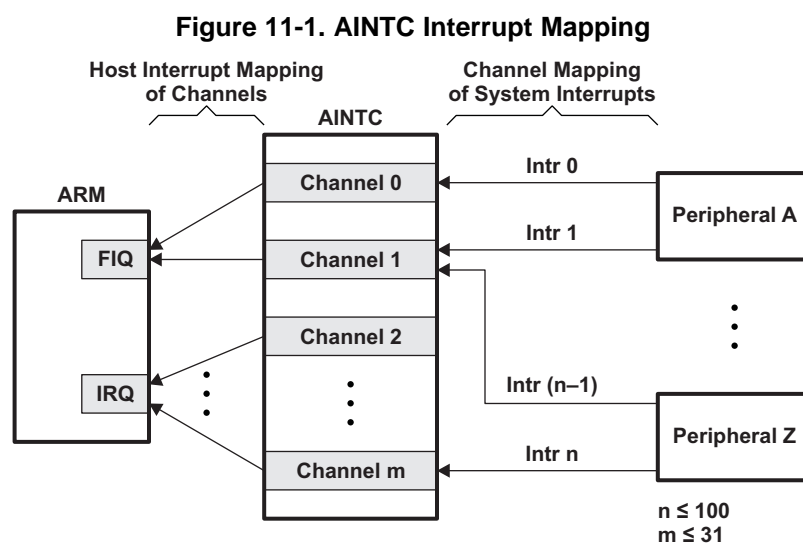

Table 11-1. AINTC System Interrupt Assignments

Event	Interrupt Name	Source
0	COMMTX	ARM
1	COMMRX	ARM
2	NINT	ARM
3	PRU_EVTOUT0	PRUSS Interrupt
4	PRU_EVTOUT1	PRUSS Interrupt
5	PRU_EVTOUT2	PRUSS Interrupt
6	PRU_EVTOUT3	PRUSS Interrupt
7	PRU_EVTOUT4	PRUSS Interrupt
8	PRU_EVTOUT5	PRUSS Interrupt
9	PRU_EVTOUT6	PRUSS Interrupt
10	PRU_EVTOUT7	PRUSS Interrupt
11	EDMA3_0_CC0_INT0	EDMA3_0 Channel Controller 0 Shadow Region 0 Transfer Completion Interrupt
12	EDMA3_0_CC0_ERRINT	EDMA3_0 Channel Controller 0 Error Interrupt
13	EDMA3_0_TC0_ERRINT	EDMA3_0 Transfer Controller 0 Error Interrupt
14	EMIFA_INT	EMIFA Interrupt
15	IIC0_INT	I2C0 interrupt
16	MMCSD0_INT0	MMCSD0 MMC/SD Interrupt
17	MMCSD0_INT1	MMCSD0 SDIO Interrupt
18	PSC0_ALLINT	PSC0 Interrupt
19	RTC_IRQS[1:0]	RTC Interrupt
20	SPI0_INT	SPI0 Interrupt
21	T64P0_TINT12	Timer64P0 Interrupt (TINT12)
22	T64P0_TINT34	Timer64P0 Interrupt (TINT34)
23	T64P1_TINT12	Timer64P1 Interrupt (TINT12)
24	T64P1_TINT34	Timer64P1 Interrupt (TINT34)
25	UART0_INT	UART0 Interrupt
26	—	Reserved
27	PROTERR	SYSCFG Protection Shared Interrupt
28	SYSCFG_CHIPINT0	SYSCFG CHIPSIG Register
29	SYSCFG_CHIPINT1	SYSCFG CHIPSIG Register
30	SYSCFG_CHIPINT2	SYSCFG CHIPSIG Register
31	SYSCFG_CHIPINT3	SYSCFG CHIPSIG Register
32	EDMA3_0_TC1_ERRINT	EDMA3_0 Transfer Controller 1 Error Interrupt
33-40	—	Reserved
41	DDR2_MEMERR	DDR2 Controller Interrupt
42	GPIO_B0INT	GPIO Bank 0 Interrupt
43	GPIO_B1INT	GPIO Bank 1 Interrupt
44	GPIO_B2INT	GPIO Bank 2 Interrupt
45	GPIO_B3INT	GPIO Bank 3 Interrupt
46	GPIO_B4INT	GPIO Bank 4 Interrupt
47	GPIO_B5INT	GPIO Bank 5 Interrupt
48	GPIO_B6INT	GPIO Bank 6 Interrupt
49	GPIO_B7INT	GPIO Bank 7 Interrupt
50	GPIO_B8INT	GPIO Bank 8 Interrupt
51	IIC1_INT	I2C1 Interrupt
52	LCDC_INT	LCD Controller Interrupt
53	UART_INT1	UART1 Interrupt

Table 11-1. AINTC System Interrupt Assignments (continued)

Event	Interrupt Name	Source
54	MCASP_INT	McASP0 Combined RX/TX Interrupt
55	PSC1_ALLINT	PSC1 Interrupt
56	SPI1_INT	SPI1 Interrupt
57	UHPI_ARMINT	HPI ARM Interrupt
58	USB0_INT	USB0 (USB2.0) Interrupt
59-60	—	Reserved
61	UART2_INT	UART2 Interrupt
62	—	Reserved
63	EHRPWM0	HiResTimer / PWM0 Interrupt
64	EHRPWM0TZ	HiResTimer / PWM0 Trip Zone Interrupt
65	EHRPWM1	HiResTimer / PWM1 Interrupt
66	EHRPWM1TZ	HiResTimer / PWM1 Trip Zone Interrupt
67	—	Reserved
68	T64P2_ALL	Timer64P2 Combined Interrupt (TINT12 and TINT34)
69	ECAP0	eCAP0 Interrupt
70	ECAP1	eCAP1 Interrupt
71	ECAP2	eCAP2 Interrupt
72	MMCS1_INT0	MMCS1 MMC/SD Interrupt
73	MMCS1_INT1	MMCS1 SDIO Interrupt
74	T64P2_CMPINT0	Timer64P2 - Compare Interrupt 0
75	T64P2_CMPINT1	Timer64P2 - Compare Interrupt 1
76	T64P2_CMPINT2	Timer64P2 - Compare Interrupt 2
77	T64P2_CMPINT3	Timer64P2 - Compare Interrupt 3
78	T64P2_CMPINT4	Timer64P2 - Compare Interrupt 4
79	T64P2_CMPINT5	Timer64P2 - Compare Interrupt 5
80	T64P2_CMPINT6	Timer64P2 - Compare Interrupt 6
81	T64P2_CMPINT7	Timer64P2 - Compare Interrupt 7
82	T64P3_CMPINT0	Timer64P3 - Compare Interrupt 0
83	T64P3_CMPINT1	Timer64P3 - Compare Interrupt 1
84	T64P3_CMPINT2	Timer64P3 - Compare Interrupt 2
85	T64P3_CMPINT3	Timer64P3 - Compare Interrupt 3
86	T64P3_CMPINT4	Timer64P3 - Compare Interrupt 4
87	T64P3_CMPINT5	Timer64P3 - Compare Interrupt 5
88	T64P3_CMPINT6	Timer64P3 - Compare Interrupt 6
89	T64P3_CMPINT7	Timer64P3 - Compare Interrupt 7
90	ARMCLKSTOPREQ	PSC0 Interrupt
91	uPP_ALLINT	uPP Combined Interrupt
92	VPIF_ALLINT	VPIF Combined Interrupt
93	EDMA3_1_CC0_INT0	EDMA3_1 Channel Controller 0 Shadow Region 0 Transfer Completion Interrupt
94	EDMA3_1_CC0_ERRINT	EDMA3_1 Channel Controller 0 Error Interrupt
95	EDMA3_1_TC0_ERRINT	EDMA3_1 Transfer Controller 0 Error Interrupt
96	T64P3_ALL	Timer64P3 Combined Interrupt (TINT12 and TINT34)
97	MCBSP0_RINT	McBSP0 Receive Interrupt
98	MCBSP0_XINT	McBSP0 Transmit Interrupt
99	MCBSP1_RINT	McBSP1 Receive Interrupt
100	MCBSP1_XINT	McBSP1 Transmit Interrupt

11.3 AINTC Methodology

The AINTC module controls the system interrupt mapping to the host interrupt interface. System interrupts are generated by the device peripherals. The AINTC receives the system interrupts and maps them to internal channels. The channels are used to combine and prioritize system interrupts. These channels are then mapped onto the host interface that is typically a smaller number of host interrupts or a vector input. Interrupts from system side are active high in polarity. Also, they are pulse type of interrupts.

The AINTC encompasses many functions to process the system interrupts and prepare them for the host interface. These functions are: processing, enabling, status, channel mapping, host interrupt mapping, prioritization, vectorization, debug, and host interfacing. Figure 11-2 illustrates the flow of system interrupts through the functions to the host. The following subsections describe each part of the flow.

Figure 11-2. Flow of System Interrupts to Host

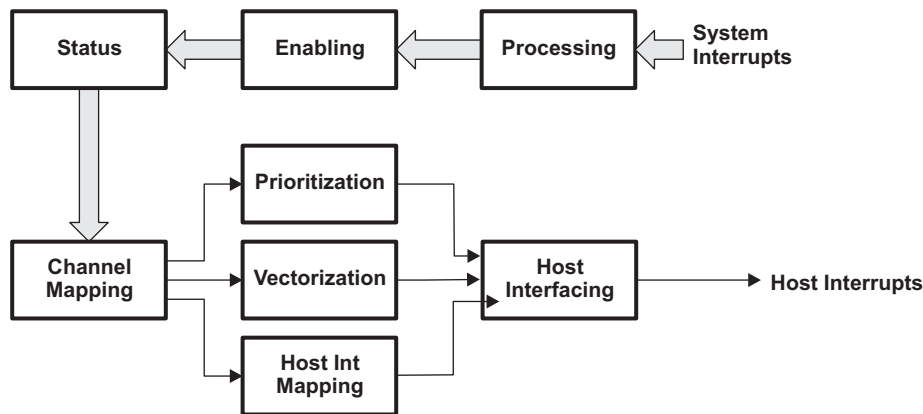

11.3.1 Interrupt Processing

The interrupt processing block does the following tasks:

- Synchronization of slower and asynchronous interrupts
- Conversion of polarity to active high
- Conversion of interrupt type to pulse interrupts

After the processing block, all interrupts will be active-high pulses.

11.3.2 Interrupt Enabling

The AINTC interrupt enable system allows individual interrupts to be enabled or disabled. Use the following sequence to enable interrupts:

1. Enable global host interrupts. All host interrupts are enabled by setting the ENABLE bit in the global enable register (GER). Individual host interrupts are enabled or disabled from their individual enables and are not overridden by the global enable.
2. Enable host interrupt lines. Host interrupt lines (FIQ and IRQ) can be enabled through one of two methods:
 - (a) Set the desired mapped bit(s) in the host interrupt enable register (HIER), or
 - (b) Write the host interrupt index (0-1) to the host interrupt enable indexed set register (HIEISR) for every interrupt line to enable.
3. Enable system interrupts. System interrupts can be individually enabled through one of two methods:
 - (a) Set the desired mapped bit(s) in the system interrupt enable set registers (ESR1-ESR4), or
 - (b) Write the system interrupt index (0-100) to the system interrupt enable indexed set register (EISR) for every system interrupt to enable.

11.3.3 Interrupt Status Checking

The next stage is to capture which system interrupts are pending. There are two kinds of pending status: raw status and enabled status. Raw status is the pending status of the system interrupt without regards to the enable bit for the system interrupt. Enabled status is the pending status of the system interrupts with the enable bits active. When the enable bit is inactive, the enabled status will always be inactive.

The enabled status of system interrupts is captured in system interrupt status enabled/clear registers (SECR1-SECR4). Status of system interrupt 'N' is indicated by the Nth bit of SECR1-SECR4. Since there exists 101 system interrupts, four 32-bit registers are used to capture the enabled status of interrupts.

The pending status reflects whether the system interrupt occurred since the last time the status register bit was cleared. Each bit in the status register is individually clearable.

11.3.4 Interrupt Channel Mapping

The AINTC has 32 internal channels to which enabled system interrupts can be mapped. Higher priority interrupts should be mapped to channels 0 and 1. Other interrupts can be mapped to any of the channels from 2 to 31. Channel 0 has highest priority and channel 31 has the lowest priority. Channels 0 and 1 are connected to FIQ ARM interrupt. Channels 2 to 31 are connected to IRQ ARM interrupt. Channels are used to group the system interrupts into a smaller number of priorities that can be given to a host interface with a very small number of interrupt inputs. When multiple system interrupts are mapped to the same channel their interrupts are ORed together so that when either is active the output is active.

The channel map registers (CMR m) define the channel for each system interrupt. There is one register per 4 system interrupts; therefore, there are 26 channel map registers (CMR0-CMR25) for a system of 101 interrupts. Channel for each system interrupt can be set using these registers.

11.3.5 Host Interrupt Mapping Interrupts

The Host is ARM9, which has two lines: FIQ and IRQ. The 32 channels from the AINTC are mapped to these two lines. The AINTC has a fixed host interrupt mapping scheme. Channels 0 and 1 are mapped to FIQ and channels 2-31 are mapped to IRQ. Thus, system interrupts mapped to channels 0 and 1 are propagated as FIQ to the host and system interrupts mapped to channels 2-31 are propagated as IRQ to the host. When multiple channels are mapped to the same host interrupt, then prioritization is done to select which interrupt is in the highest-priority channel and which should be sent first to the host.

11.3.6 Interrupt Prioritization

The next stage of the AINTC is prioritization. Since multiple interrupts feed into a single channel and multiple channels feed into a single host interrupt, it is necessary to prioritize between all the system interrupts/channels to decide on a single system interrupt to handle. The AINTC provides hardware to perform this prioritization with a given scheme so that software does not have to do this. There are two levels of prioritizations:

1. The first level of prioritization is between the active channels for a host interrupt. Channel 0 has the highest priority and channel 31 has the lowest. So the first level of prioritization picks the lowest numbered active channel.
2. The second level of prioritization is between the active system interrupts for the prioritized channel. The system interrupt in vector position 0 has the highest priority and system interrupt 100 has the lowest priority. So the second level of prioritization picks the lowest vector position active system interrupt.

The prioritized system interrupt for each host interrupt line (FIQ and IRQ) can be obtained from the host interrupt prioritized index registers (HIPIR1 and HIPIR2). The host interrupt prioritized index register values update dynamically as interrupts arrive at AINTC so care should be taken to avoid register race conditions.

The AINTC features a prioritization hold mode that is intended to prevent race conditions while servicing interrupts. This mode is enabled by setting the priority hold mode (PRHOLDMODE) bit in the control register (CR). When enabled, a read of either the host interrupt prioritized index register (HIPIR n) or the host interrupt prioritized vector register (HIPVR n) will freeze both the HIPIR n and HIPVR n values for the respective host interrupt n . The values are frozen until one of the following actions is taken to release the registers:

1. Write to the host interrupt prioritized index register (HIPIR n)
2. Write to the host interrupt prioritized vector register (HIPVR n)
3. Write-set bit n of the host interrupt enable register (HIER)
4. Write-set the active interrupt index to the host interrupt enable index set register (HIEISR)
5. Write-clear the active interrupt index to the host interrupt enable index clear register (HIEICR)

11.3.7 Interrupt Nesting

If interrupt service routines (ISRs) consume a large number of CPU cycles and may delay the servicing of other interrupts, the AINTC can perform a nesting function in its prioritization. Nesting is a method of disabling certain interrupts (usually lower-priority interrupts) when an interrupt is taken so that only those desired interrupts can trigger to the host while it is servicing the current interrupt. The typical usage is to nest on the current interrupt and disable all interrupts of the same or lower priority (or channel). Then the host will only be interrupted from a higher priority interrupt.

Nesting is available in 1 of 3 methods selectable by the NESTMODE bit in the control register (CR):

1. Nesting for all host interrupts, based on channel priority: When an interrupt is taken, the nesting level is set to its channel priority. From then, that channel priority and all lower priority channels will be disabled from generating host interrupts and only higher priority channels are allowed. When the interrupt is completely serviced, the nesting level is returned to its original value. When there is no interrupt being serviced, there are no channels disabled due to nesting. The global nesting level register (GNLR) allows the checking and setting of the global nesting level across all host interrupts. The nesting level is the channel (and all of lower priority channels) that are nested out because of a current interrupt.
2. Nesting for individual host interrupts, based on channel priority: Always nest based on channel priority for each host interrupt individually. When an interrupt is taken on a host interrupt, then, the nesting level is set to its channel priority for just that host interrupt, and other host interrupts do not have their nesting affected. Then for that host interrupt, equal or lower priority channels will not interrupt the host but may on other host interrupts if programmed. When the interrupt is completely serviced the nesting level for the host interrupt is returned to its original value. The host interrupt nesting level registers (HINLR1 and HINLR2) display and control the nesting level for each host interrupt. The nesting level controls which channel and lower priority channels are nested. There is one register per host interrupt.

3. Software manually performs the nesting of interrupts. When an interrupt is taken, the software will disable all the host interrupts, manually update the enables for any or all the system interrupts, and then re-enable all the host interrupts. This now allows only the system interrupts that are still enabled to trigger to the host. When the interrupt is completely serviced the software must reverse the changes to re-enable the nested out system interrupts. This method requires the most software interaction but gives the most flexibility if simple channel based nesting mechanisms are not adequate.

The recommended approach is the automatic host interrupt nesting method (second method). Because higher priority interrupts can preempt lower priority interrupts in this method, a software stack is used to keep track of nest priorities. The base stack value should be initialized to the default nest priority of the application. Take the following steps within the ARM hardware interrupt service routine to handle interrupts using host interrupt priority nesting:

1. Disable the ARM hardware interrupt.
2. Clear the OVERRIDE bit in the host interrupt nesting level register n (HINLR n) to expose the priority level of the active interrupt.
3. Push the active (or desired) interrupt priority value into the nest priority stack.
4. Write the active (or desired) priority level into HINLR n by setting the OVERRIDE bit.
5. Calculate and store the ISR address for the active interrupt. Unfreeze the host interrupt prioritized index register n (HIPIR n) and the host interrupt prioritized vector register n (HIPVR n), if the PRHOLDMODE bit in the control register (CR) is set.
6. Clear the system interrupt status by setting the appropriate bit in the system interrupt status enabled/clear register n (SECR n) or by writing the appropriate index to the system interrupt status indexed clear register (SICR).
7. Acknowledge and enable the ARM hardware interrupt.
8. Execute the ISR at the address stored from step 5. During this step, interrupts enabled by the new nest priority level will be able to preempt the ISR.
9. Disable the ARM hardware interrupt.
10. Discard the most recent priority level in the nest priority stack and restore the previous priority level to HINLR n by setting the OVERRIDE bit.
11. Enable the ARM hardware interrupt.

11.3.8 Interrupt Vectorization

The next stage of the AINTC is vectorization. Vectorization is an advanced feature that allows the host to receive an interrupt service routine (ISR) address in addition to just the interrupt status. Without vectorization the host would receive the interrupt and enter a general ISR that gets the prioritized system interrupt to service from the AINTC, looks up the specific ISR address for that system interrupt, and then jumps to that address. With vectorization the host can read a register that has the ISR address already calculated and jump to that address immediately.

Vectorization uses a base and universal size where all the ISR code is placed in a contiguous memory region with each ISR code a standard size. For this calculation, the vector base register (VBR) is programmed by software to hold the base address of all the ISR code and the vector size register (VSR) is programmed for the size in words between ISR code for each system interrupt. The index number of each system interrupt is used to calculate the final offset. The specific system interrupt ISR address is then calculated as:

$$\text{ISR address} = \text{base} + (\text{index} \times \text{size})$$

There is also a special case when there is no interrupt pending and then the ISR address is the ISR Null address. This is in case the vector address is executed when there is no pending interrupt so that a Null handler can be in place to just return from the interrupt. The vector null address register (VNR) holds the address of the ISR null address. When there is a pending interrupt then the ISR address is calculated as *exact base + offset* for that interrupt number.

11.3.9 Interrupt Status Clearing

After servicing the interrupt (after execution of the ISR), interrupt status is to be cleared. If a system interrupt status is not cleared, then another host interrupt may not be triggered or another host interrupt may be triggered incorrectly. For clearing the status of an interrupt, whose interrupt number is N, write a 1 to the Nth bit position in the system interrupt status enabled/clear registers (SECR1-SECR4). System interrupt N can also be cleared by writing the value N into the system interrupt status indexed clear register (SICR).

11.3.10 Interrupt Disabling

At any time, if any interrupt is not to be propagated to the host, then that interrupt should be disabled. For disabling an interrupt whose interrupt number is N, write a 1 to the Nth bit in the system interrupt enable clear registers (ECR1-ECR4). System interrupt N can also be disabled by writing the value N in the system interrupt enable indexed clear register (EICR).

11.4 AINTC Registers

Table 11-2 lists the memory-mapped registers for the AINTC.

Table 11-2. ARM Interrupt Controller (AINTC) Registers

Address	Acronym	Register Description	Section
FFFE E00h	REVID	Revision Identification Register	Section 11.4.1
FFFE E04h	CR	Control Register	Section 11.4.2
FFFE E010h	GER	Global Enable Register	Section 11.4.3
FFFE E01Ch	GNLR	Global Nesting Level Register	Section 11.4.4
FFFE E020h	SISR	System Interrupt Status Indexed Set Register	Section 11.4.5
FFFE E024h	SICR	System Interrupt Status Indexed Clear Register	Section 11.4.6
FFFE E028h	EISR	System Interrupt Enable Indexed Set Register	Section 11.4.7
FFFE E02Ch	EICR	System Interrupt Enable Indexed Clear Register	Section 11.4.8
FFFE E034h	HIEISR	Host Interrupt Enable Indexed Set Register	Section 11.4.9
FFFE E038h	HIEICR	Host Interrupt Enable Indexed Clear Register	Section 11.4.10
FFFE E050h	VBR	Vector Base Register	Section 11.4.11
FFFE E054h	VSR	Vector Size Register	Section 11.4.12
FFFE E058h	VNR	Vector Null Register	Section 11.4.13
FFFE E080h	GPIR	Global Prioritized Index Register	Section 11.4.14
FFFE E084h	GPVR	Global Prioritized Vector Register	Section 11.4.15
FFFE E200h	SRSR1	System Interrupt Status Raw/Set Register 1	Section 11.4.16
FFFE E204h	SRSR2	System Interrupt Status Raw/Set Register 2	Section 11.4.17
FFFE E208h	SRSR3	System Interrupt Status Raw/Set Register 3	Section 11.4.18
FFFE E20Ch	SRSR4	System Interrupt Status Raw/Set Register 4	Section 11.4.19
FFFE E280h	SECR1	System Interrupt Status Enabled/Clear Register 1	Section 11.4.20
FFFE E284h	SECR2	System Interrupt Status Enabled/Clear Register 2	Section 11.4.21
FFFE E288h	SECR3	System Interrupt Status Enabled/Clear Register 3	Section 11.4.22
FFFE E28Ch	SECR4	System Interrupt Status Enabled/Clear Register 4	Section 11.4.23
FFFE E300h	ESR1	System Interrupt Enable Set Register 1	Section 11.4.24
FFFE E304h	ESR2	System Interrupt Enable Set Register 2	Section 11.4.25
FFFE E308h	ESR3	System Interrupt Enable Set Register 3	Section 11.4.26
FFFE E30Ch	ESR4	System Interrupt Enable Set Register 4	Section 11.4.27
FFFE E380h	ECR1	System Interrupt Enable Clear Register 1	Section 11.4.28
FFFE E384h	ECR2	System Interrupt Enable Clear Register 2	Section 11.4.29
FFFE E388h	ECR3	System Interrupt Enable Clear Register 3	Section 11.4.30

Table 11-2. ARM Interrupt Controller (AINTC) Registers (continued)

Address	Acronym	Register Description	Section
FFFE E38Ch	ECR4	System Interrupt Enable Clear Register 4	Section 11.4.31
FFFE E400h– FFFE E464h	CMR0-CMR25	Channel Map Registers 0-25	Section 11.4.32
FFFE E900h	HIPIR1	Host Interrupt Prioritized Index Register 1	Section 11.4.33
FFFE E904h	HIPIR2	Host Interrupt Prioritized Index Register 2	Section 11.4.34
FFFE F100h	HINLR1	Host Interrupt Nesting Level Register 1	Section 11.4.35
FFFE F104h	HINLR2	Host Interrupt Nesting Level Register 2	Section 11.4.36
FFFE F500h	HIER	Host Interrupt Enable Register	Section 11.4.37
FFFE F600h	HIPVR1	Host Interrupt Prioritized Vector Register 1	Section 11.4.38
FFFE F604h	HIPVR2	Host Interrupt Prioritized Vector Register 2	Section 11.4.39

11.4.1 Revision Identification Register (REVID)

The revision identification register (REVID) is shown in [Figure 11-3](#) and described in [Table 11-3](#).

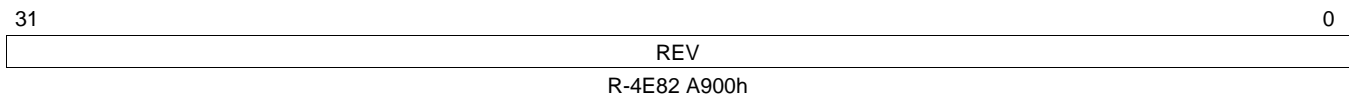
Figure 11-3. Revision Identification Register (REVID)

LEGEND: R = Read only; -n = value after reset

Table 11-3. Revision Identification Register (REVID) Field Descriptions

Bit	Field	Value	Description
31-0	REV	4E82 A900h	Revision ID of the AINTC.

11.4.2 Control Register (CR)

The control register (CR) holds global control parameters. The CR is shown in [Figure 11-4](#) and described in [Table 11-4](#).

Figure 11-4. Control Register (CR)

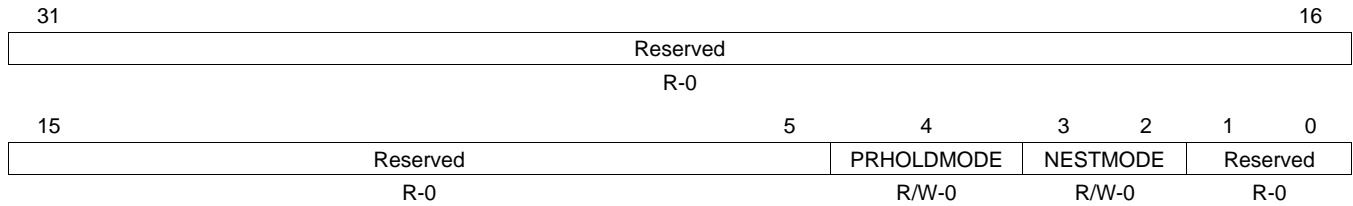

LEGEND: R/W = Read/Write; R = Read only; -n = value after reset

Table 11-4. Control Register (CR) Field Descriptions

Bit	Field	Value	Description
31-5	Reserved	0	Reserved
4	PRHOLDMODE	0	Enables priority holding mode.
		0	No priority holding. Prioritized MMRs will continually update.
		1	Priority holding enabled. Prioritized Index and Vector Address MMRs will hold their value after the first is read. See Section 11.3.6 for details.
3-2	NESTMODE	0-3h	Nesting mode.
		0	No nesting
		1h	Automatic individual nesting (per host interrupt)
		2h	Automatic global nesting (over all host interrupts)
		3h	Manual nesting
1-0	Reserved	0	Reserved

11.4.3 Global Enable Register (GER)

The global enable register (GER) enables all the host interrupts. Individual host interrupts are still enabled or disabled from their individual enables and are not overridden by the global enable. The GER is shown in [Figure 11-5](#) and described in [Table 11-5](#).

Figure 11-5. Global Enable Register (GER)

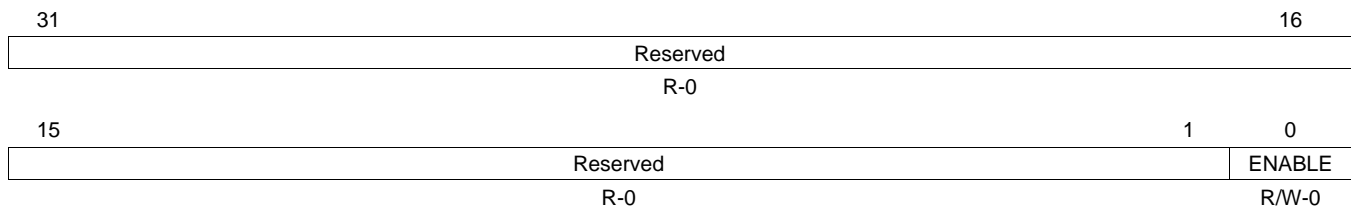

LEGEND: R/W = Read/Write; R = Read only; -n = value after reset

Table 11-5. Global Enable Register (GER) Field Descriptions

Bit	Field	Value	Description
31-1	Reserved	0	Reserved
0	ENABLE	0-1	The current global enable value when read. Writes set the global enable.

11.4.4 Global Nesting Level Register (GNLR)

The global nesting level register (GNLR) allows the checking and setting of the global nesting level across all host interrupts when automatic global nesting mode is set. The nesting level is the channel (and all of lower priority) that are nested out because of a current interrupt. The GNLR is shown in [Figure 11-6](#) and described in [Table 11-6](#).

Figure 11-6. Global Nesting Level Register (GNLR)

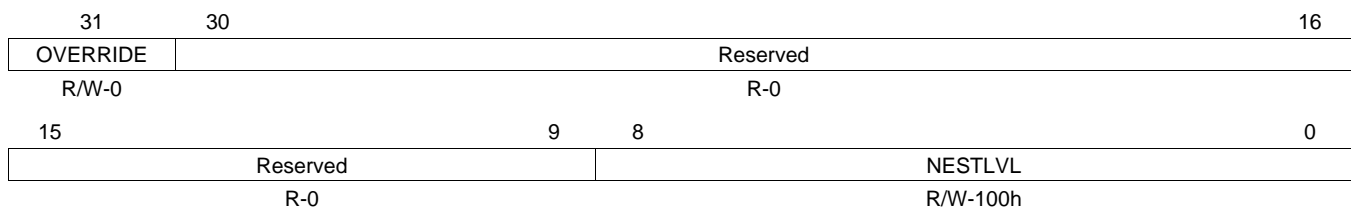

LEGEND: R/W = Read/Write; R = Read only; -n = value after reset

Table 11-6. Global Nesting Level Register (GNLR) Field Descriptions

Bit	Field	Value	Description
31	OVERVERRIDE	0-1	Always read as 0. Writes of 1 override the automatic nesting and set the NESTLVL to the written data.
30-9	Reserved	0	Reserved
8-0	NESTLVL	0-1FFh	The current global nesting level (highest channel that is nested). Writes set the nesting level. In autonesting mode this value is updated internally, unless the auto_override bit is set.

11.4.5 System Interrupt Status Indexed Set Register (SISR)

The system interrupt status indexed set register (SISR) allows setting the status of an interrupt. The interrupt to set is the INDEX value written. This sets the Raw Status Register bit of the given INDEX. The SISR is shown in [Figure 11-7](#) and described in [Table 11-7](#).

Figure 11-7. System Interrupt Status Indexed Set Register (SISR)

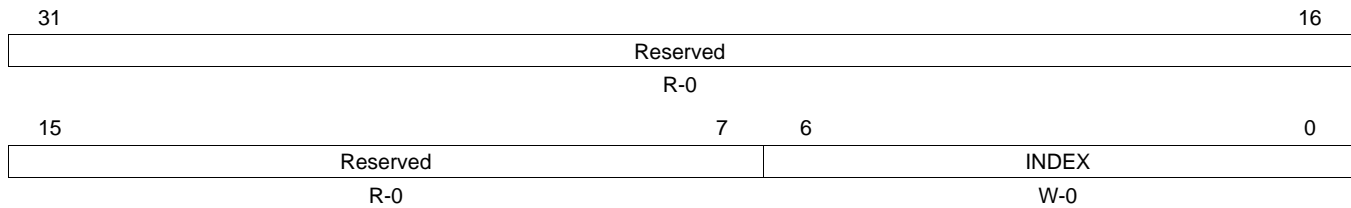

LEGEND: R = Read only; W = Write only; -n = value after reset

Table 11-7. System Interrupt Status Indexed Set Register (SISR) Field Descriptions

Bit	Field	Value	Description
31-7	Reserved	0	Reserved
6-0	INDEX	0-7Fh	Writes set the status of the interrupt given in the INDEX value. Reads return 0.

11.4.6 System Interrupt Status Indexed Clear Register (SICR)

The system interrupt status indexed clear register (SICR) allows clearing the status of an interrupt. The interrupt to clear is the INDEX value written. This clears the Raw Status Register bit of the given INDEX. The SICR is shown in [Figure 11-8](#) and described in [Table 11-8](#).

Figure 11-8. System Interrupt Status Indexed Clear Register (SICR)

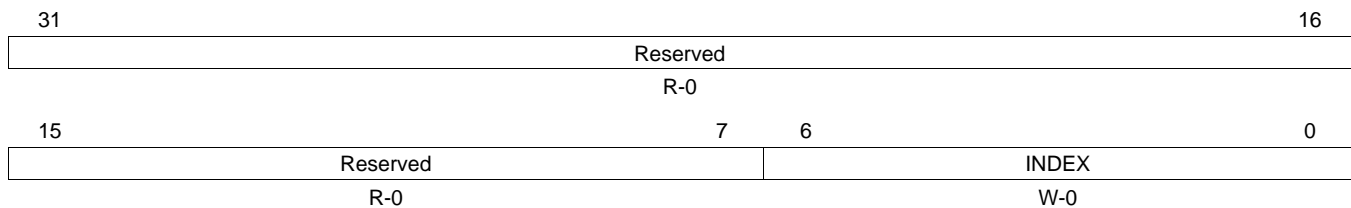

LEGEND: R = Read only; W = Write only; -n = value after reset

Table 11-8. System Interrupt Status Indexed Clear Register (SICR) Field Descriptions

Bit	Field	Value	Description
31-7	Reserved	0	Reserved
6-0	INDEX	0-7Fh	Writes clear the status of the interrupt given in the INDEX value. Reads return 0.

11.4.7 System Interrupt Enable Indexed Set Register (EISR)

The system interrupt enable indexed set register (EISR) allows enabling an interrupt. The interrupt to enable is the INDEX value written. This sets the Enable Register bit of the given INDEX. The EISR is shown in [Figure 11-9](#) and described in [Table 11-9](#).

Figure 11-9. System Interrupt Enable Indexed Set Register (EISR)

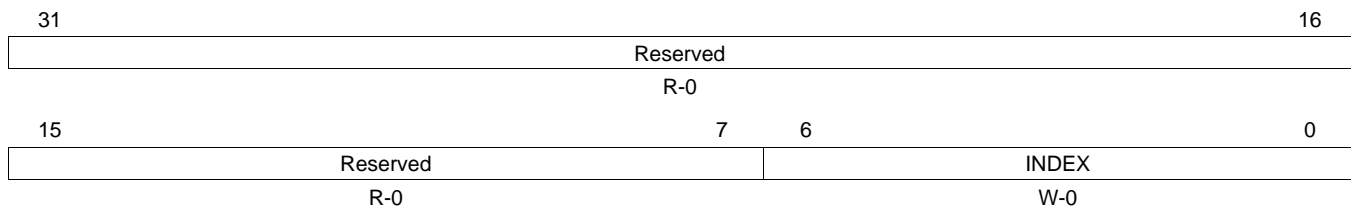

LEGEND: R = Read only; W = Write only; -n = value after reset

Table 11-9. System Interrupt Enable Indexed Set Register (EISR) Field Descriptions

Bit	Field	Value	Description
31-7	Reserved	0	Reserved
6-0	INDEX	0-7Fh	Writes set the enable of the interrupt given in the INDEX value. Reads return 0.

11.4.8 System Interrupt Enable Indexed Clear Register (EICR)

The system interrupt enable indexed clear register (EICR) allows disabling an interrupt. The interrupt to disable is the INDEX value written. This clears the Enable Register bit of the given INDEX. The EICR is shown in [Figure 11-10](#) and described in [Table 11-10](#).

Figure 11-10. System Interrupt Enable Indexed Clear Register (EICR)

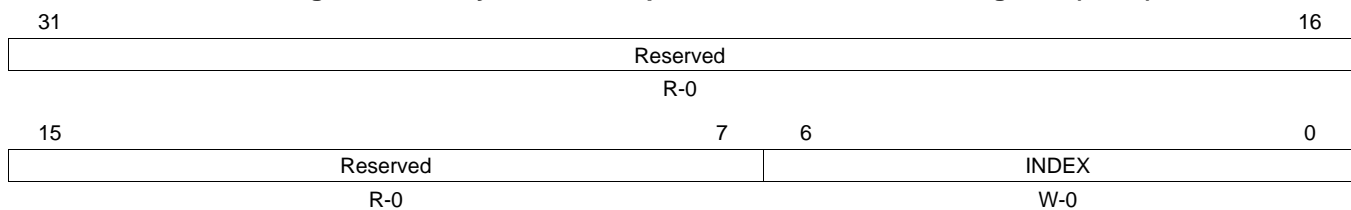

LEGEND: R = Read only; W = Write only; -n = value after reset

Table 11-10. System Interrupt Enable Indexed Clear Register (EICR) Field Descriptions

Bit	Field	Value	Description
31-7	Reserved	0	Reserved
6-0	INDEX	0-7Fh	Writes clear the enable of the interrupt given in the INDEX value. Reads return 0.

11.4.9 Host Interrupt Enable Indexed Set Register (HIEISR)

The host interrupt enable indexed set register (HIEISR) allows enabling a host interrupt output. The host interrupt to enable is the INDEX value written. This enables the host interrupt output or triggers the output again if already enabled. The HEISR is shown in Figure 11-11 and described in Table 11-11.

Figure 11-11. Host Interrupt Enable Indexed Set Register (HEISR)

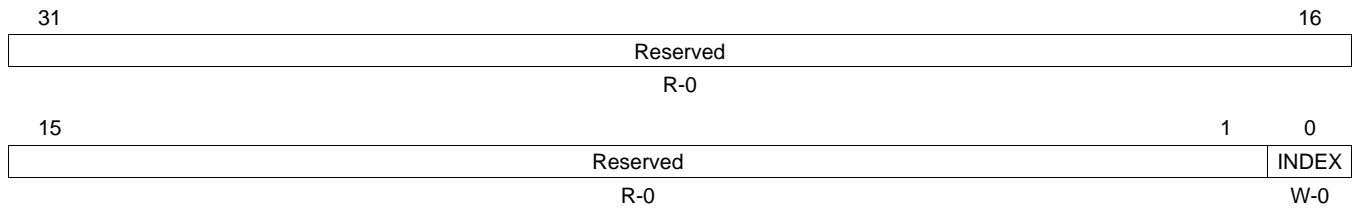

LEGEND: R = Read only; W = Write only; -n = value after reset

Table 11-11. Host Interrupt Enable Indexed Set Register (HIEISR) Field Descriptions

Bit	Field	Value	Description
31-1	Reserved	0	Reserved
0	INDEX	0	Writes set the enable of the host interrupt given in the INDEX value. Reads return 0.
		1	Writing a 0 sets FIQ. Writing a 1 sets IRQ.

11.4.10 Host Interrupt Enable Indexed Clear Register (HIEICR)

The host interrupt enable indexed clear register (HIEICR) allows disabling a host interrupt output. The host interrupt to disable is the INDEX value written. This disables the host interrupt output. The HIEICR is shown in Figure 11-12 and described in Table 11-12.

Figure 11-12. Host Interrupt Enable Indexed Clear Register (HIEICR)

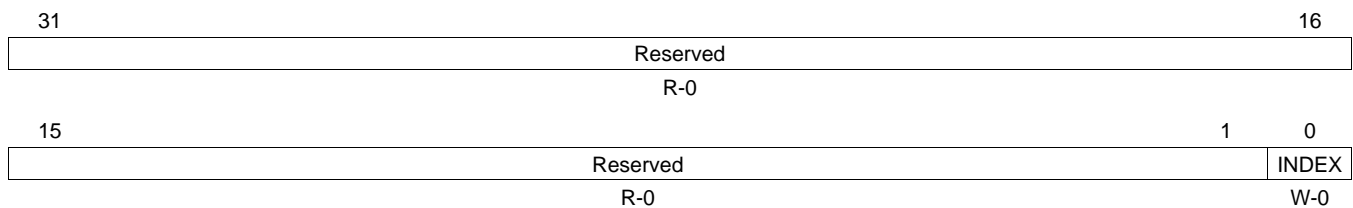

LEGEND: R = Read only; W = Write only; -n = value after reset

Table 11-12. Host Interrupt Enable Indexed Clear Register (HIEICR) Field Descriptions

Bit	Field	Value	Description
31-1	Reserved	0	Reserved
0	INDEX	0	Writes clear the enable of the host interrupt given in the INDEX value. Reads return 0.
		1	Writing a 0 clears FIQ. Writing a 1 clears IRQ.

11.4.11 Vector Base Register (VBR)

The vector base register (VBR) holds the base address of the ISR vector addresses. The VBR is shown in [Figure 11-13](#) and described in [Table 11-13](#).

Figure 11-13. Vector Base Register (VBR)

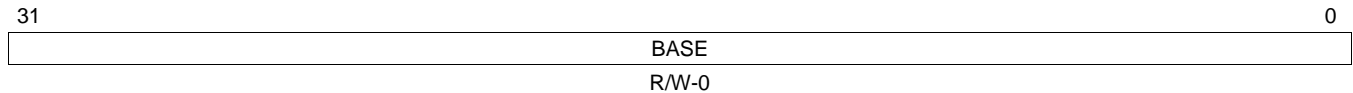

LEGEND: R/W = Read/Write; -n = value after reset

Table 11-13. Vector Base Register (VBR) Field Descriptions

Bit	Field	Value	Description
31-0	BASE	0-FFFF FFFFh	ISR Base Address.

11.4.12 Vector Size Register (VSR)

The vector size register (VSR) holds the sizes of the individual ISR routines in the vector table. This is only the sizes to space the calculated vector addresses for the initial ISR targets (the ISR targets could branch off to the full ISR routines). The VSR is shown in [Figure 11-14](#) and described in [Table 11-14](#).

NOTE: The VSR must be configured even if the desired value is equal to the default value.

Figure 11-14. Vector Size Register (VSR)

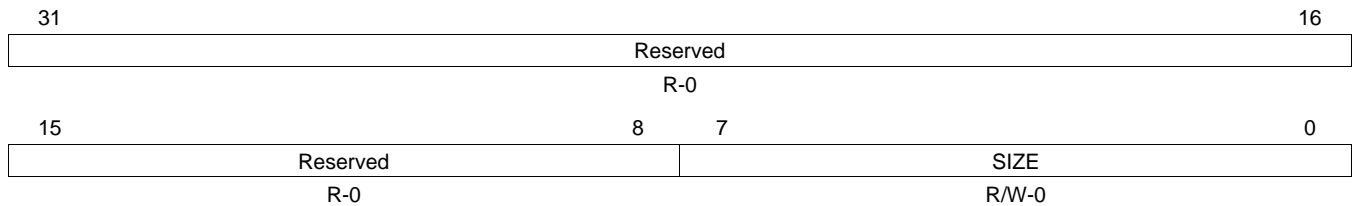

LEGEND: R/W = Read/Write; R = Read only; -n = value after reset

Table 11-14. Vector Size Register (VSR) Field Descriptions

Bit	Field	Value	Description
31-8	Reserved	0	Reserved
7-0	SIZE	0-FFh	Size of ISR address spaces.
		0	4 bytes
		1h	8 bytes
		2h	16 bytes
		3h	32 bytes
		4h	64 bytes
		5h-FFh	...

11.4.13 Vector Null Register (VNR)

The vector null register (VNR) holds the address of the ISR null address that handles no pending interrupts (if accidentally branched to when no interrupts are pending). The VNR is shown in [Figure 11-15](#) and described in [Table 11-15](#).

Figure 11-15. Vector Null Register (VNR)

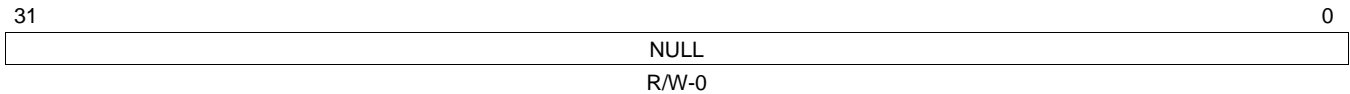

LEGEND: R/W = Read/Write; -n = value after reset

Table 11-15. Vector Null Register (VNR) Field Descriptions

Bit	Field	Value	Description
31-0	NULL	0-FFFF FFFFh	ISR Null Address.

11.4.14 Global Prioritized Index Register (GPIR)

The global prioritized index register (GPIR) shows the interrupt number of the highest priority interrupt pending across all the host interrupts. The GPIR is shown in [Figure 11-16](#) and described in [Table 11-16](#).

Figure 11-16. Global Prioritized Index Register (GPIR)

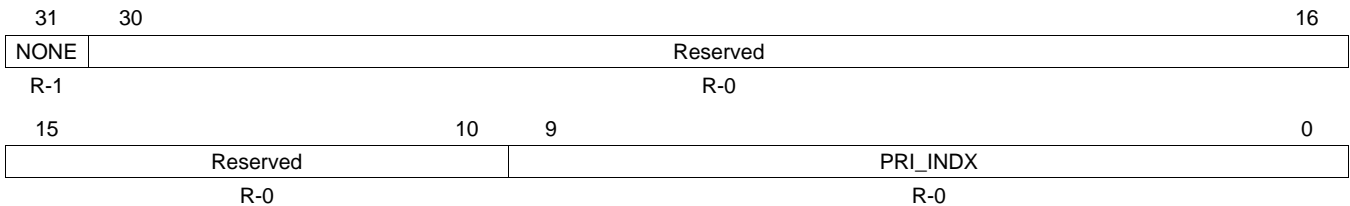

LEGEND: R = Read only; -n = value after reset

Table 11-16. Global Prioritized Index Register (GPIR) Field Descriptions

Bit	Field	Value	Description
31	NONE	0-1	No Interrupt is pending. Can be used by host to test for a negative value to see if no interrupts are pending.
30-10	Reserved	0	Reserved
9-0	PRI_IND	0-3FFh	The currently highest priority interrupt index pending across all the host interrupts.

11.4.15 Global Prioritized Vector Register (GPVR)

The global prioritized vector register (GPVR) shows the interrupt vector address of the highest priority interrupt pending across all the host interrupts. The GPVR is shown in [Figure 11-17](#) and described in [Table 11-17](#).

Figure 11-17. Global Prioritized Vector Register (GPVR)

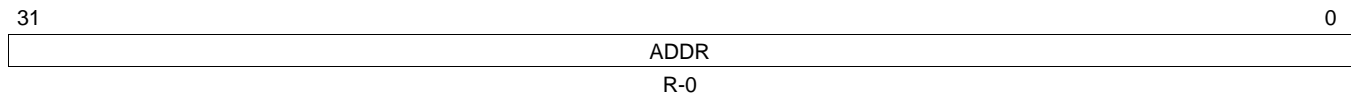

LEGEND: R = Read only; -n = value after reset

Table 11-17. Global Prioritized Vector Register (GPVR) Field Descriptions

Bit	Field	Value	Description
31-0	ADDR	0-FFFF FFFFh	The currently highest priority interrupts vector address across all the host interrupts.

11.4.16 System Interrupt Status Raw/Set Register 1 (SRSR1)

The system interrupt status raw/set register 1 (SRSR1) shows the pending enabled status of the system interrupts 0 to 31. Software can write to SRSR1 to set a system interrupt without a hardware trigger. There is one bit per system interrupt. The SRSR1 is shown in [Figure 11-18](#) and described in [Table 11-18](#).

Figure 11-18. System Interrupt Status Raw/Set Register 1 (SRSR1)

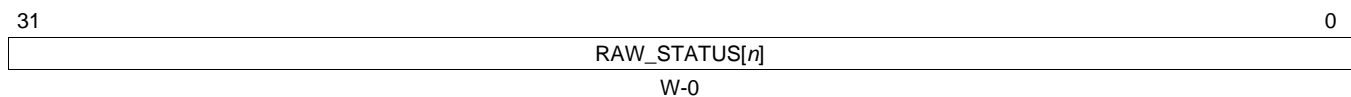

LEGEND: W = Write only; -n = value after reset

Table 11-18. System Interrupt Status Raw/Set Register 1 (SRSR1) Field Descriptions

Bit	Field	Value	Description
31-0	RAW_STATUS[n]		System interrupt raw status and setting of the system interrupts 0 to 31. Reads return the raw status.
		0	Writing a 0 has no effect.
		1	Write a 1 in bit position [n] to set the status of the system interrupt n.

11.4.17 System Interrupt Status Raw/Set Register 2 (SRSR2)

The system interrupt status raw/set register 2 (SRSR2) shows the pending enabled status of the system interrupts 32 to 63. Software can write to SRSR2 to set a system interrupt without a hardware trigger. There is one bit per system interrupt. The SRSR2 is shown in [Figure 11-19](#) and described in [Table 11-19](#).

Figure 11-19. System Interrupt Status Raw/Set Register 2 (SRSR2)

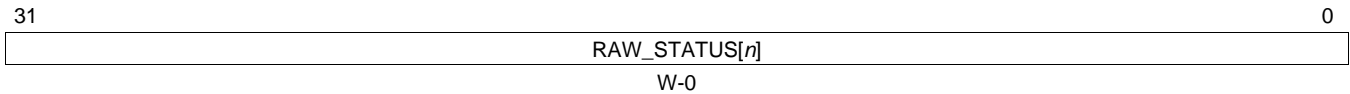

LEGEND: W = Write only; -n = value after reset

Table 11-19. System Interrupt Status Raw/Set Register 2 (SRSR2) Field Descriptions

Bit	Field	Value	Description
31-0	RAW_STATUS[n]		System interrupt raw status and setting of the system interrupts 32 to 63. Reads return the raw status.
		0	Writing a 0 has no effect.
		1	Write a 1 in bit position [n] to set the status of the system interrupt n + 32.

11.4.18 System Interrupt Status Raw/Set Register 3 (SRSR3)

The system interrupt status raw/set register 3 (SRSR3) shows the pending enabled status of the system interrupts 64 to 95. Software can write to SRSR3 to set a system interrupt without a hardware trigger. There is one bit per system interrupt. The SRSR3 is shown in [Figure 11-20](#) and described in [Table 11-20](#).

Figure 11-20. System Interrupt Status Raw/Set Register 3 (SRSR3)

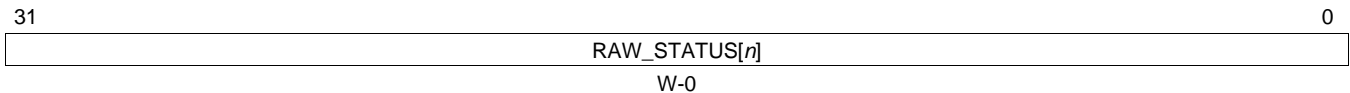

LEGEND: W = Write only; -n = value after reset

Table 11-20. System Interrupt Status Raw/Set Register 3 (SRSR3) Field Descriptions

Bit	Field	Value	Description
31-0	RAW_STATUS[n]		System interrupt raw status and setting of the system interrupts 64 to 95. Reads return the raw status.
		0	Writing a 0 has no effect.
		1	Write a 1 in bit position [n] to set the status of the system interrupt n + 64.

11.4.19 System Interrupt Status Raw/Set Register 4 (SRSR4)

The system interrupt status raw/set register 4 (SRSR4) shows the pending enabled status of the system interrupts 96 to 100. Software can write to SRSR4 to set a system interrupt without a hardware trigger. There is one bit per system interrupt. The SRSR4 is shown in [Figure 11-21](#) and described in [Table 11-21](#).

Figure 11-21. System Interrupt Status Raw/Set Register 4 (SRSR4)

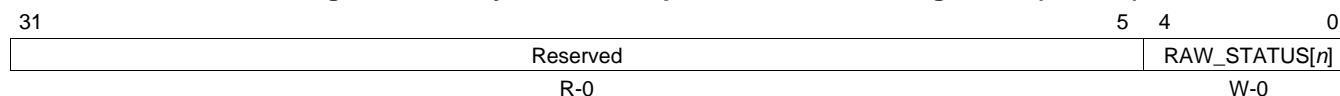

LEGEND: R = Read only; W = Write only; -n = value after reset

Table 11-21. System Interrupt Status Raw/Set Register 4 (SRSR4) Field Descriptions

Bit	Field	Value	Description
31-5	Reserved	0	Reserved
4-0	RAW_STATUS[n]	0	System interrupt raw status and setting of the system interrupts 96 to 100. Reads return the raw status. Writing a 0 has no effect.
		1	Write a 1 in bit position [n] to set the status of the system interrupt n + 96.

11.4.20 System Interrupt Status Enabled/Clear Register 1 (SECR1)

The system interrupt status enabled/clear register 1 (SECR1) shows the pending enabled status of the system interrupts 0 to 31. Software can write to SECR1 to clear a system interrupt after it has been serviced. If a system interrupt status is not cleared then another host interrupt may not be triggered or another host interrupt may be triggered incorrectly. There is one bit per system interrupt. The SECR1 is shown in [Figure 11-22](#) and described in [Table 11-22](#).

Figure 11-22. System Interrupt Status Enabled/Clear Register 1 (SECR1)

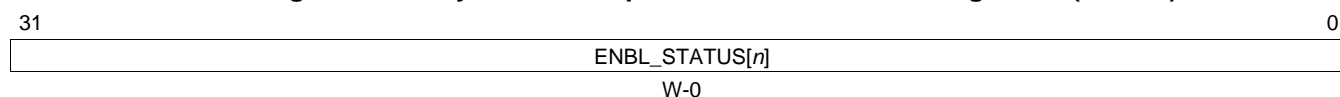

LEGEND: W = Write only; -n = value after reset

Table 11-22. System Interrupt Status Enabled/Clear Register 1 (SECR1) Field Descriptions

Bit	Field	Value	Description
31-0	ENBL_STATUS[n]		System interrupt enabled status and clearing of the system interrupts 0 to 31. Reads return the enabled status (before enabling with the Enable Registers).
		0	Writing a 0 has no effect.
		1	Write a 1 in bit position [n] to clear the status of the system interrupt n.

11.4.21 System Interrupt Status Enabled/Clear Register 2 (SECR2)

The system interrupt status enabled/clear register 2 (SECR2) shows the pending enabled status of the system interrupts 32 to 63. Software can write to SECR2 to clear a system interrupt after it has been serviced. If a system interrupt status is not cleared then another host interrupt may not be triggered or another host interrupt may be triggered incorrectly. There is one bit per system interrupt. The SECR2 is shown in [Figure 11-23](#) and described in [Table 11-23](#).

Figure 11-23. System Interrupt Status Enabled/Clear Register 2 (SECR2)

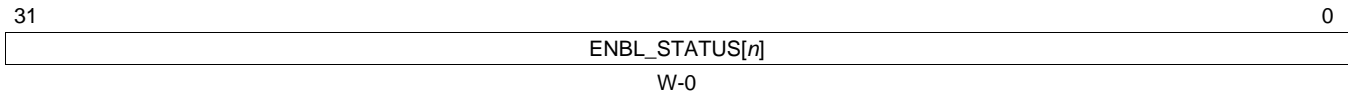

LEGEND: W = Write only; -n = value after reset

Table 11-23. System Interrupt Status Enabled/Clear Register 2 (SECR2) Field Descriptions

Bit	Field	Value	Description
31-0	ENBL_STATUS[n]		System interrupt enabled status and clearing of the system interrupts 32 to 63. Reads return the enabled status (before enabling with the Enable Registers).
		0	Writing a 0 has no effect.
		1	Write a 1 in bit position [n] to clear the status of the system interrupt n + 32.

11.4.22 System Interrupt Status Enabled/Clear Register 3 (SECR3)

The system interrupt status enabled/clear register 3 (SECR3) shows the pending enabled status of the system interrupts 64 to 95. Software can write to SECR3 to clear a system interrupt after it has been serviced. If a system interrupt status is not cleared then another host interrupt may not be triggered or another host interrupt may be triggered incorrectly. There is one bit per system interrupt. The SECR3 is shown in [Figure 11-24](#) and described in [Table 11-24](#).

Figure 11-24. System Interrupt Status Enabled/Clear Register 3 (SECR3)

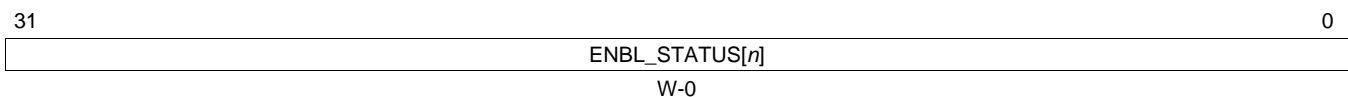

LEGEND: W = Write only; -n = value after reset

Table 11-24. System Interrupt Status Enabled/Clear Register 3 (SECR3) Field Descriptions

Bit	Field	Value	Description
31-0	ENBL_STATUS[n]		System interrupt enabled status and clearing of the system interrupts 64 to 95. Reads return the enabled status (before enabling with the Enable Registers).
		0	Writing a 0 has no effect.
		1	Write a 1 in bit position [n] to clear the status of the system interrupt n + 64.

11.4.23 System Interrupt Status Enabled/Clear Register 4 (SECR4)

The system interrupt status enabled/clear register 4 (SECR4) shows the pending enabled status of the system interrupts 96 to 100. Software can write to SECR4 to clear a system interrupt after it has been serviced. If a system interrupt status is not cleared then another host interrupt may not be triggered or another host interrupt may be triggered incorrectly. There is one bit per system interrupt. The SECR4 is shown in [Figure 11-25](#) and described in [Table 11-25](#).

Figure 11-25. System Interrupt Status Enabled/Clear Register 4 (SECR4)

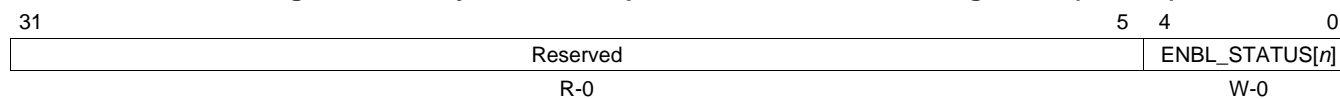

LEGEND: R = Read only; W = Write only; -n = value after reset

Table 11-25. System Interrupt Status Enabled/Clear Register 4 (SECR4) Field Descriptions

Bit	Field	Value	Description
31-5	Reserved	0	Reserved
4-0	ENBL_STATUS[n]	0	System interrupt enabled status and clearing of the system interrupts 96 to 100. Reads return the enabled status (before enabling with the Enable Registers).
		0	Writing a 0 has no effect.
		1	Write a 1 in bit position [n] to clear the status of the system interrupt n + 96.

11.4.24 System Interrupt Enable Set Register 1 (ESR1)

The system interrupt enable set register 1 (ESR1) enables system interrupts 0 to 31 to trigger outputs. System interrupts that are not enabled do not interrupt the host. There is one bit per system interrupt. The ESR1 is shown in [Figure 11-26](#) and described in [Table 11-26](#).

Figure 11-26. System Interrupt Enable Set Register 1 (ESR1)

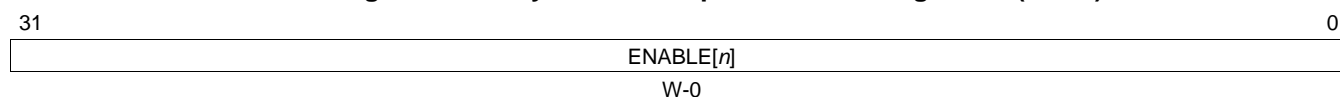

LEGEND: W = Write only; -n = value after reset

Table 11-26. System Interrupt Enable Set Register 1 (ESR1) Field Descriptions

Bit	Field	Value	Description
31-0	ENABLE[n]	0	System interrupt 0 to 31 enable. Read returns the enable value (0 = disabled, 1 = enabled).
		0	Writing a 0 has no effect.
		1	Write a 1 in bit position [n] to set the enable for system interrupt n.

11.4.25 System Interrupt Enable Set Register 2 (ESR2)

The system interrupt enable set register 2 (ESR2) enables system interrupts 32 to 63 to trigger outputs. System interrupts that are not enabled do not interrupt the host. There is one bit per system interrupt. The ESR2 is shown in [Figure 11-27](#) and described in [Table 11-27](#).

Figure 11-27. System Interrupt Enable Set Register 2 (ESR2)

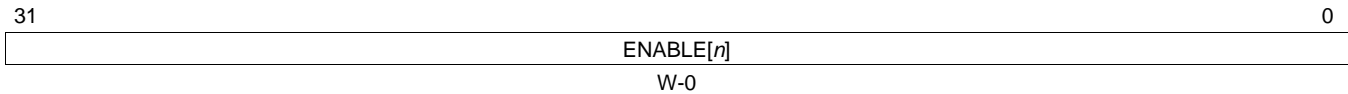

LEGEND: W = Write only; -n = value after reset

Table 11-27. System Interrupt Enable Set Register 2 (ESR2) Field Descriptions

Bit	Field	Value	Description
31-0	ENABLE[n]	0	System interrupt 32 to 63 enable. Read returns the enable value (0 = disabled, 1 = enabled). Writing a 0 has no effect.
		1	Write a 1 in bit position [n] to set the enable for system interrupt $n + 32$.

11.4.26 System Interrupt Enable Set Register 3 (ESR3)

The system interrupt enable set register 3 (ESR3) enables system interrupts 64 to 95 to trigger outputs. System interrupts that are not enabled do not interrupt the host. There is one bit per system interrupt. The ESR3 is shown in [Figure 11-28](#) and described in [Table 11-28](#).

Figure 11-28. System Interrupt Enable Set Register 3 (ESR3)

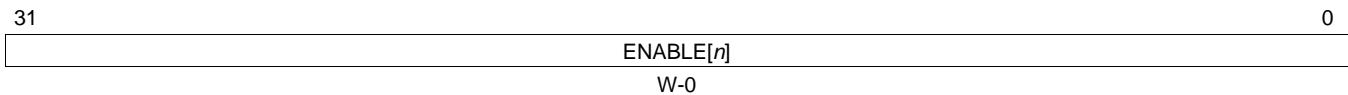

LEGEND: W = Write only; -n = value after reset

Table 11-28. System Interrupt Enable Set Register 3 (ESR3) Field Descriptions

Bit	Field	Value	Description
31-0	ENABLE[n]	0	System interrupt 64 to 95 enable. Read returns the enable value (0 = disabled, 1 = enabled). Writing a 0 has no effect.
		1	Write a 1 in bit position [n] to set the enable for system interrupt $n + 64$.

11.4.27 System Interrupt Enable Set Register 4 (ESR4)

The system interrupt enable set register 4 (ESR4) enables system interrupts 96 to 100 to trigger outputs. System interrupts that are not enabled do not interrupt the host. There is one bit per system interrupt. The ESR4 is shown in [Figure 11-29](#) and described in [Table 11-29](#).

Figure 11-29. System Interrupt Enable Set Register 4 (ESR4)

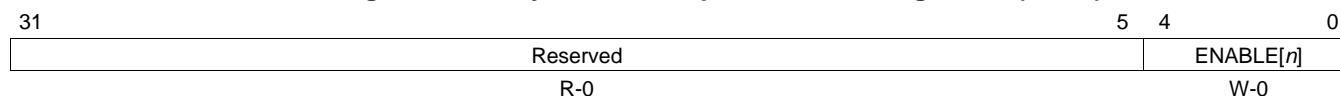

LEGEND: R = Read only; W = Write only; -n = value after reset

Table 11-29. System Interrupt Enable Set Register 4 (ESR4) Field Descriptions

Bit	Field	Value	Description
31-5	Reserved	0	Reserved
4-0	ENABLE[n]	0	System interrupt 96 to 100 enable. Read returns the enable value (0 = disabled, 1 = enabled). Writing a 0 has no effect.
		1	Write a 1 in bit position [n] to set the enable for system interrupt $n + 96$.

11.4.28 System Interrupt Enable Clear Register 1 (ECR1)

The system interrupt enable clear register 1 (ECR1) disables system interrupts 0 to 31 to map to channels. System interrupts that are not enabled do not interrupt the host. There is one bit per system interrupt. The ECR1 is shown in [Figure 11-30](#) and described in [Table 11-30](#).

Figure 11-30. System Interrupt Enable Clear Register 1 (ECR1)

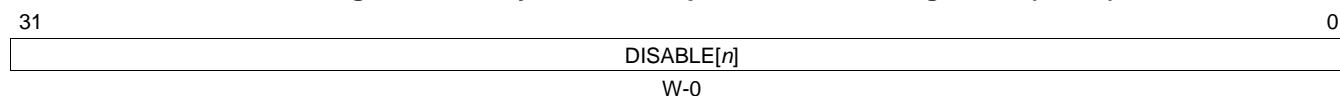

LEGEND: W = Write only; -n = value after reset

Table 11-30. System Interrupt Enable Clear Register 1 (ECR1) Field Descriptions

Bit	Field	Value	Description
31-0	DISABLE[n]	0	System interrupt 0 to 31 disable. Read returns the enable value (0 = disabled, 1 = enabled). Writing a 0 has no effect.
		1	Write a 1 in bit position [n] to clear the enable for system interrupt n .

11.4.29 System Interrupt Enable Clear Register 2 (ECR2)

The system interrupt enable clear register 2 (ECR2) disables system interrupts 32 to 63 to map to channels. System interrupts that are not enabled do not interrupt the host. There is one bit per system interrupt. The ECR2 is shown in [Figure 11-31](#) and described in [Table 11-31](#).

Figure 11-31. System Interrupt Enable Clear Register 2 (ECR2)

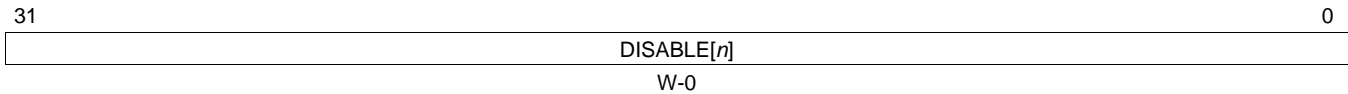

LEGEND: W = Write only; -n = value after reset

Table 11-31. System Interrupt Enable Clear Register 2 (ECR2) Field Descriptions

Bit	Field	Value	Description
31-0	DISABLE[n]	0	System interrupt 32 to 63 disable. Read returns the enable value (0 = disabled, 1 = enabled). Writing a 0 has no effect.
		1	Write a 1 in bit position [n] to clear the enable for system interrupt n + 32.

11.4.30 System Interrupt Enable Clear Register 3 (ECR3)

The system interrupt enable clear register 3 (ECR3) disables system interrupts 64 to 95 to map to channels. System interrupts that are not enabled do not interrupt the host. There is one bit per system interrupt. The ECR3 is shown in [Figure 11-32](#) and described in [Table 11-32](#).

Figure 11-32. System Interrupt Enable Clear Register 3 (ECR3)

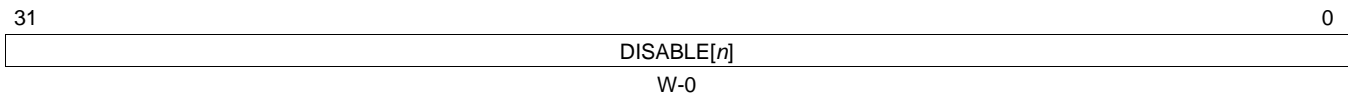

LEGEND: W = Write only; -n = value after reset

Table 11-32. System Interrupt Enable Clear Register 3 (ECR3) Field Descriptions

Bit	Field	Value	Description
27-0	DISABLE[n]	0	System interrupt 64 to 95 disable. Read returns the enable value (0 = disabled, 1 = enabled). Writing a 0 has no effect.
		1	Write a 1 in bit position [n] to clear the enable for system interrupt n + 64.

11.4.31 System Interrupt Enable Clear Register 4 (ECR4)

The system interrupt enable clear register 4 (ECR4) disables system interrupts 96 to 100 to map to channels. System interrupts that are not enabled do not interrupt the host. There is one bit per system interrupt. The ECR4 is shown in [Figure 11-33](#) and described in [Table 11-33](#).

Figure 11-33. System Interrupt Enable Clear Register 4 (ECR4)

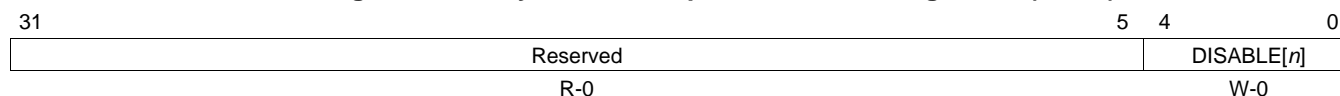

LEGEND: R = Read only; W = Write only; -n = value after reset

Table 11-33. System Interrupt Enable Clear Register 4 (ECR4) Field Descriptions

Bit	Field	Value	Description
31-5	Reserved	0	Reserved
4-0	DISABLE[n]	0	System interrupt 96 to 100 disable. Read returns the enable value (0 = disabled, 1 = enabled). Writing a 0 has no effect.
		1	Write a 1 in bit position [n] to clear the enable for system interrupt n + 96.

11.4.32 Channel Map Registers (CMR0-CMR25)

The channel map registers (CMR0-CMR25) define the channel for each system interrupt. There is one register per 4 system interrupts. The CMRn is shown in [Figure 11-34](#) and described in [Table 11-34](#).

Figure 11-34. Channel Map Registers (CMRn)

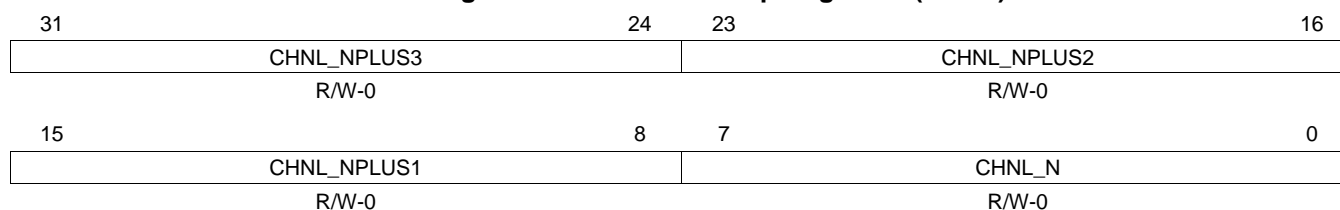

LEGEND: R/W = Read/Write; -n = value after reset

Table 11-34. Channel Map Registers (CMRn) Field Descriptions

Bit	Field	Value	Description
31-24	CHNL_NPLUS3	0-FFh	Sets the host interrupt for channel N + 3.
23-16	CHNL_NPLUS2	0-FFh	Sets the host interrupt for channel N + 2.
15-8	CHNL_NPLUS1	0-FFh	Sets the host interrupt for channel N + 1.
7-0	CHNL_N	0-FFh	Sets the channel for the system interrupt N. (N ranges from 0 to 100).

11.4.33 Host Interrupt Prioritized Index Register 1 (HIPIR1)

The host interrupt prioritized index register 1 (HIPIR1) shows the highest priority current pending interrupt for the FIQ interrupt. The HIPIR1 is shown in [Figure 11-35](#) and described in [Table 11-35](#).

Figure 11-35. Host Interrupt Prioritized Index Register 1 (HIPIR1)

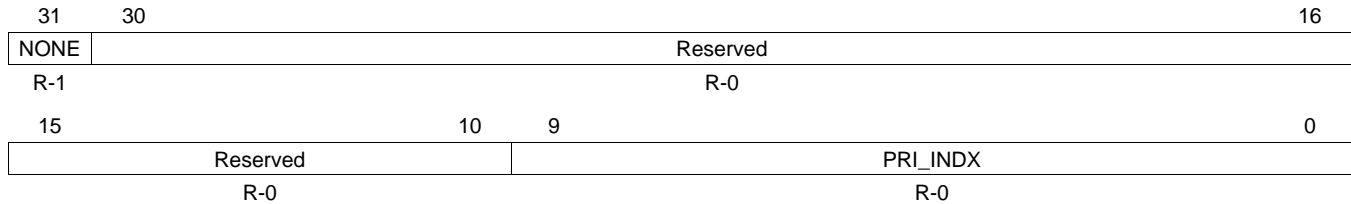

LEGEND: R = Read only; -n = value after reset

Table 11-35. Host Interrupt Prioritized Index Register 1 (HIPIR1) Field Descriptions

Bit	Field	Value	Description
31	NONE	0-1	No Interrupt is pending.
30-10	Reserved	0	Reserved
9-0	PRI_IND _X	0-3FFh	Interrupt number of the highest priority pending interrupt for FIQ host interrupt.

11.4.34 Host Interrupt Prioritized Index Register 2 (HIPIR2)

The host interrupt prioritized index register 2 (HIPIR2) shows the highest priority current pending interrupt for the IRQ interrupt. The HIPIR2 is shown in [Figure 11-36](#) and described in [Table 11-36](#).

Figure 11-36. Host Interrupt Prioritized Index Register 2 (HIPIR2)

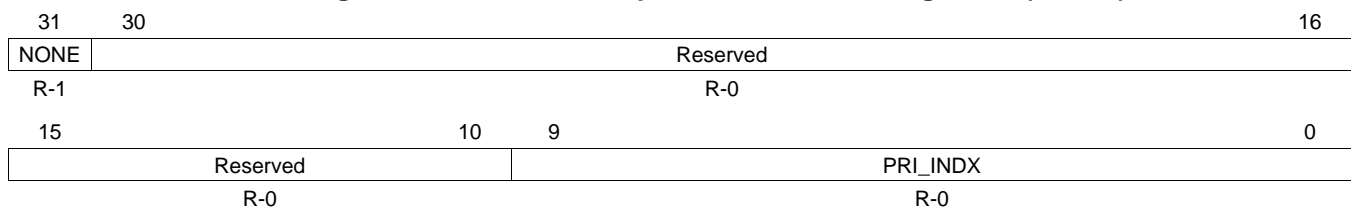

LEGEND: R = Read only; -n = value after reset

Table 11-36. Host Interrupt Prioritized Index Register 2 (HIPIR2) Field Descriptions

Bit	Field	Value	Description
31	NONE	0-1	No Interrupt is pending.
30-10	Reserved	0	Reserved
9-0	PRI_IND _X	0-3FFh	Interrupt number of the highest priority pending interrupt for IRQ host interrupt.

11.4.35 Host Interrupt Nesting Level Register 1 (HINLR1)

The host interrupt nesting level register 1 (HINLR1) displays and controls the nesting level for FIQ host interrupt. The nesting level controls which channel and lower priority channels are nested. The HINLR1 is shown in [Figure 11-37](#) and described in [Table 11-37](#).

Figure 11-37. Host Interrupt Nesting Level Register 1 (HINLR1)

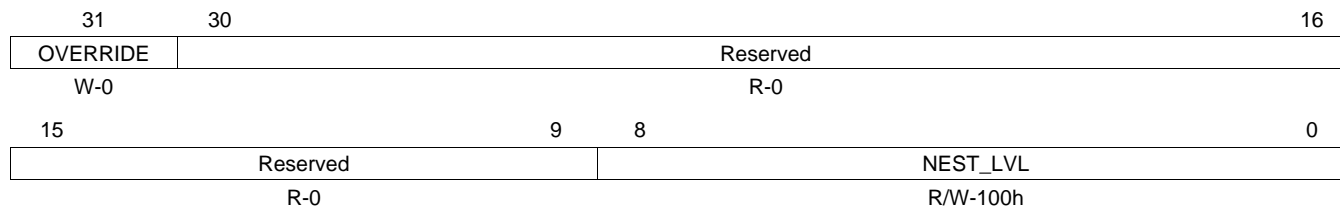

LEGEND: R/W = Read/Write; R = Read only; W = Write only; -n = value after reset

Table 11-37. Host Interrupt Nesting Level Register 1 (HINLR1) Field Descriptions

Bit	Field	Value	Description
31	OVERRIDE	0-1	Reads return 0. Writes of a 1 override the auto updating of the NEST_LVL and use the write data.
30-9	Reserved	0	Reserved
8-0	NEST_LVL	0-1FFh	Reads return the current nesting level for the FIQ host interrupt. Writes set the nesting level for the FIQ host interrupt. In auto mode the value is updated internally, unless the OVERRIDE is set and then the write data is used.

11.4.36 Host Interrupt Nesting Level Register 2 (HINLR2)

The host interrupt nesting level register 2 (HINLR2) displays and controls the nesting level for IRQ host interrupt. The nesting level controls which channel and lower priority channels are nested. The HINLR2 is shown in [Figure 11-38](#) and described in [Table 11-38](#).

Figure 11-38. Host Interrupt Nesting Level Register 2 (HINLR2)

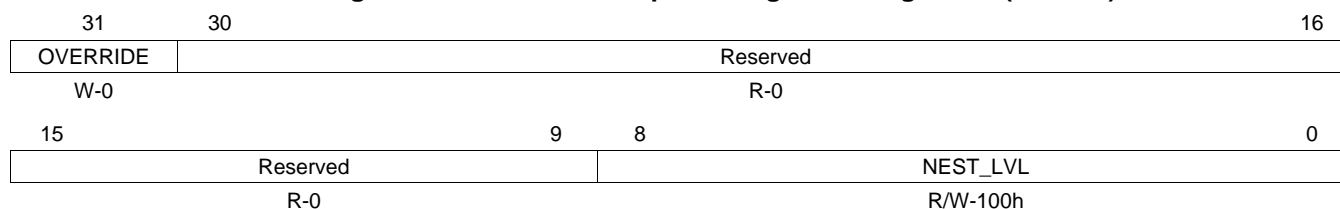

LEGEND: R/W = Read/Write; R = Read only; W = Write only; -n = value after reset

Table 11-38. Host Interrupt Nesting Level Register 2 (HINLR2) Field Descriptions

Bit	Field	Value	Description
31	OVERRIDE	0-1	Reads return 0. Writes of a 1 override the auto updating of the NEST_LVL and use the write data.
30-9	Reserved	0	Reserved
8-0	NEST_LVL	0-1FFh	Reads return the current nesting level for the IRQ host interrupt. Writes set the nesting level for the IRQ host interrupt. In auto mode the value is updated internally, unless the OVERRIDE is set and then the write data is used.

11.4.37 Host Interrupt Enable Register (HIER)

The host interrupt enable register (HIER) enables or disables individual host interrupts (FIQ and IRQ). These work separately from the global enables. There is one bit per host interrupt. These bits are updated when writing to the host interrupt enable indexed set register (HIEISR) and the host interrupt disable indexed clear register (HIDISR). The HIER is shown in [Figure 11-39](#) and described in [Table 11-39](#).

Figure 11-39. Host Interrupt Enable Register (HIER)

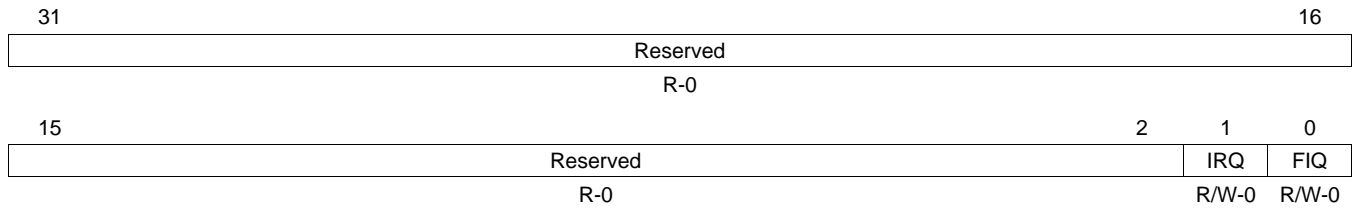

LEGEND: R/W = Read/Write; R = Read only; -n = value after reset

Table 11-39. Host Interrupt Enable Register (HIER) Field Descriptions

Bit	Field	Value	Description
31-2	Reserved	0	Reserved
1	IRQ	0	Enable of IRQ IRQ is disabled.
		1	IRQ is enabled.
0	FIQ	0	Enable of FIQ FIQ is disabled.
		1	FIQ is enabled.

11.4.38 Host Interrupt Prioritized Vector Register 1 (HIPVR1)

The host interrupt prioritized vector register 1 (HIPVR1) shows the interrupt vector address of the highest priority interrupt pending for FIQ host interrupt. The HIPVR1 is shown in [Figure 11-40](#) and described in [Table 11-40](#).

Figure 11-40. Host Interrupt Prioritized Vector Register 1 (HIPVR1)

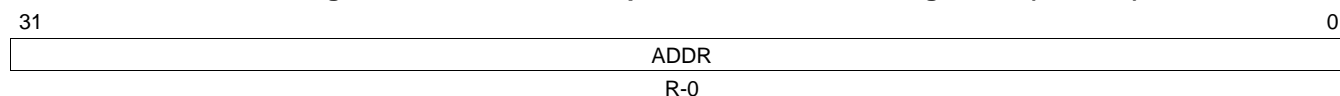

LEGEND: R = Read only; -n = value after reset

Table 11-40. Host Interrupt Prioritized Vector Register 1 (HIPVR1) Field Descriptions

Bit	Field	Value	Description
31-0	ADDR	0-FFFF FFFFh	The currently highest priority interrupt vector address across for the FIQ host interrupt.

11.4.39 Host Interrupt Prioritized Vector Register 2 (HIPVR2)

The host interrupt prioritized vector register 2 (HIPVR2) shows the interrupt vector address of the highest priority interrupt pending for IRQ host interrupt. The HIPVR2 is shown in [Figure 11-41](#) and described in [Table 11-41](#).

Figure 11-41. Host Interrupt Prioritized Vector Register 2 (HIPVR2)

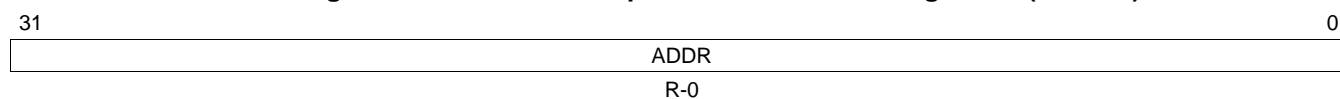

LEGEND: R = Read only; -n = value after reset

Table 11-41. Host Interrupt Prioritized Vector Register 2 (HIPVR2) Field Descriptions

Bit	Field	Value	Description
31-0	ADDR	0-FFFF FFFFh	The currently highest priority interrupt vector address across for the IRQ host interrupt.

Boot Considerations

Topic	Page
12.1 Introduction	252

12.1 Introduction

This device supports a variety of boot modes through an internal ARM ROM bootloader. This device does not support dedicated hardware boot modes; therefore, all boot modes utilize the internal ARM ROM. The input states of the BOOT pins are sampled and latched into the BOOTCFG register, which is part of the system configuration (SYSCFG) module, when device reset is deasserted. Boot mode selection is determined by the values of the BOOT pins.

The following boot modes are supported:

- NAND Flash boot
 - 8-bit NAND
 - 16-bit NAND
- NOR Flash boot
 - NOR Direct boot (8-bit or 16-bit)
 - NOR Legacy boot (8-bit or 16-bit)
 - NOR AIS boot (8-bit or 16-bit)
- HPI Boot
- I2C0/I2C1 Boot
 - EEPROM (Master Mode)
 - External Host (Slave Mode)
- SPI0/SPI1 Boot
 - Serial Flash (Master Mode)
 - Serial EEPROM (Master Mode)
 - External Host (Slave Mode)
- UART0/1/2 Boot
 - External Host

See *Using the AM18xx Bootloader Application Report* ([SPRABA5](#)) for more details on the ROM Boot Loader, a list of boot pins used, and the complete list of supported boot modes.

Revision History

Table A-1 lists the changes made since the previous version of this document.

Table A-1. Document Revision History

Reference	Additions/Modifications/Deletions
Table 7-2	Added PLLC0 Reset Control Register.
Table 7-3	Added PLLC1 Clock Enable Control Register. Added PLLC1 Clock Status Register.
Section 7.3.4	Added subsection. Subsequent subsections, figures, and tables renumbered.
Table 7-25	Changed Description of OD1EN bit, value = 1.
Section 7.3.31	Added subsection.
Section 7.3.33	Added subsection. Subsequent subsections, figures, and tables renumbered.
Section 8.2	Added NOTE.
Section 10.2.2	Changed NOTE.
Section 10.4.9	Added Type column to all tables.
Table 11-1	Changed Interrupt Name and Source of Events 74-89.
Section 11.3.2	Changed step 3(b).
Section 11.3.4	Changed second paragraph.
Section 11.3.6	Changed second sentence of level 2 in first paragraph.
Table 11-34	Changed Description of CHNL_N bit.
Section 12.1	Changed first bullet.

IMPORTANT NOTICE

Texas Instruments Incorporated and its subsidiaries (TI) reserve the right to make corrections, modifications, enhancements, improvements, and other changes to its products and services at any time and to discontinue any product or service without notice. Customers should obtain the latest relevant information before placing orders and should verify that such information is current and complete. All products are sold subject to TI's terms and conditions of sale supplied at the time of order acknowledgment.

TI warrants performance of its hardware products to the specifications applicable at the time of sale in accordance with TI's standard warranty. Testing and other quality control techniques are used to the extent TI deems necessary to support this warranty. Except where mandated by government requirements, testing of all parameters of each product is not necessarily performed.

TI assumes no liability for applications assistance or customer product design. Customers are responsible for their products and applications using TI components. To minimize the risks associated with customer products and applications, customers should provide adequate design and operating safeguards.

TI does not warrant or represent that any license, either express or implied, is granted under any TI patent right, copyright, mask work right, or other TI intellectual property right relating to any combination, machine, or process in which TI products or services are used. Information published by TI regarding third-party products or services does not constitute a license from TI to use such products or services or a warranty or endorsement thereof. Use of such information may require a license from a third party under the patents or other intellectual property of the third party, or a license from TI under the patents or other intellectual property of TI.

Reproduction of TI information in TI data books or data sheets is permissible only if reproduction is without alteration and is accompanied by all associated warranties, conditions, limitations, and notices. Reproduction of this information with alteration is an unfair and deceptive business practice. TI is not responsible or liable for such altered documentation. Information of third parties may be subject to additional restrictions.

Resale of TI products or services with statements different from or beyond the parameters stated by TI for that product or service voids all express and any implied warranties for the associated TI product or service and is an unfair and deceptive business practice. TI is not responsible or liable for any such statements.

TI products are not authorized for use in safety-critical applications (such as life support) where a failure of the TI product would reasonably be expected to cause severe personal injury or death, unless officers of the parties have executed an agreement specifically governing such use. Buyers represent that they have all necessary expertise in the safety and regulatory ramifications of their applications, and acknowledge and agree that they are solely responsible for all legal, regulatory and safety-related requirements concerning their products and any use of TI products in such safety-critical applications, notwithstanding any applications-related information or support that may be provided by TI. Further, Buyers must fully indemnify TI and its representatives against any damages arising out of the use of TI products in such safety-critical applications.

TI products are neither designed nor intended for use in military/aerospace applications or environments unless the TI products are specifically designated by TI as military-grade or "enhanced plastic." Only products designated by TI as military-grade meet military specifications. Buyers acknowledge and agree that any such use of TI products which TI has not designated as military-grade is solely at the Buyer's risk, and that they are solely responsible for compliance with all legal and regulatory requirements in connection with such use.

TI products are neither designed nor intended for use in automotive applications or environments unless the specific TI products are designated by TI as compliant with ISO/TS 16949 requirements. Buyers acknowledge and agree that, if they use any non-designated products in automotive applications, TI will not be responsible for any failure to meet such requirements.

Following are URLs where you can obtain information on other Texas Instruments products and application solutions:

Products

Audio	www.ti.com/audio
Amplifiers	amplifier.ti.com
Data Converters	dataconverter.ti.com
DLP® Products	www.dlp.com
DSP	dsp.ti.com
Clocks and Timers	www.ti.com/clocks
Interface	interface.ti.com
Logic	logic.ti.com
Power Mgmt	power.ti.com
Microcontrollers	microcontroller.ti.com
RFID	www.ti-rfid.com
RF/IF and ZigBee® Solutions	www.ti.com/lprf

Applications

Communications and Telecom	www.ti.com/communications
Computers and Peripherals	www.ti.com/computers
Consumer Electronics	www.ti.com/consumer-apps
Energy and Lighting	www.ti.com/energy
Industrial	www.ti.com/industrial
Medical	www.ti.com/medical
Security	www.ti.com/security
Space, Avionics and Defense	www.ti.com/space-avionics-defense
Transportation and Automotive	www.ti.com/automotive
Video and Imaging	www.ti.com/video
Wireless	www.ti.com/wireless-apps

TI E2E Community Home Page

e2e.ti.com

Mailing Address: Texas Instruments, Post Office Box 655303, Dallas, Texas 75265
Copyright © 2011, Texas Instruments Incorporated