

KeyStone Architecture TIMER64P

User Guide



Literature Number: SPRUGV5A
March 2012

Release History

| Release | Date | Chapter/Topic | Description/Comments |
|----------|-------------|-------------------|--|
| SPRUGV5A | March 2012 | "Introduction" | Updated section 1.2 "Timer Plus Mode" on page 1-4 |
| | | "Timer Modes" | Updated section 2.3 "Counter, Reload and Period Registers Used in GP Timer Modes" on page 2-7 Added section 2.4 "Timer Plus Modes" on page 2-8 |
| | | "Timer Operation" | Updated section 3.2 "Timer Enabling" on page 3-2 Updated section 3.5 "Timer Counting" on page 3-5 Updated section 3.7 "Timer Interrupt Rate" on page 3-5 Updated section 3.9.2 "Timer Count = 0 and Timer Period = 0 (No Prescaler)" on page 3-7 Updated section 3.10 "Initializing the Timer" on page 3-9 |
| | | "Registers" | Updated section 5.1 "Timer Registers" on page 5-2 Updated Figure 5-4 on page 5-4 Updated Table 5-5 on page 5-5 Updated Figure 5-7 on page 5-8 Updated Table 5-6 on page 5-8 Added section 5.8 "Timer Reload Registers (RELHI and RELLO)" on page 5-10 Added section 5.9 "Timer Capture Registers (CAPHI and CAPLO)" on page 5-11 Added section 5.10 "Timer Interrupt Control and Status Register (INTCTLSTAT)" on page 5-12 |
| SPRUGV5 | August 2011 | All | Initial Release |

Contents

| | |
|--|-------|
| <i>Release History</i> | ø-ii |
| <i>List of Tables</i> | ø-v |
| <i>List of Figures</i> | ø-vi |
| <hr/> | |
| <i>Preface</i> | ø-vii |
| <hr/> | |
| Chapter 1 | |
| <hr/> | |
| <i>Introduction</i> | 1-1 |
| 1.1 Introduction to the Timer | 1-2 |
| 1.2 Timer Plus Mode | 1-4 |
| <hr/> | |
| Chapter 2 | |
| <hr/> | |
| <i>Timer Modes</i> | 2-1 |
| 2.1 64-Bit Timer Mode | 2-2 |
| 2.2 Dual 32-bit Timer Mode | 2-3 |
| 2.2.1 Chained Mode | 2-3 |
| 2.2.2 Unchained Mode | 2-5 |
| 2.2.2.1 32-Bit Timer With a 4-Bit Prescaler (TIMHI) | 2-5 |
| 2.2.2.2 32-Bit Timer (TIMLO) | 2-6 |
| 2.3 Counter, Reload and Period Registers Used in GP Timer Modes | 2-7 |
| 2.4 Timer Plus Modes | 2-8 |
| 2.4.1 Timer Capture Registers | 2-8 |
| 2.4.2 Event Capture Mode | 2-8 |
| 2.4.3 Timer Counter Register Read Reset Mode | 2-8 |
| <hr/> | |
| Chapter 3 | |
| <hr/> | |
| <i>Timer Operation</i> | 3-1 |
| 3.1 Timer Mode Selection | 3-2 |
| 3.2 Timer Enabling | 3-2 |
| 3.3 Timer Clock Source Selection | 3-4 |
| 3.4 Timer Output Mode Selection | 3-4 |
| 3.5 Timer Counting | 3-5 |
| 3.6 Timer Reset Sources | 3-5 |
| 3.7 Timer Interrupt Rate | 3-5 |
| 3.8 Timer Emulation Modes | 3-6 |
| 3.9 Timer Operation Boundary Conditions | 3-6 |
| 3.9.1 Writing to and Reading From the Reserved Registers | 3-6 |
| 3.9.2 Timer Count = 0 and Timer Period = 0 (No Prescaler) | 3-7 |
| 3.9.3 Timer Count = 0, Timer Period = 0, Prescale Count = 0, and Prescale Period = 0 | 3-7 |
| 3.9.4 Timer Counter Overflow | 3-8 |
| 3.9.5 Writing to Registers of an Active Timer | 3-8 |
| 3.9.6 Small Timer Period Value in Pulse Mode | 3-8 |
| 3.9.7 Reading the Counter Registers | 3-8 |
| 3.10 Initializing the Timer | 3-9 |
| <hr/> | |
| Chapter 4 | |
| <hr/> | |
| <i>Watchdog Timer Mode</i> | 4-1 |
| 4.1 Timer Output Signal and Timer Interrupt Signal in Watchdog Mode | 4-2 |

| | |
|---|-----|
| 4.2 Watchdog Timer Mode Restrictions..... | 4-2 |
| 4.3 Watchdog Timer Mode Operation..... | 4-2 |
| 4.4 Watchdog Timer Register Write Protection..... | 4-5 |

Chapter 5

| | |
|--|------|
| <i>Registers</i> | 5-1 |
| 5.1 Timer Registers..... | 5-2 |
| 5.2 Emulation Management and Clock Speed Register (EMUMGT_CLKSPD)..... | 5-2 |
| 5.3 Timer Counter Registers (CNTHI and CNTLO)..... | 5-3 |
| 5.4 Timer Period Registers (PRDHI and PRDLO)..... | 5-4 |
| 5.5 Timer Control Register (TCR)..... | 5-5 |
| 5.6 Timer Global Control Register (TGCR)..... | 5-8 |
| 5.7 Watchdog Timer Control Register (WDTCR)..... | 5-9 |
| 5.8 Timer Reload Registers (RELHI and RELLO)..... | 5-10 |
| 5.9 Timer Capture Registers (CAPHI and CAPLO)..... | 5-11 |
| 5.10 Timer Interrupt Control and Status Register (INTCTLSTAT)..... | 5-12 |

List of Tables

| | | |
|------------|---|------|
| Table 2-1 | Counter and Period Registers Used in GP Timer Modes | 2-7 |
| Table 3-1 | Timer Mode Selection | 3-2 |
| Table 3-2 | Timer Enabling | 3-2 |
| Table 3-3 | Timer Clock Source Selection | 3-4 |
| Table 3-4 | Timer Emulation Modes Selection..... | 3-6 |
| Table 3-5 | Timer Operation When Timer Count = 0 and Timer Period = 0..... | 3-7 |
| Table 3-6 | Reading Counter Registers..... | 3-8 |
| Table 5-1 | Timer Registers..... | 5-2 |
| Table 5-2 | Emulation Management and Clock Speed Register Bit Descriptions | 5-3 |
| Table 5-3 | Timer Counter Registers (CNTHI and CNTLO) Field Descriptions | 5-4 |
| Table 5-4 | Timer Period Registers (PRDHI and PRDLO) Field Descriptions..... | 5-4 |
| Table 5-5 | Timer Control Register (TCR) Field Descriptions..... | 5-5 |
| Table 5-6 | Timer Global Control Register (TGCR) Field Descriptions | 5-8 |
| Table 5-7 | Watchdog Timer Control Register (WDTCR) Field Descriptions | 5-9 |
| Table 5-8 | Timer Reload Registers (RELHI and RELLO) Field Descriptions | 5-10 |
| Table 5-9 | Timer Capture Registers (CAPHI and CAPLO) Field Descriptions | 5-11 |
| Table 5-10 | Timer Interrupt Control and Status Register (INTCTLSTAT) Field Descriptions | 5-12 |

List of Figures

| | | |
|-------------|---|------|
| Figure 1-1 | Timer Block Diagram | 1-2 |
| Figure 1-2 | Generation of the Internal Timer Clock | 1-3 |
| Figure 2-1 | 64-Bit Timer Mode Block Diagram | 2-2 |
| Figure 2-2 | Dual 32-Bit Timers Chained Mode Block Diagram | 2-3 |
| Figure 2-3 | Dual 32-Bit Timers Chained Mode Example | 2-4 |
| Figure 2-4 | Dual 32-Bit Timers Unchained Mode Block Diagram | 2-5 |
| Figure 2-5 | Dual 32-Bit Timers Unchained Mode Example | 2-6 |
| Figure 3-1 | Timer Clock Source Block Diagram | 3-4 |
| Figure 3-2 | 32-Bit Timer Counter Overflow Example | 3-8 |
| Figure 3-3 | Timer Initialization. | 3-9 |
| Figure 4-1 | Timer in Watchdog Timer Mode. | 4-3 |
| Figure 4-2 | Watchdog Timer Operation State Diagram | 4-4 |
| Figure 5-1 | Emulation Management and Clock Speed Register (EMUMGT_CLKSPD) | 5-2 |
| Figure 5-2 | 64-Bit Timer Counter Register (CNTHI and CNTLO) | 5-3 |
| Figure 5-3 | 32-bit Timer Counter Registers - CNTHI and CNTLO | 5-4 |
| Figure 5-4 | 64-Bit Timer Period Register (PRDHI and PRDLO) | 5-4 |
| Figure 5-5 | 32-bit Timer Period Registers - PRDHI and PRDLO | 5-4 |
| Figure 5-6 | Timer Control Register (TCR) | 5-5 |
| Figure 5-7 | Timer Global Control Register (TGCR) | 5-8 |
| Figure 5-8 | Watchdog Timer Control Register (WDTCR) | 5-9 |
| Figure 5-9 | 64-Bit Timer Reload Register (RELHI and RELLO) | 5-10 |
| Figure 5-10 | 32-bit Timer Reload Registers -RELHI and RELLO | 5-10 |
| Figure 5-11 | 64-Bit Timer Capture Register (CAPHI and CAPLO) | 5-11 |
| Figure 5-12 | 32-bit Timer Capture Registers - CAPHI and CAPLO | 5-11 |
| Figure 5-13 | Timer Interrupt Control and Status Register (INTCTLSTAT) | 5-12 |



Preface

About This Manual

This document provides an overview of the 64-bit timer in the KeyStone Architecture devices. The timer can be configured as a general-purpose 64-bit timer, dual general-purpose 32-bit timers, or a watchdog timer. When configured as dual 32-bit timers, each half can operate in conjunction (chain mode) or independently (unchained mode) of each other.

Notational Conventions

This document uses the following conventions.

- Hexadecimal numbers are shown with the suffix h. For example, the following number is 40 hexadecimal (decimal 64): 40h.
- Registers in this document are shown in figures and described in tables.
 - Each register figure shows a rectangle divided into fields that represent the fields of the register. Each field is labeled with its bit name, its beginning and ending bit numbers above, and its read/write properties below. A legend explains the notation used for the properties.
 - Reserved bits in a register figure designate a bit that is used for future device expansion.

Related Documentation From Texas Instruments

The following documents describe the C66x devices and related support tools. Copies of these documents are available on the Internet.

[C66x CorePac User Guide](#)

SPRUGW0

[C66x CPU and Instruction Set Reference Guide](#)

SPRUGH7

Introduction

IMPORTANT NOTE—The information in this document should be used in conjunction with information in the device-specific Keystone Architecture data manual that applies to the part number of your device.

- 1.1 ["Introduction to the Timer"](#) on page 1-2
- 1.2 ["Timer Plus Mode"](#) on page 1-4

1.1 Introduction to the Timer

The timer can be configured in one of three modes using the timer mode (TIMMODE) bits in the timer global control register (TGCR):

- 64-bit general-purpose (GP) timer
- dual 32-bit timers (TIMLO and TIMHI)
- watchdog timer.

When configured as dual 32-bit timers, each half can operate dependently (chain mode) or independently of each other (unchained mode).

At reset, the timer is configured as a 64-bit GP timer. The watchdog timer function can be enabled, if desired, via the TIMMODE bits in timer global control register (TGCR) and WDEN bit in the watchdog timer control register (WDTCR). Once the timer is configured as a watchdog timer, it cannot be re-configured as a regular timer until a device reset occurs.

The timer has one input pin (TINPL) and one output pin (TOUTL). The timer control register (TCR) controls the function of the input and output pin.

Figure 1-1 shows a high-level block diagram of the timer circuitry.

Figure 1-1 Timer Block Diagram

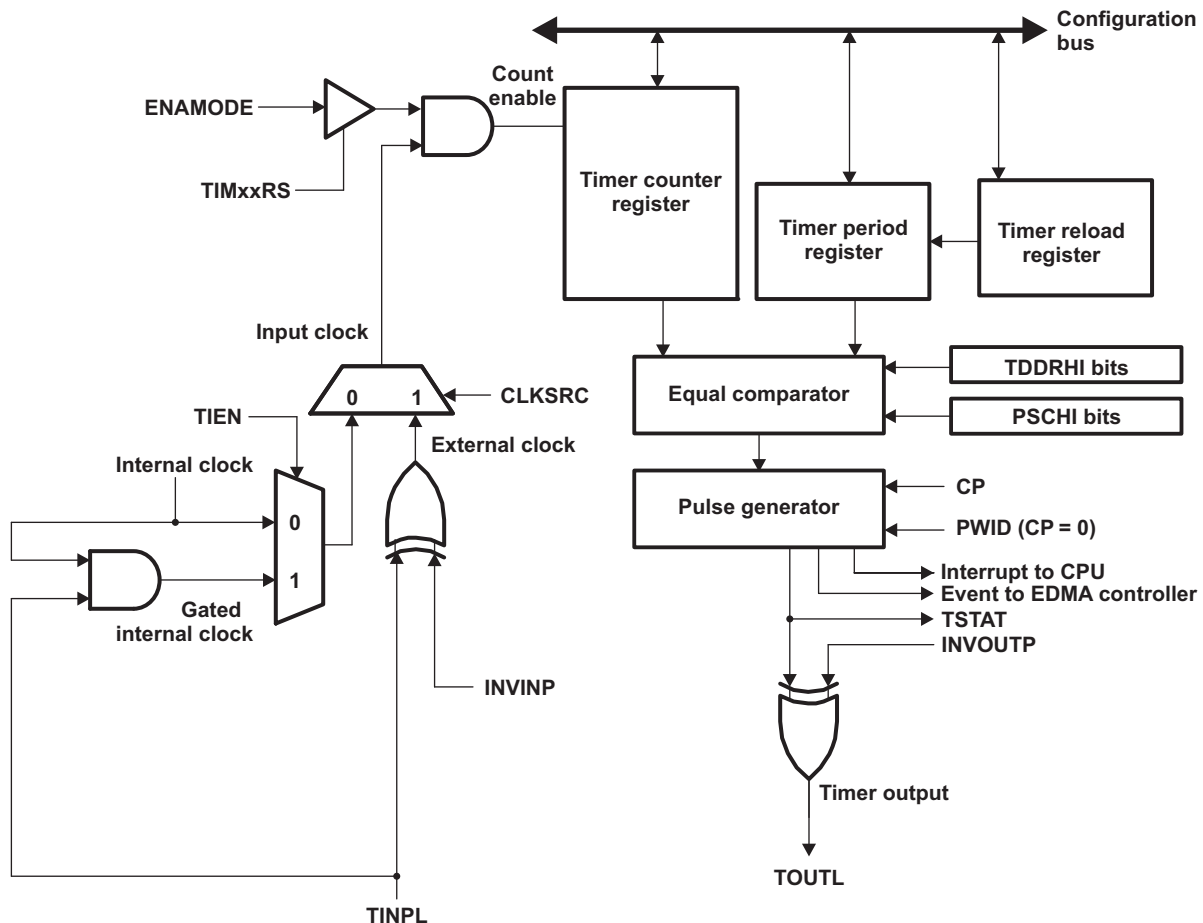

The timer can be driven by an external clock at the timer input pin (TINPL) or by the divide-down clock rate of the internal clock, as shown in [Figure 1-2](#). The internal clock is generated by the PLL1 controller and is a divided-down version of the CPU clock. For more information, see the device-specific data manual.

Figure 1-2 Generation of the Internal Timer Clock

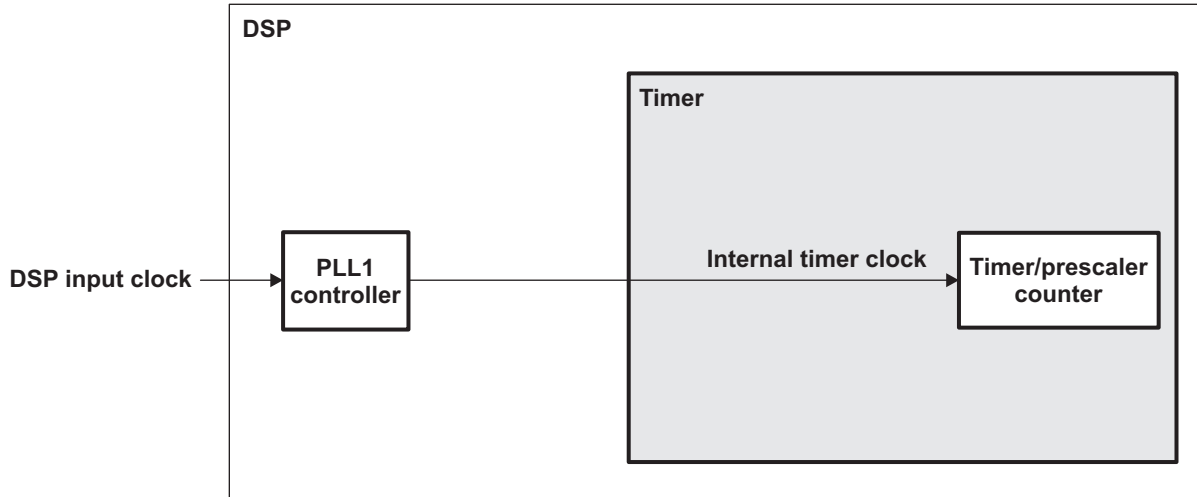

Some Timer Plus (TIMER64P) implementation has designed in the KeyStone timer. New features over previous timers include: period reload, external event capture and timer counter register read reset.

1.2 Timer Plus Mode

The Timer Plus supports the following additional features over the other timers:

- Period reload
- External event capture mode
- Timer counter register read reset mode
- Register for interrupt/DMA generation control and status

By default, period reload, external event capture mode, timer counter register read reset mode, timer counter capture registers, and interrupt/DMA/TOUTL generation control and status are not available.

To enable these features, you must set the PLUSEN bit in the timer global control register (TGCR). These features are described throughout the following sections. External clock/event input is always available, regardless of the state of the backward compatible bit.

Timer Modes

- 2.1 ["64-Bit Timer Mode"](#) on page 2-2
- 2.2 ["Dual 32-bit Timer Mode"](#) on page 2-3
- 2.3 ["Counter, Reload and Period Registers Used in GP Timer Modes"](#) on page 2-7
- 2.4 ["Timer Plus Modes"](#) on page 2-8

2.1 64-Bit Timer Mode

The timer can be configured as a 64-bit general-purpose (GP) timer, using the TIMMODE bits in the TGCRCR register. At reset, the timer is in 64-bit GP timer mode.

In this mode, the timer operates as a 64-bit up-counter, as shown in Figure 2-1. The counter registers (CNTLO, CNTHI) and the period registers (PRDLO, PRDHI) form a 64-bit timer counter register and a 64-bit timer period register, respectively. When the timer is enabled (see Section 3-2), the timer counter starts incrementing by 1 at every timer input clock cycle. When the timer counter matches the timer period, it generates a maskable timer interrupt (TINTLO), a timer event (TEVTLO), and an output signal on the timer output pin, TOUTL.

When in pulse mode (CP_LO = 0), the timer output pin (TOUTL) asserts a pulse that is 1, 2, 3, or 4 timer clock cycles wide, depending on the setting of the pulse width (PWID_LO) bits in timer control register TCR. When the timer is configured in continuous mode, the timer counter is reset to 0 on the cycle after the timer counter reaches the timer period. When the timer counter matches the timer period, the period registers will be loaded with the values in the reload registers (RELO, RELHI) if ENAMOD_LO=11b. The timer can be stopped, restarted, reset, or disabled using the bits of the timer control register.

Figure 2-1 64-Bit Timer Mode Block Diagram

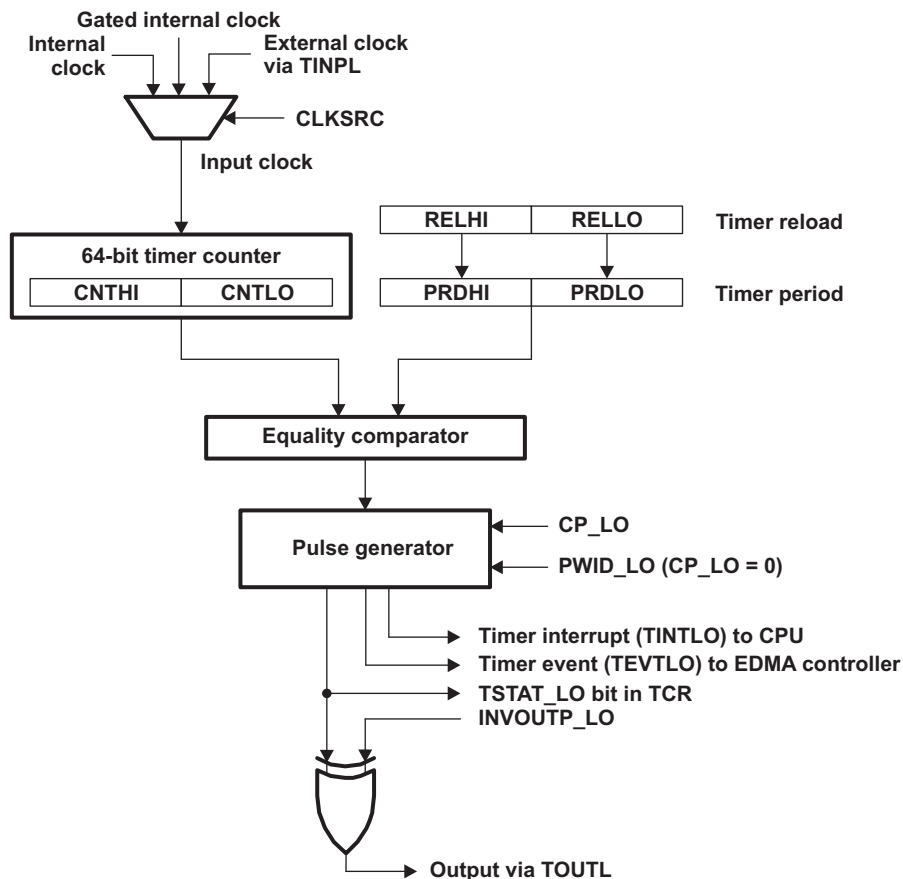

2.2 Dual 32-bit Timer Mode

The timer can be broken down into two 32-bit timers, using the TIMMODE bits in TGCR. In this mode, the two 32-bit timers can be operated in conjunction with each other (chained mode) or independently.

2.2.1 Chained Mode

In the chained mode, shown in Figure 2-2, one 32-bit timer (TIMHI) is used as a 32-bit prescaler to a second timer (TIMLO).

Figure 2-2 Dual 32-Bit Timers Chained Mode Block Diagram

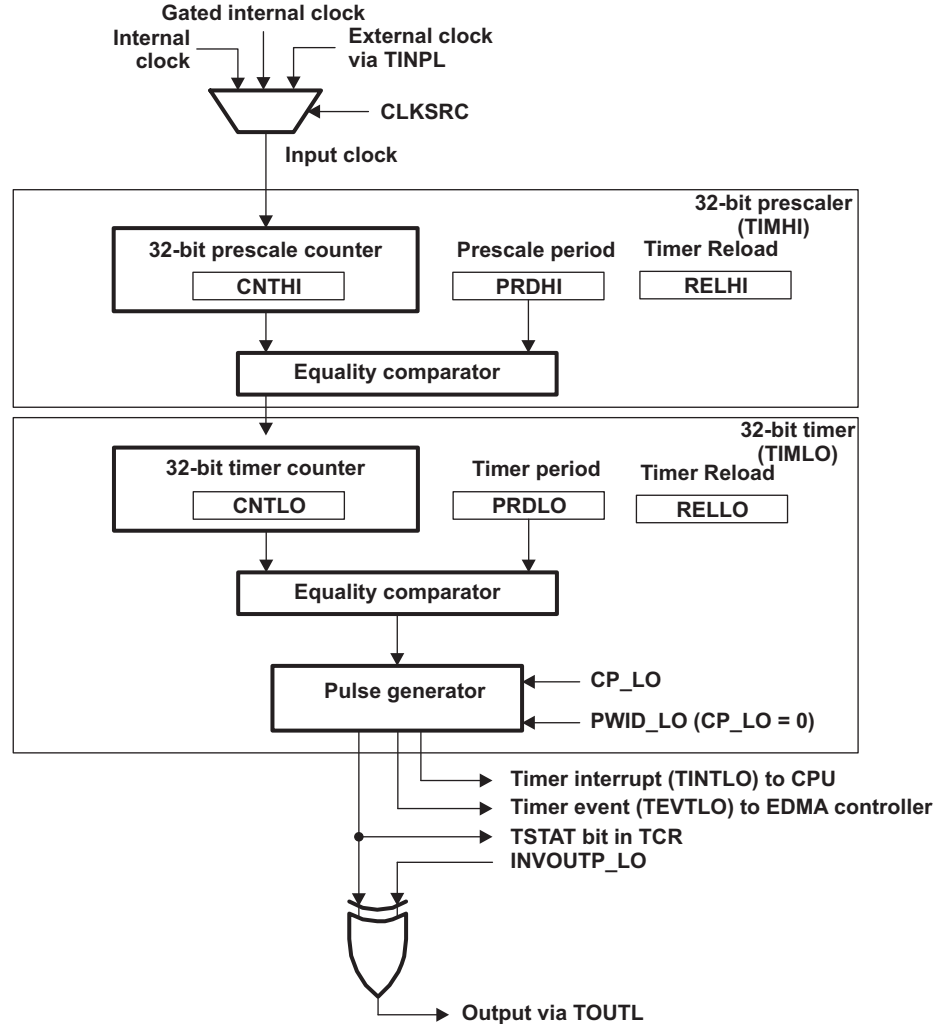

The 32-bit prescaler (TIMHI) uses the counter register (CNTHI) and the period register (PRDHI) to form a 32-bit prescale counter register and a 32-bit prescale period register, respectively. When the timer is enabled, the prescale counter starts incrementing by 1 at every timer input clock cycle. One cycle after the prescale counter matches the prescale period, a clock signal is generated and the prescale counter register is reset to 0 (see the example in Figure 2-3).

Figure 2-3 Dual 32-Bit Timers Chained Mode Example

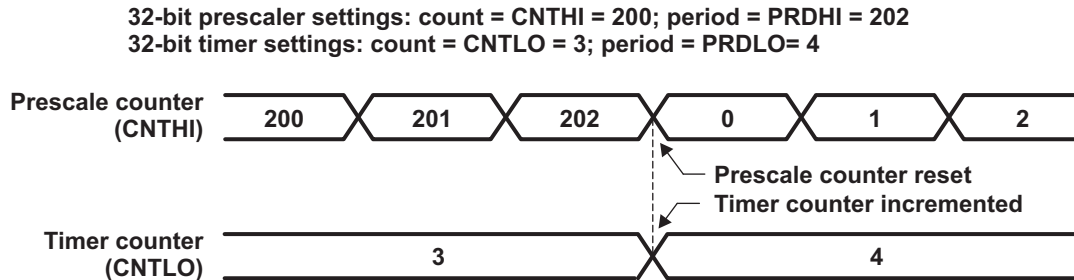

The other 32-bit timer (TIMLO) uses the counter register (CNTLO) and the period register (PRDLO) to form a 32-bit timer counter register and a 32-bit timer period register, respectively. This timer is clocked by the output clock from the prescaler (see the example in Figure 2-3). The timer counter increments by 1 at every prescaler output clock cycle. When the timer counter matches the timer period, a maskable timer interrupt (TINTLO), a timer EDMA event (TEVTLO), and an output signal are generated.

When in pulse mode ($CP_LO = 0$), the timer output (TOUTL) asserts a pulse that is 1, 2, 3, or 4 timer clock cycles wide, depending on the setting of the pulse width (PWID) bits in the timer control register (TCR). When the timer is configured in continuous mode, the timer counter is reset to 0 on the cycle after the timer counter reaches the timer period. The timer can be stopped, restarted, reset, or disabled using the bits of the timer control register. The timer control register (TCR) does not control the TIMHI in this mode.

2.2.2 Unchained Mode

In the unchained mode, shown in Figure 2-4, the timer can operate as two independent 32-bit timers. One 32-bit timer (TIMHI) can be configured as a 32-bit timer being clocked by a 4-bit prescaler. The other (TIMLO) can be used as a 32-bit timer.

Figure 2-4 Dual 32-Bit Timers Unchained Mode Block Diagram

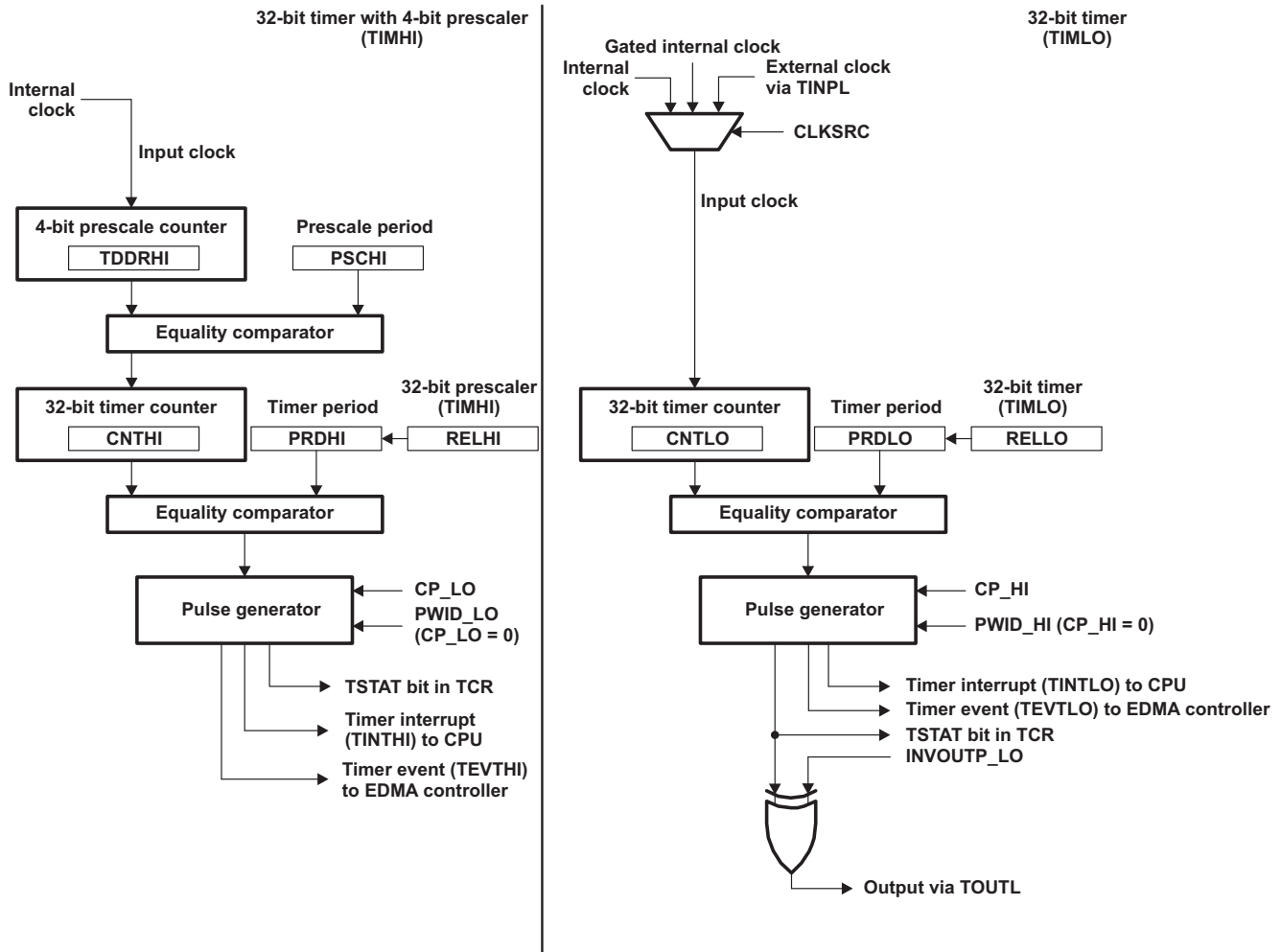

2.2.2.1 32-Bit Timer With a 4-Bit Prescaler (TIMHI)

In the unchained mode, the 4-bit prescaler must be clocked by the internal clock; an external clock source cannot be used for TIMHI. The 4-bit prescaler uses the timer divide-down ratio bits (TDDRHI) and the prescale counter bits (PSCHI) in TCR to form a 4-bit prescale counter register and a 4-bit prescale period register, respectively. When the timer is enabled, the prescale counter starts incrementing by 1 at every timer input clock cycle. One cycle after the prescale counter matches the prescale period, a clock signal is generated for the 32-bit timer.

The 32-bit timer uses the counter register (CNTHI) and the period register (PRDHI) to form a 32-bit timer counter register and a 32-bit timer period register, respectively. The 32-bit timer is clocked by the output clock from the 4-bit prescaler (see the example in Figure 2-5). When the timer is enabled, the timer counter increments by 1 at every prescaler output clock cycle. When the timer counter matches the timer period, a maskable timer interrupt (TINTHI) and a timer EDMA event (TEVTHI) are

generated. The state of the output signal is read in the timer status (TSTAT_HI) bit of the timer control register (TCR). When in pulse mode (CP_HI = 0), TSTAT_HI stays high or low for 1, 2, 3, or 4 timer clock cycles. The pulse width depends on the setting of the pulse width (PWID_HI) bits in TCR. When in clock mode (CP_HI = 1), the TSTAT bit changes state (high-to-low or low-to-high) every time the timer counter matches the timer period. When the timer is configured in continuous mode, the timer counter is reset to 0 on the cycle after the timer counter reaches the timer period (see the example in Figure 2-5). Note that when the timer counter matches the timer period, the period register (PRDHI) will be loaded with the value in the reload register (RELHI) if ENAMODE_HI = 11b. The timer can be stopped, restarted, reset, or disabled using TCR and the timer global control register (TGCR).

Figure 2-5 Dual 32-Bit Timers Unchained Mode Example

4-bit prescaler settings: count = TDDRHI = 1; period = PSCHI = 2
32-bit timer settings: count = CNTHI = 15; period = PRDHI = 16

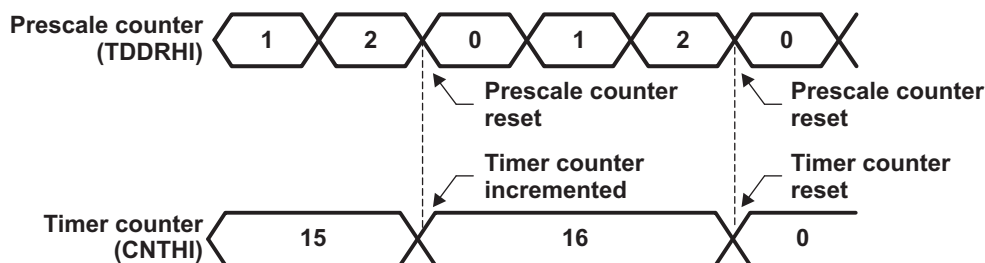

2.2.2.2 32-Bit Timer (TIMLO)

The other 32-bit timer (TIMLO) uses the counter register (CNTLO) and the period register (PRDLO) to form a 32-bit timer counter register and a 32-bit timer period register, respectively. When the timer is enabled, the timer counter increments by 1 at every timer input clock cycle. When the timer counter matches the timer period, a maskable timer interrupt (TINTLO), a timer EDMA event (TEVTLO), and an output signal (TOUTL) are generated. The state of the output signal is also read in the timer status (TSTAT) bit of the timer control register (TCR). When in pulse mode (CP_LO = 0) and depending on the timer output inverter control (INVOUTP) bit in TCR, the timer output pin (TOUTL) stays high or low for 1, 2, 3, or 4 timer clock cycles.

The pulse width depends on the setting of the pulse width (PWID_LO) bits in TCR. When in clock mode (CP_LO = 1), the timer output and the TSTAT_LO bit change state (high-to-low or low-to-high) every time the timer counter matches the timer period. When the timer is configured in continuous mode, the timer counter is reset to 0 on the cycle after the timer counter reaches the timer period. When the timer counter matches the timer period, the period register will be loaded with the value in the reload register (RELLO) if ENAMOD_LO = 11b. The timer can be stopped, restarted, reset, or disabled using TCR and the timer global control register (TGCR).

2.3 Counter, Reload and Period Registers Used in GP Timer Modes

Table 2-1 summarizes the counter registers (CNTLO and CNTHI), reload registers (RELLO and RELHI) and period registers (PRDLO and PRDHI) used in each GP timer mode.

Table 2-1 Counter and Period Registers Used in GP Timer Modes

| Timer Mode | | Counter Registers | Reload Registers | Period Registers |
|-------------------------|------------------------------|----------------------|------------------|-----------------------|
| 64-bit general-purpose | | CNTHI:CNTLO | RELHI:RELLO | PRHI:PRDLO |
| Dual 32-bit chained | Prescaler (TIMHI) | CNTHI | - | PRDHI |
| | Timer (TIMLO) | CNTLO | - | PRDLO |
| Dual 32-bit unchained | Timer (TIMLO) | CNTLO | RELLO | PRDLO |
| | Timer with prescaler (TIMHI) | PSCHI bits and CNTHI | RELHI | TDDRHI bits and PRDHI |
| End of Table 2-1 | | | | |

2.4 Timer Plus Modes

2.4.1 Timer Capture Registers

When the timer has a timeout due to a normal expiration of timer, external input event in Event Capture Mode, or read of timer counter registers in Read Reset Mode, the values of the timer counter registers (CNTLO and CNTHI) are copied onto the timer counter capture registers (CAPLO and CAPHI). Note that the value in TDDR is not captured when a read of CNTHI happens.

2.4.2 Event Capture Mode

When the PLUSEN bit in the timer global control register (TGCR) is set, Event Capture Mode is available for CNTLO when the timer is configured in 32-bit unchained mode. When Event Capture Mode is enabled, the timer cycle is restarted when an external input event occurs on pin TINPL. In particular, when an external input event occurs, the timer stops counting, generates output CPU interrupts and EDMA events, copies values from the timer counter register CNTLO to the timer capture register CAPLO, reloads the timer period register PRDLO if in continuous mode with period reload (ENAMODE = 11b), resets the timer counter register CNTLO and then restarts counting in continuous mode. Event Capture Mode is available only when the timer clock source is the internal timer (CLKSRC = 0) and the timer is in continuous mode (ENAMODE = 10b or 11b). Capture mode is enabled using the Capture mode enable bit CAPMODE_LO in the timer control register (TCR). The type of input event is selected by the capture event mode bit CAPEVTMODE_LO in the timer control register (TCR). All of the following input event types are available:

- Rising edge of input signal
- Falling edge of input signal
- Rising or falling edge of input signal

2.4.3 Timer Counter Register Read Reset Mode

Read Reset Mode is available when the PLUSEN bit in the timer global control register (TGCR) is set and the timer is configured in 32-bit unchained mode. When Read Reset Mode is enabled, the timer cycle will restart when the timer counter registers are read (CNTLO and/or CNTHI). In particular, when the timer registers are read, the timer stops counting, copies values from the timer counter registers (CNTLO and/or CNTHI) to the timer capture registers (CAPLO and/or CAPHI), reloads the timer period registers (PRDLO and/or PRDHI) if in continuous mode with period reload (ENAMODE = 11b), and then restarts counting in continuous mode. Timer output events (TINTn, TEVTn, and TOUTn) are not generated during this process. Read Reset Mode is enabled using the read reset mode enable bit (READRSTMODE) in the timer control register (TCR).

Timer Operation

The following sections describe the overall timer operation. For specific details on the watchdog timer operation, see “Watchdog Timer Mode” on page 4-1.

- 3.1 ["Timer Mode Selection"](#) on page 3-2
- 3.2 ["Timer Enabling"](#) on page 3-2
- 3.3 ["Timer Clock Source Selection"](#) on page 3-4
- 3.4 ["Timer Output Mode Selection"](#) on page 3-4
- 3.5 ["Timer Counting"](#) on page 3-5
- 3.6 ["Timer Reset Sources"](#) on page 3-5
- 3.7 ["Timer Interrupt Rate"](#) on page 3-5
- 3.8 ["Timer Emulation Modes"](#) on page 3-6
- 3.9 ["Timer Operation Boundary Conditions"](#) on page 3-6
- 3.10 ["Initializing the Timer"](#) on page 3-9

3.1 Timer Mode Selection

The timer can be configured as a 64-bit general-purpose timer or dual 32-bit timers (chained or unchained), or a watchdog timer using the timer mode (TIMMODE) bits in timer global control register (TGCR) (see [Table 3-1](#)). At reset, the timer is configured as a 64-bit GP timer by default. These bits can be written to select dual 32-bit timers (chained or unchained) or a watchdog timer function as shown in [Table 3-1](#).

Table 3-1 Timer Mode Selection

| TIMMODE Bits | | |
|------------------|-------|--|
| Bit 3 | Bit 2 | Timer Mode |
| 0 | 0 | 64-bit general-purpose timer (default) |
| 0 | 1 | Dual 32-bit timers (unchained) |
| 1 | 0 | 64-bit watchdog timer |
| 1 | 1 | Dual 32-bit timers (chained) |
| End of Table 3-1 | | |

3.2 Timer Enabling

In the 64-bit timer mode or the dual 32-bit timers chained mode, the timer can be enabled by setting the TIMLORS and TIMHIRS bits in the timer global control register (TGCR) to 1 and setting the ENAMODE_LO bits in the timer control register (TCR) to 01b, 10b or 11b.

In the dual 32-bit timers unchained mode, the 32-bit timer (TIMLO) can be enabled by setting the TIMLORS bit in TGCR to 1 and the ENAMODE_LO bits in TCR to 01b, 10b or 11b. The 32-bit timer with prescaler (TIMHI) can be enabled by setting the TIMHIRS bit in TGCR to 1 and the ENAMODE_HI bits in the timer control register (TCR) to 01b, 10b or 11b.

[Table 3-2](#) is a summary of timer enabling.

Table 3-2 Timer Enabling (Part 1 of 2)

| Timer Mode | TCR ENAMODE bits | | | | TGCR | | Timer Status |
|------------------------|------------------|--------|-------|-------|---------|---------|---|
| | Bit 23 | Bit 22 | Bit 7 | Bit 6 | TIMHIRS | TIMLORS | |
| 64-bit general-purpose | X | X | 0 | 0 | X | X | Disabled (default) |
| | X | X | 0 | 1 | 1 | 1 | Enabled one time |
| | X | X | 1 | 0 | 1 | 1 | Enabled continuously |
| | X | X | 1 | 1 | 1 | 1 | Enabled continuously with period reload |
| Dual 32-bit chained | X | X | 0 | 0 | X | X | Disabled (default) |
| | X | X | 0 | 1 | 1 | 1 | Enabled one time |
| | X | X | 1 | 0 | 1 | 1 | Enabled continuously |
| | X | X | 1 | 1 | 1 | 1 | Reserved |
| Dual 32-bit unchained | 0 | 0 | 0 | 0 | X | X | Both timers disabled (default) |
| 32-bit timer | X | X | 0 | 1 | 1 | 1 | 32-bit timer enabled one time |
| | 1 | 0 | 1 | 0 | 1 | 1 | 32-bit timer enabled continuously |
| | 1 | 1 | 1 | 1 | 1 | 1 | Enabled continuously with period reload |

Table 3-2 Timer Enabling (Part 2 of 2)

| Timer Mode | TCR ENAMODE bits | | | | TGCR | | Timer Status |
|-----------------------------|------------------|--------|-------|-------|---------|---------|---|
| | Bit 23 | Bit 22 | Bit 7 | Bit 6 | TIMHIRS | TIMLORS | |
| 32-bit timer with prescaler | 0 | 1 | X | X | 1 | X | 32-bit timer enabled one time |
| | 1 | 0 | X | X | 1 | X | 32-bit timer enabled continuously |
| | 1 | 1 | X | X | 1 | X | Enabled continuously with period reload |
| End of Table 3-2 | | | | | | | |

3.3 Timer Clock Source Selection

As shown in [Table 3-3](#) and [Figure 3-1](#), the timer clock source for TIMLO is selected using the clock source (CLKSRC) bit and timer input enable (TIEN_LO) bit in timer control register (TCR). The input clock source for TIMHI is always the internal clock.

Three clock sources are available to drive the timer clock:

- Internal clock, by setting CLKSRC_LO = 0 and TIEN_LO = 0.
- Internal clock gated by the timer input signal, by setting CLKSRC_LO = 0 and TIEN_LO = 1.
- External clock on the timer input pin (TINPL), by setting CLKSRC_LO = 1. This input signal is synchronized internally and can be inverted by setting the timer inverter control (INVINP_LO) bit in TCR to 1.

At reset, the clock source is the internal clock. The internal clock is derived from the DSP clock generator, as shown in [Figure 1-2](#).

When the clock source is the gated internal clock, the timer starts counting when the timer input transitions from low to high and the timer stops counting when the timer input transitions from high to low.

Table 3-3 Timer Clock Source Selection

| CLKSRC_LO | TIEN_LO | Input Clock |
|-------------------------|---------|---------------------------------------|
| 0 | 0 | Internal clock (default) |
| 0 | 1 | Gated internal clock |
| 1 | X | External clock on timer input (TINPL) |
| End of Table 3-3 | | |

Figure 3-1 Timer Clock Source Block Diagram

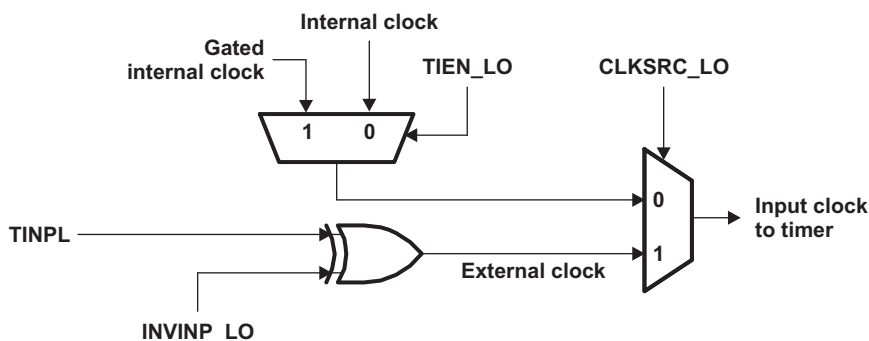

3.4 Timer Output Mode Selection

The two basic timer output modes are pulse mode and clock mode. The timer output mode is selected using the clock/pulse mode bits (CP_LO and CP_HI) in the timer control register (TCR).

When in the pulse mode (CP_LO or CP_HI = 0), the pulse width bits (PWID_LO or PWID_HI) set the pulse width to 1, 2, 3, or 4 timer clock cycles. This pulse can be inverted by setting the timer output inverter control bits (INVOUTP_LO or INVOUTP_HI) to 1.

When in the clock mode (CP_LO or CP_HI = 1), the timer output signal has a 50% duty cycle. The signal toggles (from high-to-low or from low-to-high) each time the timer counter reaches the timer period.

The output signal of TIMLO is driven on both TSTAT_LO and the timer output pin TOUTL. The output signal of TIMHI is driven on TSTAT_HI only.

3.5 Timer Counting

The timer counter runs at the timer clock rate specified by the clock source bit (CLKSRC) in the timer control register (TCR). Counting is enabled by setting the enabling mode (ENAMODE) bits in TCR to 01b or 10b. When enabled, the timer counter starts incrementing until the counter reaches a value equal to the value in the timer period register. Once the timer counter matches the timer period:

- If the timer is set to enable one time (ENAMODE = 01b), the timer counter is reset to 0, then stops.
- If the timer is set to enable continuously (ENAMODE = 10b), the timer counter is reset to 0, then continues counting.
- If the timer is set to enable continuously with period reload (ENAMODE = 11b), the timer counter is reset to zero, reloads the period registers (PRDLO and PRDHI) with the value in the period reload registers (RELLO and RELHI), then continues counting.

Once the timer stops, if an external clock is used as the timer clock, the disable period must last at least one external clock period or the timer will not start counting again. When using the external clock, the count value is synchronized to the internal clock.

Note that when both the timer counter and timer period are cleared to 0, the timer can be enabled but the timer counter does not increment because the timer period is 0.

3.6 Timer Reset Sources

The timer has two reset sources: hardware reset and the timer reset bits (TIMLORS and TIMHIRS) in the timer global control register (TGCR).

- When a hardware reset is asserted, all the registers are set to their default values.
- When TIMLORS is cleared to 0, TSTAT_LO in TCR is reset to 0 and TOUTL is in the high-impedance state.
- When TIMHIRS is cleared to 0, TSTAT_HI in TCR is reset to 0.

3.7 Timer Interrupt Rate

To receive periodic interrupts, configure the timer to run in the continuous mode (ENAMODE = 10b or 11b). Each time the timer finishes counting, it can generate a timer interrupt for the CPU and a timer event for the EDMA controller. The rate at which this occurs (the timer interrupt rate) depends on whether the timer has a prescaler.

If the timer does not have a prescaler, there is only one counter. When the timer counter reaches the programmed timer period, the timer generates an interrupt and an EDMA event. Because the timer is in the continuous mode, one cycle after the timer counter matches the timer period, the timer counter is reset to 0 and starts counting again. The timer interrupt rate is:

$$\text{TINRate} = \frac{\text{Timer input clock rate}}{\text{Programmed timer period} + 1}$$

If a timer has a prescaler, there are two counters. One cycle after the prescale counter reaches the programmed prescale period, the timer counter is incremented by 1, and the prescale counter is reset to start counting again.

If the prescaler continues long enough, it increments the timer counter to the programmed timer period. At that time, the timer generates an interrupt and an EDMA event. One cycle later (assuming the continuous mode), the timer counter is reset to 0 and starts counting again. The timer interrupt rate in this case is:

$$\text{TINRate} = \frac{\text{Timer input clock rate}}{(\text{Programmed prescale period} + 1) (\text{Programmed timer period} + 1)}$$

3.8 Timer Emulation Modes

The timer has an emulation management and clock speed register (EMUMGT_CLKSPD). As shown in Table 3-4, the FREE and SOFT bits of EMUMGT_CLKSPD determine how the timer responds to an emulation suspend event. An emulation suspend event corresponds to any type of emulator access to the DSP, such as a hardware or software breakpoint, a probe point, or a printf instruction.

Table 3-4 Timer Emulation Modes Selection

| FREE | SOFT | Emulation Mode |
|-------------------------|------|---|
| 0 | 0 | Default: The timer stops immediately. |
| 0 | 1 | The timer stops when the timer counter value increments and reaches the value in the timer period register. |
| 1 | X | The timer runs free regardless of SOFT bit status. |
| End of Table 3-4 | | |

When using an internal clock as the timer clock source, the timer counter increments properly when single stepping. For example, the timer increments by one for each single step if the timer clock is equal to the CPU clock; or increments by one for every six single steps if the timer clock is equal to one-sixth of the CPU clock.

3.9 Timer Operation Boundary Conditions

The following boundary conditions affect the timer operation.

3.9.1 Writing to and Reading From the Reserved Registers

Write the reset value to the reserved registers. Reading from the reserved registers returns zeros.

3.9.2 Timer Count = 0 and Timer Period = 0 (No Prescaler)

Consider a timer that has no prescaler:

- The 64-bit GP timer.
- TIMLO in the 32-bit dual timers configuration (unchained mode).

In the special case when timer count = 0 and timer period = 0:

- After a hardware reset and before the timer starts counting (ENAMODE bits = 00b), the timer output signal is held low.
- Once the timer is enabled, its behavior depends on the selected enabling mode (ENAMODE bits = 01b, 10b or 11b in the timer control register) and the selected timer output mode (CP bits = 0 or 1 in the timer control register). The options are summarized in [Table 3-5](#).
- The timer interrupt is not generated.

Table 3-5 Timer Operation When Timer Count = 0 and Timer Period = 0

| Timer Enabling Mode | Timer Output Mode | Timer Operation When Timer Count = 0 and Timer Period = 0 No Prescaler |
|---|--------------------------|---|
| One-time mode (ENAMODE bits = 01b) | Pulse mode (CP bits = 0) | The timer output pulses once at the first timer clock cycle, and the timer stops counting at the next timer clock cycle. The pulse width is defined by the PWID bits of the timer control register. |
| | Clock mode (CP bits = 1) | The timer output toggles once at the first timer clock cycle. The timer stops counting at the next timer clock cycle. |
| Continuous mode (ENAMODE bits = 10b) | Pulse mode (CP bits = 0) | The timer output pulses once at the first timer clock cycle, and the timer continues to count up. Whenever the timer counter reaches its maximum value, it rolls around to 0 (see Section 3.9.4), generating another pulse. The pulse width is defined by the PWID bits of the timer control register. |
| | Clock mode (CP bits = 1) | The timer output toggles once at the first timer clock cycle and then toggles with a frequency of half the timer clock frequency as the timer continues to count. |
| Continuous mode with reload (ENAMODE bits = 11b) | Pulse mode (CP bits = 0) | The timer output pulses once at the first timer clock cycle, and the timer continues to count up. Whenever the timer counter reaches its maximum value, it rolls around to 0 (see Section 3.9.4), generating another pulse. The pulse width is defined by the PWID bits of the timer control register. The period registers are loaded with the reload registers. |
| | Clock mode (CP bits = 1) | The timer output toggles once at the first timer clock cycle and then toggles with a frequency of half the timer clock frequency as the timer continues to count. The period registers are loaded with the reload registers. |
| End of Table 3-5 | | |

3.9.3 Timer Count = 0, Timer Period = 0, Prescale Count = 0, and Prescale Period = 0

Consider a timer that has a prescaler:

- The combination timer in the 32-bit dual timers chained mode.
- TIMHI in the 32-bit dual timer configuration (unchained mode).

In the special case when timer count = 0, timer period = 0, prescale count = 0, and prescale period = 0, the timer operates in the same manner as a non-prescaled timer with timer count = 0 and timer period = 0 (see [Section 3.9.2](#)).

3.9.4 Timer Counter Overflow

Timer counter overflow can happen when the timer counter register is set to a value greater than the value in the timer period register. The counter reaches its maximum value (FFFF FFFFh or FFFF FFFF FFFF FFFFh), rolls over to 0, and continues counting until it reaches the timer period. An example is shown in Figure 3-2.

Figure 3-2 32-Bit Timer Counter Overflow Example

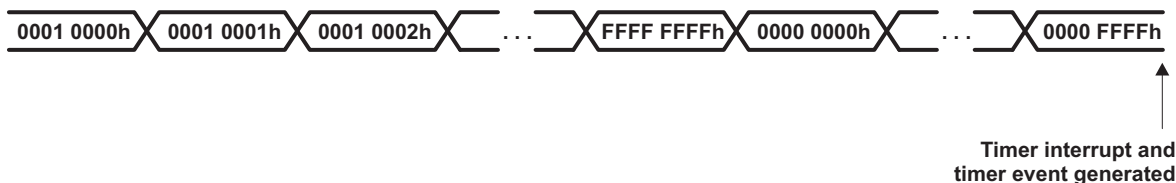

3.9.5 Writing to Registers of an Active Timer

Writes from the configuration bus to the timer registers are not allowed when the timer is active, except for stopping or resetting the timers. In the 64-bit and dual 32-bit timer modes, registers that are protected by hardware include CNTLO, CNTHI, PRDLO, PRDHI, TGCR (except the TIMLORS and TIMHIRS bits), and TCR (except the ENAMODE bits).

3.9.6 Small Timer Period Value in Pulse Mode

Small timer periods in pulse mode ($CP = 0$) can cause TSTAT to remain high when ENAMODE is not 0. This condition can occur when $PRD \cdot PWID + 1$.

3.9.7 Reading the Counter Registers

Table 3-6 summarizes how to read the counter registers. When reading the timer counter in 64-bit GP timer mode, the CPU must read the first 32-bit word from the CNTLO registers. When this occurs, the timer takes a snapshot of the CNTHI register and copies it into a shadow register CNTHIS. Note that reading CNTHI instead of CNTLO will not cause the timer to take a snapshot of the timer counters and copy them into the shadow registers.

Table 3-6 Reading Counter Registers

| Timer Mode | CPU | |
|--------------|------------|------------------------------------|
| 64-bit timer | Read CNTLO | Read CNTLO Copy CNTHI to CNTHIS |
| | Read CNTHI | Read from CNTHIS |
| 32-bit timer | Read CNTLO | Read CNTLO |
| | Read CNTHI | Read CNTHI |

3.10 Initializing the Timer

After a hardware reset, the enabling mode (ENAMODE) bits in the timer control register (TCR) are cleared to 0 and the timer is disabled. The timer counter and period registers are cleared to 0. The timer can be configured to the desired mode by programming the control registers, TCR and (in the case of the watchdog timer mode) WDTCR.

Figure 3-3 shows a typical timer initialization:

1. Write the timer counter, period reload (if used) and period values to CNTHI and/or CNTLO, RELHI, RELLO and PRDHI and/or PRDLO registers.
2. If the 4-bit prescaler is used, write the values to the TDDRHI and PSCHI bits.
3. Set the remaining control bits to the required state.
4. Set W DEN = 1 to use the timer as watchdog timer, if necessary.
5. To start the timer, set the ENAMODE bits to use the timer as a continuous interrupt generator (ENAMODE bits = 10b or 11b) or as a one-time counter (ENAMODE bits = 01b).
6. Program the WDKEY bits, if the watchdog timer mode is selected.

Figure 3-3 **Timer Initialization**

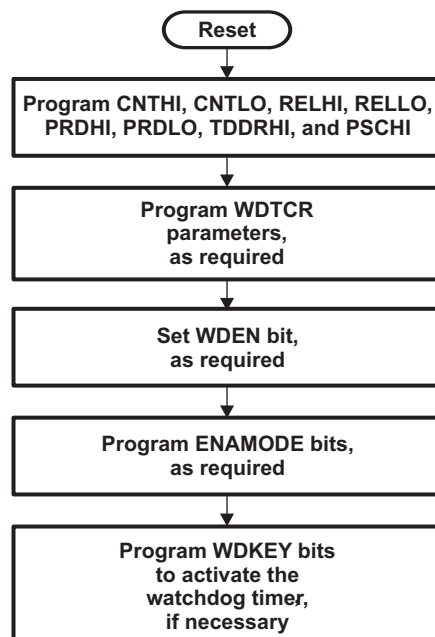

Watchdog Timer Mode

The timer also can be configured as a 64-bit watchdog timer. As a watchdog timer, it can be used to prevent system lock-up when the software becomes trapped in loops with no controlled exit. After a hardware reset, the timer is configured as a 64-bit GP timer and the watchdog mode is disabled. The timer then can be reconfigured as a watchdog timer using the timer mode (TIMMODE) bits in the timer global control register (TGCR) and the watchdog timer enable (WDEN) bit in the watchdog timer control register (WDTCR). In the watchdog timer mode, the timer requires a special service sequence to be executed periodically. Without this periodic servicing, the timer counter increments until it matches the timer period and causes a watchdog timeout event.

Once the timer is configured as a watchdog timer, it cannot be reconfigured as a GP timer until a device reset occurs. When the timer counter matches the timer period, the timer generates two signals: an output signal and an interrupt signal (described in [Section 4.1](#)). Typically, one or the other is used, depending on whether an external or internal trigger is desired.

This chapter discusses the following topics:

- 4.1 ["Timer Output Signal and Timer Interrupt Signal in Watchdog Mode"](#) on page 4-2
- 4.2 ["Watchdog Timer Mode Restrictions"](#) on page 4-2
- 4.3 ["Watchdog Timer Mode Operation"](#) on page 4-2
- 4.4 ["Watchdog Timer Register Write Protection"](#) on page 4-5

4.1 Timer Output Signal and Timer Interrupt Signal in Watchdog Mode

When the periodic service sequence is not met, the timer counter increments until it matches the period and times out. During a timeout, a pulse is asserted on the timer output pin, and an internal maskable interrupt (TINTLO) is triggered. The timer output pin can be externally connected to the non-maskable interrupt (NMI) pin of the device. Note that the timer pulse width must be configured to generate an active low pulse long enough for the CPU to recognize it as a NMI pulse. The pulse width is configured using the PWID bits of the timer control register (TCR).

4.2 Watchdog Timer Mode Restrictions

The watchdog timer mode is selected and enabled when TIMMODE = 10b in TGCR and WDEN = 1 in WDTCR. This mode has the following restrictions:

- No dual 32-bit timers mode
- No gated clock
- No external clock
- No one-time enabling
- No clock mode (only pulse mode)

4.3 Watchdog Timer Mode Operation

Figure 4-1 shows the timer when it is used in the watchdog timer mode. Note that in this mode, the timer clock must be set to the internal clock (CLKSRC_LO = 0). The CP_LO bit is forced to 0 because the pulse mode is required for the watchdog timer operation. The counter registers (CNTLO and CNTHI) form a 64-bit timer counter register and the period registers (PRDLO and PRDHI) form a 64-bit period register.

When the timer counter matches the timer period, the timer generates a watchdog timeout event. This event:

- Drives the timer output signal (TOUTL) and/or the timer interrupt signal (TINTLO).
- Resets the timer counter to 0.
- Sets the TSTAT_LO bit, which is copied to the WDFLAG bit of WDTCR.

The timer output signal can be connected externally to the NMI pin to generate a non-maskable interrupt, if so desired.

Figure 4-1 Timer in Watchdog Timer Mode

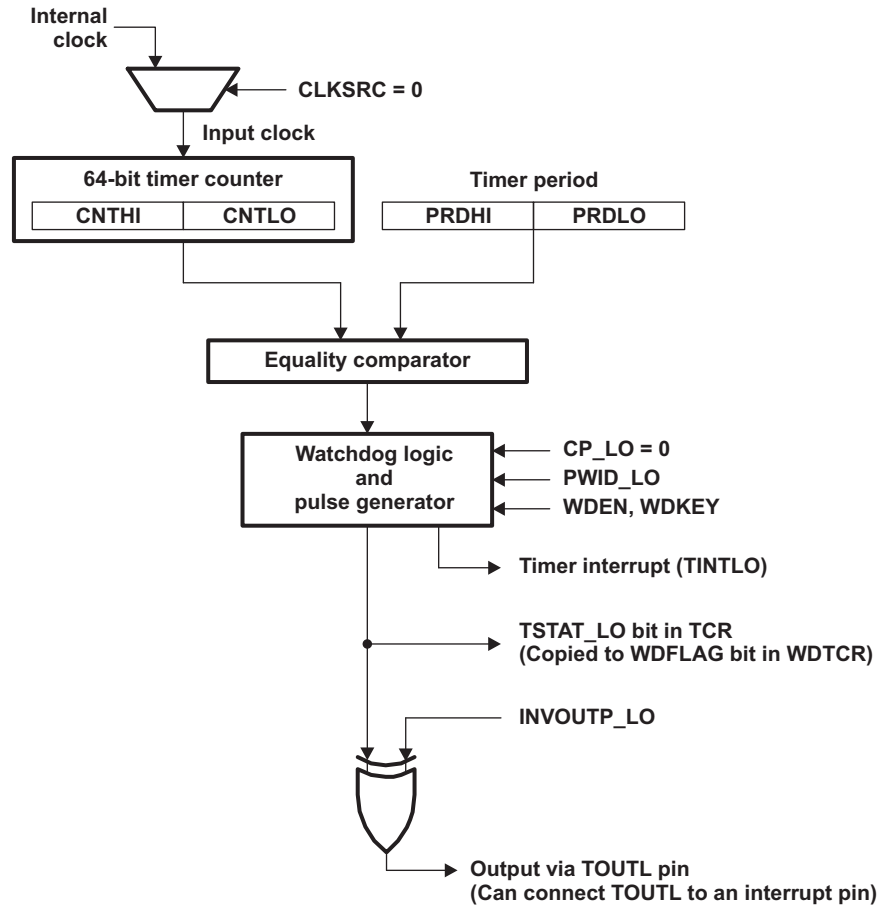

To activate the watchdog timer, a certain sequence of events must be followed, as shown in state diagram [Figure 4-2](#).

Figure 4-2 Watchdog Timer Operation State Diagram

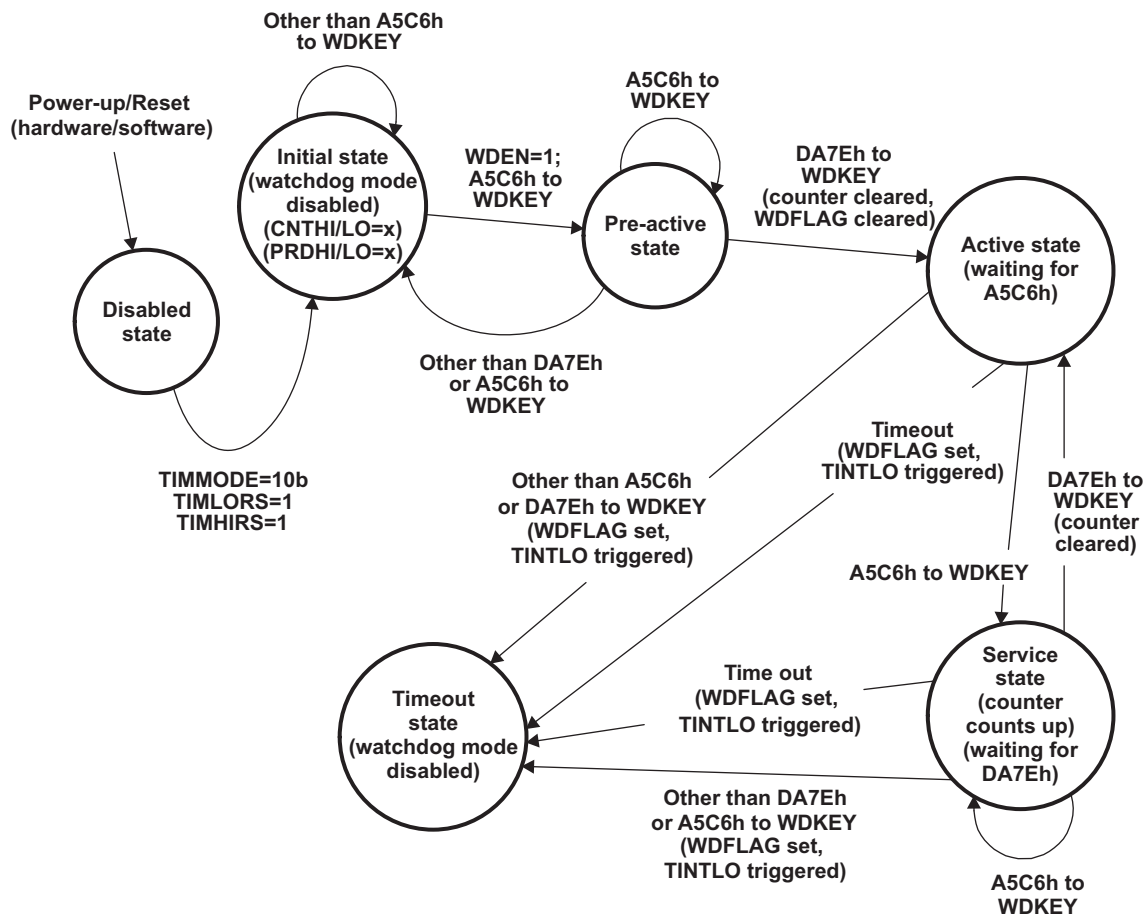

Once the watchdog timer is activated, it can be disabled only by a watchdog timeout event or by a hardware reset. A special key sequence is required to prevent the watchdog timer from being accidentally serviced while the software is trapped in a dead loop or by some other software failure.

To prevent a watchdog timeout event, the timer has to be serviced periodically (you could use another on-chip timer or an off-chip timer) by writing A5C6h followed by DA7Eh to the watchdog timer service key (WDKEY) bits of WDTCR before the timer finishes counting up. Both A5C6h and DA7Eh are allowed to be written to the WDKEY bits, but only the correct sequence of A5C6h followed by DA7Eh to the WDKEY bits services the watchdog timer. Any other writes to the WDKEY bits triggers the watchdog timeout event immediately. Writes to other bits in the WDTCR are ignored when the watchdog timer is active (see [Section 4.4](#)).

When the watchdog timer is in the timeout state, the watchdog timer is disabled, the WDFLAG bit is cleared to 0, and the timer is reset. After entering the timeout state, the watchdog timer cannot be enabled again until a hardware reset occurs.

After a hardware reset, the watchdog timer is disabled; however, reads or writes to the watchdog timer registers are allowed. Once the WDEN bit is set and A5C6h is written to the WDKEY bits, the watchdog timer enters the pre-active state. In the pre-active state:

- A write to WDTCR is allowed only when the write comes with the correct key (A5C6h or DA7Eh) to the WDKEY bits.
- A write of DA7Eh to the WDKEY bits when the WDEN bit is set to 1 resets the counters and activates the watchdog timer.

The PRDHI, PRDLO, TCR, and WDTCR registers must be configured before the watchdog timer enters the active state. The WDEN bit must be set to 1 before writing DA7Eh to the WDKEY bits in the pre-active state. Every time the watchdog timer is serviced by the correct WDKEY sequence, the watchdog timer counter is automatically reset.

Before the watchdog timer enters the active state, the timer output signal is never asserted. Only the timer interrupt is asserted when the timer finishes counting up. In this case, the timer interrupt can be used to:

- Indicate that the watchdog timer is counting but is not in the active state.
- Generate a periodic interrupt, without having to service the watchdog timer.

The watchdog timer can always be disabled before entering the active state.

4.4 Watchdog Timer Register Write Protection

Once the watchdog timer enters the pre-active state, writes to registers CNTHI, CNTLO, PRDHI, PRDLO, TCR, and WDTCR (except for the WDKEY bits) will have no effect. Writes to WDEN when the watchdog timer is in the timeout state have no effect.

The value 0xA5C6 or 0xDA7E must be written to the WDKEY bits depending on the current state (see [Figure 4-2](#)). After the watchdog timer has entered the initial state, clearing the TIMLORS and TIMHIRS bits is prohibited.

Registers

This chapter provides a brief description of the Timer64 registers and a table listing each of the registers.

- 5.1 ["Timer Registers" on page 5-2](#)
- 5.2 ["Emulation Management and Clock Speed Register \(EMUMGT_CLKSPD\)" on page 5-2](#)
- 5.3 ["Timer Counter Registers \(CNTHI and CNTLO\)" on page 5-3](#)
- 5.4 ["Timer Period Registers \(PRDHI and PRDLO\)" on page 5-4](#)
- 5.5 ["Timer Control Register \(TCR\)" on page 5-5](#)
- 5.6 ["Timer Global Control Register \(TGCR\)" on page 5-8](#)
- 5.7 ["Watchdog Timer Control Register \(WDTCR\)" on page 5-9](#)
- 5.8 ["Timer Reload Registers \(RELHI and RELLO\)" on page 5-10](#)
- 5.9 ["Timer Capture Registers \(CAPHI and CAPLO\)" on page 5-11](#)
- 5.10 ["Timer Interrupt Control and Status Register \(INTCTLSTAT\)" on page 5-12](#)

5.1 Timer Registers

The timer contains a set of registers as indicated in [Table 5-1](#). All timer register bits are read-write unless otherwise specified. For specific address locations, see the device-specific data manual.

Table 5-1 Timer Registers

| Offset | Acronym | Name | See |
|-------------------------|---------------|---|------------------------------|
| 0004 | EMUMGT_CLKSPD | Emulation management and clock speed register | Section 5.2 |
| 0010 | CNTLO | Counter register low | Section 5.3 |
| 0014 | CNTHI | Counter register high | Section 5.3 |
| 0018 | PRDLO | Period register low | Section 5.4 |
| 001C | PRDHI | Period register high | Section 5.4 |
| 0020 | TCR | Timer control register | Section 5.5 |
| 0024 | TGCR | Timer global control register | Section 5.6 |
| 0028 | WDTCR | Watchdog timer control register | Section 5.7 |
| 0034 | RELLO | Timer Reload register low | Section 5.8 |
| 0038 | RELHI | Timer Reload register high | Section 5.8 |
| 003C | CAPLO | Timer Capture register low | Section 5.9 |
| 0040 | CAPHI | Timer Capture register high | Section 5.9 |
| 0044 | INTCTLSTAT | Timer interrupt control and status register | Section 5.10 |
| End of Table 5-1 | | | |

5.2 Emulation Management and Clock Speed Register (EMUMGT_CLKSPD)

The EMUMGT_CLKSPD register contains the FREE and SOFT bits that determine how the timer responds to an emulation suspend event (see [Figure 5-1](#) and [Table 5-2](#)). An emulation suspend event corresponds to any type of emulator access to the DSP, such as a hardware or software breakpoint, a probe point, or a printf instruction. For additional emulation information, see [Section 3.8](#).

The CLKDIV field of this register also can be read to identify the ratio of the CPU clock to the timer input clock. For example, in devices where the internal timer clock frequency is equal to the CPU frequency divided by 6, the CLKDIV field will read as 6 on those devices.

Figure 5-1 Emulation Management and Clock Speed Register (EMUMGT_CLKSPD)

| | | | | | |
|----------|--------------------|----------|------|------|-----|
| 31 | 20 19 | 16 15 | 2 | 1 | 0 |
| Reserved | CLKDIV | Reserved | SOFT | FREE | |
| R-0 | R-n ^(A) | R-0 | R-0 | R-0 | R-0 |

LEGEND: R/W = Read/Write; R = Read only; -n = value after reset

(A) The reset value of this field is based on the ratio of the CPU clock to the timer internal clock. To determine what this ratio is for your device, see the device-specific data manual.

Table 5-2 Emulation Management and Clock Speed Register Bit Descriptions

| Bit | Field | Description |
|-------------------------|----------|---|
| 31-20 | Reserved | Reserved. The reserved bit location is always read as 0. A value written to this field has no effect. |
| 19-16 | CLKDIV | Clock divide-down ratio bits. Defines the ratio of the CPU clock to the timer input clock. The CLKDIV bits are read-only bits. 1h = Internal clock source for the timer is the CPU clock divided by 1. 2h = Internal clock source for the timer is the CPU clock divided by 2. 3h = Reserved 4h = Internal clock source for the timer is the CPU clock divided by 4. 5h = Reserved 6h = Internal clock source for the timer is the CPU clock divided by 6. 7h = Reserved 8h = Internal clock source for the timer is the CPU clock divided by 8. 9h-15h = Reserved |
| 15-2 | Reserved | Reserved. The reserved bit location is always read as 0. A value written to this field has no effect. |
| 1 | SOFT | Used in conjunction with FREE bit to determine how the timer responds to an emulation suspend event. When the FREE bit is 0, the SOFT bit selects the timer response. 0 = The timer stops immediately. 1 = The timer stops when the timer counter register increments and reaches the value in the timer |
| 0 | FREE | Used in conjunction with SOFT bit to determine how the timer responds to an emulation suspend event. When the FREE bit is 0, the SOFT bit selects the timer response. 0 = The SOFT bit selects the timer response. 1 = The timer runs free, regardless of the value of the SOFT bit. |
| End of Table 5-2 | | |

5.3 Timer Counter Registers (CNTHI and CNTLO)

The timer counter registers (CNTLO and CNTHI) are 32-bit-wide registers that can be used in conjunction to form a 64-bit counter, or separately as 32-bit counters. The use of these registers depends on the configuration of the timer. In the 64-bit general-purpose timer mode and watchdog mode, the two registers work as a single 64-bit counter (see [Figure 5-2](#)). The 64-bit counter increments when the timer is enabled to count. The timer counter registers are cleared to 0 at reset. These two registers are shown in [Figure 5-3](#) and described in [Table 5-3](#) and are accessed via a separate address.

In a dual 32-bit timer mode, the counter registers work as separate 32-bit registers. These two register pairs can be configured as chained or unchained.

A hardware reset clears both counter registers, but software resets do not affect them. When the TIMLORS bit is cleared, CNTLO keeps its current value, and when the TIMHIRS bit is cleared, CNTHI keeps its current value.

Figure 5-2 64-Bit Timer Counter Register (CNTHI and CNTLO)

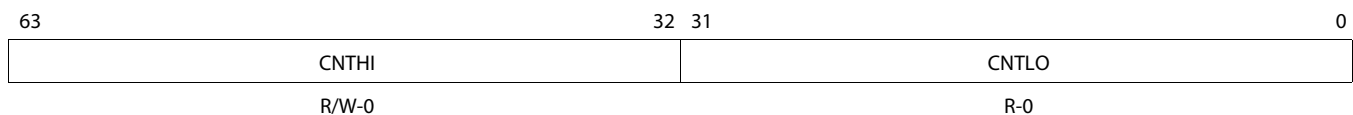

LEGEND: R/W = Read/Write; -n = value after reset

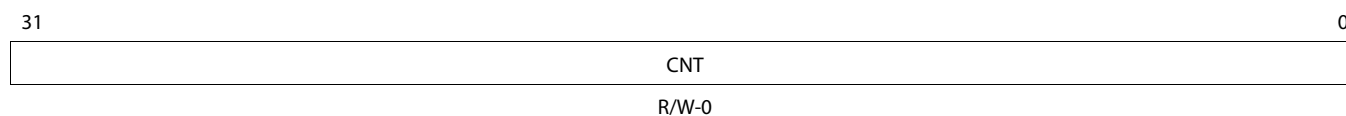
Figure 5-3 32-bit Timer Counter Registers - CNTHI and CNTLO

LEGEND: R/W = Read/Write; -n = value after reset

Table 5-3 Timer Counter Registers (CNTHI and CNTLO) Field Descriptions

| Bit | Field | Description |
|-------------------------|-------|---|
| 31-0 | CNT | Value = 00000000h - FFFFFFFFh Counter register. This register is a 32-bit prescale counter or 32-bit timer counter, or one half of a 64-bit timer counter. |
| End of Table 5-3 | | |

5.4 Timer Period Registers (PRDHI and PRDLO)

The timer period registers (PRDLO and PRDHI) are 32-bit-wide registers which can be used in conjunction to form a single 64-bit period register (Figure 5-4) or separately as 32-bit period registers. These two registers have the field shown in Figure 5-5 and described in Table 5-4 and are accessed via a separate address.

In a 64-bit general-purpose timer mode and watchdog mode, all 64 period bits contain the number of timer input clock cycles to count. This number controls the frequency of the timer output. In a 32-bit dual timer mode, the period registers work as separate 32-bit registers.

These two registers are used in conjunction with the two counter-registers, CNTHI and CNTLO.

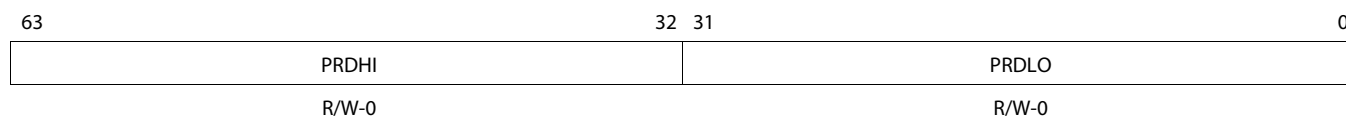
Figure 5-4 64-Bit Timer Period Register (PRDHI and PRDLO)

LEGEND: R/W = Read/Write; -n = value after reset

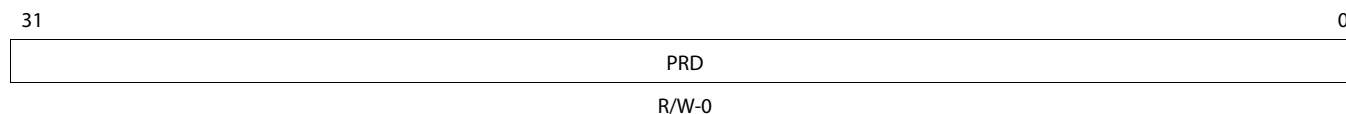
Figure 5-5 32-bit Timer Period Registers - PRDHI and PRDLO

LEGEND: R/W = Read/Write; -n = value after reset

Table 5-4 Timer Period Registers (PRDHI and PRDLO) Field Descriptions

| Bit | Field | Description |
|-------------------------|-------|--|
| 31-0 | PRD | Value = 00000000h - FFFFFFFFh Period register. This register contains the full timer period for a 32-bit timer configuration or half the timer period for a 64-bit timer configuration. |
| End of Table 5-4 | | |

5.5 Timer Control Register (TCR)

The timer control register (TCR) is shown in Figure 5-6 and described in Table 5-5. The lower 16 bits of the TCR determine the operating mode and monitor the status of TIMLO, as well as control the function of TINPL and TOUTL. The upper 16 bits determine the operating mode and monitor the status of TIMHI. The upper 16 bits of the TCR are used only when the timer is configured in dual 32-bit timers unchained mode (TIMMODE = 01b in TGCR).

Figure 5-6 Timer Control Register (TCR)

| | | | | | | | | | | | | | | | |
|------------|--|--|---------------|----|-------|--|-----------|------------|--|----------------|----------------|------------|----|-----------|----|
| 31 | | | | | | | | | | | 27 | 26 | 25 | 24 | |
| Reserved | | | | | | | | | | | READRSTMODE_HI | Reserved | | | |
| R-0 | | | | | | | | | | | R/W-0 | R-0 | | | |
| 23 | | | 22 | 21 | | | 20 | 19 | | | 18 | | | 17 | 16 |
| ENAMODE_HI | | | PWID_HI | | CP_HI | | Reserved | | | | | INVOUTP_HI | | TSTAT_HI | |
| R/W-0 | | | R/W-0 | | R/W-0 | | R-0 | | | | | R/W-0 | | R-0 | |
| 15 | | | 14 | 13 | | | 12 | 11 | | | 10 | | | 9 | 8 |
| Reserved | | | CAPEVTMODE_LO | | | | | CAPMODE_LO | | READRSTMODE_LO | | TIEN_LO | | CLKSRC_LO | |
| R-0 | | | R/W-0 | | | | | R/W-0 | | R/W-0 | | R/W-0 | | R/W-0 | |
| 7 | | | 6 | 5 | | | 4 | 3 | | | 2 | | | 1 | 0 |
| ENAMODE_LO | | | PWID_LO | | CP_LO | | INVINP_LO | | | | | INVOUTP_LO | | TSTAT_LO | |
| R/W-0 | | | R/W-0 | | R/W-0 | | R/W-0 | | | | | R/W-0 | | R-0 | |

LEGEND: R/W = Read/Write; R = Read only; -n = value after reset

Table 5-5 Timer Control Register (TCR) Field Descriptions (Part 1 of 3)

| Bit | Field | Description |
|-------|----------------|---|
| 31-27 | Reserved | Reserved. The reserved bit location is always read as 0. |
| 26 | READRSTMODE_HI | Read reset mode enable bit. Determines the effect of a timer counter read on CNTHI. Read reset mode is only available in dual 32-bit unchained. Output events (interrupt/EDMA/other) are not generated when read reset occurs. 0 = There is no effect when timer counter register CNTHI is read. 1 = Timer counter is reset when timer counter register CNTHI is read. |
| 25-24 | Reserved | Reserved. The reserved bit location is always read as 0. |
| 23-22 | ENAMODE_HI | A value written to this Enabling mode bits determine the timer mode for TIMHI. 00b = The timer is disabled (not counting) and maintains the current value. 01b = The timer is enabled one time. The timer stops after the timer counter reaches the timer period. 01b = The timer is enabled continuously. The timer counter increments until it reaches the timer period. One timer clock cycle later, the timer counter is reset to 0 and continues counting. 11b = The timer is enabled continuously. The timer counter increments until it reaches the timer period. One timer clock cycle later, the timer counter is reset to 0, the period registers (PRDHI and PRDLO) reload with the reload registers (RELHI and RELLO) and continues counting when TIMMODE is either set to 00b (64-bit timer mode) or 01b(32-bit timers unchained mode). |

Table 5-5 Timer Control Register (TCR) Field Descriptions (Part 2 of 3)

| Bit | Field | Description |
|-------|----------------|--|
| 21-20 | PWID_HI | Pulse width bits for TIMHI. PWID_HI is only used in pulse mode (CP_HI = 0). PWID_HI controls the width of the timer output signal. The polarity of the pulse is controlled by the INVOUTP_HI bit. The timer output signal is recorded in the TSTAT_HI bit and can be made visible on the timer output pin. 00b = The pulse width is 1 timer clock cycle. 01b = The pulse width is 2 timer clock cycles. 01b = The pulse width is 3 timer clock cycles. 11b = The pulse width is 4 timer clock cycles. |
| 19 | CP_HI | Clock/pulse mode bit for TIMHI. In the watchdog timer mode (TIMMODE = 10b), the pulse mode is selected automatically and the CP_HI bit is a don't care. 0 = Pulse mode. When the timer counter reaches the timer period, the timer output appears as a pulse with the width defined by the PWID_HI bits and the polarity defined by the INVOUTP_HI bits. 1 = Clock mode. The timer output signal has a 50% duty cycle signal. When the timer counter reaches the timer period, the level of the timer output signal is toggled (from high to low or from low to high). |
| 18 | Reserved | Reserved. The reserved bit location is always read as 0. A value written to this field has no effect. |
| 17 | INVOUTP_HI | Timer output inverter control bit for TIMHI. 0 = The timer output is not inverted. 1 = The timer output is inverted. |
| 16 | TSTAT_HI | Timer status bit for TIMHI. This is a read-only bit that shows the value of the timer output. 0 = Timer output is low. 1 = Timer output is high. |
| 15-14 | Reserved | The reserved bit location is always read as 0. A value written to this field has no effect. |
| 13-12 | CAPEVTMODE_LO | Capture event mode. Uses these bits to specify the type of event for Capture mode. 00b= Event occurs on timer input rising edge. 01b= Event occurs on time input falling edge. 10b= Event occurs on both rising and falling edges. 11b= Reserved |
| 11 | CAPMODE_LO | Capture mode enable bit. Determines if external event can reset timer. Capture mode is only available in dual 32-bit unchained mode and when CLKSRC = 0 and ENAMODE = 10b or 11b. Output events (interrupt/EDMA/other) are generated when capture mode event occurs. 0 = Timer is not in capture mode. 1 = Timer is in capture mode. External event can reset timer. |
| 10 | READRSTMODE_LO | Read reset mode enable bit. Determines the effect of a timer counter read on CNTLO. Read reset mode is only available in dual 32-bit unchained. Output events (interrupt/EDMA/other) are not generated when read reset occurs. 0 = There is no effect when timer counter register CNTLO is read. 1 = Timer counter is reset when timer counter register CNTLO is read. |
| 9 | TIEN_LO | Timer input enable bit determines if the timer clock is gated by the timer input. Applicable only when CLKSRC_LO = 0. 0 = Timer clock is not gated by the timer input. 1 = Timer clock is gated by a high state of the timer input synchronized with the internal clock. Timer starts counting when timer input transitions from low to high. Timer stops counting when timer input transitions from high to low. |
| 8 | CLKSRC_LO | Clock source bit determines the clock source for the timer. 0 = The clock source is the internal clock. 1 = The clock source is the signal on the timer pin. |
| 7-6 | ENAMODE_LO | Enabling mode bits determine the timer mode. 00b = The timer is disabled (not counting) and maintains the current value. 01b = The timer is enabled one time. The timer stops after the timer counter reaches the timer period. 10b = The timer is enabled continuously. The timer counter increments until it reaches the timer period. One timer clock cycle later, the timer counter is reset to 0 and continues counting. 11b = The timer is enabled continuously. The timer counter increments until it reaches the timer period. One timer clock cycle later, the timer counter is reset to 0, the period registers (PRDHI and PRDLO) reload with the reload registers (RELHI and RELLO) and continues counting when TIMMODE is either set to 00b (64-bit timer mode) or 01b (32-bit timers unchained mode). |

Table 5-5 Timer Control Register (TCR) Field Descriptions (Part 3 of 3)

| Bit | Field | Description |
|-------------------------|------------|---|
| 5-4 | PWID_LO | Pulse width bits. PWID_LO is only used in pulse mode (CP_LO = 0). PWID_LO controls the width of the timer output signal. The polarity of the pulse is controlled by the INVOUTP_LO bit. The timer output signal is recorded in the TSTAT_LO bit and can be made visible on the timer output pin. 00b = The pulse width is 1 timer clock cycle. 01b = The pulse width is 2 timer clock cycles. 10b = The pulse width is 3 timer clock cycles. 11b = The pulse width is 4 timer clock cycles. |
| 3 | CP_LO | Clock/pulse mode bit for timer output. In the watchdog timer mode (TIMMODE = 10b), the pulse mode is selected automatically and the CP_LO bit is a don't care. 0 = Pulse mode. When the timer counter reaches the timer period, the timer output appears as a pulse with the width defined by the PWID_LO bits and the polarity defined by the INVOUTP_LO bits. 1 = Clock mode. The timer output signal has a 50% duty cycle signal. When the timer counter reaches the timer period, the level of the timer output signal is toggled (from high to low or from low to high). |
| 2 | INVINP_LO | Timer input inverter control bit. Only affects operation if CLKSRC_LO = 1. 0 = A non-inverted timer input drives the timer. 1 = An inverted timer input drives the timer. |
| 1 | INVOUTP_LO | Timer output inverter control bit. 0 = The timer output is not inverted. 1 = The timer output is inverted. |
| 0 | TSTAT_LO | Timer status bit. This is a read-only bit that shows the value of the timer output. TSTAT_LO drives the timer pin (TOUTL) when the pin is used as a timer output pin and may be inverted by setting INVOUTP_LO = 1. 0 = Timer output is low. 1 = Timer output is high. |
| End of Table 5-5 | | |

5.6 Timer Global Control Register (TGCR)

The timer global control register (TGCR) is shown in [Figure 5-7](#) and described in [Table 5-6](#). This register contains a field for selecting the operating mode of the timer (TIMMODE), timer reset bits (TIMHIRS and TIMLORS), and counters for TIMHI in the dual 32-bit timers unchained mode (TDDRHI and PSCHI).

Figure 5-7 Timer Global Control Register (TGCR)

| | | | | | | | | | | | | |
|----------|--------|----|-------|----|----------|---|--------|---------|---|---------|---------|---|
| 31 | 16 | 15 | 12 | 11 | 8 | 7 | 5 | 4 | 3 | 2 | 1 | 0 |
| Reserved | TDDRHI | | PSCHI | | Reserved | | PLUSEN | TIMMODE | | TIMHIRS | TIMLORS | |
| R/W-0 | R/W-0 | | R/W-0 | | R-0 | | R/W-0 | R/W-0 | | R/W-0 | R/W-0 | |

LEGEND: R/W = Read/Write; -n = value after reset

Table 5-6 Timer Global Control Register (TGCR) Field Descriptions

| Bit | Field | Description |
|-------|----------|---|
| 31-16 | Reserved | Reserved. The reserved bit location is always read as 0. |
| 15-12 | TDDRHI | Timer divide-down ratio bits. This field is the prescale counter for TIMHI in the dual 32-bit timers unchained mode (TIMMODE = 01b). When the timer is enabled, TDDRHI increments every timer clock cycle. The timer counter (CNTHI) increments on the cycle after the TDDRHI matches the value of PSCHI. TDDRHI resets to 0 and continues. If enabled one time, when CNTHI matches the PRDHI, the timer stops; if the timer is enabled continuously, CNTHI resets to 0 on the cycle after matching the PRDHI and the timer continues counting. The default value is 0000b. |
| 11-8 | PSCHI | Prescale period bits. This field specifies the prescale period for TIMHI in the dual 32-bit timers unchained mode (TIMMODE = 01b). The default value is 0000b. |
| 7-5 | Reserved | Reserved. The reserved bit location is always read as 0. A value written to this field has no effect. |
| 4 | PLUSEN | Enable Timer Plus features. 0 = Enable backward compatibility. Disable Timer Plus features (Timer Plus features are unavailable). 1 = Disable backward compatibility. Enable Timer Plus features (Timer Plus features are available). |
| 3-2 | TIMMODE | Timer mode bits determine the timer operating mode. 00b = The timer is in the 64-bit general-purpose timer mode. 01b = The timer is in the dual 32-bit timers unchained mode. 10b = The timer is in the 64-bit watchdog timer mode. 11b = The timer is in the dual 32-bit timers chained mode. |
| 1 | TIMHIRS | TIMHI reset bit. Note that in order for the timer to function properly in 64-bit general-purpose timer mode both the TIMHIRS and TIMLORS bits must be set to 1. If the timer is in the watchdog timer active state, changing this bit does not affect the timer. 0 = TIMHI is in reset. The TSTAT_HI bit of TCR is reset to 0. However, the counter register CNTHI keeps its current value. 1 = TIMHI is not in reset. TIMHI can be used as a 32-bit timer. |
| 0 | TIMLORS | TIMLO reset bit. Note that in order for the timer to function properly in 64-bit general-purpose timer mode both the TIMHIRS and TIMLORS bits must be set to 1. If the timer is in the watchdog timer active state, changing this bit does not affect the timer. 0 = TIMLO is in reset. The TSTAT_LO bit of TCR is reset to 0, and the timer output signal is in the high-impedance state. However, the counter register CNTLO keeps its current value. 1 = TIMLO is not in reset. TIMLO can be used as a 32-bit timer. |

End of Table 5-6

5.7 Watchdog Timer Control Register (WDTCR)

The watchdog timer control register (WDTCR) is shown in [Figure 5-8](#) and described in [Table 5-7](#). This register determines the state of the watchdog timer and monitors the watchdog timer status.

Figure 5-8 Watchdog Timer Control Register (WDTCR)

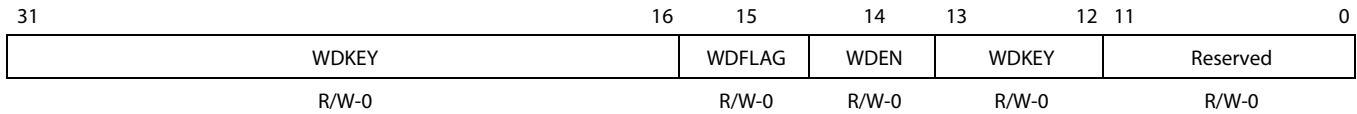

LEGEND: R/W = Read/Write; -n = value after reset

Table 5-7 Watchdog Timer Control Register (WDTCR) Field Descriptions

| Bit | Field | Description |
|-------------------------|----------|---|
| 31-16 | WDKEY | Value = 0000h - FFFFh Watchdog timer service key bits. Before a watchdog timeout event occurs, only a write sequence of a A5C6h followed by a DA7Eh services the watchdog timer. Any other write triggers a watchdog timeout event immediately. The default value of WDKEY is 0000h. WDKEY is not applicable in the general-purpose timer mode. |
| 15 | WDFLAG | Watchdog timer flag bit. WDFLAG is cleared when the watchdog timer is moved to the active state, when a hardware reset occurs, and when 1 is written to WDFLAG. 0 = No watchdog timer timeout event occurred. 1 = Watchdog timer timeout event occurred. |
| 14 | WDEN | Watchdog timer enable bit. WDEN must be set to move the watchdog timer to the pre-active state (see Figure 4-2). 0 = Watchdog timer is disabled. Watchdog timer output pin is disconnected from the watchdog timer timeout event, and the timer counter starts to count. The timer is in the general-purpose timer mode. 1 = Watchdog timer is enabled. The watchdog timer output pin is connected to the watchdog timeout event. The watchdog timer can be disabled by a watchdog timeout event or by a hardware reset. |
| 13-12 | WDKEY | Value = 00b - 11b Watchdog idle enable key bits. A write sequence of 01b followed by 10b is required before the watchdog timer can enter the idle mode. Writing 00b to WDKEY prevents the watchdog timer from entering the idle mode. WDKEY is not applicable in the general-purpose timer mode. |
| 11-0 | Reserved | Reserved. The reserved bit location is always read as 0. A value written to this field has no effect. |
| End of Table 5-7 | | |

5.8 Timer Reload Registers (RELHI and RELLO)

The timer reload registers (RELLO and RELHI) are 32-bit-wide registers which can be used in conjunction to form a single 64-bit reload register (Figure 5-9) or separately as 32-bit reload registers. These two registers have the field shown in Figure 5-10 and described in Table 5-8 and are accessed via a separate address.

These two registers are used in conjunction with the two counter-registers, CNTHI and CNTLO.

Figure 5-9 64-Bit Timer Reload Register (RELHI and RELLO)

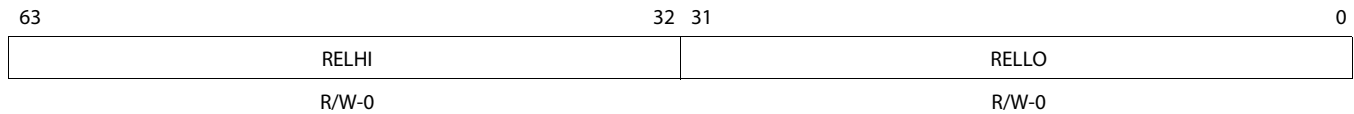

LEGEND: R/W = Read/Write; -n = value after reset

Figure 5-10 32-bit Timer Reload Registers -RELHI and RELLO

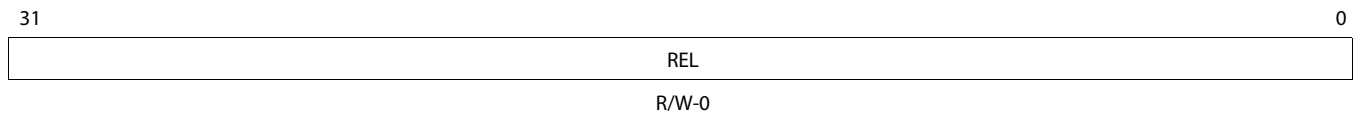

LEGEND: R/W = Read/Write; -n = value after reset

Table 5-8 Timer Reload Registers (RELHI and RELLO) Field Descriptions

| Bit | Field | Description |
|-------------------------|-------|--|
| 31-0 | REL | Value = 00000000h - FFFFFFFFh Reload register. This register contains the full timer reload for a 32-bit timer configuration or half the timer reload for a 64-bit timer configuration. |
| End of Table 5-8 | | |

5.9 Timer Capture Registers (CAPHI and CAPLO)

The timer capture registers (CAPLO and CAPHI) are 32-bit-wide registers which can be used to store the timer counter bits. When the timer has a timeout (due to external event or read of counter register) the value of CNTHI and CNTLO registers are copied onto the CAPHI and CAPLO registers. These two registers have the field shown in [Figure 5-12](#) and described in [Table 5-9](#) and are accessed via a separate address.

These two registers are used in conjunction with the two counter-registers, CNTHI and CNTLO.

Figure 5-11 64-Bit Timer Capture Register (CAPHI and CAPLO)

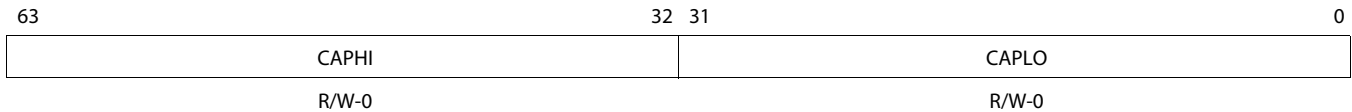

LEGEND: R/W = Read/Write; -n = value after reset

Figure 5-12 32-bit Timer Capture Registers - CAPHI and CAPLO

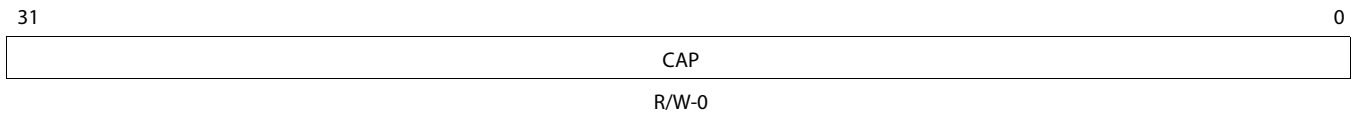

LEGEND: R/W = Read/Write; -n = value after reset

Table 5-9 Timer Capture Registers (CAPHI and CAPLO) Field Descriptions

| Bit | Field | Description |
|-------------------------|-------|---|
| 31-0 | CAP | Value = 00000000h - FFFFFFFFh Capture register. Captured timer counter bits. |
| End of Table 5-9 | | |

5.10 Timer Interrupt Control and Status Register (INTCTLSTAT)

The timer interrupt control and status register (INTCTLSTAT) is shown in [Figure 5-13](#) and described in [Table 5-10](#).

Figure 5-13 Timer Interrupt Control and Status Register (INTCTLSTAT)

| | | | | | |
|----------|----|---------------|-------------|---------------|-------------|
| 31 | 20 | 19 | 18 | 17 | 16 |
| Reserved | | EVTINTSTAT_HI | EVTINTEN_HI | PRDINTSTAT_HI | PRDINTEN_HI |
| R-0 | | R/W1C-0 | R/W-0 | R/W1C-0 | R/W-0 |
| 15 | 4 | 3 | 2 | 1 | 0 |
| Reserved | | EVTINTSTAT_LO | EVTINTEN_LO | PRDINTSTAT_LO | PRDINTEN_LO |
| R-0 | | R/W1C-0 | R/W-0 | R/W1C-0 | R/W-0 |

LEGEND: R/W = Read/Write; R/W1C = Read/Write 1 to clear bit; R = Read only; -n = value after reset

Table 5-10 Timer Interrupt Control and Status Register (INTCTLSTAT) Field Descriptions

| Bit | Field | Description |
|--------------------------|---------------|---|
| 31-20 | Reserved | Reserved. The reserved bit location is always read as 0. |
| 19 | EVTINTSTAT_HI | Interrupt status which reflects the condition that an external event caused a timeout when timer is in capture mode. Write a 1 to clear this bit. 0 = Interrupt has not occurred. 1 = Interrupt has occurred. |
| 18 | EVTINTEN_HI | Enables the interrupt generation when timer is in capture mode. 0 = Disable interrupt when in event capture mode. 1 = Enable interrupt when in event capture mode. |
| 17 | PRDINTSTAT_HI | Interrupt status which reflects the condition that timer counter matched the period register when timer is enabled. Write a 1 to clear this bit. 0 = Interrupt has not occurred. 1 = Interrupt has occurred. |
| 16 | PRDINTEN_HI | Enable interrupt generation when timer is enabled in 64-bit/32-bit chained/unchained/watchdog modes. 0 = Disable interrupt. 1 = Enable interrupt. |
| 15-4 | Reserved | Reserved. The reserved bit location is always read as 0. |
| 3 | EVTINTSTAT_LO | Interrupt status which reflects the condition that an external event caused a timeout when timer is in capture mode. Write a 1 to clear this bit. 0 = Interrupt has not occurred. 1 = Interrupt has occurred. |
| 2 | EVTINTEN_LO | Enables the interrupt generation when timer is in capture mode. 0 = Disable interrupt when in event capture mode. 1 = Enable interrupt when in event capture mode. |
| 1 | PRDINTSTAT_LO | Interrupt status which reflects the condition that timer counter matched the period register when timer is enabled. Write a 1 to clear this bit. 0 = Interrupt has not occurred. 1 = Interrupt has occurred. |
| 0 | PRDINTEN_LO | Enable interrupt generation when timer is enabled in 64-bit/32-bit chained/unchained/watchdog modes. 0 = Disable interrupt. 1 = Enable interrupt. |
| End of Table 5-10 | | |

IMPORTANT NOTICE

Texas Instruments Incorporated and its subsidiaries (TI) reserve the right to make corrections, modifications, enhancements, improvements, and other changes to its products and services at any time and to discontinue any product or service without notice. Customers should obtain the latest relevant information before placing orders and should verify that such information is current and complete. All products are sold subject to TI's terms and conditions of sale supplied at the time of order acknowledgment.

TI warrants performance of its hardware products to the specifications applicable at the time of sale in accordance with TI's standard warranty. Testing and other quality control techniques are used to the extent TI deems necessary to support this warranty. Except where mandated by government requirements, testing of all parameters of each product is not necessarily performed.

TI assumes no liability for applications assistance or customer product design. Customers are responsible for their products and applications using TI components. To minimize the risks associated with customer products and applications, customers should provide adequate design and operating safeguards.

TI does not warrant or represent that any license, either express or implied, is granted under any TI patent right, copyright, mask work right, or other TI intellectual property right relating to any combination, machine, or process in which TI products or services are used. Information published by TI regarding third-party products or services does not constitute a license from TI to use such products or services or a warranty or endorsement thereof. Use of such information may require a license from a third party under the patents or other intellectual property of the third party, or a license from TI under the patents or other intellectual property of TI.

Reproduction of TI information in TI data books or data sheets is permissible only if reproduction is without alteration and is accompanied by all associated warranties, conditions, limitations, and notices. Reproduction of this information with alteration is an unfair and deceptive business practice. TI is not responsible or liable for such altered documentation. Information of third parties may be subject to additional restrictions.

Resale of TI products or services with statements different from or beyond the parameters stated by TI for that product or service voids all express and any implied warranties for the associated TI product or service and is an unfair and deceptive business practice. TI is not responsible or liable for any such statements.

TI products are not authorized for use in safety-critical applications (such as life support) where a failure of the TI product would reasonably be expected to cause severe personal injury or death, unless officers of the parties have executed an agreement specifically governing such use. Buyers represent that they have all necessary expertise in the safety and regulatory ramifications of their applications, and acknowledge and agree that they are solely responsible for all legal, regulatory and safety-related requirements concerning their products and any use of TI products in such safety-critical applications, notwithstanding any applications-related information or support that may be provided by TI. Further, Buyers must fully indemnify TI and its representatives against any damages arising out of the use of TI products in such safety-critical applications.

TI products are neither designed nor intended for use in military/aerospace applications or environments unless the TI products are specifically designated by TI as military-grade or "enhanced plastic." Only products designated by TI as military-grade meet military specifications. Buyers acknowledge and agree that any such use of TI products which TI has not designated as military-grade is solely at the Buyer's risk, and that they are solely responsible for compliance with all legal and regulatory requirements in connection with such use.

TI products are neither designed nor intended for use in automotive applications or environments unless the specific TI products are designated by TI as compliant with ISO/TS 16949 requirements. Buyers acknowledge and agree that, if they use any non-designated products in automotive applications, TI will not be responsible for any failure to meet such requirements.

Following are URLs where you can obtain information on other Texas Instruments products and application solutions:

Products

| | |
|------------------------|--|
| Audio | www.ti.com/audio |
| Amplifiers | amplifier.ti.com |
| Data Converters | dataconverter.ti.com |
| DLP® Products | www.dlp.com |
| DSP | dsp.ti.com |
| Clocks and Timers | www.ti.com/clocks |
| Interface | interface.ti.com |
| Logic | logic.ti.com |
| Power Mgmt | power.ti.com |
| Microcontrollers | microcontroller.ti.com |
| RFID | www.ti-rfid.com |
| OMAP Mobile Processors | www.ti.com/omap |
| Wireless Connectivity | www.ti.com/wirelessconnectivity |

Applications

| | |
|-------------------------------|--|
| Automotive and Transportation | www.ti.com/automotive |
| Communications and Telecom | www.ti.com/communications |
| Computers and Peripherals | www.ti.com/computers |
| Consumer Electronics | www.ti.com/consumer-apps |
| Energy and Lighting | www.ti.com/energy |
| Industrial | www.ti.com/industrial |
| Medical | www.ti.com/medical |
| Security | www.ti.com/security |
| Space, Avionics and Defense | www.ti.com/space-avionics-defense |
| Video and Imaging | www.ti.com/video |

TI E2E Community Home Page

e2e.ti.com

Mailing Address: Texas Instruments, Post Office Box 655303, Dallas, Texas 75265
Copyright © 2012, Texas Instruments Incorporated