

CC335xMOD SimpleLink™ 2.4GHz and 5GHz Dual-Band Wi-Fi 6 and Bluetooth® Low Energy Companion Module

1 Features

Key Features

- Wi-Fi 6 (802.11ax)
- Bluetooth® Low Energy 5.4 in CC33x1MOD
- Companion module to any processor or MCU host capable of running a TCP/IP stack
- Integrated 2.4GHz and 5GHz PA for a complete wireless system with up to +18.3dBm output power
- Operating temperature: –40°C to +85°C
- Application throughput up to 50Mbps
- Regulatory Certification
 - FCC: Z64-CC33DBMOD
 - IC/ISED: 4511-CC33DBMOD
 - ETSI/CE
 - MIC (TELEC): 201-250530 (Test Grade: 51), 201-250531 (Test Grade: 50)
- Based on CC3351 QuickTrack Qualified chipset
- Bluetooth Controller Subsystem Qualified

Extended Features

- Wi-Fi 6
 - 2.4GHz and 5GHz, 20MHz, single spatial stream
 - MAC, baseband, and RF transceiver with support for IEEE 802.11 a/b/g/n/ax
 - Target wake time (TWT), OFDMA, MU-MIMO (downlink), Basic Service Set Coloring, and trigger-based transmission for improved efficiency
 - Hardware-based encryption and decryption supporting WPA2 and WPA3
 - Excellent interoperability
 - Support for 4-bit SDIO or SPI host interfaces
- Bluetooth Low Energy 5.4
 - LE Coded PHYs (long range), LE 2M PHY (high speed), and Advertising Extension
 - Host controller interface (HCI) transport with an option for UART or shared SDIO
 - Internal coexistence mechanism with Wi-Fi to share the same RF chains and antenna
- Enhanced Security
 - Secured host interface
 - Firmware authentication
 - Anti-rollback protection
- Multirole support (for example, concurrent STA and AP) to connect with Wi-Fi devices on different RF channels (Wi-Fi networks)
- Optional antenna diversity or selection

- 3-wire or 1-wire PTA for external coexistence with additional 2.4GHz radios (for example, Thread or Zigbee)
- Clock sources
 - 40MHz XTAL fast clock (Integrated into the module)
 - Internal slow clock or external 32.768kHz slow clock
- Small package size
 - Easy to design with 65-pin, 11mm × 11mm LGA package, 0.65mm pitch

2 Applications

- [Grid infrastructure](#)
 - [Electricity meter](#)
 - [String inverter](#)
 - [Microinverter](#)
 - [Energy storage power conversion system \(PCS\)](#)
 - [EV charging infrastructure](#)
- [Building and home automation](#)
 - [HVAC controller](#)
 - [HVAC gateway](#)
 - [Thermostat](#)
 - [Building security gateway](#)
 - [Garage door system](#)
 - [IP network camera](#) and [video doorbell](#)
 - [Wireless security camera](#)
- [Appliances](#)
 - [Refrigerator and freezer](#)
 - [Oven](#)
 - [Washer and dryer](#)
 - [Residential water heater and heating system](#)
 - [Air purifier and humidifier](#)
 - [Coffee machine](#)
 - [Air conditioner indoor unit](#)
 - [Vacuum robot](#)
 - [Robotic lawn mower](#)
- [Medical](#)
 - [Infusion pump](#)
 - [Electronic hospital bed and bed control](#)
 - [Multiparameter patient monitor](#)
 - [Blood pressure monitor](#)
 - [CPAP machine](#)
 - [Telehealth systems](#)
 - [Ultrasound scanner](#)
 - [Ultrasound smart probe](#)
 - [Electric toothbrush](#)
- [Retail Automation and Payment](#)
- [Printers](#)



3 Description

The SimpleLink™ Wi-Fi CC33xx family of devices is where affordability meets reliability, enabling engineers to connect more applications with confidence. CC335xMOD devices are certified modules designed to simplify hardware design and reduce time-to-market.

- CC3350MOD: A 2.4GHz and 5GHz Wi-Fi 6 companion module
- CC3351MOD: A 2.4GHz and 5GHz Wi-Fi 6 and Bluetooth Low Energy 5.4 companion module

The CC335xMOD offers the latest standards from Wi-Fi and Bluetooth Low Energy while maintaining compatibility with Wi-Fi 4 (802.11 a/b/g/n) and Wi-Fi 5 (802.11ac). These CC335xMOD devices are based on the 10th-generation connectivity combo chip from Texas Instruments. As such, the CC335xMOD is based on proven technology. These modules are an excellent choice to use in cost-sensitive embedded applications with a Linux or RTOS host running TCP/IP. CC335xMOD brings the efficiency of Wi-Fi 6 to embedded device applications for the Internet of Things (IoT).

Device Information

PART NUMBER ¹	Wi-Fi 2.4/5GHz SISO	BLUETOOTH LOW ENERGY
CC3350MODENIAMOZR	✓	
CC3351MODENIAMOZR	✓	✓

1. For more information, see the *Mechanical, Packaging, and Orderable* addendum.

4 Functional Block Diagrams

The diagram below shows the functional block diagram of the CC335xMOD module.

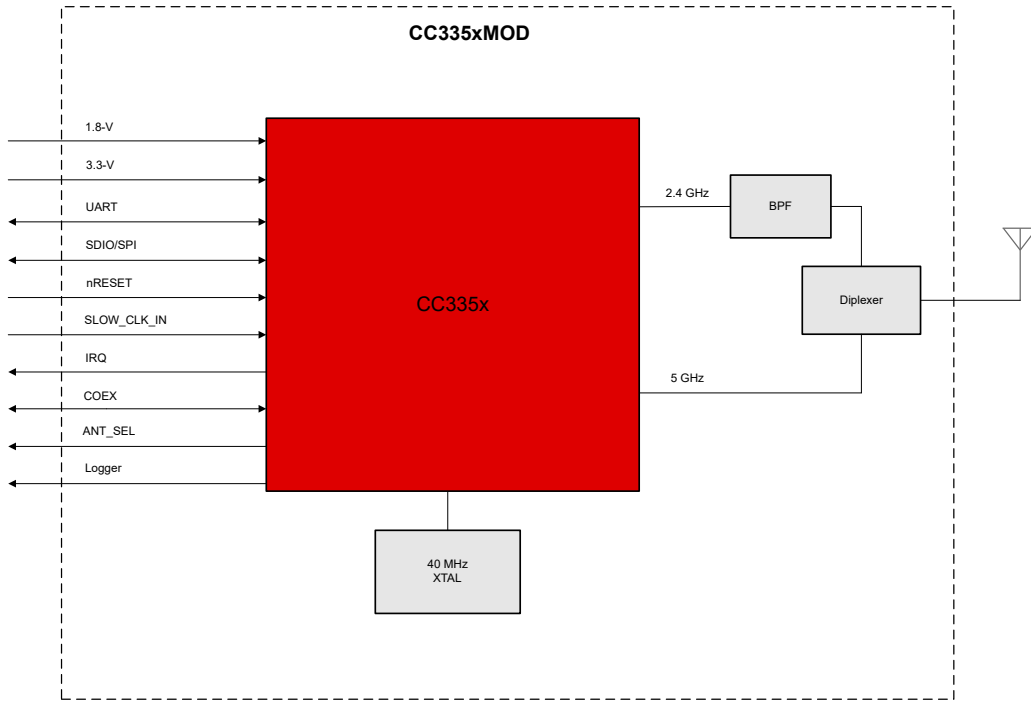

CC335xMOD Block Diagram

The diagram below shows a hardware overview of the CC335x IC used inside the CC335xMOD.

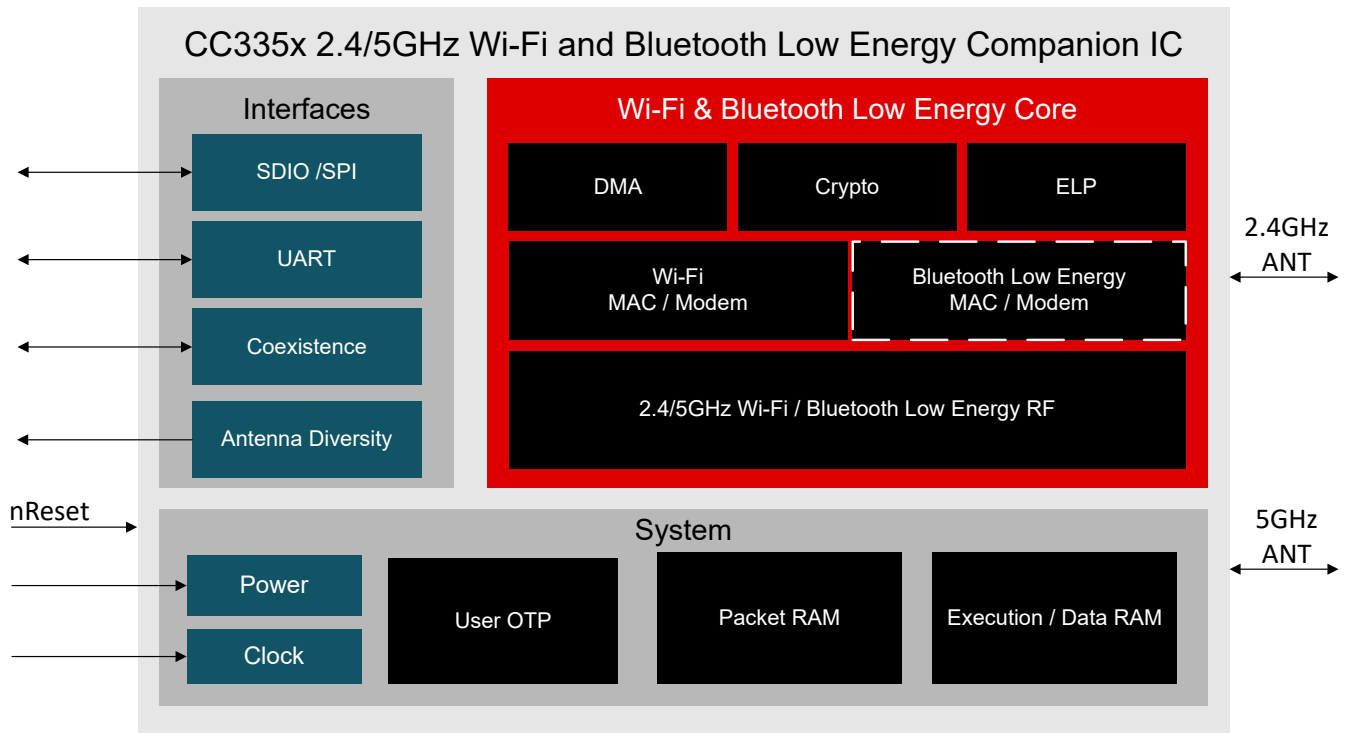

--- CC3351 only

CC335x Hardware Overview

Table of Contents

1 Features	1	6.17 Current Consumption: Device Modes.....	15
2 Applications	1	6.18 Timing and Switching Characteristics.....	15
3 Description	2	6.19 Interface Timing Characteristics.....	17
4 Functional Block Diagrams	3	7 Detailed Description	22
5 Pin Configuration and Functions	5	7.1 WLAN Features.....	22
5.1 Pin Diagram.....	5	7.2 Bluetooth Low Energy Features.....	22
5.2 Pin Descriptions.....	6	8 Device Certification	23
6 Specifications	9	8.1 FCC Certification and Statement.....	23
6.1 Absolute Maximum Ratings.....	9	8.2 IC/ISED Certification and Statement.....	24
6.2 ESD Ratings.....	9	8.3 ETSI/CE.....	24
6.3 Recommended Operating Conditions.....	9	8.4 MIC Certification.....	24
6.4 Electrical Characteristics.....	9	8.5 Manual Information to the End User.....	24
6.5 WLAN Performance: 2.4GHz Receiver Characteristics.....	9	8.6 Module Markings.....	25
6.6 WLAN Performance: 2.4GHz Transmitter Power.....	10	9 Application Information	27
6.7 WLAN Performance: 5GHz Receiver Characteristics.....	10	9.1 Applications, Implementation, and Layout.....	27
6.8 WLAN Performance: 5GHz Transmitter Power.....	11	9.2 Typical Application—CC335xMOD Reference Design.....	27
6.9 Bluetooth Low Energy Performance: Receiver Characteristics.....	11	9.3 Design Recommendations.....	27
6.10 Bluetooth Low Energy Performance: Transmitter Characteristics.....	13	9.4 Baking and SMT Recommendations.....	30
6.11 Current Consumption: 2.4GHz WLAN Static Modes.....	13	10 Device and Documentation Support	31
6.12 Current Consumption: 5GHz WLAN Static Modes.....	14	10.1 Third-Party Products Disclaimer.....	31
6.13 Current Consumption: 2.4GHz WLAN Use Cases.....	14	10.2 Device Nomenclature Boilerplate.....	31
6.14 Current Consumption: 5GHz WLAN Use Cases.....	14	10.3 Tools and Software.....	32
6.15 Current Consumption: Bluetooth Low Energy Static Modes.....	15	10.4 Documentation Support.....	32
6.16 Current Consumption: Bluetooth Low Energy Use Cases.....	15	10.5 Support Resources.....	33
		10.6 Trademarks.....	33
		10.7 Electrostatic Discharge Caution.....	33
		10.8 Glossary.....	33
		11 Revision History	33
		12 Mechanical, Packaging, and Orderable Information	34

5 Pin Configuration and Functions

5.1 Pin Diagram

Figure 5-1 shows pin assignments for the 65-pin LGA package.

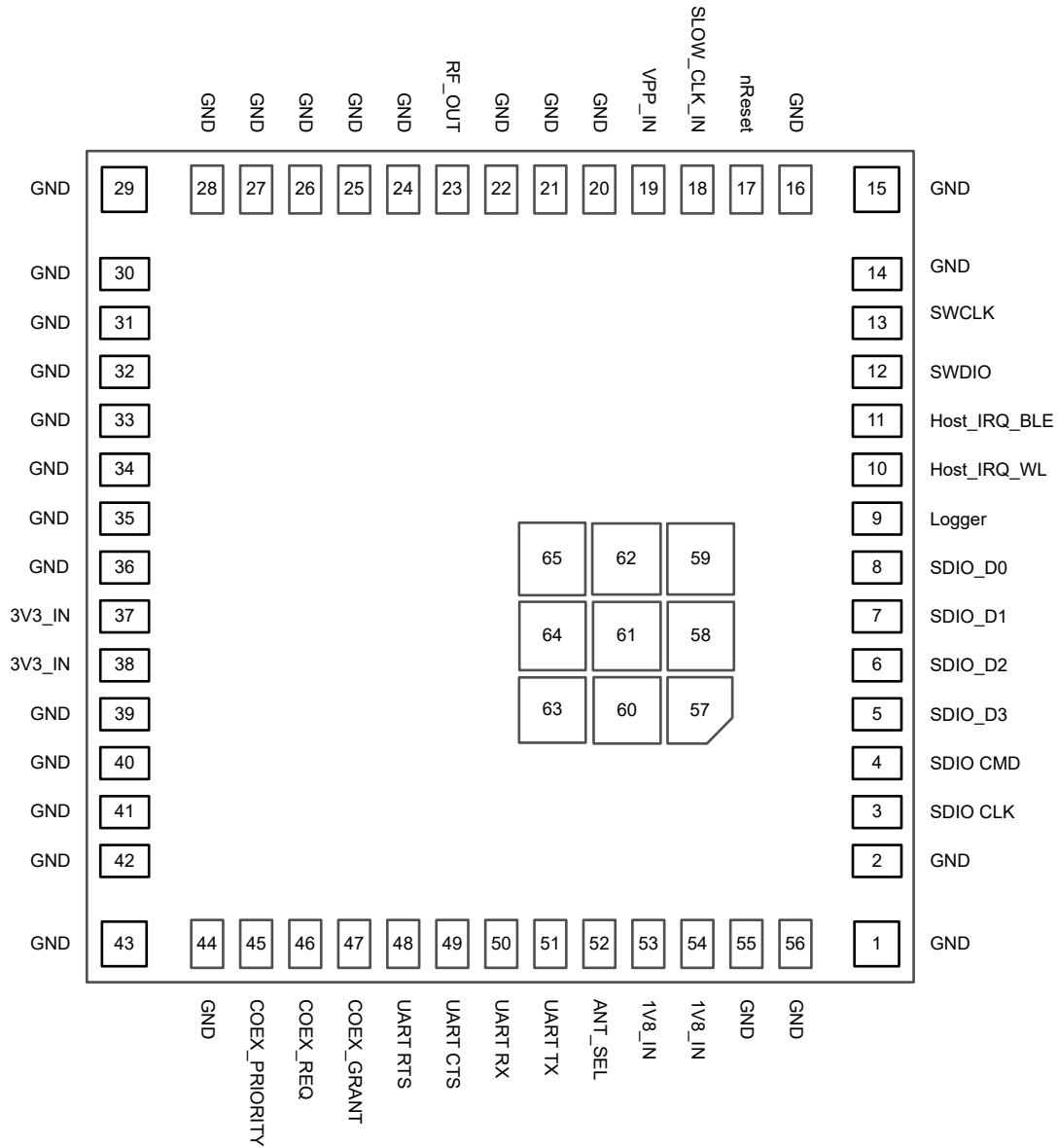

Figure 5-1. CC3351MOD Pin Diagram (Top View)

5.2 Pin Descriptions

Table 5-1. Pin Descriptions

PIN	SIGNAL NAME	TYPE	DIR (I/O)	VOLTAGE LEVEL	SHUTDOWN STATE	STATE AFTER POWER-UP	DESCRIPTION
1	GND	GND					GND
2	GND	GND					GND
3	SDIO CLK	Digital	I	1.8V	HiZ	HiZ	SDIO clock or SPI clock
4	SDIO CMD	Digital	I/O	1.8V	HiZ	HiZ	SDIO command or SPI PICO
5	SDIO_D3	Digital	I/O	1.8V	HiZ	PU	SDIO data D3 or SPI CS
6	SDIO_D2	Digital	I/O	1.8V	HiZ	HiZ	SDIO data D2
7	SDIO_D1	Digital	I/O	1.8V	HiZ	HiZ	SDIO data D1
8	SDIO_D0	Digital	I/O	1.8V	HiZ	HiZ	SDIO data D0 or SPI POCI
9	Logger ³	Digital	O	1.8V	PU	PU	Tracer (UART TX debug logger)
10	Host_IRQ_WL ³	Digital	O	1.8V	PD	0	Interrupt request to host for WLAN
11	Host_IRQ_BLE	Digital	O	1.8V	PD	PD	Reserved for future use
12	SWDIO	Digital	I/O	1.8V	PU	PU	Serial wire debug I/O
13	SWCLK	Digital	I	1.8V	PD	PD	Serial wire debug clock
14	GND	GND					GND
15	GND	GND					GND
16	GND	GND					GND
17	nReset	Digital	I	1.8V	PD	PD	Reset line for enabling or disabling device (active low)
18	SLOW_CLK_IN	Digital	I	1.8V	PD	PD	32.768kHz RTC clock input
19	VPP_IN	POW					1.8V OTP programming input supply
20	GND	GND					GND
21	GND	GND					GND
22	GND	GND					GND
23	RF_OUT	RF	I/O				Bluetooth Low Energy and WLAN 2.4 and 5 GHz RF port
24	GND	GND					GND
25	GND	GND					GND
26	GND	GND					GND
27	GND	GND					GND
28	GND	GND					GND
29	GND	GND					GND
30	GND	GND					GND
31	GND	GND					GND
32	GND	GND					GND
33	GND	GND					GND

Table 5-1. Pin Descriptions (continued)

PIN	SIGNAL NAME	TYPE	DIR (I/O)	VOLTAGE LEVEL	SHUTDOWN STATE	STATE AFTER POWER-UP	DESCRIPTION
34	GND	GND					GND
35	GND	GND					GND
36	GND	GND					GND
37	3V3_IN	POW					VDD PA Voltage
38	3V3_IN	POW					VDD PA Voltage
39	GND	GND					GND
40	GND	GND					GND
41	GND	GND					GND
42	GND	GND					GND
43	GND	GND					GND
44	GND	GND					GND
45	COEX_PRIORITY ²	Digital	I	1.8V	PU	PU	External coexistence interface: priority
46	COEX_REQ ²	Digital	I	1.8V	PU	PU	External coexistence interface: request
47	COEX_GRANT ²	Digital	O	1.8V	PD	PD	External coexistence interface: grant
48	UART RTS	Digital	O	1.8V	PU	PU	Device RTS signal: flow control for Bluetooth Low Energy HCI
49	UART CTS	Digital	I	1.8V	PU	PU	Device CTS signal: flow control for Bluetooth Low Energy HCI
50	UART RX	Digital	I	1.8V	PU	PU	UART RX for Bluetooth Low Energy HCI
51	UART TX	Digital	O	1.8V	PU	PU	UART TX for Bluetooth Low Energy HCI
52	ANT_SEL ²	Digital	O	1.8V	PD	PD	Antenna select control line
53	1V8_IN	POW					Main supply voltage for analog and digital—VDD_MAIN_IN, VDDA_IN1, VDDA_IN2, VIO
54	1V8_IN	POW					Main supply voltage for analog and digital—VDD_MAIN_IN, VDDA_IN1, VDDA_IN2, VIO
55	GND	GND					GND
56	GND	GND					GND
57	GND	GND					GND
58	GND	GND					GND
59	GND	GND					GND
60	GND	GND					GND
61	GND	GND					GND

Table 5-1. Pin Descriptions (continued)

PIN	SIGNAL NAME	TYPE	DIR (I/O)	VOLTAGE LEVEL	SHUTDOWN STATE	STATE AFTER POWER-UP	DESCRIPTION
62	GND	GND					GND
63	GND	GND					GND
64	GND	GND					GND
65	GND	GND					GND

1. All digital I/Os (with the exception of SDIO signals) are Hi-Z when the device is in shutdown mode with internal PU/PD according to the "shutdown state" column.
2. See software release notes for support level.
3. Logger and Host_IRQ_WL pins are sensed by the device during boot, see [CC33xx Hardware Integration](#).

6 Specifications

All specifications are given at the module pins. Typical values are measured with nominal device at 25°C.

6.1 Absolute Maximum Ratings

Over operating free-air temperature range (unless otherwise noted)⁽¹⁾

PARAMETER		PINS	MIN	MAX	UNIT
1V8_IN	1.8-V Supply	53,54	-0.5	2.1	V
3V3_IN	3.3-V Supply	37,38	-0.5	4.2	V
	Input Voltage to all digital pins		-0.5	1V8_IN + 0.5	V
V _{PP}	VPP OTP Voltage	19	-0.5	2.1	V
T _A	Operating Ambient Temperature		-40	85	°C
T _{stg}	Storage temperature		-40	105	°C

- (1) Operation outside the Absolute Maximum Ratings may cause permanent device damage. Absolute Maximum Ratings do not imply functional operation of the device at these or any other conditions beyond those listed under Recommended Operating Conditions. If outside the Recommended Operating Conditions but within the Absolute Maximum Ratings, the device may not be fully functional, and this may affect device reliability, functionality, performance, and shorten the device lifetime.

6.2 ESD Ratings

				VALUE	UNIT
V _(ESD)	Electrostatic discharge	Human body model (HBM), per ANSI/ESDA/JEDEC JS-001 ^{(1) (3)}	RF pins	±1000	V
			Other pins	±2000	
		Charged device model (CDM), per ANSI/ESDA/JEDEC JS-002 ^{(2) (3)}	RF pins	±250	
			Other pins	±500	

- (1) JEDEC document JEP155 states that 500V HBM allows safe manufacturing with a standard ESD control process.
(2) JEDEC document JEP157 states that 250V CDM allows safe manufacturing with a standard ESD control process.
(3) ESD Rating is based on CC3351 IC Chipset.

6.3 Recommended Operating Conditions

PARAMETER		PINS	MIN	TYP	MAX	UNIT
1V8_IN	1.8-V Supply	53,54	1.62	1.8	1.98	V
3V3_IN	3.3-V Supply	37,38	2.97	3.3	3.63	
V _{PP}	DC supply rail for OTP memory	19	1.62	1.8	1.98	V
T _A	Operating ambient temperature		-40		85	°C
	Maximum power dissipation				2	W

6.4 Electrical Characteristics

PARAMETER	DESCRIPTION	TEST CONDITION	MIN	TYP	MAX	UNIT
V _{IH}	High Level Input Voltage		0.65 × V _{IO}		V _{IO}	V
V _{IL}	Low Level Input Voltage		0		0.35 × V _{IO}	
V _{OH}	High Level Output Voltage	at 4mA	V _{IO} - 0.45		V _{IO}	
V _{OL}	Low Level Output Voltage	at 4mA	0		0.45	

6.5 WLAN Performance: 2.4GHz Receiver Characteristics

PARAMETER	TEST CONDITIONS	MIN	TYP	MAX	UNIT
Operational Frequency Range		2412		2472	MHz

6.5 WLAN Performance: 2.4GHz Receiver Characteristics (continued)

PARAMETER	TEST CONDITIONS	MIN	TYP	MAX	UNIT
Sensitivity: 8% PER for 11b rates, 10% PER for 11g/n/ax rates	1Mbps DSSS		-96.1		dBm
	2Mbps DSSS		-93.7		
	11Mbps CCK		-88.2		
	6Mbps OFDM		-91.3		
	54Mbps OFDM		-73.6		
	HT MCS0 MM 4K		-91		
	HT MCS7 MM 4K		-71		
	HE MCS0 4K		-91.2		
	HE MCS7 4K		-72.2		
Maximum input level: 8% PER for 11b rates, 10% PER for 11g/n/ax rates	1 DSSS		0		dBm
	OFDM6, HT MCS0, HE MCS0		0		
	OFDM54, HT MCS7, HE MCS7		-9		
Adjacent Channel Rejection	1Mbps DSSS		45		dB
	11Mbps CCK		39		
	6Mbps OFDM		20		
	54Mbps OFDM		3		
	HT MCS0		20		
	HT MCS7		3		
	HE MCS0		16		
	HE MCS7		-1		
RSSI Accuracy	-90dBm to -30dBm	-3		3	dB

6.6 WLAN Performance: 2.4GHz Transmitter Power

PARAMETER	TEST CONDITIONS	MIN	TYP	MAX	UNIT
Operational Frequency Range ^{(1) (2)}		2412		2472	MHz
Maximum output power at 3V3_IN > 3.0V ^{(3) (4)}	1Mbps DSSS		17.9		dBm
	6Mbps OFDM		17.8		
	54Mbps OFDM		15.5		
	HT MCS0 MM		17.8		
	HT MCS7 MM		15.5		
	HE MCS0		17.8		
	HE MCS7		15.3		
Transmit center frequency accuracy		-25		25	ppm

(1) Channels 1 (2142 MHz) through 11 (2462 MHz) are supported for FCC.

(2) Channels 1 (2142 MHz) through 13 (2472MHz) are supported for Europe and Japan. Note that channel 14 is not supported for Japan.

(3) The 11g/n/ax low rates on edge channels (2412 and 2462 MHz) have reduced TX power to meet FCC emission limits.

(4) Power of 802.11b rates are reduced to meet ETSI requirements in Europe.

6.7 WLAN Performance: 5GHz Receiver Characteristics

PARAMETER	TEST CONDITIONS	MIN	TYP	MAX	UNIT
Operational Frequency Range		5180		5845	MHz

PARAMETER	TEST CONDITIONS	MIN	TYP	MAX	UNIT
Sensitivity: 10% PER for 11g/n/ax rates	6Mbps OFDM		-91.6		dBm
	54Mbps OFDM		-74.1		
	HT MCS0 MM 4K		-91.3		
	HT MCS7 MM 4K		-71.7		
	HE MCS0 4K		-91.3		
	HE MCS7 4K		-72.1		
Maximum input level: 10% PER for 11g/n/ax rates	OFDM6, HT MCS0, HE MCS0		-8.5		
	OFDM54, HT MCS7, HE MCS7		-17.5		
Adjacent Channel Rejection	6Mbps OFDM		20		dB
	54Mbps OFDM		3		
	HT MCS0		18		
	HT MCS7		0		
	HE MCS0		16		
	HE MCS7		-1		
RSSI Accuracy	-90dBm to -30dBm	-3		3	dB

6.8 WLAN Performance: 5GHz Transmitter Power

PARAMETER	TEST CONDITIONS	MIN	TYP	MAX	UNIT
Operational Frequency Range ^{(1) (2) (3)}		5180		5845	MHz
Maximum output power at 3V3_IN > 3.0V	6Mbps OFDM		18.3		dBm
	54Mbps OFDM		13.8		
	HT MCS0 MM		18.3		
	HT MCS7 MM		13.8		
	HE MCS0 20 MHz		18.3		
	HE MCS7 20 MHz		13.2		
Transmit center frequency accuracy		-20		20	ppm

- (1) FCC band covers U-NII-1, U-NII-2A, U-NII-2C, and U-NII-3 20MHz BW modulations
(2) Europe bands 1-4 20MHz BW modulations are supported.
(3) For Japan, W52, W53 and W56, 20MHz BW modulations are supported.

6.9 Bluetooth Low Energy Performance: Receiver Characteristics

PARAMETER	TEST CONDITION	MIN	TYP	MAX	UNIT
Bluetooth Low Energy 125Kbps (LE Coded) Receiver Characteristics					
Receiver sensitivity ⁽²⁾	PER <30.2%		-101.4		dBm
Receiver saturation	PER <30.2%		2		dBm
Co-channel rejection ⁽¹⁾	Wanted signal at -79dBm, modulated interferer in channel		10		dB
Selectivity, ±1MHz ⁽¹⁾	Wanted signal at -79dBm, modulated interferer at ±1MHz.		0 / 0		dB
Selectivity, ±2MHz ⁽¹⁾	Wanted signal at -79dBm, modulated interferer at ±2MHz.		-37 / -30		dB
Selectivity, ±3MHz ⁽¹⁾	Wanted signal at -79dBm, modulated interferer at ±3MHz.		-39 / -36		dB
Selectivity, ±4MHz ⁽¹⁾	Wanted signal at -79dBm, modulated interferer at ±4MHz.		-45 / -41		dB

6.9 Bluetooth Low Energy Performance: Receiver Characteristics (continued)

PARAMETER	TEST CONDITION	MIN	TYP	MAX	UNIT
RSSI Accuracy	Dynamic range of –90 to –20dBm	–4		4	dB
Bluetooth Low Energy 500Kbps (LE Coded) Receiver Characteristics					
Receiver sensitivity	PER <30.2%		–98.6		dBm
Receiver saturation	PER <30.2%		2		dBm
Co-channel rejection ⁽¹⁾	Wanted signal at –72dBm, modulated interferer in channel.		10		dB
Selectivity, ±1MHz ⁽¹⁾	Wanted signal at –72dBm, modulated interferer at ±1MHz.		0 / 0		dB
Selectivity, ±2MHz ⁽¹⁾	Wanted signal at –72dBm, modulated interferer at ±2MHz.	–35 / –25			dB
Selectivity, ±3MHz ⁽¹⁾	Wanted signal at –72dBm, modulated interferer at ±3MHz.	–40 / –37			dB
Selectivity, ±4MHz ⁽¹⁾	Wanted signal at –72dBm, modulated interferer at ±4MHz.	–45 / –40			dB
RSSI Accuracy	Dynamic range of –90 to –20dBm	–4		4	dB
Bluetooth Low Energy 1Mbps (LE 1M) Receiver Characteristics					
Receiver sensitivity ⁽³⁾	PER <30.2%, 37 byte packets		–97.2		dBm
Receiver sensitivity ⁽³⁾	PER <30.2%, 255 byte packets		–96		dBm
Receiver saturation	PER <30.2%		2		dBm
Co-channel rejection ⁽¹⁾	Wanted signal at –67dBm, modulated interferer in channel		10		dB
Selectivity, ±1MHz ⁽¹⁾	Wanted signal at –67dBm, modulated interferer at ±1MHz		0 / 0		dB
Selectivity, ±2MHz ⁽¹⁾	Wanted signal at –67dBm, modulated interferer at ±2MHz.	–35 / –28			dB
Selectivity, ±3MHz ⁽¹⁾	Wanted signal at –67dBm, modulated interferer at ±3MHz	–38 / –32			dB
Selectivity, ±4MHz ⁽¹⁾	Wanted signal at –67dBm, modulated interferer at ±4MHz	–45 / –40			dB
Out-of-band blocking	30MHz to 2000MHz, Wanted signal at –67dBm		–23		dBm
Out-of-band blocking	2003MHz to 2399MHz, Wanted signal at –67dBm		–30		dBm
Out-of-band blocking	2484 MHz to 2997 MHz, Wanted signal at –67dBm		–30		dBm
Out-of-band blocking	3000MHz to 6GHz, Wanted signal at –67dBm		–21		dBm
Intermodulation	Wanted signal at 2402MHz, –64dBm. Two interferers at 2405 and 2408MHz respectively, at the given power level		–40		dBm
RSSI accuracy	Dynamic range of –90 to –20dBm	–4		4	dB
Bluetooth Low Energy 2Mbps (LE 2M) Receiver Characteristics					
Receiver sensitivity ⁽⁴⁾	PER <30.2%		–93.4		dBm
Receiver saturation	PER <30.2%		2		dBm
Co-channel rejection ⁽¹⁾	Wanted signal at –67dBm, modulated interferer in channel		10		dB
Selectivity, ±2MHz ⁽¹⁾	Wanted signal at –67dBm, modulated interferer at ±2MHz.		0 / 0		dB
Selectivity, ±4MHz ⁽¹⁾	Wanted signal at –67dBm, modulated interferer at ±4MHz	–35 / –28			dB
Selectivity, ±6MHz ⁽¹⁾	Wanted signal at –67dBm, modulated interferer at ±6MHz	–35 / –28			dB

6.9 Bluetooth Low Energy Performance: Receiver Characteristics (continued)

PARAMETER	TEST CONDITION	MIN	TYP	MAX	UNIT
Alternate channel rejection, $\pm 8\text{MHz}$ ⁽¹⁾	Wanted signal at -67dBm , modulated interferer at $\pm 8\text{MHz}$		$-37 / -32$		dB
Out-of-band blocking	30MHz to 2000MHz, Wanted signal at -67dBm		-23		dBm
Out-of-band blocking	2003MHz to 2399MHz, Wanted signal at -67dBm		-30		dBm
Out-of-band blocking	2484MHz to 2997MHz, Wanted signal at -67dBm		-30		dBm
Out-of-band blocking	3000MHz to 6GHz, Wanted signal at -67dBm		-21		dBm
Intermodulation	Wanted signal at 2402MHz, -64dBm . Two interferers at 2405 and 2408MHz respectively, at the given power level		-44		dBm
RSSI Accuracy	Dynamic range of -90 to -20dBm	-4		4	dB

- (1) Numbers given as C/I dB
- (2) Bluetooth Low Energy Coded PHY sensitivity on channels 17 and 39 may degrade by up to 3dB
- (3) Bluetooth Low Energy 1M PHY sensitivity on channels 17 and 39 may degrade by up to 2.5dB
- (4) Bluetooth Low Energy 2M PHY sensitivity on channel 17 may degrade by up to 1.5dB

6.10 Bluetooth Low Energy Performance: Transmitter Characteristics

The CC33X1 devices support Bluetooth Low Energy TX setting 0,5,10, or 20dBm

PARAMETER	DESCRIPTION	MIN	TYP	MAX	UNIT
Output Power, highest setting			17.8		dBm

6.11 Current Consumption: 2.4GHz WLAN Static Modes

All results are based on measurements taken using the [RadioTool](#) evaluation application (typ values are taken with nominal devices at room temp).

PARAMETER	TEST CONDITIONS		1V8_IN		3V3_IN		UNIT
			TYP	MAX	TYP	MAX	
Continuous TX ⁽¹⁾	1 DSSS	TX Power = 17.9dBm	92		270	310	mA
	6 OFDM	TX Power = 17.8dBm	110	170	270	320	
	54 OFDM	TX Power = 15.5dBm	115		215		
	HT MCS0	TX Power = 17.8dBm	110		270		
	HT MCS7	TX Power = 15.5dBm	115		215		
	HE MCS0	TX Power = 17.8dBm	110		270		
	HE MCS7	TX Power = 15.3dBm	115		215		
Continuous RX			62		0		mA
Continuous Listen (for Beacon)			55.5		0.4		mA

- (1) Peak current 3V3_IN can hit 450mA during device calibration.
Peak current 1V8_IN of 300mA including peripherals and internal CPU

6.12 Current Consumption: 5GHz WLAN Static Modes

All results are based on measurements taken using the [RadioTool](#) evaluation application (typ values are taken with nominal devices at room temp).

PARAMETER	TEST CONDITIONS		1V8_IN		3V3_IN		UNIT
			TYP	MAX	TYP	MAX	
Continuous TX ⁽¹⁾	6 OFDM	TX Power = 18.3dBm	170	220	290	340	mA
	54 OFDM	TX Power = 13.8dBm	175		215		
	HT MCS0	TX Power = 18.3dBm	170		300		
	HT MCS7	TX Power = 13.8dBm	175		215		
	HE MCS0	TX Power = 18.3dBm	170		300		
	HE MCS7	TX Power = 13.2dBm	175		210		
Continuous RX			110		0		mA
Continuous Listen (For Beacon)			88		0		mA

- (1) Peak current 3V3_IN can hit 450mA during device calibration.
Peak current 1V8_IN of 300mA including peripherals and internal CPU

6.13 Current Consumption: 2.4GHz WLAN Use Cases

MODE	DESCRIPTION	TYP ⁽¹⁾	UNIT
System with 3.3V to Ext. DC/DC at 85% Efficiency			
DTIM = 1	WLAN beacon reception every DTIM=1 (~102ms)	562	μA
DTIM = 3	WLAN beacon reception every DTIM=3 (~306ms)	355	
DTIM = 5	WLAN beacon reception every DTIM=5 (~510ms)	313	
System with 1.8V			
DTIM = 1	WLAN beacon reception every DTIM=1 (~102ms)	864	μA
DTIM = 3	WLAN beacon reception every DTIM=3 (~306ms)	546	
DTIM = 5	WLAN beacon reception every DTIM=5 (~510ms)	482	

- (1) Current measured on 1V8_IN supply

6.14 Current Consumption: 5GHz WLAN Use Cases

MODE	DESCRIPTION	TYP ⁽¹⁾	UNIT
System with 3.3V to Ext. DC/DC at 85% Efficiency			
DTIM = 1	WLAN beacon reception every DTIM=1 (~102ms)	700	μA
DTIM = 3	WLAN beacon reception every DTIM=3 (~306ms)	417	
DTIM = 5	WLAN beacon reception every DTIM=5 (~510ms)	348	
System with 1.8V			
DTIM = 1	WLAN beacon reception every DTIM=1 (~102ms)	1077	μA
DTIM = 3	WLAN beacon reception every DTIM=3 (~306ms)	642	
DTIM = 5	WLAN beacon reception every DTIM=5 (~510ms)	536	

- (1) Current measured on 1V8_IN supply

6.15 Current Consumption: Bluetooth Low Energy Static Modes

All results are based on measurements taken using the [RadioTool](#) evaluation application (typ values are taken with nominal devices at room temp).

PARAMETER	TEST CONDITIONS	1V8_IN		3V3_IN		UNIT
		TYP	MAX	TYP	MAX	
TX	TX Power = 0dBm	107		60		mA
	TX Power = 10dBm	107		135		
	TX Power = 17.8 dBm	110		275		
RX		62		0		mA

6.16 Current Consumption: Bluetooth Low Energy Use Cases

over operating free-air temperature range (unless otherwise noted)

MODE	TYP ⁽¹⁾	UNIT
Bluetooth Low Energy Advertise 100ms	3029	μA
Bluetooth Low Energy Connection, 1s	633	μA

(1) Current measured on 1V8_IN supply

6.17 Current Consumption: Device Modes

Nominal device at room temperature

MODE	DESCRIPTION	1V8_IN		3V3_IN		UNIT
		TYP	MAX	TYP	MAX	
Shutdown	External supplies are available, device held in reset (nReset is low)	10		2		μA
Sleep	Low power mode - RAM in retention	330		2		

6.18 Timing and Switching Characteristics

6.18.1 Power Supply Sequencing

For proper operation of the CC335xMOD module, perform the recommended power-up sequencing as follows:

1. All supplies (1V8_IN, 3V3_IN, VPP) must be available before nReset is released.
2. For an external slow clock, confirm that the clock is stable before nReset is deasserted (high).
3. The nReset pin must be held low for at least 10μs after the stabilization of the external power supplies.

6.18.2 Clocking Specifications

The CC335x device uses two clocks for operation:

- A fast clock running at 40MHz for WLAN/Bluetooth Low Energy functions
- A slow clock running at 32.768kHz for low power modes

The fast clock is integrated inside the CC335xMOD and does not need to be supplied externally. The slow clock can be generated internally from the CC335x device or can be supplied externally to the CC335xMOD.

6.18.2.1 Slow Clock Generated Internally

To minimize external components, the slow clock can be generated by an internal oscillator. However, this clock is less accurate and consumes more power than sourcing the slow clock externally. For this scenario, the SLOW_CLK_IN pin must be left not connected.

6.18.2.2 Slow Clock Using an External Oscillator

For excellent power consumption, the slow clock can be generated externally by an oscillator or sourced elsewhere in the system. The external source must meet the requirements shown in [Table 6-1](#). This clock can be fed into the SLOW_CLK_IN pin of the CC335xMOD and must be stable before the nReset pin is deasserted and the device is enabled.

Table 6-1. External Slow Clock Requirements

Parameter		Description	MIN	TYP	MAX	Unit
	Input slow clock frequency	Square wave		32768		Hz
	Frequency accuracy	Initial + temperature + aging			±250	ppm
	Input duty cycle		30%	50%	70%	
T_r/T_f	Rise and fall time	10% to 90% (rise) and 90% to 10% (fall) of digital signal level			100	ns
V_{IL}	Input low level		0		$0.35 \times V_{IO}$	V
V_{IH}	Input high level		$0.65 \times V_{IO}$		1.95	V
	Input impedance		1			MΩ
	Input capacitance				5	pF

6.19 Interface Timing Characteristics

6.19.1 SDIO Timing Specifications

SDIO is the main host interface for WLAN, and it supports a maximum clock rate of 52MHz. The CC335x device also supports a shared SDIO interface for both Bluetooth Low Energy and WLAN.

6.19.1.1 SDIO Timing Diagram: Default Speed

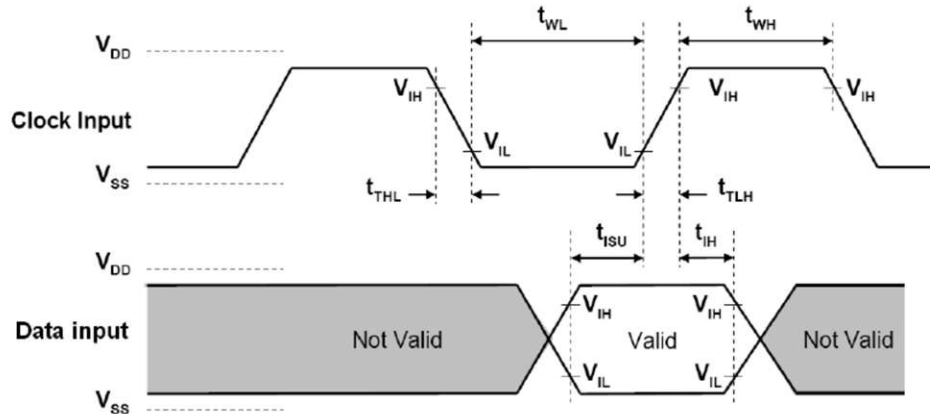

Figure 6-1. SDIO Default Input Timing

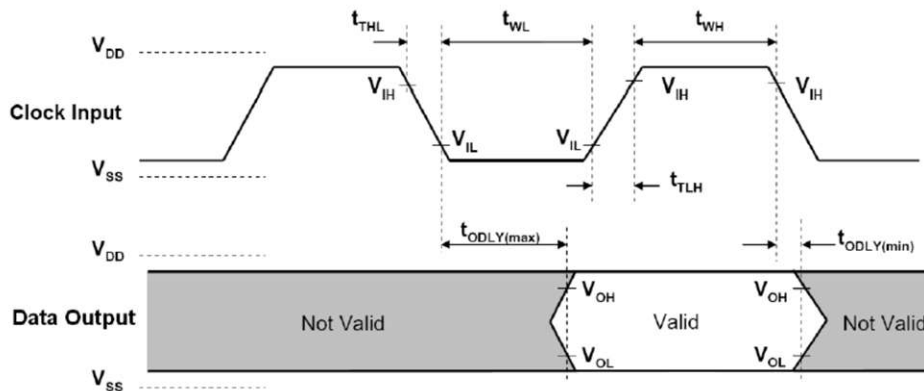

Figure 6-2. SDIO Default Output Timing

Table 6-2. SDIO Timing Parameters: Default Speed

Parameter	Description	MIN	MAX	Unit
f_{clock}	Clock frequency, CLK		26	MHz
t_{High}	High period	10		ns
t_{Low}	Low period	10		
t_{TLH}	Rise time, CLK		10	
t_{THL}	Fall time, CLK		10	
t_{ISU}	Setup time, input valid before CLK \uparrow	5		
t_{IH}	Hold time, input valid after CLK \uparrow	5		
t_{ODLY}	Delay time, CLK \downarrow to output valid	2	14	
C_L	Capacitive load on outputs	15	40	pF

6.19.1.2 SDIO Timing Diagram: High Speed

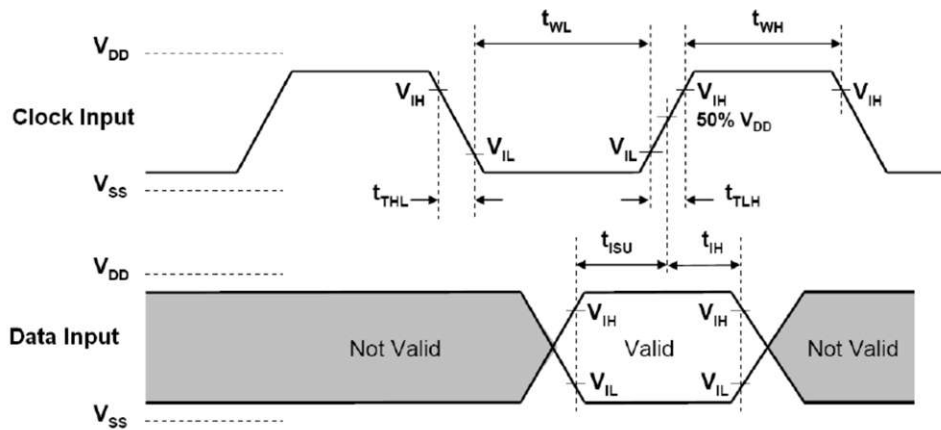

Figure 6-3. SDIO HS Input Timing

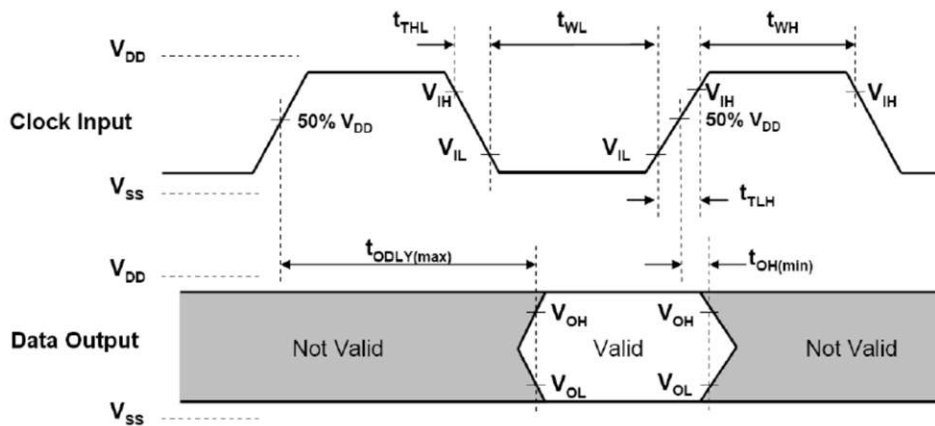

Figure 6-4. SDIO HS Output Timing

Table 6-3. SDIO Timing Parameters: High Speed

Parameter	Description	MIN	MAX	Unit
f_{clock}	Clock frequency, CLK		52	MHz
t_{High}	High period	7		ns
t_{Low}	Low period	7		
t_{TLH}	Rise time, CLK		3	
t_{THL}	Fall time, CLK		3	
t_{ISU}	Setup time, input valid before CLK \uparrow	6		
t_{IH}	Hold time, input valid after CLK \uparrow	2		
t_{ODLY}	Delay time, CLK \uparrow to output valid	2	14	
C_{L}	Capacitive load on outputs	15	40	pF

6.19.2 SPI Timing Specifications

SPI is another host interface for WLAN. The CC335x device also supports shared SPI interface for both Bluetooth Low Energy and WLAN.

6.19.2.1 SPI Timing Diagram

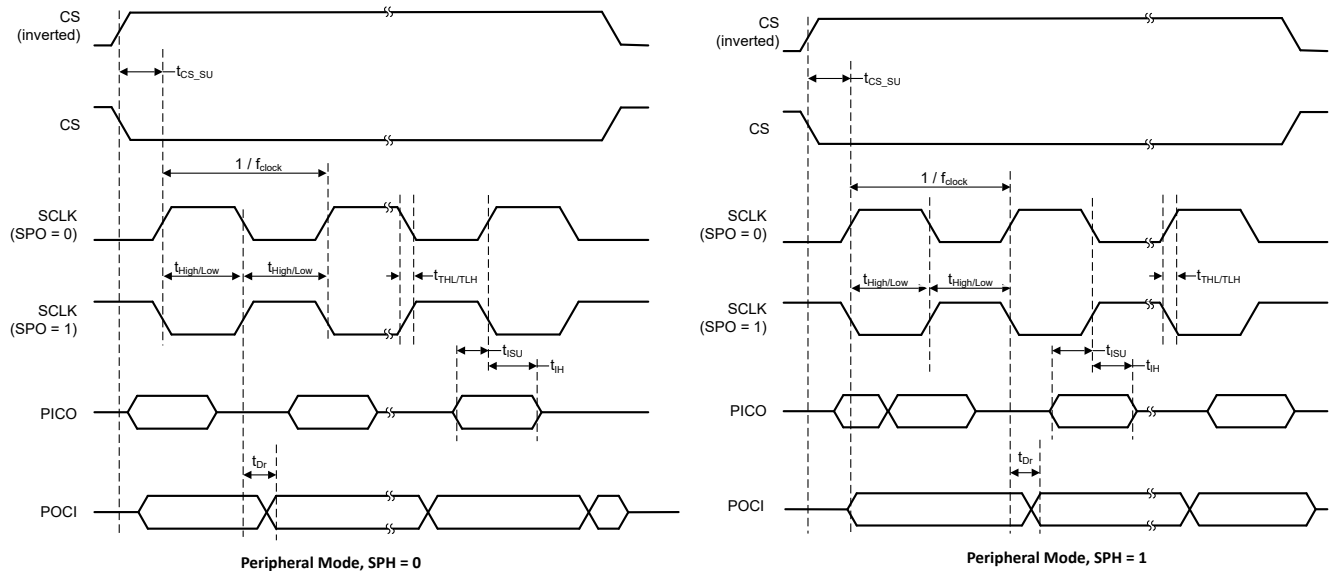

Figure 6-5. SPI Timing

6.19.2.2 SPI Timing Parameters

PARAMETER	DESCRIPTION	MIN	MAX	UNIT
f_{clock}	Clock frequency, CLK		26	MHz
t_{High}	High Period	10		ns
t_{Low}	Low Period	10		
t_{TLH}	Rise time, CLK		3	
t_{THL}	Fall time, CLK		3	
t_{CSsu}	CS Setup time, CS valid before CLK \uparrow	3		
t_{ISU}	PICO, input valid before CLK \uparrow	3		
t_{IH}	PICO Hold time, input valid after CLK \uparrow	3		
$t_{\text{Dr}}, t_{\text{Df}} - \text{Active}$	Delay time, CLK \uparrow/\downarrow to output valid	2	10	
$t_{\text{Dr}}, t_{\text{Df}} - \text{Sleep}$	Delay time, CLK \uparrow/\downarrow to output valid		12	
C_{L}	Capacitive load on outputs	15	40	pF

6.19.3 UART 4-Wire Interface

UART is the main host interface for Bluetooth Low Energy, which supports the host controller interface (HCI) transport layer.

6.19.3.1 UART Timing Parameters

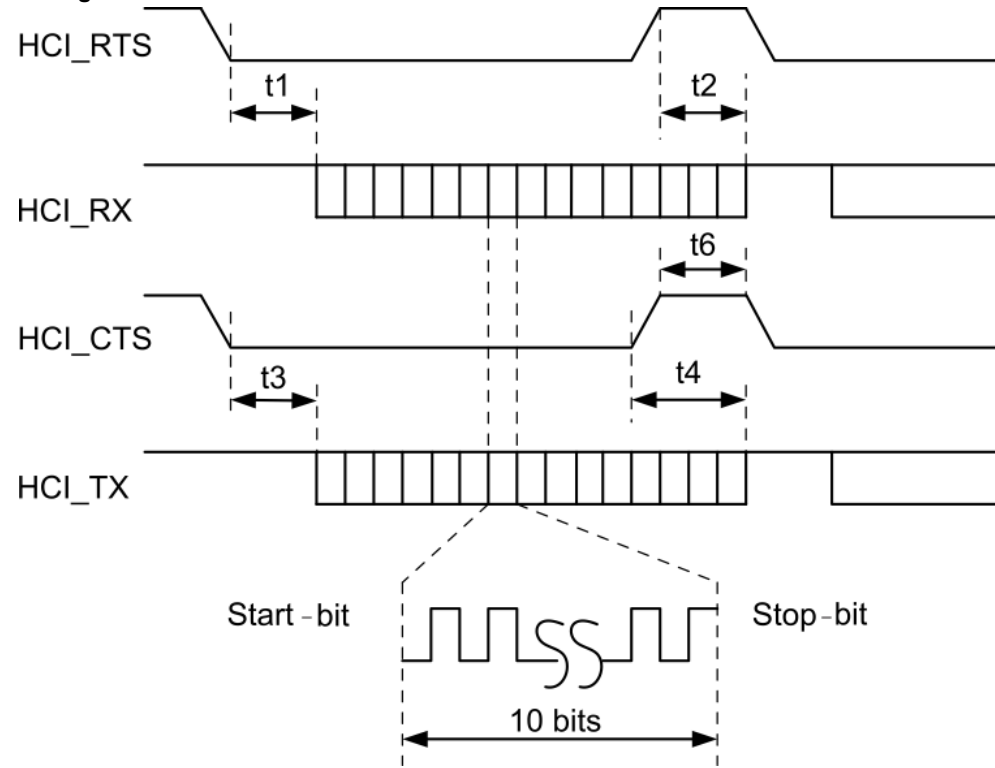

Figure 6-6. UART Timing Diagram

PARAMETER	TEST CONDITIONS	SYMBOL	MIN	TYP	MAX	UNIT
Baud rate			37.5		4364	Kbps
Baud rate accuracy per byte	Receive/Transmit		-2.5		1.5	%
Baud rate accuracy per bit	Receive/Transmit		-12.5		12.5	%
CTS low to TX_DATA on		t3	0	2		µs
CTS high to TX_DATA off	Hardware flow control	t4			1	Byte
CTS High Pulse Width		t6	1			bit
RTS low to RX_DATA on		t1	0	2		µs
RTS high to RX_DATA off	Interrupt set to 1/4 FIFO	t2			16	Bytes



- STR - Start bit
- D0..Dn - Data bits (LSB first)
- PAR - Parity bit (if used)
- STP - Stop bit

7 Detailed Description

The CC335xMOD offers Wi-Fi 6 (802.11ax) and Bluetooth Low Energy 5.4 (CC3351MOD devices) in a single-chip solution while maintaining compatibility with Wi-Fi 4 (802.11 a/b/g/n) and Wi-Fi 5 (802.11ac). These devices are ideal for cost-sensitive embedded applications with a Linux or RTOS host running TCP/IP. CC335xMOD brings the efficiency of Wi-Fi 6 to embedded device applications for the Internet of Things (IoT) with a small PCB footprint and a highly optimized bill of materials. The device features an integrated 2.4GHz and 5GHz PA for a complete wireless solution with up to +20.5dBm output power, operating temperature of -40°C to $+105^{\circ}\text{C}$, and application throughput up to 50Mbps. The CC335xMOD devices include BSD-3 clause software distributed in integrated ROM. License terms are provided in the product software manifest available in the [CC33XX-Software](#) downloadable product.

7.1 WLAN Features

The device supports the following WLAN features:

- 2.4GHz and 5GHz, 20MHz, single spatial stream
- MAC, baseband, and RF transceiver with support for IEEE 802.11 a/b/g/n/ax
- OFDMA, trigger frame, MU-MIMO (downlink), basic service set coloring, and target wake time (TWT) for improved efficiency
- Hardware-based encryption and decryption supporting WPA2 and WPA3
- Multirole support (for example, concurrent STA and AP) to connect with Wi-Fi devices on different RF channels (Wi-Fi networks)
- Optional antenna diversity or selection
- 3-wire or 1-wire PTA for external coexistence with additional 2.4GHz radios (for example, Thread or Zigbee)
- Excellent interoperability
- Support for 4-bit SDIO or SPI host interfaces

7.2 Bluetooth Low Energy Features

The device supports the following Bluetooth low energy features:

- Bluetooth Low Energy 5.4
- LE coded PHYs (long range), LE 2M PHY (high speed), and advertising extension
- Host controller interface (HCI) transport with option for UART or shared SDIO

8 Device Certification

The CC3350MOD and CC3351MOD modules from TI are certified for FCC, IC, ETSI/CE, and Japan MIC. The module is also Wi-Fi CERTIFIED™ with the ability to request a certificate transfer for Wi-Fi Alliance® members. TI customers who build products based on the CC335xMOD device from TI can save on testing costs and time per product family. [Table 8-1](#) shows the certification list for the CC3351MOD module.

Note

The FCC and IC IDs must be located in both the user manual and on the packaging. Due to the small size of the module (11 mm x 11 mm), placing the IDs and markings in a type size large enough to be legible without the aid of magnification is impractical.

Table 8-1. Device Certification

REGULATORY BODY	SPECIFICATION	ID (IF APPLICABLE)
FCC (USA)	Part 15C + MPE FCC RF exposure	Z64-CC33DBMOD
IC/ISED (Canada)	RSS-102 (MPE) and RSS-247 (Wi-Fi, Bluetooth)	4511-CC33DBMOD
ETSI/CE (Europe)	EN300328 v2.2.2 (2.4GHz Wi-Fi, Bluetooth)	—
	EN301893 v2.1.1 (5GHz Wi-Fi)	—
	EN300440 V2.2.1	—
	EN62311:2020 (MPE)	—
	EN50665:2017	—
	EN301489-1 v2.2.3 (general EMC)	—
	EN301489-3 V2.3.2	—
	EN301489-17 v3.3.1 (EMC)	—
MIC (Japan)	Article 49-20 of ORRE	201-250530 (Test Grade: 51)
		201-250531 (Test Grade: 50)

8.1 FCC Certification and Statement

The CC335xMOD modules from TI are certified for the FCC as a single-modular transmitter. The modules are FCC-certified radio modules that carry a modular grant. Users are cautioned that changes or modifications not expressly approved by the party responsible for compliance could void the authority of the user to operate the equipment.

This device complies with Part 15 of the FCC rules. Operation is subject to the following two conditions:

- This device may not cause harmful interference.
- This device must accept any interference received, including interference that may cause undesired operation of the device.

CAUTION

FCC RF Radiation Exposure Statement

This equipment complies with FCC radiation exposure limits set forth for an uncontrolled environment. End users must follow the specific operating instructions to satisfy RF exposure limits. This transmitter must not be colocated or operate with any other antenna or transmitter.

8.2 IC/ISED Certification and Statement

CAUTION

IC RF Radiation Exposure Statement:

To comply with IC RF exposure requirements, this device and its antenna must not be co-located or operating in conjunction with any other antenna or transmitter.

Pour se conformer aux exigences de conformité RF canadienne l'exposition, cet appareil et son antenne ne doivent pas être co-localisés ou fonctionnant en conjonction avec une autre antenne ou transmetteur.

The CC335xMOD modules from TI are certified for IC as a single-modular transmitter. The CC335xMOD modules from TI meet IC modular approval and labeling requirements. The IC follows the same testing and rules as the FCC regarding certified modules in authorized equipment.

This device complies with Industry Canada license-exempt RSS standards.

Operation is subject to the following two conditions:

- This device may not cause interference.
- This device must accept any interference, including interference that may cause undesired operation of the device.

Le présent appareil est conforme aux CNR d'Industrie Canada applicables aux appareils radio exempts de licence.

L'exploitation est autorisée aux deux conditions suivantes:

- L'appareil ne doit pas produire de brouillage
- L'utilisateur de l'appareil doit accepter tout brouillage radioélectrique subi, même si le brouillage est susceptible d'en compromettre le fonctionnement.

8.3 ETSI/CE

The CC335xMOD modules conform to the EU Radio Equipment Directive. For further details, see the full text of the EU Declaration of Conformity for the CC3351MOD devices.

8.4 MIC Certification

The CC335xMOD modules from TI are MIC-certified against articles 49–20 and the relevant articles of the Ordinance Regulating Radio Equipment. Operation is subject to the following condition:

- The host system does not contain a wireless wide area network (WWAN) device.

8.5 Manual Information to the End User

The OEM integrator must be aware of not providing information to the end user regarding how to install or remove this RF module in the user's manual of the end product that integrates this module. The end user's manual must include all required regulatory information and warnings as shown in this manual.

8.6 Module Markings

The figure below shows the markings for the CC335xMOD module.

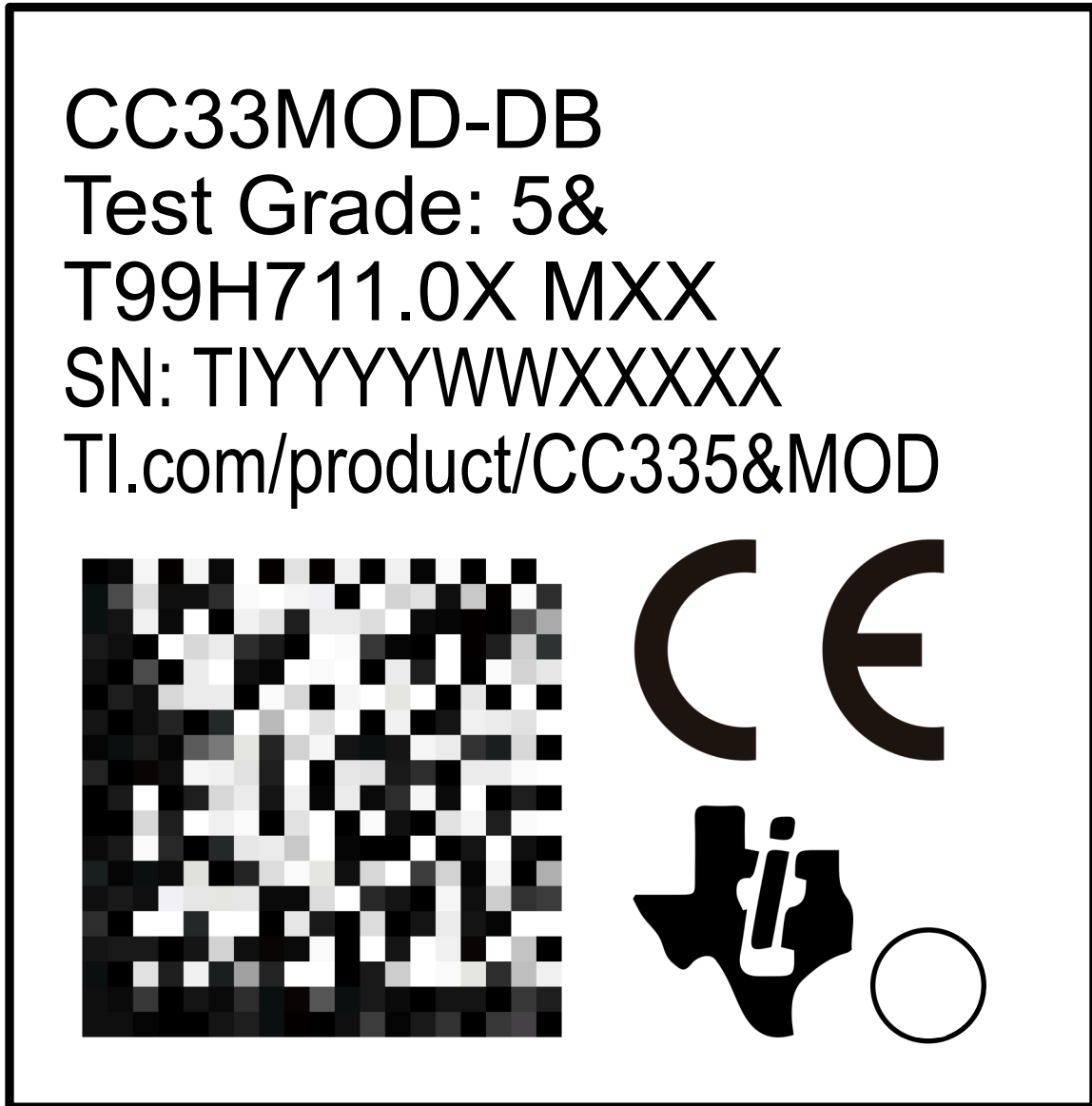

Figure 8-1. CC335xMOD Module Markings

The table below describes the CC335xMOD markings.

Table 8-2. Description of CC335xMOD Markings

MARKING	DESCRIPTION
CC33MOD-DB	TI Model P/N
5&	Test grade (For more information see the Test Grades section)
T99H711.0X	Internal Part Identifier
MXX	Internal Part Identifier
SN(Serial Number): TIYYYYWWXXXXX	SN: Reserved for TI Use
Ti.com/product/CC335&MOD	Link to module product page

Table 8-2. Description of CC335xMOD Markings (continued)

MARKING	DESCRIPTION
○	Pin 1 Indicator
CE logo	CE Compliance Mark
QR Code	Internal Use

8.6.1 Test Grades

See the table below for more information about test grades for CC335xMOD.

Table 8-3. Test Grade Markings for CC335xMOD

TEST GRADE	PART NUMBER	WLAN 2.4/5GHz	BLUETOOTH LOW ENERGY
50	CC3350MODENIAMOZR	Tested	—
51	CC3351MODENIAMOZR	Tested	Tested

9 Application Information

9.1 Applications, Implementation, and Layout

Note

Information in the following applications sections is not part of the TI component specification, and TI does not warrant its accuracy or completeness. TI's customers are responsible for determining suitability of components for their purposes, as well as validating and testing their design implementation to confirm system functionality.

9.2 Typical Application—CC335xMOD Reference Design

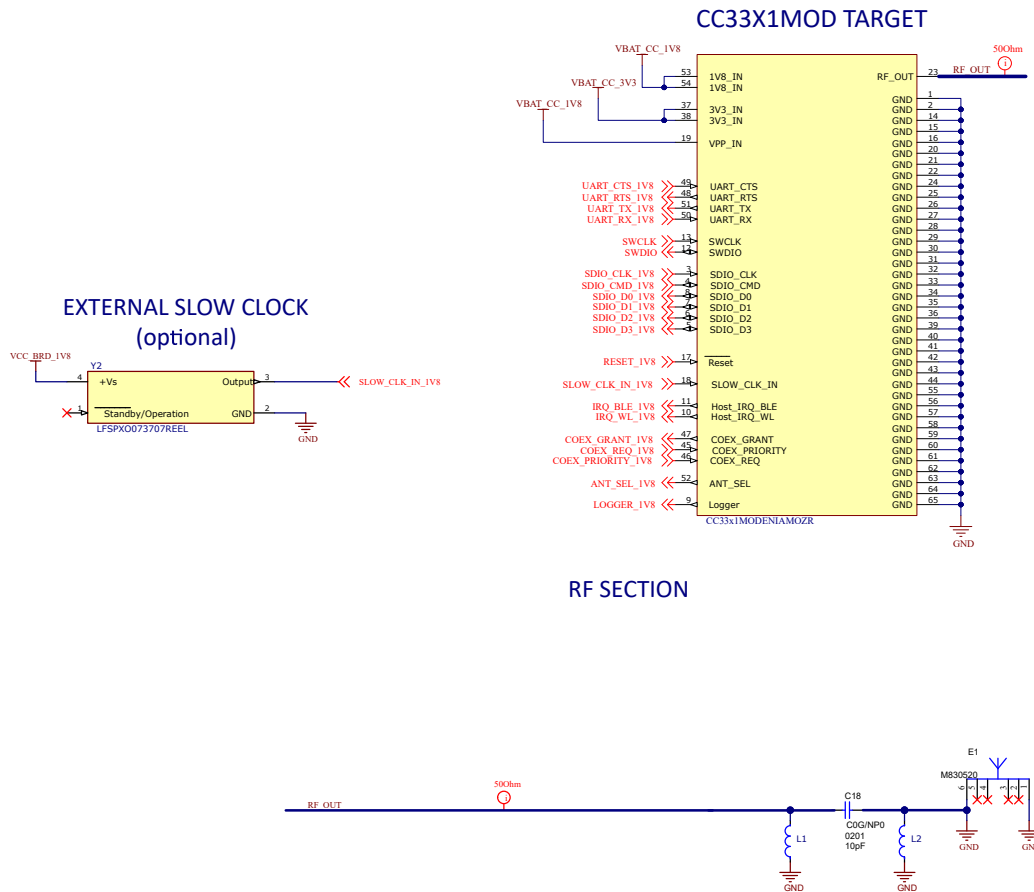

Figure 9-1. CC335xMOD Reference Schematics

9.3 Design Recommendations

This section describes the layout recommendations for the CC335xMOD module, RF trace, and antenna.

Table 9-1 summarizes the layout recommendations.

Table 9-1. Layout Recommendations Summary

ITEM	DESCRIPTION
Thermal	
1	The proximity of ground vias must be close to the pad.
2	Signal traces must not be run underneath the module on the layer where the module is mounted.
3	Have a complete ground pour in layer 2 for thermal dissipation.
4	Have a solid ground plane and ground vias under the module for a stable system and thermal dissipation.

Table 9-1. Layout Recommendations Summary (continued)

ITEM	DESCRIPTION
5	Increase the ground pour in the first layer and have all of the traces from the first layer on the inner layers, if possible.
6	Signal traces can be run on a third layer under the solid ground layer, which is below the module mounting layer.
RF Trace and Antenna Routing	
7	The RF trace antenna feed must be as short as possible beyond the ground reference. At this point, the trace starts to radiate.
8	The RF trace bends must be gradual, with an approximate maximum bend of 45° with trace mitered. RF traces must not have sharp corners.
9	RF traces must have via stitching on the ground plane beside the RF trace on both sides.
10	RF traces must have constant impedance (microstrip transmission line).
11	For best results, the RF trace ground layer should be the ground layer immediately below the RF trace. The ground layer should be solid.
12	There must be no traces or ground under the antenna section.
13	RF traces must be as short as possible. The antenna, RF traces, and modules must be on the edge of the PCB product. The proximity of the antenna to the enclosure and the enclosure material must also be considered.

9.3.1 General Layout Recommendations

Ensure that the following general layout recommendations are followed:

- Have a solid ground plane and ground vias under the module for stable system and thermal dissipation.
- Do not place signal traces underneath the module on a layer where the module is mounted.

9.3.2 CC335xMOD RF Layout Recommendations

The RF section of this wireless module gets top priority in terms of layout. It is very important for the RF section to be laid out correctly to ensure optimum performance from the module. A poor layout can cause low-output power, EVM degradation, sensitivity degradation, and mask violations.

The image below shows the RF placement and routing of the CC3351MOD module with an external antenna.

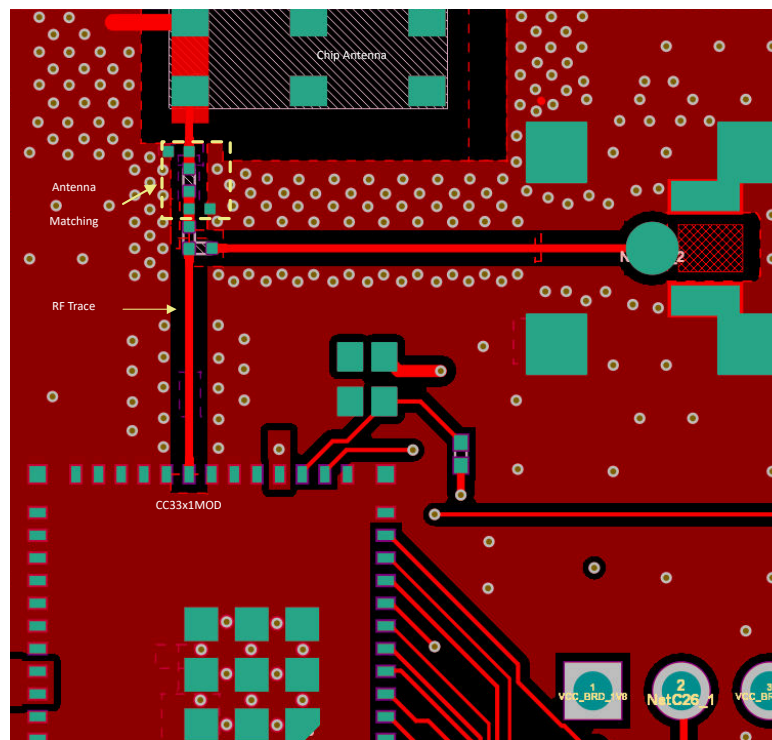

Figure 9-2. RF Section Layout

Follow these RF layout recommendations for the CC335xMOD device:

- RF traces must have 50Ω impedance and should be no shorter than 9.24mm.
- RF trace bends must be made with gradual curves, and 90° bends must be avoided.
- RF traces must not have sharp corners.
- There must be no traces or ground under the antenna section.
- RF traces must have via stitching on the ground plane beside the RF trace on both sides.
- RF traces must be as short as possible. The antenna, RF traces, and the module must be on the edge of the PCB product in consideration of the product enclosure material and proximity.

9.3.3 Thermal Board Recommendations

The TI module uses μ vias for layers 1 through 4 with full copper filling, providing heat flow all the way to the module ground pads.

TI recommends using one big ground pad under the module with vias all the way to connect the pad to all ground layers (see [Block of Ground Pads on the Bottom Side of Package](#)).

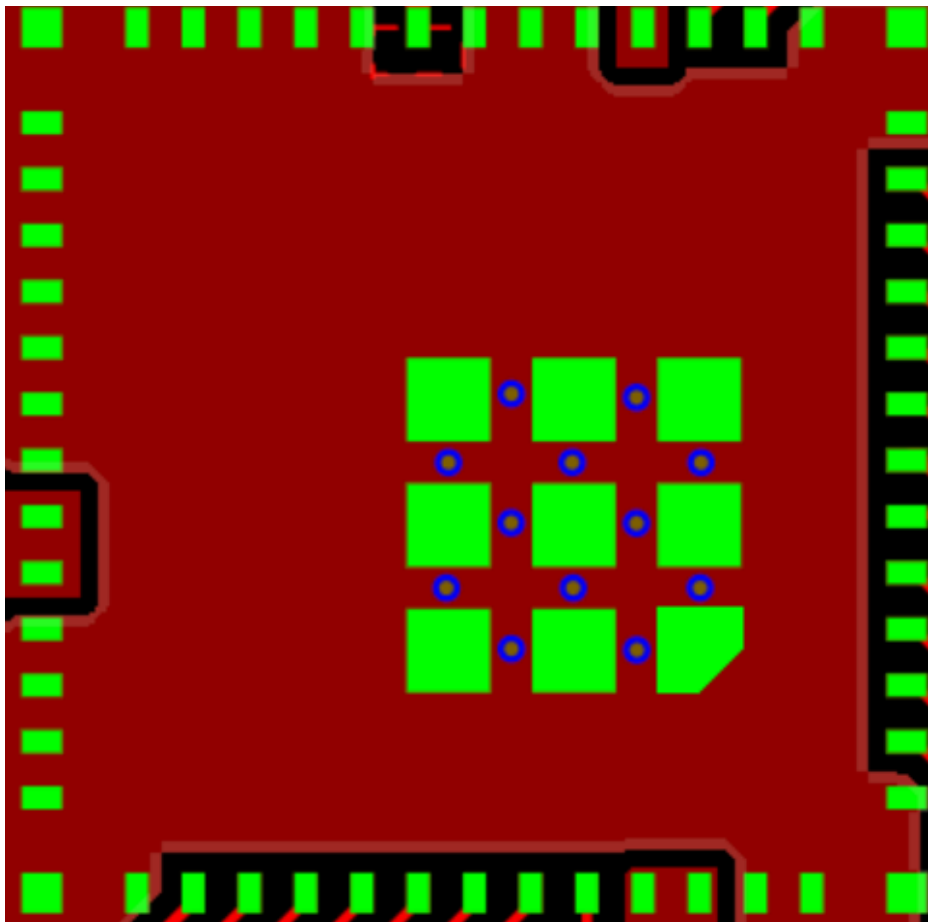

Figure 9-3. Block of Ground Pads on the Bottom Side of Package

For more general layout recommendations, refer to the [CC33xx Hardware Integration](#) document. This document describes how to integrate the CC335xMOD into any system, and the hardware requirements for this device. Layout and schematic considerations are listed here as well, which TI highly recommends following to achieve the device performance listed in this data sheet.

9.4 Baking and SMT Recommendations

9.4.1 Baking Recommendations

Follow these baking guidelines for the CC335xMOD module:

- Follow MSL level 4 to perform the baking process.
- After the bag is open, devices subjected to reflow solder or other high-temperature processes must be mounted within 72 hours of factory conditions (< 30°C/60% RH) or stored at <10% RH.
- If the humidity indicator card reads >10%, devices require baking before they are mounted.
- If baking is required, bake devices for 8 hours at 125°C.

9.4.2 SMT Recommendations

[Reflow Profile for the CC335xMOD Module](#) shows the recommended reflow profile for the CC335xMOD module.

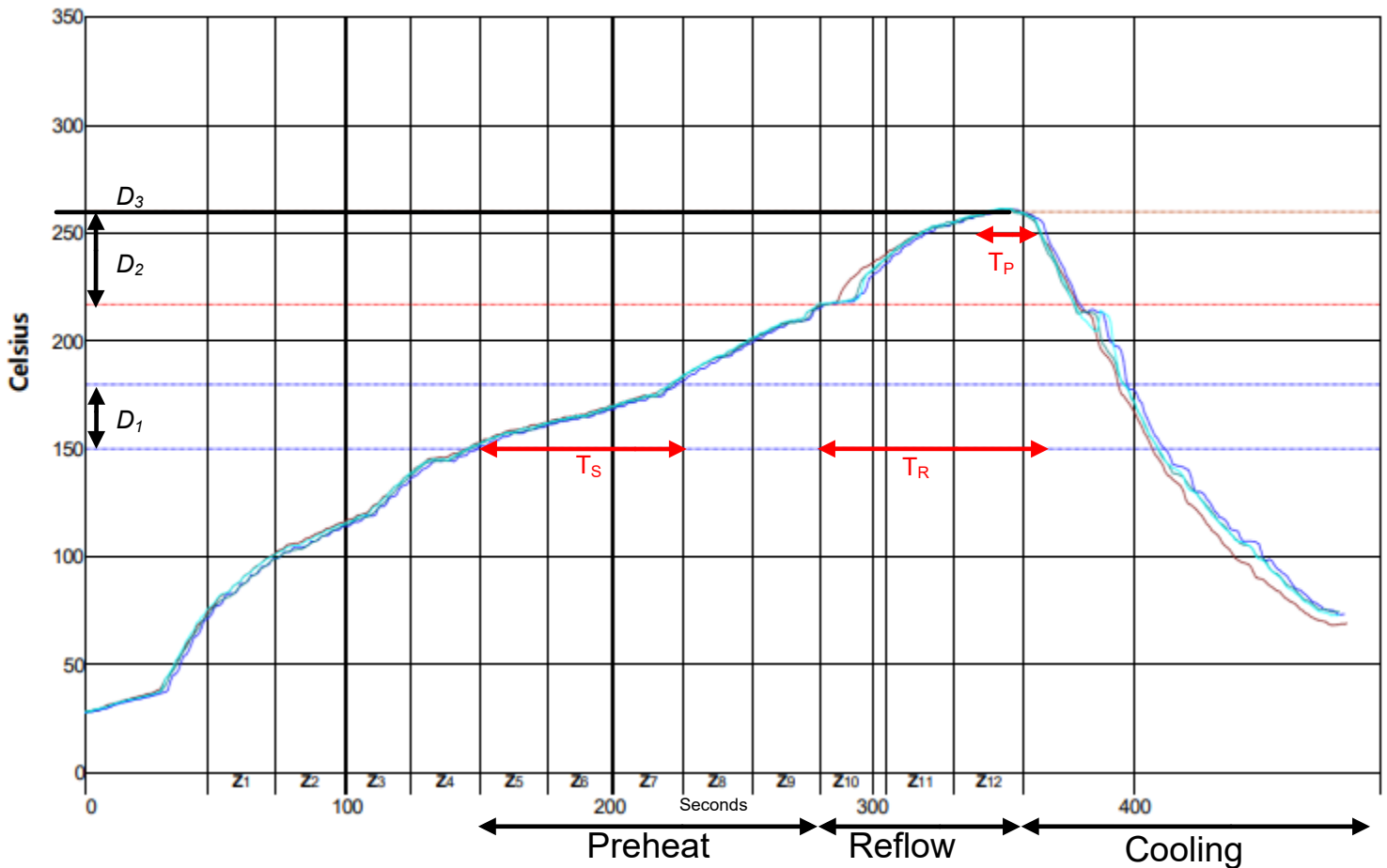

Figure 9-4. Reflow Profile for the CC335xMOD Module

[Temperature Values for Reflow Profile](#) lists the temperature values for the profile shown in [Reflow Profile for the CC335xMOD Module](#).

Table 9-2. Temperature Values for Reflow Profile

ITEM	TEMPERATURE (°C)	TIME (s)
Preheat	D ₁ : 150 to 180	T _S : 60 to 120
Reflow	D ₂ : 217 to 260	T _R : 60 to 120
Peak temperature	D ₃ : 260 maximum	T _P : 7.5

- Solder paste alloy: S3X58-M500 KOKI (Sn96.5, Ag3.0, Cu0.5)

- Pre-heat temperature: 150°C ~ 180°C; Soak time: 60 seconds ~ 120 seconds
- Peak temperature: 260°C
- Time above 217°C: 60 seconds ~ 120 seconds
- Time above 260°C: 7.5 seconds
- Optimal heating rate: 3°C/second
- Optimal cooling rate: -3°C/second

10 Device and Documentation Support

TI offers an extensive line of development tools. Tools and software to evaluate the performance of the device, generate code, and develop systems are listed below.

10.1 Third-Party Products Disclaimer

TI'S PUBLICATION OF INFORMATION REGARDING THIRD-PARTY PRODUCTS OR SERVICES DOES NOT CONSTITUTE AN ENDORSEMENT REGARDING THE SUITABILITY OF SUCH PRODUCTS OR SERVICES OR A WARRANTY, REPRESENTATION OR ENDORSEMENT OF SUCH PRODUCTS OR SERVICES, EITHER ALONE OR IN COMBINATION WITH ANY TI PRODUCT OR SERVICE.

10.2 Device Nomenclature Boilerplate

Device development evolutionary flow:

- X** Experimental device that is not necessarily representative of the final device's electrical specifications and may not use production assembly flow.
- P** Prototype device that is not necessarily the final silicon die and may not necessarily meet final electrical specifications.
- null** Production version of the silicon die that is fully qualified.

Support tool development evolutionary flow:

- TMDX** Development-support product that has not yet completed Texas Instruments internal qualification testing.
- TMDS** Fully-qualified development-support product.

X and P devices and TMDX development-support tools are shipped against the following disclaimer:

Device development evolutionary flow:

- TMX** Experimental device that is not necessarily representative of the final device's electrical specifications and may not use production assembly flow.
- TMP** Prototype device that is not necessarily the final silicon die and may not necessarily meet final electrical specifications.
- TMS** Production version of the silicon die that is fully qualified.

Support tool development evolutionary flow:

- TMDX** Development-support product that has not yet completed Texas Instruments internal qualification testing.
- TMDS** Fully-qualified development-support product.

TMX and TMP devices and TMDX development-support tools are shipped against the following disclaimer:

"Developmental product is intended for internal evaluation purposes."

Production devices and TMDS development-support tools have been characterized fully, and the quality and reliability of the device have been demonstrated fully. TI's standard warranty applies.

Predictions show that prototype devices (X or P) have a greater failure rate than the standard production devices. Texas Instruments recommends that these devices not be used in any production system because their expected end-use failure rate still is undefined. Only qualified production devices are to be used.

10.3 Tools and Software

Design Kits and Evaluation Modules

[CC3351MOD BoosterPack plug-in module](#) The CC3351MOD BoosterPack™ plug-in module (BP-CC3351MOD) is a test and development board that can be easily connected to TI LaunchPad™ development kits or processor boards; thus enabling rapid software development.

Software

[SimpleLink Wi-Fi Toolbox](#) SimpleLink Wi-Fi Toolbox is a collection of tools to help development and testing of the CC33xx. The Wi-Fi toolbox package provides all the capabilities required to debug and monitor WLAN/Bluetooth® Low Energy firmware with a host, perform RF validation tests, run pretest for regulatory certification testing, and debug hardware and software platform integration issues.

[CC33xx device drivers](#) The CC33XX are single-chip Wi-Fi 6 and Bluetooth Low Energy 5.4 companion devices for both Linux- and RTOS-based systems. CC33XX-SOFTWARE is a collection of software development sources aimed to facilitate quick setup, out-of-box experience, and accelerate development in Linux or RTOS environments.

10.4 Documentation Support

To receive notification of documentation updates, navigate to the device product folder on ti.com. Click on *Notifications* to register and receive a weekly digest of any product information that has changed. For change details, review the revision history included in any revised document.

Application Reports

[CC33xx Production Line Guide](#) Texas Instruments™ provides many resources to assist users in quickly examining the functionality and performance of the TI devices. This document provides the necessary information to guide the user in production line testing for CC33xx. The devices' functions can be checked using tools and software provided by Texas Instruments. Performance testing is more involved as external equipment is required for a thorough examination.

[SimpleLink CC33xx Security Features](#) This document describes the CC33xx security-related features, which are made available to vendors through an ecosystem that incorporates simple and concise APIs, tools, and documentation

[SimpleLink CC33xx Host Interfaces](#) This document describes the host interface between the host processor and CC33xx companion IC and provides the system designer with all the required technical information for easy integration

User's Guides

[CC33xx WLAN Features User's Guide](#) This document provides information about CC335xMOD family of devices and Wi-Fi® features, as well as TI proprietary enhancements. The document does not provide the complete application programming interface (API) set, but a high-level overview of the features.

[CC33xx Hardware Integration](#) This document describes how to integrate the CC335xMOD into any system, and the hardware requirements for this device. Layout and schematic considerations are listed here as well, which TI highly recommends following to achieve the device performance listed in this data sheet.

[WFA QuickTrack Control Application with CC33xx User's Guide](#) This document provides information about using the QuickTrack Control App to certify CC33xx devices according to Wi-Fi® standards. The document provides a high-level overview of the certification process.

10.5 Support Resources

[TI E2E™ support forums](#) are an engineer's go-to source for fast, verified answers and design help — straight from the experts. Search existing answers or ask your own question to get the quick design help you need.

Linked content is provided "AS IS" by the respective contributors. They do not constitute TI specifications and do not necessarily reflect TI's views; see TI's [Terms of Use](#).

10.6 Trademarks

SimpleLink™ is a trademark of TI.

TI E2E™ is a trademark of Texas Instruments.

Bluetooth® is a registered trademark of Bluetooth SIG, Inc.

All trademarks are the property of their respective owners.

10.7 Electrostatic Discharge Caution



This integrated circuit can be damaged by ESD. Texas Instruments recommends that all integrated circuits be handled with appropriate precautions. Failure to observe proper handling and installation procedures can cause damage.

ESD damage can range from subtle performance degradation to complete device failure. Precision integrated circuits may be more susceptible to damage because very small parametric changes could cause the device not to meet its published specifications.

10.8 Glossary

[TI Glossary](#) This glossary lists and explains terms, acronyms, and definitions.

11 Revision History

NOTE: Page numbers for previous revisions may differ from page numbers in the current version.

Changes from July 1, 2025 to February 28, 2026 (from Revision * (July 2025) to Revision A (February 2026))

	Page
• Added Certifications IDs.....	1
• Updated Specifications for RTM.....	9
• Updated Module Markings.....	25

12 Mechanical, Packaging, and Orderable Information

The following pages include mechanical, packaging, and orderable information. This information is the most current data available for the designated devices. This data is subject to change without notice and revision of this document. For browser-based versions of this data sheet, refer to the left-hand navigation.

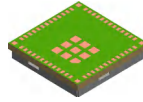

MOZ0065A

PACKAGE OUTLINE

QFM - 2.1 mm max height

QUAD FLAT MODULE

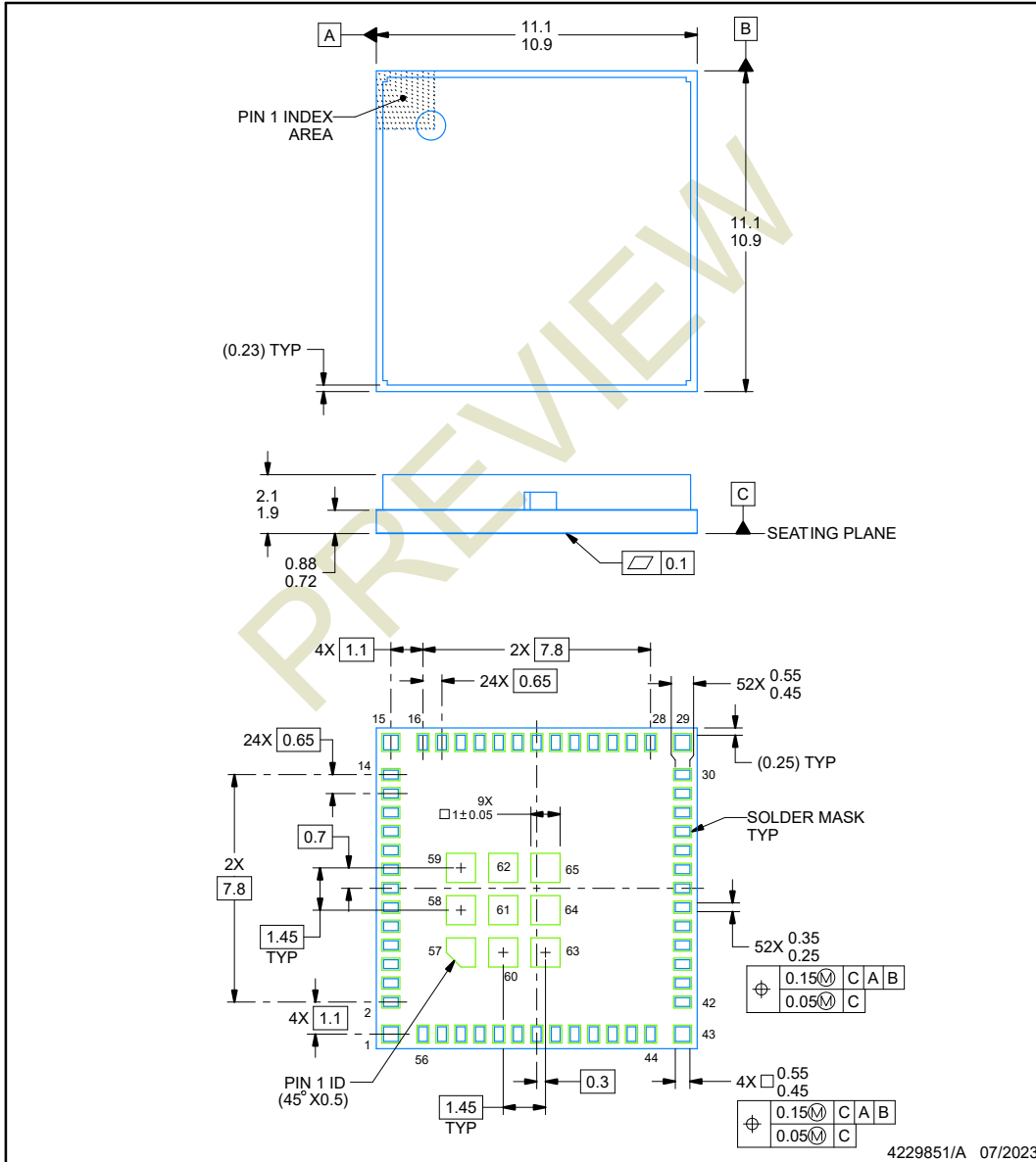

NOTES:

1. All linear dimensions are in millimeters. Any dimensions in parenthesis are for reference only. Dimensioning and tolerancing per ASME Y14.5M.
2. This drawing is subject to change without notice.

EXAMPLE BOARD LAYOUT

MOZ0065A

QFM - 2.1 mm max height

QUAD FLAT MODULE

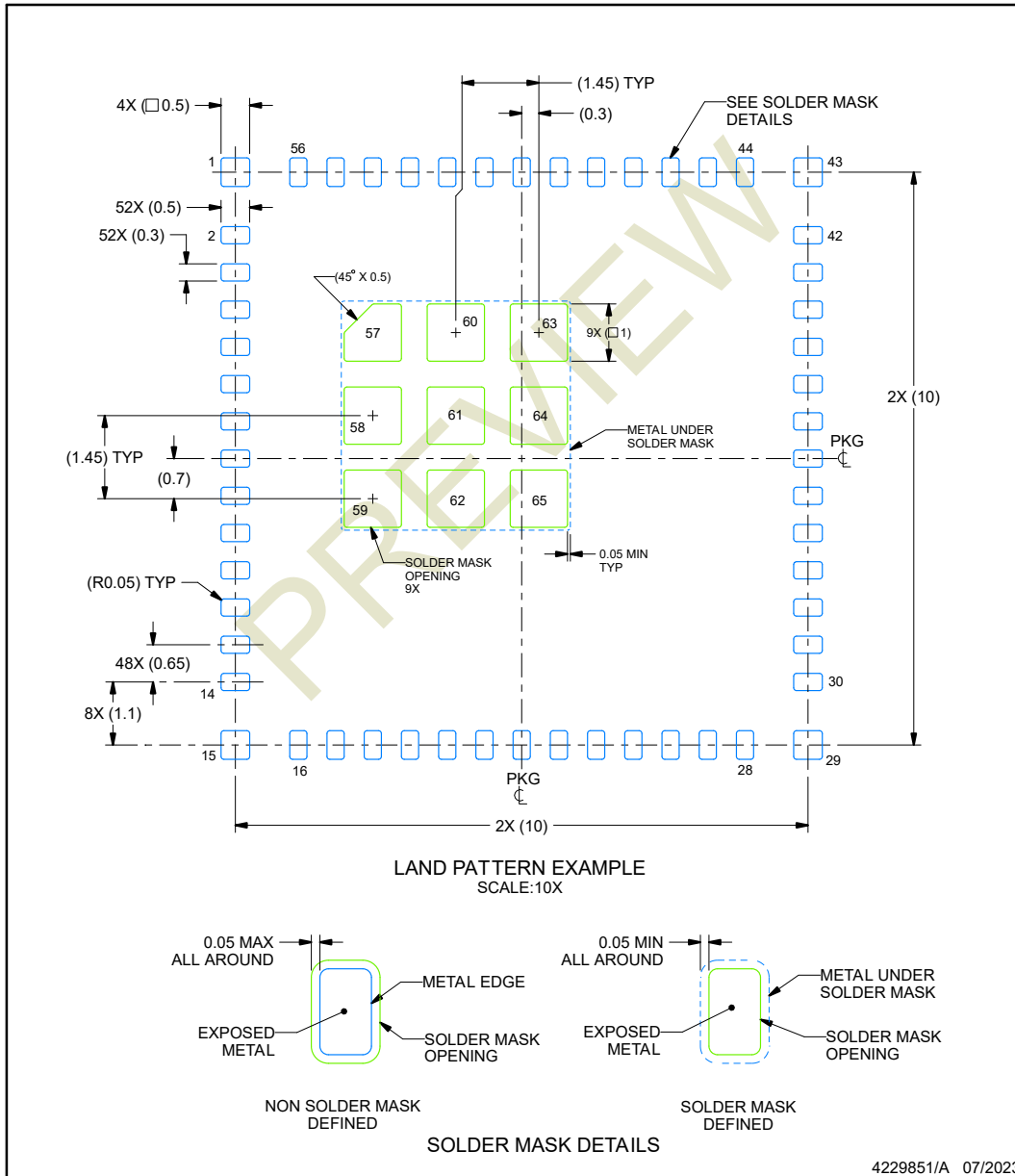

NOTES: (continued)

- This package is designed to be soldered to a thermal pad on the board. For more information, see Texas Instruments literature number SLUA271 (www.ti.com/lit/slua271).

EXAMPLE STENCIL DESIGN

MOZ0065A

QFM - 2.1 mm max height

QUAD FLAT MODULE

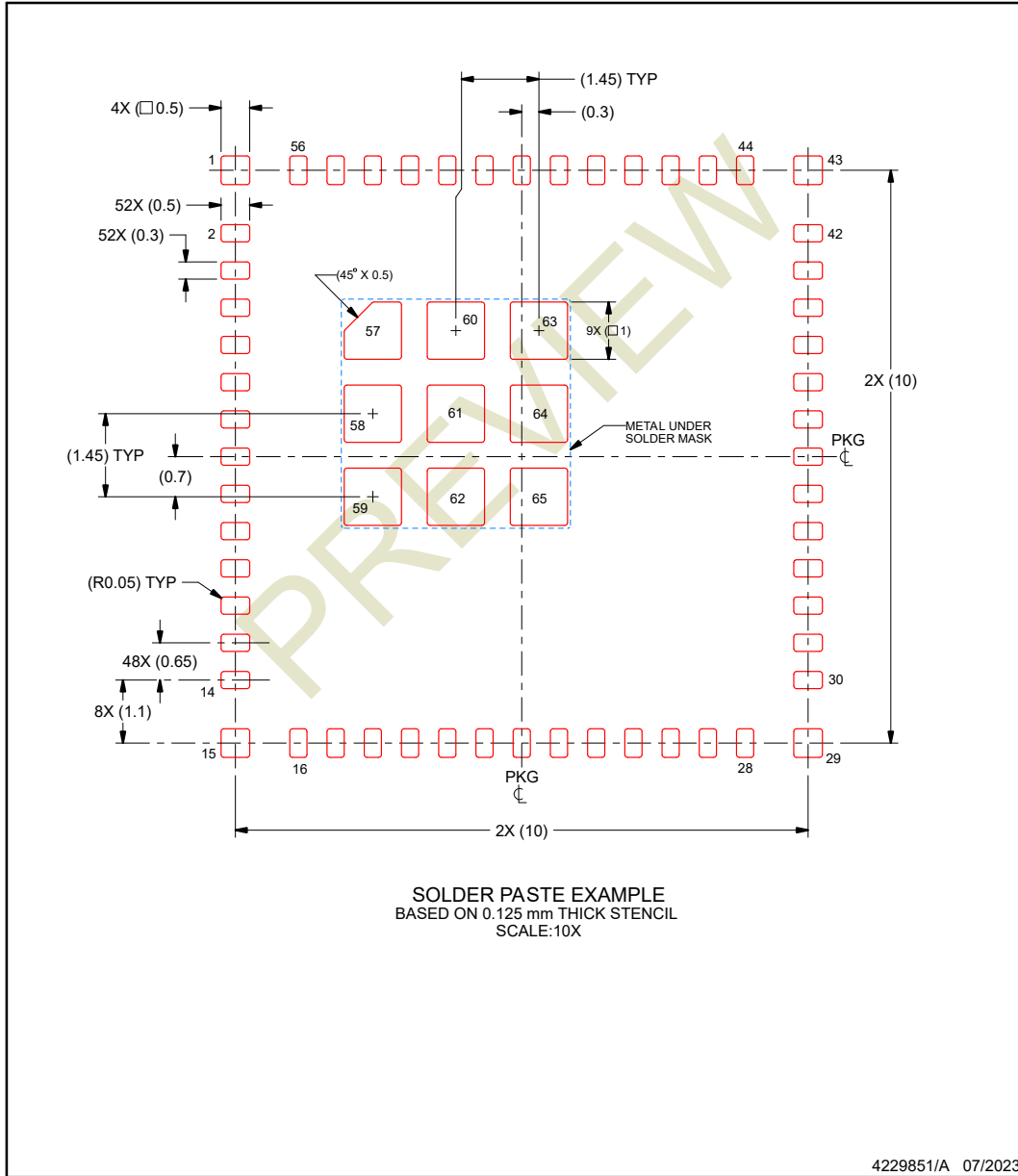

NOTES: (continued)

4. Laser cutting apertures with trapezoidal walls and rounded corners may offer better paste release. IPC-7525 may have alternate design recommendations.

PACKAGING INFORMATION

Orderable part number	Status (1)	Material type (2)	Package Pins	Package qty Carrier	RoHS (3)	Lead finish/ Ball material (4)	MSL rating/ Peak reflow (5)	Op temp (°C)	Part marking (6)
CC3350MODENIAMOZR	Active	Production	QFM (MOZ) 65	1500 LARGE T&R	Exempt	Call TI	Call TI	-40 to 85	
CC3351MODENIAMOZR	Active	Production	QFM (MOZ) 65	1500 LARGE T&R	Exempt	Call TI	Call TI	-40 to 85	

(1) **Status:** For more details on status, see our [product life cycle](#).

(2) **Material type:** When designated, preproduction parts are prototypes/experimental devices, and are not yet approved or released for full production. Testing and final process, including without limitation quality assurance, reliability performance testing, and/or process qualification, may not yet be complete, and this item is subject to further changes or possible discontinuation. If available for ordering, purchases will be subject to an additional waiver at checkout, and are intended for early internal evaluation purposes only. These items are sold without warranties of any kind.

(3) **RoHS values:** Yes, No, RoHS Exempt. See the [TI RoHS Statement](#) for additional information and value definition.

(4) **Lead finish/Ball material:** Parts may have multiple material finish options. Finish options are separated by a vertical ruled line. Lead finish/Ball material values may wrap to two lines if the finish value exceeds the maximum column width.

(5) **MSL rating/Peak reflow:** The moisture sensitivity level ratings and peak solder (reflow) temperatures. In the event that a part has multiple moisture sensitivity ratings, only the lowest level per JEDEC standards is shown. Refer to the shipping label for the actual reflow temperature that will be used to mount the part to the printed circuit board.

(6) **Part marking:** There may be an additional marking, which relates to the logo, the lot trace code information, or the environmental category of the part.

Multiple part markings will be inside parentheses. Only one part marking contained in parentheses and separated by a "~" will appear on a part. If a line is indented then it is a continuation of the previous line and the two combined represent the entire part marking for that device.

Important Information and Disclaimer:The information provided on this page represents TI's knowledge and belief as of the date that it is provided. TI bases its knowledge and belief on information provided by third parties, and makes no representation or warranty as to the accuracy of such information. Efforts are underway to better integrate information from third parties. TI has taken and continues to take reasonable steps to provide representative and accurate information but may not have conducted destructive testing or chemical analysis on incoming materials and chemicals. TI and TI suppliers consider certain information to be proprietary, and thus CAS numbers and other limited information may not be available for release.

In no event shall TI's liability arising out of such information exceed the total purchase price of the TI part(s) at issue in this document sold by TI to Customer on an annual basis.

IMPORTANT NOTICE AND DISCLAIMER

TI PROVIDES TECHNICAL AND RELIABILITY DATA (INCLUDING DATASHEETS), DESIGN RESOURCES (INCLUDING REFERENCE DESIGNS), APPLICATION OR OTHER DESIGN ADVICE, WEB TOOLS, SAFETY INFORMATION, AND OTHER RESOURCES "AS IS" AND WITH ALL FAULTS, AND DISCLAIMS ALL WARRANTIES, EXPRESS AND IMPLIED, INCLUDING WITHOUT LIMITATION ANY IMPLIED WARRANTIES OF MERCHANTABILITY, FITNESS FOR A PARTICULAR PURPOSE OR NON-INFRINGEMENT OF THIRD PARTY INTELLECTUAL PROPERTY RIGHTS.

These resources are intended for skilled developers designing with TI products. You are solely responsible for (1) selecting the appropriate TI products for your application, (2) designing, validating and testing your application, and (3) ensuring your application meets applicable standards, and any other safety, security, regulatory or other requirements.

These resources are subject to change without notice. TI grants you permission to use these resources only for development of an application that uses the TI products described in the resource. Other reproduction and display of these resources is prohibited. No license is granted to any other TI intellectual property right or to any third party intellectual property right. TI disclaims responsibility for, and you fully indemnify TI and its representatives against any claims, damages, costs, losses, and liabilities arising out of your use of these resources.

TI's products are provided subject to [TI's Terms of Sale](#), [TI's General Quality Guidelines](#), or other applicable terms available either on ti.com or provided in conjunction with such TI products. TI's provision of these resources does not expand or otherwise alter TI's applicable warranties or warranty disclaimers for TI products. Unless TI explicitly designates a product as custom or customer-specified, TI products are standard, catalog, general purpose devices.

TI objects to and rejects any additional or different terms you may propose.

Copyright © 2026, Texas Instruments Incorporated

Last updated 10/2025