

## CMOS Hex 'D'-Type Flip-Flop

### High-Voltage Types (20-Volt Rating)

■ CD40174B consists of six identical 'D'-type flip-flops having independent DATA inputs. The CLOCK and CLEAR inputs are common to all six units. Data is transferred to the Q outputs on the positive-going transition of the clock pulse. All six flip-flops are simultaneously reset by a low level on the CLEAR input.

The CD40174B types are supplied in 16-lead hermetic dual-in-line ceramic packages (F3A suffix), 16-lead dual-in-line plastic packages (E suffix), 16-lead small-outline packages (M, M96, MT, and NSR suffixes), and 16-lead thin shrink small-outline packages (PW and PWR suffixes).

### MAXIMUM RATINGS, Absolute-Maximum Values:

DC SUPPLY-VOLTAGE RANGE, (V <sub>DD</sub> )	-0.5V to +20V
Voltages referenced to V <sub>SS</sub> Terminal)	
INPUT VOLTAGE RANGE, ALL INPUTS	-0.5V to V <sub>DD</sub> + 0.5V
DC INPUT CURRENT, ANY ONE INPUT	±10mA
POWER DISSIPATION PER PACKAGE (P <sub>D</sub> ):	
For T <sub>A</sub> = -55°C to +100°C	500mW
For T <sub>A</sub> = +100°C to +125°C	Derate Linearly at 12mW/°C to 200mW
DEVICE DISSIPATION PER OUTPUT TRANSISTOR	
FOR T <sub>A</sub> = FULL PACKAGE-TEMPERATURE RANGE (All Package Types)	100mW
OPERATING-TEMPERATURE RANGE (T <sub>A</sub> )	-55°C to +125°C
STORAGE TEMPERATURE RANGE (T <sub>stg</sub> )	-65°C to +150°C
LEAD TEMPERATURE (DURING SOLDERING):	
At distance 1/16 ± 1/32 inch (1.59 ± 0.79mm) from case for 10s max	+265°C

### Features:

- 5-V, 10-V, and 15-V parametric rating
- Standardized symmetrical output characteristics
- 100% tested for quiescent current at 20 V
- Maximum input current of 1 μA at 18 V over full package-temperature range; 100 nA at 18 V and 25°C
- Noise margin (over full package-temperature range):  
1 V at V<sub>DD</sub> = 5 V  
2 V at V<sub>DD</sub> = 10 V  
2.5 V at V<sub>DD</sub> = 15 V
- Meets all requirements of JEDEC Tentative Standard No. 13A, "Standard Specifications for Description of 'B' Series CMOS Devices"

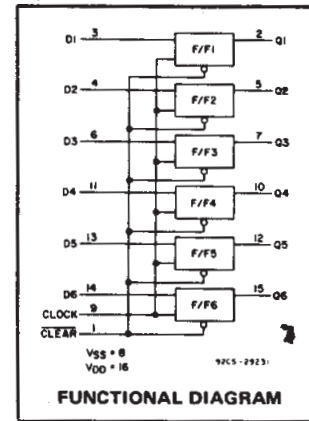

### Applications:

- Shift Registers
- Buffer/Storage Registers
- Pattern Generators

### TRUTH TABLE FOR 1 OF 6 FLIP-FLOPS

INPUTS		OUTPUT	
CLOCK	DATA	CLEAR	Q
0	0	1	0
0	1	1	1
1	X	1	NC
X	X	0	0

1 = High Level      X = Don't Care  
0 = Low Level      NC = No Change

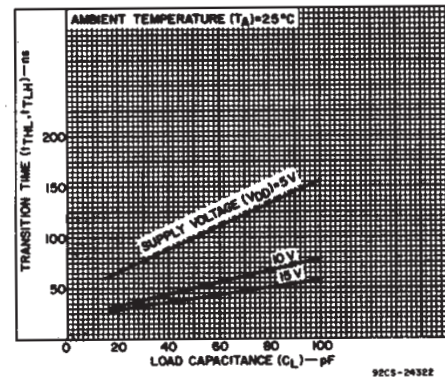
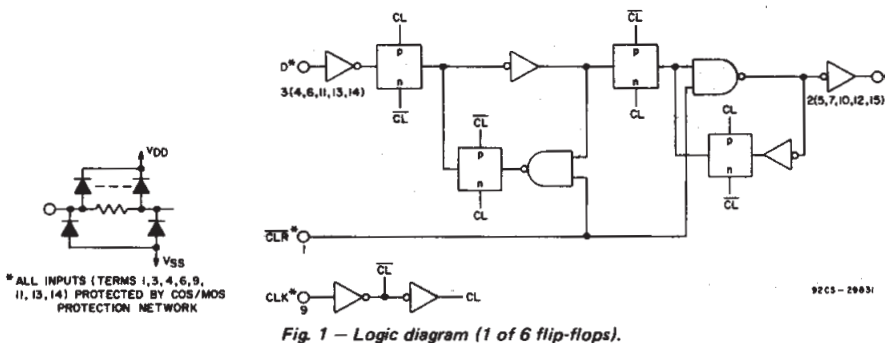

## CD40174B Types

**RECOMMENDED OPERATING CONDITIONS** at  $T_A = 25^\circ\text{C}$ , Except as Noted.

For maximum reliability, nominal operating conditions should be selected so that operation is always within the following ranges:

CHARACTERISTIC	$V_{DD}$ (V)	LIMITS		UNITS
		Min.	Max.	
Supply-Voltage Range (For $T_A =$ Full Package-Temperature Range)	—	3	18	V
Data Setup Time, $t_{SU}$	5 10 15	40 20 10	— — —	ns
Data Hold Time, $t_H$	5 10 15	80 40 30	— — —	ns
Clock Input Frequency, $f_{CL}$	5 10 15	— dc —	3.5 6 8	MHz
Clock Input Rise or Fall Time, $t_{rCL}$ , $t_{fCL}$	5 10 15	— — —	15 15 15	$\mu\text{s}$
Clock Input Pulse Width, $t_{WL}$ , $t_{WH}$	5 10 15	130 60 40	— — —	ns
Clear Pulse Width, $t_{WL}$	5 10 15	100 50 40	— — —	ns
Clear Removal Time, $t_{REM}$	5 10 15	0 0 0	— — —	ns

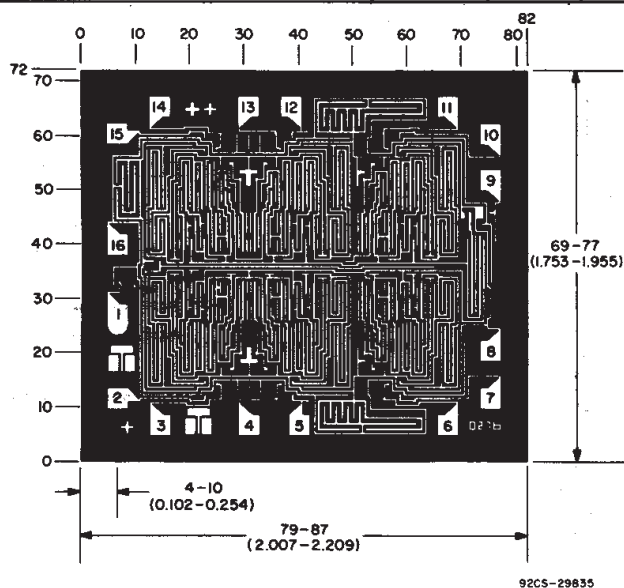

Dimensions and pad layout for CD40174BH.

Dimensions in parentheses are in millimeters and are derived from the basic inch dimensions as indicated. Grid graduations are in mils ( $10^{-3}$  inch).

The photographs and dimensions of each CMOS chip represent a chip when it is part of the wafer. When the wafer is separated into individual chips, the angle of cleavage may vary with respect to the chip face for different chips. The actual dimensions of the isolated chip, therefore, may differ slightly from the nominal dimensions shown. The user should consider a tolerance of  $-3$  mils to  $+16$  mils applicable to the nominal dimensions shown.

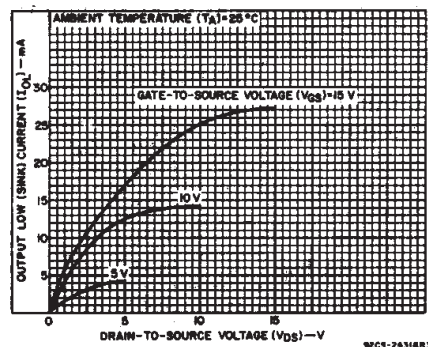

Fig. 3— Typical output low (sink) current characteristics.

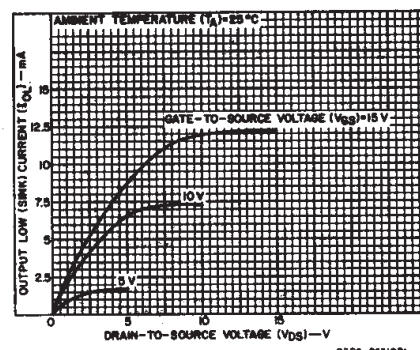

Fig. 4— Minimum output low (sink) current characteristics.

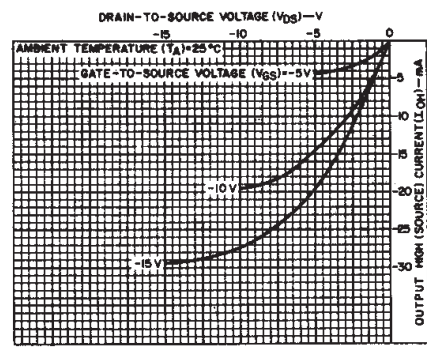

Fig. 5— Typical output high (source) current characteristics.

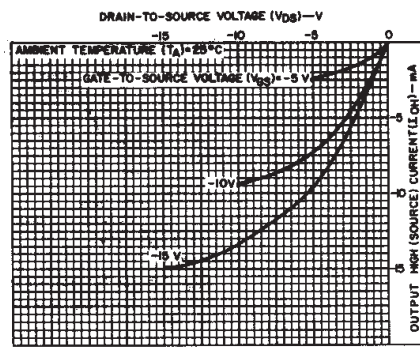

Fig. 6— Minimum output high (source) current characteristics.

3  
COMMERCIAL CMOS  
HIGH VOLTAGE ICs

# CD40174B Types

## STATIC ELECTRICAL CHARACTERISTICS

CHARACTERISTIC	CONDITIONS			LIMITS AT INDICATED TEMPERATURES (°C)							UNITS
	V <sub>O</sub> (V)	V <sub>IN</sub> (V)	V <sub>DD</sub> (V)	-55	-40	+85	+125	+25			
								Min.	Typ.	Max.	
Quiescent Device Current, I <sub>DD</sub> Max.	—	0.5	5	1	1	30	30	—	0.02	1	μA
	—	0.10	10	2	2	60	60	—	0.02	2	
	—	0.15	15	4	4	120	120	—	0.02	4	
	—	0.20	20	20	20	600	600	—	0.04	20	
Output Low (Sink) Current I <sub>OL</sub> Min.	0.4	0.5	5	0.64	0.61	0.42	0.36	0.51	1	—	mA
	0.5	0.10	10	1.6	1.5	1.1	0.9	1.3	2.6	—	
	1.5	0.15	15	4.2	4	2.8	2.4	3.4	6.8	—	
Output High (Source) Current, I <sub>OH</sub> Min.	4.6	0.5	5	-0.64	-0.61	-0.42	-0.36	-0.51	-1	—	mA
	2.5	0.5	5	-2	-1.8	-1.3	-1.15	-1.6	-3.2	—	
	9.5	0.10	10	-1.6	-1.5	-1.1	-0.9	-1.3	-2.6	—	
	13.5	0.15	15	-4.2	-4	-2.8	-2.4	-3.4	-6.8	—	
Output Voltage: Low-Level, V <sub>OL</sub> Max.	—	0.5	5	0.05				—	0	0.05	V
	—	0.10	10	0.05				—	—	0.05	
	—	0.15	15	0.05				—	0	0.05	
Output Voltage: High-Level, V <sub>OH</sub> Min.	—	0.5	5	4.95				4.95	5	—	V
	—	0.10	10	9.95				9.95	10	—	
	—	0.15	15	14.95				14.95	15	—	
Input Low Voltage, V <sub>IL</sub> Max.	0.5, 4.5	—	5	1.5				—	—	1.5	V
	1.9	—	10	3				—	—	3	
	1.5, 13.5	—	15	4				—	—	4	
Input High Voltage, V <sub>IH</sub> Min.	0.5, 4.5	—	5	3.5				3.5	—	—	V
	1.9	—	10	7				7	—	—	
	1.5, 13.5	—	15	11				11	—	—	
Input Current I <sub>IN</sub> Max.	—	0.18	18	±0.1	±0.1	±1	±1	—	±10 <sup>-5</sup>	±0.1	μA

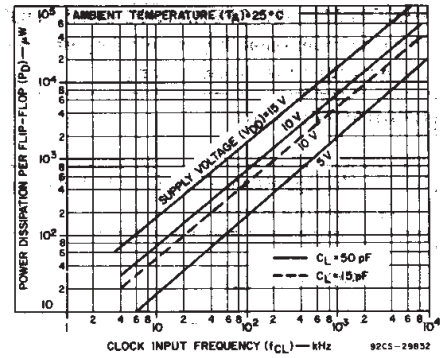

Fig. 7—Typical dynamic power dissipation as a function of CLOCK frequency.

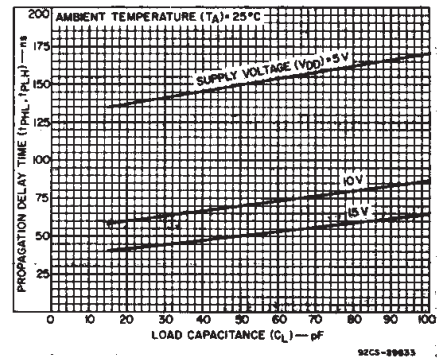

Fig. 8—Typical propagation delay time (CLOCK to OUTPUT) as a function of load capacitance.

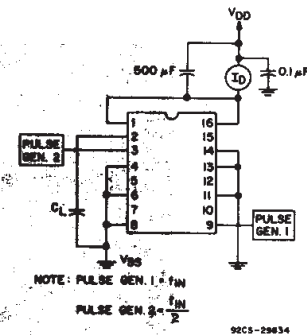

Fig. 9—Dynamic power dissipation test circuit.

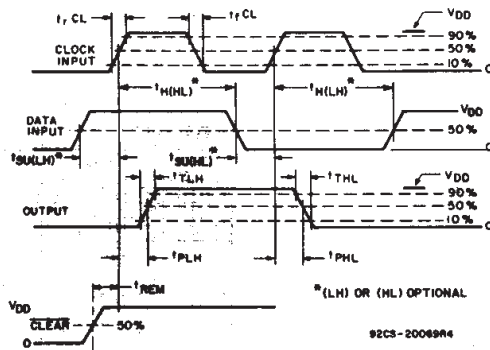

Fig. 10—Definition of setup, hold, propagation delay, and removal times.

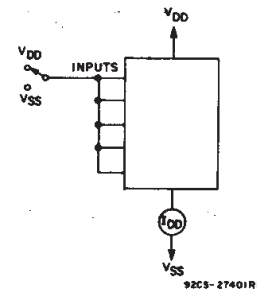

Fig. 11—Quiescent device current test circuit.

# CD40174B Types

DYNAMIC ELECTRICAL CHARACTERISTICS at  $T_A = 25^\circ\text{C}$ ;  
 Input  $t_r, t_f = 20\text{ ns}$ ,  $C_L = 50\text{ pF}$ ,  $R_L = 200\text{ k}\Omega$

CHARACTERISTIC	TEST CONDITIONS $V_{DD}$ (V)	LIMITS			UNITS
		Min.	Typ.	Max.	
Propagation Delay Time Clock to Output, $t_{PHL}, t_{PLH}$	5	—	150	300	ns
	10	—	70	140	
	15	—	50	100	
Clear to Output, $t_{PHL}$	5	—	100	200	ns
	10	—	50	100	
	15	—	40	80	
Transition Time, $t_{THL}, t_{TLH}$	5	—	100	200	ns
	10	—	50	100	
	15	—	40	80	
Minimum Pulse Width, Clock, $t_{WL}, t_{WH}$	5	—	65	130	ns
	10	—	30	60	
	15	—	20	40	
Clear, $t_{WL}$	5	—	50	100	ns
	10	—	25	50	
	15	—	20	40	
Minimum Data Setup Time, $t_{SU}$	5	—	20	40	ns
	10	—	10	20	
	15	—	0	10	
Minimum Data Hold Time, $t_H$	5	—	40	80	ns
	10	—	20	40	
	15	—	15	30	
Maximum Clock Frequency, $f_{CL}$	5	3.5	7	—	MHz
	10	6	12	—	
	15	8	16	—	
Maximum Clock Rise or Fall Time, $t_{rCL}, t_{fCL}$	5	15	—	—	$\mu\text{s}$
	10	15	—	—	
	15	15	—	—	
Input Capacitance, $C_{IN}$	Clear	—	25	40	pF
	All other	—	5	7.5	
Minimum Clear Removal Time, $t_{REM}$	5	—	-40	0	ns
	10	—	-15	0	
	15	—	-10	0	

3  
 COMMERCIAL CMOS  
 HIGH VOLTAGE ICs

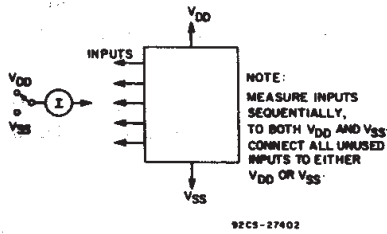

Fig. 12 - Input current test circuit.

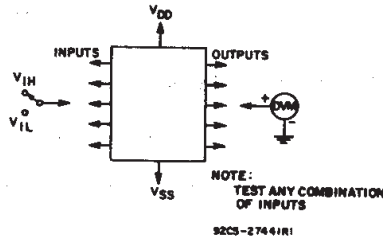
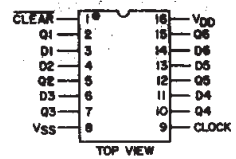

Fig. 13 - Input voltage test circuit.

### TERMINAL ASSIGNMENT



**PACKAGING INFORMATION**

Orderable part number	Status (1)	Material type (2)	Package   Pins	Package qty   Carrier	RoHS (3)	Lead finish/ Ball material (4)	MSL rating/ Peak reflow (5)	Op temp (°C)	Part marking (6)
<a href="#">CD40174BE</a>	Active	Production	PDIP (N)   16	25   TUBE	Yes	NIPDAU	N/A for Pkg Type	-55 to 125	CD40174BE
CD40174BE.A	Active	Production	PDIP (N)   16	25   TUBE	Yes	NIPDAU	N/A for Pkg Type	-55 to 125	CD40174BE
CD40174BEE4	Active	Production	PDIP (N)   16	25   TUBE	Yes	NIPDAU	N/A for Pkg Type	-55 to 125	CD40174BE
<a href="#">CD40174BF</a>	Active	Production	CDIP (J)   16	25   TUBE	No	SNPB	N/A for Pkg Type	-55 to 125	CD40174BF
CD40174BF.A	Active	Production	CDIP (J)   16	25   TUBE	No	SNPB	N/A for Pkg Type	-55 to 125	CD40174BF
<a href="#">CD40174BF3A</a>	Active	Production	CDIP (J)   16	25   TUBE	No	SNPB	N/A for Pkg Type	-55 to 125	CD40174BF3A
CD40174BF3A.A	Active	Production	CDIP (J)   16	25   TUBE	No	SNPB	N/A for Pkg Type	-55 to 125	CD40174BF3A
<a href="#">CD40174BM</a>	Obsolete	Production	SOIC (D)   16	-	-	Call TI	Call TI	-55 to 125	CD40174BM
<a href="#">CD40174BM96</a>	Active	Production	SOIC (D)   16	2500   LARGE T&R	Yes	NIPDAU	Level-1-260C-UNLIM	-55 to 125	CD40174BM
CD40174BM96.A	Active	Production	SOIC (D)   16	2500   LARGE T&R	Yes	NIPDAU	Level-1-260C-UNLIM	-55 to 125	CD40174BM
<a href="#">CD40174BNSR</a>	Active	Production	SOP (NS)   16	2000   LARGE T&R	Yes	NIPDAU	Level-1-260C-UNLIM	-55 to 125	CD40174B
CD40174BNSR.A	Active	Production	SOP (NS)   16	2000   LARGE T&R	Yes	NIPDAU	Level-1-260C-UNLIM	-55 to 125	CD40174B
<a href="#">CD40174BPW</a>	Active	Production	TSSOP (PW)   16	90   TUBE	Yes	NIPDAU	Level-1-260C-UNLIM	-55 to 125	CM0174B
CD40174BPW.A	Active	Production	TSSOP (PW)   16	90   TUBE	Yes	NIPDAU	Level-1-260C-UNLIM	-55 to 125	CM0174B

(1) **Status:** For more details on status, see our [product life cycle](#).

(2) **Material type:** When designated, preproduction parts are prototypes/experimental devices, and are not yet approved or released for full production. Testing and final process, including without limitation quality assurance, reliability performance testing, and/or process qualification, may not yet be complete, and this item is subject to further changes or possible discontinuation. If available for ordering, purchases will be subject to an additional waiver at checkout, and are intended for early internal evaluation purposes only. These items are sold without warranties of any kind.

(3) **RoHS values:** Yes, No, RoHS Exempt. See the [TI RoHS Statement](#) for additional information and value definition.

(4) **Lead finish/Ball material:** Parts may have multiple material finish options. Finish options are separated by a vertical ruled line. Lead finish/Ball material values may wrap to two lines if the finish value exceeds the maximum column width.

(5) **MSL rating/Peak reflow:** The moisture sensitivity level ratings and peak solder (reflow) temperatures. In the event that a part has multiple moisture sensitivity ratings, only the lowest level per JEDEC standards is shown. Refer to the shipping label for the actual reflow temperature that will be used to mount the part to the printed circuit board.

(6) **Part marking:** There may be an additional marking, which relates to the logo, the lot trace code information, or the environmental category of the part.

Multiple part markings will be inside parentheses. Only one part marking contained in parentheses and separated by a "~" will appear on a part. If a line is indented then it is a continuation of the previous line and the two combined represent the entire part marking for that device.

**Important Information and Disclaimer:** The information provided on this page represents TI's knowledge and belief as of the date that it is provided. TI bases its knowledge and belief on information provided by third parties, and makes no representation or warranty as to the accuracy of such information. Efforts are underway to better integrate information from third parties. TI has taken and continues to take reasonable steps to provide representative and accurate information but may not have conducted destructive testing or chemical analysis on incoming materials and chemicals. TI and TI suppliers consider certain information to be proprietary, and thus CAS numbers and other limited information may not be available for release.

In no event shall TI's liability arising out of such information exceed the total purchase price of the TI part(s) at issue in this document sold by TI to Customer on an annual basis.

**OTHER QUALIFIED VERSIONS OF CD40174B, CD40174B-MIL :**

- Catalog : [CD40174B](#)
- Military : [CD40174B-MIL](#)

NOTE: Qualified Version Definitions:

- Catalog - TI's standard catalog product
- Military - QML certified for Military and Defense Applications

**TAPE AND REEL INFORMATION**

**QUADRANT ASSIGNMENTS FOR PIN 1 ORIENTATION IN TAPE**

\*All dimensions are nominal

Device	Package Type	Package Drawing	Pins	SPQ	Reel Diameter (mm)	Reel Width W1 (mm)	A0 (mm)	B0 (mm)	K0 (mm)	P1 (mm)	W (mm)	Pin1 Quadrant
CD40174BM96	SOIC	D	16	2500	330.0	16.4	6.5	10.3	2.1	8.0	16.0	Q1
CD40174BNSR	SOP	NS	16	2000	330.0	16.4	8.1	10.4	2.5	12.0	16.0	Q1

**TAPE AND REEL BOX DIMENSIONS**

\*All dimensions are nominal

Device	Package Type	Package Drawing	Pins	SPQ	Length (mm)	Width (mm)	Height (mm)
CD40174BM96	SOIC	D	16	2500	353.0	353.0	32.0
CD40174BNSR	SOP	NS	16	2000	353.0	353.0	32.0

**TUBE**

\*All dimensions are nominal

Device	Package Name	Package Type	Pins	SPQ	L (mm)	W (mm)	T (μm)	B (mm)
CD40174BE	N	PDIP	16	25	506	13.97	11230	4.32
CD40174BE	N	PDIP	16	25	506	13.97	11230	4.32
CD40174BE.A	N	PDIP	16	25	506	13.97	11230	4.32
CD40174BE.A	N	PDIP	16	25	506	13.97	11230	4.32
CD40174BEE4	N	PDIP	16	25	506	13.97	11230	4.32
CD40174BEE4	N	PDIP	16	25	506	13.97	11230	4.32
CD40174BPW	PW	TSSOP	16	90	530	10.2	3600	3.5
CD40174BPW.A	PW	TSSOP	16	90	530	10.2	3600	3.5

D (R-PDSO-G16)

PLASTIC SMALL OUTLINE



- NOTES:
- A. All linear dimensions are in inches (millimeters).
  - B. This drawing is subject to change without notice.
  - C. Body length does not include mold flash, protrusions, or gate burrs. Mold flash, protrusions, or gate burrs shall not exceed 0.006 (0,15) each side.
  - D. Body width does not include interlead flash. Interlead flash shall not exceed 0.017 (0,43) each side.
  - E. Reference JEDEC MS-012 variation AC.

J (R-GDIP-T\*\*)

14 LEADS SHOWN

CERAMIC DUAL IN-LINE PACKAGE



DIM \ PINS **	14	16	18	20
A	0.300 (7,62) BSC	0.300 (7,62) BSC	0.300 (7,62) BSC	0.300 (7,62) BSC
B MAX	0.785 (19,94)	.840 (21,34)	0.960 (24,38)	1.060 (26,92)
B MIN	—	—	—	—
C MAX	0.300 (7,62)	0.300 (7,62)	0.310 (7,87)	0.300 (7,62)
C MIN	0.245 (6,22)	0.245 (6,22)	0.220 (5,59)	0.245 (6,22)



4040083/F 03/03

- NOTES:
- All linear dimensions are in inches (millimeters).
  - This drawing is subject to change without notice.
  - This package is hermetically sealed with a ceramic lid using glass frit.
  - Index point is provided on cap for terminal identification only on press ceramic glass frit seal only.
  - Falls within MIL STD 1835 GDIP1-T14, GDIP1-T16, GDIP1-T18 and GDIP1-T20.

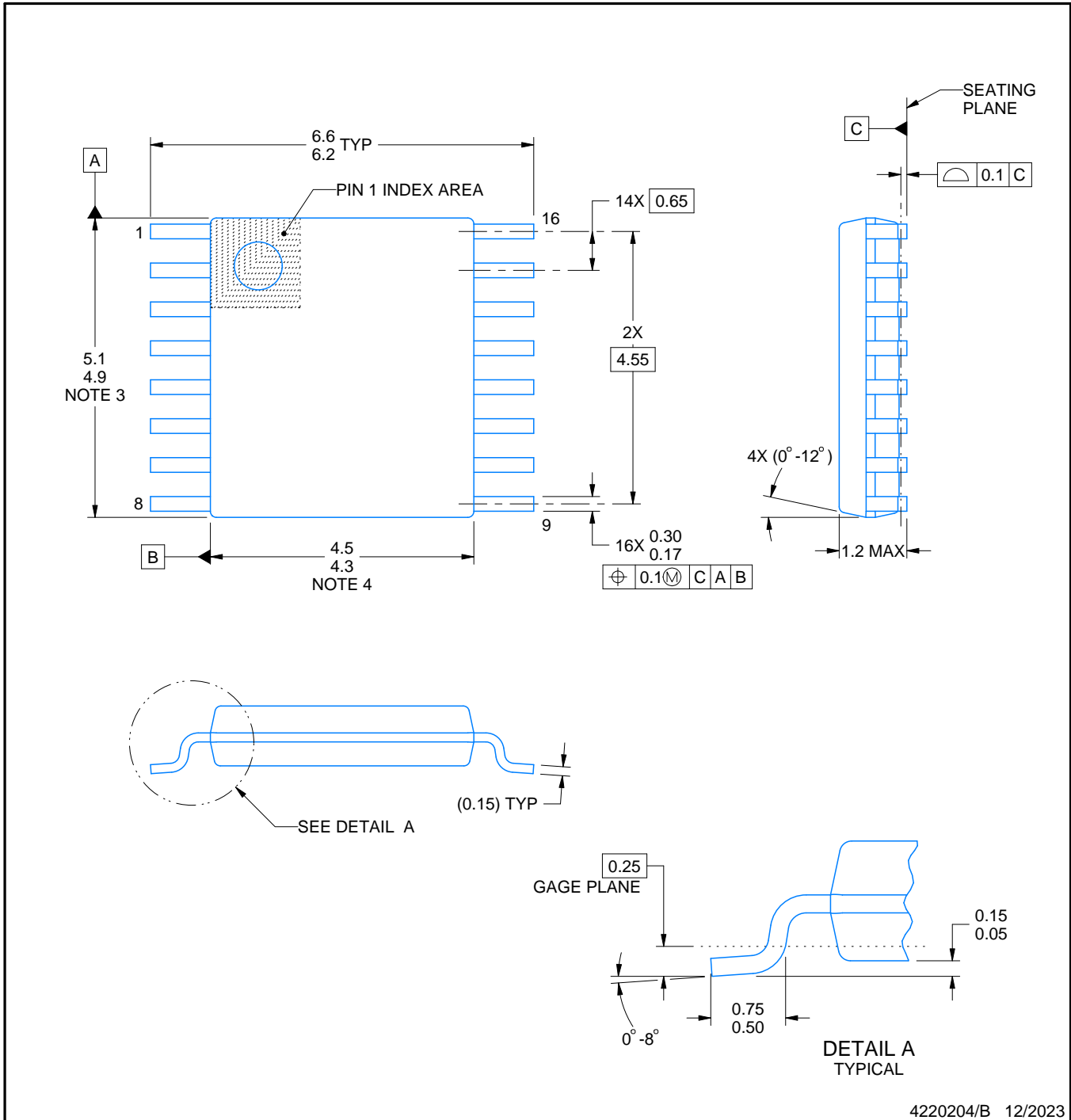
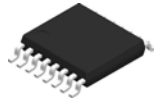

4220204/B 12/2023

NOTES:

1. All linear dimensions are in millimeters. Any dimensions in parenthesis are for reference only. Dimensioning and tolerancing per ASME Y14.5M.
2. This drawing is subject to change without notice.
3. This dimension does not include mold flash, protrusions, or gate burrs. Mold flash, protrusions, or gate burrs shall not exceed 0.15 mm per side.
4. This dimension does not include interlead flash. Interlead flash shall not exceed 0.25 mm per side.
5. Reference JEDEC registration MO-153.

# EXAMPLE BOARD LAYOUT

PW0016A

TSSOP - 1.2 mm max height

SMALL OUTLINE PACKAGE

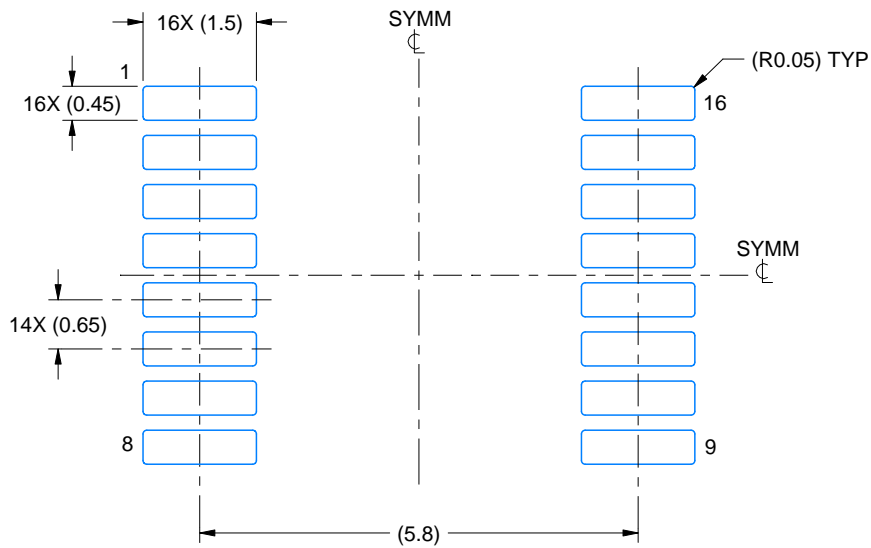

LAND PATTERN EXAMPLE  
EXPOSED METAL SHOWN  
SCALE: 10X

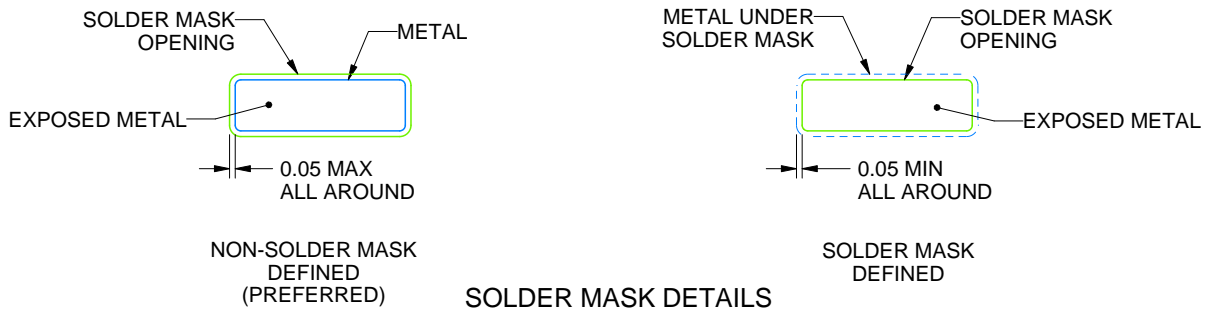

SOLDER MASK DETAILS

4220204/B 12/2023

NOTES: (continued)

- 6. Publication IPC-7351 may have alternate designs.
- 7. Solder mask tolerances between and around signal pads can vary based on board fabrication site.

# EXAMPLE STENCIL DESIGN

PW0016A

TSSOP - 1.2 mm max height

SMALL OUTLINE PACKAGE

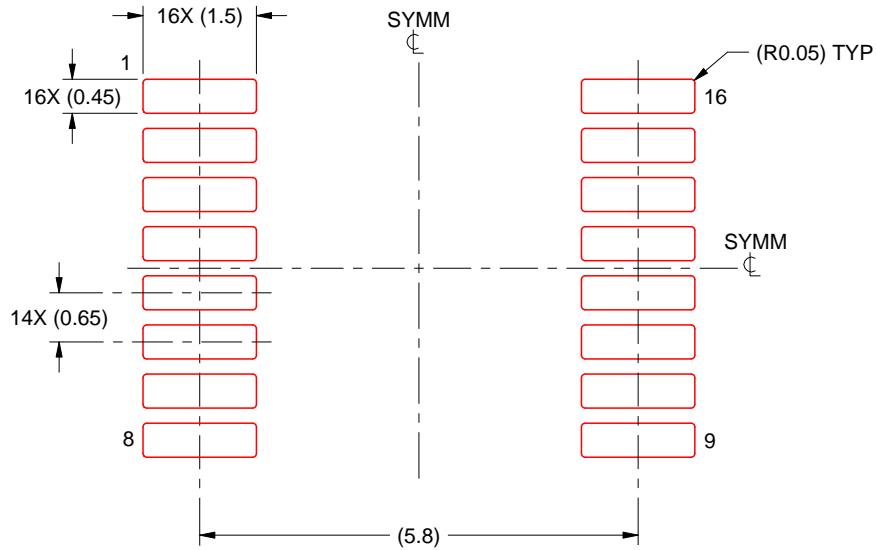

SOLDER PASTE EXAMPLE  
BASED ON 0.125 mm THICK STENCIL  
SCALE: 10X

4220204/B 12/2023

NOTES: (continued)

8. Laser cutting apertures with trapezoidal walls and rounded corners may offer better paste release. IPC-7525 may have alternate design recommendations.
9. Board assembly site may have different recommendations for stencil design.

N (R-PDIP-T\*\*)

PLASTIC DUAL-IN-LINE PACKAGE

16 PINS SHOWN



- NOTES:
- A. All linear dimensions are in inches (millimeters).
  - B. This drawing is subject to change without notice.
  - Falls within JEDEC MS-001, except 18 and 20 pin minimum body length (Dim A).
  - The 20 pin end lead shoulder width is a vendor option, either half or full width.



# PACKAGE OUTLINE

## NS0016A

### SOP - 2.00 mm max height

SOP



4220735/A 12/2021

#### NOTES:

1. All linear dimensions are in millimeters. Dimensions in parenthesis are for reference only. Dimensioning and tolerancing per ASME Y14.5M.
2. This drawing is subject to change without notice.
3. This dimension does not include mold flash, protrusions, or gate burrs. Mold flash, protrusions, or gate burrs shall not exceed 0.15 mm, per side.
4. This dimension does not include interlead flash. Interlead flash shall not exceed 0.25 mm, per side.

# EXAMPLE BOARD LAYOUT

NS0016A

SOP - 2.00 mm max height

SOP



## SOLDER MASK DETAILS

4220735/A 12/2021

NOTES: (continued)

5. Publication IPC-7351 may have alternate designs.

6. Solder mask tolerances between and around signal pads can vary based on board fabrication site.

# EXAMPLE STENCIL DESIGN

NS0016A

SOP - 2.00 mm max height

SOP



SOLDER PASTE EXAMPLE  
BASED ON 0.125 mm THICK STENCIL  
SCALE:7X

4220735/A 12/2021

NOTES: (continued)

7. Laser cutting apertures with trapezoidal walls and rounded corners may offer better paste release. IPC-7525 may have alternate design recommendations.
8. Board assembly site may have different recommendations for stencil design.

## IMPORTANT NOTICE AND DISCLAIMER

TI PROVIDES TECHNICAL AND RELIABILITY DATA (INCLUDING DATASHEETS), DESIGN RESOURCES (INCLUDING REFERENCE DESIGNS), APPLICATION OR OTHER DESIGN ADVICE, WEB TOOLS, SAFETY INFORMATION, AND OTHER RESOURCES "AS IS" AND WITH ALL FAULTS, AND DISCLAIMS ALL WARRANTIES, EXPRESS AND IMPLIED, INCLUDING WITHOUT LIMITATION ANY IMPLIED WARRANTIES OF MERCHANTABILITY, FITNESS FOR A PARTICULAR PURPOSE OR NON-INFRINGEMENT OF THIRD PARTY INTELLECTUAL PROPERTY RIGHTS.

These resources are intended for skilled developers designing with TI products. You are solely responsible for (1) selecting the appropriate TI products for your application, (2) designing, validating and testing your application, and (3) ensuring your application meets applicable standards, and any other safety, security, regulatory or other requirements.

These resources are subject to change without notice. TI grants you permission to use these resources only for development of an application that uses the TI products described in the resource. Other reproduction and display of these resources is prohibited. No license is granted to any other TI intellectual property right or to any third party intellectual property right. TI disclaims responsibility for, and you fully indemnify TI and its representatives against any claims, damages, costs, losses, and liabilities arising out of your use of these resources.

TI's products are provided subject to [TI's Terms of Sale](#), [TI's General Quality Guidelines](#), or other applicable terms available either on [ti.com](#) or provided in conjunction with such TI products. TI's provision of these resources does not expand or otherwise alter TI's applicable warranties or warranty disclaimers for TI products. Unless TI explicitly designates a product as custom or customer-specified, TI products are standard, catalog, general purpose devices.

TI objects to and rejects any additional or different terms you may propose.

Copyright © 2026, Texas Instruments Incorporated

Last updated 10/2025