

N-Channel NexFET™ Power MOSFETs

 Check for Samples: [CSD16407Q5](#)

FEATURES

- **Ultralow Qg and Qgd**
- **Low Thermal Resistance**
- **Avalanche Rated**
- **SON 5-mm × 6-mm Plastic Package**

APPLICATIONS

- **Point-of-Load Synchronous Buck Converter for Applications in Networking, Telecom and Computing Systems**
- **Optimized for Synchronous FET Applications**

DESCRIPTION

The NexFET™ power MOSFET has been designed to minimize losses in power conversion applications.

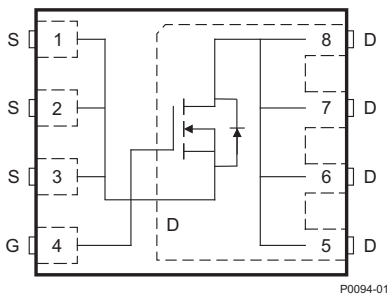
Top View

PRODUCT SUMMARY

V_{DS}	Drain-to-source voltage	25	V
Q_g	Gate charge, total (4.5 V)	13.3	nC
Q_{gd}	Gate charge, gate-to-drain	3.5	nC
$R_{DS(on)}$	Drain-to-source on-resistance	$V_{GS} = 4.5\text{ V}$	2.5 mΩ
		$V_{GS} = 10\text{ V}$	1.8 mΩ
$V_{GS(th)}$	Threshold voltage	1.6	V

ORDERING INFORMATION

Device	Package	Media	Qty	Ship
CSD16407Q5	SON 5 × 6 plastic package	13-inch reel	2500	Tape and reel

ABSOLUTE MAXIMUM RATINGS

$T_A = 25^\circ\text{C}$ unless otherwise stated		VALUE	UNIT
V_{DS}	Drain-to-source voltage	25	V
V_{GS}	Gate-to-source voltage	+16 / -12	V
I_D	Continuous drain current, $T_C = 25^\circ\text{C}$	100	A
	Continuous drain current ⁽¹⁾	31	A
I_{DM}	Pulsed drain current, $T_A = 25^\circ\text{C}$ ⁽²⁾	200	A
P_D	Power dissipation ⁽¹⁾	3.1	W
T_J, T_{STG}	Operating junction and storage temperature range	-55 to 150	°C
E_{AS}	Avalanche energy, single pulse $I_D = 66\text{ A}, L = 0.1\text{ mH}, R_G = 25\ \Omega$	218	mJ

- (1) $R_{\theta JA} = 40^\circ\text{C/W}$ on 1 in² (6.45 cm²) Cu [2 oz. (0.071 mm thick)] on 0.060-inch (1.52-mm) thick FR4 PCB.
- (2) Pulse duration $\leq 300\ \mu\text{s}$, duty cycle $\leq 2\%$

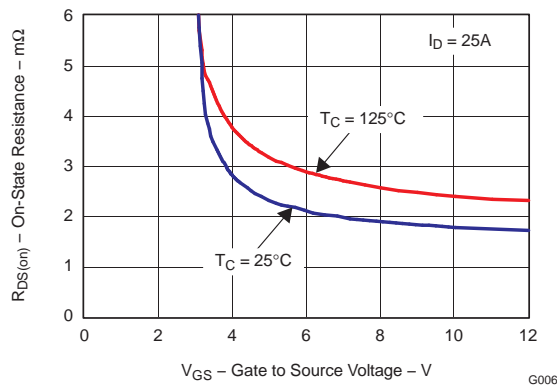
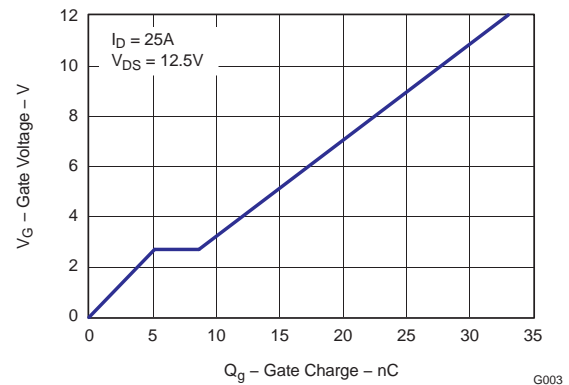
 $r_{DS(on)}$ vs V_{GS}

Gate Charge

Please be aware that an important notice concerning availability, standard warranty, and use in critical applications of Texas Instruments semiconductor products and disclaimers thereto appears at the end of this data sheet.

NexFET is a trademark of Texas Instruments.

ELECTRICAL CHARACTERISTICS

(T_A = 25°C unless otherwise stated)

PARAMETER		TEST CONDITIONS	MIN	TYP	MAX	UNIT
Static Characteristics						
B _V DSS	Drain-to-source voltage	V _{GS} = 0 V, I _D = 250 μA	25			V
I _{DSS}	Drain-to-source leakage current	V _{GS} = 0 V, V _{DS} = 20 V			1	μA
I _{GSS}	Gate-to-source leakage current	V _{DS} = 0 V, V _{GS} = 16 V to –12 V			100	nA
V _{GS(th)}	Gate-to-source threshold voltage	V _{DS} = V _{GS} , I _D = 250 μA	1.3	1.6	1.9	V
r _{DS(on)}	Drain-to-source on-resistance	V _{GS} = 4.5 V, I _D = 25 A		2.5	3.3	mΩ
		V _{GS} = 10 V, I _D = 25 A		1.8	2.4	mΩ
g _{fs}	Transconductance	V _{DS} = 15 V, I _D = 25 A		111		S
Dynamic Characteristics						
C _{ISS}	Input capacitance	V _{GS} = 0 V, V _{DS} = 12.5 V, f = 1 MHz		2040	2660	pF
C _{OSS}	Output capacitance			1600	2080	pF
C _{RSS}	Reverse transfer capacitance			115	160	pF
R _g	Series gate resistance	V _{DS} = 12.5 V, I _D = 25 A		1.2	2.4	Ω
Q _g	Gate charge total (4.5 V)			13.3	18	nC
Q _{gd}	Gate charge, gate-to-drain			3.5		nC
Q _{gs}	Gate charge, gate-to-source			5.3		nC
Q _{g(th)}	Gate charge at V _{th}			3.1		nC
Q _{OSS}	Output charge	V _{DS} = 13.5 V, V _{GS} = 0 V		33		nC
t _{d(on)}	Turnon delay time	V _{DS} = 12.5 V, V _{GS} = 4.5 V, I _D = 25 A R _G = 2 Ω		11.9		ns
t _r	Rise time			18.4		ns
t _{d(off)}	Turnoff delay time			16		ns
t _f	Fall time			9		ns
Diode Characteristics						
V _{SD}	Diode forward voltage	I _S = 25 A, V _{GS} = 0 V		0.8	1	V
Q _{rr}	Reverse recovery charge	V _{DD} = 13.5 V, I _F = 25 A, di/dt = 300 A/μs		41		nC
t _{rr}	Reverse recovery time	V _{DD} = 13.5 V, I _F = 25 A, di/dt = 300 A/μs		34		ns

THERMAL CHARACTERISTICS

(T_A = 25°C unless otherwise stated)

PARAMETER		MIN	TYP	MAX	UNIT
R _{θJC}	Thermal resistance, junction-to-case ⁽¹⁾			1.1	°C/W
R _{θJA}	Thermal resistance, junction-to-ambient ^{(1) (2)}			51	°C/W

- (1) R_{θJC} is determined with the device mounted on a 1-inch (2.54-cm) square 2-oz (0.071-mm thick) Cu pad on a 1.5-inch (3.81-cm) × 1.5-inch (3.81-cm) × 0.060-inch (1.52-mm) thick FR4 board. R_{θJC} is specified by design, whereas R_{θJA} is determined by the user's board design.
- (2) Device mounted on FR4 material with 1 inch² (6.45 cm²) of 2-oz. (0.071-mm thick) Cu.



Max $R_{\theta JA} = 50^{\circ}\text{C/W}$
when mounted on 1
inch² (6.45 cm²) of
2-oz. (0.071-mm thick)
Cu.

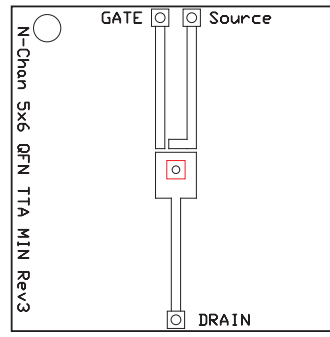

Max $R_{\theta JA} = 121^{\circ}\text{C/W}$
when mounted on
minimum pad area of
2-oz. (0.071-mm thick)
Cu.

TYPICAL MOSFET CHARACTERISTICS

($T_A = 25^{\circ}\text{C}$ unless otherwise stated)

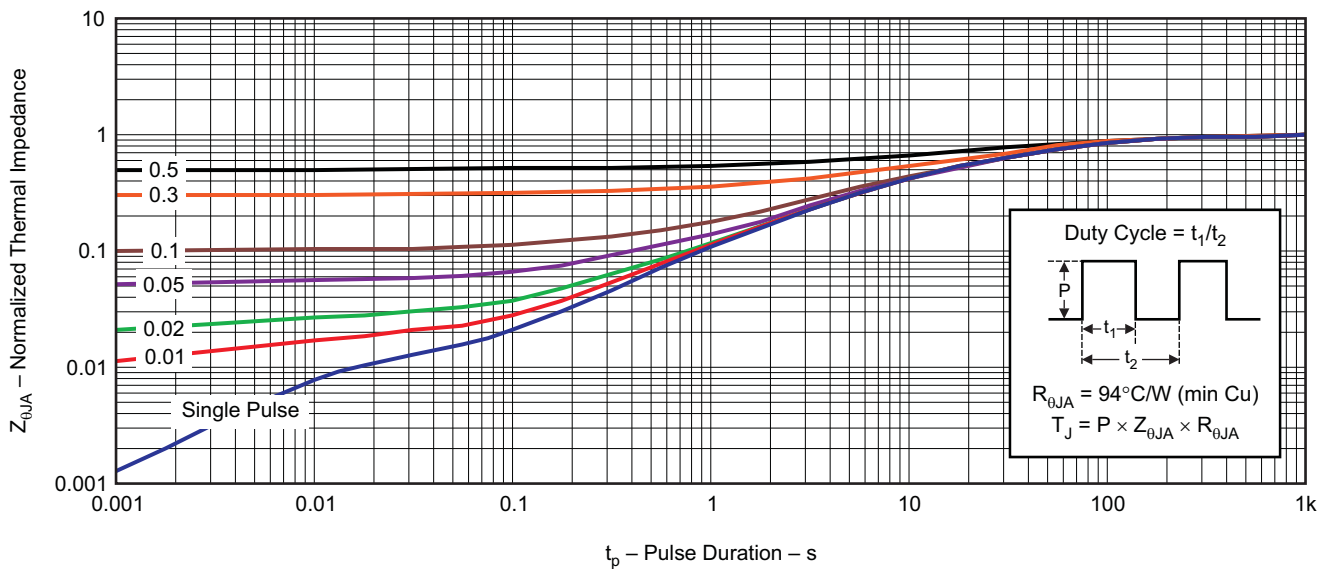

Figure 1. Transient Thermal Impedance

G012

TYPICAL MOSFET CHARACTERISTICS (continued)

($T_A = 25^\circ\text{C}$ unless otherwise stated)

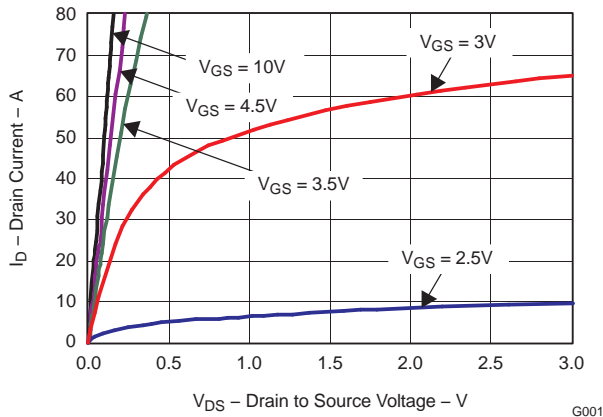

Figure 2. Saturation Characteristics

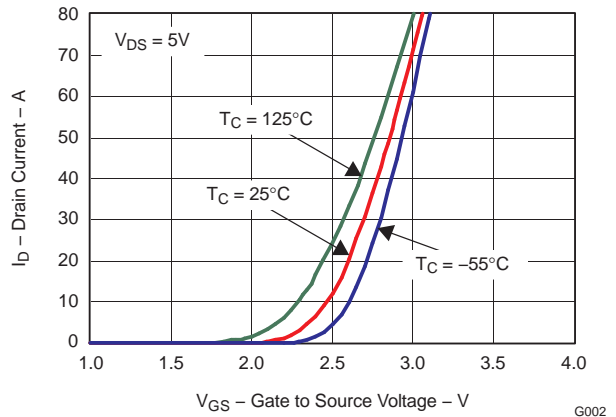

Figure 3. Transfer Characteristics

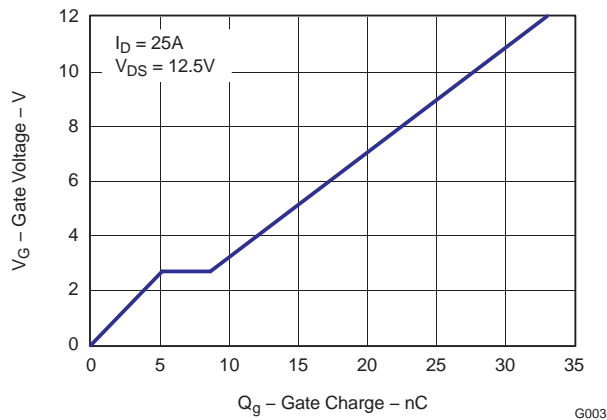

Figure 4. Gate Charge

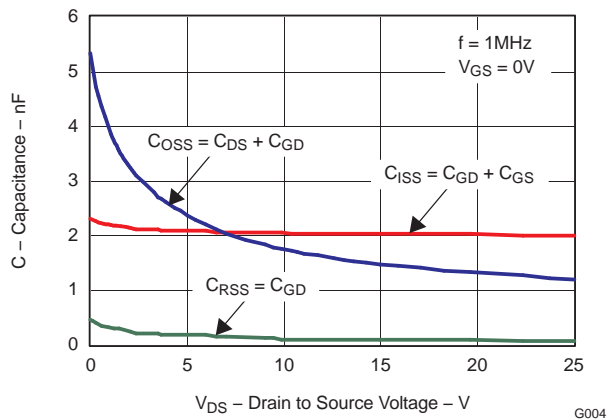

Figure 5. Capacitance

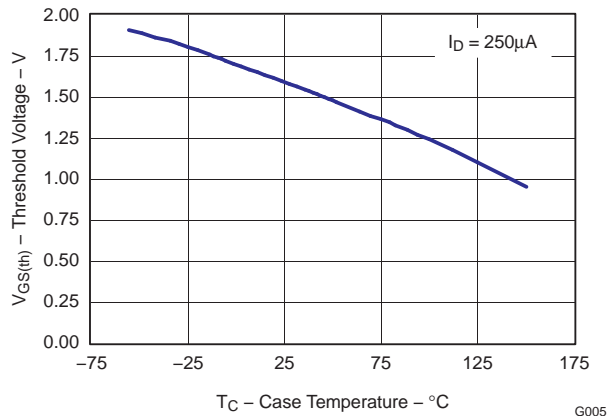

Figure 6. Threshold Voltage vs. Temperature

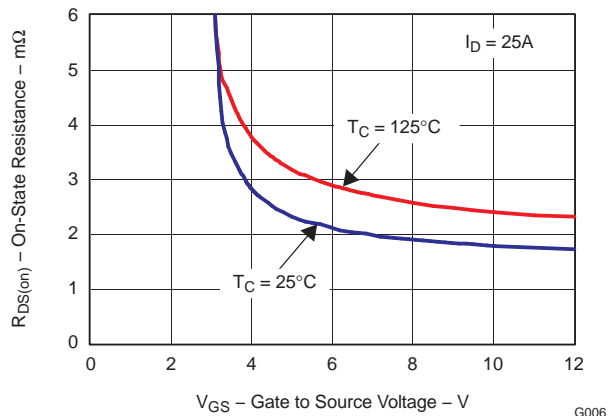

Figure 7. On Resistance vs. Gate Voltage

TYPICAL MOSFET CHARACTERISTICS (continued)

($T_A = 25^\circ\text{C}$ unless otherwise stated)

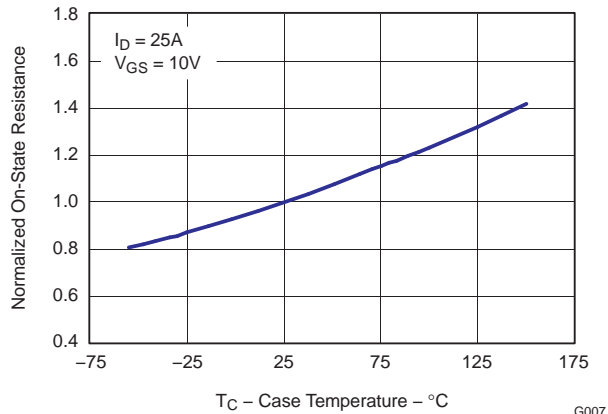

Figure 8. On Resistance vs. Temperature

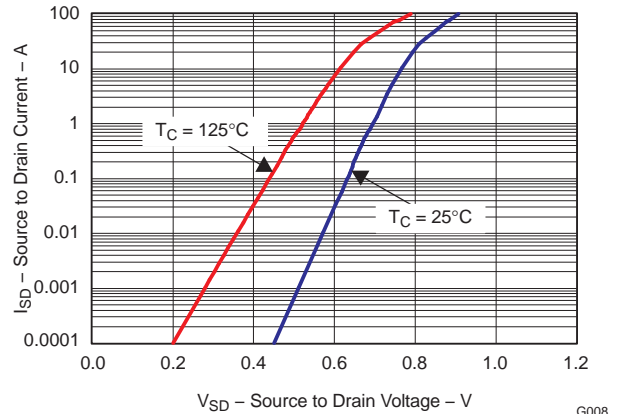

Figure 9. Typical Diode Forward Voltage

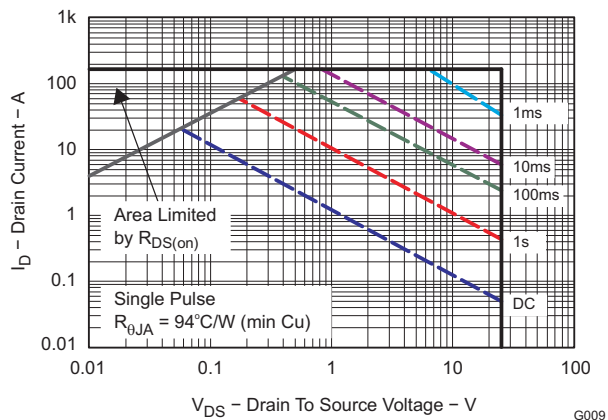

Figure 10. Maximum Safe Operating Area

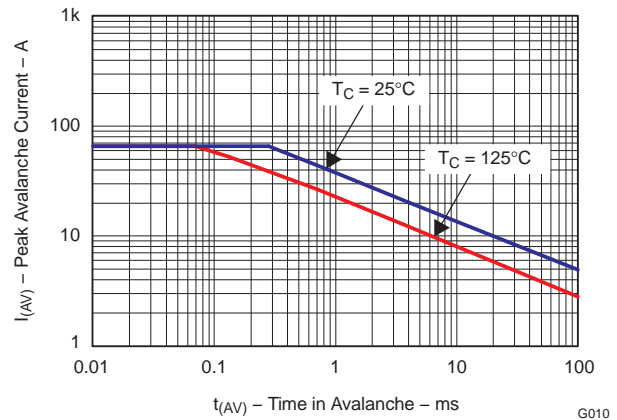

Figure 11. Single Pulse Unclamped Inductive Switching

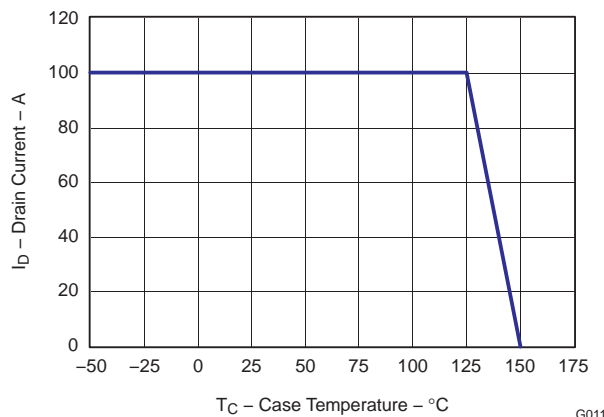

Figure 12. Maximum Drain Current vs. Temperature

MECHANICAL DATA

Q5 Package Dimensions



M0140-01

DIM	MILLIMETERS		INCHES	
	MIN	MAX	MIN	MAX
A	0.950	1.050	0.037	0.039
b	0.360	0.460	0.014	0.018
c	0.150	0.250	0.006	0.010
c1	0.150	0.250	0.006	0.010
D1	4.900	5.100	0.193	0.201
D2	4.320	4.520	0.170	0.178
E	4.900	5.100	0.193	0.201
E1	5.900	6.100	0.232	0.240
E2	3.920	4.12	0.154	0.162
e	1.27 TYP		0.050	
L	0.510	0.710	0.020	0.028
theta	0.00	-	-	-
K	0.760	-	0.030	-

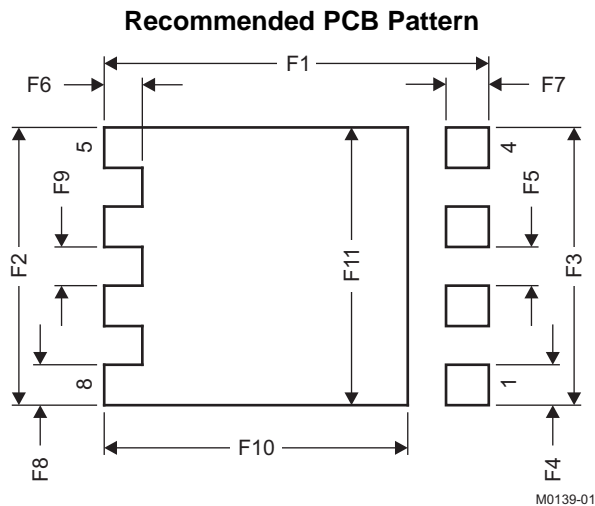

DIM	MILLIMETERS		INCHES	
	MIN	MAX	MIN	MAX
F1	6.205	6.305	0.2440	0.248
F2	4.460	4.560	0.1760	0.180
F3	4.460	4.560	0.1760	0.180
F4	0.650	0.700	0.0260	0.028
F5	0.620	0.670	0.0240	0.026
F6	0.630	0.680	0.0250	0.027
F7	0.70	0.800	0.0380	0.031
F8	0.650	0.700	0.0260	0.028
F9	0.620	0.670	0.0240	0.026
F10	4.900	5.000	0.1930	0.197
F11	4.460	4.560	0.1760	0.180

For recommended circuit layout for PCB designs, see application note [SLPA005 – Reducing Ringing Through PCB Layout Techniques](#).

Q5 Tape and Reel Information



M0138-01

Notes:

- 10 sprocket hole pitch cumulative tolerance ± 0.2
- Camber not to exceed 1 mm IN 100 mm, noncumulative over 250 mm
- Material: black static dissipative polystyrene
- All dimensions are in mm (unless otherwise specified)
- Thickness: 0.30 ± 0.05 mm
- MSL1 260°C (IR and Convection) PbF Reflow Compatible

REVISION HISTORY

Changes from Revision Original (August 2009) to Revision A	Page
• Deleted environmental bullets from features list	1
• Deleted package marking at end of data sheet	7

PACKAGING INFORMATION

Orderable part number	Status (1)	Material type (2)	Package Pins	Package qty Carrier	RoHS (3)	Lead finish/ Ball material (4)	MSL rating/ Peak reflow (5)	Op temp (°C)	Part marking (6)
CSD16407Q5	Active	Production	VSON-CLIP (DQH) 8	2500 LARGE T&R	ROHS Exempt	SN	Level-1-260C-UNLIM	-55 to 150	CSD16407
CSD16407Q5.B	Active	Production	VSON-CLIP (DQH) 8	2500 LARGE T&R	ROHS Exempt	SN	Level-1-260C-UNLIM	-55 to 150	CSD16407

(1) **Status:** For more details on status, see our [product life cycle](#).

(2) **Material type:** When designated, preproduction parts are prototypes/experimental devices, and are not yet approved or released for full production. Testing and final process, including without limitation quality assurance, reliability performance testing, and/or process qualification, may not yet be complete, and this item is subject to further changes or possible discontinuation. If available for ordering, purchases will be subject to an additional waiver at checkout, and are intended for early internal evaluation purposes only. These items are sold without warranties of any kind.

(3) **RoHS values:** Yes, No, RoHS Exempt. See the [TI RoHS Statement](#) for additional information and value definition.

(4) **Lead finish/Ball material:** Parts may have multiple material finish options. Finish options are separated by a vertical ruled line. Lead finish/Ball material values may wrap to two lines if the finish value exceeds the maximum column width.

(5) **MSL rating/Peak reflow:** The moisture sensitivity level ratings and peak solder (reflow) temperatures. In the event that a part has multiple moisture sensitivity ratings, only the lowest level per JEDEC standards is shown. Refer to the shipping label for the actual reflow temperature that will be used to mount the part to the printed circuit board.

(6) **Part marking:** There may be an additional marking, which relates to the logo, the lot trace code information, or the environmental category of the part.

Multiple part markings will be inside parentheses. Only one part marking contained in parentheses and separated by a "-" will appear on a part. If a line is indented then it is a continuation of the previous line and the two combined represent the entire part marking for that device.

Important Information and Disclaimer: The information provided on this page represents TI's knowledge and belief as of the date that it is provided. TI bases its knowledge and belief on information provided by third parties, and makes no representation or warranty as to the accuracy of such information. Efforts are underway to better integrate information from third parties. TI has taken and continues to take reasonable steps to provide representative and accurate information but may not have conducted destructive testing or chemical analysis on incoming materials and chemicals. TI and TI suppliers consider certain information to be proprietary, and thus CAS numbers and other limited information may not be available for release.

In no event shall TI's liability arising out of such information exceed the total purchase price of the TI part(s) at issue in this document sold by TI to Customer on an annual basis.

IMPORTANT NOTICE AND DISCLAIMER

TI PROVIDES TECHNICAL AND RELIABILITY DATA (INCLUDING DATASHEETS), DESIGN RESOURCES (INCLUDING REFERENCE DESIGNS), APPLICATION OR OTHER DESIGN ADVICE, WEB TOOLS, SAFETY INFORMATION, AND OTHER RESOURCES "AS IS" AND WITH ALL FAULTS, AND DISCLAIMS ALL WARRANTIES, EXPRESS AND IMPLIED, INCLUDING WITHOUT LIMITATION ANY IMPLIED WARRANTIES OF MERCHANTABILITY, FITNESS FOR A PARTICULAR PURPOSE OR NON-INFRINGEMENT OF THIRD PARTY INTELLECTUAL PROPERTY RIGHTS.

These resources are intended for skilled developers designing with TI products. You are solely responsible for (1) selecting the appropriate TI products for your application, (2) designing, validating and testing your application, and (3) ensuring your application meets applicable standards, and any other safety, security, regulatory or other requirements.

These resources are subject to change without notice. TI grants you permission to use these resources only for development of an application that uses the TI products described in the resource. Other reproduction and display of these resources is prohibited. No license is granted to any other TI intellectual property right or to any third party intellectual property right. TI disclaims responsibility for, and you fully indemnify TI and its representatives against any claims, damages, costs, losses, and liabilities arising out of your use of these resources.

TI's products are provided subject to [TI's Terms of Sale](#), [TI's General Quality Guidelines](#), or other applicable terms available either on [ti.com](#) or provided in conjunction with such TI products. TI's provision of these resources does not expand or otherwise alter TI's applicable warranties or warranty disclaimers for TI products. Unless TI explicitly designates a product as custom or customer-specified, TI products are standard, catalog, general purpose devices.

TI objects to and rejects any additional or different terms you may propose.

Copyright © 2025, Texas Instruments Incorporated

Last updated 10/2025