



30V, N-Channel NexFET™ Power MOSFETs

 Check for Samples: [CSD17305Q5A](#)

FEATURES

- Optimized for 5V Gate Drive
- Ultralow Q_g and Q_{gd}
- Low Thermal Resistance
- Avalanche Rated
- Pb Free Terminal Plating
- RoHS Compliant
- Halogen Free
- SON 5-mm x 6-mm Plastic Package

APPLICATIONS

- Notebook Point of Load
- Point-of-Load Synchronous Buck in Networking, Telecom and Computing Systems

DESCRIPTION

The NexFET™ power MOSFET has been designed to minimize losses in power conversion applications, and optimized for 5V gate drive applications.

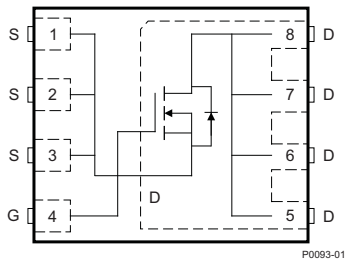
Top View

PRODUCT SUMMARY

V_{DS}	Drain to Source Voltage	30	V
Q_g	Gate Charge Total (4.5V)	14.1	nC
Q_{gd}	Gate Charge Gate to Drain	3	nC
$R_{DS(on)}$	Drain to Source On Resistance	$V_{GS} = 3V$	3.9 mΩ
		$V_{GS} = 4.5V$	2.8 mΩ
		$V_{GS} = 8V$	2.4 mΩ
$V_{GS(th)}$	Threshold Voltage	1.1	V

ORDERING INFORMATION

Device	Package	Media	Qty	Ship
CSD17305Q5A	SON 5-mm x 6-mm Plastic Package	13-Inch Reel	2500	Tape and Reel

ABSOLUTE MAXIMUM RATINGS

$T_A = 25^\circ\text{C}$ unless otherwise stated		VALUE	UNIT
V_{DS}	Drain to Source Voltage	30	V
V_{GS}	Gate to Source Voltage	+10 / -8	V
I_D	Continuous Drain Current, $T_C = 25^\circ\text{C}$	100	A
	Continuous Drain Current ⁽¹⁾	29	A
I_{DM}	Pulsed Drain Current, $T_A = 25^\circ\text{C}$ ⁽²⁾	181	A
P_D	Power Dissipation ⁽¹⁾	3.1	W
T_J, T_{STG}	Operating Junction and Storage Temperature Range	-55 to 150	$^\circ\text{C}$
E_{AS}	Avalanche Energy, single pulse $I_D = 78\text{A}, L = 0.1\text{mH}, R_G = 25\Omega$	304	mJ

(1) Typical $R_{\theta JA} = 40^\circ\text{C}/\text{W}$ on a 1-inch² (6.45-cm²), 2-oz. (0.071-mm thick) Cu pad on a 0.06-inch (1.52-mm) thick FR4 PCB.

(2) Pulse duration $\leq 300\mu\text{s}$, duty cycle $\leq 2\%$

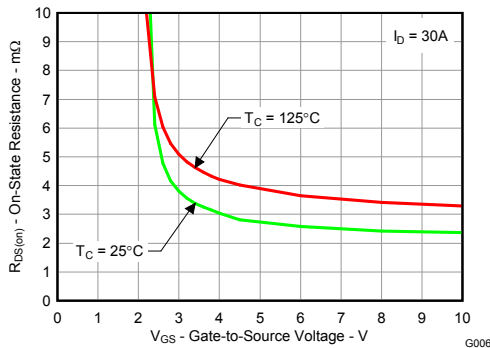
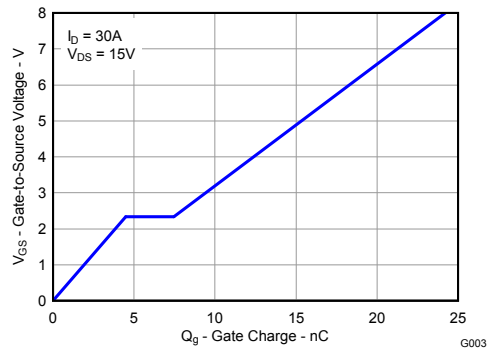
 $R_{DS(on)}$ VS V_{GS}

GATE CHARGE

Please be aware that an important notice concerning availability, standard warranty, and use in critical applications of Texas Instruments semiconductor products and disclaimers thereto appears at the end of this data sheet.

NexFET is a trademark of Texas Instruments.

PRODUCTION DATA information is current as of publication date. Products conform to specifications per the terms of the Texas Instruments standard warranty. Production processing does not necessarily include testing of all parameters.



These devices have limited built-in ESD protection. The leads should be shorted together or the device placed in conductive foam during storage or handling to prevent electrostatic damage to the MOS gates.

ELECTRICAL CHARACTERISTICS

($T_A = 25^\circ\text{C}$ unless otherwise stated)

PARAMETER		TEST CONDITIONS	MIN	TYP	MAX	UNIT
Static Characteristics						
BV_{DSS}	Drain to Source Voltage	$V_{GS} = 0V, I_D = 250\mu A$	30			V
I_{DSS}	Drain to Source Leakage Current	$V_{GS} = 0V, V_{DS} = 24V$			1	μA
I_{GSS}	Gate to Source Leakage Current	$V_{DS} = 0V, V_{GS} = +10/-8V$			100	nA
$V_{GS(th)}$	Gate to Source Threshold Voltage	$V_{DS} = V_{GS}, I_D = 250\mu A$	0.9	1.1	1.6	V
$R_{DS(on)}$	Drain to Source On Resistance	$V_{GS} = 3V, I_D = 30A$		3.9	5.4	m Ω
		$V_{GS} = 4.5V, I_D = 30A$		2.8	3.6	m Ω
		$V_{GS} = 8V, I_D = 30A$		2.4	3.4	m Ω
g_{fs}	Transconductance	$V_{DS} = 15V, I_D = 30A$		139		S
Dynamic Characteristics						
C_{iss}	Input Capacitance	$V_{GS} = 0V, V_{DS} = 15V,$ $f = 1MHz$		2000	2600	pF
C_{oss}	Output Capacitance			1100	1430	pF
C_{rss}	Reverse Transfer Capacitance			79	103	pF
R_G	Series Gate Resistance			1	2	Ω
Q_g	Gate Charge Total (4.5V)	$V_{DS} = 15V,$ $I_D = 30A$		14.1	18.3	nC
Q_{gd}	Gate Charge Gate to Drain			3		nC
Q_{gs}	Gate Charge Gate to Source			4.5		nC
$Q_{g(th)}$	Gate Charge at V_{th}			2.2		nC
Q_{oss}	Output Charge	$V_{DS} = 13.5V, V_{GS} = 0V$		27		nC
$t_{d(on)}$	Turn On Delay Time	$V_{DS} = 15V, V_{GS} = 4.5V, I_D = 30A$ $R_G = 2\Omega$		8.9		ns
t_r	Rise Time			16.5		ns
$t_{d(off)}$	Turn Off Delay Time			20		ns
t_f	Fall Time			7.9		ns
Diode Characteristics						
V_{SD}	Diode Forward Voltage	$I_{SD} = 30A, V_{GS} = 0V$		0.85	1	V
Q_{rr}	Reverse Recovery Charge	$V_{DD} = 13.5V, I_F = 30A,$ $di/dt = 300A/\mu s$		34		nC
t_{rr}	Reverse Recovery Time			27		ns

THERMAL CHARACTERISTICS

($T_A = 25^\circ\text{C}$ unless otherwise stated)

PARAMETER		MIN	TYP	MAX	UNIT
$R_{\theta JC}$	Thermal Resistance Junction to Case ⁽¹⁾			1.3	$^\circ\text{C/W}$
$R_{\theta JA}$	Thermal Resistance Junction to Ambient ^{(1) (2)}			50	$^\circ\text{C/W}$

- (1) $R_{\theta JC}$ is determined with the device mounted on a 1-inch² (6.45-cm²), 2-oz. (0.071-mm thick) Cu pad on a 1.5-inch x 1.5-inch (3.81-cm x 3.81-cm), 0.06-inch (1.52-mm) thick FR4 PCB. $R_{\theta JC}$ is specified by design, whereas $R_{\theta JA}$ is determined by the user's board design.
- (2) Device mounted on FR4 material with 1-inch² (6.45-cm²), 2-oz. (0.071-mm thick) Cu.



Max $R_{\theta JA} = 50^{\circ}\text{C/W}$
when mounted on
1 inch² (6.45 cm²) of
2-oz. (0.071-mm thick)
Cu.

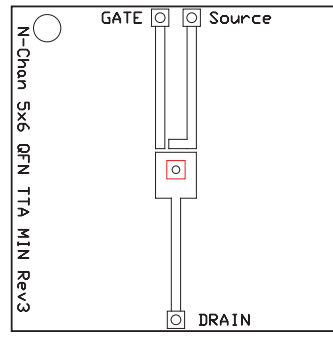

Max $R_{\theta JA} = 120^{\circ}\text{C/W}$
when mounted on a
minimum pad area of
2-oz. (0.071-mm thick)
Cu.

TYPICAL MOSFET CHARACTERISTICS

($T_A = 25^{\circ}\text{C}$ unless otherwise stated)

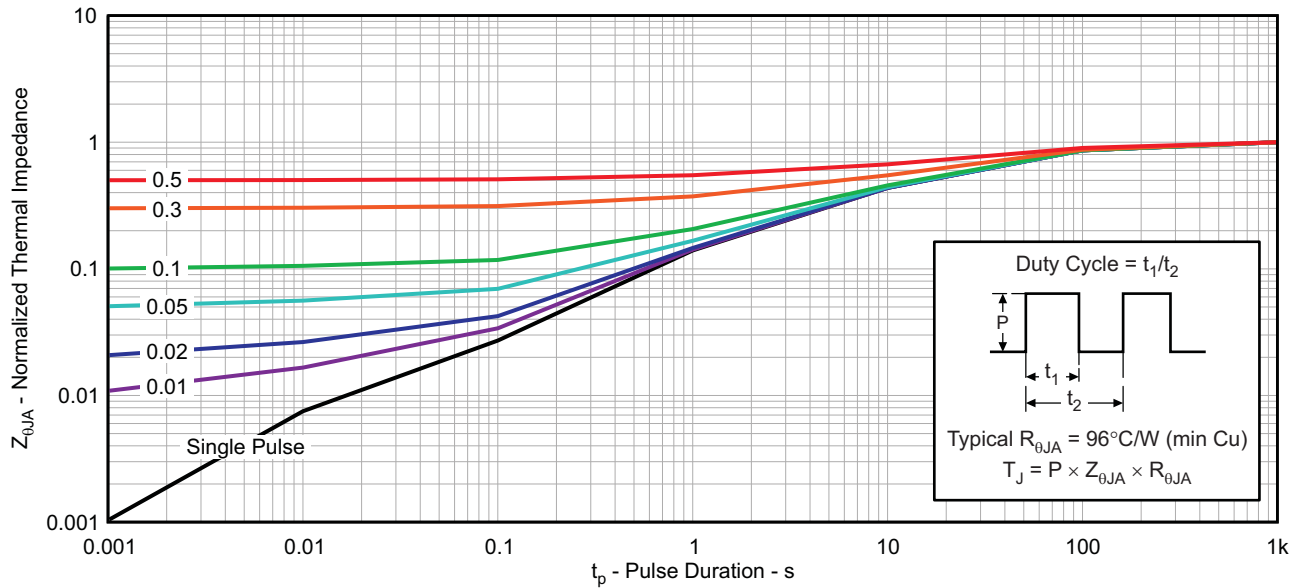

Figure 1. Transient Thermal Impedance

TYPICAL MOSFET CHARACTERISTICS (continued)

($T_A = 25^\circ\text{C}$ unless otherwise stated)

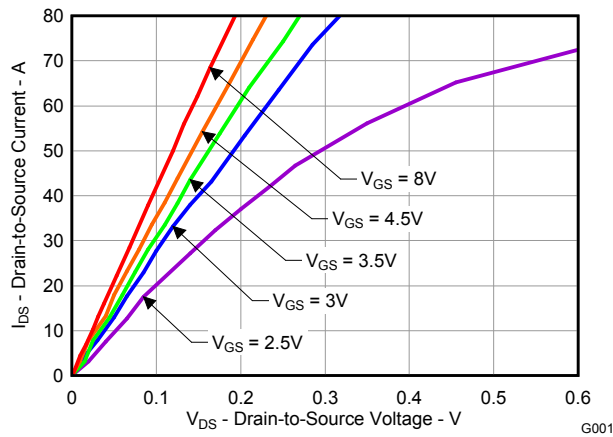

Figure 2. Saturation Characteristics

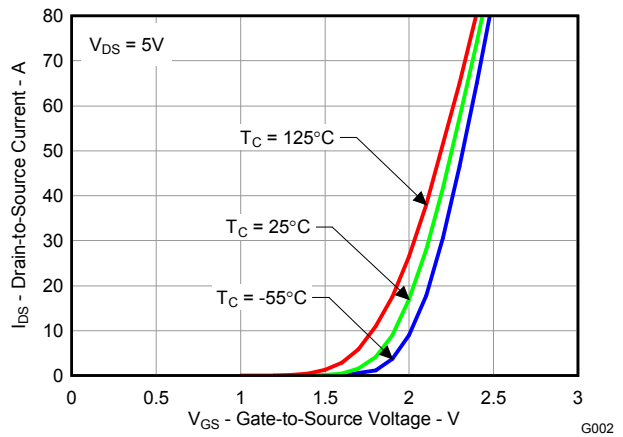

Figure 3. Transfer Characteristics

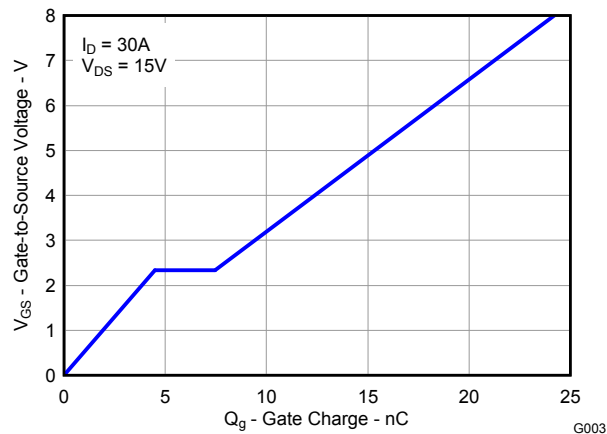

Figure 4. Gate Charge

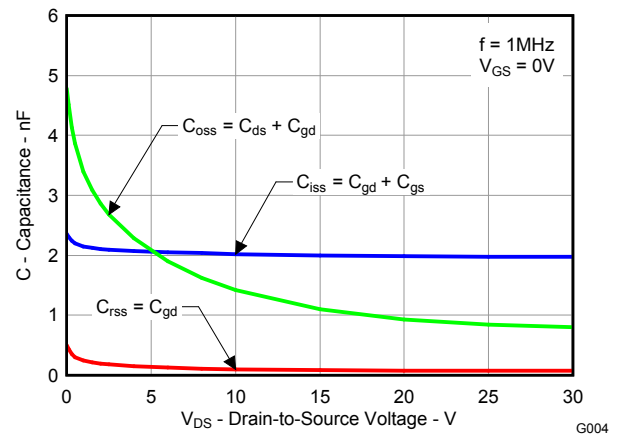

Figure 5. Capacitance

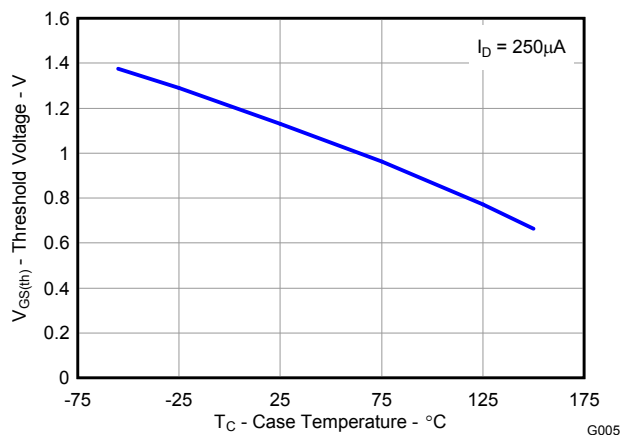

Figure 6. Threshold Voltage vs. Temperature

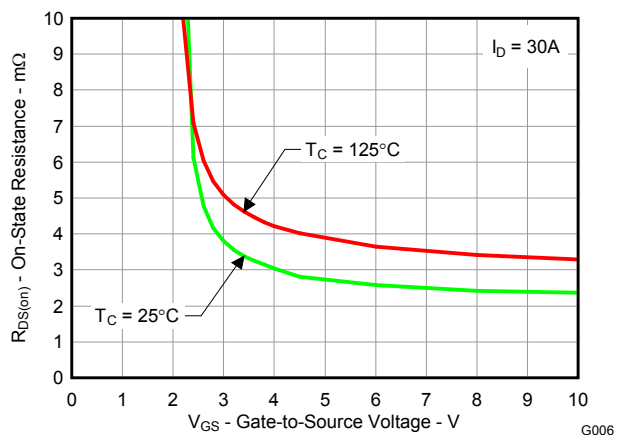

Figure 7. On-State Resistance vs. Gate to Source Voltage

TYPICAL MOSFET CHARACTERISTICS (continued)

($T_A = 25^\circ\text{C}$ unless otherwise stated)

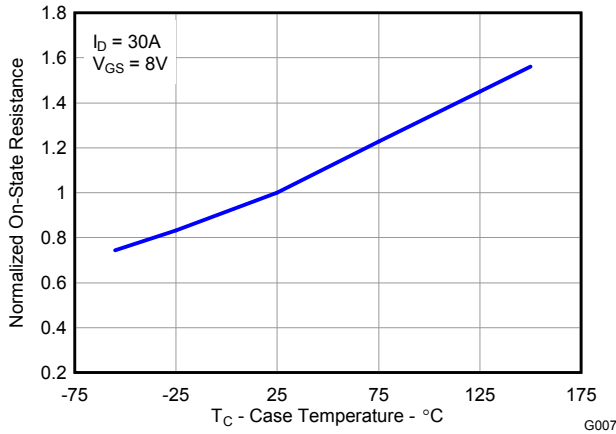

Figure 8. Normalized On-State Resistance vs. Temperature

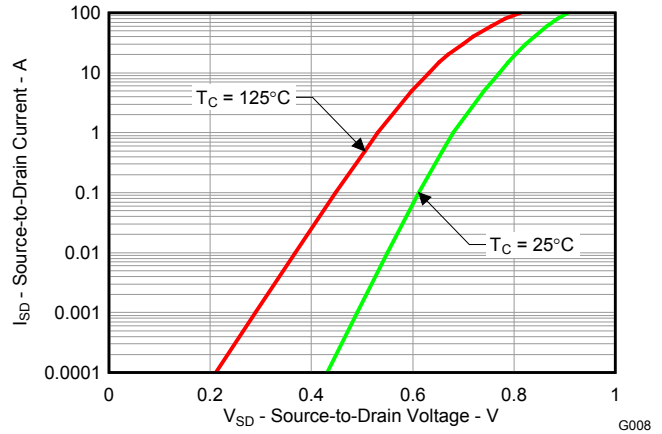

Figure 9. Typical Diode Forward Voltage

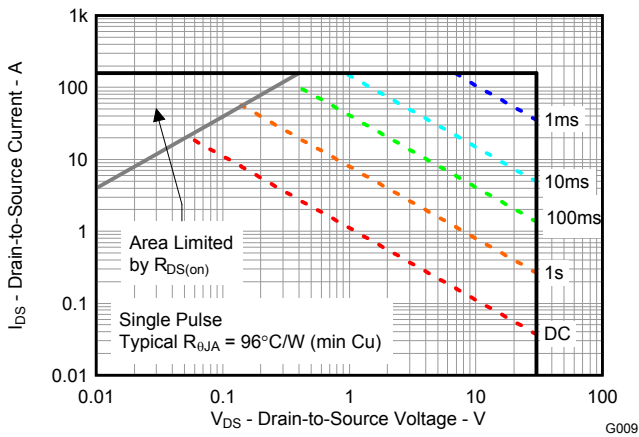

Figure 10. Maximum Safe Operating Area

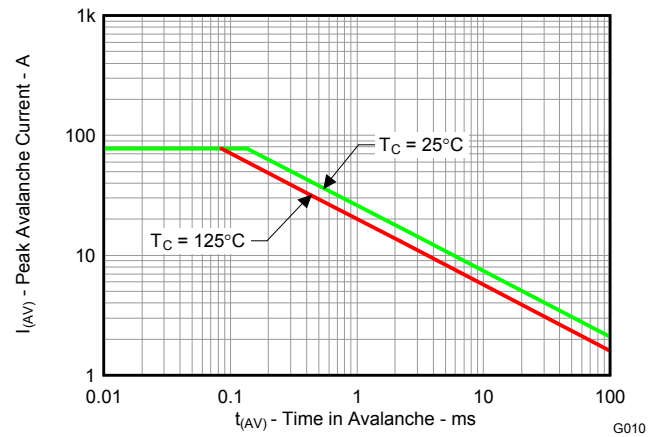

Figure 11. Single Pulse Unclamped Inductive Switching

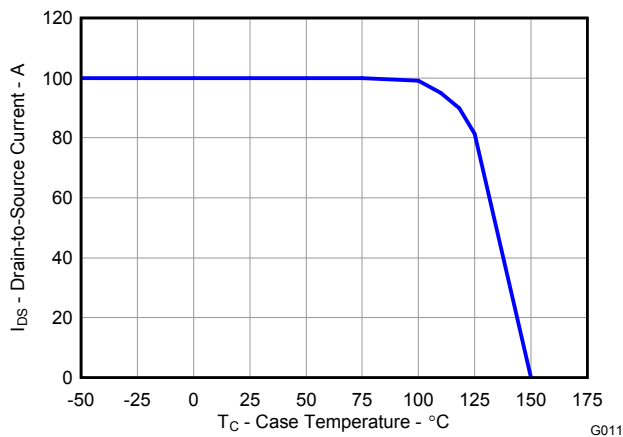

Figure 12. Maximum Drain Current vs. Temperature

MECHANICAL DATA

Q5A Package Dimensions



M0135-01

DIM	MILLIMETERS		
	MIN	NOM	MAX
A	0.90	1.00	1.10
b	0.33	0.41	0.51
c	0.20	0.25	0.34
D1	4.80	4.90	5.00
D2	3.61	3.81	4.02
E	5.90	6.00	6.10
E1	5.70	5.75	5.80
E2	3.38	3.58	3.78
e	1.17	1.27	1.37
H	0.41	0.56	0.71
K	1.10		
L	0.51	0.61	0.71
L1	0.06	0.13	0.20
θ	0°		12°

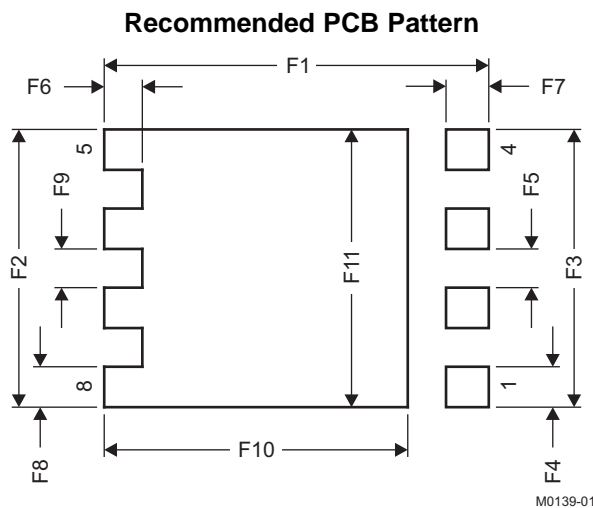

DIM	MILLIMETERS		INCHES	
	MIN	MAX	MIN	MAX
F1	6.205	6.305	0.244	0.248
F2	4.46	4.56	0.176	0.18
F3	4.46	4.56	0.176	0.18
F4	0.65	0.7	0.026	0.028
F5	0.62	0.67	0.024	0.026
F6	0.63	0.68	0.025	0.027
F7	0.7	0.8	0.028	0.031
F8	0.65	0.7	0.026	0.028
F9	0.62	0.67	0.024	0.026
F10	4.9	5	0.193	0.197
F11	4.46	4.56	0.176	0.18

For recommended circuit layout for PCB designs, see application note [SLPA005](#) – *Reducing Ringing Through PCB Layout Techniques*.

Q5A Tape and Reel Information

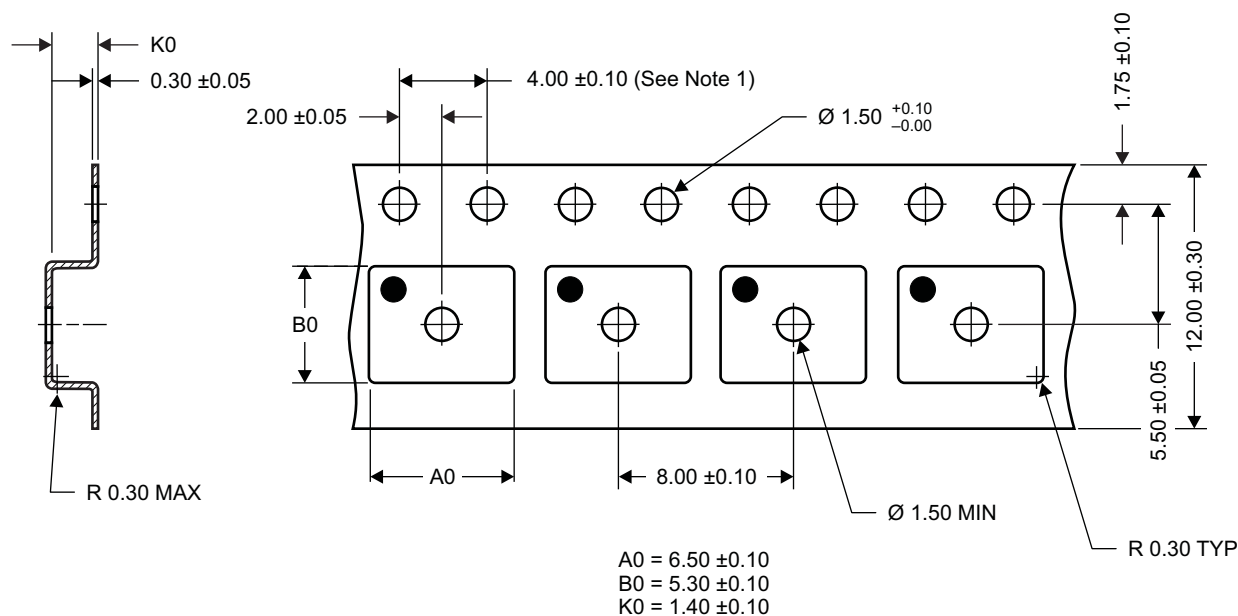

Notes:

1. 10-sprocket hole-pitch cumulative tolerance ± 0.2
2. Camber not to exceed 1mm in 100mm, noncumulative over 250mm
3. Material: black static-dissipative polystyrene
4. All dimensions are in mm (unless otherwise specified)
5. A0 and B0 measured on a plane 0.3mm above the bottom of the pocket

REVISION HISTORY

Changes from Original (February 2010) to Revision A	Page
• Updated the Q5A Package Dimensions table. DIM c MAX was 0.30, DIM D2 MAX was 3.96, DIM e MIN was blank MAX was blank, DIM H NOM was 0.51 MAX was 0.61	6
• Deleted Note 6 from the Q5A Tape and Reel Information - "MSL1 260°C (IR and convection) PbF reflow compatible"	7
• Deleted the Package Marking Information section	7

PACKAGING INFORMATION

Orderable part number	Status (1)	Material type (2)	Package Pins	Package qty Carrier	RoHS (3)	Lead finish/ Ball material (4)	MSL rating/ Peak reflow (5)	Op temp (°C)	Part marking (6)
CSD17305Q5A	Active	Production	VSONP (DQJ) 8	2500 LARGE T&R	ROHS Exempt	SN	Level-1-260C-UNLIM	-55 to 150	CSD17305
CSD17305Q5A.B	Active	Production	VSONP (DQJ) 8	2500 LARGE T&R	ROHS Exempt	SN	Level-1-260C-UNLIM	-55 to 150	CSD17305

(1) **Status:** For more details on status, see our [product life cycle](#).

(2) **Material type:** When designated, preproduction parts are prototypes/experimental devices, and are not yet approved or released for full production. Testing and final process, including without limitation quality assurance, reliability performance testing, and/or process qualification, may not yet be complete, and this item is subject to further changes or possible discontinuation. If available for ordering, purchases will be subject to an additional waiver at checkout, and are intended for early internal evaluation purposes only. These items are sold without warranties of any kind.

(3) **RoHS values:** Yes, No, RoHS Exempt. See the [TI RoHS Statement](#) for additional information and value definition.

(4) **Lead finish/Ball material:** Parts may have multiple material finish options. Finish options are separated by a vertical ruled line. Lead finish/Ball material values may wrap to two lines if the finish value exceeds the maximum column width.

(5) **MSL rating/Peak reflow:** The moisture sensitivity level ratings and peak solder (reflow) temperatures. In the event that a part has multiple moisture sensitivity ratings, only the lowest level per JEDEC standards is shown. Refer to the shipping label for the actual reflow temperature that will be used to mount the part to the printed circuit board.

(6) **Part marking:** There may be an additional marking, which relates to the logo, the lot trace code information, or the environmental category of the part.

Multiple part markings will be inside parentheses. Only one part marking contained in parentheses and separated by a "-" will appear on a part. If a line is indented then it is a continuation of the previous line and the two combined represent the entire part marking for that device.

Important Information and Disclaimer: The information provided on this page represents TI's knowledge and belief as of the date that it is provided. TI bases its knowledge and belief on information provided by third parties, and makes no representation or warranty as to the accuracy of such information. Efforts are underway to better integrate information from third parties. TI has taken and continues to take reasonable steps to provide representative and accurate information but may not have conducted destructive testing or chemical analysis on incoming materials and chemicals. TI and TI suppliers consider certain information to be proprietary, and thus CAS numbers and other limited information may not be available for release.

In no event shall TI's liability arising out of such information exceed the total purchase price of the TI part(s) at issue in this document sold by TI to Customer on an annual basis.

IMPORTANT NOTICE AND DISCLAIMER

TI PROVIDES TECHNICAL AND RELIABILITY DATA (INCLUDING DATASHEETS), DESIGN RESOURCES (INCLUDING REFERENCE DESIGNS), APPLICATION OR OTHER DESIGN ADVICE, WEB TOOLS, SAFETY INFORMATION, AND OTHER RESOURCES "AS IS" AND WITH ALL FAULTS, AND DISCLAIMS ALL WARRANTIES, EXPRESS AND IMPLIED, INCLUDING WITHOUT LIMITATION ANY IMPLIED WARRANTIES OF MERCHANTABILITY, FITNESS FOR A PARTICULAR PURPOSE OR NON-INFRINGEMENT OF THIRD PARTY INTELLECTUAL PROPERTY RIGHTS.

These resources are intended for skilled developers designing with TI products. You are solely responsible for (1) selecting the appropriate TI products for your application, (2) designing, validating and testing your application, and (3) ensuring your application meets applicable standards, and any other safety, security, regulatory or other requirements.

These resources are subject to change without notice. TI grants you permission to use these resources only for development of an application that uses the TI products described in the resource. Other reproduction and display of these resources is prohibited. No license is granted to any other TI intellectual property right or to any third party intellectual property right. TI disclaims responsibility for, and you fully indemnify TI and its representatives against any claims, damages, costs, losses, and liabilities arising out of your use of these resources.

TI's products are provided subject to [TI's Terms of Sale](#), [TI's General Quality Guidelines](#), or other applicable terms available either on ti.com or provided in conjunction with such TI products. TI's provision of these resources does not expand or otherwise alter TI's applicable warranties or warranty disclaimers for TI products. Unless TI explicitly designates a product as custom or customer-specified, TI products are standard, catalog, general purpose devices.

TI objects to and rejects any additional or different terms you may propose.

Copyright © 2025, Texas Instruments Incorporated

Last updated 10/2025