

DS25BR120 3.125 Gbps LVDS Buffer with Transmit Pre-Emphasis

Check for Samples: [DS25BR120](#)

FEATURES

- DC - 3.125 Gbps Low Jitter, High Noise Immunity, Low Power Operation
- Four Levels of Transmit Pre-Emphasis Drive Lossy Backplanes and Cables
- On-Chip 100Ω Input and Output Termination Minimizes Insertion and Return Losses, Reduces Component Count, and Minimizes Board Space
- 7 kV ESD on LVDS I/O pins Protects Adjoining Components
- Small 3 mm x 3 mm 8-WSON Space Saving Package

APPLICATIONS

- Clock and Data Buffering
- Metallic Cable Driving
- FR-4 Driving

DESCRIPTION

The DS25BR120 is a single channel 3.125 Gbps LVDS buffer optimized for high-speed signal transmission over lossy FR-4 printed circuit board backplanes and balanced metallic cables. Fully differential signal paths ensure exceptional signal integrity and noise immunity.

The DS25BR120 features four levels of pre-emphasis (PE) for use as an optimized driver device. Other LVDS devices with similar IO characteristics include the following products. The DS25BR110 features four levels of equalization for use as an optimized receiver device, while the DS25BR100 features both pre-emphasis and equalization for use as an optimized repeater device. The DS25BR150 is a buffer/repeater with the lowest power consumption and does not feature transmit pre-emphasis nor receive equalization.

Wide input common mode range allows the receiver to accept signals with LVDS, CML and LVPECL levels; the output levels are LVDS. A very small package footprint requires minimal space on the board while the flow-through pinout allows easy board layout. The differential inputs and outputs are internally terminated with a 100Ω resistor to lower device input and output return losses, reduce component count and further minimize board space.

Typical Application

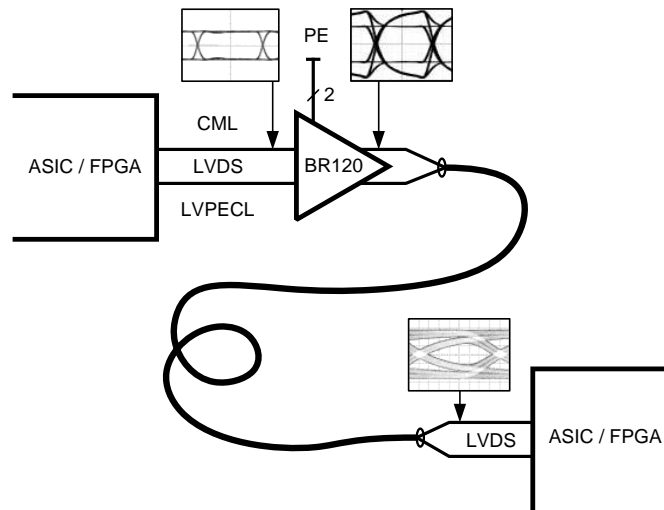

Please be aware that an important notice concerning availability, standard warranty, and use in critical applications of Texas Instruments semiconductor products and disclaimers thereto appears at the end of this data sheet.

All trademarks are the property of their respective owners.

Block Diagram

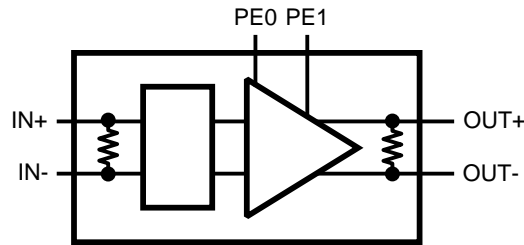

Pin Diagram

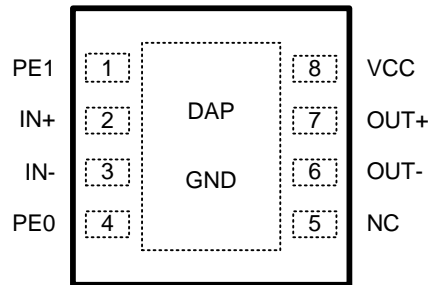

WSON Package

PIN DESCRIPTIONS

Pin Name	Pin Name	Pin Type	Pin Description
PE1	1	Input	Pre-emphasis select pin.
IN+	2	Input	Non-inverting LVDS input pin.
IN-	3	Input	Inverting LVDS input pin.
PE0	4	Input	Pre-emphasis select pin.
NC	5	NA	"NO CONNECT" pin.
OUT-	6	Output	Inverting LVDS output pin.
OUT+	7	Output	Non-inverting LVDS Output pin.
VCC	8	Power	Power supply pin.
GND	DAP	Power	Ground pad (DAP - die attach pad)

Pre-Emphasis Truth Table

PE1	PE0	Pre-emphasis Level
0	0	Off
0	1	Low (Approx. 3 dB at 1.56 GHz)
1	0	Medium (Approx. 6 dB at 1.56 GHz)
1	1	High (Approx. 9 dB at 1.56 GHz)



These devices have limited built-in ESD protection. The leads should be shorted together or the device placed in conductive foam during storage or handling to prevent electrostatic damage to the MOS gates.

Absolute Maximum Ratings⁽¹⁾⁽²⁾

Supply Voltage (V_{CC})	-0.3V to +4V
LVCMOS Input Voltage (PE0, PE1)	-0.3V to ($V_{CC} + 0.3V$)
LVDS Input Voltage (IN+, IN-)	-0.3V to +4V
Differential Input Voltage VID	1.0V
LVDS Output Voltage (OUT+, OUT-)	-0.3V to ($V_{CC} + 0.3V$)
LVDS Differential Output Voltage ((OUT+) - (OUT-))	0V to 1.0V
LVDS Output Short Circuit Current Duration	5 ms
Junction Temperature	+150°C
Storage Temperature Range	-65°C to +150°C
Lead Temperature Range	
Soldering (4 sec.)	+260°C
Maximum Package Power Dissipation at 25°C	
NGQ Package	2.08W
Derate NGQ Package	16.7 mW/°C above +25°C
Package Thermal Resistance	
θ_{JA}	+60.0°C/W
θ_{JC}	+12.3°C/W
ESD Susceptibility	
HBM ⁽³⁾	≥7 kV
MM ⁽⁴⁾	≥250V
CDM ⁽⁵⁾	≥1250V

- (1) "Absolute Maximum Ratings" indicate limits beyond which damage to the device may occur, including inoperability and degradation of device reliability and/or performance. Functional operation of the device and/or non-degradation at the Absolute Maximum Ratings or other conditions beyond those indicated in the Recommended Operating Conditions is not implied. The Recommended Operating Conditions indicate conditions at which the device is functional and the device should not be operated beyond such conditions.
- (2) If Military/Aerospace specified devices are required, please contact the TI Sales Office/Distributors for availability and specifications.
- (3) Human Body Model, applicable std. JESD22-A114C
- (4) Machine Model, applicable std. JESD22-A115-A
- (5) Field Induced Charge Device Model, applicable std. JESD22-C101-C

Recommended Operating Conditions

	Min	Typ	Max	Units
Supply Voltage (V_{CC})	3.0	3.3	3.6	V
Receiver Differential Input Voltage (V_{ID})	0		1.0	V
Operating Free Air Temperature (T_A)	-40	+25	+85	°C

Electrical Characteristics

 Over recommended operating supply and temperature ranges unless otherwise specified.⁽¹⁾⁽²⁾⁽³⁾

Symbol	Parameter	Conditions	Min	Typ	Max	Units
LVCMOS INPUT DC SPECIFICATIONS (PE0, PE1)						
V_{IH}	High Level Input Voltage		2.0		V_{CC}	V
V_{IL}	Low Level Input Voltage		GND		0.8	V
I_{IH}	High Level Input Current	$V_{IN} = 3.6V$ $V_{CC} = 3.6V$		0	±10	μA
I_{IL}	Low Level Input Current	$V_{IN} = GND$ $V_{CC} = 3.6V$		0	±10	μA

- (1) The Electrical Characteristics tables list ensured specifications under the listed Recommended Operating Conditions except as otherwise modified or specified by the Electrical Characteristics Conditions and/or Notes. Typical specifications are estimations only and are not ensured.
- (2) Current into device pins is defined as positive. Current out of device pins is defined as negative. All voltages are referenced to ground except V_{OD} and ΔV_{OD} .
- (3) Typical values represent most likely parametric norms for $V_{CC} = +3.3V$ and $T_A = +25°C$, and at the Recommended Operation Conditions at the time of product characterization and are not ensured.

Electrical Characteristics (continued)

Over recommended operating supply and temperature ranges unless otherwise specified.⁽¹⁾⁽²⁾⁽³⁾

Symbol	Parameter	Conditions	Min	Typ	Max	Units
V_{CL}	Input Clamp Voltage	$I_{CL} = -18 \text{ mA}$, $V_{CC} = 0\text{V}$		-0.9	-1.5	V
LVDS OUTPUT DC SPECIFICATIONS (OUT+, OUT-)						
V_{OD}	Differential Output Voltage	$R_L = 100\Omega$	250	350	450	mV
ΔV_{OD}	Change in Magnitude of V_{OD} for Complimentary Output States		-35		35	mV
V_{OS}	Offset Voltage	$R_L = 100\Omega$	1.05	1.2	1.375	V
ΔV_{OS}	Change in Magnitude of V_{OS} for Complimentary Output States		-35		35	mV
I_{OS}	Output Short Circuit Current ⁽⁴⁾	OUT to GND $PE0 = PE1 = 0$		-35	-55	mA
		OUT to V_{CC} $PE0 = PE1 = 0$		7	55	mA
C_{OUT}	Output Capacitance	Any LVDS Output Pin to GND		1.2		pF
R_{OUT}	Output Termination Resistor	Between OUT+ and OUT-		100		Ω
LVDS INPUT DC SPECIFICATIONS (IN+, IN-)						
V_{ID}	Input Differential Voltage		0		1	V
V_{TH}	Differential Input High Threshold	$V_{CM} = +0.05\text{V}$ or $V_{CC}-0.05\text{V}$		0	+100	mV
V_{TL}	Differential Input Low Threshold		-100	0		mV
V_{CMR}	Common Mode Voltage Range	$V_{ID} = 100 \text{ mV}$	0.05		$V_{CC} - 0.05$	V
I_{IN}	Input Current	$V_{IN} = 3.6\text{V}$ or 0V $V_{CC} = 3.6\text{V}$ or 0V		± 1	± 10	μA
C_{IN}	Input Capacitance	Any LVDS Input Pin to GND		1.7		pF
R_{IN}	Input Termination Resistor	Between IN+ and IN-		100		Ω
SUPPLY CURRENT						
I_{CC}	Supply Current	$PE0 = 0$, $PE1 = 0$		35	43	mA

(4) Output short circuit current (I_{OS}) is specified as magnitude only, minus sign indicates direction only.

AC Electrical Characteristics⁽¹⁾

Over recommended operating supply and temperature ranges unless otherwise specified.⁽²⁾⁽³⁾

Symbol	Parameter	Conditions	Min	Typ	Max	Units
LVDS OUTPUT AC SPECIFICATIONS (OUT+, OUT-)						
t_{PHLD}	Differential Propagation Delay High to Low	$R_L = 100\Omega$		350	465	ps
t_{PLHD}	Differential Propagation Delay Low to High				350	465
t_{SKD1}	Pulse Skew $ t_{PLHD} - t_{PHLD} $ ⁽⁴⁾			45	100	ps
t_{SKD2}	Part to Part Skew ⁽⁵⁾			45	150	ps
t_{LHT}	Rise Time	$R_L = 100\Omega$		80	150	ps
t_{HLT}	Fall Time				80	150

(1) Specification is ensured by characterization and is not tested in production.

(2) The Electrical Characteristics tables list ensured specifications under the listed Recommended Operating Conditions except as otherwise modified or specified by the Electrical Characteristics Conditions and/or Notes. Typical specifications are estimations only and are not ensured.

(3) Typical values represent most likely parametric norms for $V_{CC} = +3.3\text{V}$ and $T_A = +25^\circ\text{C}$, and at the Recommended Operation Conditions at the time of product characterization and are not ensured.

(4) t_{SKD1} , $|t_{PLHD} - t_{PHLD}|$, is the magnitude difference in differential propagation delay time between the positive going edge and the negative going edge of the same channel.

(5) t_{SKD2} , Part to Part Skew, is defined as the difference between the minimum and maximum specified differential propagation delays. This specification applies to devices at the same V_{CC} and within 5°C of each other within the operating temperature range.

AC Electrical Characteristics⁽¹⁾ (continued)

 Over recommended operating supply and temperature ranges unless otherwise specified.⁽²⁾⁽³⁾

Symbol	Parameter	Conditions	Min	Typ	Max	Units
JITTER PERFORMANCE WITH PE = OFF						
t _{RJ1A}	Random Jitter (RMS Value) No Test Channels ⁽⁶⁾	V _{ID} = 350 mV V _{CM} = 1.2V Clock (RZ) PE0 = 0, PE1 = 0	2.5 Gbps		0.5	1 ps
t _{RJ2A}			3.125 Gbps		0.5	1 ps
t _{DJ1A}	Deterministic Jitter (Peak to Peak) No Test Channels ⁽⁷⁾	V _{ID} = 350 mV V _{CM} = 1.2V K28.5 (NRZ) PE0 = 0, PE1 = 0	2.5 Gbps		9	31 ps
t _{DJ2A}			3.125 Gbps		16	40 ps
t _{TJ1A}	Total Jitter (Peak to Peak) No Test Channels ⁽⁸⁾	V _{ID} = 350 mV V _{CM} = 1.2V PRBS-23 (NRZ) PE0 = 0, PE1 = 0	2.5 Gbps		0.05	0.13 U _{I_{P-P}}
t _{TJ2A}			3.125 Gbps		0.09	0.16 U _{I_{P-P}}
JITTER PERFORMANCE WITH PE = LOW (Figure 5 and Figure 6)						
t _{RJ1B}	Random Jitter (RMS Value) Test Channel A ⁽⁶⁾	V _{ID} = 350 mV V _{CM} = 1.2V Clock (RZ) PE0 = 1, PE1 = 0	2.5 Gbps		0.5	1.3 ps
t _{RJ2B}			3.125 Gbps		0.5	1.3 ps
t _{DJ1B}	Deterministic Jitter (Peak to Peak) Test Channel A ⁽⁷⁾	V _{ID} = 350 mV V _{CM} = 1.2V K28.5 (NRZ) PE0 = 1, PE1 = 0	2.5 Gbps		17	31 ps
t _{DJ2B}			3.125 Gbps		18	40 ps
t _{TJ1B}	Total Jitter (Peak to Peak) Test Channel A ⁽⁸⁾	V _{ID} = 350 mV V _{CM} = 1.2V PRBS-23 (NRZ) PE0 = 1, PE1 = 0	2.5 Gbps		0.09	0.14 U _{I_{P-P}}
t _{TJ2B}			3.125 Gbps		0.12	0.19 U _{I_{P-P}}
JITTER PERFORMANCE WITH PE = MEDIUM (Figure 5 and Figure 6)						
t _{RJ1C}	Random Jitter (RMS Value) Test Channel B ⁽⁶⁾	V _{ID} = 350 mV V _{CM} = 1.2V Clock (RZ) PE0 = 0, PE1 = 1	2.5 Gbps		0.5	1.2 ps
t _{RJ2C}			3.125 Gbps		0.5	1.2 ps
t _{DJ1C}	Deterministic Jitter (Peak to Peak) Test Channel B ⁽⁷⁾	V _{ID} = 350 mV V _{CM} = 1.2V K28.5 (NRZ) PE0 = 0, PE1 = 1	2.5 Gbps		21	44 ps
t _{DJ2C}			3.125 Gbps		27	48 ps
t _{TJ1C}	Total Jitter (Peak to Peak) Test Channel B ⁽⁸⁾	V _{ID} = 350 mV V _{CM} = 1.2V PRBS-23 (NRZ) PE0 = 0, PE1 = 1	2.5 Gbps		0.09	0.16 U _{I_{P-P}}
t _{TJ2C}			3.125 Gbps		0.13	0.23 U _{I_{P-P}}
JITTER PERFORMANCE WITH PE = HIGH (Figure 5 and Figure 6)						
t _{RJ1D}	Random Jitter (RMS Value) Test Channel C ⁽⁶⁾	V _{ID} = 350 mV V _{CM} = 1.2V Clock (RZ) PE0 = 1, PE1 = 1	2.5 Gbps		0.5	1.2 ps
t _{RJ2D}			3.125 Gbps		0.5	1.2 ps
t _{DJ1D}	Deterministic Jitter (Peak to Peak) Test Channel C ⁽⁷⁾	V _{ID} = 350 mV V _{CM} = 1.2V K28.5 (NRZ) PE0 = 1, PE1 = 1	2.5 Gbps		30	65 ps
t _{DJ2D}			3.125 Gbps		30	58 ps
t _{TJ1D}	Total Jitter (Peak to Peak) Test Channel C ⁽⁸⁾	V _{ID} = 350 mV V _{CM} = 1.2V PRBS-23 (NRZ) PE0 = 1, PE1 = 1	2.5 Gbps		0.09	0.20 U _{I_{P-P}}
t _{TJ2D}			3.125 Gbps		0.13	0.22 U _{I_{P-P}}

(6) Measured on a clock edge with a histogram and an accumulation of 1500 histogram hits. Input stimulus jitter is subtracted geometrically.

(7) Tested with a combination of the 1100000101 (K28.5+ character) and 0011111010 (K28.5- character) patterns. Input stimulus jitter is subtracted algebraically.

(8) Measured on an eye diagram with a histogram and an accumulation of 3500 histogram hits. Input stimulus jitter is subtracted.

APPLICATION INFORMATION

DC TEST CIRCUITS

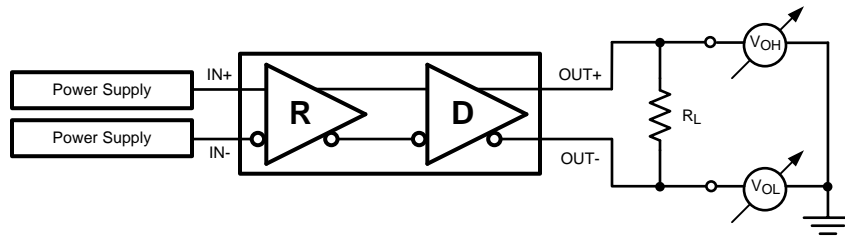

Figure 1. Differential Driver DC Test Circuit

AC TEST CIRCUITS AND TIMING DIAGRAMS

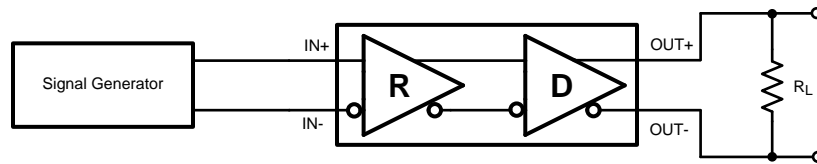

Figure 2. Differential Driver AC Test Circuit

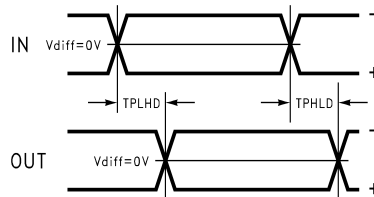

Figure 3. Propagation Delay Timing Diagram

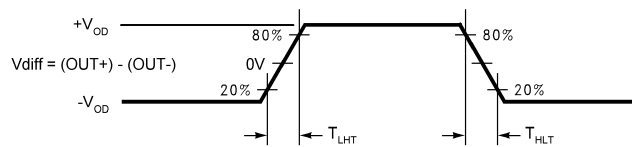

Figure 4. LVDS Output Transition Times

PRE-EMPHASIS TEST CIRCUITS

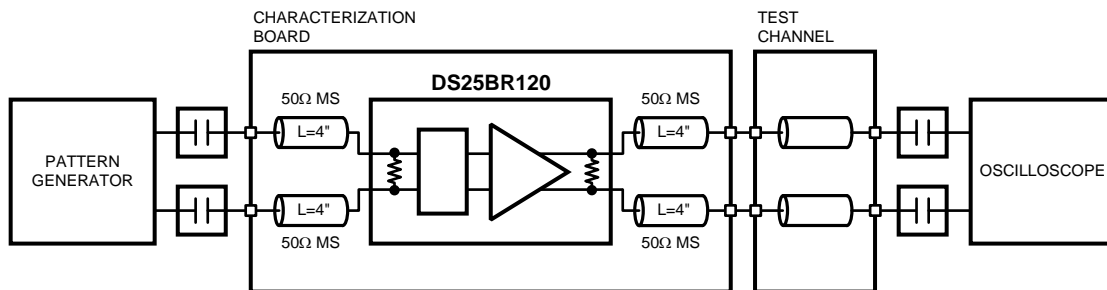

Figure 5. Pre-emphasis Performance Test Circuit

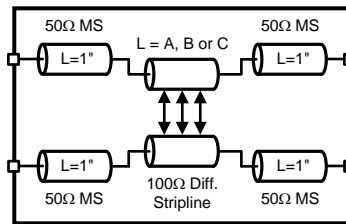

Figure 6. Test Channel Description

Test Channel Loss Characteristics

The test channel was fabricated with Polyclad PCL-FR-370-Laminate/PCL-FRP-370 Prepreg materials (Dielectric constant of 3.7 and Loss Tangent of 0.02). The edge coupled differential striplines have the following geometries: Trace Width (W) = 5 mils, Gap (S) = 5 mils, Height (B) = 16 mils.

Test Channel	Length (inches)	Insertion Loss (dB)					
		500 MHz	750 MHz	1000 MHz	1250 MHz	1500 MHz	1560 MHz
A	10	-1.2	-1.7	-2.0	-2.4	-2.7	-2.8
B	20	-2.6	-3.5	-4.1	-4.8	-5.5	-5.6
C	30	-4.3	-5.7	-7.0	-8.2	-9.4	-9.7
D	15	-1.6	-2.2	-2.7	-3.2	-3.7	-3.8
E	30	-3.4	-4.5	-5.6	-6.6	-7.7	-7.9
F	60	-7.8	-10.3	-12.4	-14.5	-16.6	-17.0

Device Operation

INPUT INTERFACING

The DS25BR120 accepts differential signals and allows simple AC or DC coupling. With a wide common mode range, the DS25BR120 can be DC-coupled with all common differential drivers (i.e. LVPECL, LVDS, CML). The following three figures illustrate typical DC-coupled interface to common differential drivers. Note that the DS25BR120 inputs are internally terminated with a 100Ω resistor.

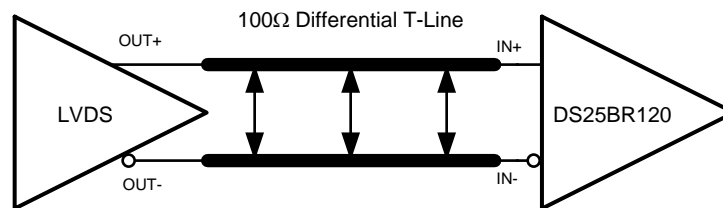

Figure 7. Typical LVDS Driver DC-Coupled Interface to DS25BR120 Input

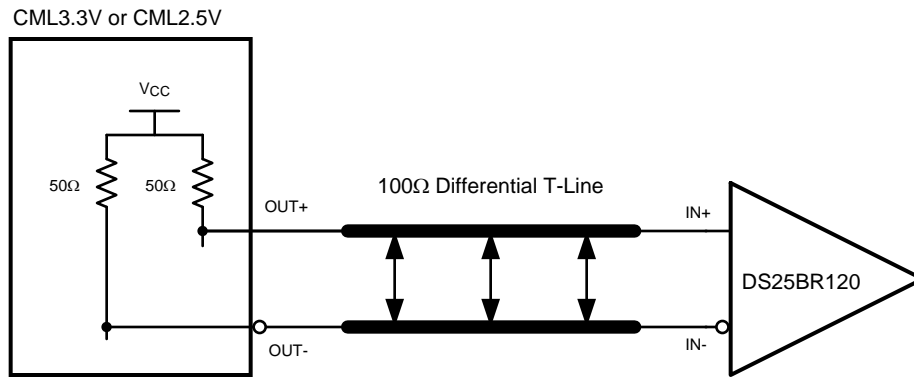

Figure 8. Typical CML Driver DC-Coupled Interface to DS25BR120 Input

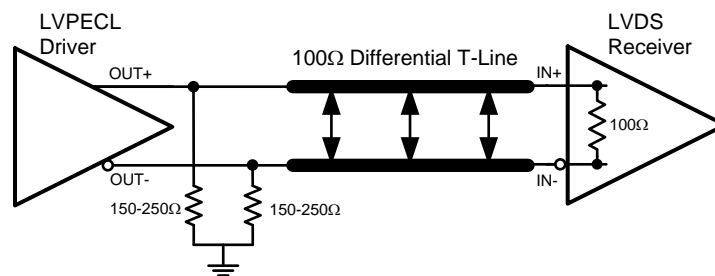

Figure 9. Typical LVPECL Driver DC-Coupled Interface to DS25BR120 Input

OUTPUT INTERFACING

The DS25BR120 outputs signals compliant to the LVDS standard. It can be DC-coupled to most common differential receivers. The following figure illustrates typical DC-coupled interface to common differential receivers and assumes that the receivers have high impedance inputs. While most differential receivers have a common mode input range that can accommodate LVDS compliant signals, it is recommended to check the respective receiver's datasheet prior to implementing the suggested interface implementation.

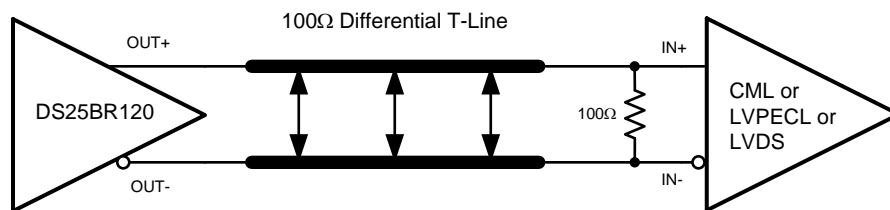

Figure 10. Typical DS25BR120 Output DC-Coupled Interface to an LVDS, CML or LVPECL Receiver

TYPICAL PERFORMANCE CHARACTERISTICS

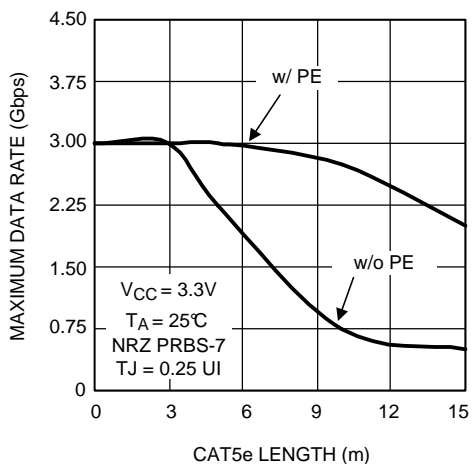

Figure 11. Maximum Data Rate as a Function of CAT5e (Belden 1700A) Length

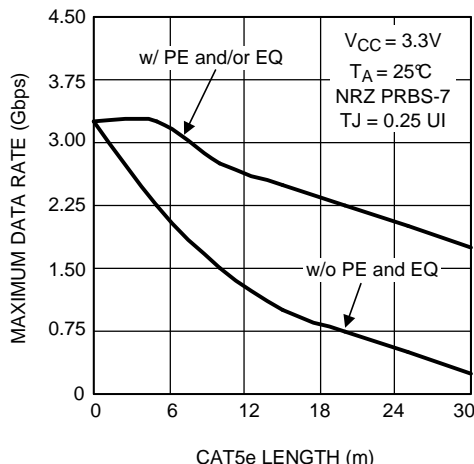

Figure 12. Maximum Data Rate as a Function of CAT5e (Belden 1700A) Length DS25BR120 Used as a Driver DS25BR110 Used as a Receiver

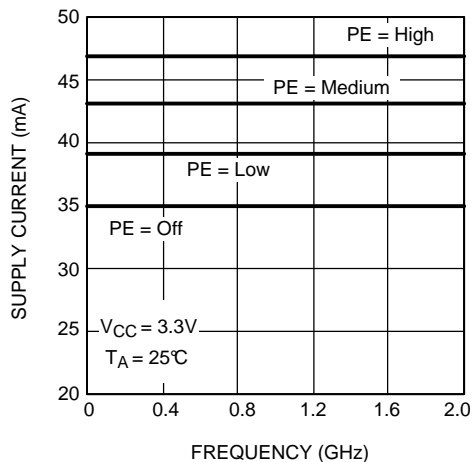

Figure 13. Power Supply Current as a Function of Frequency

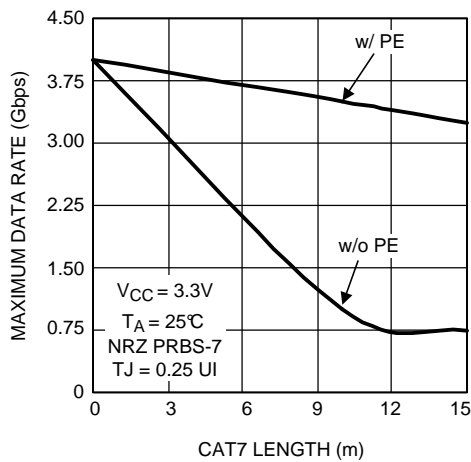

Figure 14. Maximum Data Rate as a Function of CAT7 (Siemon Tera) Length

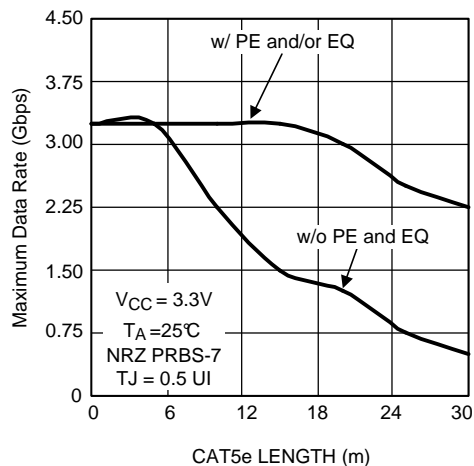

Figure 15. Maximum Data Rate as a Function of CAT5e (Belden 1700A) Length DS25BR120 Used as a Driver DS25BR110 Used as a Receiver

TYPICAL PERFORMANCE CHARACTERISTICS (continued)

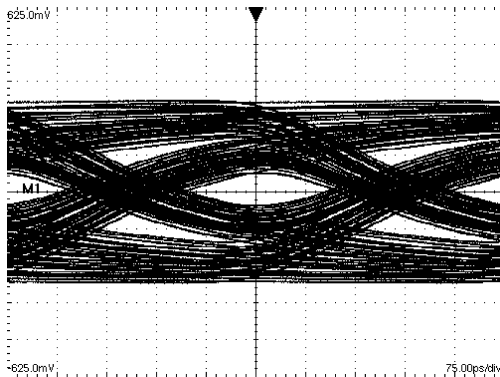

Figure 16. A 2.5 Gbps NRZ PRBS-7 After 40" Differential FR-4 Stripline
V:125 mV / DIV, H:75 ps / DIV

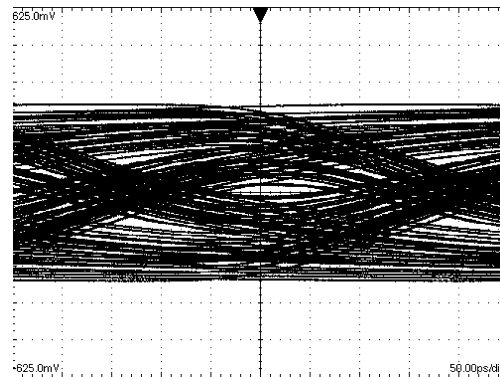

Figure 17. A 3.125 Gbps NRZ PRBS-7 After 40" Differential FR-4 Stripline
V:125 mV / DIV, H:50 ps / DIV

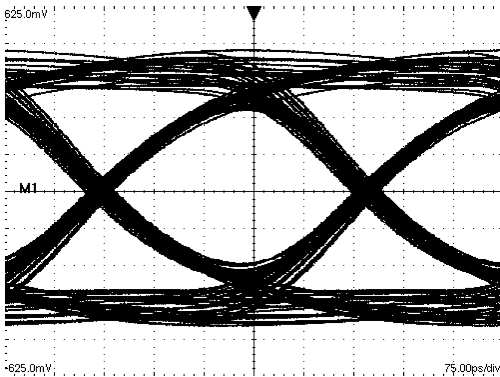

Figure 18. An Equalized (with PE) 2.5 Gbps NRZ PRBS-7 After 40" Differential FR-4 Stripline
V:125 mV / DIV, H:75 ps / DIV

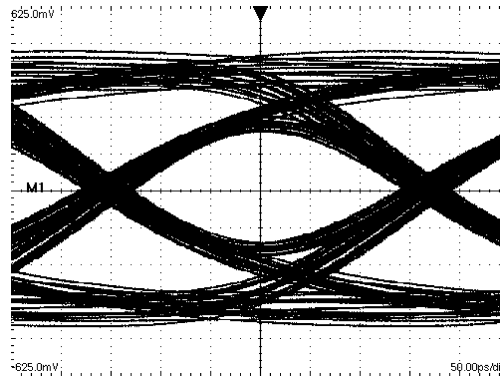

Figure 19. An Equalized (with PE) 3.125 Gbps NRZ PRBS-7 After 40" Differential FR-4 Stripline
V:125 mV / DIV, H:50 ps / DIV

REVISION HISTORY

Changes from Revision D (April 2013) to Revision E	Page
• Changed layout of National Data Sheet to TI format	10

PACKAGING INFORMATION

Orderable part number	Status (1)	Material type (2)	Package Pins	Package qty Carrier	RoHS (3)	Lead finish/ Ball material (4)	MSL rating/ Peak reflow (5)	Op temp (°C)	Part marking (6)
DS25BR120TSD/NOPB	Active	Production	WSON (NGQ) 8	1000 SMALL T&R	Yes	SN	Level-3-260C-168 HR	-40 to 85	2R120
DS25BR120TSD/NOPB.A	Active	Production	WSON (NGQ) 8	1000 SMALL T&R	Yes	SN	Level-3-260C-168 HR	-40 to 85	2R120
DS25BR120TSD/NOPB.B	Active	Production	WSON (NGQ) 8	1000 SMALL T&R	-	Call TI	Call TI	-40 to 85	

(1) **Status:** For more details on status, see our [product life cycle](#).

(2) **Material type:** When designated, preproduction parts are prototypes/experimental devices, and are not yet approved or released for full production. Testing and final process, including without limitation quality assurance, reliability performance testing, and/or process qualification, may not yet be complete, and this item is subject to further changes or possible discontinuation. If available for ordering, purchases will be subject to an additional waiver at checkout, and are intended for early internal evaluation purposes only. These items are sold without warranties of any kind.

(3) **RoHS values:** Yes, No, RoHS Exempt. See the [TI RoHS Statement](#) for additional information and value definition.

(4) **Lead finish/Ball material:** Parts may have multiple material finish options. Finish options are separated by a vertical ruled line. Lead finish/Ball material values may wrap to two lines if the finish value exceeds the maximum column width.

(5) **MSL rating/Peak reflow:** The moisture sensitivity level ratings and peak solder (reflow) temperatures. In the event that a part has multiple moisture sensitivity ratings, only the lowest level per JEDEC standards is shown. Refer to the shipping label for the actual reflow temperature that will be used to mount the part to the printed circuit board.

(6) **Part marking:** There may be an additional marking, which relates to the logo, the lot trace code information, or the environmental category of the part.

Multiple part markings will be inside parentheses. Only one part marking contained in parentheses and separated by a "-" will appear on a part. If a line is indented then it is a continuation of the previous line and the two combined represent the entire part marking for that device.

Important Information and Disclaimer: The information provided on this page represents TI's knowledge and belief as of the date that it is provided. TI bases its knowledge and belief on information provided by third parties, and makes no representation or warranty as to the accuracy of such information. Efforts are underway to better integrate information from third parties. TI has taken and continues to take reasonable steps to provide representative and accurate information but may not have conducted destructive testing or chemical analysis on incoming materials and chemicals. TI and TI suppliers consider certain information to be proprietary, and thus CAS numbers and other limited information may not be available for release.

In no event shall TI's liability arising out of such information exceed the total purchase price of the TI part(s) at issue in this document sold by TI to Customer on an annual basis.

TAPE AND REEL INFORMATION

QUADRANT ASSIGNMENTS FOR PIN 1 ORIENTATION IN TAPE

*All dimensions are nominal

Device	Package Type	Package Drawing	Pins	SPQ	Reel Diameter (mm)	Reel Width W1 (mm)	A0 (mm)	B0 (mm)	K0 (mm)	P1 (mm)	W (mm)	Pin1 Quadrant
DS25BR120TSD/NOPB	WSO	NGQ	8	1000	177.8	12.4	3.3	3.3	1.0	8.0	12.0	Q1

TAPE AND REEL BOX DIMENSIONS

*All dimensions are nominal

Device	Package Type	Package Drawing	Pins	SPQ	Length (mm)	Width (mm)	Height (mm)
DS25BR120TSD/NOPB	WSON	NGQ	8	1000	208.0	191.0	35.0

NGQ0008A

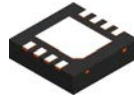

PACKAGE OUTLINE

WSO - 0.8 mm max height

PLASTIC SMALL OUTLINE - NO LEAD

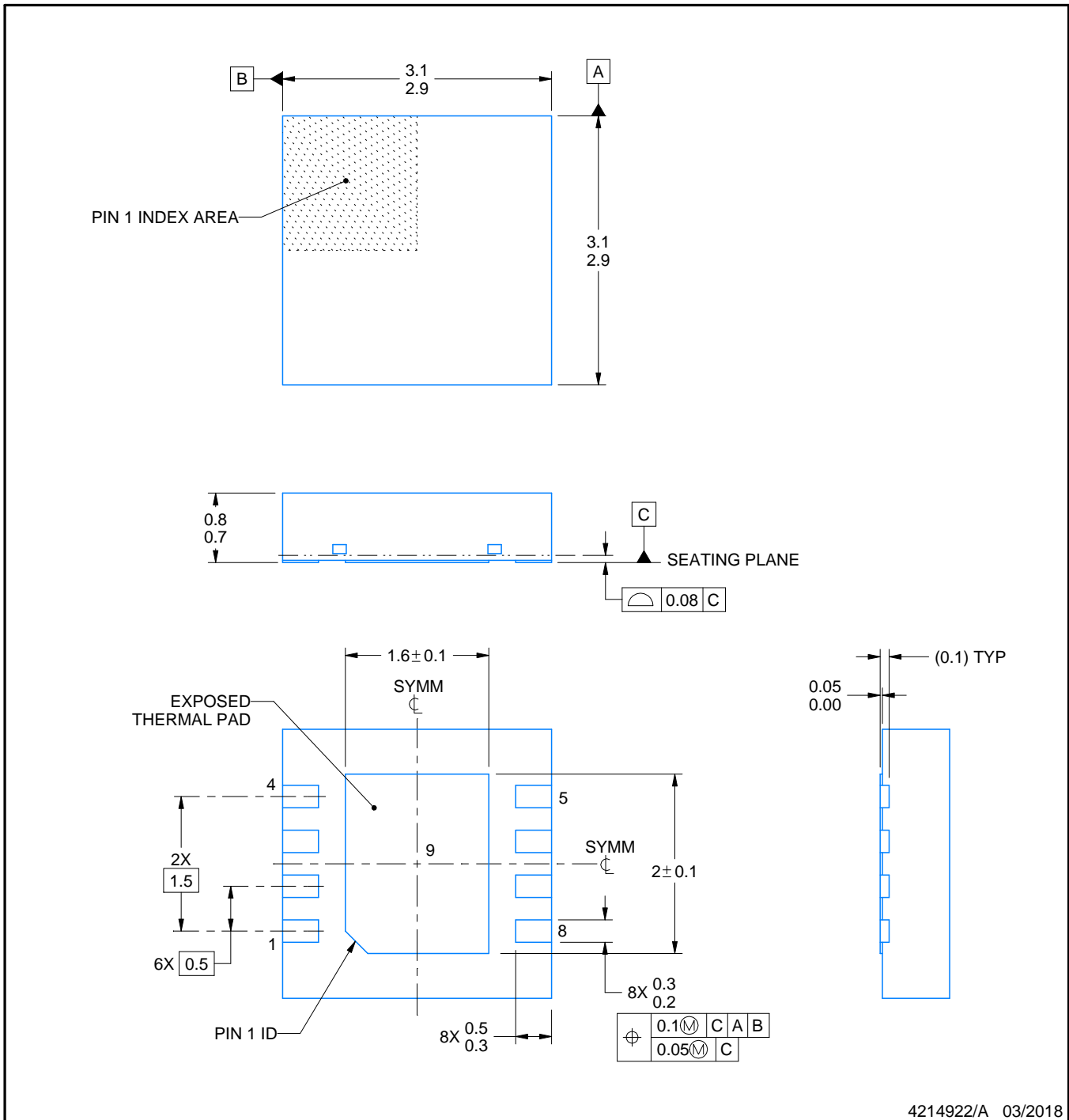

NOTES:

1. All linear dimensions are in millimeters. Any dimensions in parenthesis are for reference only. Dimensioning and tolerancing per ASME Y14.5M.
2. This drawing is subject to change without notice.
3. The package thermal pad must be soldered to the printed circuit board for thermal and mechanical performance.

EXAMPLE BOARD LAYOUT

NGQ0008A

WSON - 0.8 mm max height

PLASTIC SMALL OUTLINE - NO LEAD

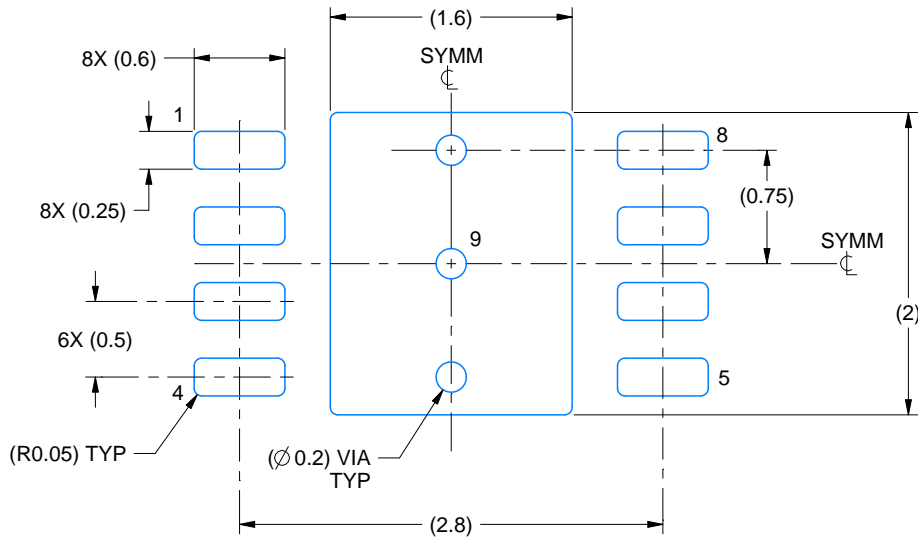

LAND PATTERN EXAMPLE
EXPOSED METAL SHOWN
SCALE:20X

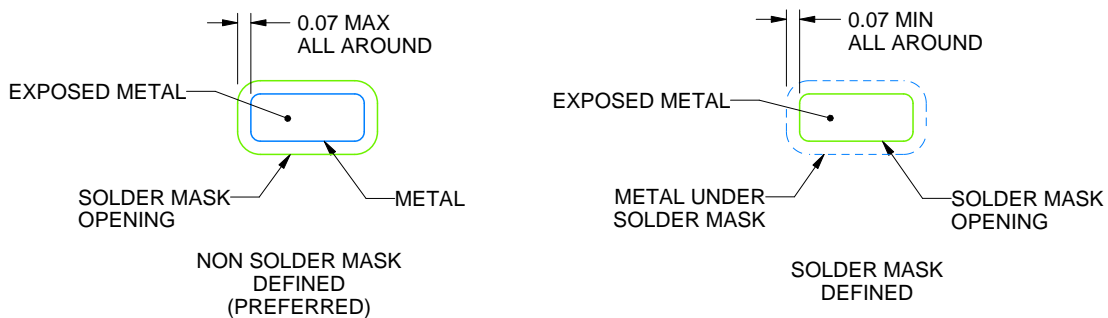

SOLDER MASK DETAILS

4214922/A 03/2018

NOTES: (continued)

- This package is designed to be soldered to a thermal pad on the board. For more information, see Texas Instruments literature number SLUA271 (www.ti.com/lit/slua271).
- Vias are optional depending on application, refer to device data sheet. If any vias are implemented, refer to their locations shown on this view. It is recommended that vias under paste be filled, plugged or tented.

EXAMPLE STENCIL DESIGN

NGQ0008A

WSON - 0.8 mm max height

PLASTIC SMALL OUTLINE - NO LEAD

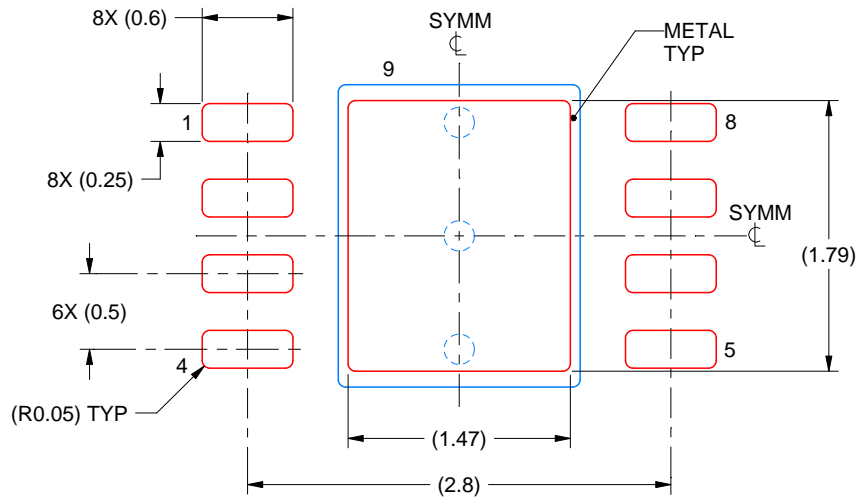

SOLDER PASTE EXAMPLE
BASED ON 0.1 mm THICK STENCIL

EXPOSED PAD 9:
82% PRINTED SOLDER COVERAGE BY AREA UNDER PACKAGE
SCALE:20X

4214922/A 03/2018

NOTES: (continued)

6. Laser cutting apertures with trapezoidal walls and rounded corners may offer better paste release. IPC-7525 may have alternate design recommendations.

IMPORTANT NOTICE AND DISCLAIMER

TI PROVIDES TECHNICAL AND RELIABILITY DATA (INCLUDING DATASHEETS), DESIGN RESOURCES (INCLUDING REFERENCE DESIGNS), APPLICATION OR OTHER DESIGN ADVICE, WEB TOOLS, SAFETY INFORMATION, AND OTHER RESOURCES "AS IS" AND WITH ALL FAULTS, AND DISCLAIMS ALL WARRANTIES, EXPRESS AND IMPLIED, INCLUDING WITHOUT LIMITATION ANY IMPLIED WARRANTIES OF MERCHANTABILITY, FITNESS FOR A PARTICULAR PURPOSE OR NON-INFRINGEMENT OF THIRD PARTY INTELLECTUAL PROPERTY RIGHTS.

These resources are intended for skilled developers designing with TI products. You are solely responsible for (1) selecting the appropriate TI products for your application, (2) designing, validating and testing your application, and (3) ensuring your application meets applicable standards, and any other safety, security, regulatory or other requirements.

These resources are subject to change without notice. TI grants you permission to use these resources only for development of an application that uses the TI products described in the resource. Other reproduction and display of these resources is prohibited. No license is granted to any other TI intellectual property right or to any third party intellectual property right. TI disclaims responsibility for, and you fully indemnify TI and its representatives against any claims, damages, costs, losses, and liabilities arising out of your use of these resources.

TI's products are provided subject to [TI's Terms of Sale](#), [TI's General Quality Guidelines](#), or other applicable terms available either on ti.com or provided in conjunction with such TI products. TI's provision of these resources does not expand or otherwise alter TI's applicable warranties or warranty disclaimers for TI products. Unless TI explicitly designates a product as custom or customer-specified, TI products are standard, catalog, general purpose devices.

TI objects to and rejects any additional or different terms you may propose.

Copyright © 2025, Texas Instruments Incorporated

Last updated 10/2025