

# LMV3xxA Low-Voltage Rail-to-Rail Output Operational Amplifiers

## 1 Features

- Low input offset voltage:  $\pm 1\text{mV}$
- Rail-to-rail output
- Unity-gain bandwidth: 1MHz
- Low broadband noise:  $30\text{nV}/\sqrt{\text{Hz}}$
- Low input bias current: 10pA
- Low quiescent current:  $70\mu\text{A}/\text{Ch}$
- Unity-gain stable
- Internal RFI and EMI filter
- Operational at supply voltages as low as 2.5V
- Easier to stabilize with higher capacitive load due to resistive open-loop output impedance
- Extended temperature range:  $-40^\circ\text{C}$  to  $125^\circ\text{C}$

## 2 Applications

- Smoke detectors
- [Motion detectors](#)
- [Wearable devices](#)
- Large and small appliances
- EPOS
- [Barcode scanners](#)
- Sensor signal conditioning
- Power modules
- [Personal electronics](#)
- Active filters
- [HVAC: heating, ventilating, and air conditioning](#)
- [Motor control: AC induction](#)
- Low-side current sensing

## 3 Description

The LMV3xxA family includes single (LMV321A), dual (LMV358A), and quad-channel (LMV324A) low-voltage (2.5V to 5.5V) operational amplifiers (op amps) with rail-to-rail output swing capabilities. These op amps provide a cost-effective solution for space-constrained applications such as large appliances, smoke detectors, and personal electronics where low-voltage operation and high capacitive-load drive are required. The capacitive-load drive of the LMV3xxA family is 500pF, and the resistive open-loop output impedance makes stabilization easier with much higher capacitive loads. These op amps are designed specifically for low-voltage operation (2.5V to 5.5V) with performance specifications similar to the LMV3xx devices.

The robust design of the LMV3xxA family simplifies circuit design. The op amps feature unity-gain stability, an integrated RFI and EMI rejection filter, and no-phase reversal in overdrive conditions.

The LMV3xxA family is available in industry-standard packages such as SOIC, MSOP, SOT-23, and TSSOP packages.

### Package Information

PART NUMBER	PACKAGE <sup>(1)</sup>	PACKAGE SIZE <sup>(2)</sup>
LMV321A	DBV (SOT-23, 5)	2.9mm × 2.8mm
	DCK (SC70, 5)	2mm × 2.1mm
LMV358A	D (SOIC, 8)	4.9mm × 6mm
	DGK (VSSOP, 8)	3mm × 4.9mm
	PW (TSSOP, 8)	3mm × 6.4mm
	DDF (SOT-23, 8)	2.9mm × 2.8mm
	D (SOIC, 14)	8.65mm × 6mm
LMV324A	DYY (SOT-23, 14)	4.2mm × 3.26mm
	PW (TSSOP, 14)	5mm × 6.4mm
	D (SOIC, 14)	8.65mm × 6mm

- (1) For all available packages, see [Section 10](#).
- (2) The package size (length × width) is a nominal value and includes pins, where applicable.



$$\frac{V_{OUT}}{V_{IN}} = \left(1 + \frac{R_F}{R_G}\right) \left(\frac{1}{1 + sR_1C_1}\right)$$

### Single-Pole, Low-Pass Filter



## Table of Contents

<b>1 Features</b> .....	1	6.4 Device Functional Modes.....	15
<b>2 Applications</b> .....	1	<b>7 Application and Implementation</b> .....	16
<b>3 Description</b> .....	1	7.1 Application Information.....	16
<b>4 Pin Functions and Configurations</b> .....	3	7.2 Typical Application.....	16
<b>5 Specifications</b> .....	5	7.3 Power Supply Recommendations.....	20
5.1 Absolute Maximum Ratings.....	5	7.4 Layout.....	20
5.2 ESD Ratings.....	5	<b>8 Device and Documentation Support</b> .....	22
5.3 Recommended Operating Conditions.....	5	8.1 Documentation Support.....	22
5.4 Thermal Information: LMV321A.....	6	8.2 Receiving Notification of Documentation Updates....	22
5.5 Thermal Information: LMV358A.....	6	8.3 Support Resources.....	22
5.6 Thermal Information: LMV324A.....	6	8.4 Trademarks.....	22
5.7 Electrical Characteristics.....	7	8.5 Electrostatic Discharge Caution.....	22
5.8 Typical Characteristics.....	8	8.6 Glossary.....	22
<b>6 Detailed Description</b> .....	14	<b>9 Revision History</b> .....	22
6.1 Overview.....	14	<b>10 Mechanical, Packaging, and Orderable Information</b> .....	23
6.2 Functional Block Diagram.....	14		
6.3 Feature Description.....	15		

## 4 Pin Functions and Configurations



**Figure 4-1. LMV321A DBV Package 5-Pin SOT-23 Top View**



**Figure 4-2. LMV321AU DBV, LMV321A DCK Package 5-Pin SOT-23, SC70 Top View**

**Table 4-1. Pin Functions: LMV321A**

PIN			TYPE <sup>(1)</sup>	DESCRIPTION
NAME	DBV	DBV (U), DCK		
-IN	4	3	I	Inverting input
+IN	3	1	I	Noninverting input
OUT	1	4	O	Output
V-	2	2	—	Negative (lowest) supply or ground (for single-supply operation)
V+	5	5	—	Positive (highest) supply

(1) I = input, O = output



**Figure 4-3. LMV358A D, DDF, DGK, or PW Packages, 8-Pin SOIC, SOT-23, VSSOP, or TSSOP (Top View)**

**Table 4-2. Pin Functions: LMV358A**

PIN		TYPE <sup>(1)</sup>	DESCRIPTION
NAME	NO.		
-IN A	2	I	Inverting input, channel A
+IN A	3	I	Noninverting input, channel A
-IN B	6	I	Inverting input, channel B
+IN B	5	I	Noninverting input, channel B
OUT A	1	O	Output, channel A
OUT B	7	O	Output, channel B
V-	4	—	Negative (lowest) supply or ground (for single-supply operation)
V+	8	—	Positive (highest) supply

(1) I = input, O = output

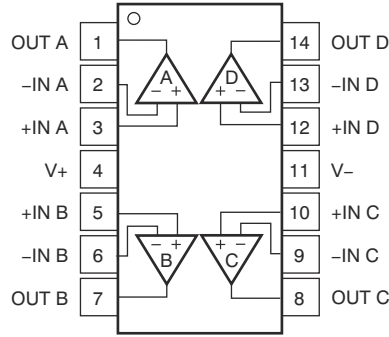

Figure 4-4. LMV324A D, DYY, PW Packages, 14-Pin SOIC, SOT-23, TSSOP (Top View)

Table 4-3. Pin Functions: LMV324A

PIN		TYPE <sup>(1)</sup>	DESCRIPTION
NAME	NO.		
-IN A	2	I	Inverting input, channel A
+IN A	3	I	Noninverting input, channel A
-IN B	6	I	Inverting input, channel B
+IN B	5	I	Noninverting input, channel B
-IN C	9	I	Inverting input, channel C
+IN C	10	I	Noninverting input, channel C
-IN D	13	I	Inverting input, channel D
+IN D	12	I	Noninverting input, channel D
OUT A	1	O	Output, channel A
OUT B	7	O	Output, channel B
OUT C	8	O	Output, channel C
OUT D	14	O	Output, channel D
V-	11	—	Negative (lowest) supply or ground (for single-supply operation)
V+	4	—	Positive (highest) supply

(1) I = input, O = output

## 5 Specifications

### 5.1 Absolute Maximum Ratings

over operating temperature range (unless otherwise noted)<sup>(1)</sup>

		MIN	MAX	UNIT	
Supply voltage, ([V+] – [V–])		0	6	V	
Signal input pins	Voltage <sup>(2)</sup>	Common-mode	(V–) – 0.5	(V+) + 0.5	V
		Differential	(V+) – (V–) + 0.2		V
	Current <sup>(2)</sup>	–10	10	mA	
Output short-circuit <sup>(3)</sup>		Continuous			
Operating, T <sub>A</sub>		–55	150	°C	
Operating junction temperature, T <sub>J</sub>			150	°C	
Storage temperature, T <sub>stg</sub>		–65	150	°C	

- (1) Stresses beyond those listed under *Absolute Maximum Ratings* may cause permanent damage to the device. These are stress ratings only, which do not imply functional operation of the device at these or any other conditions beyond those indicated under *Recommended Operating Conditions*. Exposure to absolute-maximum-rated conditions for extended periods may affect device reliability.
- (2) Input pins are diode-clamped to the power-supply rails. Input signals that may swing more than 0.5 V beyond the supply rails must be current limited to 10 mA or less.
- (3) Short-circuit to ground, one amplifier per package.

### 5.2 ESD Ratings

		VALUE	UNIT
V <sub>(ESD)</sub>	Electrostatic discharge	Human-body model (HBM), per ANSI/ESDA/JEDEC JS-001 <sup>(1)</sup>	±2000
		Charged-device model (CDM), per JEDEC specification JESD22-C101 <sup>(2)</sup>	±1000

- (1) JEDEC document JEP155 states that 500-V HBM allows safe manufacturing with a standard ESD control process.
- (2) JEDEC document JEP157 states that 250-V CDM allows safe manufacturing with a standard ESD control process.

### 5.3 Recommended Operating Conditions

over operating temperature range (unless otherwise noted)

		MIN	MAX	UNIT
V <sub>S</sub>	Supply voltage	2.5	5.5	V
T <sub>A</sub>	Specified temperature	–40	125	°C

### 5.4 Thermal Information: LMV321A

THERMAL METRIC <sup>(1)</sup>		LMV321A		UNIT
		DBV (SOT-23)	DCK (SC70)	
		5 PINS	5 PINS	
R <sub>θJA</sub>	Junction-to-ambient thermal resistance	232.8	239.6	°C/W
R <sub>θJC(top)</sub>	Junction-to-case (top) thermal resistance	153.8	148.5	°C/W
R <sub>θJB</sub>	Junction-to-board thermal resistance	100.9	82.3	°C/W
ψ <sub>JT</sub>	Junction-to-top characterization parameter	77.2	54.5	°C/W
ψ <sub>JB</sub>	Junction-to-board characterization parameter	100.4	81.8	°C/W
R <sub>θJC(bot)</sub>	Junction-to-case (bottom) thermal resistance	N/A	N/A	°C/W

(1) For more information about traditional and new thermal metrics, see [Semiconductor and IC Package Thermal Metrics](#).

### 5.5 Thermal Information: LMV358A

THERMAL METRIC <sup>(1)</sup>		LMV358A				UNIT
		D (SOIC)	DGK (VSSOP)	PW (TSSOP)	DDF (SOT-23)	
		8 PINS	8 PINS	8 PINS	8 PINS	
R <sub>θJA</sub>	Junction-to-ambient thermal resistance	147.4	201.2	205.8	183.7	°C/W
R <sub>θJC(top)</sub>	Junction-to-case (top) thermal resistance	94.3	85.7	106.7	112.5	°C/W
R <sub>θJB</sub>	Junction-to-board thermal resistance	89.5	122.9	133.9	98.2	°C/W
ψ <sub>JT</sub>	Junction-to-top characterization parameter	47.3	21.2	34.4	18.8	°C/W
ψ <sub>JB</sub>	Junction-to-board characterization parameter	89	121.4	132.6	97.6	°C/W

(1) For more information about traditional and new thermal metrics, see [Semiconductor and IC Package Thermal Metrics](#).

### 5.6 Thermal Information: LMV324A

THERMAL METRIC <sup>(1)</sup>		LMV324A			UNIT
		D (SOIC)	DYY (SOT-23)	PW (TSSOP)	
		14 PINS	14 PINS	8 PINS	
R <sub>θJA</sub>	Junction-to-ambient thermal resistance	102.1	154.3	148.3	°C/W
R <sub>θJC(top)</sub>	Junction-to-case (top) thermal resistance	56.8	86.8	68.1	°C/W
R <sub>θJB</sub>	Junction-to-board thermal resistance	58.5	67.9	92.7	°C/W
ψ <sub>JT</sub>	Junction-to-top characterization parameter	20.5	10.1	16.9	°C/W
ψ <sub>JB</sub>	Junction-to-board characterization parameter	58.1	67.5	91.8	°C/W

## 5.7 Electrical Characteristics

For  $V_S = (V+) - (V-) = 2.5\text{ V to }5.5\text{ V}$  ( $\pm 1.25\text{ V to } \pm 2.75\text{ V}$ ),  $T_A = 25^\circ\text{C}$ ,  $R_L = 10\text{ k}\Omega$  connected to  $V_S / 2$ , and  $V_{CM} = V_{OUT} = V_S / 2$  (unless otherwise noted)

PARAMETER		TEST CONDITIONS	MIN	TYP	MAX	UNIT
<b>OFFSET VOLTAGE</b>						
$V_{OS}$	Input offset voltage	$V_S = 5\text{ V}$		$\pm 1$	$\pm 4$	mV
		$V_S = 5\text{ V}, T_A = -40^\circ\text{C to }125^\circ\text{C}$			$\pm 5$	
$dV_{OS}/dT$	$V_{OS}$ vs temperature	$T_A = -40^\circ\text{C to }125^\circ\text{C}$		$\pm 1$		$\mu\text{V}/^\circ\text{C}$
PSRR	Power-supply rejection ratio	$V_S = 2.5\text{ to }5.5\text{ V}, V_{CM} = (V-)$	78	100		dB
<b>INPUT VOLTAGE RANGE</b>						
$V_{CM}$	Common-mode voltage range	No phase reversal, rail-to-rail input	$(V-) - 0.1$		$(V+) - 1$	V
CMRR	Common-mode rejection ratio	$V_S = 2.5\text{ V}, (V-) - 0.1\text{ V} < V_{CM} < (V+) - 1.4\text{ V}$ $T_A = -40^\circ\text{C to }125^\circ\text{C}$		86		dB
		$V_S = 5.5\text{ V}, (V-) - 0.1\text{ V} < V_{CM} < (V+) - 1.4\text{ V}$ $T_A = -40^\circ\text{C to }125^\circ\text{C}$		95		
		$V_S = 5.5\text{ V}, (V-) - 0.1\text{ V} < V_{CM} < (V+) + 0.1\text{ V}$ $T_A = -40^\circ\text{C to }125^\circ\text{C}$	63	77		
		$V_S = 2.5\text{ V}, (V-) - 0.1\text{ V} < V_{CM} < (V+) + 0.1\text{ V}$ $T_A = -40^\circ\text{C to }125^\circ\text{C}$		68		
<b>INPUT BIAS CURRENT</b>						
$I_B$	Input bias current	$V_S = 5\text{ V}$		$\pm 10$		pA
$I_{OS}$	Input offset current			$\pm 3$		pA
<b>NOISE</b>						
$E_n$	Input voltage noise (peak-to-peak)	$f = 0.1\text{ Hz to }10\text{ Hz}, V_S = 5\text{ V}$		5.1		$\mu\text{V}_{PP}$
$e_n$	Input voltage noise density	$f = 1\text{ kHz}, V_S = 5\text{ V}$		33		$\text{nV}/\sqrt{\text{Hz}}$
		$f = 10\text{ kHz}, V_S = 5\text{ V}$		30		
$i_n$	Input current noise density	$f = 1\text{ kHz}, V_S = 5\text{ V}$		25		$\text{fA}/\sqrt{\text{Hz}}$
<b>INPUT CAPACITANCE</b>						
$C_{ID}$	Differential			1.5		pF
$C_{IC}$	Common-mode			5		pF
<b>OPEN-LOOP GAIN</b>						
$A_{OL}$	Open-loop voltage gain	$V_S = 5.5\text{ V}, (V-) + 0.05\text{ V} < V_O < (V+) - 0.05\text{ V}, R_L = 10\text{ k}\Omega$	100	115		dB
		$V_S = 2.5\text{ V}, (V-) + 0.04\text{ V} < V_O < (V+) - 0.04\text{ V}, R_L = 10\text{ k}\Omega$		98		
		$V_S = 2.5\text{ V}, (V-) + 0.1\text{ V} < V_O < (V+) - 0.1\text{ V}, R_L = 2\text{ k}\Omega$		112		
		$V_S = 5.5\text{ V}, (V-) + 0.15\text{ V} < V_O < (V+) - 0.15\text{ V}, R_L = 2\text{ k}\Omega$		128		
<b>FREQUENCY RESPONSE</b>						
GBW	Gain-bandwidth product	$V_S = 5\text{ V}$		1		MHz
$\phi_m$	Phase margin	$V_S = 5.5\text{ V}, G = 1$		76		$^\circ$
SR	Slew rate	$V_S = 5\text{ V}$		1.7		V/ $\mu\text{s}$
$t_s$	Settling time	To 0.1%, $V_S = 5\text{ V}, 2\text{-V step}, G = +1, C_L = 100\text{ pF}$		3		$\mu\text{s}$
		To 0.01%, $V_S = 5\text{ V}, 2\text{-V step}, G = +1, C_L = 100\text{ pF}$		4		
$t_{OR}$	Overload recovery time	$V_S = 5\text{ V}, V_{IN} \times \text{gain} > V_S$		0.9		$\mu\text{s}$
THD+N	Total harmonic distortion + noise	$V_S = 5.5\text{ V}, V_{CM} = 2.5\text{ V}, V_O = 1\text{ V}_{RMS}, G = +1, f = 1\text{ kHz}, 80\text{-kHz measurement BW}$		0.005%		
<b>OUTPUT</b>						
$V_O$	Voltage output swing from supply rails	$V_S = 5.5\text{ V}, R_L = 10\text{ k}\Omega$		20	50	mV
		$V_S = 5.5\text{ V}, R_L = 2\text{ k}\Omega$		40	75	
$I_{SC}$	Short-circuit current	$V_S = 5.5\text{ V}$		$\pm 40$		mA
$Z_O$	Open-loop output impedance	$V_S = 5\text{ V}, f = 1\text{ MHz}$		1200		$\Omega$
<b>POWER SUPPLY</b>						
$V_S$	Specified voltage range		2.5 ( $\pm 1.25$ )		5.5 ( $\pm 2.75$ )	V
$I_Q$	Quiescent current per amplifier	$I_O = 0\text{ mA}, V_S = 5.5\text{ V}$		70	125	$\mu\text{A}$
		$I_O = 0\text{ mA}, V_S = 5.5\text{ V}, T_A = -40^\circ\text{C to }125^\circ\text{C}$			150	
	Power-on time	$V_S = 0\text{ V to }5\text{ V}, \text{ to }90\% I_Q \text{ level}$		50		$\mu\text{s}$

## 5.8 Typical Characteristics

at  $T_A = 25^\circ\text{C}$ ,  $V_+ = 2.75\text{ V}$ ,  $V_- = -2.75\text{ V}$ ,  $R_L = 10\text{ k}\Omega$  connected to  $V_S / 2$ ,  $V_{CM} = V_S / 2$ , and  $V_{OUT} = V_S / 2$  (unless otherwise noted)

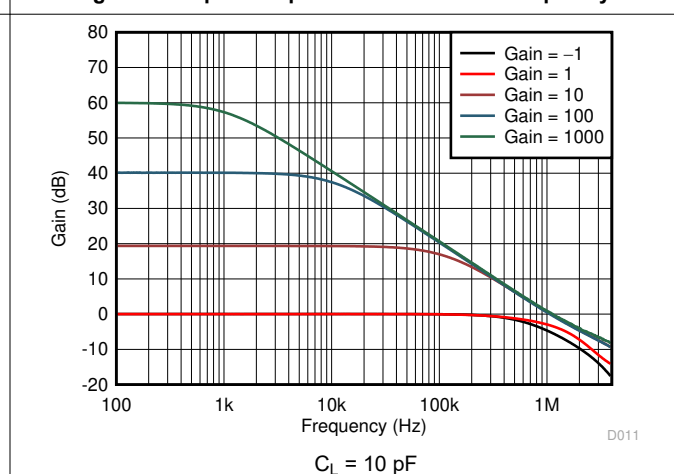
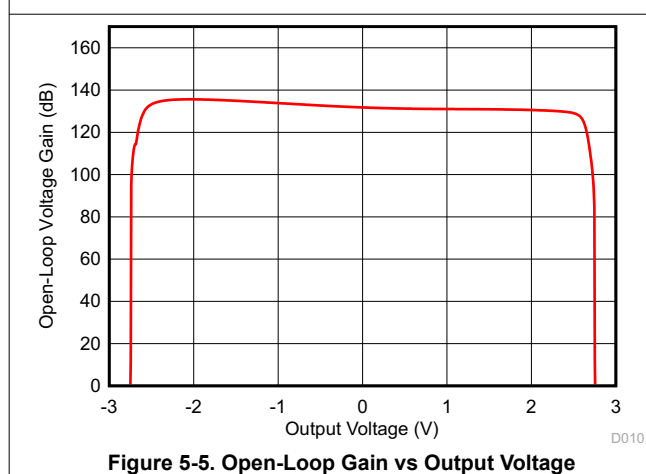
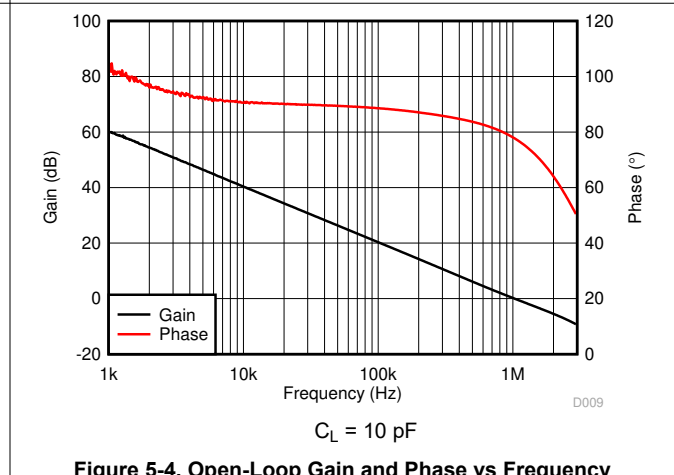
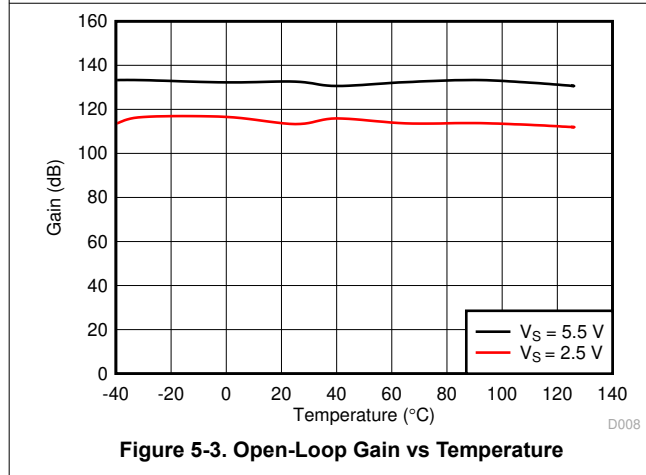
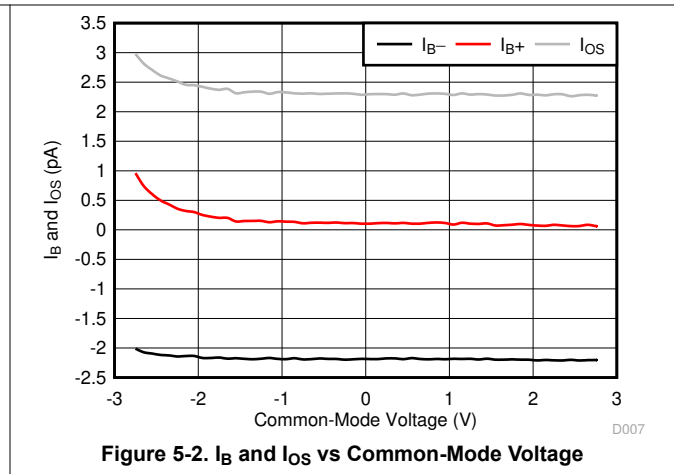
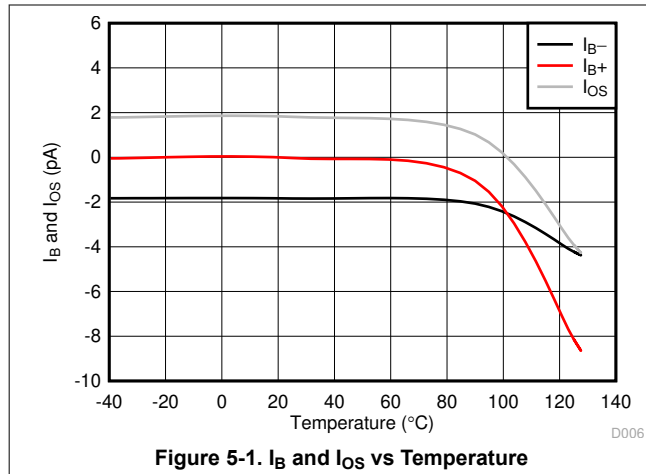

### 5.8 Typical Characteristics (continued)

at  $T_A = 25^\circ\text{C}$ ,  $V_+ = 2.75\text{ V}$ ,  $V_- = -2.75\text{ V}$ ,  $R_L = 10\text{ k}\Omega$  connected to  $V_S / 2$ ,  $V_{CM} = V_S / 2$ , and  $V_{OUT} = V_S / 2$  (unless otherwise noted)

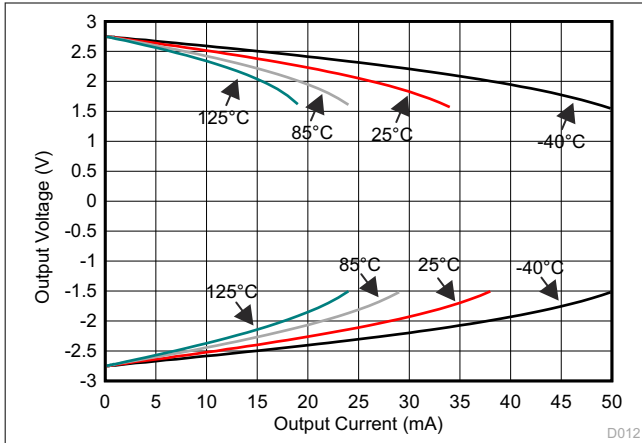

**Figure 5-7. Output Voltage vs Output Current (Claw)**



**Figure 5-8. PSRR vs Frequency**



**Figure 5-9. DC PSRR vs Temperature**



**Figure 5-10. CMRR vs Frequency**

### 5.8 Typical Characteristics (continued)

at  $T_A = 25^\circ\text{C}$ ,  $V_+ = 2.75\text{ V}$ ,  $V_- = -2.75\text{ V}$ ,  $R_L = 10\text{ k}\Omega$  connected to  $V_S / 2$ ,  $V_{CM} = V_S / 2$ , and  $V_{OUT} = V_S / 2$  (unless otherwise noted)

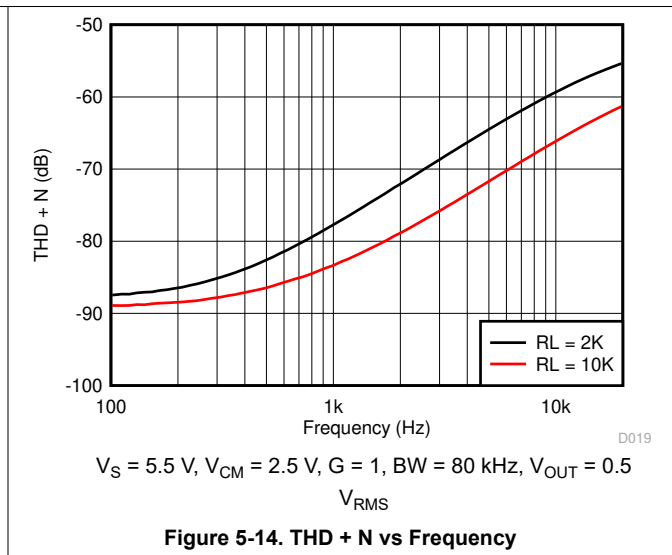
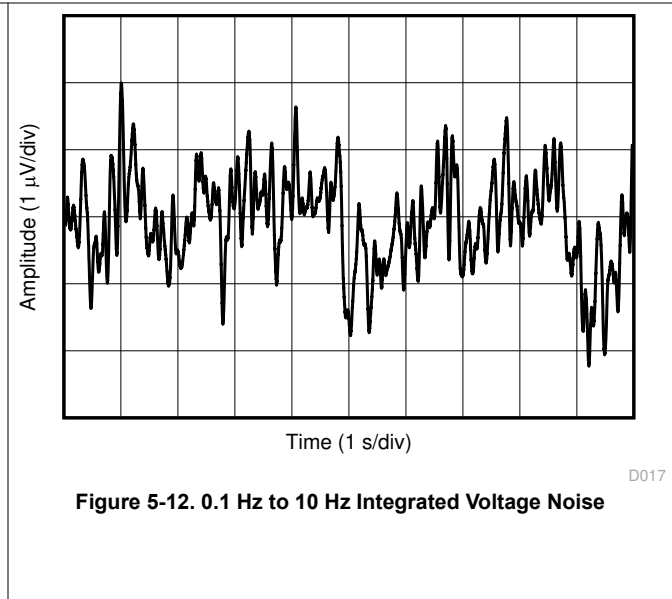

### 5.8 Typical Characteristics (continued)

at  $T_A = 25^\circ\text{C}$ ,  $V_+ = 2.75\text{ V}$ ,  $V_- = -2.75\text{ V}$ ,  $R_L = 10\text{ k}\Omega$  connected to  $V_S / 2$ ,  $V_{CM} = V_S / 2$ , and  $V_{OUT} = V_S / 2$  (unless otherwise noted)

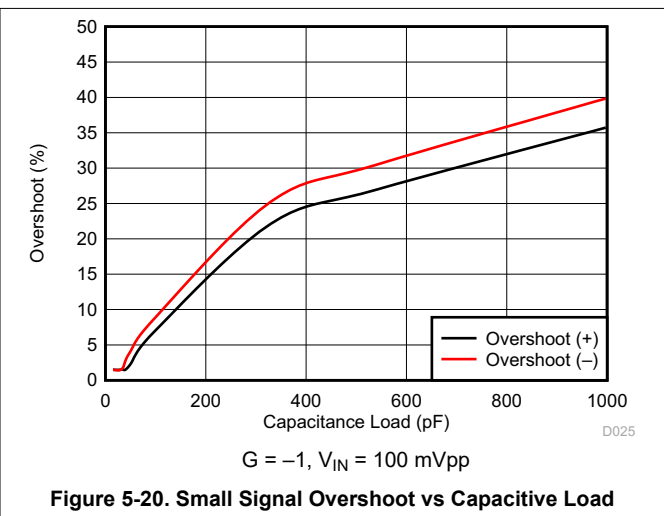
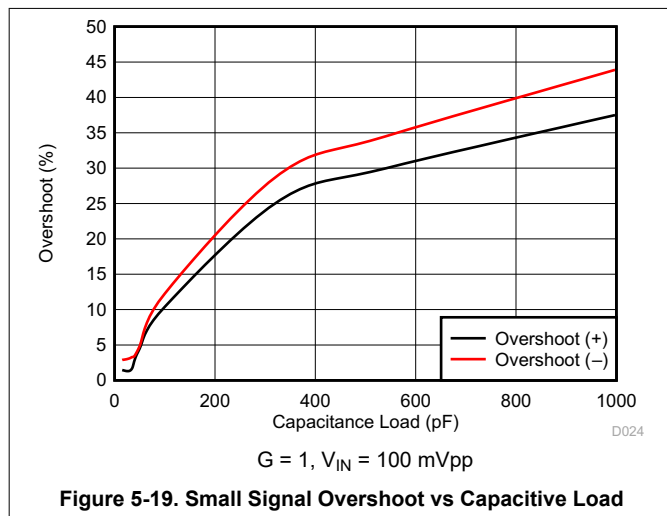
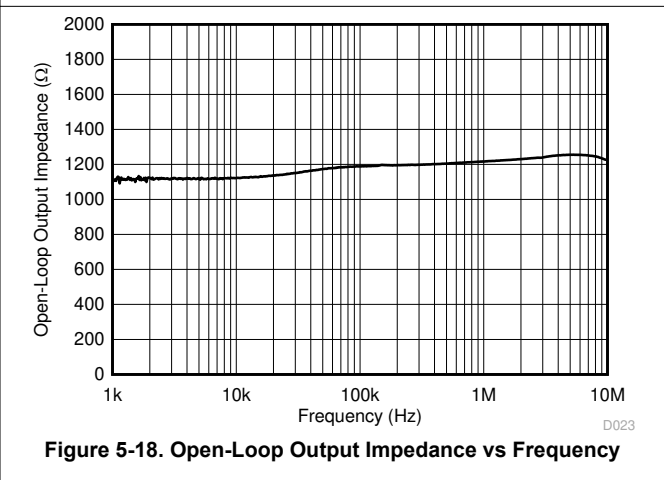
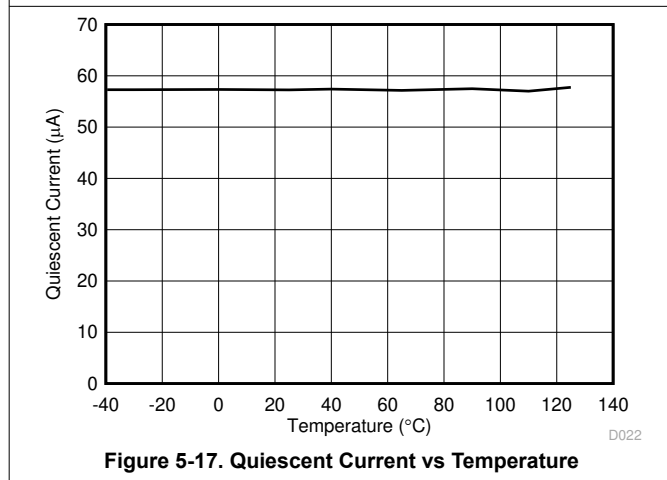
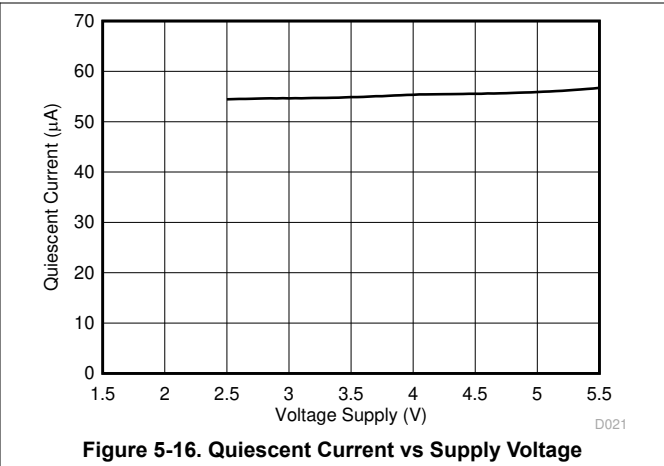
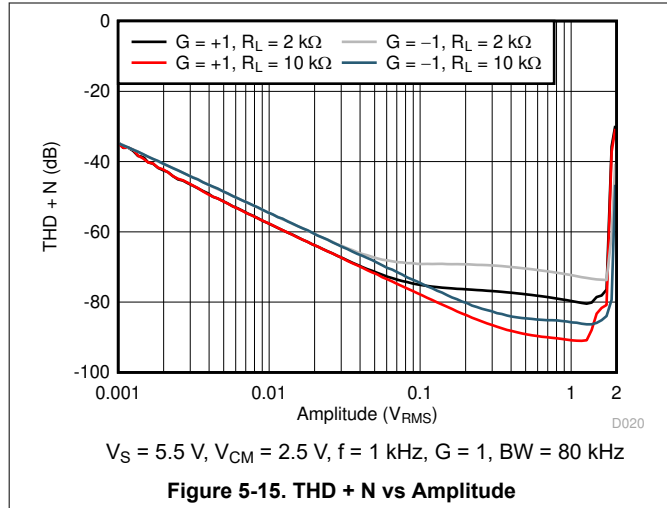

### 5.8 Typical Characteristics (continued)

at  $T_A = 25^\circ\text{C}$ ,  $V_+ = 2.75\text{ V}$ ,  $V_- = -2.75\text{ V}$ ,  $R_L = 10\text{ k}\Omega$  connected to  $V_S / 2$ ,  $V_{CM} = V_S / 2$ , and  $V_{OUT} = V_S / 2$  (unless otherwise noted)



**Figure 5-21. Phase Margin vs Capacitive Load**

D026



$G = 1$ ,  $V_{IN} = 6.5\text{ V}_{PP}$

**Figure 5-22. No Phase Reversal**

D027

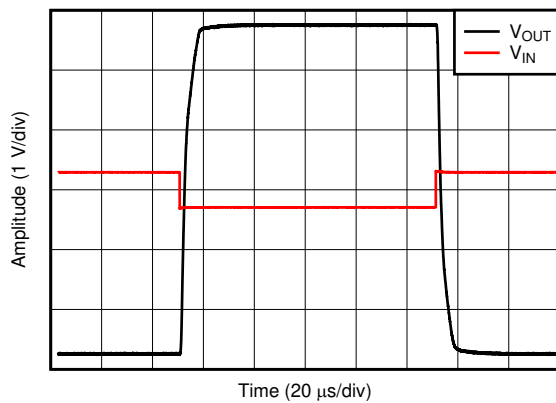

$G = -10$ ,  $V_{IN} = 600\text{ mV}_{PP}$

**Figure 5-23. Overload Recovery**

D028



$G = 1$ ,  $V_{IN} = 100\text{ mV}_{PP}$ ,  $C_L = 10\text{ pF}$

**Figure 5-24. Small-Signal Step Response**

D029

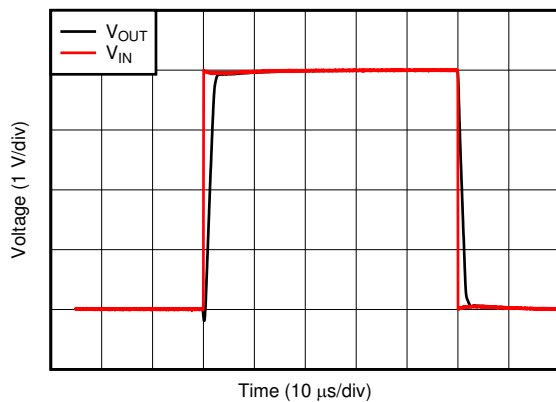

$G = 1$ ,  $V_{IN} = 4\text{ V}_{PP}$ ,  $C_L = 10\text{ pF}$

**Figure 5-25. Large-Signal Step Response**

D030



$G = 1$ ,  $C_L = 100\text{ pF}$ , 2-V step

**Figure 5-26. Large-Signal Settling Time (Negative)**

D031

### 5.8 Typical Characteristics (continued)

at  $T_A = 25^\circ\text{C}$ ,  $V_+ = 2.75\text{ V}$ ,  $V_- = -2.75\text{ V}$ ,  $R_L = 10\text{ k}\Omega$  connected to  $V_S / 2$ ,  $V_{CM} = V_S / 2$ , and  $V_{OUT} = V_S / 2$  (unless otherwise noted)



$G = 1$ ,  $C_L = 100\text{ pF}$ , 2-V step

**Figure 5-27. Large-Signal Settling Time (Positive)**



**Figure 5-28. Short-Circuit Current vs Temperature**



**Figure 5-29. Maximum Output Voltage vs Frequency**



**Figure 5-30. Electromagnetic Interference Rejection Ratio Referred to Noninverting Input (EMIRR+) vs Frequency**

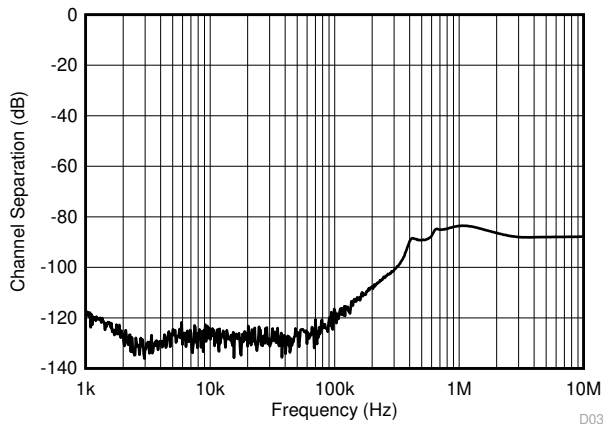

**Figure 5-31. Channel Separation**

## 6 Detailed Description

### 6.1 Overview

The LMV3xxA is a family of low-power, rail-to-rail output op amps. These devices operate from 2.5 V to 5.5 V, are unity-gain stable, and are designed for a wide range of general-purpose applications. The input common-mode voltage range includes the negative rail and allows the LMV3xxA family to be used in many single-supply applications. Rail-to-rail output swing significantly increases dynamic range, especially in low-supply applications, and makes them suitable for driving sampling analog-to-digital converters (ADCs).

### 6.2 Functional Block Diagram



## 6.3 Feature Description

### 6.3.1 Operating Voltage

The LMV3xxA family of op amps are for operate from 2.5 V to 5.5 V. In addition, many specifications such as input offset voltage, quiescent current, offset current, and short circuit current apply from  $-40^{\circ}\text{C}$  to  $125^{\circ}\text{C}$ . Parameters that vary significantly with operating voltages or temperature are shown in [Section 5.8](#).

### 6.3.2 Input Common Mode Range

The input common-mode voltage range of the LMV3xxA family extends 100 mV beyond the negative supply rail and within 1 V below the positive rail for the full supply voltage range of 2.5 V to 5.5 V. This performance is achieved with a P-channel differential pair, as shown in the [Functional Block Diagram](#). Additionally, a complementary N-channel differential pair has been included in parallel to eliminate issues with phase reversal that are common with previous generations of op amps. However, the N-channel pair is not optimized for operation. TI recommends limiting any voltages applied at the inputs to less than  $V_{\text{CC}} - 1\text{ V}$  to ensure that the op amp conforms to the specifications detailed in the [Electrical Characteristics](#) table.

### 6.3.3 Rail-to-Rail Output

Designed as a low-power, low-voltage operational amplifier, the LMV3xxA family delivers a robust output drive capability. A class-AB output stage with common-source transistors achieves full rail-to-rail output swing capability. For resistive loads of 10 k $\Omega$ , the output swings to within 20 mV of either supply rail, regardless of the applied power-supply voltage. Different load conditions change the ability of the amplifier to swing close to the rails.

### 6.3.4 Overload Recovery

Overload recovery is defined as the time required for the operational amplifier output to recover from a saturated state to a linear state. The output devices of the operational amplifier enter a saturation region when the output voltage exceeds the rated operating voltage, because of the high input voltage or the high gain. After the device enters the saturation region, the charge carriers in the output devices require time to return to the linear state. After the charge carriers return to the linear state, the device begins to slew at the specified slew rate. Therefore, the propagation delay (in case of an overload condition) is the sum of the overload recovery time and the slew time. The overload recovery time for the LMV3xxA family is approximately 850 ns.

## 6.4 Device Functional Modes

The LMV3xxA family has a single functional mode. The devices are powered on as long as the power-supply voltage is between 2.5 V ( $\pm 1.25\text{ V}$ ) and 5.5 V ( $\pm 2.75\text{ V}$ ).

## 7 Application and Implementation

### Note

Information in the following applications sections is not part of the TI component specification, and TI does not warrant its accuracy or completeness. TI's customers are responsible for determining suitability of components for their purposes. Customers should validate and test their design implementation to confirm system functionality.

### 7.1 Application Information

The LMV3xxA family of low-power, rail-to-rail output operational amplifiers is specifically designed for portable applications. The devices operate from 2.5 V to 5.5 V, are unity-gain stable, and are suitable for a wide range of general-purpose applications. The class AB output stage is capable of driving less than or equal to 10-k $\Omega$  loads connected to any point between V+ and V-. The input common-mode voltage range includes the negative rail, and allows the LMV3xxA devices to be used in many single-supply applications.

### 7.2 Typical Application

#### 7.2.1 LMV3xxA Low-Side, Current Sensing Application

Figure 7-1 shows the LMV3xxA configured in a low-side current sensing application.



Figure 7-1. LMV3xxA in a Low-Side, Current-Sensing Application

### 7.2.1.1 Design Requirements

The design requirements for this design are:

- Load current: 0 A to 1 A
- Output voltage: 4.9 V
- Maximum shunt voltage: 100 mV

### 7.2.1.2 Detailed Design Procedure

The transfer function of the circuit in [Figure 7-1](#) is given in [Equation 1](#).

$$V_{OUT} = I_{LOAD} \times R_{SHUNT} \times Gain \quad (1)$$

The load current ( $I_{LOAD}$ ) produces a voltage drop across the shunt resistor ( $R_{SHUNT}$ ). The load current is set from 0 A to 1 A. To keep the shunt voltage below 100 mV at maximum load current, the largest shunt resistor is shown using [Equation 2](#).

$$R_{SHUNT} = \frac{V_{SHUNT\_MAX}}{I_{LOAD\_MAX}} = \frac{100\text{ mV}}{1\text{ A}} = 100\text{ m}\Omega \quad (2)$$

Using [Equation 2](#),  $R_{SHUNT}$  is calculated to be 100 m $\Omega$ . The voltage drop produced by  $I_{LOAD}$  and  $R_{SHUNT}$  is amplified by the LMV3xxA to produce an output voltage of approximately 0 V to 4.9 V. The gain needed by the LMV3xxA to produce the necessary output voltage is calculated using [Equation 3](#).

$$Gain = \frac{(V_{OUT\_MAX} - V_{OUT\_MIN})}{(V_{IN\_MAX} - V_{IN\_MIN})} \quad (3)$$

Using [Equation 3](#), the required gain is calculated to be 49 V/V, which is set with resistors  $R_F$  and  $R_G$ . [Equation 4](#) sizes the resistors  $R_F$  and  $R_G$ , to set the gain of the LMV3xxA to 49 V/V.

$$Gain = 1 + \frac{(R_F)}{(R_G)} \quad (4)$$

Selecting  $R_F$  as 57.6 k $\Omega$  and  $R_G$  as 1.2 k $\Omega$  provides a combination that equals 49 V/V. [Figure 7-2](#) shows the measured transfer function of the circuit shown in [Figure 7-1](#). Notice that the gain is only a function of the feedback and gain resistors. This gain is adjusted by varying the ratio of the resistors and the actual resistors values are determined by the impedance levels that the designer wants to establish. The impedance level determines the current drain, the effect that stray capacitance has, and a few other behaviors. There is no optimal impedance selection that works for every system, you must choose an impedance that is ideal for your system parameters.

### 7.2.1.3 Application Curve

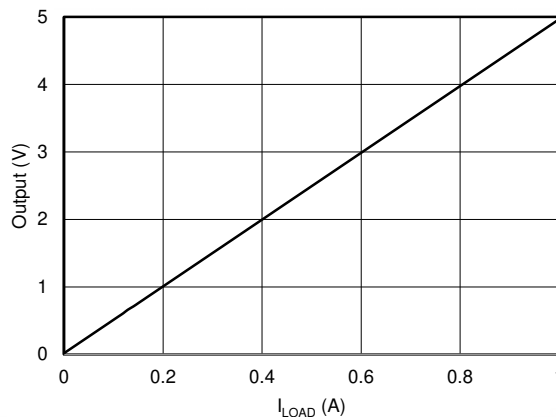

**Figure 7-2. Low-Side, Current-Sense Transfer Function**

### 7.2.2 Single-Supply Photodiode Amplifier

Photodiodes are used in many applications to convert light signals to electrical signals. The current through the photodiode is proportional to the photon energy absorbed, and is commonly in the range of a few hundred picoamps to a few tens of microamps. An amplifier in a transimpedance configuration is typically used to convert the low-level photodiode current to a voltage signal for processing in an MCU. The circuit shown in Figure 7-3 is an example of a single-supply photodiode amplifier circuit using the LMV358A.



Figure 7-3. Single-Supply Photodiode Amplifier Circuit

### 7.2.2.1 Design Requirements

The design requirements for this design are:

- Supply voltage: 3.3 V
- Input: 0  $\mu$ A to 10  $\mu$ A
- Output: 0.1 V to 3.2 V
- Bandwidth: 50 kHz

### 7.2.2.2 Detailed Design Procedure

The transfer function between the output voltage ( $V_{OUT}$ ), the input current, ( $I_{IN}$ ) and the reference voltage ( $V_{REF}$ ) is defined in [Equation 5](#).

$$V_{OUT} = I_{IN} \times R_F + V_{REF} \quad (5)$$

Where:

$$V_{REF} = V_+ \times \left( \frac{R_1 \times R_2}{R_1 + R_2} \right) \quad (6)$$

Set  $V_{REF}$  to 100 mV to meet the minimum output voltage level by setting R1 and R2 to meet the required ratio calculated in [Equation 7](#).

$$\frac{V_{REF}}{V_+} = \frac{0.1 V}{3.3 V} = 0.0303 \quad (7)$$

The closest resistor ratio to meet this ratio sets R1 to 11.5 k $\Omega$  and R2 to 357  $\Omega$ .

The required feedback resistance can be calculated based on the input current and desired output voltage.

$$R_F = \frac{V_{OUT} - V_{REF}}{I_{IN}} = \frac{3.2 V - 0.1 V}{10 \mu A} = 310 \frac{kV}{A} \approx 309 k\Omega \quad (8)$$

Calculate the value for the feedback capacitor based on  $R_F$  and the desired  $-3$ -dB bandwidth, ( $f_{-3dB}$ ) using [Equation 9](#).

$$C_F = \frac{1}{2 \times \pi \times R_F \times f_{-3 dB}} = \frac{1}{2 \times \pi \times 309 k\Omega \times 50 kHz} = 10.3 pF \approx 10 pF \quad (9)$$

The minimum op amp bandwidth required for this application is based on the value of  $R_F$ ,  $C_F$ , and the capacitance on the INx– pin of the LMV358A which is equal to the sum of the photodiode shunt capacitance, (CPD) the common-mode input capacitance, (CCM) and the differential input capacitance (CD) as [Equation 10](#) shows.

$$C_{IN} = C_{PD} + C_{CM} + C_D = 47 pF + 5 pF + 1 pF = 53 pF \quad (10)$$

The minimum op amp bandwidth is calculated in [Equation 11](#).

$$f = BGW \geq \frac{C_{IN} + C_F}{2 \times \pi \times R_F \times C_F^2} \geq 324 kHz \quad (11)$$

The 1-MHz bandwidth of the LMV3xxA meets the minimum bandwidth requirement and remains stable in this application configuration.

### 7.2.2.3 Application Curves

The measured current-to-voltage transfer function for the photodiode amplifier circuit is shown in Figure 7-4. The measured performance of the photodiode amplifier circuit is shown in Figure 7-5.



**Figure 7-4. Photodiode Amplifier Circuit AC Gain Results**



**Figure 7-5. Photodiode Amplifier Circuit DC Results**

## 7.3 Power Supply Recommendations

The LMV3xxA family is specified for operation from 2.5 V to 5.5 V ( $\pm 1.25$  V to  $\pm 2.75$  V); many specifications apply from  $-40^{\circ}\text{C}$  to  $125^{\circ}\text{C}$ . Section 5.8 presents parameters that may exhibit significant variance with regard to operating voltage or temperature.

### CAUTION

Supply voltages larger than 6 V may permanently damage the device; see Section 5.1.

Place 0.1- $\mu\text{F}$  bypass capacitors close to the power-supply pins to reduce coupling errors from noisy or high-impedance power supplies. For more detailed information on bypass capacitor placement, see Section 7.4.1.

### 7.3.1 Input and ESD Protection

The LMV3xxA family incorporates internal ESD protection circuits on all pins. For input and output pins, this protection primarily consists of current-steering diodes connected between the input and power-supply pins. These ESD protection diodes provide in-circuit, input overdrive protection, as long as the current is limited to 10 mA. Figure 7-6 shows how a series input resistor can be added to the driven input to limit the input current. The added resistor contributes thermal noise at the amplifier input and the value must be kept to a minimum in noise-sensitive applications.

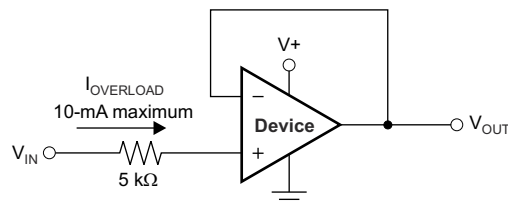

**Figure 7-6. Input Current Protection**

## 7.4 Layout

### 7.4.1 Layout Guidelines

For best operational performance of the device, use good printed circuit board (PCB) layout practices, including:

- Noise can propagate into analog circuitry through the power connections of the board and propagate to the power pins of the op amp itself. Bypass capacitors are used to reduce the coupled noise by providing a low-impedance path to ground.
  - Connect low-ESR, 0.1- $\mu\text{F}$  ceramic bypass capacitors between each supply pin and ground, placed as close to the device as possible. A single bypass capacitor from  $V_+$  to ground is adequate for single-supply applications.
- Separate grounding for analog and digital portions of circuitry is one of the simplest and most effective methods of noise suppression. One or more layers on multilayer PCBs are usually devoted to ground planes. A ground plane helps distribute heat and reduces electromagnetic interference (EMI) noise pickup. Take care to physically separate digital and analog grounds, paying attention to the flow of the ground current.
- To reduce parasitic coupling, run the input traces as far away from the supply or output traces as possible. If these traces cannot be kept separate, crossing the sensitive trace at a 90 degree angle is much better as opposed to running the traces in parallel with the noisy trace.
- Place the external components as close to the device as possible, as shown in Figure 7-8. Keeping  $R_F$  and  $R_G$  close to the inverting input minimizes parasitic capacitance.
- Keep the length of input traces as short as possible. Remember that the input traces are the most sensitive part of the circuit.
- Consider a driven, low-impedance guard ring around the critical traces. A guard ring may significantly reduce leakage currents from nearby traces that are at different potentials.
- Cleaning the PCB following board assembly is recommended for best performance.
- Any precision integrated circuit can experience performance shifts resulting from moisture ingress into the plastic package. Following any aqueous PCB cleaning process, baking the PCB assembly is recommended to remove moisture introduced into the device packaging during the cleaning process. A low-temperature, post-cleaning bake at 85°C for 30 minutes is sufficient for most circumstances.

### 7.4.2 Layout Example



**Figure 7-7. Schematic Representation**

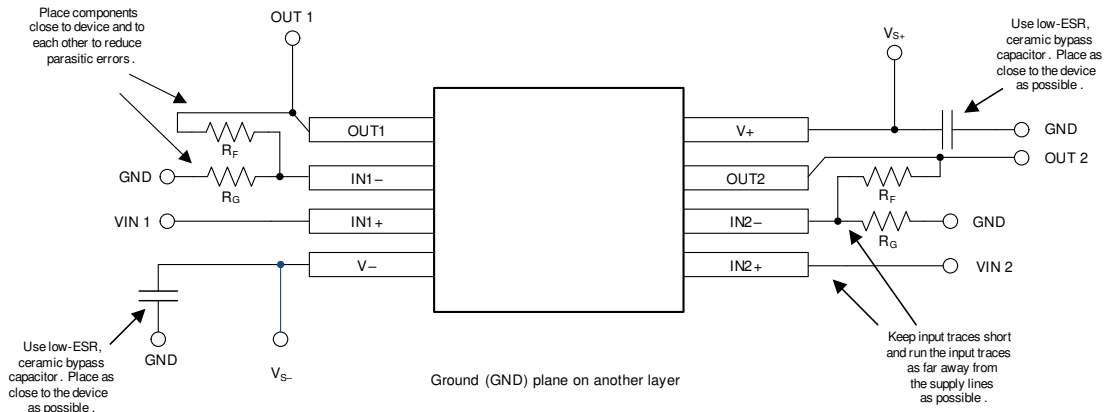

**Figure 7-8. Layout Example**

## 8 Device and Documentation Support

### 8.1 Documentation Support

#### 8.1.1 Related Documentation

For related documentation, see the following:

- Texas Instruments, [EMI Rejection Ratio of Operational Amplifiers application note](#)

### 8.2 Receiving Notification of Documentation Updates

To receive notification of documentation updates, navigate to the device product folder on [ti.com](#). Click on *Notifications* to register and receive a weekly digest of any product information that has changed. For change details, review the revision history included in any revised document.

### 8.3 Support Resources

TI E2E™ support forums are an engineer's go-to source for fast, verified answers and design help — straight from the experts. Search existing answers or ask your own question to get the quick design help you need.

Linked content is provided "AS IS" by the respective contributors. They do not constitute TI specifications and do not necessarily reflect TI's views; see TI's [Terms of Use](#).

### 8.4 Trademarks

TI E2E™ is a trademark of Texas Instruments.  
All trademarks are the property of their respective owners.

### 8.5 Electrostatic Discharge Caution



This integrated circuit can be damaged by ESD. Texas Instruments recommends that all integrated circuits be handled with appropriate precautions. Failure to observe proper handling and installation procedures can cause damage.

ESD damage can range from subtle performance degradation to complete device failure. Precision integrated circuits may be more susceptible to damage because very small parametric changes could cause the device not to meet its published specifications.

### 8.6 Glossary

[TI Glossary](#) This glossary lists and explains terms, acronyms, and definitions.

## 9 Revision History

NOTE: Page numbers for previous revisions may differ from page numbers in the current version.

Changes from Revision H (April 2023) to Revision I (July 2024)	Page
• Changed the <i>Device Information</i> table to <i>Package Information</i> .....	1
• Added LMV321A and LMV321AU variant names to the DBV pinouts in <i>Pin Configuration and Functions</i> .....	3
• Changed <i>Electrical Characteristics</i> table description from: $V_S = (V+) - (V-) = 2.5\text{ V to }5.5\text{ V } (\pm 0.9\text{ V to } \pm 2.75\text{ V})$ , $T_A = 25^\circ\text{C}$ , $R_L = 10\text{ k}\Omega$ connected to $V_S / 2$ , and $V_{CM} = V_{OUT} = V_S / 2$ (unless otherwise noted) to: $V_S = (V+) - (V-) = 2.5\text{ V to }5.5\text{ V } (\pm 1.25\text{ V to } \pm 2.75\text{ V})$ , $T_A = 25^\circ\text{C}$ , $R_L = 10\text{ k}\Omega$ connected to $V_S / 2$ , and $V_{CM} = V_{OUT} = V_S / 2$ (unless otherwise noted).....	7

---

Changes from Revision G (February 2022) to Revision H (April 2023)	Page
• Updated test condition of <i>Electrical Characteristics</i> table from " $V_S = (V+) - (V-) = 2.5\text{ V to }5.5\text{ V } (\pm 0.9\text{ V to } \pm 2.75\text{ V})$ " to " $V_S = (V+) - (V-) = 2.5\text{ V to }5.5\text{ V } (\pm 1.25\text{ V to } \pm 2.75\text{ V})$ ".....	7
• Updated <i>Typical Characteristics</i> section.....	8

---

<b>Changes from Revision F (January 2020) to Revision G (February 2022)</b>	<b>Page</b>
• Updated the numbering format for tables, figures, and cross-references throughout the document. ....	1
• Added SOT-23 (DYY) package to <i>Description</i> section.....	1
• Added SOT-23 (DYY) package information to <i>Pin Configuration and Functions</i> section.....	3
• Added SOT-23 (DYY) package to <i>Thermal Information: LMV324A</i> .....	6

---

<b>Changes from Revision E (September 2019) to Revision F (January 2020)</b>	<b>Page</b>
• Added SOT-23 (U) package information to <i>Pin Configuration and Functions</i> section.....	3

---

## 10 Mechanical, Packaging, and Orderable Information

The following pages include mechanical, packaging, and orderable information. This information is the most-current data available for the designated devices. This data is subject to change without notice and without revision of this document. For browser-based versions of this data sheet, see the left-hand navigation pane.

**PACKAGING INFORMATION**

Orderable part number	Status (1)	Material type (2)	Package   Pins	Package qty   Carrier	RoHS (3)	Lead finish/ Ball material (4)	MSL rating/ Peak reflow (5)	Op temp (°C)	Part marking (6)
<a href="#">LMV321AIDBVR</a>	Active	Production	SOT-23 (DBV)   5	3000   LARGE T&R	Yes	NIPDAU   SN	Level-1-260C-UNLIM	-40 to 125	1OIF
LMV321AIDBVR.A	Active	Production	SOT-23 (DBV)   5	3000   LARGE T&R	Yes	SN	Level-1-260C-UNLIM	-40 to 125	1OIF
LMV321AIDBVRG4	Active	Production	SOT-23 (DBV)   5	3000   LARGE T&R	Yes	NIPDAU	Level-1-260C-UNLIM	-40 to 125	1OIF
LMV321AIDBVRG4.A	Active	Production	SOT-23 (DBV)   5	3000   LARGE T&R	Yes	NIPDAU	Level-1-260C-UNLIM	-40 to 125	1OIF
<a href="#">LMV321AIDCKR</a>	Active	Production	SC70 (DCK)   5	3000   LARGE T&R	Yes	SN	Level-2-260C-1 YEAR	-40 to 125	1C2
LMV321AIDCKR.A	Active	Production	SC70 (DCK)   5	3000   LARGE T&R	Yes	SN	Level-2-260C-1 YEAR	-40 to 125	1C2
<a href="#">LMV321AUIDBVR</a>	Active	Production	SOT-23 (DBV)   5	3000   LARGE T&R	Yes	NIPDAU   SN	Level-1-260C-UNLIM	-40 to 125	1WOF
LMV321AUIDBVR.A	Active	Production	SOT-23 (DBV)   5	3000   LARGE T&R	Yes	NIPDAU	Level-1-260C-UNLIM	-40 to 125	1WOF
LMV321AUIDBVRG4	Active	Production	SOT-23 (DBV)   5	3000   LARGE T&R	Yes	NIPDAU	Level-1-260C-UNLIM	-40 to 125	1WOF
LMV321AUIDBVRG4.A	Active	Production	SOT-23 (DBV)   5	3000   LARGE T&R	Yes	NIPDAU	Level-1-260C-UNLIM	-40 to 125	1WOF
<a href="#">LMV324AIDR</a>	Active	Production	SOIC (D)   14	2500   LARGE T&R	Yes	NIPDAU	Level-2-260C-1 YEAR	-40 to 125	LMV324
LMV324AIDR.A	Active	Production	SOIC (D)   14	2500   LARGE T&R	Yes	NIPDAU	Level-2-260C-1 YEAR	-40 to 125	LMV324
<a href="#">LMV324AIDYYR</a>	Active	Production	SOT-23-THIN (DYY)   14	3000   LARGE T&R	Yes	NIPDAU	Level-1-260C-UNLIM	-40 to 125	LM324I
LMV324AIDYYR.A	Active	Production	SOT-23-THIN (DYY)   14	3000   LARGE T&R	Yes	NIPDAU	Level-1-260C-UNLIM	-40 to 125	LM324I
<a href="#">LMV324AIPWR</a>	Active	Production	TSSOP (PW)   14	2000   LARGE T&R	Yes	NIPDAU   SN	Level-2-260C-1 YEAR	-40 to 125	LMV324A
LMV324AIPWR.A	Active	Production	TSSOP (PW)   14	2000   LARGE T&R	Yes	SN	Level-2-260C-1 YEAR	-40 to 125	LMV324A
<a href="#">LMV358AIDDFR</a>	Active	Production	SOT-23-THIN (DDF)   8	3000   LARGE T&R	Yes	NIPDAU	Level-1-260C-UNLIM	-40 to 125	358A
LMV358AIDDFR.A	Active	Production	SOT-23-THIN (DDF)   8	3000   LARGE T&R	Yes	NIPDAU	Level-1-260C-UNLIM	-40 to 125	358A
LMV358AIDDFRG4	Active	Production	SOT-23-THIN (DDF)   8	3000   LARGE T&R	Yes	NIPDAU	Level-1-260C-UNLIM	-40 to 125	358A
LMV358AIDDFRG4.A	Active	Production	SOT-23-THIN (DDF)   8	3000   LARGE T&R	Yes	NIPDAU	Level-1-260C-UNLIM	-40 to 125	358A
<a href="#">LMV358AIDGKR</a>	Active	Production	VSSOP (DGK)   8	2500   LARGE T&R	Yes	NIPDAU   SN   NIPDAUAG	Level-2-260C-1 YEAR	-40 to 125	1MAX
LMV358AIDGKR.A	Active	Production	VSSOP (DGK)   8	2500   LARGE T&R	Yes	NIPDAU	Level-2-260C-1 YEAR	-40 to 125	1MAX
LMV358AIDGKRG4	Active	Production	VSSOP (DGK)   8	2500   LARGE T&R	Yes	NIPDAU	Level-2-260C-1 YEAR	-40 to 125	1MAX
LMV358AIDGKRG4.A	Active	Production	VSSOP (DGK)   8	2500   LARGE T&R	Yes	NIPDAU	Level-2-260C-1 YEAR	-40 to 125	1MAX
<a href="#">LMV358AIDGKT</a>	Active	Production	VSSOP (DGK)   8	250   SMALL T&R	Yes	NIPDAU   SN   NIPDAUAG	Level-2-260C-1 YEAR	-40 to 125	1MAX
LMV358AIDGKT.A	Active	Production	VSSOP (DGK)   8	250   SMALL T&R	Yes	NIPDAU	Level-2-260C-1 YEAR	-40 to 125	1MAX

Orderable part number	Status (1)	Material type (2)	Package   Pins	Package qty   Carrier	RoHS (3)	Lead finish/ Ball material (4)	MSL rating/ Peak reflow (5)	Op temp (°C)	Part marking (6)
<a href="#">LMV358AIDR</a>	Active	Production	SOIC (D)   8	2500   LARGE T&R	Yes	NIPDAU   SN	Level-2-260C-1 YEAR	-40 to 125	MV358A
LMV358AIDR.A	Active	Production	SOIC (D)   8	2500   LARGE T&R	Yes	SN	Level-2-260C-1 YEAR	-40 to 125	MV358A
<a href="#">LMV358AIPWR</a>	Active	Production	TSSOP (PW)   8	2000   LARGE T&R	Yes	NIPDAU   SN	Level-2-260C-1 YEAR	-40 to 125	LMV358
LMV358AIPWR.A	Active	Production	TSSOP (PW)   8	2000   LARGE T&R	Yes	SN	Level-2-260C-1 YEAR	-40 to 125	LMV358

(1) **Status:** For more details on status, see our [product life cycle](#).

(2) **Material type:** When designated, preproduction parts are prototypes/experimental devices, and are not yet approved or released for full production. Testing and final process, including without limitation quality assurance, reliability performance testing, and/or process qualification, may not yet be complete, and this item is subject to further changes or possible discontinuation. If available for ordering, purchases will be subject to an additional waiver at checkout, and are intended for early internal evaluation purposes only. These items are sold without warranties of any kind.

(3) **RoHS values:** Yes, No, RoHS Exempt. See the [TI RoHS Statement](#) for additional information and value definition.

(4) **Lead finish/Ball material:** Parts may have multiple material finish options. Finish options are separated by a vertical ruled line. Lead finish/Ball material values may wrap to two lines if the finish value exceeds the maximum column width.

(5) **MSL rating/Peak reflow:** The moisture sensitivity level ratings and peak solder (reflow) temperatures. In the event that a part has multiple moisture sensitivity ratings, only the lowest level per JEDEC standards is shown. Refer to the shipping label for the actual reflow temperature that will be used to mount the part to the printed circuit board.

(6) **Part marking:** There may be an additional marking, which relates to the logo, the lot trace code information, or the environmental category of the part.

Multiple part markings will be inside parentheses. Only one part marking contained in parentheses and separated by a "-" will appear on a part. If a line is indented then it is a continuation of the previous line and the two combined represent the entire part marking for that device.

**Important Information and Disclaimer:**The information provided on this page represents TI's knowledge and belief as of the date that it is provided. TI bases its knowledge and belief on information provided by third parties, and makes no representation or warranty as to the accuracy of such information. Efforts are underway to better integrate information from third parties. TI has taken and continues to take reasonable steps to provide representative and accurate information but may not have conducted destructive testing or chemical analysis on incoming materials and chemicals. TI and TI suppliers consider certain information to be proprietary, and thus CAS numbers and other limited information may not be available for release.

In no event shall TI's liability arising out of such information exceed the total purchase price of the TI part(s) at issue in this document sold by TI to Customer on an annual basis.

**OTHER QUALIFIED VERSIONS OF LMV321A, LMV324A, LMV358A :**

- Automotive : [LMV321A-Q1](#), [LMV324A-Q1](#), [LMV358A-Q1](#)

**NOTE: Qualified Version Definitions:**

- Automotive - Q100 devices qualified for high-reliability automotive applications targeting zero defects

**TAPE AND REEL INFORMATION**

**QUADRANT ASSIGNMENTS FOR PIN 1 ORIENTATION IN TAPE**

\*All dimensions are nominal

Device	Package Type	Package Drawing	Pins	SPQ	Reel Diameter (mm)	Reel Width W1 (mm)	A0 (mm)	B0 (mm)	K0 (mm)	P1 (mm)	W (mm)	Pin1 Quadrant
LMV321AIDBVR	SOT-23	DBV	5	3000	178.0	8.4	3.2	3.2	1.4	4.0	8.0	Q3
LMV321AIDBVRG4	SOT-23	DBV	5	3000	180.0	8.4	3.2	3.2	1.4	4.0	8.0	Q3
LMV321AIDCKR	SC70	DCK	5	3000	178.0	8.4	2.25	2.45	1.2	4.0	8.0	Q3
LMV321AUIDBVR	SOT-23	DBV	5	3000	178.0	8.4	3.2	3.2	1.4	4.0	8.0	Q3
LMV321AUIDBVRG4	SOT-23	DBV	5	3000	180.0	8.4	3.2	3.2	1.4	4.0	8.0	Q3
LMV321AUIDBVRG4	SOT-23	DBV	5	3000	180.0	8.4	3.2	3.2	1.4	4.0	8.0	Q3
LMV324AIDR	SOIC	D	14	2500	330.0	16.4	6.5	9.0	2.1	8.0	16.0	Q1
LMV324AIDR	SOIC	D	14	2500	330.0	16.4	6.5	9.0	2.1	8.0	16.0	Q1
LMV324AIDYYR	SOT-23-THIN	DYY	14	3000	330.0	12.4	4.8	3.6	1.6	8.0	12.0	Q3
LMV324AIPWR	TSSOP	PW	14	2000	330.0	12.4	6.9	5.6	1.6	8.0	12.0	Q1
LMV358AIDDFR	SOT-23-THIN	DDF	8	3000	180.0	8.4	3.2	3.2	1.4	4.0	8.0	Q3
LMV358AIDDFRG4	SOT-23-THIN	DDF	8	3000	180.0	8.4	3.2	3.2	1.4	4.0	8.0	Q3
LMV358AIDGKR	VSSOP	DGK	8	2500	330.0	12.4	5.3	3.4	1.4	8.0	12.0	Q1
LMV358AIDGKRG4	VSSOP	DGK	8	2500	330.0	12.4	5.3	3.4	1.4	8.0	12.0	Q1

Device	Package Type	Package Drawing	Pins	SPQ	Reel Diameter (mm)	Reel Width W1 (mm)	A0 (mm)	B0 (mm)	K0 (mm)	P1 (mm)	W (mm)	Pin1 Quadrant
LMV358AIDGKT	VSSOP	DGK	8	250	330.0	12.4	5.3	3.4	1.4	8.0	12.0	Q1
LMV358AIDR	SOIC	D	8	2500	330.0	12.4	6.4	5.2	2.1	8.0	12.0	Q1
LMV358AIPWR	TSSOP	PW	8	2000	330.0	12.4	7.0	3.6	1.6	8.0	12.0	Q1

**TAPE AND REEL BOX DIMENSIONS**

\*All dimensions are nominal

Device	Package Type	Package Drawing	Pins	SPQ	Length (mm)	Width (mm)	Height (mm)
LMV321AIDBVR	SOT-23	DBV	5	3000	208.0	191.0	35.0
LMV321AIDBVRG4	SOT-23	DBV	5	3000	210.0	185.0	35.0
LMV321AIDCKR	SC70	DCK	5	3000	208.0	191.0	35.0
LMV321AUIDBVR	SOT-23	DBV	5	3000	208.0	191.0	35.0
LMV321AUIDBVRG4	SOT-23	DBV	5	3000	210.0	185.0	35.0
LMV321AUIDBVRG4	SOT-23	DBV	5	3000	210.0	185.0	35.0
LMV324AIDR	SOIC	D	14	2500	353.0	353.0	32.0
LMV324AIDR	SOIC	D	14	2500	353.0	353.0	32.0
LMV324AIDYYR	SOT-23-THIN	DYY	14	3000	336.6	336.6	31.8
LMV324AIPWR	TSSOP	PW	14	2000	353.0	353.0	32.0
LMV358AIDDFR	SOT-23-THIN	DDF	8	3000	210.0	185.0	35.0
LMV358AIDDFRG4	SOT-23-THIN	DDF	8	3000	210.0	185.0	35.0
LMV358AIDGKR	VSSOP	DGK	8	2500	356.0	356.0	36.0
LMV358AIDGKRG4	VSSOP	DGK	8	2500	353.0	353.0	32.0
LMV358AIDGKT	VSSOP	DGK	8	250	353.0	353.0	32.0
LMV358AIDR	SOIC	D	8	2500	353.0	353.0	32.0
LMV358AIPWR	TSSOP	PW	8	2000	353.0	353.0	32.0



# EXAMPLE BOARD LAYOUT

DBV0005A

SOT-23 - 1.45 mm max height

SMALL OUTLINE TRANSISTOR



LAND PATTERN EXAMPLE  
EXPOSED METAL SHOWN  
SCALE:15X



SOLDER MASK DETAILS

4214839/K 08/2024

NOTES: (continued)

- 6. Publication IPC-7351 may have alternate designs.
- 7. Solder mask tolerances between and around signal pads can vary based on board fabrication site.

# EXAMPLE STENCIL DESIGN

DBV0005A

SOT-23 - 1.45 mm max height

SMALL OUTLINE TRANSISTOR



SOLDER PASTE EXAMPLE  
BASED ON 0.125 mm THICK STENCIL  
SCALE:15X

4214839/K 08/2024

NOTES: (continued)

8. Laser cutting apertures with trapezoidal walls and rounded corners may offer better paste release. IPC-7525 may have alternate design recommendations.
9. Board assembly site may have different recommendations for stencil design.

DGK0008A



PACKAGE OUTLINE  
VSSOP - 1.1 mm max height

SMALL OUTLINE PACKAGE

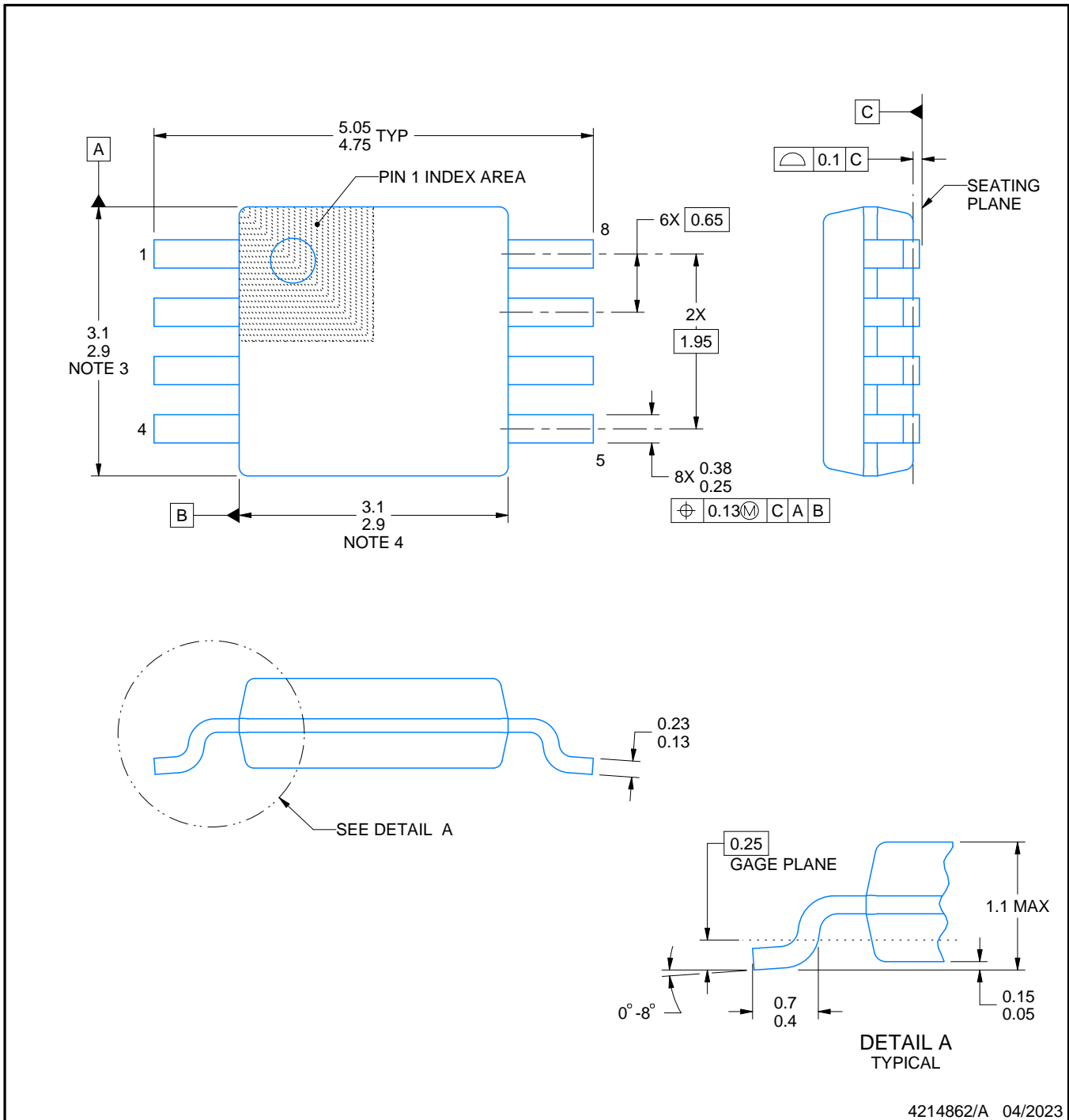

4214862/A 04/2023

NOTES:

PowerPAD is a trademark of Texas Instruments.

1. All linear dimensions are in millimeters. Any dimensions in parenthesis are for reference only. Dimensioning and tolerancing per ASME Y14.5M.
2. This drawing is subject to change without notice.
3. This dimension does not include mold flash, protrusions, or gate burrs. Mold flash, protrusions, or gate burrs shall not exceed 0.15 mm per side.
4. This dimension does not include interlead flash. Interlead flash shall not exceed 0.25 mm per side.
5. Reference JEDEC registration MO-187.

# EXAMPLE BOARD LAYOUT

DGK0008A

™ VSSOP - 1.1 mm max height

SMALL OUTLINE PACKAGE



LAND PATTERN EXAMPLE  
EXPOSED METAL SHOWN  
SCALE: 15X



SOLDER MASK DETAILS

4214862/A 04/2023

NOTES: (continued)

6. Publication IPC-7351 may have alternate designs.
7. Solder mask tolerances between and around signal pads can vary based on board fabrication site.
8. Vias are optional depending on application, refer to device data sheet. If any vias are implemented, refer to their locations shown on this view. It is recommended that vias under paste be filled, plugged or tented.
9. Size of metal pad may vary due to creepage requirement.

# EXAMPLE STENCIL DESIGN

DGK0008A

™ VSSOP - 1.1 mm max height

SMALL OUTLINE PACKAGE



SOLDER PASTE EXAMPLE  
SCALE: 15X

4214862/A 04/2023

NOTES: (continued)

11. Laser cutting apertures with trapezoidal walls and rounded corners may offer better paste release. IPC-7525 may have alternate design recommendations.
12. Board assembly site may have different recommendations for stencil design.

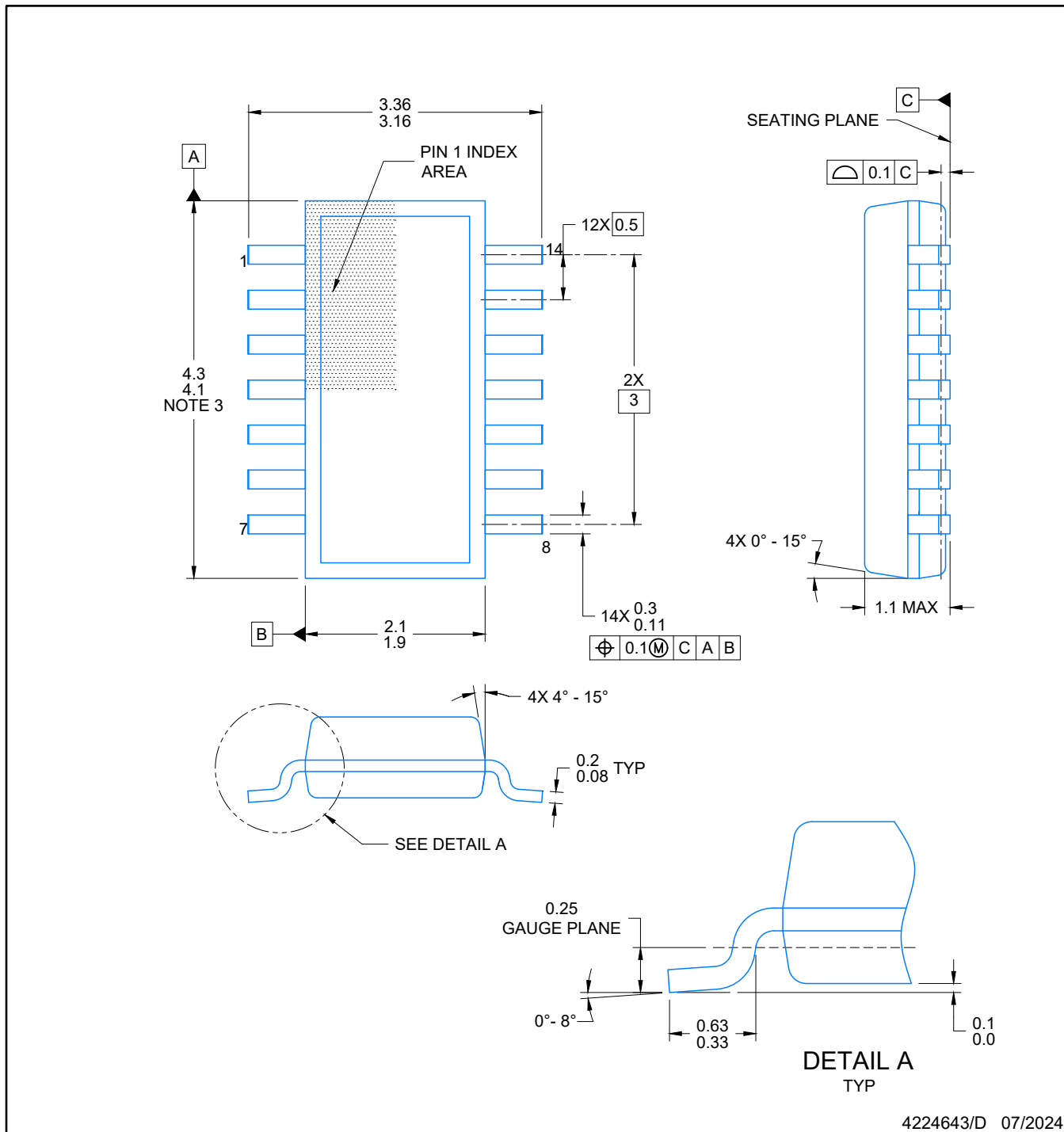

4224643/D 07/2024

NOTES:

1. All linear dimensions are in millimeters. Any dimensions in parenthesis are for reference only. Dimensioning and tolerancing per ASME Y14.5M.
2. This drawing is subject to change without notice.
3. This dimension does not include mold flash, protrusions, or gate burrs. Mold flash, protrusions, or gate burrs shall not exceed 0.15 per side.
4. This dimension does not include interlead flash. Interlead flash shall not exceed 0.50 per side.
5. Reference JEDEC Registration MO-345, Variation AB

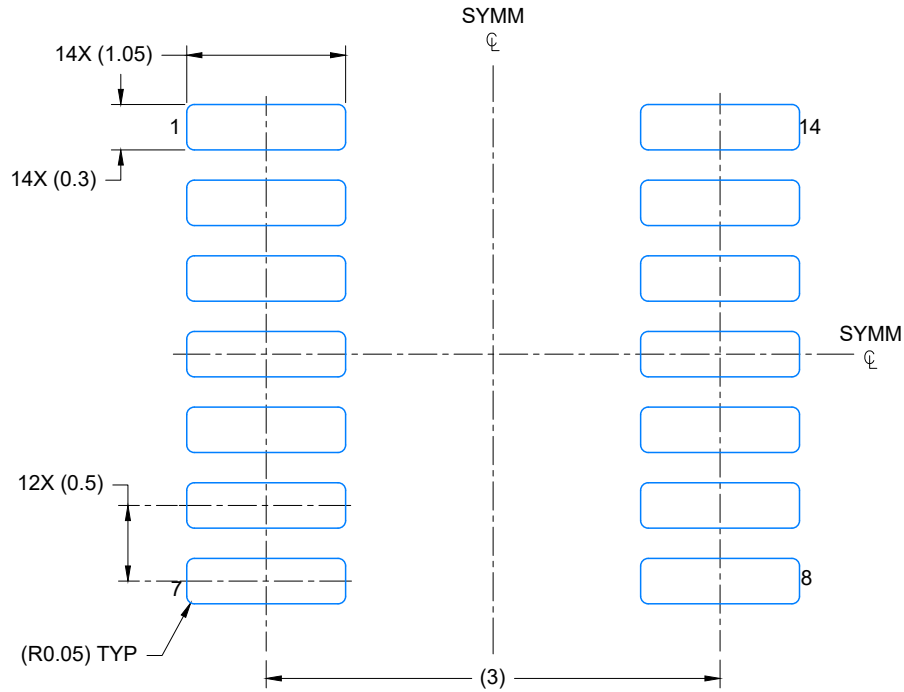

LAND PATTERN EXAMPLE  
EXPOSED METAL SHOWN  
SCALE: 20X

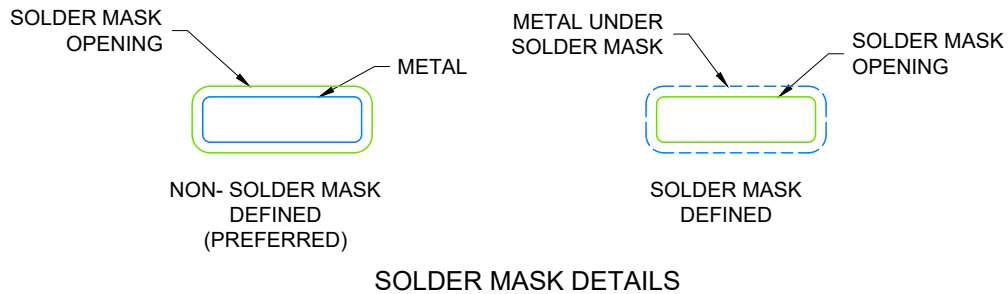

4224643/D 07/2024

NOTES: (continued)

- 6. Publication IPC-7351 may have alternate designs.
- 7. Solder mask tolerances between and around signal pads can vary based on board fabrication site.

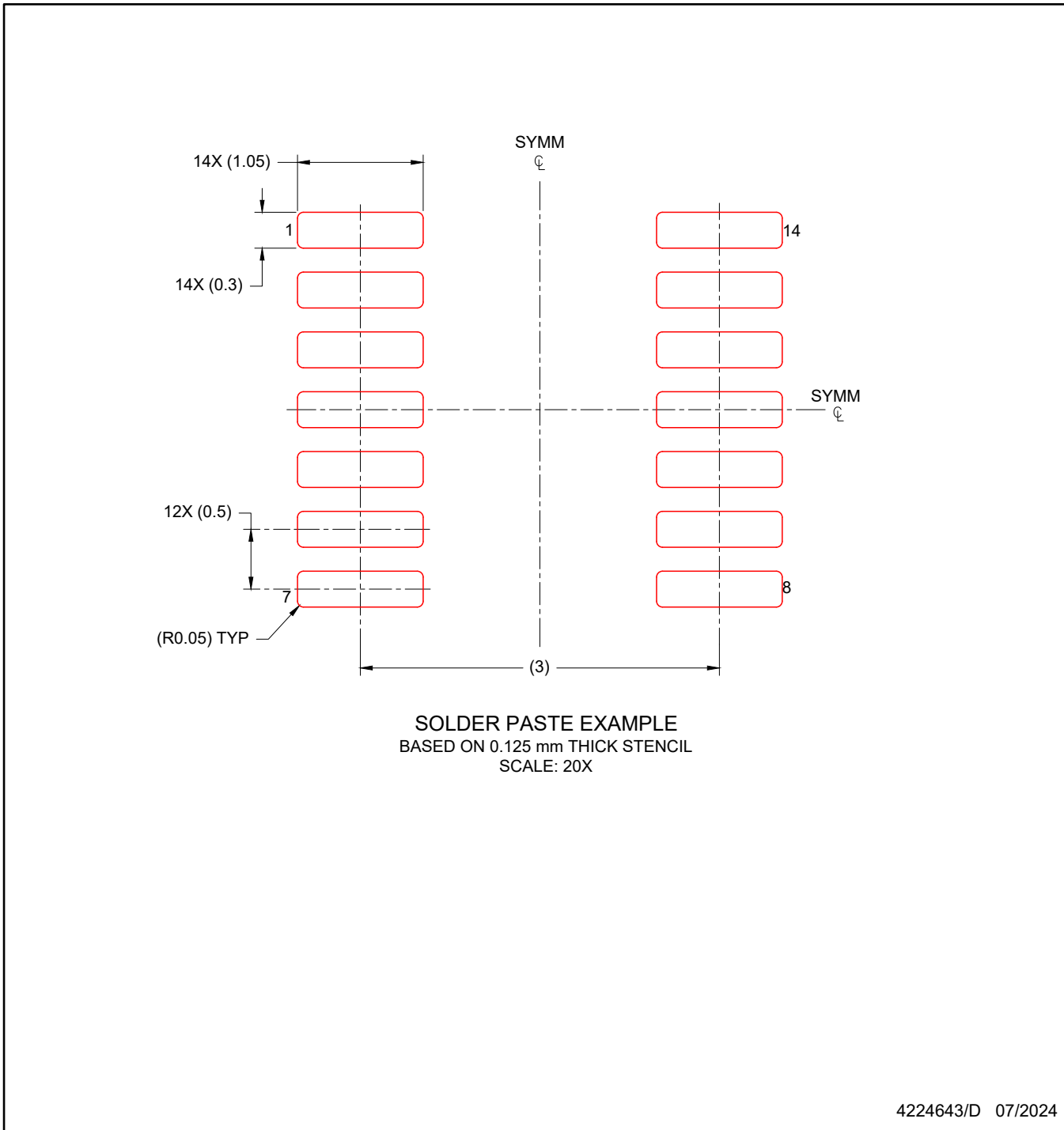

NOTES: (continued)

- 8. Laser cutting apertures with trapezoidal walls and rounded corners may offer better paste release. IPC-7525 may have alternate design recommendations.
- 9. Board assembly site may have different recommendations for stencil design.



# D0014A

# PACKAGE OUTLINE

## SOIC - 1.75 mm max height

SMALL OUTLINE INTEGRATED CIRCUIT



4220718/A 09/2016

### NOTES:

1. All linear dimensions are in millimeters. Dimensions in parenthesis are for reference only. Dimensioning and tolerancing per ASME Y14.5M.
2. This drawing is subject to change without notice.
3. This dimension does not include mold flash, protrusions, or gate burrs. Mold flash, protrusions, or gate burrs shall not exceed 0.15 mm, per side.
4. This dimension does not include interlead flash. Interlead flash shall not exceed 0.43 mm, per side.
5. Reference JEDEC registration MS-012, variation AB.



# EXAMPLE STENCIL DESIGN

D0014A

SOIC - 1.75 mm max height

SMALL OUTLINE INTEGRATED CIRCUIT



SOLDER PASTE EXAMPLE  
BASED ON 0.125 mm THICK STENCIL  
SCALE:8X

4220718/A 09/2016

NOTES: (continued)

8. Laser cutting apertures with trapezoidal walls and rounded corners may offer better paste release. IPC-7525 may have alternate design recommendations.
9. Board assembly site may have different recommendations for stencil design.

# DCK0005A



## PACKAGE OUTLINE

SOT - 1.1 max height

SMALL OUTLINE TRANSISTOR

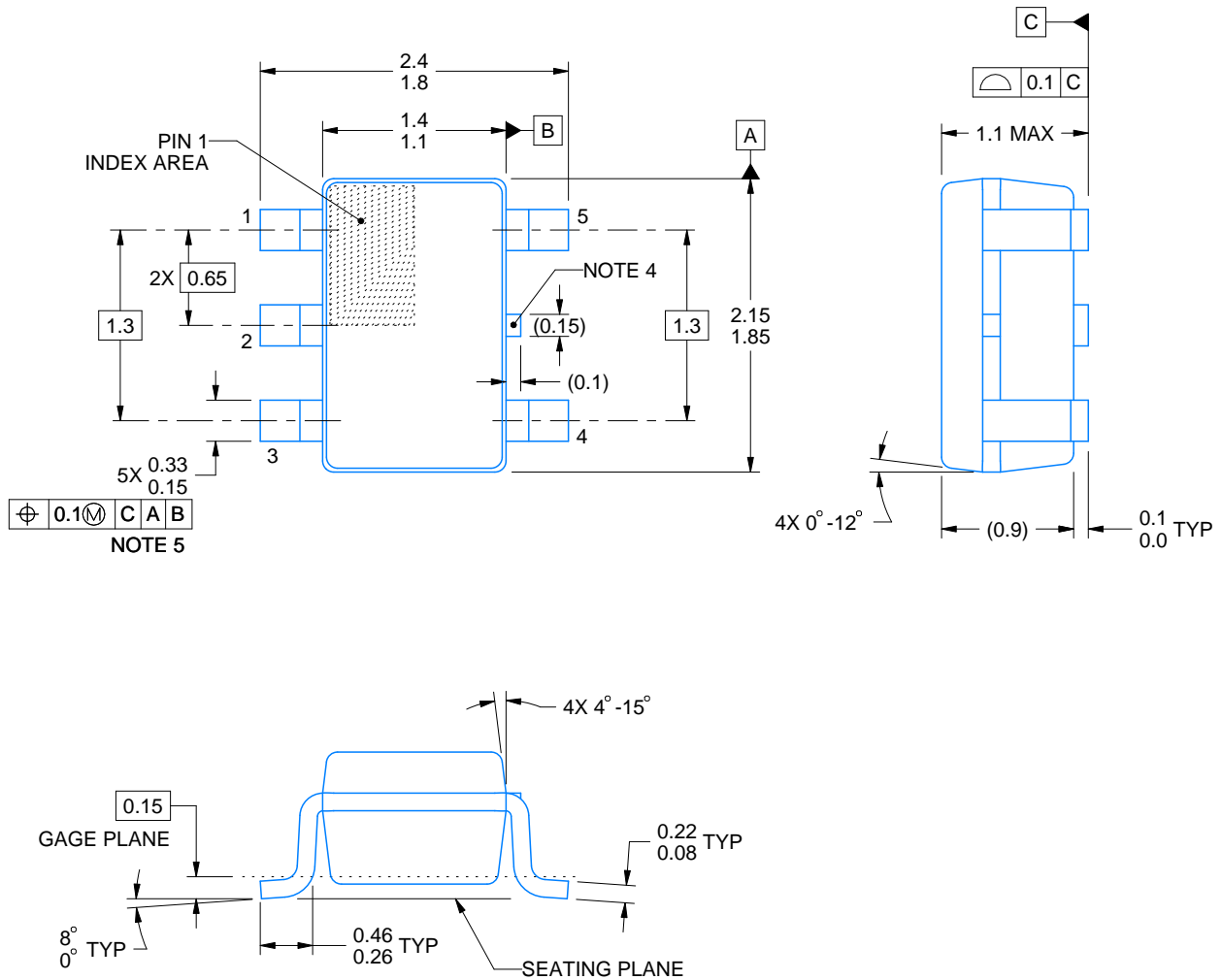

4214834/G 11/2024

### NOTES:

1. All linear dimensions are in millimeters. Any dimensions in parenthesis are for reference only. Dimensioning and tolerancing per ASME Y14.5M.
2. This drawing is subject to change without notice.
3. Reference JEDEC MO-203.
4. Support pin may differ or may not be present.
5. Lead width does not comply with JEDEC.
6. Body dimensions do not include mold flash, protrusions, or gate burrs. Mold flash, protrusions, or gate burrs shall not exceed 0.25mm per side

# EXAMPLE BOARD LAYOUT

DCK0005A

SOT - 1.1 max height

SMALL OUTLINE TRANSISTOR



LAND PATTERN EXAMPLE  
EXPOSED METAL SHOWN  
SCALE:18X



SOLDER MASK DETAILS

4214834/G 11/2024

NOTES: (continued)

- 7. Publication IPC-7351 may have alternate designs.
- 8. Solder mask tolerances between and around signal pads can vary based on board fabrication site.

# EXAMPLE STENCIL DESIGN

DCK0005A

SOT - 1.1 max height

SMALL OUTLINE TRANSISTOR



SOLDER PASTE EXAMPLE  
BASED ON 0.125 THICK STENCIL  
SCALE:18X

4214834/G 11/2024

NOTES: (continued)

9. Laser cutting apertures with trapezoidal walls and rounded corners may offer better paste release. IPC-7525 may have alternate design recommendations.
10. Board assembly site may have different recommendations for stencil design.

# DDF0008A



# PACKAGE OUTLINE

## SOT-23-THIN - 1.1 mm max height

PLASTIC SMALL OUTLINE



4222047/E 07/2024

**NOTES:**

1. All linear dimensions are in millimeters. Any dimensions in parenthesis are for reference only. Dimensioning and tolerancing per ASME Y14.5M.
2. This drawing is subject to change without notice.
3. This dimension does not include mold flash, protrusions, or gate burrs. Mold flash, protrusions, or gate burrs shall not exceed 0.15 mm per side.

# EXAMPLE BOARD LAYOUT

DDF0008A

SOT-23-THIN - 1.1 mm max height

PLASTIC SMALL OUTLINE



LAND PATTERN EXAMPLE  
EXPOSED METAL SHOWN  
SCALE:15X



SOLDER MASK DETAILS

4222047/E 07/2024

NOTES: (continued)

- 4. Publication IPC-7351 may have alternate designs.
- 5. Solder mask tolerances between and around signal pads can vary based on board fabrication site.

# EXAMPLE STENCIL DESIGN

DDF0008A

SOT-23-THIN - 1.1 mm max height

PLASTIC SMALL OUTLINE



SOLDER PASTE EXAMPLE  
BASED ON 0.125 mm THICK STENCIL  
SCALE:15X

4222047/E 07/2024

NOTES: (continued)

6. Laser cutting apertures with trapezoidal walls and rounded corners may offer better paste release. IPC-7525 may have alternate design recommendations.
7. Board assembly site may have different recommendations for stencil design.



D0008A

# PACKAGE OUTLINE

SOIC - 1.75 mm max height

SMALL OUTLINE INTEGRATED CIRCUIT



4214825/C 02/2019

### NOTES:

- Linear dimensions are in inches [millimeters]. Dimensions in parenthesis are for reference only. Controlling dimensions are in inches. Dimensioning and tolerancing per ASME Y14.5M.
- This drawing is subject to change without notice.
- This dimension does not include mold flash, protrusions, or gate burrs. Mold flash, protrusions, or gate burrs shall not exceed .006 [0.15] per side.
- This dimension does not include interlead flash.
- Reference JEDEC registration MS-012, variation AA.

# EXAMPLE BOARD LAYOUT

D0008A

SOIC - 1.75 mm max height

SMALL OUTLINE INTEGRATED CIRCUIT



LAND PATTERN EXAMPLE  
 EXPOSED METAL SHOWN  
 SCALE:8X



SOLDER MASK DETAILS

4214825/C 02/2019

NOTES: (continued)

- 6. Publication IPC-7351 may have alternate designs.
- 7. Solder mask tolerances between and around signal pads can vary based on board fabrication site.

# EXAMPLE STENCIL DESIGN

D0008A

SOIC - 1.75 mm max height

SMALL OUTLINE INTEGRATED CIRCUIT



SOLDER PASTE EXAMPLE  
BASED ON .005 INCH [0.125 MM] THICK STENCIL  
SCALE:8X

4214825/C 02/2019

NOTES: (continued)

8. Laser cutting apertures with trapezoidal walls and rounded corners may offer better paste release. IPC-7525 may have alternate design recommendations.
9. Board assembly site may have different recommendations for stencil design.

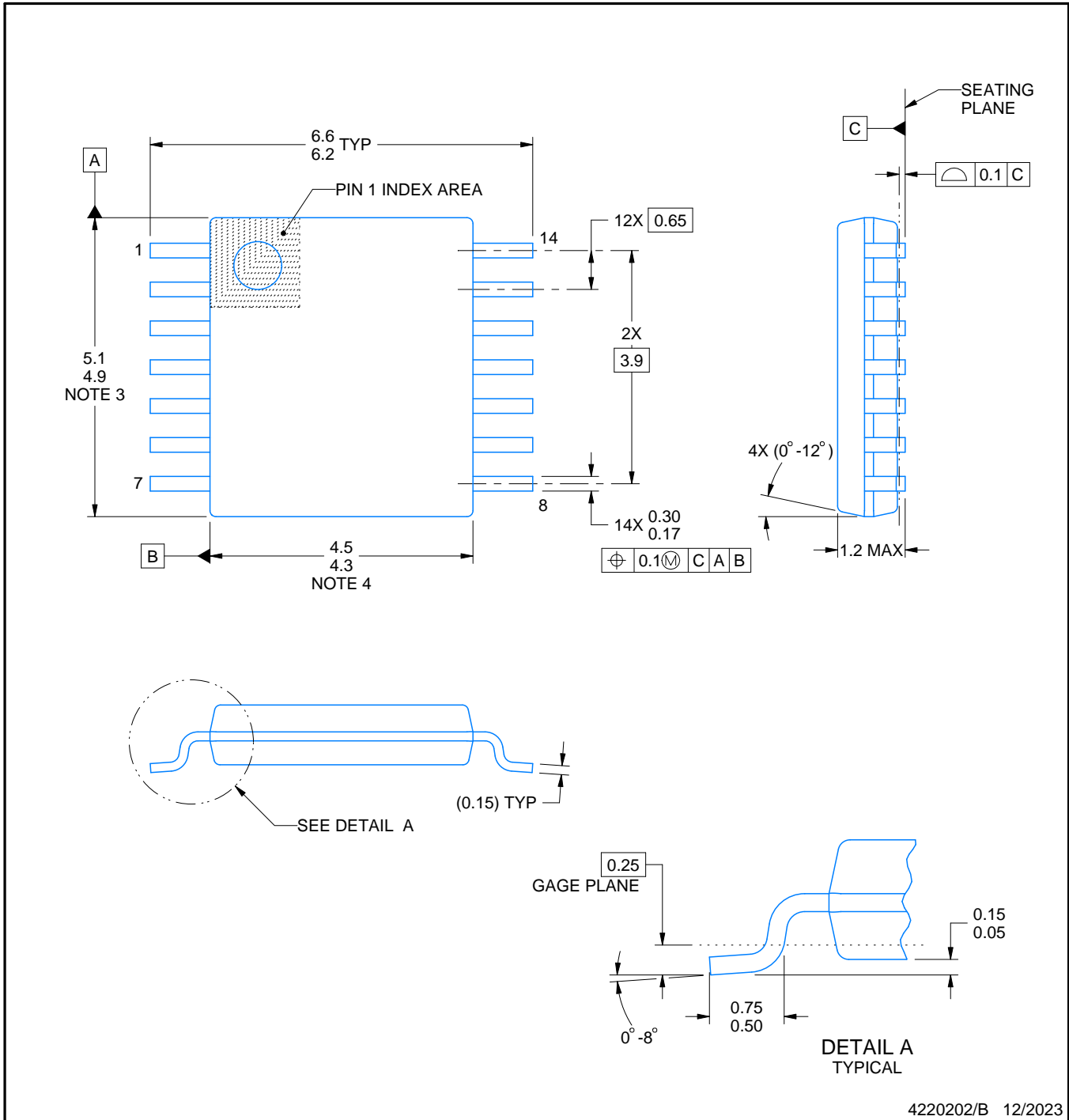
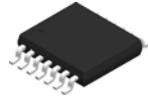

4220202/B 12/2023

**NOTES:**

1. All linear dimensions are in millimeters. Any dimensions in parenthesis are for reference only. Dimensioning and tolerancing per ASME Y14.5M.
2. This drawing is subject to change without notice.
3. This dimension does not include mold flash, protrusions, or gate burrs. Mold flash, protrusions, or gate burrs shall not exceed 0.15 mm per side.
4. This dimension does not include interlead flash. Interlead flash shall not exceed 0.25 mm per side.
5. Reference JEDEC registration MO-153.

# EXAMPLE BOARD LAYOUT

PW0014A

TSSOP - 1.2 mm max height

SMALL OUTLINE PACKAGE

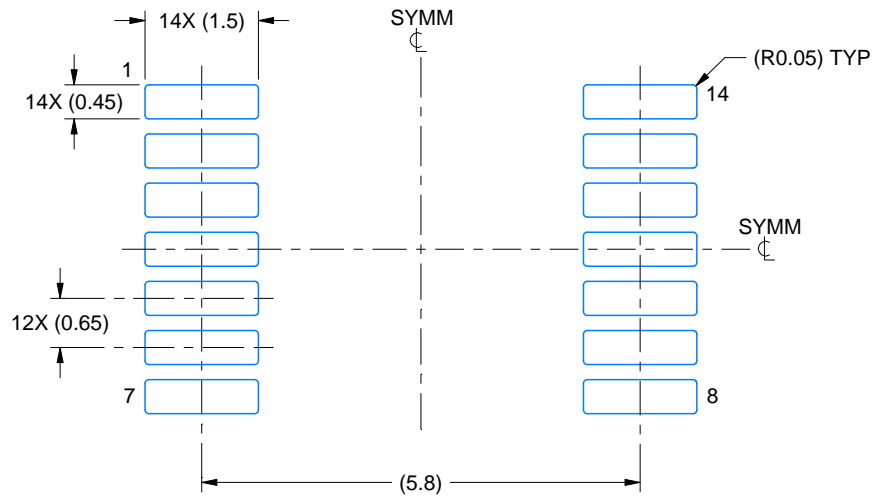

LAND PATTERN EXAMPLE  
EXPOSED METAL SHOWN  
SCALE: 10X

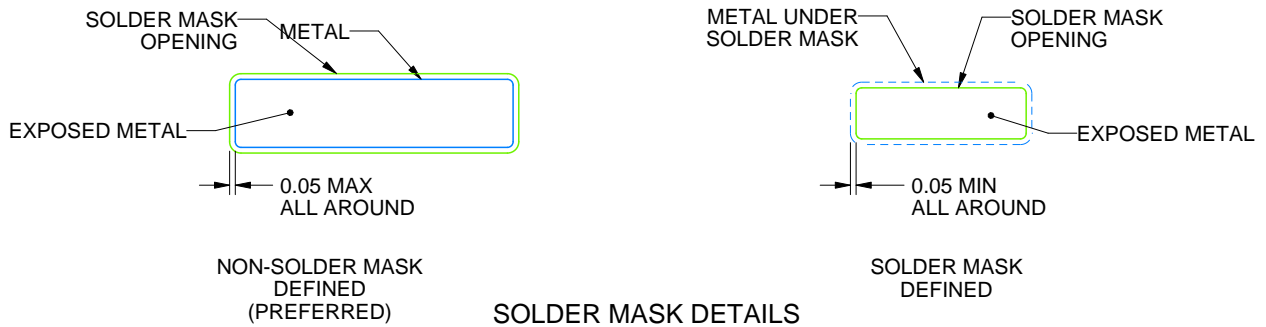

4220202/B 12/2023

NOTES: (continued)

- 6. Publication IPC-7351 may have alternate designs.
- 7. Solder mask tolerances between and around signal pads can vary based on board fabrication site.

# EXAMPLE STENCIL DESIGN

PW0014A

TSSOP - 1.2 mm max height

SMALL OUTLINE PACKAGE

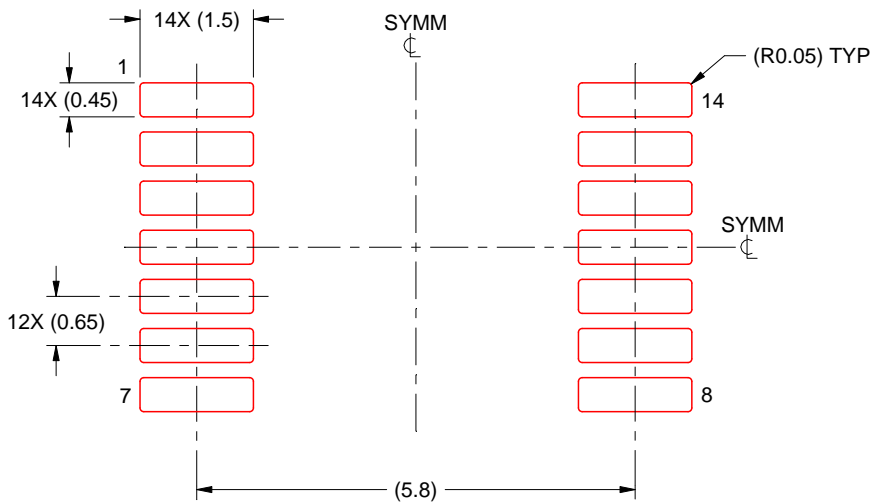

SOLDER PASTE EXAMPLE  
BASED ON 0.125 mm THICK STENCIL  
SCALE: 10X

4220202/B 12/2023

NOTES: (continued)

8. Laser cutting apertures with trapezoidal walls and rounded corners may offer better paste release. IPC-7525 may have alternate design recommendations.
9. Board assembly site may have different recommendations for stencil design.

PW0008A



**PACKAGE OUTLINE**  
**TSSOP - 1.2 mm max height**

SMALL OUTLINE PACKAGE



4221848/A 02/2015

NOTES:

1. All linear dimensions are in millimeters. Any dimensions in parenthesis are for reference only. Dimensioning and tolerancing per ASME Y14.5M.
2. This drawing is subject to change without notice.
3. This dimension does not include mold flash, protrusions, or gate burrs. Mold flash, protrusions, or gate burrs shall not exceed 0.15 mm per side.
4. This dimension does not include interlead flash. Interlead flash shall not exceed 0.25 mm per side.
5. Reference JEDEC registration MO-153, variation AA.

# EXAMPLE BOARD LAYOUT

PW0008A

TSSOP - 1.2 mm max height

SMALL OUTLINE PACKAGE



LAND PATTERN EXAMPLE  
SCALE:10X



SOLDER MASK DETAILS  
NOT TO SCALE

4221848/A 02/2015

NOTES: (continued)

- 6. Publication IPC-7351 may have alternate designs.
- 7. Solder mask tolerances between and around signal pads can vary based on board fabrication site.

# EXAMPLE STENCIL DESIGN

PW0008A

TSSOP - 1.2 mm max height

SMALL OUTLINE PACKAGE



SOLDER PASTE EXAMPLE  
BASED ON 0.125 mm THICK STENCIL  
SCALE:10X

4221848/A 02/2015

NOTES: (continued)

8. Laser cutting apertures with trapezoidal walls and rounded corners may offer better paste release. IPC-7525 may have alternate design recommendations.
9. Board assembly site may have different recommendations for stencil design.

## IMPORTANT NOTICE AND DISCLAIMER

TI PROVIDES TECHNICAL AND RELIABILITY DATA (INCLUDING DATASHEETS), DESIGN RESOURCES (INCLUDING REFERENCE DESIGNS), APPLICATION OR OTHER DESIGN ADVICE, WEB TOOLS, SAFETY INFORMATION, AND OTHER RESOURCES "AS IS" AND WITH ALL FAULTS, AND DISCLAIMS ALL WARRANTIES, EXPRESS AND IMPLIED, INCLUDING WITHOUT LIMITATION ANY IMPLIED WARRANTIES OF MERCHANTABILITY, FITNESS FOR A PARTICULAR PURPOSE OR NON-INFRINGEMENT OF THIRD PARTY INTELLECTUAL PROPERTY RIGHTS.

These resources are intended for skilled developers designing with TI products. You are solely responsible for (1) selecting the appropriate TI products for your application, (2) designing, validating and testing your application, and (3) ensuring your application meets applicable standards, and any other safety, security, regulatory or other requirements.

These resources are subject to change without notice. TI grants you permission to use these resources only for development of an application that uses the TI products described in the resource. Other reproduction and display of these resources is prohibited. No license is granted to any other TI intellectual property right or to any third party intellectual property right. TI disclaims responsibility for, and you fully indemnify TI and its representatives against any claims, damages, costs, losses, and liabilities arising out of your use of these resources.

TI's products are provided subject to [TI's Terms of Sale](#), [TI's General Quality Guidelines](#), or other applicable terms available either on [ti.com](http://ti.com) or provided in conjunction with such TI products. TI's provision of these resources does not expand or otherwise alter TI's applicable warranties or warranty disclaimers for TI products. Unless TI explicitly designates a product as custom or customer-specified, TI products are standard, catalog, general purpose devices.

TI objects to and rejects any additional or different terms you may propose.

Copyright © 2026, Texas Instruments Incorporated

Last updated 10/2025