

LP2985LV-N Micropower 150-mA, Low-Noise, Low-Dropout Regulator in SOT-23 and DSBGA Packages

1 Features

- Wide Supply Voltage Range: 2.2 V to 16 V
- Ensured 150-mA Output Current
- Requires Minimum External Components
- Stable With Low-ESR Output Capacitor
- < 1- μ A Quiescent Current When Shut Down
- Low Ground Pin Current at all Loads
- Output Voltage Accuracy 1% (A Grade)
- High Peak Current Capability
- Low Z_{OUT} : 0.3- Ω Typical (10 Hz to 1 MHz)
- Overtemperature/Overcurrent Protection
- -40°C to +125°C Junction Temperature Range

2 Applications

- Cellular Phone
- Palmtop/Laptop Computer
- Personal Digital Assistant (PDA)
- Camcorder, Personal Stereo, Camera

3 Description

The LP2985LV-N is a 150-mA, fixed-output voltage regulator designed to provide high performance and low noise in applications requiring output voltages \leq 2 V.

Using an optimized vertically integrated PNP (VIP) process, the LP2985LV-N delivers unequaled performance in all specifications critical to battery-powered designs:

- Ground Pin Current: Typically 825 μ A at 150-mA load, and 75 μ A at 1-mA load.
- Enhanced Stability: The LP2985LV-N is stable with output capacitor equivalent series resistance (ESR) as low as 5 m Ω , which allows the use of ceramic capacitors on the output.
- Sleep Mode: Less than 1- μ A quiescent current when ON/OFF pin is pulled low.
- Precision Output: 1% tolerance output voltages available (A grade).
- Low Noise: By adding a 10-nF bypass capacitor, output noise can be reduced to 30 μ V (typical).

Device Information⁽¹⁾

PART NUMBER	PACKAGE	BODY SIZE (NOM)
LP2985LV-N	SOT-23 (5)	2.90 mm x 1.60 mm
	DSBGA (5)	1.164 mm x 0.987 mm

(1) For all available packages, see the orderable addendum at the end of the data sheet.

Typical Application

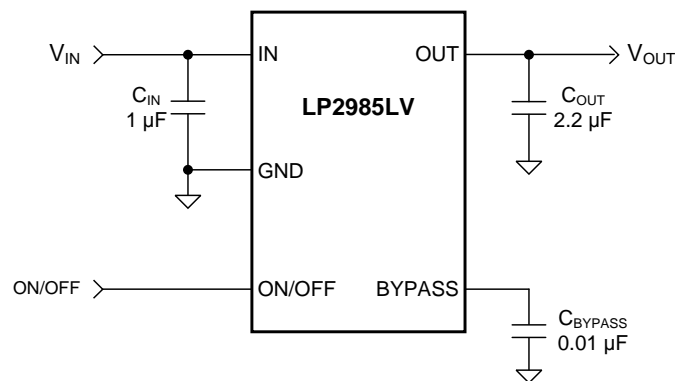

Copyright © 2016, Texas Instruments Incorporated



Table of Contents

1 Features 1 2 Applications 1 3 Description 1 4 Revision History 2 5 Pin Configuration and Functions 3 6 Specifications 4 6.1 Absolute Maximum Ratings 4 6.2 ESD Ratings..... 4 6.3 Recommended Operating Conditions..... 4 6.4 Thermal Information 5 6.5 Electrical Characteristics..... 5 6.6 Typical Characteristics 7 7 Detailed Description 11 7.1 Overview 11 7.2 Functional Block Diagram 11 7.3 Feature Description..... 12 7.4 Device Functional Modes..... 13	8 Application and Implementation 14 8.1 Application Information..... 14 8.2 Typical Application 14 9 Power Supply Recommendations 22 10 Layout 22 10.1 Layout Guidelines 22 10.2 Layout Example 22 10.3 DSBGA Mounting..... 23 10.4 DSBGA Light Sensitivity 23 11 Device and Documentation Support 24 11.1 Documentation Support 24 11.2 Community Resources..... 24 11.3 Trademarks 24 11.4 Electrostatic Discharge Caution..... 24 11.5 Glossary 24 12 Mechanical, Packaging, and Orderable Information 24
--	--

4 Revision History

NOTE: Page numbers for previous revisions may differ from page numbers in the current version.

Changes from Revision P (April 2013) to Revision Q	Page
• Added <i>Device Information</i> and <i>Pin Configuration and Functions</i> sections, <i>ESD Ratings</i> and <i>Thermal Information</i> tables, <i>Feature Description</i> , <i>Device Functional Modes</i> , <i>Application and Implementation</i> , <i>Power Supply Recommendations</i> , <i>Layout</i> , <i>Device and Documentation Support</i> , and <i>Mechanical, Packaging, and Orderable Information</i> sections; change pin names in text and app circuit drawing "VOUT" and "VIN" to "OUT" and "IN" 1	1
• Deleted lead temperature spec per new TI documentation guidelines 4	4
• Changed value of $R_{\theta JA}$ for the SOT-23 package is 220°C/W ..." to "...value of $R_{\theta JA}$ for the SOT-23 package is 175.7°C/W..." in footnote 3 to <i>Abs Max</i> table - see update thermal info for SOT-23 in <i>Thermal Information</i> ; add $R_{\theta JA}$ values to footnote 3 to <i>Abs Max</i> 4	4
• Added <i>Power Dissipation</i> and <i>Estimating Junction Temperature</i> subsections 19	19

Changes from Revision O (April 2013) to Revision P	Page
• Changed layout of National Semiconductor data sheet to TI format 1	1

5 Pin Configuration and Functions

**DBV Package
5 Pin SOT-23
Top View**

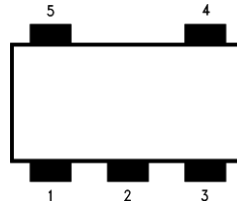

**YPB Package
5-Pin DSBGA
Top View**

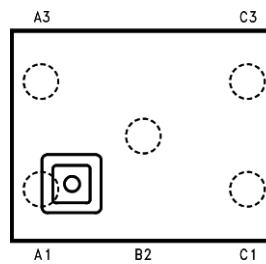

- (1) The actual physical placement of the package marking varies from part to part. Package marking contains date code and lot traceability information and will vary considerably. Package marking does not correlate to device type.

Pin Functions

NAME	PIN		TYPE	DESCRIPTION
	SOT-23	DSBGA		
BYPASS	4	B2	I/O	Bypass capacitor for low noise operation
GND	2	A1	—	Common ground (device substrate)
IN	1	C3	I	Input voltage
ON/OFF	3	A3	I	Logic high enable input
OUT	5	C1	O	Regulated output voltage

6 Specifications

6.1 Absolute Maximum Ratings

 over operating free-air temperature range (unless otherwise noted)⁽¹⁾⁽²⁾

	MIN	MAX	UNIT
Input supply voltage	-0.3	16	V
Shutdown input voltage	-0.3	16	V
Power dissipation ⁽³⁾	Internally Limited		
Output voltage ⁽⁴⁾	-0.3	9	V
I _{OUT}	Short-circuit protected		
Input-output voltage ⁽⁵⁾	-0.3	16	V
Storage temperature, T _{stg}	-65	150	°C

(1) Stresses beyond those listed under *Absolute Maximum Ratings* may cause permanent damage to the device. These are stress ratings only, which do not imply functional operation of the device at these or any other conditions beyond those indicated under *Recommended Operating Conditions*. Exposure to absolute-maximum-rated conditions for extended periods may affect device reliability.

(2) If Military/Aerospace specified devices are required, contact the Texas Instruments Sales Office/ Distributors for availability and specifications.

(3) The maximum allowable power dissipation is a function of the maximum junction temperature, T_{J_MAX}, the junction-to-ambient thermal resistance, R_{θJA}, and the ambient temperature, T_A. The maximum allowable power dissipation at any ambient temperature is calculated using:

$$P_{MAX} = \frac{T_{J_MAX} - T_A}{R_{\theta JA}}$$

Where the value of R_{θJA} for the SOT-23 package is 175.7°C/W in a typical PC board mounting or 178.8°C/W for YPB-type DSBGA package.

Exceeding the maximum allowable dissipation causes excessive die temperature, and the regulator goes into thermal shutdown.

(4) If used in a dual-supply system where the regulator load is returned to a negative supply, the LP2985LV-N output must be diode-clamped to GND.

(5) The output PNP structure contains a diode between the IN to OUT pins that is normally reverse-biased. Reversing the polarity from IN to OUT turns on this diode.

6.2 ESD Ratings

			VALUE	UNIT
V _(ESD) Electrostatic discharge	Human-body model (HBM), per ANSI/ESDA/JEDEC JS-001 ⁽¹⁾	Pins 3 and 4 (SOT-23) Pins A3 and B2 (DSBGA)	±1000	V
		Pins 1, 2, and 5 (SOT-23) Pins A1, C1, and C3 (DSBGA)	±2000	

(1) JEDEC document JEP155 states that 500-V HBM allows safe manufacturing with a standard ESD control process.

6.3 Recommended Operating Conditions

over operating free-air temperature range (unless otherwise noted)

		MIN	MAX	UNIT
V _{IN}	Supply input voltage	2.2 ⁽¹⁾	16	V
V _{ON/OFF}	ON/OFF input voltage	0	V _{IN}	V
I _{OUT}	Output current		150	mA
T _J	Operating junction temperature	-40	125	°C

(1) Recommended minimum V_{IN} is the greater of 2.2 V or V_{OUT(MAX)} + rated dropout voltage (maximum) for operating load current.

6.4 Thermal Information

THERMAL METRIC ⁽¹⁾		LP2985LV-N		UNIT
		SOT-23 (DBV)	DSBGA (YPB)	
		5 PINS		
$R_{\theta JA}$ ⁽²⁾	Junction-to-ambient thermal resistance	175.7	178.8	°C/W
$R_{\theta JC(top)}$	Junction-to-case (top) thermal resistance	78	2.1	°C/W
$R_{\theta JB}$	Junction-to-board thermal resistance	30.8	146.3	°C/W
ψ_{JT}	Junction-to-top characterization parameter	2.8	1.9	°C/W
ψ_{JB}	Junction-to-board characterization parameter	30.3	146.3	°C/W

- (1) For more information about traditional and new thermal metrics, see the [Semiconductor and IC Package Thermal Metrics](#) application report.
- (2) Thermal resistance value $R_{\theta JA}$ is based on the EIA/JEDEC High-K printed circuit board defined by: *JESD51-7 - High Effective Thermal Conductivity Test Board for Leaded Surface Mount Packages*.

6.5 Electrical Characteristics

Unless otherwise specified: $V_{IN} = V_{O(NOM)} + 1\text{ V}$, $I_L = 1\text{ mA}$, $C_{IN} = 1\text{ }\mu\text{F}$, $C_{OUT} = 4.7\text{ }\mu\text{F}$, $V_{ON/OFF} = 2\text{ V}$, $T_J = 25^\circ\text{C}$.⁽¹⁾

PARAMETER	TEST CONDITIONS	LP2985AI-XX ⁽²⁾			LP2985I-XX ⁽²⁾			UNIT	
		MIN	TYP	MAX	MIN	TYP	MAX		
ΔV_O	Output voltage tolerance	$I_L = 1\text{ mA}$	-1		1	-1.5		1.5	% V_{NOM}
		$1\text{ mA} < I_L < 50\text{ mA}$	-1.5		1.5	-2.5		2.5	
		$1\text{ mA} < I_L < 50\text{ mA}$ $-40^\circ\text{C} \leq T_J \leq 125^\circ\text{C}$	-2.5		2.5	-3.5		3.5	
		$1\text{ mA} < I_L < 150\text{ mA}$	-2.5		2.5	-3		3	
		$1\text{ mA} < I_L < 150\text{ mA}$ $-40^\circ\text{C} \leq T_J \leq 125^\circ\text{C}$	-3.5		3.5	-4		4	
$\Delta V_O/\Delta V_{IN}$	Output voltage line regulation	$V_{O(NOM)} + 1\text{ V} \leq V_{IN} \leq 16\text{ V}$	0.007	0.014		0.007	0.014	%V	
		$V_{O(NOM)} + 1\text{ V} \leq V_{IN} \leq 16\text{ V}$ $-40^\circ\text{C} \leq T_J \leq 125^\circ\text{C}$		0.032			0.032		
$V_{IN(MIN)}$	Minimum input voltage required to maintain output regulation ⁽³⁾		2.05			2.05		V	
		$-40^\circ\text{C} \leq T_J \leq 125^\circ\text{C}$		2.2			2.2		
$V_{IN} - V_{OUT}$	Dropout voltage ⁽³⁾	$I_L = 50\text{ mA}$		120	150		120	150	mV
		$I_L = 50\text{ mA}$, $-40^\circ\text{C} \leq T_J \leq 125^\circ\text{C}$			250			250	
		$I_L = 150\text{ mA}$		280	350		280	350	
		$I_L = 150\text{ mA}$, $-40^\circ\text{C} \leq T_J \leq 125^\circ\text{C}$			600			600	
I_{GND}	Ground pin current	$I_L = 0\text{ mA}$		65	95		65	95	μA
		$I_L = 0\text{ mA}$, $-40^\circ\text{C} \leq T_J \leq 125^\circ\text{C}$			125			125	
		$I_L = 1\text{ mA}$		75	110		75	110	
		$I_L = 1\text{ mA}$, $-40^\circ\text{C} \leq T_J \leq 125^\circ\text{C}$			170			170	
		$I_L = 10\text{ mA}$		120	220		120	220	
		$I_L = 10\text{ mA}$, $-40^\circ\text{C} \leq T_J \leq 125^\circ\text{C}$			400			400	
		$I_L = 50\text{ mA}$		300	500		300	500	
		$I_L = 50\text{ mA}$, $-40^\circ\text{C} \leq T_J \leq 125^\circ\text{C}$			900			900	
		$I_L = 150\text{ mA}$		825	1200		825	1200	
		$I_L = 150\text{ mA}$, $-40^\circ\text{C} \leq T_J \leq 125^\circ\text{C}$			2000			2000	
		$V_{ON/OFF} < 0.3\text{ V}$		0.01	0.8		0.01	0.8	
$V_{ON/OFF} < 0.15\text{ V}$ $-40^\circ\text{C} \leq T_J \leq 125^\circ\text{C}$		0.05	2		0.05	2			

- (1) Exposing the DSBGA device to direct sunlight causes misoperation. See [Layout](#) for additional information.
- (2) Limits are 100% production tested at 25°C. Limits over the operating temperature range are ensured through correlation using statistical quality control (SQC) methods. The limits are used to calculate average outgoing quality level (AOQL).
- (3) V_{IN} must be the greater of 2.2 V or $V_{OUT(NOM)} +$ dropout voltage to maintain output regulation. Dropout voltage is defined as the input to output differential at which the output voltage drops 2% below the value measured with a 1-V differential.

Electrical Characteristics (continued)

 Unless otherwise specified: $V_{IN} = V_{O(NOM)} + 1\text{ V}$, $I_L = 1\text{ mA}$, $C_{IN} = 1\text{ }\mu\text{F}$, $C_{OUT} = 4.7\text{ }\mu\text{F}$, $V_{ON/OFF} = 2\text{ V}$, $T_J = 25^\circ\text{C}$.⁽¹⁾

PARAMETER	TEST CONDITIONS	LP2985AI-XX ⁽²⁾			LP2985I-XX ⁽²⁾			UNIT
		MIN	TYP	MAX	MIN	TYP	MAX	
$V_{ON/OFF}$ ON/OFF input voltage ⁽⁴⁾	High = O/P ON		1.4			1.4		V
	High = O/P ON $-40^\circ\text{C} \leq T_J \leq 125^\circ\text{C}$	1.6			1.6			
	Low = O/P OFF		0.55			0.55		
	Low = O/P OFF $-40^\circ\text{C} \leq T_J \leq 125^\circ\text{C}$			0.15			0.15	
$I_{ON/OFF}$ ON/OFF input current	$V_{ON/OFF} = 0\text{ V}$		0.01			0.01		μA
	$V_{ON/OFF} = 0\text{ V}$ $-40^\circ\text{C} \leq T_J \leq 125^\circ\text{C}$			-2			-2	
	$V_{ON/OFF} = 5\text{ V}$		5			5		
	$V_{ON/OFF} = 5\text{ V}$ $-40^\circ\text{C} \leq T_J \leq 125^\circ\text{C}$			15			15	
$I_{O(PK)}$ Peak output current	$V_{OUT} \geq V_{O(NOM)} - 5\%$		350			350		mA
e_n Output noise voltage	BW = 300 Hz to 50 kHz $C_{OUT} = 10\text{ }\mu\text{F}$ $C_{BYPASS} = 10\text{ nF}$, $V_{OUT} = 1.8\text{ V}$		30			30		$\mu\text{V}_{(RMS)}$
$\Delta V_O/\Delta V_{IN}$ Ripple rejection	$f = 1\text{ kHz}$, $C_{OUT} = 10\text{ }\mu\text{F}$ $C_{BYPASS} = 10\text{ nF}$		45			45		dB
$I_{O(SC)}$ Short-circuit current	$R_L = 0\text{ }\Omega$ (steady state) ⁽⁵⁾		400			400		mA

(4) The ON/OFF inputs must be properly driven to prevent misoperation. For details, see [Operation With ON/OFF Control](#).

(5) The LP2985LV-N has foldback current limiting, which allows a high peak current when $V_{OUT} > 0.5\text{ V}$ and then reduces the maximum output current as V_{OUT} is forced to ground (see related curve(s) in [Typical Characteristics](#)).

6.6 Typical Characteristics

Unless otherwise specified: $C_{IN} = 1 \mu\text{F}$, $C_{OUT} = 4.7 \mu\text{F}$, $V_{IN} = V_{OUT}(\text{NOM}) + 1$, $V_{OUT} = 1.8 \text{ V}$, $T_A = 25^\circ\text{C}$, ON/OFF pin is tied to V_{IN} .

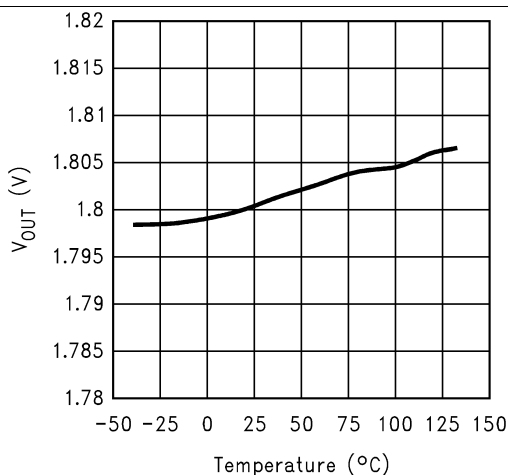

Figure 1. V_{OUT} vs Temperature

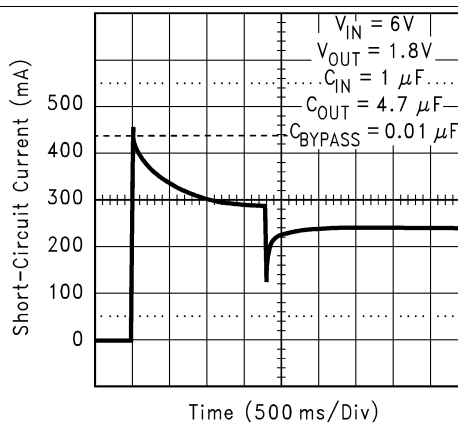

Figure 2. Short-Circuit Current

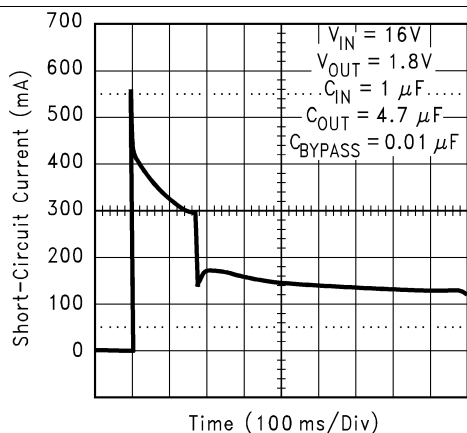

Figure 3. Short-Circuit Current

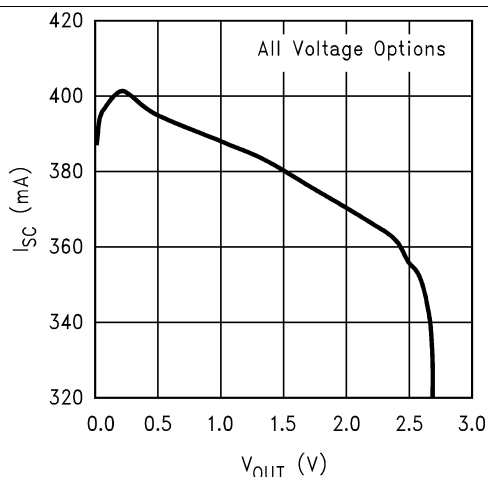

Figure 4. Short-Circuit Current vs Output Voltage

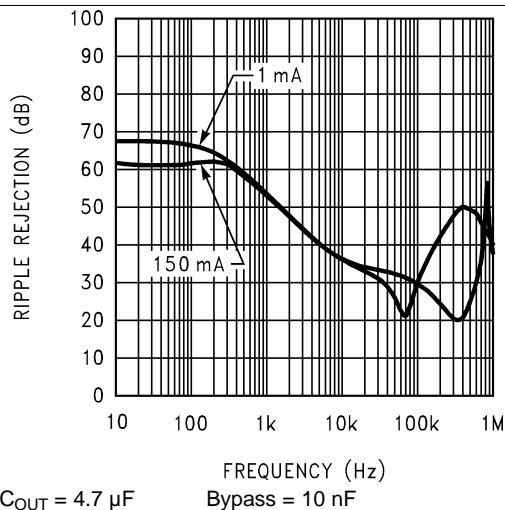

Figure 5. Ripple Rejection

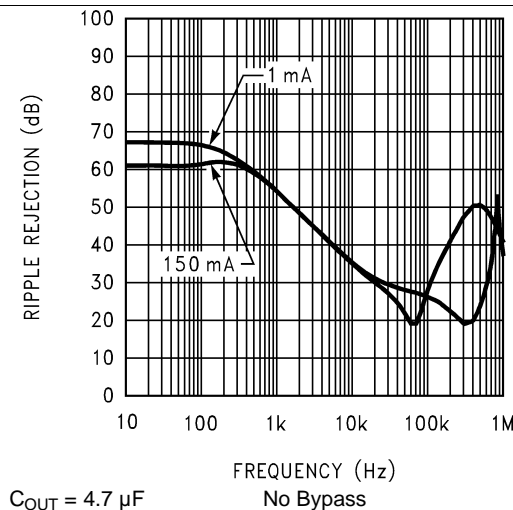

Figure 6. Ripple Rejection

Typical Characteristics (continued)

Unless otherwise specified: $C_{IN} = 1 \mu F$, $C_{OUT} = 4.7 \mu F$, $V_{IN} = V_{OUT(NOM)} + 1$, $V_{OUT} = 1.8 V$, $T_A = 25^\circ C$, ON/OFF pin is tied to V_{IN} .

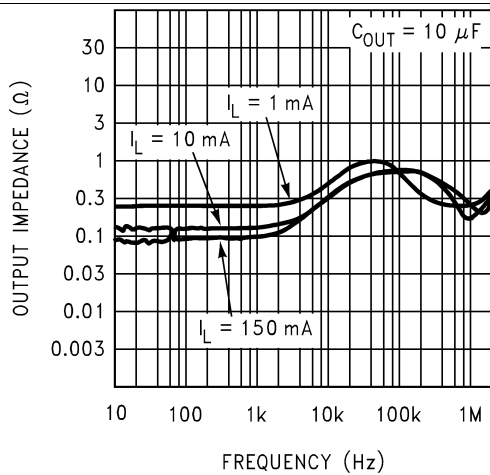

Figure 7. Output Impedance vs Frequency

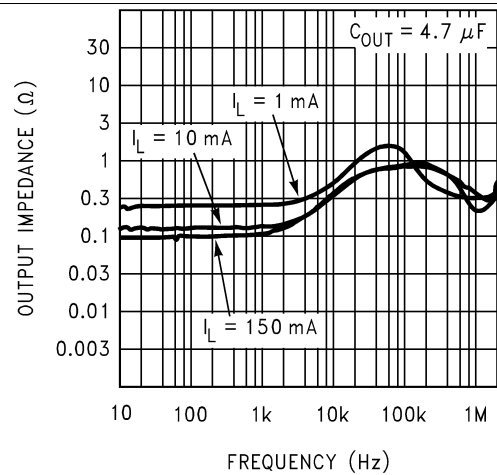

Figure 8. Output Impedance vs Frequency

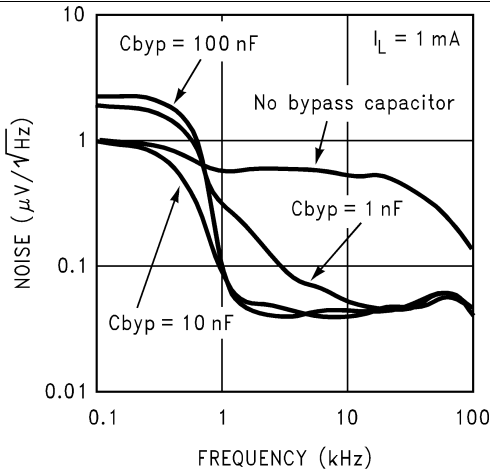

Figure 9. Noise Density

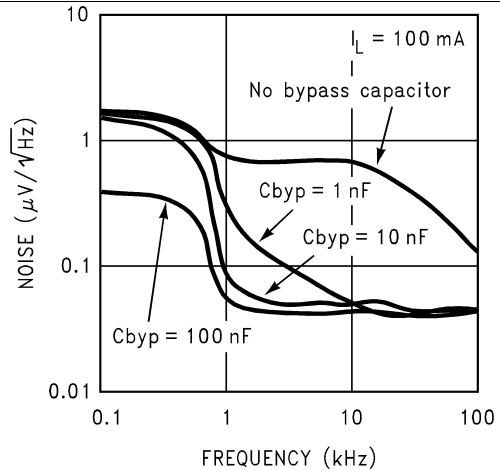

Figure 10. Noise Density

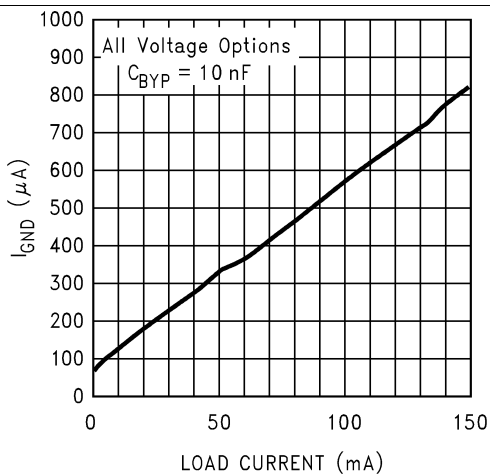

Figure 11. Ground Pin vs Load Current

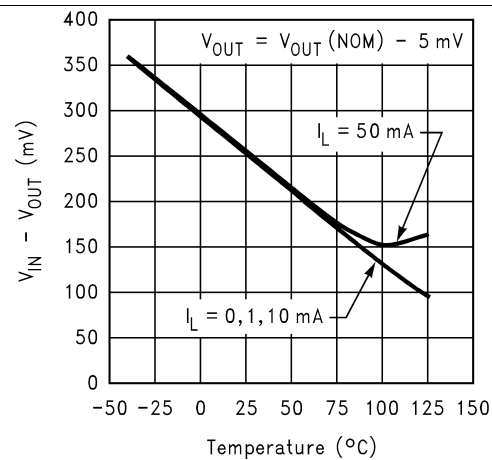

Figure 12. Minimum Input Voltage vs Temperature

Typical Characteristics (continued)

Unless otherwise specified: $C_{IN} = 1 \mu F$, $C_{OUT} = 4.7 \mu F$, $V_{IN} = V_{OUT(NOM)} + 1$, $V_{OUT} = 1.8 V$, $T_A = 25^\circ C$, ON/OFF pin is tied to V_{IN} .

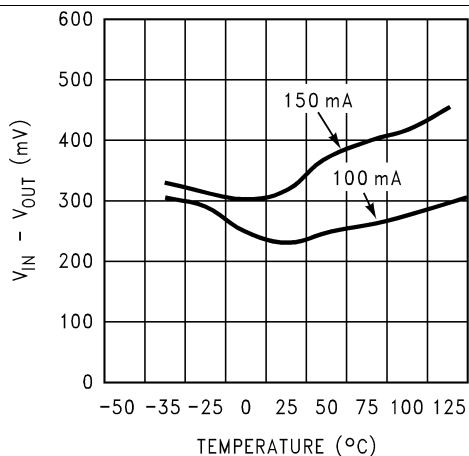

Figure 13. Minimum Input Voltage vs Temperature

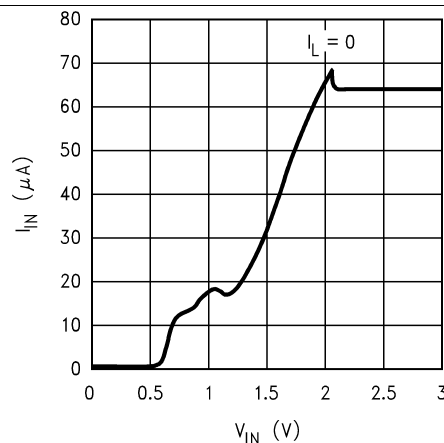

Figure 14. Input Current vs V_{IN}

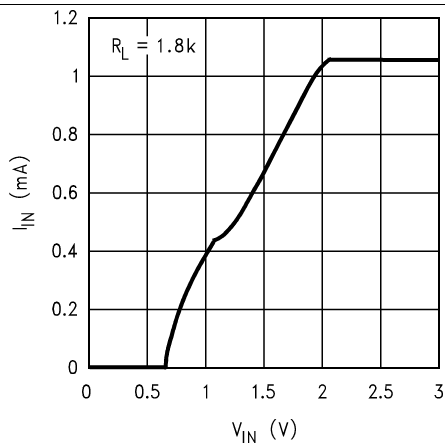

Figure 15. Input Current vs V_{IN}

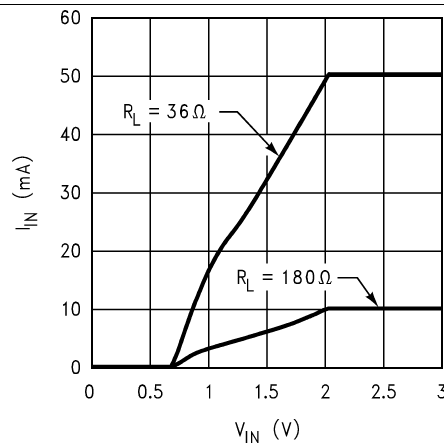

Figure 16. Input Current vs V_{IN}

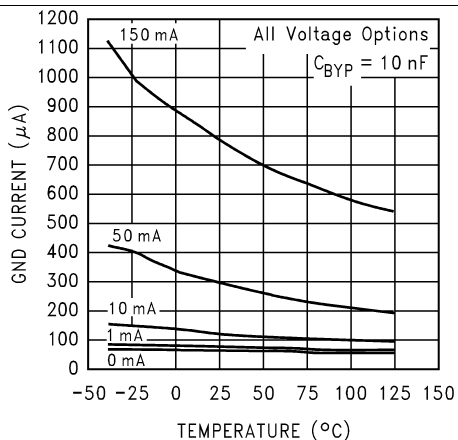

Figure 17. Ground Pin Current vs Temperature

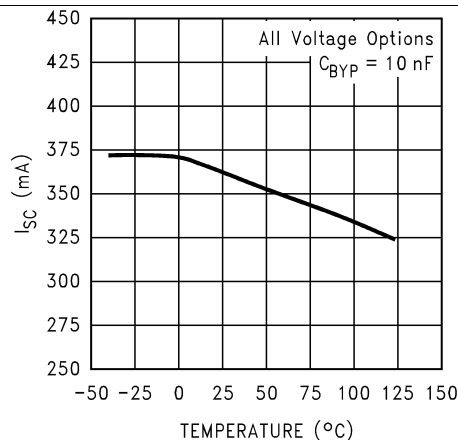

Figure 18. Instantaneous Short Circuit Current

Typical Characteristics (continued)

Unless otherwise specified: $C_{IN} = 1 \mu\text{F}$, $C_{OUT} = 4.7 \mu\text{F}$, $V_{IN} = V_{OUT}(\text{NOM}) + 1$, $V_{OUT} = 1.8 \text{ V}$, $T_A = 25^\circ\text{C}$, ON/OFF pin is tied to V_{IN} .

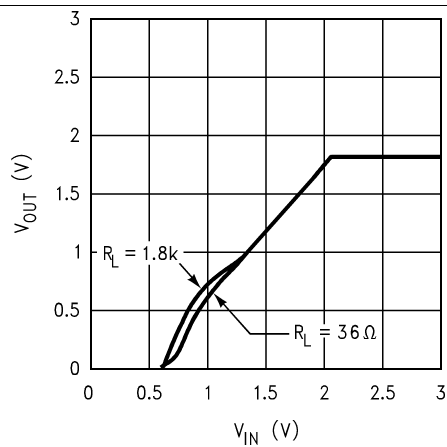

Figure 19. Output Characteristics

7 Detailed Description

7.1 Overview

The LP2985LV-N family of fixed-output, ultra-low-dropout and low-noise regulators offers exceptional, cost-effective performance for battery-powered applications. Available in output voltages from 1.5 V to 2 V, the family has an output voltage tolerance of 1% for the A version (1.5% for the non-A version) and is capable of delivering 150-mA continuous load current. Standard regulator features, such as overcurrent and overtemperature protection, are also included.

Using an optimized vertically integrated PNP (VIP) process, the LP2985LV-N contains several features to facilitate battery-powered designs:

- Multiple voltage options
- Low dropout voltage, typical dropout of 280 mV at 150-mA load current and 120 mV at 50-mA load current.
- Low quiescent current and low ground current, typically 825- μ A at 150-mA load, and 75 μ A at 1-mA load.
- A shutdown feature is available, allowing the regulator to consume only 0.01 μ A typically when the ON/ $\overline{\text{OFF}}$ pin is pulled low.
- Overtemperature protection and overcurrent protection circuitry is designed to safeguard the device during unexpected conditions
- Enhanced stability: The LP2985LV-N is stable with output capacitor ESR as low as 5 m Ω , which allows the use of ceramic capacitors on the output.
- Low noise: A BYPASS pin allows for low-noise operation, with a typical output noise of 30 μ V_{RMS}, with the use of a 10-nF bypass capacitor.

7.2 Functional Block Diagram

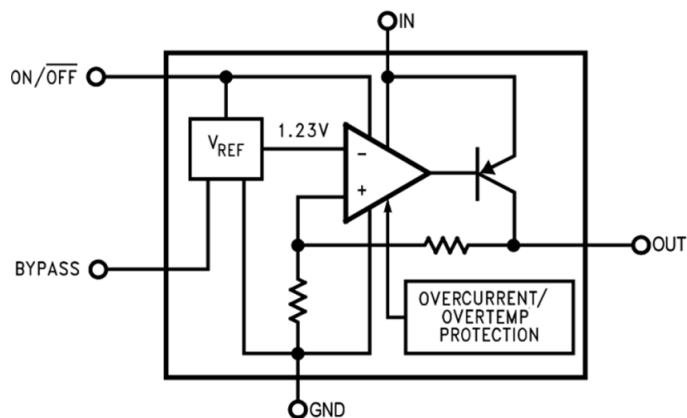

Copyright © 2016, Texas Instruments Incorporated

7.3 Feature Description

7.3.1 Multiple Voltage Options

In order to meet different application requirement, the LP2985LV-N family provide multiple fixed output options from 1.5 V to 2 V. Contact your regional TI sales team for custom voltage options.

7.3.2 Output Voltage Accuracy

Output voltage accuracy specifies minimum and maximum output voltage error, relative to the expected nominal output voltage stated as a percent. This accuracy error includes the errors introduced by the internal reference and the load and line regulation across the full range of rated load and line operating conditions over temperature, unless otherwise specified by the [Electrical Characteristics](#). Output voltage accuracy also accounts for all variations between manufacturing lots.

7.3.3 Ultra-Low-Dropout Voltage

Generally speaking, the dropout voltage often refers to the voltage difference between the input and output voltage ($V_{DO} = V_{IN} - V_{OUT}$), where the current pass transistor loses its voltage-controlled current capability and the collector (V_{OUT}) to emitter (V_{IN}) voltage becomes constant for a given current and is characterized by the classic $V_{CE(SAT)}$ of the PNP transistor. V_{DO} indirectly specifies a minimum input voltage above the nominal programmed output voltage at which the output voltage is expected to remain within its accuracy boundary. If the input falls below this V_{DO} limit ($V_{IN} < V_{OUT} + V_{DO}$), then active regulation of the output voltage is no longer possible, and the output voltage decreases as the input voltage falls.

7.3.4 Low Ground Current

The LP2985LV-N device uses a vertical PNP process which allows for quiescent currents that are considerably lower than those associated with traditional lateral PNP regulators, typically 825 μ A at 150-mA load.

7.3.5 Sleep Mode

When the $\overline{ON/OFF}$ pin is pulled to a low level the LP2985LV-N enters sleep mode, and less than 2- μ A quiescent current is consumed. This function is designed for the application which needs a sleep mode to effectively enhance battery life cycle.

7.3.6 Internal Protection Circuitry

7.3.6.1 Short Circuit Protection (Current Limit)

The internal current limit circuit is used to protect the LDO against high-load current faults or shorting events. The LDO is not designed to operate in a steady-state current limit. During a current-limit event, the LDO sources constant current. Therefore, the output voltage falls when load impedance decreases. Note also that if a current limit occurs and the resulting output voltage is low, excessive power may be dissipated across the LDO, resulting in a thermal shutdown of the output.

A foldback feature limits the short-circuit current to protect the regulator from damage under all load conditions. If V_{OUT} is forced below 0 V before EN goes high and the load current required exceeds the foldback current limit, the device may not start up correctly.

7.3.6.2 Thermal Protection

The LP2985LV-N contains a thermal shutdown protection circuit to turn off the output current when excessive heat is dissipated in the LDO. The thermal time-constant of the semiconductor die is fairly short, and thus the output cycles on and off at a high rate when thermal shutdown is reached until the power dissipation is reduced.

The internal protection circuitry of the LP2985LV-N is designed to protect against thermal overload conditions. The circuitry is not intended to replace proper heat sinking. Continuously running the device into thermal shutdown degrades its reliability.

Feature Description (continued)

7.3.7 Enhanced Stability

The LP2985LV-N is designed specifically to work with ceramic output capacitors, utilizing circuitry which allows the regulator to be stable across the entire range of output current with an output capacitor whose ESR is as low as 5 mΩ. For output capacitor requirement, refer to [Output Capacitor](#).

7.3.8 Low Noise

The LP2985LV-N includes a low-noise reference ensuring minimal noise during operation because the internal reference is normally the dominant term in noise analysis. Further noise reduction can be achieved by adding an external bypass capacitor between the BYPASS pin and the GND pin.

7.4 Device Functional Modes

7.4.1 Operation with $V_{OUT(TARGET)} + 0.6\text{ V} \geq V_{IN} > 16\text{ V}$

The device operate if the input voltage is equal to, or exceeds $V_{OUT(TARGET)} + 0.6\text{ V}$. At input voltages below the minimum V_{IN} requirement, the devices do not operate correctly and output voltage may not reach target value.

7.4.2 Operation With $\overline{\text{ON/OFF}}$ Control

If the voltage on the $\overline{\text{ON/OFF}}$ pin is less than 0.15 V, the device is disabled, and in this state shutdown current does not exceed 2 μA. Raising $\overline{\text{ON/OFF}}$ above 1.6 V initiates the start-up sequence of the device.

8 Application and Implementation

NOTE

Information in the following applications sections is not part of the TI component specification, and TI does not warrant its accuracy or completeness. TI's customers are responsible for determining suitability of components for their purposes. Customers should validate and test their design implementation to confirm system functionality.

8.1 Application Information

The LP2985LV-N is a linear voltage regulator operating from 2.2 V to 16 V on the input and regulating voltages from 1.5 V to 2 V with 1% accuracy (A-grade) and 150-mA maximum output current. Efficiency is defined by the ratio of output voltage to input voltage because the LP2985LV-N is a linear voltage regulator. To achieve high efficiency, the dropout voltage ($V_{IN} - V_{OUT}$) must be as small as possible, thus requiring a very-low-dropout LDO. Successfully implementing an LDO in an application depends on the application requirements. If the requirements are simply input voltage and output voltage, compliance specifications (such as internal power dissipation or stability) must be verified to ensure a solid design. If timing, start-up, noise, power supply rejection ratio (PSRR), or any other transient specification is required, then the design becomes more challenging.

8.2 Typical Application

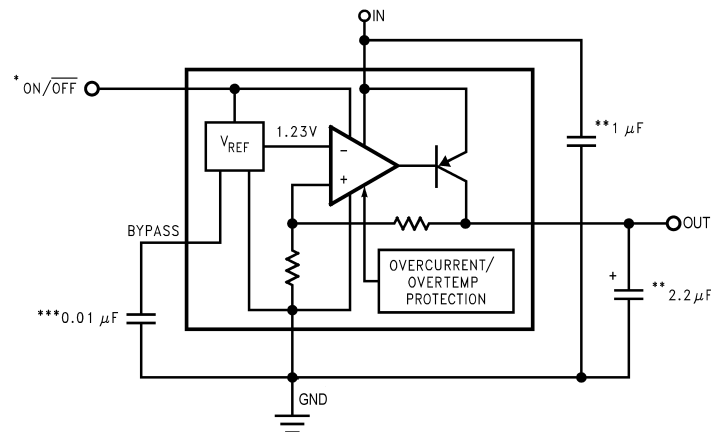

*ON/OFF input must be actively terminated. Tie to V_{IN} if this function is not to be used.

**Minimum capacitance is shown to ensure stability (may be increased without limit). Ceramic capacitor required for output (see [Output Capacitor](#)).

***Reduces output noise (may be omitted if application is not noise critical). Use ceramic or film type with very low leakage current (see [Noise Bypass Capacitor](#)).

Figure 20. Typical Application Schematic

8.2.1 Design Requirements

For typical design parameters, see [Table 1](#).

Table 1. Design Parameters

DESIGN PARAMETERS	VALUE
Input voltage	2.8 V \pm 10%
Output voltage	1.8 V \pm 4%
Output current	150 mA (maximum)
PSRR at 1 kHz	> 50 dB

8.2.2 Detailed Design Procedure

At 150-mA loading, the dropout of the LP2985LV-N has 600-mV maximum dropout over temperature, thus an 1000-mV headroom is sufficient for operation over both input and output voltage accuracy. The efficiency of the LP2985LV-N in this configuration is $V_{OUT} / V_{IN} = 64\%$. To achieve the smallest form factor, the DSBGA package is selected.

Input and output capacitors are selected in accordance with the [Capacitor Characteristics](#) section. Ceramic capacitances of 1 μF for the input and one 2.2- μF capacitor for the output are selected. With a V_{IN} of 2.8 V, a V_{OUT} of 1.8 V, and an output current of 150 mA [Equation 1](#) shows the power dissipation to be 150 mW. With an $R_{\theta JA}$ rating of 178.8°C/W for the DSBGA YPB package, and a maximum operating ambient temperature of 85°C, [Equation 2](#) shows the maximum junction temperature to be approximately 111.8°C.

8.2.2.1 External Capacitors

Like any low-dropout regulator, the LP2985LV-N requires external capacitors for regulator stability. These capacitors must be correctly selected for good performance.

8.2.2.1.1 Input Capacitor

An input capacitor whose capacitance is $\geq 1 \mu\text{F}$ is required between the LP2985LV-N input and ground (the amount of capacitance may be increased without limit).

This capacitor must be located a distance of not more than 1 cm from the input pin and returned to a clean analog ground. Any good quality ceramic, tantalum, or film capacitor may be used at the input.

NOTE

Tantalum capacitors can suffer catastrophic failure due to surge current when connected to a low-impedance source of power (like a battery or very large capacitor). If a Tantalum capacitor is used at the input, it must be ensured by the manufacturer to have a surge current rating sufficient for the application.

There are no requirements for ESR on the input capacitor, but tolerance and temperature coefficient must be considered when selecting the capacitor to ensure the capacitance is $\geq 1 \mu\text{F}$ over the entire operating temperature range.

8.2.2.1.2 Output Capacitor

The LP2985LV-N is designed specifically to work with ceramic output capacitors, utilizing circuitry which allows the regulator to be stable across the entire range of output current with an output capacitor whose ESR is as low as 5 m Ω . It may also be possible to use tantalum or film capacitors at the output, but these are not as attractive for reasons of size and cost (see [Capacitor Characteristics](#)).

The output capacitor must meet the requirement for minimum amount of capacitance and also have an ESR value which is within the stable range. Curves are provided showing the stable ESR range as a function of load current (see [Figure 21](#) and [Figure 22](#)).

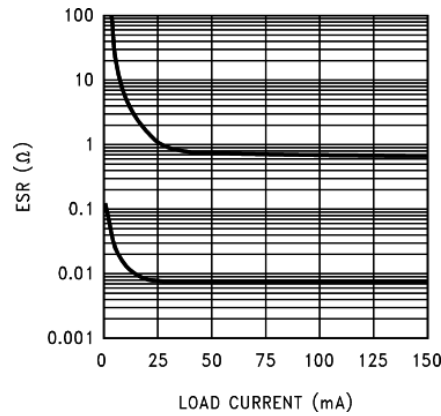

Figure 21. LP2985LV-N 2.2- μ F Stable ESR Range

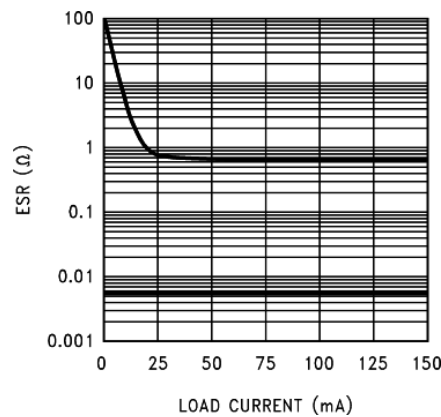

Figure 22. LP2985LV-N 4.7- μ F Stable ESR Range

NOTE

The output capacitor must maintain its ESR within the stable region over the full operating temperature range of the application to assure stability.

The LP2985LV-N requires a minimum of 2.2 μ F on the output (output capacitor size can be increased without limit).

It is important to remember that capacitor tolerance and variation with temperature must be taken into consideration when selecting an output capacitor so that the minimum required amount of output capacitance is provided over the full operating temperature range. Ceramic capacitors can exhibit large changes in capacitance with temperature (see [Capacitor Characteristics](#)). The output capacitor must be located not more than 1 cm from the output pin and returned to a clean analog ground.

8.2.2.1.3 Noise Bypass Capacitor

Connecting a 10-nF capacitor to the BYPASS pin significantly reduces noise on the regulator output. The capacitor is connected directly to a high-impedance circuit in the bandgap reference.

Because this circuit has only a few microamperes flowing in it, any significant loading on this node causes a change in the regulated output voltage. For this reason, DC leakage current through the noise bypass capacitor must never exceed 100 nA and must be kept as low as possible for best output voltage accuracy.

The types of capacitors best suited for the noise bypass capacitor are ceramic and film. High-quality ceramic capacitors with either NPO or COG dielectric typically have very low leakage. 10-nF polypropylene and polycarbonate film capacitors are available in small surface-mount packages and typically have extremely low leakage current.

8.2.2.2 Capacitor Characteristics

The LP2985LV-N is designed to work with ceramic capacitors on the output to take advantage of the benefits they offer: for capacitance values in the 2.2- μF to 4.7- μF range, ceramics are the least expensive and also have the lowest ESR values (making them best for eliminating high-frequency noise). The ESR of a typical 2.2- μF ceramic capacitor is in the range of 10 m Ω to 20 m Ω , which easily meets the ESR limits required for stability by the device.

One disadvantage of ceramic capacitors is that their capacitance can vary with temperature. Most large value ceramic capacitors ($\geq 2.2 \mu\text{F}$) are manufactured with the Z5U or Y5V temperature characteristic, which results in the capacitance dropping by more than 50% as the temperature goes from 25°C to 85°C.

Problems may ensue if a 2.2- μF capacitor is used on the output because it drops down to approximately 1 μF at high ambient temperatures (which could cause the LM2985 to oscillate). If Z5U or Y5V capacitors are used on the output, a minimum capacitance value of 4.7 μF must be observed.

A better choice for temperature coefficient in ceramic capacitors is X7R, which holds the capacitance within $\pm 15\%$. Unfortunately, the larger values of capacitance are not offered by all manufacturers in the X7R dielectric.

8.2.2.2.1 Tantalum

Tantalum capacitors are less desirable than ceramics for use as output capacitors because they are more expensive when comparing equivalent capacitance and voltage ratings in the 1 μF to 4.7 μF range.

An additional important consideration is that tantalum capacitors have higher ESR values than equivalent size ceramics. This means that while it may be possible to find a tantalum capacitor with an ESR value within the stable range, it would have to be larger in capacitance (which means bigger and more costly) than a ceramic capacitor with the same ESR value.

Note that the ESR of a typical tantalum increases about 2:1 as the temperature goes from 25°C down to -40°C, so some guard band must be allowed.

8.2.2.3 On/OFF Input Operation

The LP2985LV-N is shut off by driving the ON/OFF input low, and turned on by pulling it high. If this feature is not to be used, the ON/OFF input must be tied to V_{IN} to keep the regulator output on at all times.

To assure proper operation, the signal source used to drive the ON/OFF input must be able to swing above and below the specified turnon/turnoff voltage thresholds listed in [Electrical Characteristics](#) under $V_{\text{ON/OFF}}$. To prevent mis-operation, the turnon (and turnoff) voltage signals applied to the ON/OFF input must have a slew rate which is $\geq 40 \text{ mV}/\mu\text{s}$.

CAUTION

The regulator output voltage cannot be ensured if a slow-moving AC (or DC) signal is applied that is in the range between the specified turnon and turnoff voltages listed under the electrical specification $V_{\text{ON/OFF}}$ (see [Electrical Characteristics](#)).

8.2.2.4 Reverse Input-Output Voltage

The PNP power transistor used as the pass element in the LP2985LV-N has an inherent diode connected between the regulator output and input. During normal operation (where the input voltage is higher than the output) this diode is reverse-biased.

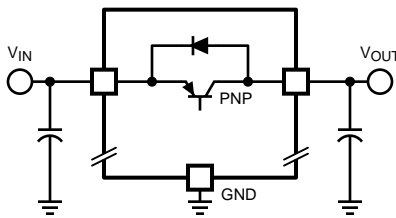
Figure 23. Normal Operation

However, if the output is pulled above the input, this diode turns ON, and current flows into the regulator output. In such cases, a parasitic SCR can latch, allowing a high current to flow into V_{IN} (and out the ground pin), which can damage the part.

In any application where the output may be pulled above the input, an external Schottky diode must be connected from V_{IN} to V_{OUT} (cathode on V_{IN} , anode on V_{OUT}), to limit the reverse voltage across the LP2985LV-N to 0.3V (see [Absolute Maximum Ratings](#)).

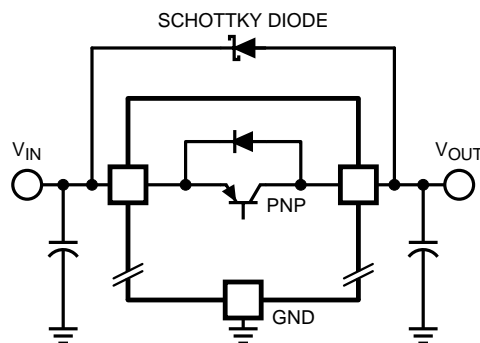
Figure 24. Operation With Schottky Diode

8.2.2.5 Power Dissipation

Knowing the device power dissipation and proper sizing of the thermal plane connected to the tab or pad is critical to ensuring reliable operation. Device power dissipation depends on input voltage, output voltage, and load conditions and can be calculated with [Equation 1](#).

$$P_{D(MAX)} = (V_{IN(MAX)} - V_{OUT}) \times I_{OUT(MAX)} \quad (1)$$

Power dissipation can be minimized, and greater efficiency can be achieved, by using the lowest available voltage drop option that would still be greater than the dropout voltage (V_{DO}). However, keep in mind that higher voltage drops result in better dynamic (that is, PSRR and transient) performance.

On the DSBGA (YPB) package, the primary conduction path for heat is through the four bumps to the PCB.

On the SOT-23 (DBV) package, the primary conduction path for heat is through the device leads to the PCB, predominately device lead 2 (GND). It is recommended that the trace from lead 2 be extended under the package body and connected to an internal ground plane with thermal vias.

The maximum allowable junction temperature ($T_{J(MAX)}$) determines maximum power dissipation allowed ($P_{D(MAX)}$) for the device package.

Power dissipation and junction temperature are most often related by the junction-to-ambient thermal resistance ($R_{\theta JA}$) of the combined PCB and device package and the temperature of the ambient air (T_A), according to [Equation 2](#) or [Equation 3](#):

$$T_{J(MAX)} = T_{A(MAX)} + (R_{\theta JA} \times P_{D(MAX)}) \quad (2)$$

$$P_{D(MAX)} = (T_{J(MAX)} - T_{A(MAX)}) / R_{\theta JA} \quad (3)$$

Unfortunately, this $R_{\theta JA}$ is highly dependent on the heat-spreading capability of the particular PCB design, and therefore varies according to the total copper area, copper weight, and location of the planes. The $R_{\theta JA}$ recorded in [Thermal Information](#) is determined by the specific EIA/JEDEC JESD51-7 standard for PCB and copper-spreading area, and is to be used only as a relative measure of package thermal performance. For a well-designed thermal layout, $R_{\theta JA}$ is actually the sum of the package junction-to-case (bottom) thermal resistance ($R_{\theta JCbot}$) plus the thermal resistance contribution by the PCB copper area acting as a heat sink.

8.2.2.6 Estimating Junction Temperature

The EIA/JEDEC standard recommends the use of psi (Ψ) thermal characteristics to estimate the junction temperatures of surface mount devices on a typical PCB board application. These characteristics are not true thermal resistance values, but rather package specific thermal characteristics that offer practical and relative means of estimating junction temperatures. These psi metrics are determined to be significantly independent of copper-spreading area. The key thermal characteristics (Ψ_{JT} and Ψ_{JB}) are given in [Thermal Information](#) and are used in accordance with [Equation 4](#) or [Equation 5](#).

$$T_{J(MAX)} = T_{TOP} + (\Psi_{JT} \times P_{D(MAX)})$$

where

- $P_{D(MAX)}$ is explained in [Equation 1](#).
- T_{TOP} is the temperature measured at the center-top of the device package. (4)

$$T_{J(MAX)} = T_{BOARD} + (\Psi_{JB} \times P_{D(MAX)})$$

where

- $P_{D(MAX)}$ is explained in [Equation 1](#).
- T_{BOARD} is the PCB surface temperature measured 1-mm from the device package and centered on the package edge. (5)

For more information about the thermal characteristics Ψ_{JT} and Ψ_{JB} , see [Semiconductor and IC Package Thermal Metrics](#), available for download at www.ti.com.

For more information about measuring T_{TOP} and T_{BOARD} , see [Using New Thermal Metrics](#), available for download at www.ti.com.

For more information about the EIA/JEDEC JESD51 PCB used for validating $R_{\theta JA}$, see [Thermal Characteristics of Linear and Logic Packages Using JEDEC PCB Designs](#), available for download at www.ti.com.

8.2.3 Application Curves

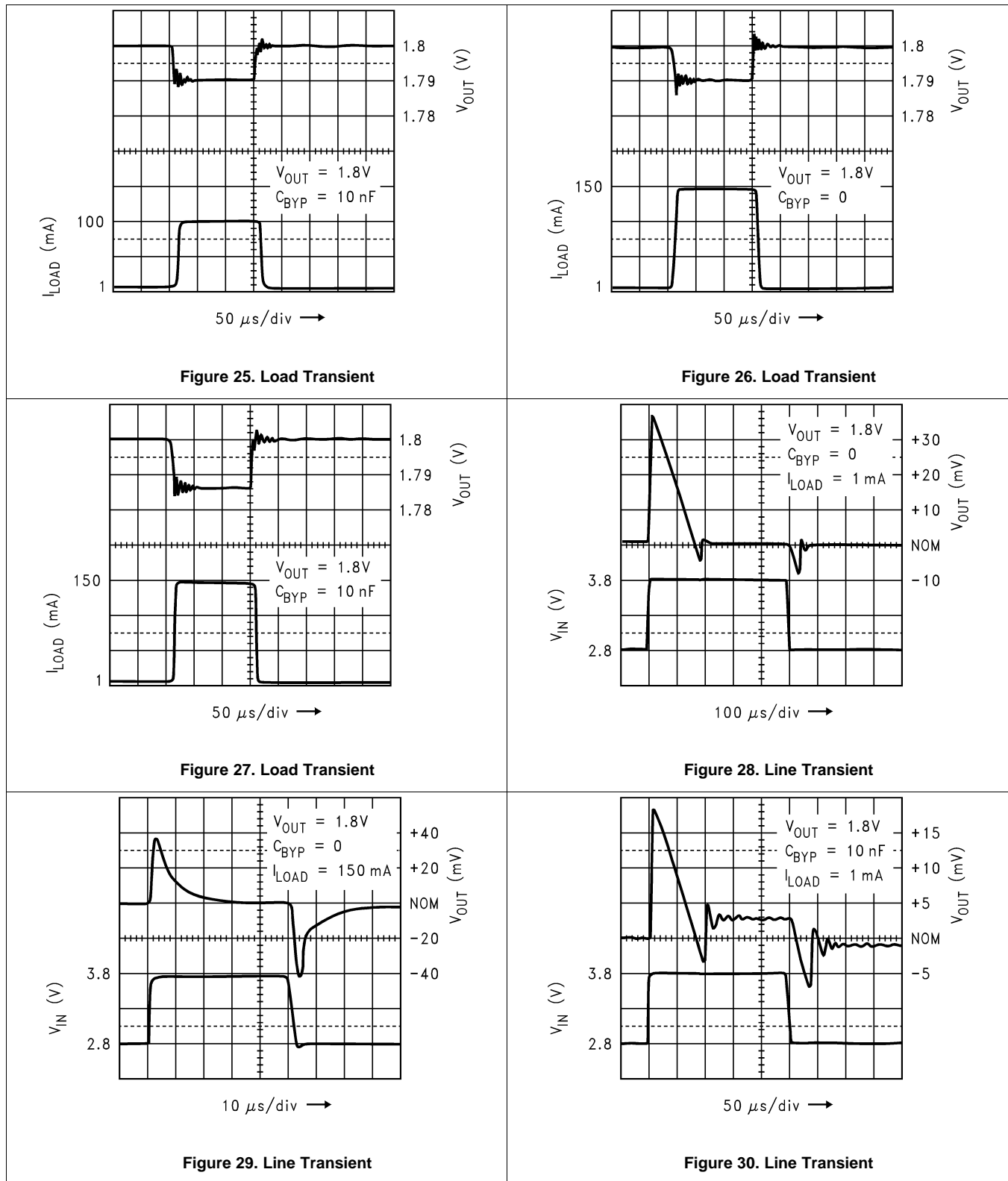

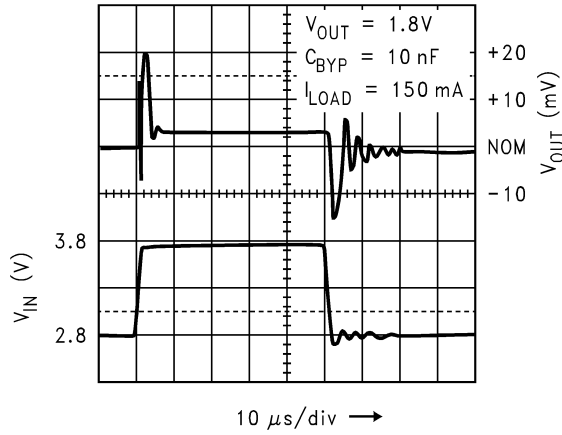

Figure 31. Line Transient

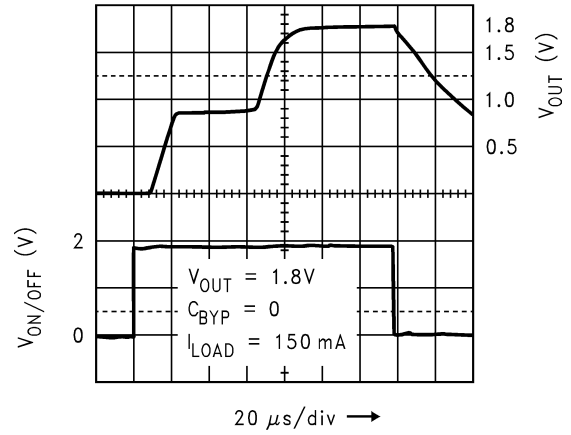

Figure 32. Turnon Time

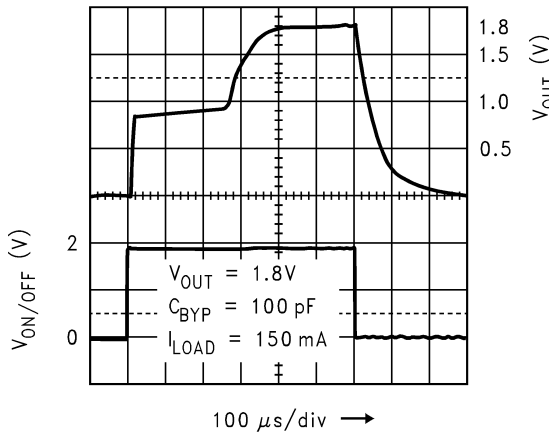

Figure 33. Turnon Time

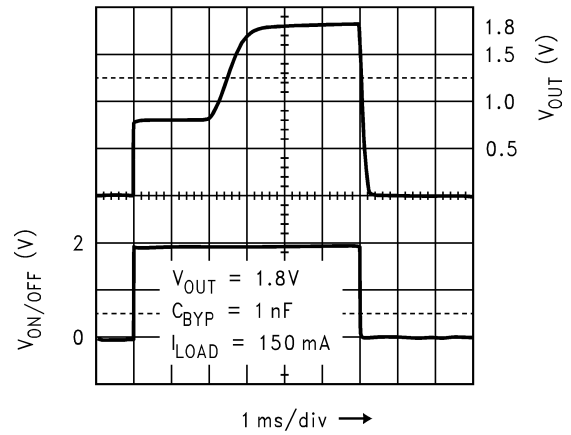

Figure 34. Turnon Time

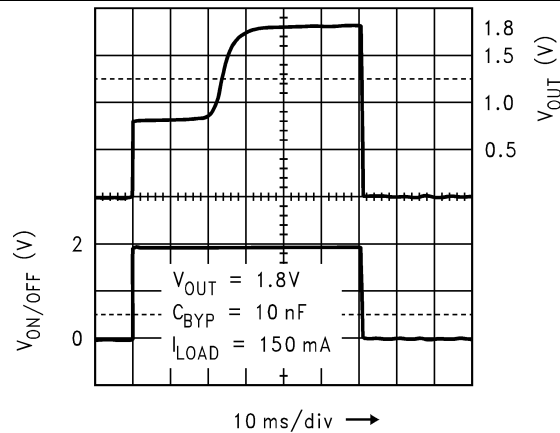

Figure 35. Turnon Time

9 Power Supply Recommendations

The LP2985LV-N is designed to operate from a minimum input supply voltage of either 2.2 V, or $V_{OUT} + V_{DO}$, whichever is higher, up to a maximum input supply voltage of 16 V. However, to ensure that the LP2985LV-N output voltage is well regulated, in specification, and that the dynamic performance is optimum, TI recommends a minimum a minimum input supply voltage of at least $V_{OUT} + 1$ V.

The input supply voltage must be well regulated and free of spurious noise. A minimum capacitor value of 1 μ F to be placed within 1 cm of the IN pin. Any good-quality ceramic, tantalum, or film capacitor may be used at the input.

10 Layout

10.1 Layout Guidelines

For best overall performance, place all circuit components on the same side of the circuit board and as near as practical to the respective LDO pin connections. Place ground return connections to the input and output capacitor, and to the LDO ground pin as close as possible to each other, connected by a wide, component-side, copper surface. The use of vias and long traces to create LDO circuit connections is strongly discouraged and negatively affects system performance. This grounding and layout scheme minimizes inductive parasitics, and thereby reduces load-current transients, minimizes noise, and increases circuit stability.

A ground reference plane is also recommended and is either embedded in the PCB itself or located on the bottom side of the PCB opposite the components. This reference plane serves to assure accuracy of the output voltage, shield noise, and behaves similar to a thermal plane to spread (or sink) heat from the LDO device.

In most applications, this ground plane is necessary to meet thermal requirements.

10.2 Layout Example

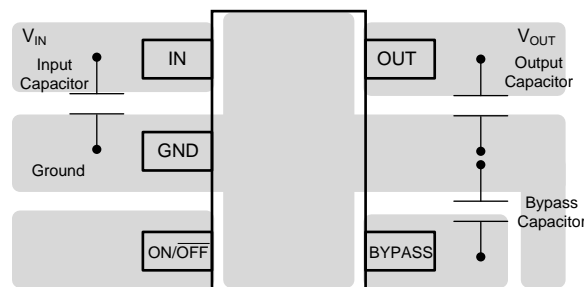

Figure 36. LP2985 SOT-23 Package Typical Layout

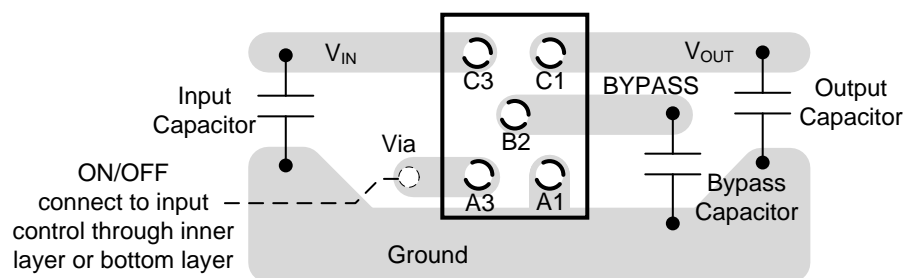

Figure 37. LP2985 DSBGA Package Typical Layout

10.3 DSBGA Mounting

The DSBGA package requires specific mounting techniques which are detailed in [AN-1112 DSBGA Wafer Level Chip Scale Package](#). Referring to the section *Surface Mount Technology (SMT) Assembly Considerations*, note that the pad style which must be used with the 5-pin package is the NSMD (non-solder mask defined) type.

For best results during assembly, alignment ordinals on the PC board may be used to facilitate placement of the DSBGA device.

10.4 DSBGA Light Sensitivity

Exposing the DSBGA device to direct sunlight cause misoperation of the device. Light sources such as Halogen lamps can also affect electrical performance if brought near to the device.

The wavelengths which have the most detrimental effect are reds and infra-reds, which means that the fluorescent lighting used inside most buildings has very little effect on performance. A DSBGA test board was brought to within 1 cm of a fluorescent desk lamp and the effect on the regulated output voltage was negligible, showing a deviation of less than 0.1% from nominal.

11 Device and Documentation Support

11.1 Documentation Support

11.1.1 Related Documentation

For additional information, see the following:

- [AN-1112 DSBGA Wafer Level Chip Scale Package](#)
- [Semiconductor and IC Package Thermal Metrics \(SPRA953\)](#)
- [Using New Thermal Metrics](#)
- [Thermal Characteristics of Linear and Logic Packages Using JEDEC PCB Designs](#)

11.1.2 Receiving Notification of Documentation Updates

To receive notification of documentation updates, navigate to the device product folder on ti.com. In the upper right corner, click on *Alert me* to register and receive a weekly digest of any product information that has changed. For change details, review the revision history included in any revised document.

11.2 Community Resources

The following links connect to TI community resources. Linked contents are provided "AS IS" by the respective contributors. They do not constitute TI specifications and do not necessarily reflect TI's views; see TI's [Terms of Use](#).

TI E2E™ Online Community *TI's Engineer-to-Engineer (E2E) Community*. Created to foster collaboration among engineers. At e2e.ti.com, you can ask questions, share knowledge, explore ideas and help solve problems with fellow engineers.

Design Support *TI's Design Support* Quickly find helpful E2E forums along with design support tools and contact information for technical support.

11.3 Trademarks

E2E is a trademark of Texas Instruments.
All other trademarks are the property of their respective owners.

11.4 Electrostatic Discharge Caution



These devices have limited built-in ESD protection. The leads should be shorted together or the device placed in conductive foam during storage or handling to prevent electrostatic damage to the MOS gates.

11.5 Glossary

SLYZ022 — *TI Glossary*.

This glossary lists and explains terms, acronyms, and definitions.

12 Mechanical, Packaging, and Orderable Information

The following pages include mechanical, packaging, and orderable information. This information is the most current data available for the designated devices. This data is subject to change without notice and revision of this document. For browser-based versions of this data sheet, refer to the left-hand navigation.

PACKAGING INFORMATION

Orderable part number	Status (1)	Material type (2)	Package Pins	Package qty Carrier	RoHS (3)	Lead finish/ Ball material (4)	MSL rating/ Peak reflow (5)	Op temp (°C)	Part marking (6)
LP2985AIM5-1.5/NO.A	Active	Production	SOT-23 (DBV) 5	1000 LARGE T&R	Yes	SN	Level-1-260C-UNLIM	-40 to 125	LCHA
LP2985AIM5-1.5/NOPB	Active	Production	SOT-23 (DBV) 5	1000 LARGE T&R	Yes	SN	Level-1-260C-UNLIM	-40 to 125	LCHA
LP2985AIM5-1.8/NO.A	Active	Production	SOT-23 (DBV) 5	3000 LARGE T&R	Yes	SN	Level-1-260C-UNLIM	-40 to 125	LAYA
LP2985AIM5-1.8/NOPB	Active	Production	SOT-23 (DBV) 5	3000 LARGE T&R	Yes	SN	Level-1-260C-UNLIM	-40 to 125	LAYA
LP2985AIM5-2.0/NO.A	Active	Production	SOT-23 (DBV) 5	1000 LARGE T&R	Yes	SN	Level-1-260C-UNLIM	-40 to 125	LCDA
LP2985AIM5-2.0/NOPB	Active	Production	SOT-23 (DBV) 5	1000 LARGE T&R	Yes	SN	Level-1-260C-UNLIM	-40 to 125	LCDA
LP2985AIM5X-1.8/NO.A	Active	Production	SOT-23 (DBV) 5	3000 LARGE T&R	Yes	SN	Level-1-260C-UNLIM	-40 to 125	LAYA
LP2985AIM5X-1.8/NOPB	Active	Production	SOT-23 (DBV) 5	3000 LARGE T&R	Yes	SN	Level-1-260C-UNLIM	-40 to 125	LAYA
LP2985AIM5X-2.0/NO.A	Active	Production	SOT-23 (DBV) 5	3000 LARGE T&R	Yes	SN	Level-1-260C-UNLIM	-40 to 125	LCDA
LP2985AIM5X-2.0/NOPB	Active	Production	SOT-23 (DBV) 5	3000 LARGE T&R	Yes	SN	Level-1-260C-UNLIM	-40 to 125	LCDA
LP2985IM5-1.8/NOPB	Active	Production	SOT-23 (DBV) 5	3000 LARGE T&R	Yes	NIPDAU SN	Level-1-260C-UNLIM	-40 to 125	LAYB
LP2985IM5-1.8/NOPB.A	Active	Production	SOT-23 (DBV) 5	3000 LARGE T&R	Yes	NIPDAU	Level-1-260C-UNLIM	-40 to 125	LAYB
LP2985IM5-1.8/NOPB.B	Active	Production	SOT-23 (DBV) 5	3000 LARGE T&R	Yes	NIPDAU	Level-1-260C-UNLIM	-40 to 125	LAYB
LP2985IM5-2.0/NOPB	Active	Production	SOT-23 (DBV) 5	1000 LARGE T&R	Yes	SN	Level-1-260C-UNLIM	-40 to 125	LCDB
LP2985IM5-2.0/NOPB.A	Active	Production	SOT-23 (DBV) 5	1000 LARGE T&R	Yes	SN	Level-1-260C-UNLIM	-40 to 125	LCDB
LP2985IM5-2.0/NOPB.B	Active	Production	SOT-23 (DBV) 5	1000 LARGE T&R	Yes	SN	Level-1-260C-UNLIM	-40 to 125	LCDB
LP2985IM5X-1.8/NO.A	Active	Production	SOT-23 (DBV) 5	3000 LARGE T&R	Yes	NIPDAU	Level-1-260C-UNLIM	-40 to 125	LAYB
LP2985IM5X-1.8/NO.B	Active	Production	SOT-23 (DBV) 5	3000 LARGE T&R	Yes	NIPDAU	Level-1-260C-UNLIM	-40 to 125	LAYB
LP2985IM5X-1.8/NOPB	Active	Production	SOT-23 (DBV) 5	3000 LARGE T&R	Yes	NIPDAU SN	Level-1-260C-UNLIM	-40 to 125	LAYB
LP2985IM5X-2.0/NO.A	Active	Production	SOT-23 (DBV) 5	3000 LARGE T&R	Yes	SN	Level-1-260C-UNLIM	-40 to 125	LCDB
LP2985IM5X-2.0/NOPB	Active	Production	SOT-23 (DBV) 5	3000 LARGE T&R	Yes	SN	Level-1-260C-UNLIM	-40 to 125	LCDB

(1) **Status:** For more details on status, see our [product life cycle](#).

(2) **Material type:** When designated, preproduction parts are prototypes/experimental devices, and are not yet approved or released for full production. Testing and final process, including without limitation quality assurance, reliability performance testing, and/or process qualification, may not yet be complete, and this item is subject to further changes or possible discontinuation. If available for ordering, purchases will be subject to an additional waiver at checkout, and are intended for early internal evaluation purposes only. These items are sold without warranties of any kind.

(3) **RoHS values:** Yes, No, RoHS Exempt. See the [TI RoHS Statement](#) for additional information and value definition.

- (4) **Lead finish/Ball material:** Parts may have multiple material finish options. Finish options are separated by a vertical ruled line. Lead finish/Ball material values may wrap to two lines if the finish value exceeds the maximum column width.
- (5) **MSL rating/Peak reflow:** The moisture sensitivity level ratings and peak solder (reflow) temperatures. In the event that a part has multiple moisture sensitivity ratings, only the lowest level per JEDEC standards is shown. Refer to the shipping label for the actual reflow temperature that will be used to mount the part to the printed circuit board.
- (6) **Part marking:** There may be an additional marking, which relates to the logo, the lot trace code information, or the environmental category of the part.

Multiple part markings will be inside parentheses. Only one part marking contained in parentheses and separated by a "~" will appear on a part. If a line is indented then it is a continuation of the previous line and the two combined represent the entire part marking for that device.

Important Information and Disclaimer: The information provided on this page represents TI's knowledge and belief as of the date that it is provided. TI bases its knowledge and belief on information provided by third parties, and makes no representation or warranty as to the accuracy of such information. Efforts are underway to better integrate information from third parties. TI has taken and continues to take reasonable steps to provide representative and accurate information but may not have conducted destructive testing or chemical analysis on incoming materials and chemicals. TI and TI suppliers consider certain information to be proprietary, and thus CAS numbers and other limited information may not be available for release.

In no event shall TI's liability arising out of such information exceed the total purchase price of the TI part(s) at issue in this document sold by TI to Customer on an annual basis.

TAPE AND REEL INFORMATION

QUADRANT ASSIGNMENTS FOR PIN 1 ORIENTATION IN TAPE

*All dimensions are nominal

Device	Package Type	Package Drawing	Pins	SPQ	Reel Diameter (mm)	Reel Width W1 (mm)	A0 (mm)	B0 (mm)	K0 (mm)	P1 (mm)	W (mm)	Pin1 Quadrant
LP2985AIM5-1.5/NOPB	SOT-23	DBV	5	1000	178.0	8.4	3.2	3.2	1.4	4.0	8.0	Q3
LP2985AIM5-1.8/NOPB	SOT-23	DBV	5	3000	180.0	8.4	3.2	3.2	1.4	4.0	8.0	Q3
LP2985AIM5-2.0/NOPB	SOT-23	DBV	5	1000	178.0	8.4	3.2	3.2	1.4	4.0	8.0	Q3
LP2985AIM5X-1.8/NOPB	SOT-23	DBV	5	3000	178.0	8.4	3.2	3.2	1.4	4.0	8.0	Q3
LP2985AIM5X-1.8/NOPB	SOT-23	DBV	5	3000	180.0	8.4	3.2	3.2	1.4	4.0	8.0	Q3
LP2985AIM5X-2.0/NOPB	SOT-23	DBV	5	3000	178.0	8.4	3.2	3.2	1.4	4.0	8.0	Q3
LP2985IM5-1.8/NOPB	SOT-23	DBV	5	3000	178.0	8.4	3.2	3.2	1.4	4.0	8.0	Q3
LP2985IM5-2.0/NOPB	SOT-23	DBV	5	1000	178.0	8.4	3.2	3.2	1.4	4.0	8.0	Q3
LP2985IM5X-1.8/NOPB	SOT-23	DBV	5	3000	178.0	8.4	3.2	3.2	1.4	4.0	8.0	Q3
LP2985IM5X-2.0/NOPB	SOT-23	DBV	5	3000	178.0	8.4	3.2	3.2	1.4	4.0	8.0	Q3

TAPE AND REEL BOX DIMENSIONS

*All dimensions are nominal

Device	Package Type	Package Drawing	Pins	SPQ	Length (mm)	Width (mm)	Height (mm)
LP2985AIM5-1.5/NOPB	SOT-23	DBV	5	1000	208.0	191.0	35.0
LP2985AIM5-1.8/NOPB	SOT-23	DBV	5	3000	210.0	185.0	35.0
LP2985AIM5-2.0/NOPB	SOT-23	DBV	5	1000	208.0	191.0	35.0
LP2985AIM5X-1.8/NOPB	SOT-23	DBV	5	3000	208.0	191.0	35.0
LP2985AIM5X-1.8/NOPB	SOT-23	DBV	5	3000	210.0	185.0	35.0
LP2985AIM5X-2.0/NOPB	SOT-23	DBV	5	3000	208.0	191.0	35.0
LP2985IM5-1.8/NOPB	SOT-23	DBV	5	3000	208.0	191.0	35.0
LP2985IM5-2.0/NOPB	SOT-23	DBV	5	1000	208.0	191.0	35.0
LP2985IM5X-1.8/NOPB	SOT-23	DBV	5	3000	208.0	191.0	35.0
LP2985IM5X-2.0/NOPB	SOT-23	DBV	5	3000	208.0	191.0	35.0

EXAMPLE BOARD LAYOUT

DBV0005A

SOT-23 - 1.45 mm max height

SMALL OUTLINE TRANSISTOR



LAND PATTERN EXAMPLE
EXPOSED METAL SHOWN
SCALE:15X



SOLDER MASK DETAILS

4214839/K 08/2024

NOTES: (continued)

- 6. Publication IPC-7351 may have alternate designs.
- 7. Solder mask tolerances between and around signal pads can vary based on board fabrication site.

EXAMPLE STENCIL DESIGN

DBV0005A

SOT-23 - 1.45 mm max height

SMALL OUTLINE TRANSISTOR



SOLDER PASTE EXAMPLE
BASED ON 0.125 mm THICK STENCIL
SCALE:15X

4214839/K 08/2024

NOTES: (continued)

8. Laser cutting apertures with trapezoidal walls and rounded corners may offer better paste release. IPC-7525 may have alternate design recommendations.
9. Board assembly site may have different recommendations for stencil design.

IMPORTANT NOTICE AND DISCLAIMER

TI PROVIDES TECHNICAL AND RELIABILITY DATA (INCLUDING DATASHEETS), DESIGN RESOURCES (INCLUDING REFERENCE DESIGNS), APPLICATION OR OTHER DESIGN ADVICE, WEB TOOLS, SAFETY INFORMATION, AND OTHER RESOURCES "AS IS" AND WITH ALL FAULTS, AND DISCLAIMS ALL WARRANTIES, EXPRESS AND IMPLIED, INCLUDING WITHOUT LIMITATION ANY IMPLIED WARRANTIES OF MERCHANTABILITY, FITNESS FOR A PARTICULAR PURPOSE OR NON-INFRINGEMENT OF THIRD PARTY INTELLECTUAL PROPERTY RIGHTS.

These resources are intended for skilled developers designing with TI products. You are solely responsible for (1) selecting the appropriate TI products for your application, (2) designing, validating and testing your application, and (3) ensuring your application meets applicable standards, and any other safety, security, regulatory or other requirements.

These resources are subject to change without notice. TI grants you permission to use these resources only for development of an application that uses the TI products described in the resource. Other reproduction and display of these resources is prohibited. No license is granted to any other TI intellectual property right or to any third party intellectual property right. TI disclaims responsibility for, and you fully indemnify TI and its representatives against any claims, damages, costs, losses, and liabilities arising out of your use of these resources.

TI's products are provided subject to [TI's Terms of Sale](#), [TI's General Quality Guidelines](#), or other applicable terms available either on ti.com or provided in conjunction with such TI products. TI's provision of these resources does not expand or otherwise alter TI's applicable warranties or warranty disclaimers for TI products. Unless TI explicitly designates a product as custom or customer-specified, TI products are standard, catalog, general purpose devices.

TI objects to and rejects any additional or different terms you may propose.

Copyright © 2026, Texas Instruments Incorporated

Last updated 10/2025