

LP2992 Micropower, 250mA, Low-Noise, Ultra-Low-Dropout Regulator in SOT-23 and WSON Packages Designed for Use With Very Low-ESR Output Capacitors

1 Features

- V_{IN} range (new chip): 2.5V to 16V
- V_{OUT} range (new chip):
 - 1.2V to 5.0V (fixed, 100mV steps)
- V_{OUT} accuracy:
 - $\pm 1\%$ for A-grade legacy chip
 - $\pm 1.5\%$ for standard-grade legacy chip
 - $\pm 0.5\%$ for new chip
- $\pm 1\%$ output accuracy over load, and temperature (new chip)
- Output current: Up to 250mA
- Low I_Q (new chip): 69 μ A at $I_{LOAD} = 0$ mA
- Low I_Q (new chip): 875 μ A at $I_{LOAD} = 250$ mA
- Shutdown current:
 - 0.01 μ A (typ, legacy chip)
 - 1.12 μ A (typ, new chip)
- Low noise: 30 μ V_{RMS} with 10nF bypass capacitor
- Output current limiting and thermal protection
- Stable with 2.2 μ F ceramic capacitors
- High PSRR: 70dB at 1kHz, 40dB at 1MHz
- Operating junction temperature: -40° C to $+125^{\circ}$ C
- Package: 5-pin SOT-23 (DBV)

2 Applications

- Washers and dryers
- Land mobile radios
- Active antenna system mMIMO
- Cordless power tools
- Motor drives and control boards

3 Description

The LP2992 is a fixed-output, wide-input, low-noise, low-dropout voltage regulator supporting an input voltage range from 2.5V to 16V and up to 250mA of load current. The LP2992 supports an output range of 1.2V to 5.0V (new chip).

Additionally, the LP2992 (new chip) has a 1% output accuracy across load, and temperature that can meet the needs of low-voltage microcontrollers (MCUs) and processors.

Low output noise of 30 μ V_{RMS} (with 10nF bypass capacitors) and wide bandwidth PSRR performance of greater than 70dB at 1kHz and 40dB at 1MHz help attenuate the switching frequency of an upstream DC/DC converter and minimize post regulator filtering.

The internal soft-start time and current limit protection reduce inrush current during start up, thus minimizing input capacitance. Standard protection features, such as overcurrent and overtemperature protection, are included.

The LP2992 is available in a 5-pin 2.9mm \times 2.8mm SOT-23 (DBV) package.

Package Information

PART NUMBER	PACKAGE ⁽¹⁾	PACKAGE SIZE ⁽²⁾
LP2992	DBV (SOT-23, 5)	2.9mm \times 2.8mm
	NGD (WSON, 6)	2.92mm \times 3.29mm

- (1) For more information, see the [Mechanical, Packaging, and Orderable Information](#).
- (2) The package size (length \times width) is a nominal value and includes pins, where applicable.

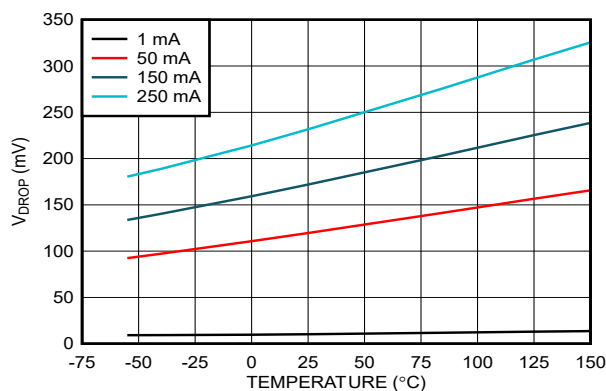

Dropout Voltage vs Temperature for New Chip

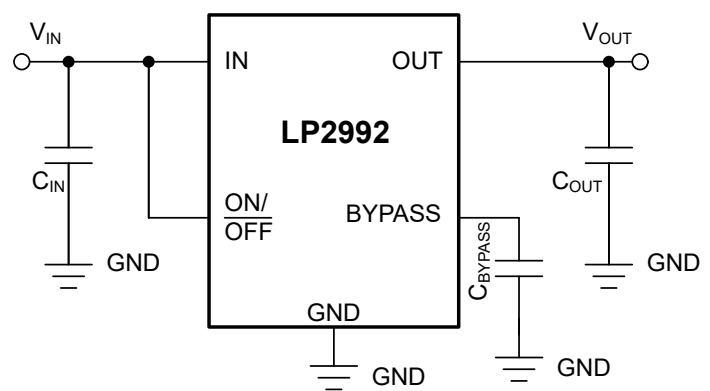

Typical Application Circuit



Table of Contents

1 Features	1	7 Application and Implementation	22
2 Applications	1	7.1 Application Information.....	22
3 Description	1	7.2 Typical Application.....	25
4 Pin Configuration and Functions	3	7.3 Power Supply Recommendations.....	27
5 Specifications	4	7.4 Layout.....	28
5.1 Absolute Maximum Ratings.....	4	8 Device and Documentation Support	29
5.2 ESD Ratings.....	4	8.1 Device Nomenclature.....	29
5.3 Recommended Operating Conditions.....	4	8.2 Documentation Support.....	29
5.4 Thermal Information.....	5	8.3 Receiving Notification of Documentation Updates....	29
5.5 Electrical Characteristics.....	5	8.4 Support Resources.....	29
5.6 Typical Characteristics.....	8	8.5 Trademarks.....	29
6 Detailed Description	18	8.6 Electrostatic Discharge Caution.....	29
6.1 Overview.....	18	8.7 Glossary.....	29
6.2 Functional Block Diagram.....	18	9 Revision History	30
6.3 Feature Description.....	18	10 Mechanical, Packaging, and Orderable Information	30
6.4 Device Functional Modes.....	21		

4 Pin Configuration and Functions

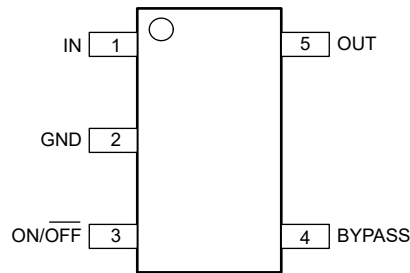

Figure 4-1. DBV Package, 5-Pin SOT-23 (Top View)

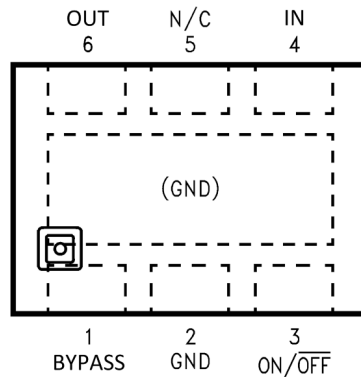

Figure 4-2. NGD Package, 6-Pin WSON (Top View) (Legacy Chip)

Table 4-1. Pin Functions

NAME	PIN		TYPE	DESCRIPTION
	DBV	NGD (Legacy chip only)		
BYPASS	4	1	I	BYPASS pin to achieve low noise performance. Connecting an external capacitor between BYPASS pin and ground reduces reference voltage noise. See the Recommended Operating Conditions table for more information.
GND	2	2	—	Ground
ON/OFF	3	3	I	Enable pin for the LDO. Driving the ON/OFF pin high enables the device. Driving this pin low disables the device. High and low thresholds are listed in the Electrical Characteristics table. Tie this pin to V_{IN} if unused.
IN	1	4	I	Input supply pin. Use a capacitor with a value of 1 μ F or larger from this pin to ground. See the Input and Output Capacitor Requirements section for more information.
OUT	5	6	O	Output of the regulator. Use a capacitor with a value of 2.2 μ F or larger from this pin to ground ⁽¹⁾ . See the Input and Output Capacitor Requirements section for more information.
N/C	—	5	—	No internal connection. Connect to GND or leave open. (Legacy chip only)
DAP	—	Exposed thermal pad	—	The exposed die attach pad on the bottom of the package must be connected to a copper thermal pad on the PCB at ground potential. Connect to ground potential or leave floating. Do not connect to any potential other than the same ground potential seen at device pin 2. (Legacy chip only)

(1) The nominal output capacitance must be greater than 1 μ F. Throughout this document, the nominal derating on these capacitors is 50%. Make sure that the effective capacitance at the pin is greater than 1 μ F.

5 Specifications

5.1 Absolute Maximum Ratings

over operating free-air temperature range (unless otherwise noted)⁽¹⁾ ⁽²⁾

		MIN	MAX	UNIT
V _{IN}	Continuous input voltage range (for legacy chip)	-0.3	16	V
	Continuous input voltage range (for new chip)	-0.3	18	
V _{OUT}	Output voltage range (for legacy chip)	-0.3	9	V
	Output voltage range (for new chip)	-0.3	V _{IN} + 0.3 or 9 (whichever is smaller)	
V _{BYPASS}	BYPASS pin voltage range (for new chip)	-0.3	3	V
V _{ON/OFF}	ON/OFF pin voltage range (for legacy chip)	-0.3	16	V
	ON/OFF pin voltage range (for new chip)	-0.3	18	
Current	Maximum output	Internally limited		A
Temperature	Operating junction, T _J	-55	150	°C
	Storage, T _{stg}	-65	150	

- Operation outside the Absolute Maximum Ratings may cause permanent device damage. Absolute Maximum Ratings do not imply functional operation of the device at these or any other conditions beyond those listed under Recommended Operating Conditions. If used outside the Recommended Operating Conditions but within the Absolute Maximum Ratings, the device may not be fully functional, and this may affect device reliability, functionality, performance, and shorten the device lifetime.
- All voltages with respect to GND.

5.2 ESD Ratings

			VALUE (Legacy Chip)	VALUE (New Chip)	UNIT
V _(ESD)	Electrostatic discharge	Human body model (HBM), per ANSI/ESDA/JEDEC JS-001 ⁽¹⁾	±2000	±3000	V
		Charged device model (CDM), per JEDEC specification JESD22-C101 ⁽²⁾	±500	±1000	

- JEDEC document JEP155 states that 2-kV HBM allows safe manufacturing with a standard ESD control process.
- JEDEC document JEP157 states that 500-V CDM allows safe manufacturing with a standard ESD control process.

5.3 Recommended Operating Conditions

		MIN	NOM	MAX	UNIT
V _{IN}	Supply input voltage (for legacy chip)	2.2		16	V
	Supply input voltage (for new chip)	2.5		16	
V _{OUT}	Output voltage (for legacy chip)	1.2		10.0	V
	Output voltage (for new chip)	1.2		5.0	
V _{BYPASS}	Bypass voltage		1.2		V
V _{ON/OFF}	Enable voltage (for legacy chip)	0		V _{IN}	V
	Enable voltage (for new chip)	0		16	
I _{OUT}	Output current	0		250	mA
C _{IN} ⁽¹⁾	Input capacitor		1		μF
C _{OUT}	Output capacitance (for legacy chip)	2.2	4.7		μF
	Output capacitance (for new chip) ⁽¹⁾	1	2.2	200	
C _{OUT} ESR ⁽³⁾	Output capacitor ESR (for new chip) ⁽²⁾	0		1	Ω
T _J	Operating junction temperature	-40		125	°C

- All capacitor values are assumed to derate to 50% of the nominal capacitor value. Maintain an effective output capacitance of 1 μF minimum for stability.
- Details related to supported ESR range for the legacy chip are available in *Recommended Capacitors for the Legacy Chip*.
- Maximum supported ESR range for new chip is 1 Ω. For output capacitor with higher ESR values, place a low ESR MLCC capacitor with value of 100nF, close to the output pin of the LDO.

5.4 Thermal Information

THERMAL METRIC ⁽²⁾ ⁽¹⁾		Legacy Chip Only	Legacy Chip	New Chip	UNIT
		NGD (WSON) ⁽³⁾	DBV (SOT23-5)	DBV (SOT23-5)	
		6 PINS	5 PINS	5 PINS	
R _{θJA}	Junction-to-ambient thermal resistance	72.3	169.7	178.6	°C/W
R _{θJC(top)}	Junction-to-case (top) thermal resistance	81.6	122.6	77.9	°C/W
R _{θJB}	Junction-to-board thermal resistance	39.5	29.9	47.2	°C/W
Ψ _{JT}	Junction-to-top characterization parameter	2	16.7	15.9	°C/W
Ψ _{JB}	Junction-to-board characterization parameter	39.2	29.4	46.9	°C/W
R _{θJC(bot)}	Junction-to-case (bottom) thermal resistance	11.6	–	–	°C/W

- (1) For more information about traditional and new thermal metrics, see the [Semiconductor and IC Package Thermal Metrics](#) application note.
- (2) Thermal performance results are based on the JEDEC standard of 2s2p PCB configuration. These thermal metric parameters can be further improved by 35-55% based on thermally optimized PCB layout designs. See the analysis of the [Impact of board layout on LDO thermal performance](#) application report.
- (3) The PCB for the NGD (WSON) package R_{θJA} includes two (2) thermal vias under the exposed thermal pad per EIA/JEDEC JESD51-5.

5.5 Electrical Characteristics

specified at T_J = 25°C, V_{IN} = V_{OUT(nom)} + 1.0 V or V_{IN} = 2.5 V (whichever is greater), I_{OUT} = 1 mA, V_{ON/OFF} = 2 V, C_{IN} = 1.0 μF, and C_{OUT} = 2.2 μF (unless otherwise noted)

PARAMETER		TEST CONDITIONS		MIN	TYP	MAX	UNIT
ΔV _{OUT}	Output voltage tolerance	I _L = 1 mA	Legacy chip (standard grade)	-1.5		1.5	%
			Legacy chip (A grade)	-1.0		1.0	
			New chip	-0.5		0.5	
		1 mA ≤ I _L ≤ 50 mA	Legacy chip (standard grade)	-2.5		2.5	
			Legacy chip (A grade)	-1.5		1.5	
			New chip	-0.5		0.5	
		1 mA ≤ I _L ≤ 50 mA, -40°C ≤ T _J ≤ 125°C	Legacy chip (standard grade)	-3.5		3.5	
			Legacy chip (A grade)	-2.5		2.5	
			New chip	-1		1	
		1 mA ≤ I _L ≤ 250 mA	Legacy chip (standard grade)	-4		4	
			Legacy chip (A grade)	-3.5		3.5	
			New chip	-0.5		0.5	
1 mA ≤ I _L ≤ 250 mA, -40°C ≤ T _J ≤ 125°C	Legacy chip (standard grade)	-5		5			
	Legacy chip (A grade)	-4.5		4.5			
	New chip	-1		1			

5.5 Electrical Characteristics (continued)

specified at $T_J = 25^\circ\text{C}$, $V_{IN} = V_{OUT(nom)} + 1.0\text{ V}$ or $V_{IN} = 2.5\text{ V}$ (whichever is greater), $I_{OUT} = 1\text{ mA}$, $V_{ON/OFF} = 2\text{ V}$, $C_{IN} = 1.0\text{ }\mu\text{F}$, and $C_{OUT} = 2.2\text{ }\mu\text{F}$ (unless otherwise noted)

PARAMETER		TEST CONDITIONS	MIN	TYP	MAX	UNIT
$\Delta V_{OUT(\Delta V_{IN})}$	Line regulation	$V_{O(NOM)} + 1\text{ V} \leq V_{IN} \leq 16\text{ V}$	Legacy chip	0.007	0.014	%V
			New chip	0.002	0.014	
		$V_{O(NOM)} + 1\text{ V} \leq V_{IN} \leq 16\text{ V}, -40^\circ\text{C} \leq T_J \leq 125^\circ\text{C}$	Legacy chip	0.007	0.032	
			New chip	0.002	0.032	
$V_{IN(MIN)}$	Minimum input voltage required to maintain output regulation	$-40^\circ\text{C} \leq T_J \leq 125^\circ\text{C}$	Legacy chip	2.05		V
			New chip	2.05		
	Minimum input voltage required to maintain output regulation		Legacy chip		2.2	
			New chip		2.35	
I_{GND}	GND pin current	$I_{OUT} = 0\text{ mA}$	Legacy chip	65	95	μA
			New chip	69	95	
		$I_{OUT} = 0\text{ mA}, -40^\circ\text{C} \leq T_J \leq 125^\circ\text{C}$	Legacy chip		125	
			New chip		123	
		$I_{OUT} = 1\text{ mA}$	Legacy chip	75	110	
			New chip	78	110	
		$I_{OUT} = 1\text{ mA}, -40^\circ\text{C} \leq T_J \leq 125^\circ\text{C}$	Legacy chip		170	
			New chip		140	
		$I_{OUT} = 50\text{ mA}$	Legacy chip	350	600	
			New chip	380	440	
		$I_{OUT} = 50\text{ mA}, -40^\circ\text{C} \leq T_J \leq 125^\circ\text{C}$	Legacy chip		1000	
			New chip		650	
		$I_{OUT} = 150\text{ mA}$	Legacy chip	850	1500	
			New chip	765	890	
		$I_{OUT} = 150\text{ mA}, -40^\circ\text{C} \leq T_J \leq 125^\circ\text{C}$	Legacy chip		2500	
			New chip		1060	
		$I_{OUT} = 250\text{ mA}$	Legacy Chip	1500	2300	
			New Chip	875	1010	
		$I_{OUT} = 250\text{ mA}, -40^\circ\text{C} \leq T_J \leq 125^\circ\text{C}$	Legacy Chip		4000	
			New Chip		1200	
$V_{ON/OFF} < 0.3\text{ V}, V_{IN} = 16\text{ V}$	Legacy chip	0.01	0.8			
	New chip	1.25	1.75			
$V_{ON/OFF} < 0.15\text{ V}, V_{IN} = 16\text{ V}, -40^\circ\text{C} \leq T_J \leq 125^\circ\text{C}$	Legacy chip	0.05	2			
	New chip	1.12	2.75			

5.5 Electrical Characteristics (continued)

specified at $T_J = 25^\circ\text{C}$, $V_{IN} = V_{OUT(nom)} + 1.0\text{ V}$ or $V_{IN} = 2.5\text{ V}$ (whichever is greater), $I_{OUT} = 1\text{ mA}$, $V_{ON/OFF} = 2\text{ V}$, $C_{IN} = 1.0\ \mu\text{F}$, and $C_{OUT} = 2.2\ \mu\text{F}$ (unless otherwise noted)

PARAMETER		TEST CONDITIONS	MIN	TYP	MAX	UNIT	
V_{DO}	Dropout voltage ⁽¹⁾	$I_{OUT} = 0\text{ mA}$	Legacy chip	0.5	2.5	mV	
			New chip	1	2.75		
		$I_{OUT} = 0\text{ mA}, -40^\circ\text{C} \leq T_J \leq 125^\circ\text{C}$	Legacy chip		4		
			New chip		3		
		$I_{OUT} = 1\text{ mA}$	Legacy chip	5	9		
			New chip	11.5	14		
		$I_{OUT} = 1\text{ mA}, -40^\circ\text{C} \leq T_J \leq 125^\circ\text{C}$	Legacy chip		12		
			New chip		17		
		$I_{OUT} = 50\text{ mA}$	Legacy chip	100	125		
			New chip	120	145		
		$I_{OUT} = 50\text{ mA}, -40^\circ\text{C} \leq T_J \leq 125^\circ\text{C}$	Legacy chip		180		
			New chip		184		
		$I_{OUT} = 150\text{ mA}$	Legacy chip	260	325		
			New chip	180	198		
$I_{OUT} = 150\text{ mA}, -40^\circ\text{C} \leq T_J \leq 125^\circ\text{C}$	Legacy chip		470				
	New chip		254				
$I_{OUT} = 250\text{ mA}$	Legacy chip	450	575				
	New chip	225	260				
$I_{OUT} = 250\text{ mA}, -40^\circ\text{C} \leq T_J \leq 125^\circ\text{C}$	Legacy chip		850				
	New chip		340				
$V_{ON/OFF}$	ON/OFF input voltage	Low = Output OFF	Legacy chip	0.55		V	
			New chip	0.72			
		Low = Output OFF, $V_{OUT} + 1 \leq V_{IN} \leq 16\text{ V}, -40^\circ\text{C} \leq T_J \leq 125^\circ\text{C}$	Legacy chip		0.15		
			New chip		0.15		
		High = Output ON	Legacy chip	1.4			
			New chip	0.85			
		High = Output ON, $V_{OUT} + 1 \leq V_{IN} \leq 16\text{ V}, -40^\circ\text{C} \leq T_J \leq 125^\circ\text{C}$	Legacy chip	1.6			
			New chip	1.6			
$I_{ON/OFF}$	ON/OFF input current	$V_{ON/OFF} = 0\text{ V}, V_{OUT} + 1 \leq V_{IN} \leq 16\text{ V}, -40^\circ\text{C} \leq T_J \leq 125^\circ\text{C}$	Legacy chip		-2	μA	
			New chip		-0.9		
$I_{ON/OFF}$	ON/OFF input current	$V_{ON/OFF} = 0\text{ V}$	Legacy chip	0.01		μA	
			New chip	0.42			
IO(PK)	Peak output current	$V_{OUT} \geq V_{O(NOM)} - 5\%$ (steady state)	Legacy chip	300	350	mA	
			New chip	300	350		
$I_{O(SC)}$	Short output current	$R_L = 0\ \Omega$ (steady state)	Legacy chip	400		mA	
			New chip	375			
$\Delta V_O/\Delta V_{IN}$	Ripple rejection	$f = 1\text{ kHz}, C_{BYPASS} = 10\text{ nF}, C_{OUT} = 10\ \mu\text{F}$	Legacy chip	45		dB	
			New chip	78			
V_n	Output noise voltage	Bandwidth = 300 Hz to 50 kHz, $C_{BYPASS} = 10\text{ nF}, C_{OUT} = 2.2\ \mu\text{F}, V_{OUT} = 3.3\text{ V}$	Legacy chip	30		μVRMS	
			New chip	30			

(1) Dropout voltage (V_{DO}) is defined as the input-to-output differential at which the output voltage drops 100 mV below the value measured with a 1 V differential. V_{DO} is measured with $V_{IN} = V_{OUT(nom)} - 100\text{ mV}$ for fixed output devices.

5.6 Typical Characteristics

$C_{IN} = 1\mu F$, $C_{OUT} = 4.7\mu F$, $V_{IN} = V_{OUT(NOM)} + 1V$, $T_A = 25^\circ C$, and ON/OFF pin is tied to the IN pin (unless otherwise noted)

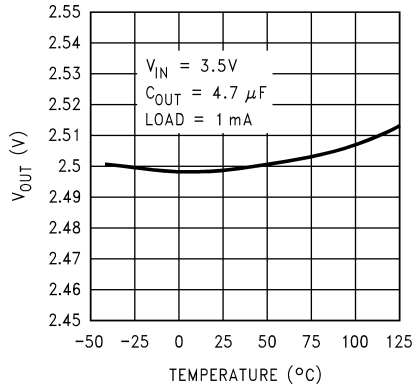

Figure 5-1. V_{OUT} vs Temperature (Legacy Chip)

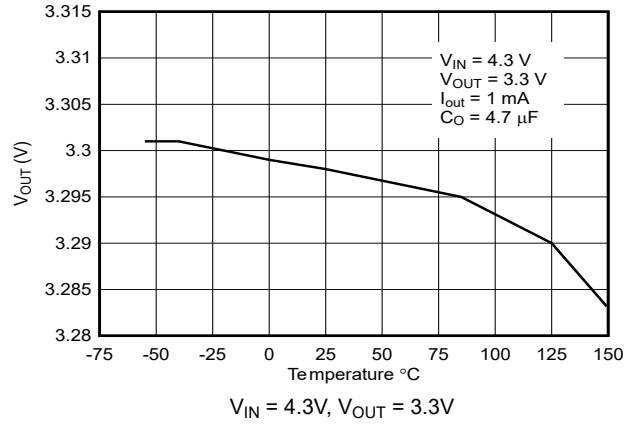

Figure 5-2. V_{OUT} vs Temperature (New Chip)

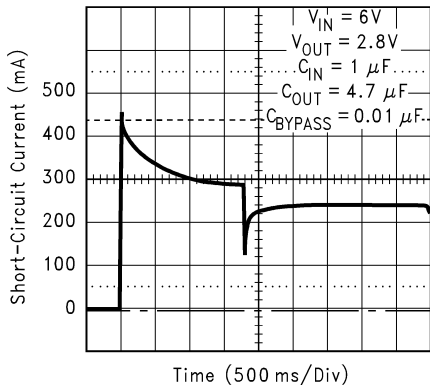

Figure 5-3. Short-Circuit Current (Legacy Chip)

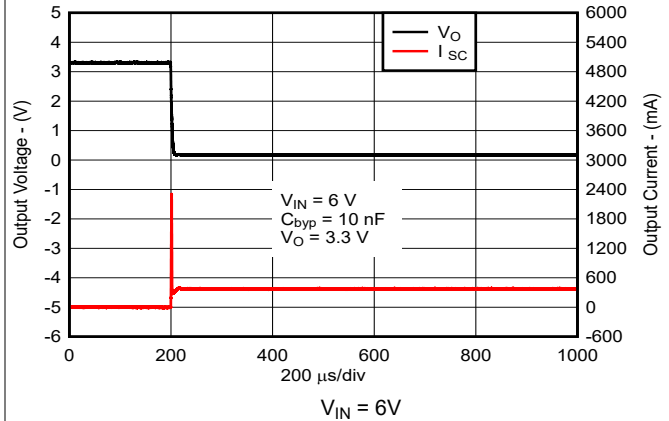

Figure 5-4. Short-Circuit Current vs Time (New Chip)

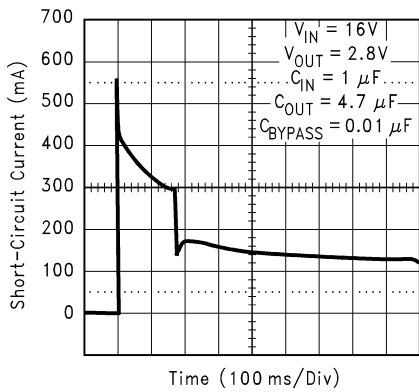

Figure 5-5. Short-Circuit Current (Legacy Chip)

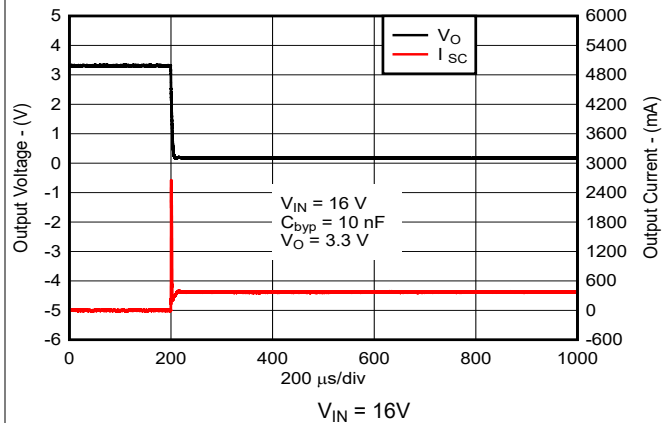

Figure 5-6. Short-Circuit Current vs Time (New Chip)

5.6 Typical Characteristics (continued)

$C_{IN} = 1\mu\text{F}$, $C_{OUT} = 4.7\mu\text{F}$, $V_{IN} = V_{OUT(NOM)} + 1\text{V}$, $T_A = 25^\circ\text{C}$, and ON/OFF pin is tied to the IN pin (unless otherwise noted)

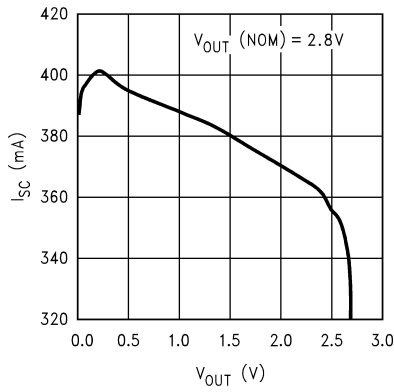

Figure 5-7. Short-Circuit Current vs Output Voltage (Legacy Chip)

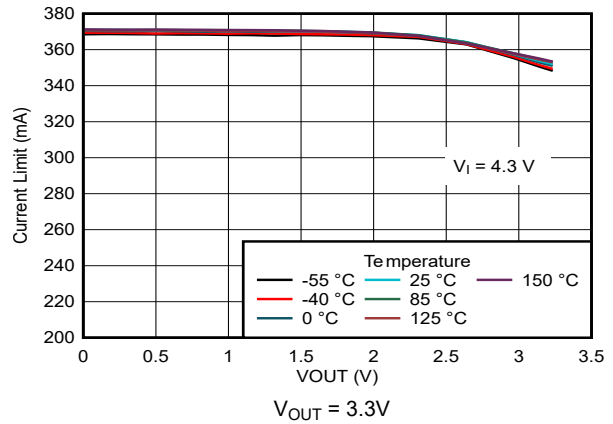

Figure 5-8. Short-Circuit Current vs Output Voltage (New Chip)

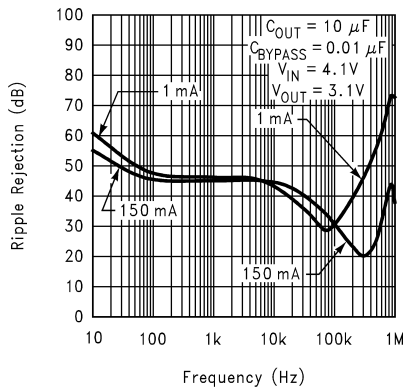

Figure 5-9. Ripple Rejection vs Frequency (Legacy Chip)

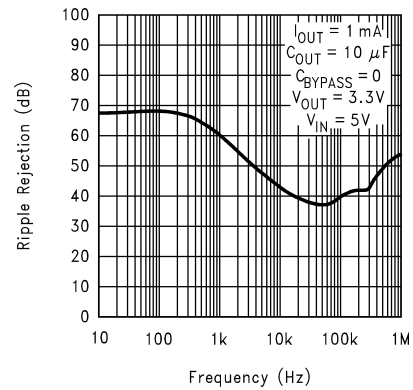

Figure 5-10. Ripple Rejection vs Frequency (Legacy Chip)

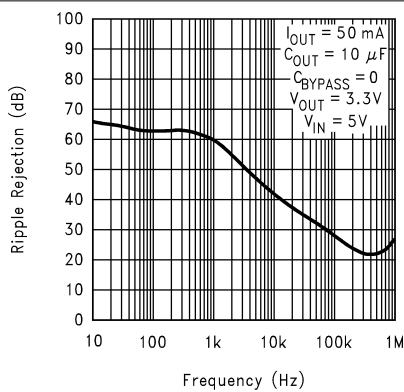

Figure 5-11. Ripple Rejection vs Frequency (Legacy Chip)

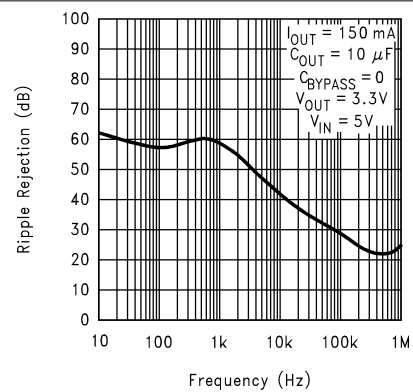
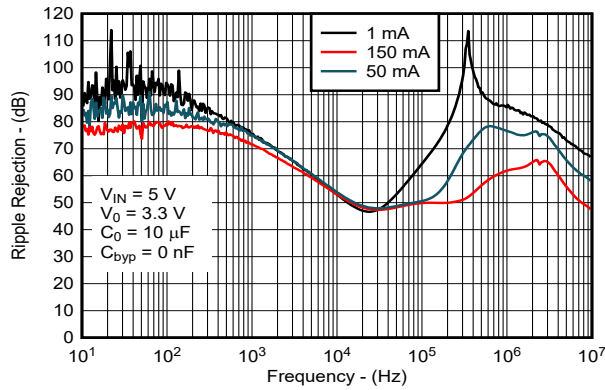

Figure 5-12. Ripple Rejection vs Frequency (Legacy Chip)

5.6 Typical Characteristics (continued)

$C_{IN} = 1\mu\text{F}$, $C_{OUT} = 4.7\mu\text{F}$, $V_{IN} = V_{OUT(NOM)} + 1\text{V}$, $T_A = 25^\circ\text{C}$, and ON/OFF pin is tied to the IN pin (unless otherwise noted)



$V_{IN} = 5\text{V}$, $V_{OUT} = 3.3\text{V}$, $C_{OUT} = 10\mu\text{F}$, $C_{BYP} = 0\text{nF}$

Figure 5-13. Ripple Rejection vs Frequency (New Chip)

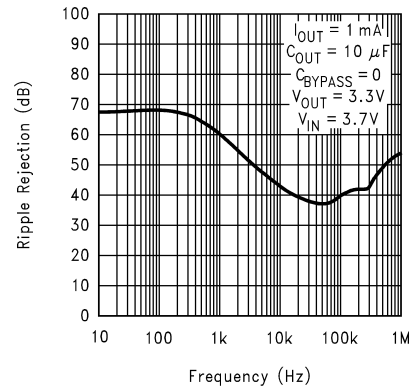

Figure 5-14. Ripple Rejection vs Frequency (Legacy Chip)

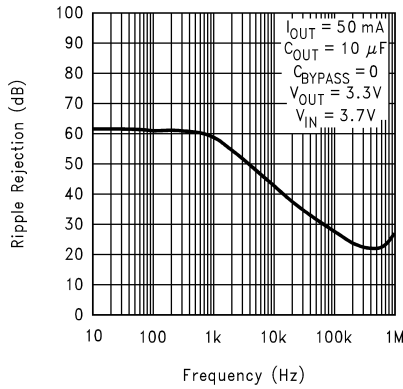

Figure 5-15. Ripple Rejection vs Frequency (Legacy Chip)

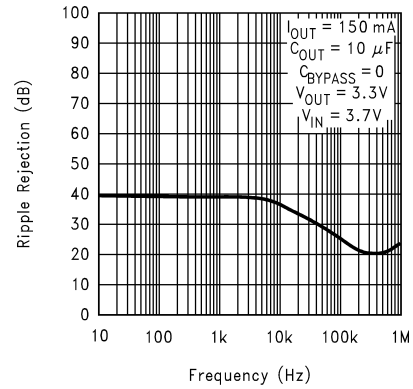
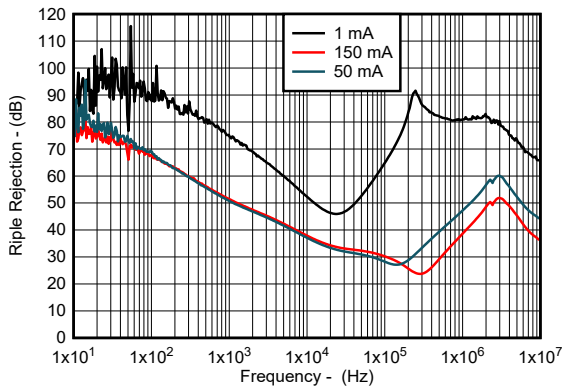

Figure 5-16. Ripple Rejection vs Frequency (Legacy Chip)



$V_{IN} = 3.7\text{V}$, $V_{OUT} = 3.3\text{V}$, $C_{OUT} = 10\mu\text{F}$, $C_{BYP} = 0\text{nF}$

Figure 5-17. Ripple Rejection vs Frequency (New Chip)

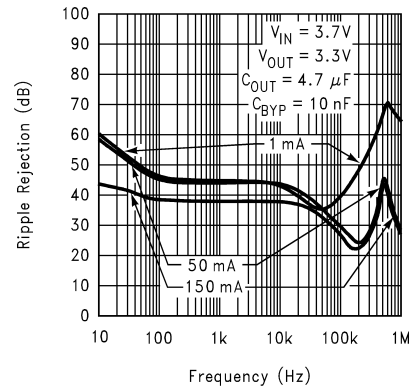

Figure 5-18. Ripple Rejection vs Frequency (Legacy Chip)

5.6 Typical Characteristics (continued)

$C_{IN} = 1\mu\text{F}$, $C_{OUT} = 4.7\mu\text{F}$, $V_{IN} = V_{OUT(NOM)} + 1\text{V}$, $T_A = 25^\circ\text{C}$, and ON/OFF pin is tied to the IN pin (unless otherwise noted)

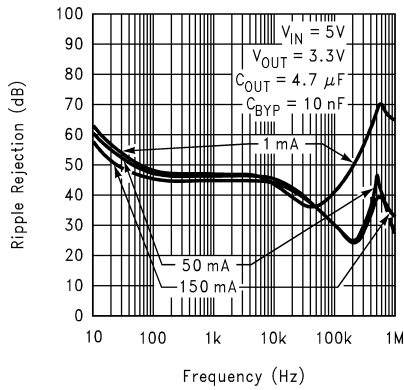

Figure 5-19. Ripple Rejection vs Frequency (Legacy Chip)

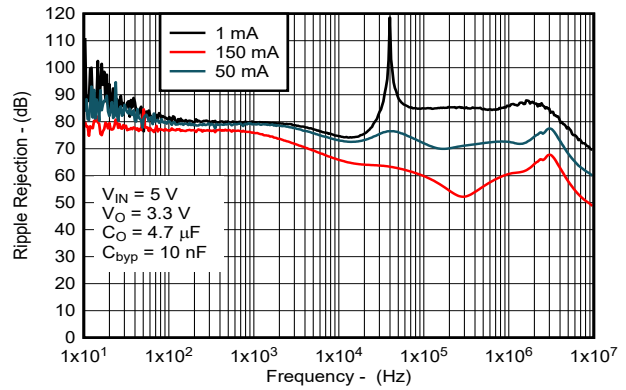

Figure 5-20. Ripple Rejection vs Frequency (New Chip)

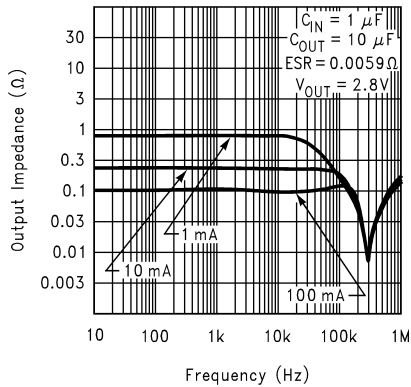

Figure 5-21. Output Impedance vs Frequency (Legacy Chip)

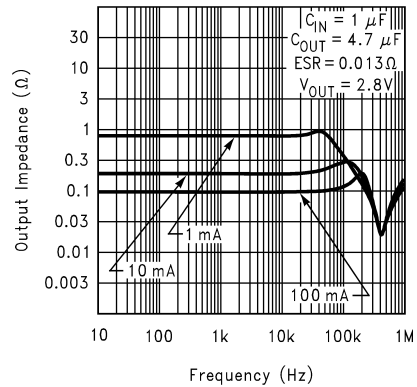

Figure 5-22. Output Impedance vs Frequency (Legacy Chip)

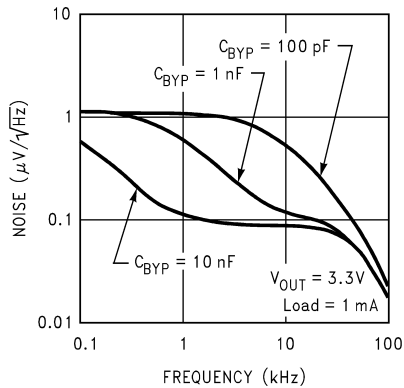

Figure 5-23. Output Noise Density (Legacy Chip)

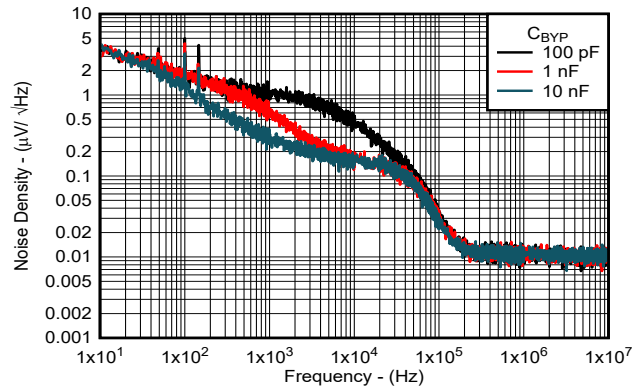

Figure 5-24. Output Noise Density vs Frequency (New Chip)

5.6 Typical Characteristics (continued)

$C_{IN} = 1\mu F$, $C_{OUT} = 4.7\mu F$, $V_{IN} = V_{OUT(NOM)} + 1V$, $T_A = 25^\circ C$, and ON/OFF pin is tied to the IN pin (unless otherwise noted)

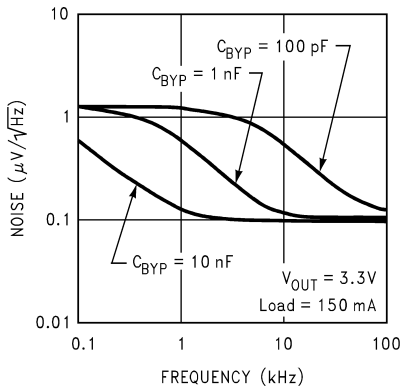

Figure 5-25. Output Noise Density (Legacy Chip)

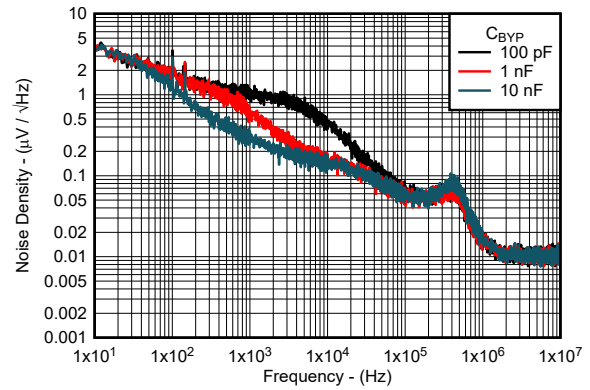

Figure 5-26. Output Noise Density vs Frequency (New Chip)

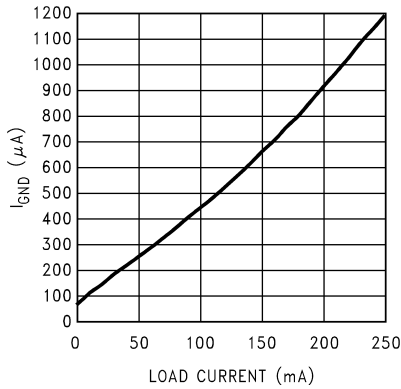

Figure 5-27. GND Pin vs Load Current (Legacy Chip)

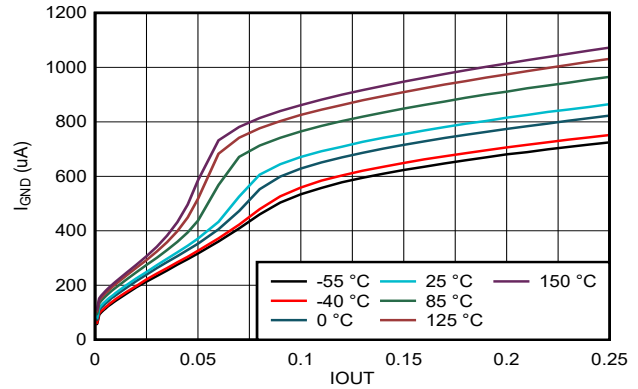

Figure 5-28. GND Pin vs Load Current (New Chip)

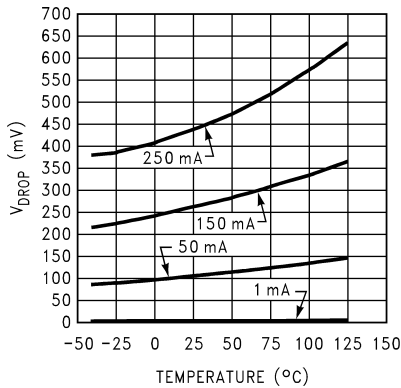

Figure 5-29. Dropout Voltage vs Temperature (Legacy Chip)

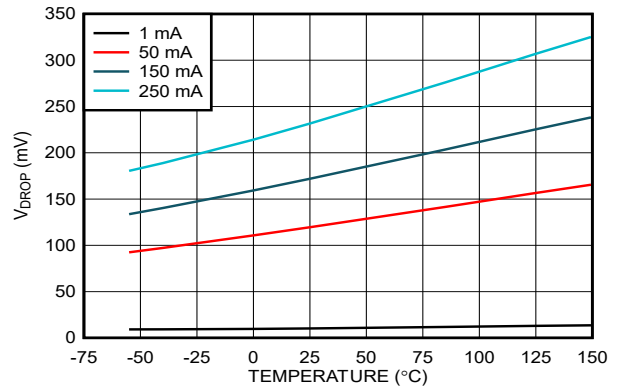

Figure 5-30. Dropout Voltage vs Temperature (New Chip)

5.6 Typical Characteristics (continued)

$C_{IN} = 1\mu\text{F}$, $C_{OUT} = 4.7\mu\text{F}$, $V_{IN} = V_{OUT(NOM)} + 1\text{V}$, $T_A = 25^\circ\text{C}$, and ON/OFF pin is tied to the IN pin (unless otherwise noted)

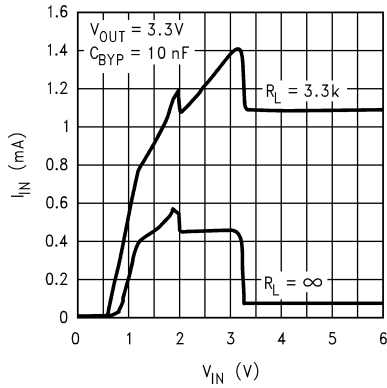

Figure 5-31. Input Current vs Input Voltage (Legacy Chip)

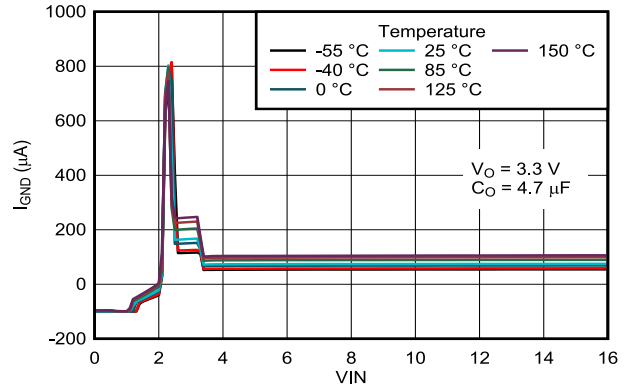

Figure 5-32. Input Current vs Input Voltage (New Chip)

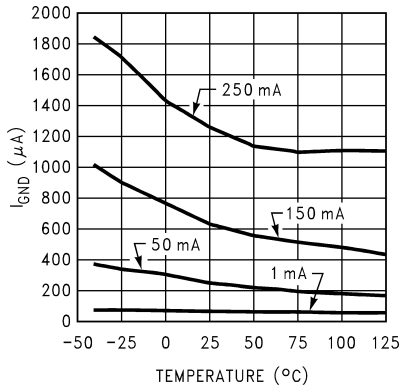

Figure 5-33. I_{GND} vs Load and Temperature (Legacy Chip)

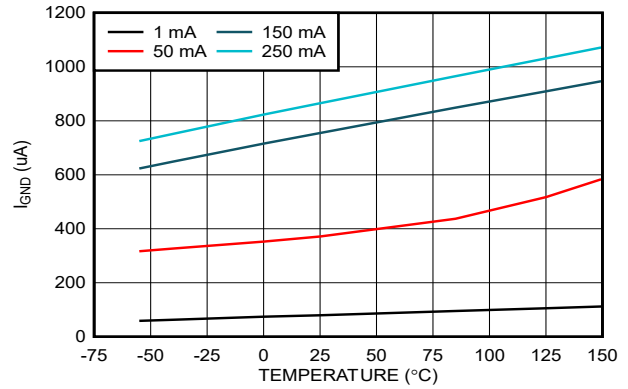

Figure 5-34. I_{GND} vs Load and Temperature (New Chip)

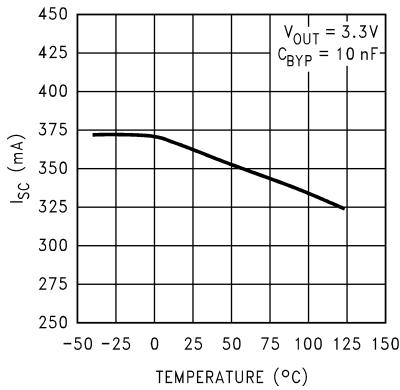

Figure 5-35. Short-Circuit Current vs Temperature (Legacy Chip)

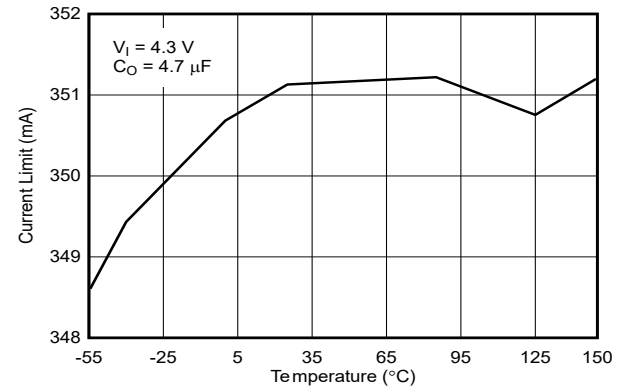

Figure 5-36. Short-Circuit Current vs Temperature (New Chip)

5.6 Typical Characteristics (continued)

$C_{IN} = 1\mu\text{F}$, $C_{OUT} = 4.7\mu\text{F}$, $V_{IN} = V_{OUT(NOM)} + 1\text{V}$, $T_A = 25^\circ\text{C}$, and ON/OFF pin is tied to the IN pin (unless otherwise noted)

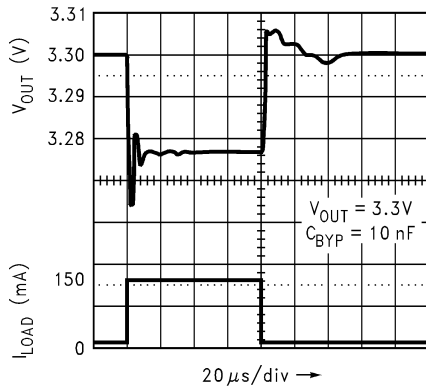

Figure 5-37. Load Transient Response (Legacy Chip)

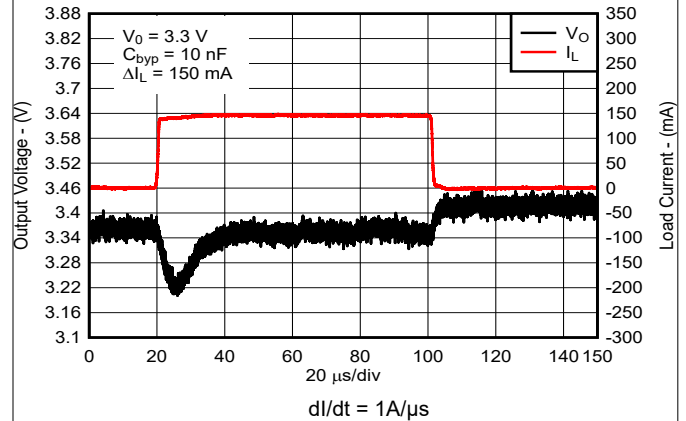

Figure 5-38. Load Transient (New Chip)

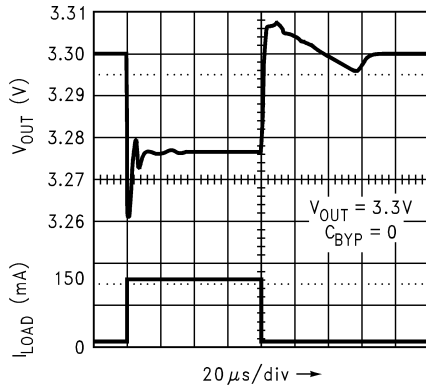

Figure 5-39. Load Transient Response (Legacy Chip)

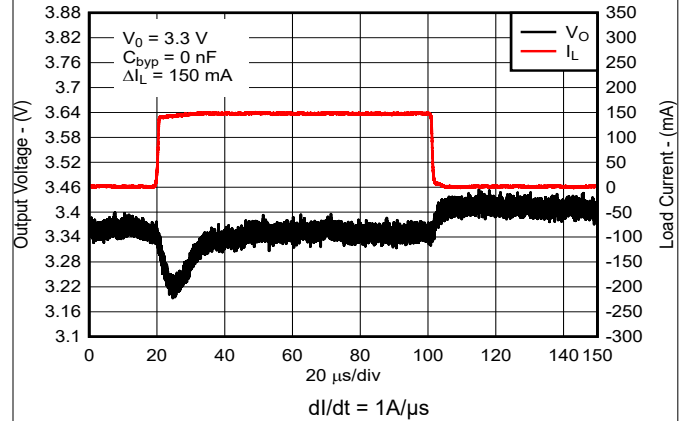

Figure 5-40. Load Transient Response (New Chip)

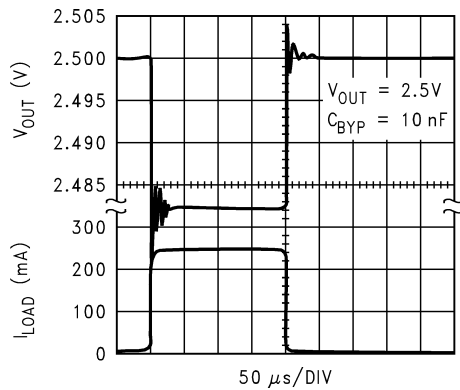

Figure 5-41. Load Transient Response (Legacy Chip)

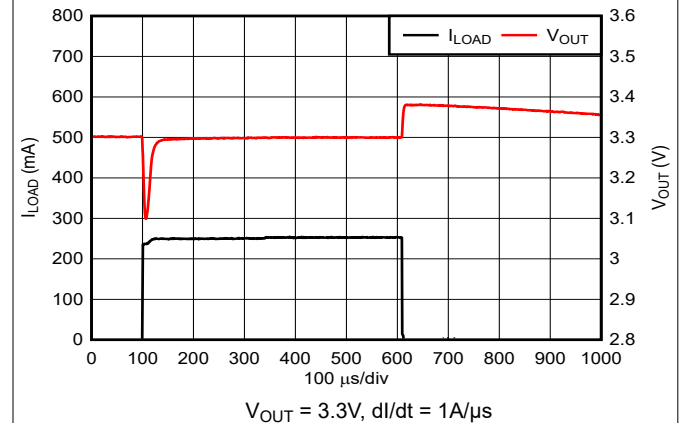

Figure 5-42. Load Transient Response (New Chip)

5.6 Typical Characteristics (continued)

$C_{IN} = 1\mu\text{F}$, $C_{OUT} = 4.7\mu\text{F}$, $V_{IN} = V_{OUT(NOM)} + 1\text{V}$, $T_A = 25^\circ\text{C}$, and ON/OFF pin is tied to the IN pin (unless otherwise noted)

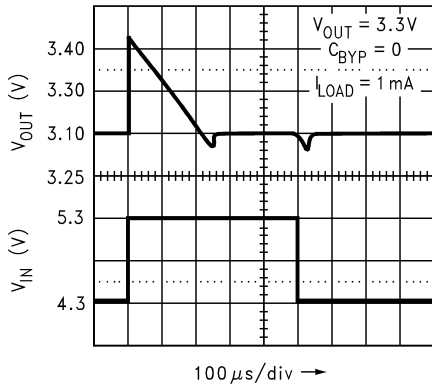

Figure 5-43. Line Transient Response (Legacy Chip)

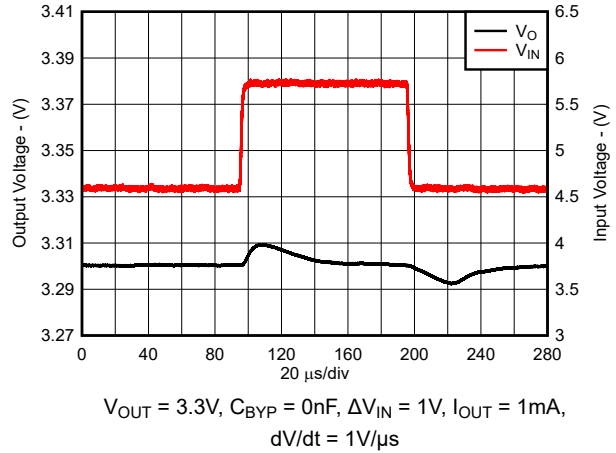

Figure 5-44. Line Transient Response (New Chip)

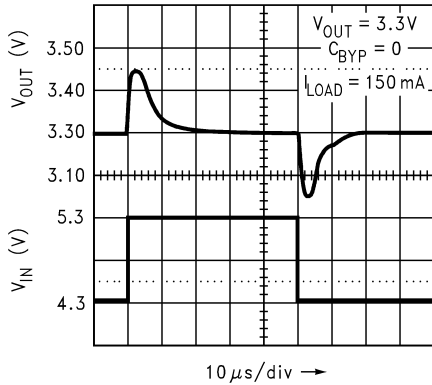

Figure 5-45. Line Transient Response (Legacy Chip)

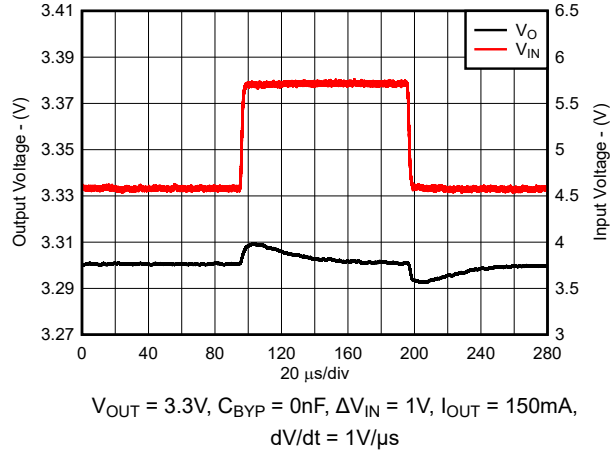

Figure 5-46. Line Transient Response (New Chip)

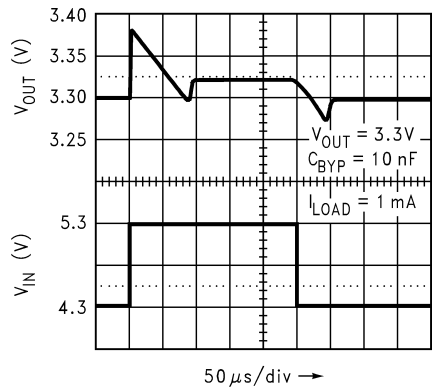

Figure 5-47. Line Transient Response (Legacy Chip)

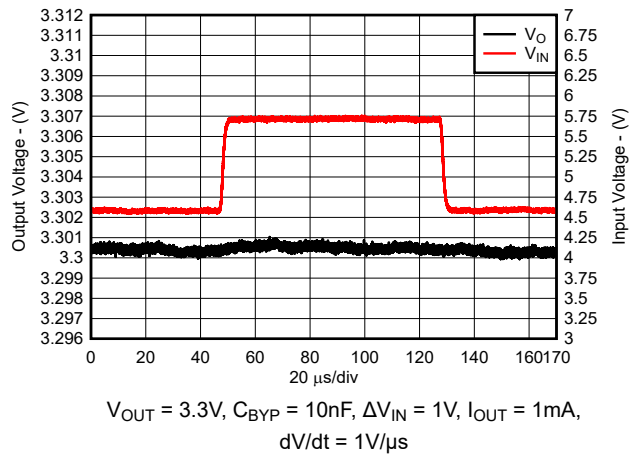

Figure 5-48. Line Transient Response (New Chip)

5.6 Typical Characteristics (continued)

$C_{IN} = 1\mu\text{F}$, $C_{OUT} = 4.7\mu\text{F}$, $V_{IN} = V_{OUT(NOM)} + 1\text{V}$, $T_A = 25^\circ\text{C}$, and ON/OFF pin is tied to the IN pin (unless otherwise noted)

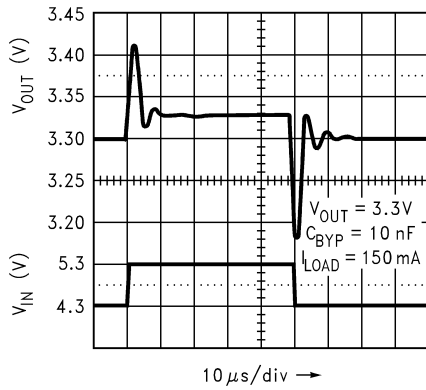

Figure 5-49. Line Transient Response (Legacy Chip)

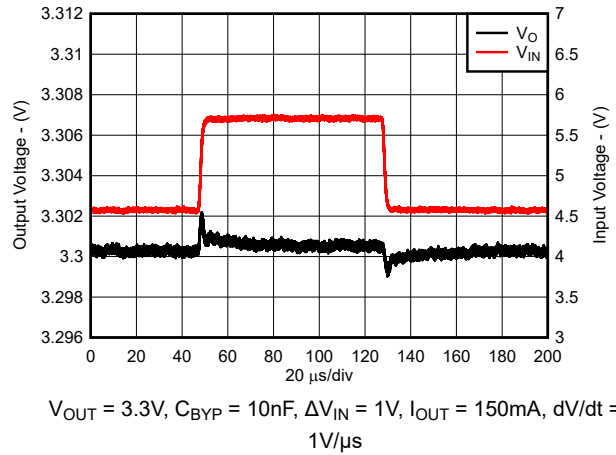

Figure 5-50. Line Transient Response (New Chip)

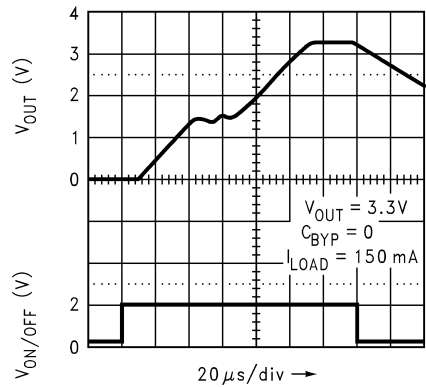

Figure 5-51. Turn-On Time (Legacy Chip)

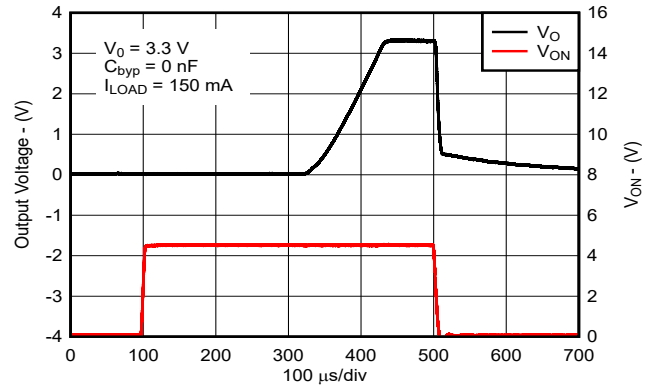

Figure 5-52. Turn-On Time (New Chip)

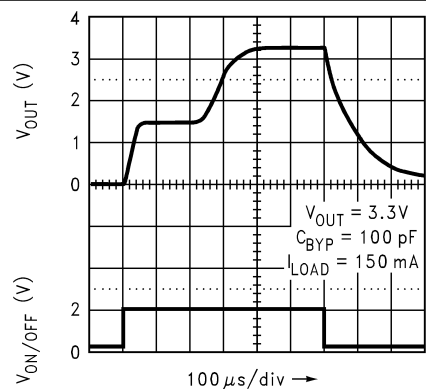

Figure 5-53. Turn-On Time (Legacy Chip)

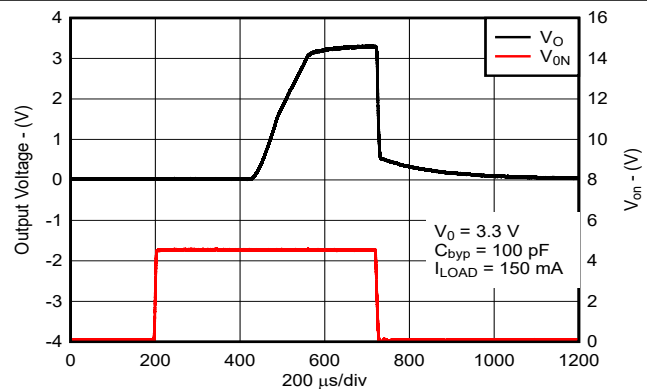

Figure 5-54. Turn-On Time (New Chip)

5.6 Typical Characteristics (continued)

$C_{IN} = 1\mu\text{F}$, $C_{OUT} = 4.7\mu\text{F}$, $V_{IN} = V_{OUT(NOM)} + 1\text{V}$, $T_A = 25^\circ\text{C}$, and ON/OFF pin is tied to the IN pin (unless otherwise noted)

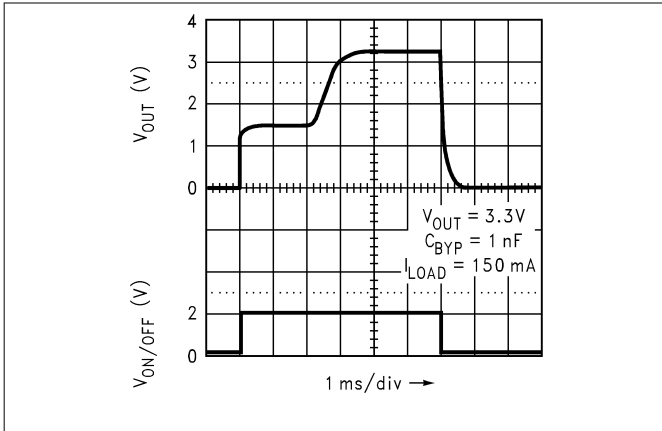

Figure 5-55. Turn-On Time (Legacy Chip)

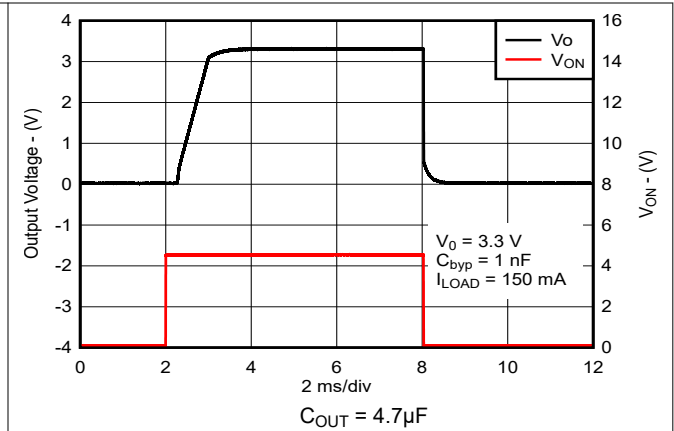

Figure 5-56. Turn-On Time (New Chip)

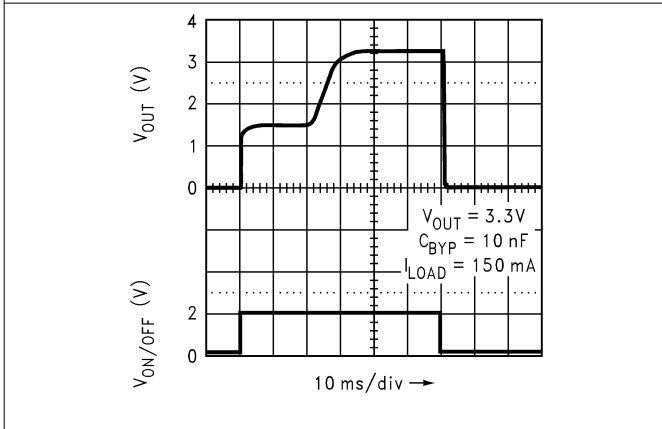

Figure 5-57. Turn-On Time (Legacy Chip)

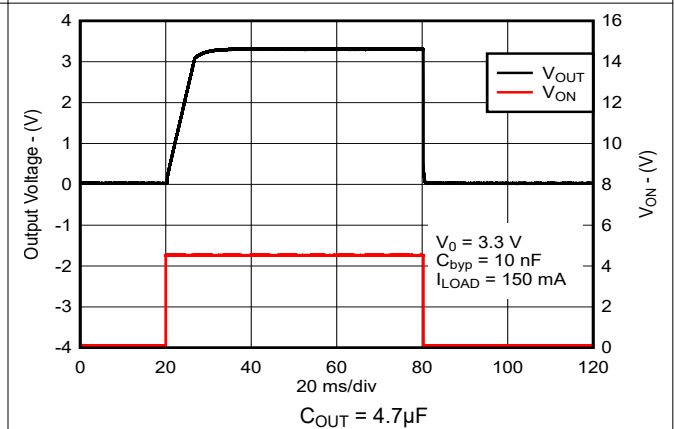

Figure 5-58. Turn-On Time (New Chip)

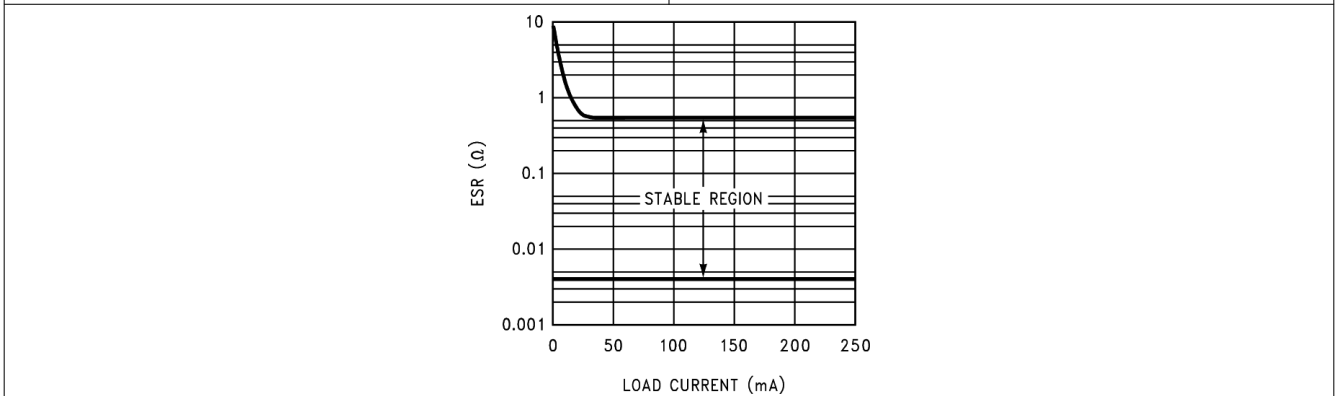

Figure 5-59. Stable ESR Range vs Load Current (Legacy Chip)

6 Detailed Description

6.1 Overview

The LP2991 is a fixed-output, low-noise, high PSRR, low-dropout regulator that offers exceptional, cost-effective performance for both portable and nonportable applications. The LP2991 has an output tolerance of 1% across line, load, and temperature variation (for the new chip) and is capable of delivering 250 mA of continuous load current.

This device features integrated overcurrent protection, thermal shutdown, output enable, and internal output pulldown and has a built-in soft-start mechanism for controlled inrush current. This device delivers excellent line and load transient performance. The operating ambient temperature range of the device is -40°C to 125°C .

6.2 Functional Block Diagram

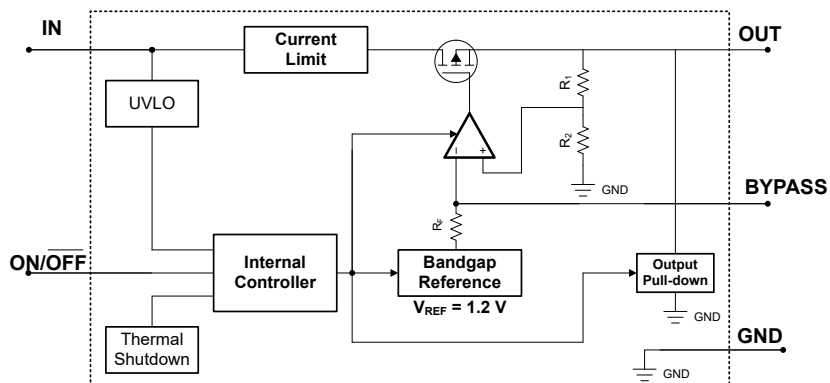

6.3 Feature Description

6.3.1 Output Enable

The ON/ $\overline{\text{OFF}}$ pin for the device is an active-high pin. The output voltage is enabled when the voltage of the ON/ $\overline{\text{OFF}}$ pin is greater than the high-level input voltage of the ON/ $\overline{\text{OFF}}$ pin and disabled when the ON/ $\overline{\text{OFF}}$ pin voltage is less than the low-level input voltage of the ON/ $\overline{\text{OFF}}$ pin. If independent control of the output voltage is not needed, connect the ON/ $\overline{\text{OFF}}$ pin to the input of the device.

The device has an internal pulldown circuit that activates when the device is disabled by pulling the ON/ $\overline{\text{OFF}}$ pin voltage lower than the low-level input voltage of the ON/ $\overline{\text{OFF}}$ pin, to actively discharge the output voltage.

6.3.2 Dropout Voltage

Dropout voltage (V_{DO}) is defined as the input voltage minus the output voltage ($V_{\text{IN}} - V_{\text{OUT}}$) at the rated output current (I_{RATED}), where the pass transistor is fully on. I_{RATED} is the maximum I_{OUT} listed in the [Recommended Operating Conditions](#) table. The pass transistor is in the ohmic or triode region of operation, and acts as a switch. The dropout voltage indirectly specifies a minimum input voltage greater than the nominal programmed output voltage at which the output voltage is expected to stay in regulation. If the input voltage falls to less than the nominal output regulation, then the output voltage falls as well.

For a CMOS regulator, the dropout voltage is determined by the drain-source on-state resistance ($R_{DS(ON)}$) of the pass transistor. Therefore, if the linear regulator operates at less than the rated current, the dropout voltage for that current scales accordingly. The following equation calculates the $R_{DS(ON)}$ of the device.

$$R_{DS(ON)} = \frac{V_{DO}}{I_{RATED}} \quad (1)$$

6.3.3 Current Limit

6.3.3.1 Current Limit (Legacy Chip)

The internal current-limit circuit protects the LDO against high-current faults or shorting events. The LDO is not designed to operate in a steady-state current limit. During a current-limit event, the LDO sources constant current. Therefore, the output voltage falls when the output impedance decreases. If current limit occurs and the resulting output voltage is low, excessive power is potentially dissipated across the LDO, resulting in a thermal shutdown of the output. The LP2992 features a foldback current limit that allows a high peak current when $V_{OUT} > 0.5V$. The device then reduces the maximum output current when V_{OUT} is forced to ground.

6.3.3.2 Current Limit (New Chip)

The device has an internal current limit circuit that protects the regulator during transient high-load current faults or shorting events. The current limit is a brick-wall scheme. In a high-load current fault, the brick-wall scheme limits the output current to the current limit (I_{CL}). I_{CL} is listed in the [Electrical Characteristics](#) table.

The output voltage is not regulated when the device is in current limit. When a current limit event occurs, the device begins to heat up because of the increase in power dissipation. When the device is in brick-wall current limit, the pass transistor dissipates power $[(V_{IN} - V_{OUT}) \times I_{CL}]$. If thermal shutdown is triggered, the device turns off. After the device cools down, the internal thermal shutdown circuit turns the device back on. If the output current fault condition continues, the device cycles between current limit and thermal shutdown. For more information on current limits, see the [Know Your Limits](#) application note.

Figure 6-1 shows a diagram of the current limit.

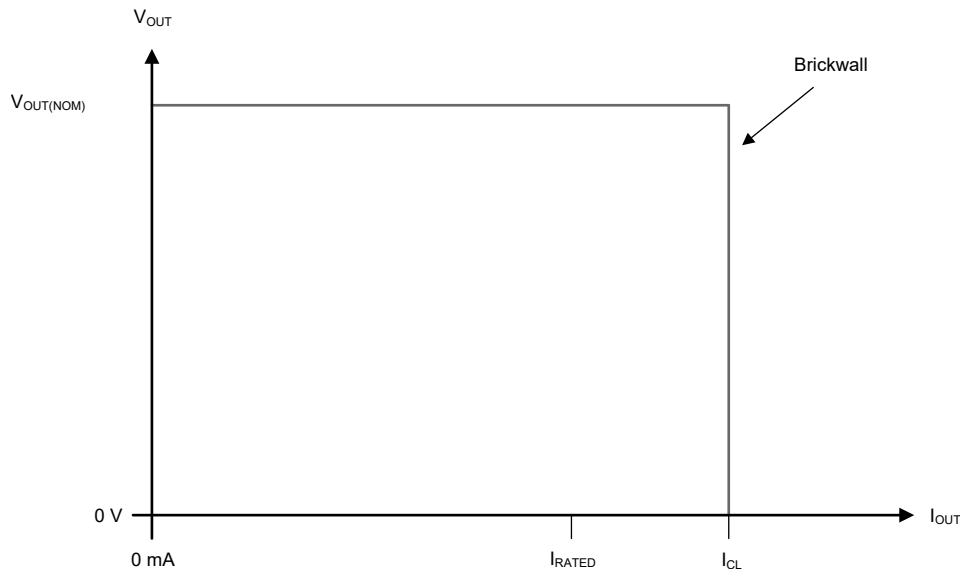

Figure 6-1. Current Limit

6.3.4 Undervoltage Lockout (UVLO)

The device has an independent undervoltage lockout (UVLO) circuit that monitors the input voltage, allowing a controlled and consistent turn on and off of the output voltage. To prevent the device from turning off if the input drops during turn on, the UVLO has hysteresis as specified in the [Electrical Characteristics](#) table.

6.3.5 Output Pulldown

The new chip has an output pulldown circuit. The output pulldown activates in the following conditions:

- When the device is disabled ($V_{ON/OFF} < V_{ON/OFF(LOW)}$)
- If $1.0V < V_{IN} < V_{UVLO}$

Do not rely on the output pulldown circuit for discharging a large amount of output capacitance after the input supply has collapsed because reverse current can flow from the output to the input. This reverse current flow can cause damage to the device. See the [Reverse Current](#) section for more details.

6.3.6 Thermal Shutdown

The device contains a thermal shutdown protection circuit to disable the device when the junction temperature (T_J) of the pass transistor rises to $T_{SD(shutdown)}$ (typical). Thermal shutdown hysteresis resets (turns on) the device when the temperature falls to $T_{SD(reset)}$ (typical).

The thermal time-constant of the semiconductor die is fairly short, thus the device can cycle on and off when thermal shutdown is reached until power dissipation is reduced. Power dissipation during start up can be high from large $V_{IN} - V_{OUT}$ voltage drops across the device or from high inrush currents charging large output capacitors. Under some conditions, the thermal shutdown protection disables the device before start up completes.

For reliable operation, limit the junction temperature to the maximum listed in the [Recommended Operating Conditions](#) table. Operation above this maximum temperature causes the device to exceed operational specifications. Although the internal protection circuitry of the device is designed to protect against thermal overall conditions, this circuitry is not intended to replace proper heat sinking. Continuously running the device into thermal shutdown or above the maximum recommended junction temperature reduces long-term reliability.

6.4 Device Functional Modes

Table 6-1 shows the conditions that lead to the different modes of operation. See the [Electrical Characteristics](#) table for parameter values.

Table 6-1. Device Functional Mode Comparison

OPERATING MODE	PARAMETER			
	V_{IN}	$V_{ON/OFF}$	I_{OUT}	T_J
Normal operation	$V_{IN} > V_{OUT(nom)} + V_{DO}$ and $V_{IN} > V_{IN(min)}$	$V_{ON/OFF} > V_{ON/OFF(HI)}$	$I_{OUT} < I_{OUT(max)}$	$T_J < T_{SD(shutdown)}$
Dropout operation	$V_{IN(min)} < V_{IN} < V_{OUT(nom)} + V_{DO}$	$V_{ON/OFF} > V_{ON/OFF(HI)}$	$I_{OUT} < I_{OUT(max)}$	$T_J < T_{SD(shutdown)}$
Disabled (any true condition disables the device)	$V_{IN} < V_{UVLO}$	$V_{ON/OFF} < V_{ON/OFF(LOW)}$	Not applicable	$T_J > T_{SD(shutdown)}$

6.4.1 Normal Operation

The device regulates to the nominal output voltage when the following conditions are met:

- The input voltage is greater than the nominal output voltage plus the dropout voltage ($V_{OUT(nom)} + V_{DO}$)
- The output current is less than the current limit ($I_{OUT} < I_{CL}$)
- The device junction temperature is less than the thermal shutdown temperature ($T_J < T_{SD}$)
- The $\overline{ON/OFF}$ voltage has previously exceeded the $\overline{ON/OFF}$ rising threshold voltage and has not yet decreased to less than the enable falling threshold

6.4.2 Dropout Operation

If the input voltage is lower than the nominal output voltage plus the specified dropout voltage, but all other conditions are met for normal operation, the device operates in dropout mode. In this mode, the output voltage tracks the input voltage. During this mode, the transient performance of the device becomes significantly degraded because the pass transistor is in the ohmic or triode region, and acts as a switch. Line or load transients in dropout can result in large output-voltage deviations.

When the device is in a steady dropout state (defined as when the device is in dropout, $V_{IN} < V_{OUT(NOM)} + V_{DO}$, directly after being in a normal regulation state, but *not* during start up), the pass transistor is driven into the ohmic or triode region. When the input voltage returns to a value greater than or equal to the nominal output voltage plus the dropout voltage ($V_{OUT(NOM)} + V_{DO}$), the output voltage can overshoot for a short period of time while the device pulls the pass transistor back into the linear region.

6.4.3 Disabled

The output of the device can be shutdown by forcing the voltage of the $\overline{ON/OFF}$ pin to less than the maximum $\overline{ON/OFF}$ pin low-level input voltage (see the [Electrical Characteristics](#) table). When disabled, the pass transistor is turned off, internal circuits are shutdown, and the output voltage is actively discharged to ground by an internal discharge circuit from the output to ground.

7 Application and Implementation

Note

Information in the following applications sections is not part of the TI component specification, and TI does not warrant its accuracy or completeness. TI's customers are responsible for determining suitability of components for their purposes, as well as validating and testing their design implementation to confirm system functionality.

7.1 Application Information

7.1.1 Estimating Junction Temperature

The JEDEC standard now recommends the use of psi (Ψ) thermal metrics to estimate the junction temperatures of the linear regulator when in-circuit on a typical PCB board application. These metrics are not thermal resistance parameters and instead offer a practical and relative way to estimate junction temperature. These psi metrics are determined to be significantly independent of the copper area available for heat-spreading. The [Thermal Information](#) lists the primary thermal metrics, which are the junction-to-top characterization parameter (ψ_{JT}) and junction-to-board characterization parameter (ψ_{JB}). These parameters provide two methods for calculating the junction temperature (T_J), as described in the following equations. Use the junction-to-top characterization parameter (ψ_{JT}) with the temperature at the center-top of device package (T_T) to calculate the junction temperature. Use the junction-to-board characterization parameter (ψ_{JB}) with the PCB surface temperature 1mm from the device package (T_B) to calculate the junction temperature.

$$T_J = T_T + \psi_{JT} \times P_D \quad (2)$$

where:

- P_D is the dissipated power
- T_T is the temperature at the center-top of the device package

$$T_J = T_B + \psi_{JB} \times P_D \quad (3)$$

where:

- T_B is the PCB surface temperature measured 1mm from the device package and centered on the package edge

For detailed information on the thermal metrics and how to use them, see the [Semiconductor and IC Package Thermal Metrics](#) application note.

7.1.2 Input and Output Capacitor Requirements

Although an input capacitor is not required for stability, good analog design practice is to connect a capacitor from IN to GND. This capacitor counteracts reactive input sources and improves transient response, input ripple, and PSRR. Use an input capacitor if the source impedance is more than 0.5Ω . A higher value capacitor can be necessary if large, fast rise-time load or line transients are anticipated or if the device is located several inches from the input power source.

Dynamic performance of the device is improved with the use of an output capacitor. Use an output capacitor within the range specified in the [Recommended Operating Conditions](#) table for stability.

7.1.3 Noise Bypass Capacitor (C_{BYPASS})

The LP2992 allows for low-noise performance with the use of a bypass capacitor that is connected to the internal band-gap reference with the BYPASS pin. This high-impedance band-gap circuitry is biased in the microampere range and, thus, cannot be loaded significantly, otherwise, the output (and, correspondingly, the output of the regulator) changes. Thus, for best output accuracy, dc leakage current through C_{BYPASS} must be minimized as

much as possible and must never exceed 100nA. The C_{BYPASS} capacitor also impacts the start-up behavior of the regulator. Inrush current and start-up time increase with larger bypass capacitor values.

Use a 10nF capacitor for C_{BYPASS} . Ceramic and film capacitors are good choices for this purpose.

7.1.4 Power Dissipation (P_D)

Circuit reliability requires consideration of the device power dissipation, location of the circuit on the printed circuit board (PCB), and correct sizing of the thermal plane. The PCB area around the regulator must have few or no other heat-generating devices that cause added thermal stress.

To first-order approximation, power dissipation in the regulator depends on the input-to-output voltage difference and load conditions. The following equation calculates power dissipation (P_D).

$$P_D = (V_{\text{IN}} - V_{\text{OUT}}) \times I_{\text{OUT}} \quad (4)$$

Note

Power dissipation can be minimized, and therefore greater efficiency can be achieved, by correct selection of the system voltage rails. For the lowest power dissipation use the minimum input voltage required for correct output regulation.

For devices with a thermal pad, the primary heat conduction path for the device package is through the thermal pad to the PCB. Solder the thermal pad to a copper pad area under the device. This pad area must contain an array of plated vias that conduct heat to additional copper planes for increased heat dissipation.

The maximum power dissipation determines the maximum allowable ambient temperature (T_A) for the device. According to the following equation, power dissipation and junction temperature are most often related by the junction-to-ambient thermal resistance ($R_{\theta\text{JA}}$) of the combined PCB and device package and the temperature of the ambient air (T_A).

$$T_J = T_A + (R_{\theta\text{JA}} \times P_D) \quad (5)$$

Thermal resistance ($R_{\theta\text{JA}}$) is highly dependent on the heat-spreading capability built into the particular PCB design, and therefore varies according to the total copper area, copper weight, and location of the planes. The junction-to-ambient thermal resistance listed in the [Thermal Information](#) table is determined by the JEDEC standard PCB and copper-spreading area, and is used as a relative measure of package thermal performance.

7.1.5 Recommended Capacitor Types

This section describes the recommended capacitors for both the new chip and the legacy chip.

7.1.5.1 Recommended Capacitors (Legacy Chip)

The LP2992 is designed specifically to work with ceramic output capacitors, using circuitry that allows the regulator to be stable across the entire range of output current with an output capacitor whose ESR is as low as 5mΩ. Tantalum or film capacitors are available for use at the output, but these capacitors are not as attractive for size and cost reasons.

Make sure the output capacitor meets the requirement for minimum amount of capacitance and also have an ESR value within the stable range. Curves are provided that show the stable ESR range as a function of load current (see [Figure 5-59](#)).

Make sure the output capacitor maintains the ESR within the stable region over the full operating temperature range of the application to provide stability.

The legacy chip version of the LP2992 requires a minimum of 4.7μF on the output (increase output capacitor size without limit). Remember to take capacitor tolerance and variation with temperature into consideration when selecting an output capacitor so that the minimum required amount of output capacitance is provided over the full operating temperature range. Ceramic capacitors potentially exhibit large changes in capacitance with temperature.

Do not locate the output capacitor more than 1cm from the output pin. Make sure the output capacitor returns to a clean analog ground.

7.1.5.1.1 Tantalum Capacitors (Legacy Chip)

Tantalum capacitors are less desirable than ceramics for use as output capacitors because these components are more expensive when comparing equivalent capacitance and voltage ratings in the 1 μ F to 4.7 μ F range.

Another important consideration is that tantalum capacitors have higher ESR values than equivalent size ceramics. This condition means that although finding a Tantalum capacitor with an ESR value within the stable range is possible, the capacitor is larger in capacitance (which means bigger and more costly) than a ceramic capacitor with the same ESR value.

The ESR of a typical tantalum increases approximately 2:1 as the temperature goes from 25°C down to -40°C, so allow for some guard band.

7.1.5.2 Recommended Capacitors (New Chip)

The device is designed to be stable using low equivalent series resistance (ESR) ceramic capacitors at the input and output. Multilayer ceramic capacitors have become the industry standard for these types of applications and are recommended, but must be used with good judgment. Ceramic capacitors that employ X7R-, X5R-, and C0G-rated dielectric materials provide relatively good capacitive stability across temperature, whereas the use of Y5V-rated capacitors is discouraged because of large variations in capacitance.

Regardless of the ceramic capacitor type selected, the effective capacitance varies with operating voltage and temperature. Generally, expect the effective capacitance to decrease by as much as 50%. The input and output capacitors listed in the [Recommended Operating Conditions](#) account for an effective capacitance of approximately 50% of the nominal value.

7.1.6 Reverse Current

Excessive reverse current can damage this device. Reverse current flows through the intrinsic body diode of the pass transistor instead of the normal conducting channel. At high magnitudes, this current flow degrades the long-term reliability of the device.

Conditions where reverse current can occur are outlined in this section, all of which can exceed the absolute maximum rating of $V_{OUT} \leq V_{IN} + 0.3$ V.

- If the device has a large C_{OUT} and the input supply collapses with little or no load current
- The output is biased when the input supply is not established
- The output is biased above the input supply

If reverse current flow is expected in the application, use external protection to protect the device. Reverse current is not limited in the device, so external limiting is required if extended reverse voltage operation is anticipated.

Figure 7-1 shows one approach for protecting the device.

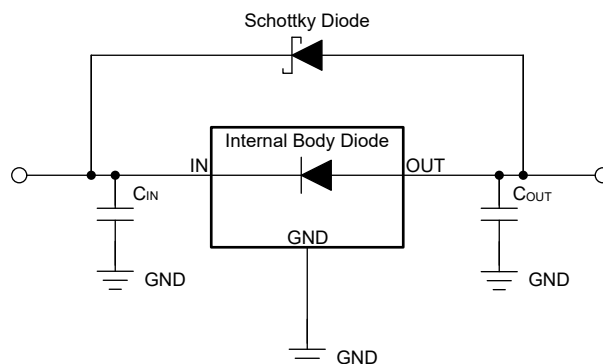

Figure 7-1. Example Circuit for Reverse Current Protection Using a Schottky Diode

7.2 Typical Application

Figure 7-2 shows the standard usage of the LP2992 as a low-dropout regulator.

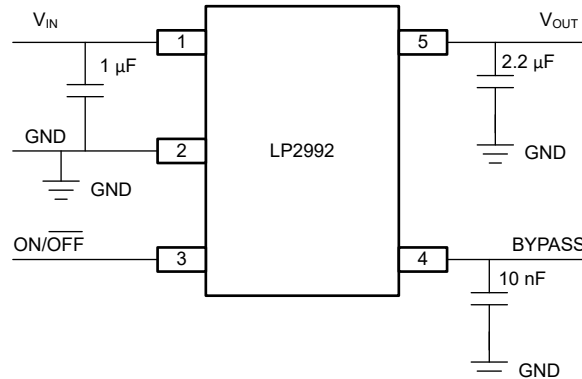

Figure 7-2. LP2992 Typical Application

7.2.1 Design Requirements

Minimum C_{OUT} value for stability (can be increased without limit for improved stability and transient response)

ON/\overline{OFF} must be actively terminated. Connect to V_{IN} if shutdown feature is not used.

Optional BYPASS capacitor for low-noise operation.

7.2.2 Detailed Design Procedure

7.2.2.1 ON/\overline{OFF} Operation

The LP2992 allows for a shutdown mode using the ON/\overline{OFF} pin. Driving the pin LOW ($\leq 0.4V$) turns the device OFF; conversely, a HIGH ($\geq 1.2V$) turns the device ON. If the shutdown feature is not used, connect ON/\overline{OFF} to the input so that the regulator is on at all times. For proper operation, do not leave ON/\overline{OFF} unconnected.

7.2.3 Application Curves

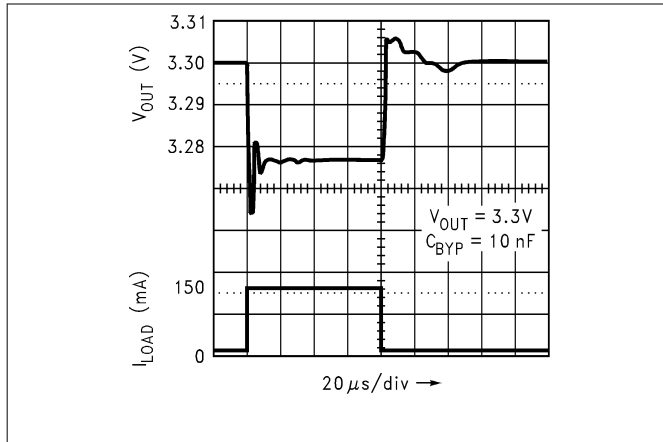

Figure 7-3. Load Transient Response for Legacy Chip

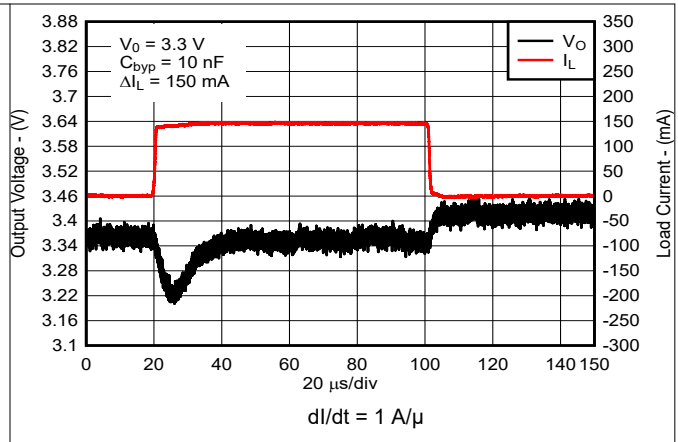

Figure 7-4. Load Transient for New Chip

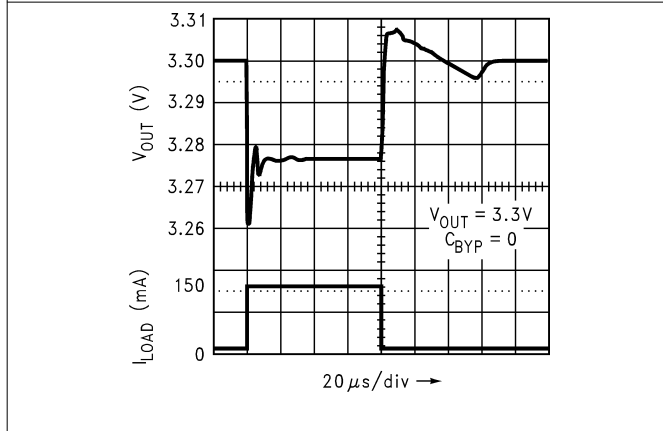

Figure 7-5. Load Transient Response for Legacy Chip

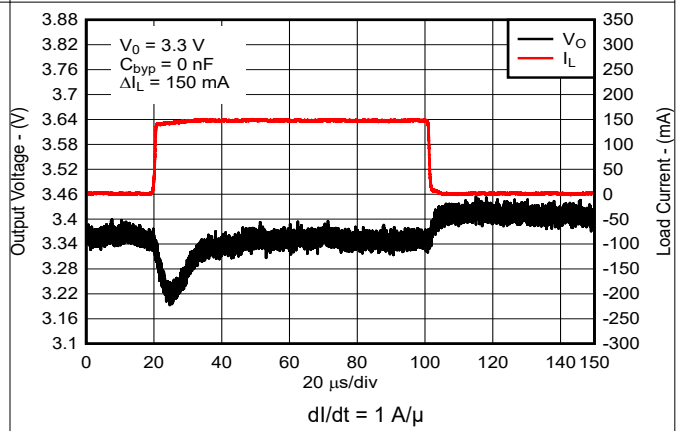

Figure 7-6. Load Transient Response for New Chip

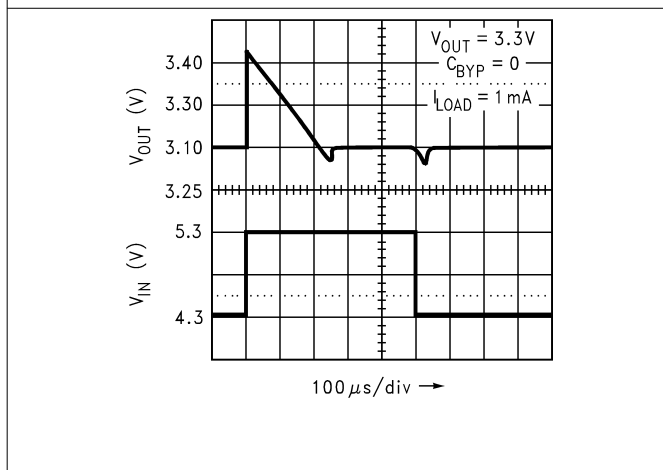

Figure 7-7. Line Transient Response for Legacy Chip

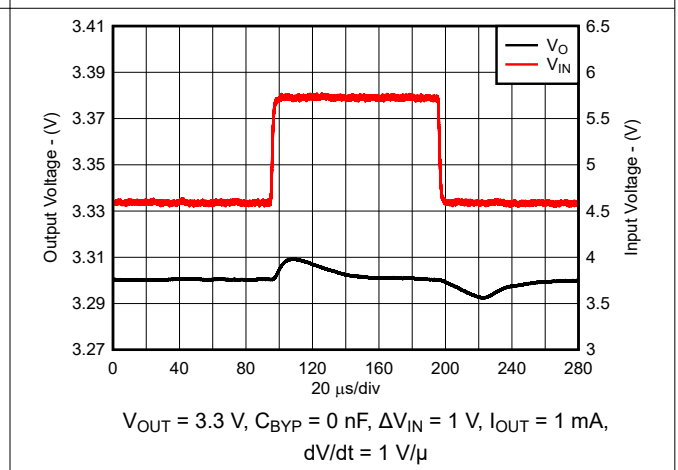

Figure 7-8. Line Transient Response for New Chip

7.2.3 Application Curves (continued)

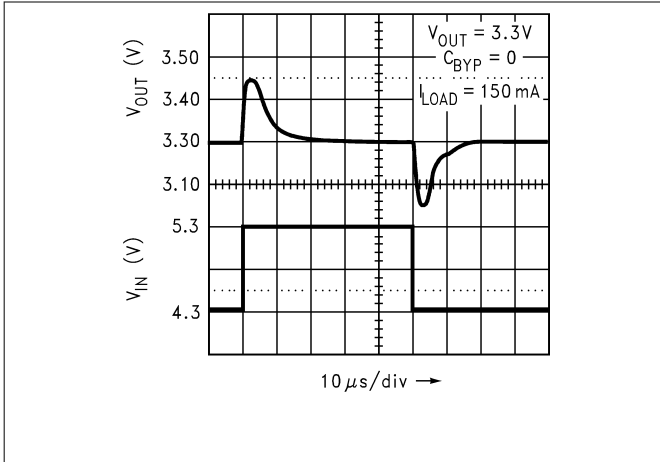

Figure 7-9. Line Transient Response for Legacy Chip

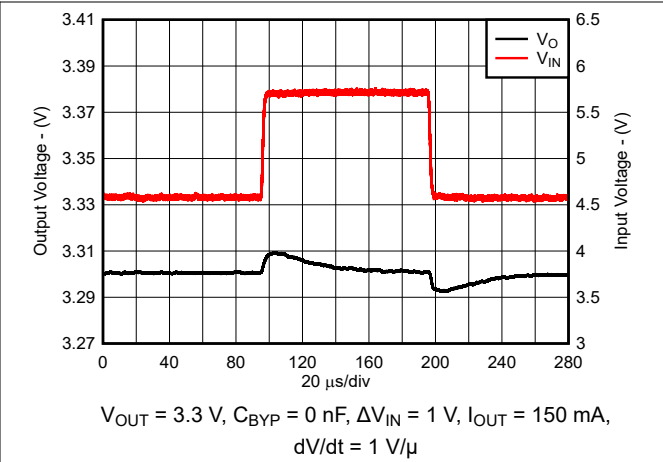

Figure 7-10. Line Transient Response for New Chip

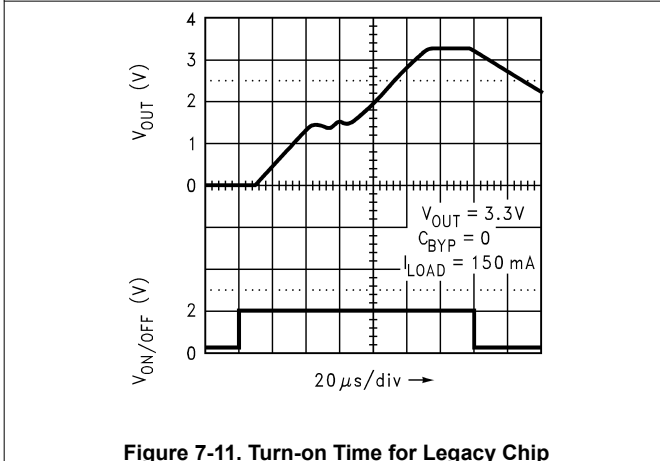

Figure 7-11. Turn-on Time for Legacy Chip

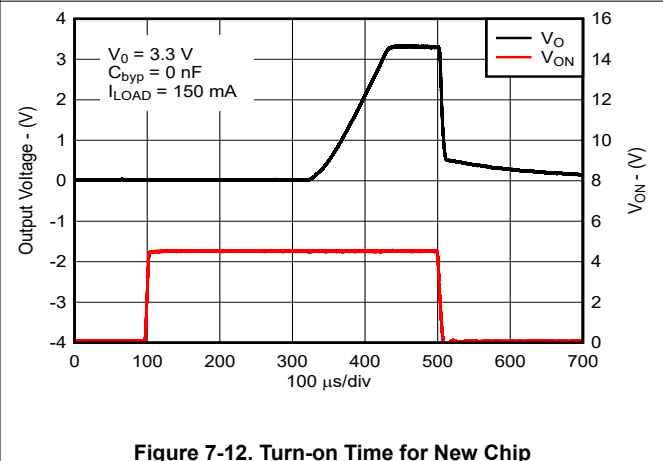

Figure 7-12. Turn-on Time for New Chip

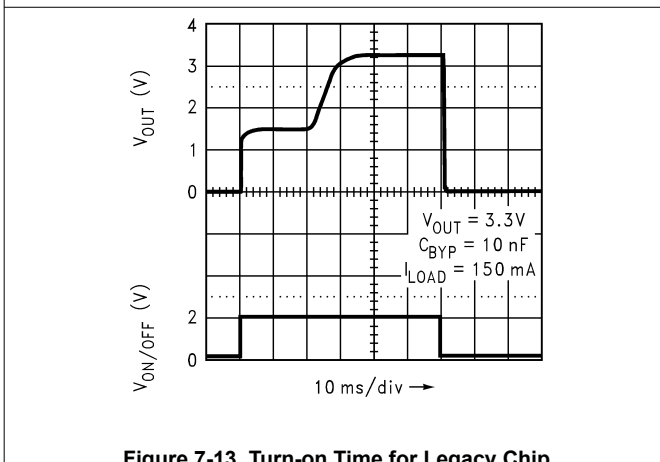

Figure 7-13. Turn-on Time for Legacy Chip

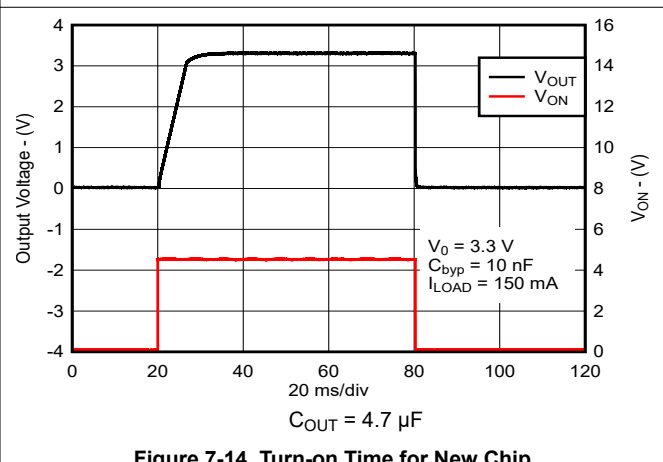

Figure 7-14. Turn-on Time for New Chip

7.3 Power Supply Recommendations

A power supply can be used at the input voltage within the ranges given in the [Recommended Operating Conditions](#) table. Use bypass capacitors as described in the [Layout Guidelines](#) section.

7.4 Layout

7.4.1 Layout Guidelines

- Bypass the input pin to ground with a bypass capacitor.
- The optimum placement of the bypass capacitor is closest to the V_{IN} of the device and GND of the system. Care must be taken to minimize the loop area formed by the bypass capacitor connection, the V_{IN} pin, and the GND pin of the system.
- For operation at full-rated load, use wide trace lengths to eliminate IR drop and heat dissipation.

7.4.2 Layout Examples

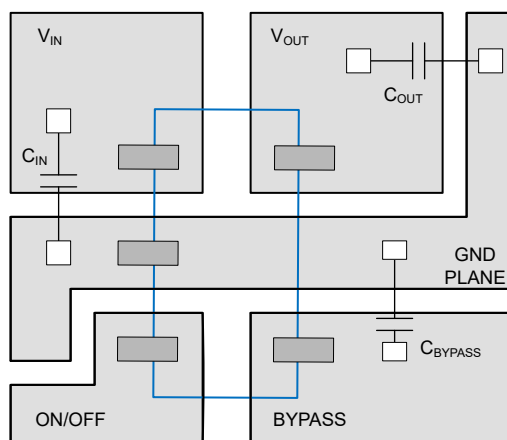

Figure 7-15. Layout Diagram

8 Device and Documentation Support

8.1 Device Nomenclature

Table 8-1. Available Options

PRODUCT ⁽¹⁾	V _{OUT}
LP2992vwxy-z.z/NOPB	<p>v is the accuracy specification for the legacy chip (A or blank). See the Electrical Characteristics for more information. This character is insignificant for the new chip. w is the operating temperature range (I = -40°C to +125°C). xx is the package designator. y is the reel designator size. See the Package Addendum for more information on package quantity.</p> <p>z.z is the nominal output voltage (for example, 3.3 = 3.3V; 5.0 = 5.0V). /NOPB indicates material construction that does not use Lead (Pb).</p> <p>This device ships with the legacy chip (CSO: DLN or GF8) or the new chip (CSO: RFB), which uses the latest manufacturing flow. The reel packaging label provides CSO information to distinguish which chip is used. Device performance for new and legacy chips is denoted throughout the document.</p>

(1) For the most current package and ordering information, see the Package Option Addendum at the end of this document, or visit the device product folder at www.ti.com.

8.2 Documentation Support

8.2.1 Related Documentation

For related documentation see the following:

- Texas Instruments, [AN-1187 Leadless Leadframe Package \(LLP\)](#), application note
- Texas Instruments, [Semiconductor and IC Package Thermal Metrics](#), application note
- Texas Instruments, [Using New Thermal Metrics](#), application note
- Texas Instruments, [Thermal Characteristics of Linear and Logic Packages Using JEDEC PCB Designs](#), application note

8.3 Receiving Notification of Documentation Updates

To receive notification of documentation updates, navigate to the device product folder on ti.com. In the upper right corner, click on *Alert me* to register and receive a weekly digest of any product information that has changed. For change details, review the revision history included in any revised document.

8.4 Support Resources

[TI E2E™ support forums](#) are an engineer's go-to source for fast, verified answers and design help — straight from the experts. Search existing answers or ask your own question to get the quick design help you need.

Linked content is provided "AS IS" by the respective contributors. They do not constitute TI specifications and do not necessarily reflect TI's views; see TI's [Terms of Use](#).

8.5 Trademarks

TI E2E™ is a trademark of Texas Instruments.
All trademarks are the property of their respective owners.

8.6 Electrostatic Discharge Caution



This integrated circuit can be damaged by ESD. Texas Instruments recommends that all integrated circuits be handled with appropriate precautions. Failure to observe proper handling and installation procedures can cause damage.

ESD damage can range from subtle performance degradation to complete device failure. Precision integrated circuits may be more susceptible to damage because very small parametric changes could cause the device not to meet its published specifications.

8.7 Glossary

[TI Glossary](#) This glossary lists and explains terms, acronyms, and definitions.

9 Revision History

NOTE: Page numbers for previous revisions may differ from page numbers in the current version.

Changes from Revision K (December 2023) to Revision L (February 2025)	Page
• Updated the numbering format for tables, figures, and cross-references throughout the document.	1
• Changed V_{IN} pin to IN and V_{OUT} pin to OUT in <i>Pin Configuration and Functions</i> section.....	3
• Added ESR range for output capacitor.....	4
• Added <i>Stable ESR Range vs Load Current for Legacy Chip</i> curve.....	8
• Changed V_{IN} pin to IN and V_{OUT} pin to OUT in <i>Functional Block Diagram</i>	18
• Added <i>Recommended Capacitors (Legacy Chip)</i> section.....	23
• Added <i>Tantalum Capacitors (Legacy Chip)</i> section.....	24
• Added <i>Recommended Capacitors (New Chip)</i> section.....	24

Changes from Revision J (January 2017) to Revision K (December 2023)	Page
• Changed entire document to align with current family format.....	1
• Added M3 devices to document	1
• Updated the numbering format for tables, figures, and cross-references throughout the document.	1
• Updated Absolute Maximum Ratings, Recommended Operating Conditions, Electrical Characteristics and Thermal Information for M3-suffix(new chip).....	5
• Changed <i>Current Limit</i> section.....	19
• Added <i>Output Pulldown</i> section.....	20
• Added <i>Device Nomenclature</i> section.....	29

10 Mechanical, Packaging, and Orderable Information

The following pages include mechanical, packaging, and orderable information. This information is the most current data available for the designated devices. This data is subject to change without notice and revision of this document. For browser-based versions of this data sheet, refer to the left-hand navigation.

PACKAGING INFORMATION

Orderable part number	Status (1)	Material type (2)	Package Pins	Package qty Carrier	RoHS (3)	Lead finish/ Ball material (4)	MSL rating/ Peak reflow (5)	Op temp (°C)	Part marking (6)
LP2992AILD-1.5/NO.A	Active	Production	WSON (NGD) 6	1000 SMALL T&R	Yes	SN	Level-3-260C-168 HR	-40 to 125	L011A
LP2992AILD-1.5/NOPB	Active	Production	WSON (NGD) 6	1000 SMALL T&R	Yes	SN	Level-3-260C-168 HR	-40 to 125	L011A
LP2992AILD-1.8/NO.A	Active	Production	WSON (NGD) 6	1000 SMALL T&R	Yes	SN	Level-3-260C-168 HR	-40 to 125	L012A
LP2992AILD-1.8/NOPB	Active	Production	WSON (NGD) 6	1000 SMALL T&R	Yes	NIPDAU SN	Level-3-260C-168 HR	-40 to 125	L012A
LP2992AILD-3.3/NO.A	Active	Production	WSON (NGD) 6	1000 SMALL T&R	Yes	SN	Level-3-260C-168 HR	-40 to 125	L014A
LP2992AILD-3.3/NOPB	Active	Production	WSON (NGD) 6	1000 SMALL T&R	Yes	NIPDAU SN	Level-3-260C-168 HR	-40 to 125	L014A
LP2992AILD-5.0/NO.A	Active	Production	WSON (NGD) 6	1000 SMALL T&R	Yes	SN	Level-3-260C-168 HR	-40 to 125	L015A
LP2992AILD-5.0/NOPB	Active	Production	WSON (NGD) 6	1000 SMALL T&R	Yes	NIPDAU SN	Level-3-260C-168 HR	-40 to 125	L015A
LP2992AILDX-3.3/NO.A	Active	Production	WSON (NGD) 6	4500 LARGE T&R	Yes	SN	Level-3-260C-168 HR	-40 to 125	L014A
LP2992AILDX-3.3/NOPB	Active	Production	WSON (NGD) 6	4500 LARGE T&R	Yes	NIPDAU SN	Level-3-260C-168 HR	-40 to 125	L014A
LP2992AILDX-5.0/NO.A	Active	Production	WSON (NGD) 6	4500 LARGE T&R	Yes	SN	Level-3-260C-168 HR	-40 to 125	L015A
LP2992AILDX-5.0/NOPB	Active	Production	WSON (NGD) 6	4500 LARGE T&R	Yes	NIPDAU SN	Level-3-260C-168 HR	-40 to 125	L015A
LP2992AIM5-1.5/NO.A	Active	Production	SOT-23 (DBV) 5	1000 LARGE T&R	Yes	SN	Level-1-260C-UNLIM	-40 to 125	LFBA
LP2992AIM5-1.5/NOPB	Active	Production	SOT-23 (DBV) 5	1000 LARGE T&R	Yes	SN	Level-1-260C-UNLIM	-40 to 125	LFBA
LP2992AIM5-1.8/NO.A	Active	Production	SOT-23 (DBV) 5	3000 LARGE T&R	Yes	SN	Level-1-260C-UNLIM	-40 to 125	LFCA
LP2992AIM5-1.8/NOPB	Active	Production	SOT-23 (DBV) 5	3000 LARGE T&R	Yes	SN	Level-1-260C-UNLIM	-40 to 125	LFCA
LP2992AIM5-2.5/NO.A	Active	Production	SOT-23 (DBV) 5	3000 LARGE T&R	Yes	SN	Level-1-260C-UNLIM	-40 to 125	LFDA
LP2992AIM5-2.5/NOPB	Active	Production	SOT-23 (DBV) 5	3000 LARGE T&R	Yes	SN	Level-1-260C-UNLIM	-40 to 125	LFDA
LP2992AIM5-3.3/NO.A	Active	Production	SOT-23 (DBV) 5	3000 LARGE T&R	Yes	NIPDAU	Level-1-260C-UNLIM	-40 to 125	LFEA
LP2992AIM5-3.3/NOPB	Active	Production	SOT-23 (DBV) 5	3000 LARGE T&R	Yes	NIPDAU SN	Level-1-260C-UNLIM	-40 to 125	LFEA
LP2992AIM5-5.0/NO.A	Active	Production	SOT-23 (DBV) 5	3000 LARGE T&R	Yes	SN	Level-1-260C-UNLIM	-40 to 125	LFFA
LP2992AIM5-5.0/NOPB	Active	Production	SOT-23 (DBV) 5	3000 LARGE T&R	Yes	SN	Level-1-260C-UNLIM	-40 to 125	LFFA
LP2992AIM5X-1.5/NO.A	Active	Production	SOT-23 (DBV) 5	3000 LARGE T&R	Yes	SN	Level-1-260C-UNLIM	-40 to 125	LFBA
LP2992AIM5X-1.5/NOPB	Active	Production	SOT-23 (DBV) 5	3000 LARGE T&R	Yes	SN	Level-1-260C-UNLIM	-40 to 125	LFBA
LP2992AIM5X-1.8/NO.A	Active	Production	SOT-23 (DBV) 5	3000 LARGE T&R	Yes	SN	Level-1-260C-UNLIM	-40 to 125	LFCA
LP2992AIM5X-1.8/NOPB	Active	Production	SOT-23 (DBV) 5	3000 LARGE T&R	Yes	SN	Level-1-260C-UNLIM	-40 to 125	LFCA
LP2992AIM5X-2.5/NO.A	Active	Production	SOT-23 (DBV) 5	3000 LARGE T&R	Yes	SN	Level-1-260C-UNLIM	-40 to 125	LFDA
LP2992AIM5X-2.5/NOPB	Active	Production	SOT-23 (DBV) 5	3000 LARGE T&R	Yes	SN	Level-1-260C-UNLIM	-40 to 125	LFDA
LP2992AIM5X-3.3/NO.A	Active	Production	SOT-23 (DBV) 5	3000 LARGE T&R	Yes	NIPDAU	Level-1-260C-UNLIM	-40 to 125	LFEA

Orderable part number	Status (1)	Material type (2)	Package Pins	Package qty Carrier	RoHS (3)	Lead finish/ Ball material (4)	MSL rating/ Peak reflow (5)	Op temp (°C)	Part marking (6)
LP2992AIM5X-3.3/NO.B	Active	Production	SOT-23 (DBV) 5	3000 LARGE T&R	-	Call TI	Call TI	-40 to 125	
LP2992AIM5X-3.3/NOPB	Active	Production	SOT-23 (DBV) 5	3000 LARGE T&R	Yes	NIPDAU SN	Level-1-260C-UNLIM	-40 to 125	LFEA
LP2992AIM5X-5.0/NO.A	Active	Production	SOT-23 (DBV) 5	3000 LARGE T&R	Yes	SN	Level-1-260C-UNLIM	-40 to 125	LFFA
LP2992AIM5X-5.0/NOPB	Active	Production	SOT-23 (DBV) 5	3000 LARGE T&R	Yes	SN	Level-1-260C-UNLIM	-40 to 125	LFFA
LP2992ILD-1.8/NOPB	Active	Production	WSON (NGD) 6	1000 SMALL T&R	Yes	NIPDAU SN	Level-3-260C-168 HR	-40 to 125	L012A B
LP2992ILD-1.8/NOPB.A	Active	Production	WSON (NGD) 6	1000 SMALL T&R	Yes	SN	Level-3-260C-168 HR	-40 to 125	L012A B
LP2992ILD-1.8/NOPB.B	Active	Production	WSON (NGD) 6	1000 SMALL T&R	Yes	SN	Level-3-260C-168 HR	-40 to 125	L012A B
LP2992ILD-2.5/NOPB	Active	Production	WSON (NGD) 6	1000 SMALL T&R	Yes	SN	Level-3-260C-168 HR	-40 to 125	L013A B
LP2992ILD-2.5/NOPB.A	Active	Production	WSON (NGD) 6	1000 SMALL T&R	Yes	SN	Level-3-260C-168 HR	-40 to 125	L013A B
LP2992ILD-2.5/NOPB.B	Active	Production	WSON (NGD) 6	1000 SMALL T&R	Yes	SN	Level-3-260C-168 HR	-40 to 125	L013A B
LP2992ILD-3.3/NOPB	Active	Production	WSON (NGD) 6	1000 SMALL T&R	Yes	NIPDAU SN	Level-3-260C-168 HR	-40 to 125	L014A B
LP2992ILD-3.3/NOPB.A	Active	Production	WSON (NGD) 6	1000 SMALL T&R	Yes	SN	Level-3-260C-168 HR	-40 to 125	L014A B
LP2992ILD-3.3/NOPB.B	Active	Production	WSON (NGD) 6	1000 SMALL T&R	Yes	SN	Level-3-260C-168 HR	-40 to 125	L014A B
LP2992ILD-5.0/NOPB	Active	Production	WSON (NGD) 6	1000 SMALL T&R	Yes	NIPDAU SN	Level-3-260C-168 HR	-40 to 125	L015A B
LP2992ILD-5.0/NOPB.A	Active	Production	WSON (NGD) 6	1000 SMALL T&R	Yes	SN	Level-3-260C-168 HR	-40 to 125	L015A B
LP2992ILD-5.0/NOPB.B	Active	Production	WSON (NGD) 6	1000 SMALL T&R	Yes	SN	Level-3-260C-168 HR	-40 to 125	L015A B
LP2992ILD-1.5/NO.A	Active	Production	WSON (NGD) 6	4500 LARGE T&R	Yes	SN	Level-3-260C-168 HR	-40 to 125	L011A B
LP2992ILD-1.5/NOPB	Active	Production	WSON (NGD) 6	4500 LARGE T&R	Yes	NIPDAU SN	Level-3-260C-168 HR	-40 to 125	L011A B
LP2992ILD-3.3/NO.A	Active	Production	WSON (NGD) 6	4500 LARGE T&R	Yes	SN	Level-3-260C-168 HR	-40 to 125	L014A B

Orderable part number	Status (1)	Material type (2)	Package Pins	Package qty Carrier	RoHS (3)	Lead finish/ Ball material (4)	MSL rating/ Peak reflow (5)	Op temp (°C)	Part marking (6)
LP2992ILDY-3.3/NOPB	Active	Production	WSON (NGD) 6	4500 LARGE T&R	Yes	NIPDAU SN	Level-3-260C-168 HR	-40 to 125	L014A B
LP2992ILDY-5.0/NO.A	Active	Production	WSON (NGD) 6	4500 LARGE T&R	Yes	SN	Level-3-260C-168 HR	-40 to 125	L015A B
LP2992ILDY-5.0/NOPB	Active	Production	WSON (NGD) 6	4500 LARGE T&R	Yes	SN	Level-3-260C-168 HR	-40 to 125	L015A B
LP2992IM5-1.5/NOPB	Active	Production	SOT-23 (DBV) 5	1000 LARGE T&R	Yes	SN	Level-1-260C-UNLIM	-40 to 125	LFBB
LP2992IM5-1.5/NOPB.A	Active	Production	SOT-23 (DBV) 5	1000 LARGE T&R	Yes	SN	Level-1-260C-UNLIM	-40 to 125	LFBB
LP2992IM5-1.5/NOPB.B	Active	Production	SOT-23 (DBV) 5	1000 LARGE T&R	Yes	SN	Level-1-260C-UNLIM	-40 to 125	LFBB
LP2992IM5-1.8/NOPB	Active	Production	SOT-23 (DBV) 5	3000 LARGE T&R	Yes	SN	Level-1-260C-UNLIM	-40 to 125	LFCE
LP2992IM5-1.8/NOPB.A	Active	Production	SOT-23 (DBV) 5	3000 LARGE T&R	Yes	SN	Level-1-260C-UNLIM	-40 to 125	LFCE
LP2992IM5-2.5/NOPB	Active	Production	SOT-23 (DBV) 5	1000 SMALL T&R	Yes	SN	Level-1-260C-UNLIM	-40 to 125	LFDB
LP2992IM5-2.5/NOPB.A	Active	Production	SOT-23 (DBV) 5	1000 SMALL T&R	Yes	SN	Level-1-260C-UNLIM	-40 to 125	LFDB
LP2992IM5-2.5/NOPB.B	Active	Production	SOT-23 (DBV) 5	1000 SMALL T&R	Yes	SN	Level-1-260C-UNLIM	-40 to 125	LFDB
LP2992IM5-3.0/NOPB	Active	Production	SOT-23 (DBV) 5	1000 LARGE T&R	Yes	SN	Level-1-260C-UNLIM	-40 to 125	LF8B
LP2992IM5-3.0/NOPB.A	Active	Production	SOT-23 (DBV) 5	1000 LARGE T&R	Yes	SN	Level-1-260C-UNLIM	-40 to 125	LF8B
LP2992IM5-3.0/NOPB.B	Active	Production	SOT-23 (DBV) 5	1000 LARGE T&R	Yes	SN	Level-1-260C-UNLIM	-40 to 125	LF8B
LP2992IM5-3.3/NOPB	Active	Production	SOT-23 (DBV) 5	3000 LARGE T&R	Yes	NIPDAU SN	Level-1-260C-UNLIM	-40 to 125	LFEB
LP2992IM5-3.3/NOPB.A	Active	Production	SOT-23 (DBV) 5	3000 LARGE T&R	Yes	NIPDAU	Level-1-260C-UNLIM	-40 to 125	LFEB
LP2992IM5-5.0/NOPB	Active	Production	SOT-23 (DBV) 5	3000 LARGE T&R	Yes	SN	Level-1-260C-UNLIM	-40 to 125	LFEB
LP2992IM5-5.0/NOPB.A	Active	Production	SOT-23 (DBV) 5	3000 LARGE T&R	Yes	SN	Level-1-260C-UNLIM	-40 to 125	LFEB
LP2992IM5X-1.5/NO.A	Active	Production	SOT-23 (DBV) 5	3000 LARGE T&R	Yes	SN	Level-1-260C-UNLIM	-40 to 125	LFBB
LP2992IM5X-1.5/NOPB	Active	Production	SOT-23 (DBV) 5	3000 LARGE T&R	Yes	SN	Level-1-260C-UNLIM	-40 to 125	LFBB
LP2992IM5X-1.8/NO.A	Active	Production	SOT-23 (DBV) 5	3000 LARGE T&R	Yes	SN	Level-1-260C-UNLIM	-40 to 125	LFCE
LP2992IM5X-1.8/NOPB	Active	Production	SOT-23 (DBV) 5	3000 LARGE T&R	Yes	SN	Level-1-260C-UNLIM	-40 to 125	LFCE
LP2992IM5X-2.5/NO.A	Active	Production	SOT-23 (DBV) 5	3000 LARGE T&R	Yes	SN	Level-1-260C-UNLIM	-40 to 125	LFDB
LP2992IM5X-2.5/NOPB	Active	Production	SOT-23 (DBV) 5	3000 LARGE T&R	Yes	SN	Level-1-260C-UNLIM	-40 to 125	LFDB
LP2992IM5X-3.3/NO.A	Active	Production	SOT-23 (DBV) 5	3000 LARGE T&R	Yes	NIPDAU	Level-1-260C-UNLIM	-40 to 125	LFEB
LP2992IM5X-3.3/NO.B	Active	Production	SOT-23 (DBV) 5	3000 LARGE T&R	-	Call TI	Call TI	-40 to 125	
LP2992IM5X-3.3/NOPB	Active	Production	SOT-23 (DBV) 5	3000 LARGE T&R	Yes	NIPDAU SN	Level-1-260C-UNLIM	-40 to 125	LFEB
LP2992IM5X-5.0/NO.A	Active	Production	SOT-23 (DBV) 5	3000 LARGE T&R	Yes	SN	Level-1-260C-UNLIM	-40 to 125	LFEB

Orderable part number	Status (1)	Material type (2)	Package Pins	Package qty Carrier	RoHS (3)	Lead finish/ Ball material (4)	MSL rating/ Peak reflow (5)	Op temp (°C)	Part marking (6)
LP2992IM5X-5.0/NOPB	Active	Production	SOT-23 (DBV) 5	3000 LARGE T&R	Yes	SN	Level-1-260C-UNLIM	-40 to 125	LFFB

⁽¹⁾ **Status:** For more details on status, see our [product life cycle](#).

⁽²⁾ **Material type:** When designated, preproduction parts are prototypes/experimental devices, and are not yet approved or released for full production. Testing and final process, including without limitation quality assurance, reliability performance testing, and/or process qualification, may not yet be complete, and this item is subject to further changes or possible discontinuation. If available for ordering, purchases will be subject to an additional waiver at checkout, and are intended for early internal evaluation purposes only. These items are sold without warranties of any kind.

⁽³⁾ **RoHS values:** Yes, No, RoHS Exempt. See the [TI RoHS Statement](#) for additional information and value definition.

⁽⁴⁾ **Lead finish/Ball material:** Parts may have multiple material finish options. Finish options are separated by a vertical ruled line. Lead finish/Ball material values may wrap to two lines if the finish value exceeds the maximum column width.

⁽⁵⁾ **MSL rating/Peak reflow:** The moisture sensitivity level ratings and peak solder (reflow) temperatures. In the event that a part has multiple moisture sensitivity ratings, only the lowest level per JEDEC standards is shown. Refer to the shipping label for the actual reflow temperature that will be used to mount the part to the printed circuit board.

⁽⁶⁾ **Part marking:** There may be an additional marking, which relates to the logo, the lot trace code information, or the environmental category of the part.

Multiple part markings will be inside parentheses. Only one part marking contained in parentheses and separated by a "~" will appear on a part. If a line is indented then it is a continuation of the previous line and the two combined represent the entire part marking for that device.

Important Information and Disclaimer: The information provided on this page represents TI's knowledge and belief as of the date that it is provided. TI bases its knowledge and belief on information provided by third parties, and makes no representation or warranty as to the accuracy of such information. Efforts are underway to better integrate information from third parties. TI has taken and continues to take reasonable steps to provide representative and accurate information but may not have conducted destructive testing or chemical analysis on incoming materials and chemicals. TI and TI suppliers consider certain information to be proprietary, and thus CAS numbers and other limited information may not be available for release.

In no event shall TI's liability arising out of such information exceed the total purchase price of the TI part(s) at issue in this document sold by TI to Customer on an annual basis.

TAPE AND REEL INFORMATION

QUADRANT ASSIGNMENTS FOR PIN 1 ORIENTATION IN TAPE

*All dimensions are nominal

Device	Package Type	Package Drawing	Pins	SPQ	Reel Diameter (mm)	Reel Width W1 (mm)	A0 (mm)	B0 (mm)	K0 (mm)	P1 (mm)	W (mm)	Pin1 Quadrant
LP2992AILD-1.5/NOPB	WSO	NGD	6	1000	177.8	12.4	3.6	3.2	1.0	8.0	12.0	Q1
LP2992AILD-1.8/NOPB	WSO	NGD	6	1000	177.8	12.4	3.6	3.2	1.0	8.0	12.0	Q1
LP2992AILD-3.3/NOPB	WSO	NGD	6	1000	177.8	12.4	3.6	3.2	1.0	8.0	12.0	Q1
LP2992AILD-5.0/NOPB	WSO	NGD	6	1000	180.0	12.4	3.6	3.2	1.0	8.0	12.0	Q1
LP2992AILD-5.0/NOPB	WSO	NGD	6	1000	177.8	12.4	3.6	3.2	1.0	8.0	12.0	Q1
LP2992AILD-5.0/NOPB	WSO	NGD	6	1000	177.8	12.4	3.6	3.2	1.0	8.0	12.0	Q1
LP2992AILD-5.0/NOPB	WSO	NGD	6	1000	177.8	12.4	3.6	3.2	1.0	8.0	12.0	Q1
LP2992AILD-5.0/NOPB	WSO	NGD	6	1000	177.8	12.4	3.6	3.2	1.0	8.0	12.0	Q1
LP2992AILD-5.0/NOPB	WSO	NGD	6	1000	177.8	12.4	3.6	3.2	1.0	8.0	12.0	Q1
LP2992AILD-5.0/NOPB	WSO	NGD	6	1000	177.8	12.4	3.6	3.2	1.0	8.0	12.0	Q1
LP2992AILD-5.0/NOPB	WSO	NGD	6	1000	177.8	12.4	3.6	3.2	1.0	8.0	12.0	Q1
LP2992AIM5-1.5/NOPB	SOT-23	DBV	5	1000	178.0	8.4	3.2	3.2	1.4	4.0	8.0	Q3
LP2992AIM5-1.8/NOPB	SOT-23	DBV	5	3000	180.0	8.4	3.2	3.2	1.4	4.0	8.0	Q3
LP2992AIM5-2.5/NOPB	SOT-23	DBV	5	3000	178.0	8.4	3.2	3.2	1.4	4.0	8.0	Q3
LP2992AIM5-3.3/NOPB	SOT-23	DBV	5	3000	178.0	8.4	3.2	3.2	1.4	4.0	8.0	Q3
LP2992AIM5-5.0/NOPB	SOT-23	DBV	5	3000	178.0	8.4	3.2	3.2	1.4	4.0	8.0	Q3
LP2992AIM5X-1.5/NOPB	SOT-23	DBV	5	3000	178.0	8.4	3.2	3.2	1.4	4.0	8.0	Q3
LP2992AIM5X-1.8/NOPB	SOT-23	DBV	5	3000	178.0	8.4	3.2	3.2	1.4	4.0	8.0	Q3
LP2992AIM5X-2.5/NOPB	SOT-23	DBV	5	3000	178.0	8.4	3.2	3.2	1.4	4.0	8.0	Q3
LP2992AIM5X-3.3/NOPB	SOT-23	DBV	5	3000	178.0	8.4	3.2	3.2	1.4	4.0	8.0	Q3

Device	Package Type	Package Drawing	Pins	SPQ	Reel Diameter (mm)	Reel Width W1 (mm)	A0 (mm)	B0 (mm)	K0 (mm)	P1 (mm)	W (mm)	Pin1 Quadrant
LP2992AIM5X-5.0/NOPB	SOT-23	DBV	5	3000	178.0	8.4	3.2	3.2	1.4	4.0	8.0	Q3
LP2992ILD-1.8/NOPB	WSON	NGD	6	1000	177.8	12.4	3.6	3.2	1.0	8.0	12.0	Q1
LP2992ILD-2.5/NOPB	WSON	NGD	6	1000	177.8	12.4	3.6	3.2	1.0	8.0	12.0	Q1
LP2992ILD-3.3/NOPB	WSON	NGD	6	1000	177.8	12.4	3.6	3.2	1.0	8.0	12.0	Q1
LP2992ILD-5.0/NOPB	WSON	NGD	6	1000	180.0	12.4	3.6	3.2	1.0	8.0	12.0	Q1
LP2992ILD-5.0/NOPB	WSON	NGD	6	1000	177.8	12.4	3.6	3.2	1.0	8.0	12.0	Q1
LP2992ILD-1.5/NOPB	WSON	NGD	6	4500	330.0	12.4	3.6	3.2	1.0	8.0	12.0	Q1
LP2992ILD-1.5/NOPB	WSON	NGD	6	4500	330.0	12.4	3.6	3.2	1.0	8.0	12.0	Q1
LP2992ILD-3.3/NOPB	WSON	NGD	6	4500	330.0	12.4	3.6	3.2	1.0	8.0	12.0	Q1
LP2992ILD-5.0/NOPB	WSON	NGD	6	4500	330.0	12.4	3.6	3.2	1.0	8.0	12.0	Q1
LP2992IM5-1.5/NOPB	SOT-23	DBV	5	1000	178.0	8.4	3.2	3.2	1.4	4.0	8.0	Q3
LP2992IM5-1.8/NOPB	SOT-23	DBV	5	3000	178.0	8.4	3.2	3.2	1.4	4.0	8.0	Q3
LP2992IM5-2.5/NOPB	SOT-23	DBV	5	1000	178.0	8.4	3.2	3.2	1.4	4.0	8.0	Q3
LP2992IM5-3.0/NOPB	SOT-23	DBV	5	1000	178.0	8.4	3.2	3.2	1.4	4.0	8.0	Q3
LP2992IM5-3.3/NOPB	SOT-23	DBV	5	3000	178.0	8.4	3.2	3.2	1.4	4.0	8.0	Q3
LP2992IM5-5.0/NOPB	SOT-23	DBV	5	3000	180.0	8.4	3.2	3.2	1.4	4.0	8.0	Q3
LP2992IM5X-1.5/NOPB	SOT-23	DBV	5	3000	178.0	8.4	3.2	3.2	1.4	4.0	8.0	Q3
LP2992IM5X-1.8/NOPB	SOT-23	DBV	5	3000	178.0	8.4	3.2	3.2	1.4	4.0	8.0	Q3
LP2992IM5X-2.5/NOPB	SOT-23	DBV	5	3000	178.0	8.4	3.2	3.2	1.4	4.0	8.0	Q3
LP2992IM5X-3.3/NOPB	SOT-23	DBV	5	3000	178.0	8.4	3.2	3.2	1.4	4.0	8.0	Q3
LP2992IM5X-5.0/NOPB	SOT-23	DBV	5	3000	178.0	8.4	3.2	3.2	1.4	4.0	8.0	Q3

TAPE AND REEL BOX DIMENSIONS



*All dimensions are nominal

Device	Package Type	Package Drawing	Pins	SPQ	Length (mm)	Width (mm)	Height (mm)
LP2992AILD-1.5/NOPB	WSON	NGD	6	1000	208.0	191.0	35.0
LP2992AILD-1.8/NOPB	WSON	NGD	6	1000	208.0	191.0	35.0
LP2992AILD-3.3/NOPB	WSON	NGD	6	1000	208.0	191.0	35.0
LP2992AILD-5.0/NOPB	WSON	NGD	6	1000	213.0	191.0	35.0
LP2992AILD-5.0/NOPB	WSON	NGD	6	1000	208.0	191.0	35.0
LP2992AILDX-3.3/NOPB	WSON	NGD	6	4500	356.0	356.0	36.0
LP2992AILDX-5.0/NOPB	WSON	NGD	6	4500	356.0	356.0	36.0
LP2992AIM5-1.5/NOPB	SOT-23	DBV	5	1000	208.0	191.0	35.0
LP2992AIM5-1.8/NOPB	SOT-23	DBV	5	3000	210.0	185.0	35.0
LP2992AIM5-2.5/NOPB	SOT-23	DBV	5	3000	208.0	191.0	35.0
LP2992AIM5-3.3/NOPB	SOT-23	DBV	5	3000	208.0	191.0	35.0
LP2992AIM5-5.0/NOPB	SOT-23	DBV	5	3000	208.0	191.0	35.0
LP2992AIM5X-1.5/NOPB	SOT-23	DBV	5	3000	208.0	191.0	35.0
LP2992AIM5X-1.8/NOPB	SOT-23	DBV	5	3000	208.0	191.0	35.0
LP2992AIM5X-2.5/NOPB	SOT-23	DBV	5	3000	208.0	191.0	35.0
LP2992AIM5X-3.3/NOPB	SOT-23	DBV	5	3000	208.0	191.0	35.0
LP2992AIM5X-5.0/NOPB	SOT-23	DBV	5	3000	208.0	191.0	35.0
LP2992ILD-1.8/NOPB	WSON	NGD	6	1000	208.0	191.0	35.0

Device	Package Type	Package Drawing	Pins	SPQ	Length (mm)	Width (mm)	Height (mm)
LP2992ILD-2.5/NOPB	WSON	NGD	6	1000	208.0	191.0	35.0
LP2992ILD-3.3/NOPB	WSON	NGD	6	1000	208.0	191.0	35.0
LP2992ILD-5.0/NOPB	WSON	NGD	6	1000	213.0	191.0	35.0
LP2992ILD-5.0/NOPB	WSON	NGD	6	1000	208.0	191.0	35.0
LP2992ILD-1.5/NOPB	WSON	NGD	6	4500	356.0	356.0	36.0
LP2992ILD-1.5/NOPB	WSON	NGD	6	4500	367.0	367.0	38.0
LP2992ILD-3.3/NOPB	WSON	NGD	6	4500	356.0	356.0	36.0
LP2992ILD-5.0/NOPB	WSON	NGD	6	4500	356.0	356.0	36.0
LP2992IM5-1.5/NOPB	SOT-23	DBV	5	1000	208.0	191.0	35.0
LP2992IM5-1.8/NOPB	SOT-23	DBV	5	3000	208.0	191.0	35.0
LP2992IM5-2.5/NOPB	SOT-23	DBV	5	1000	208.0	191.0	35.0
LP2992IM5-3.0/NOPB	SOT-23	DBV	5	1000	208.0	191.0	35.0
LP2992IM5-3.3/NOPB	SOT-23	DBV	5	3000	208.0	191.0	35.0
LP2992IM5-5.0/NOPB	SOT-23	DBV	5	3000	210.0	185.0	35.0
LP2992IM5X-1.5/NOPB	SOT-23	DBV	5	3000	208.0	191.0	35.0
LP2992IM5X-1.8/NOPB	SOT-23	DBV	5	3000	208.0	191.0	35.0
LP2992IM5X-2.5/NOPB	SOT-23	DBV	5	3000	208.0	191.0	35.0
LP2992IM5X-3.3/NOPB	SOT-23	DBV	5	3000	208.0	191.0	35.0
LP2992IM5X-5.0/NOPB	SOT-23	DBV	5	3000	208.0	191.0	35.0

NGD0006A

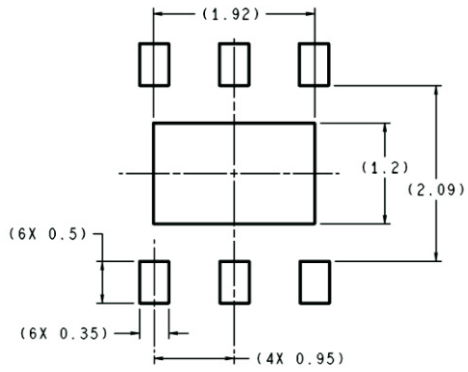

RECOMMENDED LAND PATTERN
1:1 RATIO WITH PKG SOLDER PADS

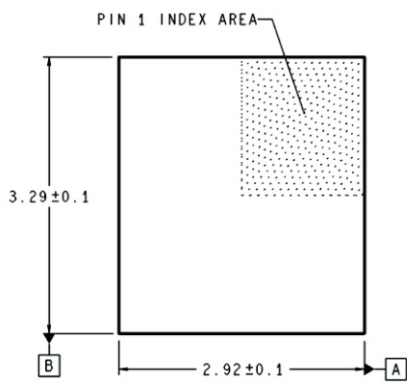

DIMENSIONS ARE IN MILLIMETERS

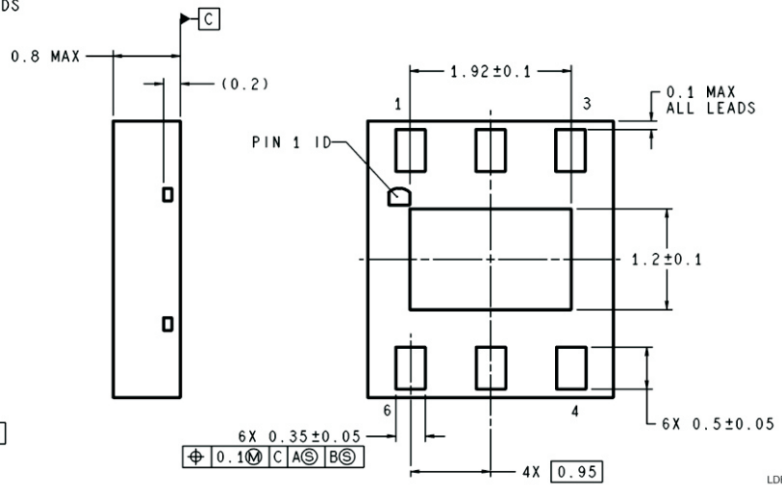

LDE06A (Rev A)



DBV0005A

PACKAGE OUTLINE

SOT-23 - 1.45 mm max height

SMALL OUTLINE TRANSISTOR

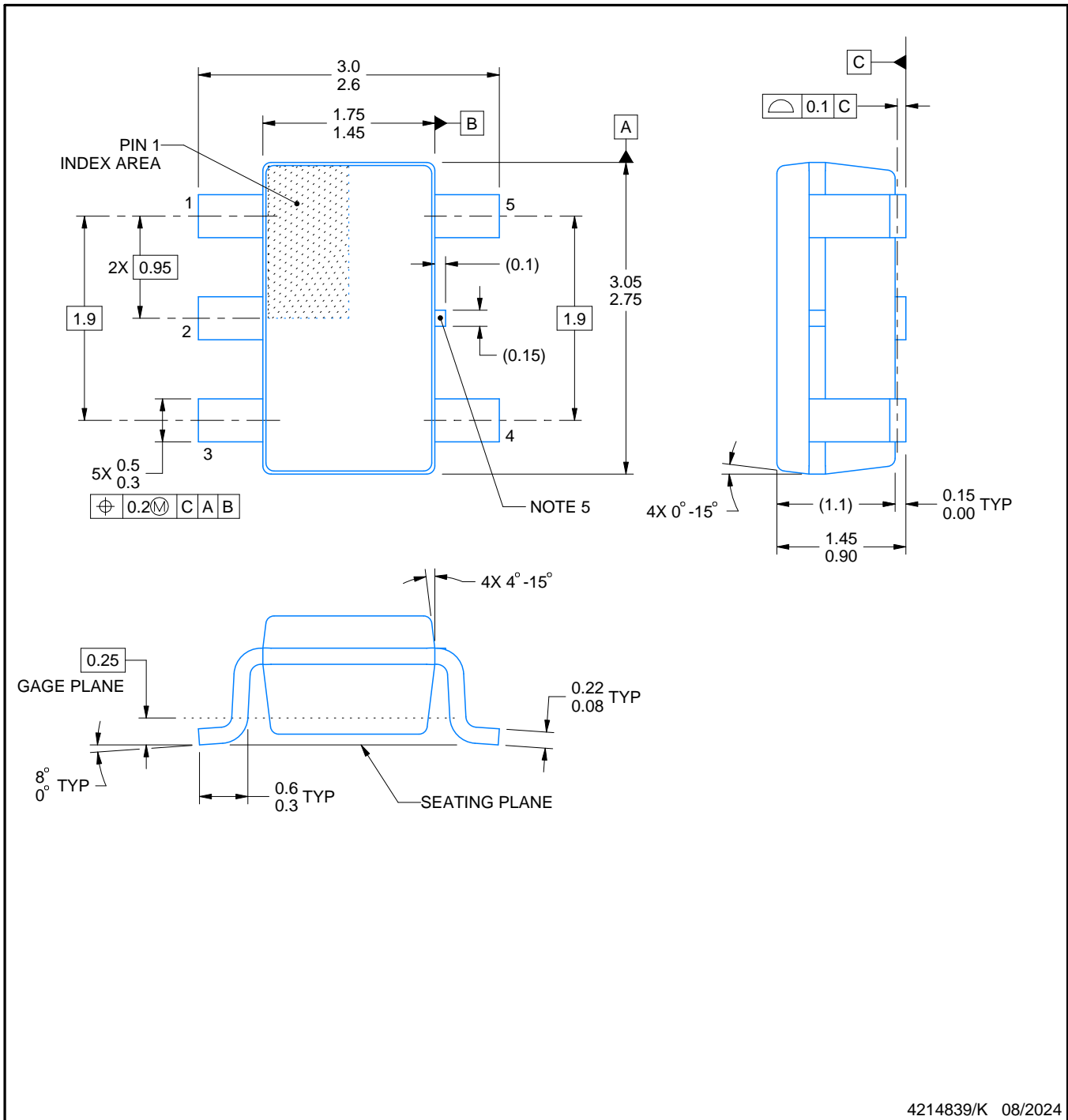

4214839/K 08/2024

NOTES:

- All linear dimensions are in millimeters. Any dimensions in parenthesis are for reference only. Dimensioning and tolerancing per ASME Y14.5M.
- This drawing is subject to change without notice.
- Reference JEDEC MO-178.
- Body dimensions do not include mold flash, protrusions, or gate burrs. Mold flash, protrusions, or gate burrs shall not exceed 0.25 mm per side.
- Support pin may differ or may not be present.

EXAMPLE BOARD LAYOUT

DBV0005A

SOT-23 - 1.45 mm max height

SMALL OUTLINE TRANSISTOR



LAND PATTERN EXAMPLE
EXPOSED METAL SHOWN
SCALE:15X



SOLDER MASK DETAILS

4214839/K 08/2024

NOTES: (continued)

- 6. Publication IPC-7351 may have alternate designs.
- 7. Solder mask tolerances between and around signal pads can vary based on board fabrication site.

EXAMPLE STENCIL DESIGN

DBV0005A

SOT-23 - 1.45 mm max height

SMALL OUTLINE TRANSISTOR



SOLDER PASTE EXAMPLE
BASED ON 0.125 mm THICK STENCIL
SCALE:15X

4214839/K 08/2024

NOTES: (continued)

8. Laser cutting apertures with trapezoidal walls and rounded corners may offer better paste release. IPC-7525 may have alternate design recommendations.
9. Board assembly site may have different recommendations for stencil design.

IMPORTANT NOTICE AND DISCLAIMER

TI PROVIDES TECHNICAL AND RELIABILITY DATA (INCLUDING DATASHEETS), DESIGN RESOURCES (INCLUDING REFERENCE DESIGNS), APPLICATION OR OTHER DESIGN ADVICE, WEB TOOLS, SAFETY INFORMATION, AND OTHER RESOURCES "AS IS" AND WITH ALL FAULTS, AND DISCLAIMS ALL WARRANTIES, EXPRESS AND IMPLIED, INCLUDING WITHOUT LIMITATION ANY IMPLIED WARRANTIES OF MERCHANTABILITY, FITNESS FOR A PARTICULAR PURPOSE OR NON-INFRINGEMENT OF THIRD PARTY INTELLECTUAL PROPERTY RIGHTS.

These resources are intended for skilled developers designing with TI products. You are solely responsible for (1) selecting the appropriate TI products for your application, (2) designing, validating and testing your application, and (3) ensuring your application meets applicable standards, and any other safety, security, regulatory or other requirements.

These resources are subject to change without notice. TI grants you permission to use these resources only for development of an application that uses the TI products described in the resource. Other reproduction and display of these resources is prohibited. No license is granted to any other TI intellectual property right or to any third party intellectual property right. TI disclaims responsibility for, and you fully indemnify TI and its representatives against any claims, damages, costs, losses, and liabilities arising out of your use of these resources.

TI's products are provided subject to [TI's Terms of Sale](#), [TI's General Quality Guidelines](#), or other applicable terms available either on [ti.com](#) or provided in conjunction with such TI products. TI's provision of these resources does not expand or otherwise alter TI's applicable warranties or warranty disclaimers for TI products. Unless TI explicitly designates a product as custom or customer-specified, TI products are standard, catalog, general purpose devices.

TI objects to and rejects any additional or different terms you may propose.

Copyright © 2025, Texas Instruments Incorporated

Last updated 10/2025