

SN74HCT14-Q1 HEX SCHMITT-TRIGGER INVERTER

SCLS588A – JULY 2004 – REVISED APRIL 2008

- Qualified for Automotive Applications
- Operating Voltage Range of 4.5 V to 5.5 V
- Outputs Can Drive Up To 10 LSTTL Loads
- Low Power Consumption, 20- μ A Max I_{CC}
- \pm 4-mA Output Drive at 5 V
- Low Input Current of 1 μ A Max
- Inputs Are TTL-Voltage Compatible

D OR PW PACKAGE
(TOP VIEW)

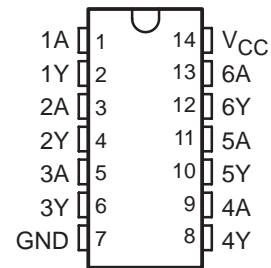

description/ordering information

The SN74HCT14 device contains six independent inverters. The device performs the Boolean function $Y = \bar{A}$ in positive logic.

ORDERING INFORMATION†

TA	PACKAGE‡		ORDERABLE PART NUMBER	TOP-SIDE MARKING
-40°C to 125°C	SOIC – D	Reel of 2500	SN74HCT14QDRQ1	HCT14Q
	TSSOP – PW	Reel of 2000	SN74HCT14QPWRQ1	HCT14Q

† For the most current package and ordering information, see the Package Option Addendum at the end of this document, or see the TI web site at <http://www.ti.com>.

‡ Package drawings, thermal data, and symbolization are available at <http://www.ti.com/packaging>.

FUNCTION TABLE
(each inverter)

INPUT A	OUTPUT Y
H	L
L	H

logic diagram (positive logic)



Please be aware that an important notice concerning availability, standard warranty, and use in critical applications of Texas Instruments semiconductor products and disclaimers thereto appears at the end of this data sheet.

PRODUCTION DATA information is current as of publication date. Products conform to specifications per the terms of Texas Instruments standard warranty. Production processing does not necessarily include testing of all parameters.

 **TEXAS
INSTRUMENTS**

POST OFFICE BOX 655303 • DALLAS, TEXAS 75265

Copyright © 2008, Texas Instruments Incorporated

SN74HCT14-Q1

HEX SCHMITT-TRIGGER INVERTER

SCLS588A – JULY 2004 – REVISED APRIL 2008

absolute maximum ratings over operating free-air temperature range (unless otherwise noted)†

Supply voltage range, V_{CC}	-0.5 V to 7 V
Input voltage range, V_I (see Note 1)	-0.5 V to $V_{CC} + 0.5$ V
Output voltage range, V_O (see Note 1)	-0.5 V to $V_{CC} + 0.5$ V
Input clamp current, I_{IK} ($V_I < 0$ or $V_I > V_{CC}$)	± 20 mA
Output clamp current, I_{OK} ($V_O < 0$ or $V_O > V_{CC}$)	± 20 mA
Continuous output current, I_O ($V_O = 0$ to V_{CC})	± 25 mA
Continuous current through V_{CC} or GND	± 50 mA
Package thermal impedance, θ_{JA} (see Note 2): D package	86°C/W
PW package	113°C/W
Storage temperature range, T_{stg}	-65°C to 150°C

† Stresses beyond those listed under “absolute maximum ratings” may cause permanent damage to the device. These are stress ratings only, and functional operation of the device at these or any other conditions beyond those indicated under “recommended operating conditions” is not implied. Exposure to absolute-maximum-rated conditions for extended periods may affect device reliability.

- NOTES: 1. The input and output voltage ratings may be exceeded if the input and output current ratings are observed.
 2. The package thermal impedance is calculated in accordance with JESD 51-7.

recommended operating conditions (see Note 3)

	MIN	MAX	UNIT
V_{CC} Supply voltage	4.5	5.5	V
V_I Input voltage	0	V_{CC}	V
V_O Output voltage	0	V_{CC}	V
T_A Operating free-air temperature	-40	125	°C

NOTE 3: All unused inputs of the device must be held at V_{CC} or GND to ensure proper device operation. Refer to the TI application report, *Implications of Slow or Floating CMOS Inputs*, literature number SCBA004.

electrical characteristics over recommended operating free-air temperature range (unless otherwise noted)

PARAMETER	TEST CONDITIONS	V_{CC}	$T_A = 25^\circ\text{C}$			MIN	MAX	UNIT
			MIN	TYP	MAX			
V_{T+} Positive-going threshold		4.5 V	1.2	1.5	1.9	1.2	1.9	V
		5.5 V	1.4	1.7	2.1	1.4	2.1	
V_{T-} Negative-going threshold		4.5 V	0.5	0.9	1.2	0.5	1.2	V
		5.5 V	0.6	1	1.4	0.6	1.4	
ΔV_T Hysteresis ($V_{T+} - V_{T-}$)		4.5 V	0.4	0.6	1.4	0.4	1.4	V
		5.5 V	0.4	0.65	1.5	0.4	1.5	
V_{OH}	$I_{OH} = -20 \mu\text{A}$	4.5 V	4.4	4.49		4.4		V
	$I_{OH} = -4 \text{ mA}$	4.5 V	3.98	4.3		3.7		
V_{OL}	$I_{OL} = 20 \mu\text{A}$	4.5 V		0.001	0.1		0.1	V
	$I_{OL} = 4 \text{ mA}$	4.5 V		0.17	0.26		0.4	
I_I	$V_I = V_{CC}$ or GND	5.5 V				± 0.1	± 1	μA
I_{CC}	$V_I = V_{CC}$ or GND, $I_O = 0$	5.5 V			2		40	μA
ΔI_{CC}^\ddagger	One input at 0.5 V or 2.4 V, Other inputs at GND or V_{CC}	5.5 V		0.2	2.4		3	mA
C_i	$V_I = V_{CC}$ or GND	5 V		3	10		10	pF

‡ This is the increase in supply current for each input that is at one of the specified TTL voltage levels, rather than 0 V or V_{CC} .



switching characteristics over recommended operating free-air temperature range, $C_L = 50$ pF (unless otherwise noted) (see Figure 1)

PARAMETER	FROM (INPUT)	TO (OUTPUT)	V_{CC}	$T_A = 25^\circ\text{C}$			MIN	MAX	UNIT
				MIN	TYP	MAX			
t_{pd}	A	Y	4.5 V		20	32		48	ns
			5.5 V		18	30		45	
t_t		Y	4.5 V		7	15		22	ns
			5.5 V		6	14		20	

operating characteristics, $T_A = 25^\circ\text{C}$

PARAMETER	TEST CONDITIONS	TYP	UNIT
C_{pd} Power dissipation capacitance	No load	10	pF

PARAMETER MEASUREMENT INFORMATION

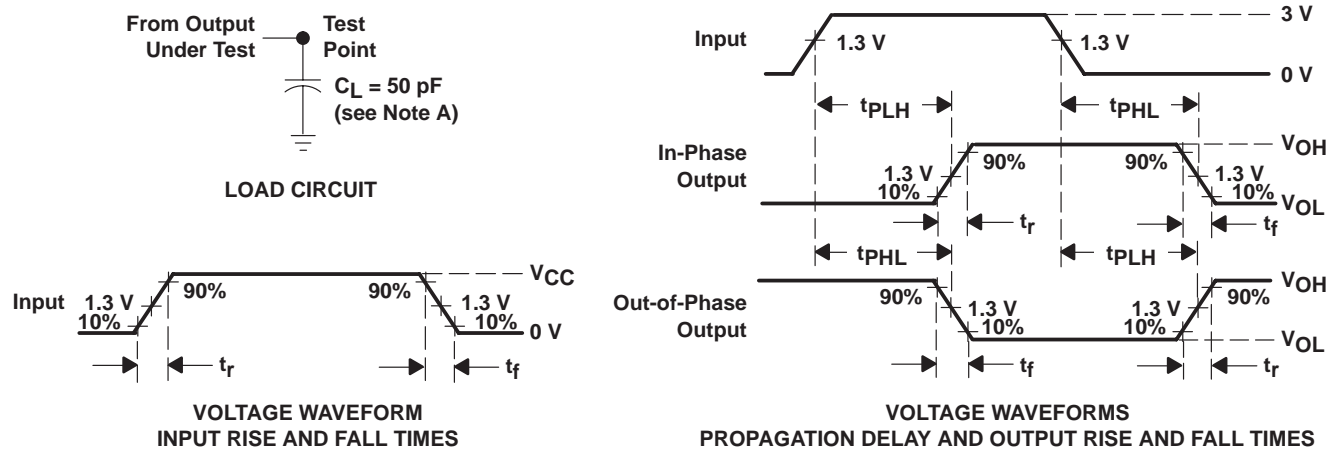

- NOTES:
- C_L includes probe and test-fixture capacitance.
 - Phase relationships between waveforms were chosen arbitrarily. All input pulses are supplied by generators having the following characteristics: $PRR \leq 1$ MHz, $Z_O = 50 \Omega$, $t_r = 6$ ns, $t_f = 6$ ns.
 - The outputs are measured one at a time, with one input transition per measurement.
 - t_{PLH} and t_{PHL} are the same as t_{pd} .

Figure 1. Load Circuit and Voltage Waveforms

SN74HCT14-Q1 HEX SCHMITT-TRIGGER INVERTER

SCLS588A – JULY 2004 – REVISED APRIL 2008

TYPICAL CHARACTERISTICS

SUPPLY CURRENT
vs
INPUT VOLTAGE

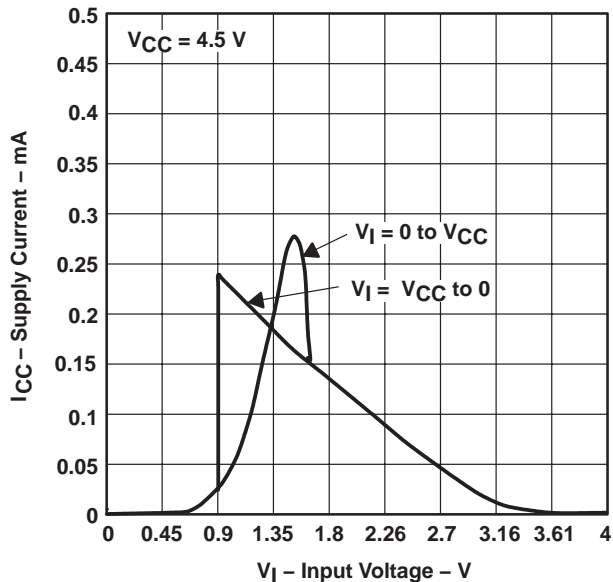

SUPPLY CURRENT
vs
INPUT VOLTAGE

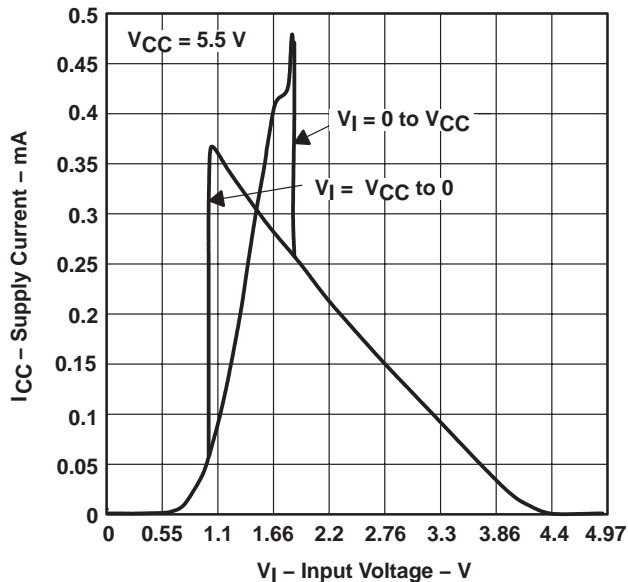

OUTPUT VOLTAGE
vs
INPUT VOLTAGE

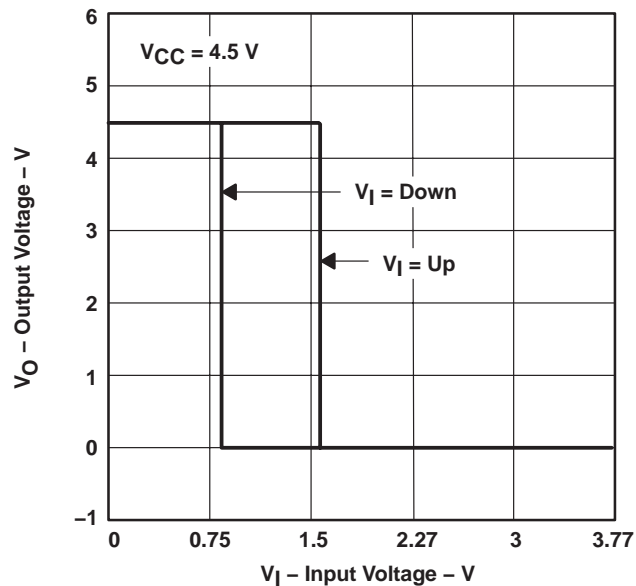

OUTPUT VOLTAGE
vs
INPUT VOLTAGE

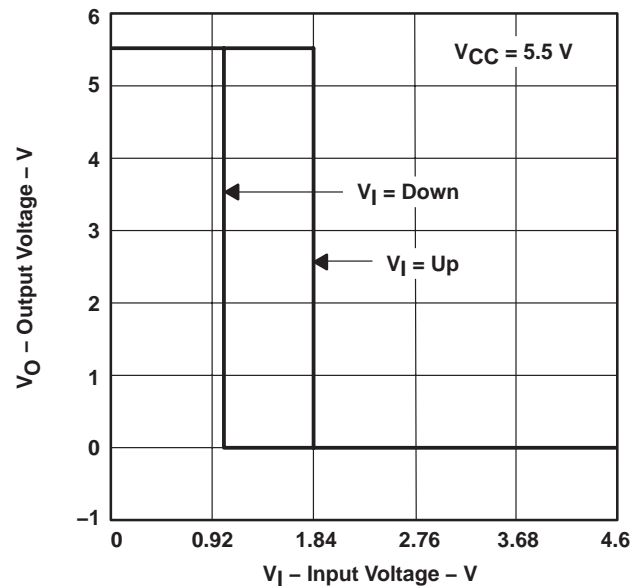

PACKAGING INFORMATION

Orderable part number	Status (1)	Material type (2)	Package Pins	Package qty Carrier	RoHS (3)	Lead finish/ Ball material (4)	MSL rating/ Peak reflow (5)	Op temp (°C)	Part marking (6)
SN74HCT14QPWRG4Q1	Active	Production	TSSOP (PW) 14	2000 LARGE T&R	Yes	NIPDAU	Level-1-260C-UNLIM	-40 to 125	HCT14Q
SN74HCT14QPWRG4Q1.A	Active	Production	TSSOP (PW) 14	2000 LARGE T&R	Yes	NIPDAU	Level-1-260C-UNLIM	-40 to 125	HCT14Q
SN74HCT14QPWRQ1	Active	Production	TSSOP (PW) 14	2000 LARGE T&R	Yes	NIPDAU	Level-3-260C-168 HR	-40 to 125	HCT14Q
SN74HCT14QPWRQ1.A	Active	Production	TSSOP (PW) 14	2000 LARGE T&R	Yes	NIPDAU	Level-3-260C-168 HR	-40 to 125	HCT14Q

(1) **Status:** For more details on status, see our [product life cycle](#).

(2) **Material type:** When designated, preproduction parts are prototypes/experimental devices, and are not yet approved or released for full production. Testing and final process, including without limitation quality assurance, reliability performance testing, and/or process qualification, may not yet be complete, and this item is subject to further changes or possible discontinuation. If available for ordering, purchases will be subject to an additional waiver at checkout, and are intended for early internal evaluation purposes only. These items are sold without warranties of any kind.

(3) **RoHS values:** Yes, No, RoHS Exempt. See the [TI RoHS Statement](#) for additional information and value definition.

(4) **Lead finish/Ball material:** Parts may have multiple material finish options. Finish options are separated by a vertical ruled line. Lead finish/Ball material values may wrap to two lines if the finish value exceeds the maximum column width.

(5) **MSL rating/Peak reflow:** The moisture sensitivity level ratings and peak solder (reflow) temperatures. In the event that a part has multiple moisture sensitivity ratings, only the lowest level per JEDEC standards is shown. Refer to the shipping label for the actual reflow temperature that will be used to mount the part to the printed circuit board.

(6) **Part marking:** There may be an additional marking, which relates to the logo, the lot trace code information, or the environmental category of the part.

Multiple part markings will be inside parentheses. Only one part marking contained in parentheses and separated by a "~" will appear on a part. If a line is indented then it is a continuation of the previous line and the two combined represent the entire part marking for that device.

Important Information and Disclaimer: The information provided on this page represents TI's knowledge and belief as of the date that it is provided. TI bases its knowledge and belief on information provided by third parties, and makes no representation or warranty as to the accuracy of such information. Efforts are underway to better integrate information from third parties. TI has taken and continues to take reasonable steps to provide representative and accurate information but may not have conducted destructive testing or chemical analysis on incoming materials and chemicals. TI and TI suppliers consider certain information to be proprietary, and thus CAS numbers and other limited information may not be available for release.

In no event shall TI's liability arising out of such information exceed the total purchase price of the TI part(s) at issue in this document sold by TI to Customer on an annual basis.

OTHER QUALIFIED VERSIONS OF SN74HCT14-Q1 :

- Catalog : [SN74HCT14](#)
- Military : [SN54HCT14](#)

NOTE: Qualified Version Definitions:

- Catalog - TI's standard catalog product
- Military - QML certified for Military and Defense Applications

TAPE AND REEL INFORMATION

QUADRANT ASSIGNMENTS FOR PIN 1 ORIENTATION IN TAPE

*All dimensions are nominal

Device	Package Type	Package Drawing	Pins	SPQ	Reel Diameter (mm)	Reel Width W1 (mm)	A0 (mm)	B0 (mm)	K0 (mm)	P1 (mm)	W (mm)	Pin1 Quadrant
SN74HCT14QPWRG4Q1	TSSOP	PW	14	2000	330.0	12.4	6.9	5.6	1.6	8.0	12.0	Q1
SN74HCT14QPWRQ1	TSSOP	PW	14	2000	330.0	12.4	6.9	5.6	1.6	8.0	12.0	Q1
SN74HCT14QPWRQ1	TSSOP	PW	14	2000	330.0	12.4	6.9	5.6	1.6	8.0	12.0	Q1

TAPE AND REEL BOX DIMENSIONS

*All dimensions are nominal

Device	Package Type	Package Drawing	Pins	SPQ	Length (mm)	Width (mm)	Height (mm)
SN74HCT14QPWRG4Q1	TSSOP	PW	14	2000	353.0	353.0	32.0
SN74HCT14QPWRQ1	TSSOP	PW	14	2000	353.0	353.0	32.0
SN74HCT14QPWRQ1	TSSOP	PW	14	2000	353.0	353.0	32.0

PW0014A

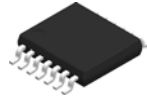

PACKAGE OUTLINE

TSSOP - 1.2 mm max height

SMALL OUTLINE PACKAGE



4220202/B 12/2023

NOTES:

1. All linear dimensions are in millimeters. Any dimensions in parenthesis are for reference only. Dimensioning and tolerancing per ASME Y14.5M.
2. This drawing is subject to change without notice.
3. This dimension does not include mold flash, protrusions, or gate burrs. Mold flash, protrusions, or gate burrs shall not exceed 0.15 mm per side.
4. This dimension does not include interlead flash. Interlead flash shall not exceed 0.25 mm per side.
5. Reference JEDEC registration MO-153.

EXAMPLE BOARD LAYOUT

PW0014A

TSSOP - 1.2 mm max height

SMALL OUTLINE PACKAGE



LAND PATTERN EXAMPLE
EXPOSED METAL SHOWN
SCALE: 10X



4220202/B 12/2023

NOTES: (continued)

- 6. Publication IPC-7351 may have alternate designs.
- 7. Solder mask tolerances between and around signal pads can vary based on board fabrication site.

EXAMPLE STENCIL DESIGN

PW0014A

TSSOP - 1.2 mm max height

SMALL OUTLINE PACKAGE



SOLDER PASTE EXAMPLE
BASED ON 0.125 mm THICK STENCIL
SCALE: 10X

4220202/B 12/2023

NOTES: (continued)

8. Laser cutting apertures with trapezoidal walls and rounded corners may offer better paste release. IPC-7525 may have alternate design recommendations.
9. Board assembly site may have different recommendations for stencil design.

IMPORTANT NOTICE AND DISCLAIMER

TI PROVIDES TECHNICAL AND RELIABILITY DATA (INCLUDING DATASHEETS), DESIGN RESOURCES (INCLUDING REFERENCE DESIGNS), APPLICATION OR OTHER DESIGN ADVICE, WEB TOOLS, SAFETY INFORMATION, AND OTHER RESOURCES "AS IS" AND WITH ALL FAULTS, AND DISCLAIMS ALL WARRANTIES, EXPRESS AND IMPLIED, INCLUDING WITHOUT LIMITATION ANY IMPLIED WARRANTIES OF MERCHANTABILITY, FITNESS FOR A PARTICULAR PURPOSE OR NON-INFRINGEMENT OF THIRD PARTY INTELLECTUAL PROPERTY RIGHTS.

These resources are intended for skilled developers designing with TI products. You are solely responsible for (1) selecting the appropriate TI products for your application, (2) designing, validating and testing your application, and (3) ensuring your application meets applicable standards, and any other safety, security, regulatory or other requirements.

These resources are subject to change without notice. TI grants you permission to use these resources only for development of an application that uses the TI products described in the resource. Other reproduction and display of these resources is prohibited. No license is granted to any other TI intellectual property right or to any third party intellectual property right. TI disclaims responsibility for, and you fully indemnify TI and its representatives against any claims, damages, costs, losses, and liabilities arising out of your use of these resources.

TI's products are provided subject to [TI's Terms of Sale](#), [TI's General Quality Guidelines](#), or other applicable terms available either on [ti.com](#) or provided in conjunction with such TI products. TI's provision of these resources does not expand or otherwise alter TI's applicable warranties or warranty disclaimers for TI products. Unless TI explicitly designates a product as custom or customer-specified, TI products are standard, catalog, general purpose devices.

TI objects to and rejects any additional or different terms you may propose.

Copyright © 2025, Texas Instruments Incorporated

Last updated 10/2025