

TL5002 PULSE-WIDTH-MODULATION CONTROL CIRCUIT

SLVS304A – SEPTEMBER 2000 – REVISED AUGUST 2002

- Complete PWM Power Control
- 3.6-V to 40-V Operation
- Internal Undervoltage-Lockout Circuit
- Oscillator Frequency . . . 20 kHz to 500 kHz
- Variable Dead Time Provides Control Over Total Range
- Ideal Controller for DDR Memory Application
- Uncommitted Error Amplifier Inputs

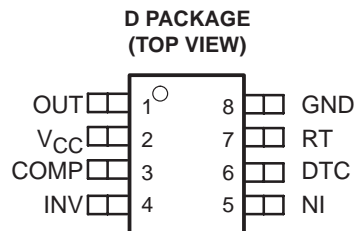

description

The TL5002 incorporates on a single monolithic chip all the functions required for a pulse-width-modulation (PWM) control circuit. Designed primarily for power-supply control, the TL5002 contains an error amplifier, a regulator, an oscillator, a PWM comparator with a dead-time-control input, undervoltage lockout (UVLO), and an open-collector output transistor.

The error-amplifier input common-mode voltage ranges from 0.9 V to 1.5 V. Dead-time control (DTC) can be set to provide 0% to 100% dead time by connecting an external resistor between DTC and GND. The oscillator frequency is set by terminating RT with an external resistor to GND. During low V_{CC} conditions, the UVLO circuit turns the output off until V_{CC} recovers to its normal operating range.

The TL5002 is characterized for operation from –40°C to 85°C.

AVAILABLE OPTIONS

T _A	SMALL OUTLINE (D)
–20°C to 85°C	TL5002CD
–40°C to 85°C	TL5002ID

The D package is available taped and reeled. Add the suffix R to the device type (e.g., TL5002CDR).

functional block diagram

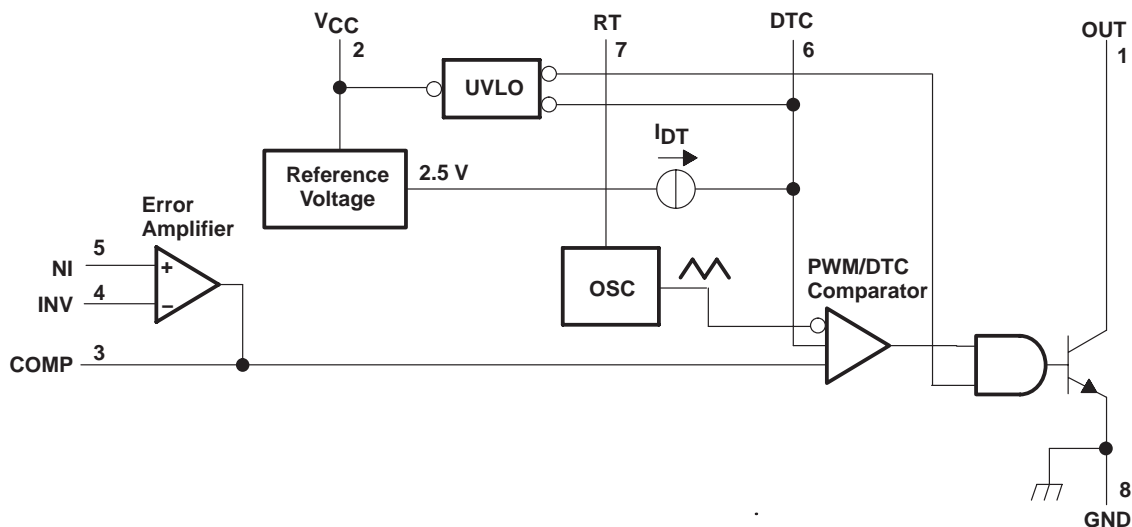

Please be aware that an important notice concerning availability, standard warranty, and use in critical applications of Texas Instruments semiconductor products and disclaimers thereto appears at the end of this data sheet.

PRODUCTION DATA information is current as of publication date. Products conform to specifications per the terms of Texas Instruments standard warranty. Production processing does not necessarily include testing of all parameters.

**TEXAS
INSTRUMENTS**

POST OFFICE BOX 655303 • DALLAS, TEXAS 75265

Copyright © 2002, Texas Instruments Incorporated

TL5002

PULSE-WIDTH-MODULATION CONTROL CIRCUIT

SLVS304A – SEPTEMBER 2000 – REVISED AUGUST 2002

detailed description

voltage reference

A 2.5-V regulator operating from V_{CC} is used to power the internal circuitry of the TL5002.

error amplifier

The error amplifier compares a sample of the dc-to-dc converter output voltage to an external reference voltage and generates an error signal for the PWM comparator. The dc-to-dc converter output voltage is set by selecting the error-amplifier gain (see Figure 1), using the following expression:

$$V_O = (1 + R1/R2) (1 \text{ V})$$

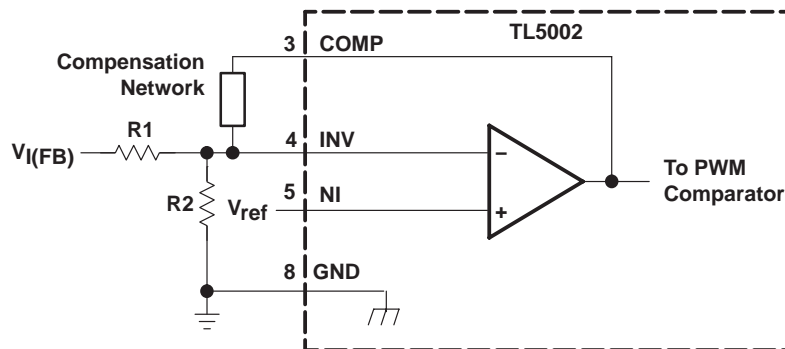

Figure 1. Error-Amplifier Gain Setting

The error-amplifier output is brought out as COMP for use in compensating the dc-to-dc converter control loop for stability. Because the amplifier can only source 45 μ A, the total dc load resistance should be 100 k Ω or more.

oscillator/PWM

The oscillator frequency (f_{OSC}) can be set between 20 kHz and 500 kHz by connecting a resistor between RT and GND. Acceptable resistor values range from 15 k Ω to 250 k Ω . The oscillator frequency can be determined by using the graph shown in Figure 5.

The oscillator output is a triangular wave with a minimum value of approximately 0.7 V and a maximum value of approximately 1.3 V. The PWM comparator compares the error-amplifier output voltage and the DTC input voltage to the triangular wave and turns the output transistor off whenever the triangular wave is greater than the lesser of the two inputs.

dead-time control (DTC)

DTC provides a means of limiting the output-switch duty cycle to a value less than 100%, which is critical for boost and flyback converters. A current source generates a reference current (I_{DTC}) at DTC that is nominally equal to the current at the oscillator timing terminal, RT. Connecting a resistor between DTC and GND generates a dead-time reference voltage (V_{DTC}), which the PWM/DTC comparator compares to the oscillator triangle wave as described in the previous section. Nominally, the maximum duty cycle is 0% when V_{DTC} is 0.7 V or less and 100% when V_{DTC} is 1.3 V or greater. Because the triangle wave amplitude is a function of frequency and the source impedance of RT is relatively high (1250 Ω), choosing R_{DTC} for a specific maximum duty cycle, D, is accomplished using the following equation and the voltage limits for the frequency in question as found in Figure 11 (V_{OSCmax} and V_{OSCmin} are the maximum and minimum oscillator levels):

dead-time control (DTC) (continued)

$$R_{DT} = (R_t + 1250) [D(V_{oscmax} - V_{oscmin}) + V_{oscmin}]$$

Where

R_{DT} and R_t are in ohms, D in decimal

Soft start can be implemented by paralleling the DTC resistor with a capacitor (C_{DT}) as shown in Figure 2. During soft start, the voltage at DTC is derived by the following equation:

$$V_{DT} \approx I_{DT}R_{DT} \left(1 - e^{-t/R_{DT}C_{DT}} \right)$$

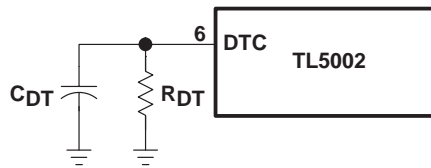

Figure 2. Soft-Start Circuit

If the dc-to-dc converter must be in regulation within a specified period of time, the time constant, $R_{DT}C_{DT}$, should be $t_0/3$ to $t_0/5$. The TL5002 remains off until $V_{DT} \approx 0.7$ V, the minimum ramp value. C_{DT} is discharged every time UVLO becomes active.

undervoltage-lockout (UVLO) protection

The undervoltage-lockout circuit turns the output transistor off whenever the supply voltage drops too low (approximately 3 V at 25°C) for proper operation. A hysteresis voltage of 200 mV eliminates false triggering on noise and chattering.

output transistor

The output of the TL5002 is an open-collector transistor with a maximum collector current rating of 21 mA and a voltage rating of 51 V. The output is turned on under the following conditions: the oscillator triangle wave is lower than both the DTC voltage and the error-amplifier output voltage, and the UVLO circuit is inactive.

TL5002

PULSE-WIDTH-MODULATION CONTROL CIRCUIT

SLVS304A – SEPTEMBER 2000 – REVISED AUGUST 2002

absolute maximum ratings over operating free-air temperature range (unless otherwise noted)†

Supply voltage, V_{CC} (see Note 1)	41 V
Amplifier input voltage, $V_{I(INV)}, V_{I(NI)}$	20 V
Output voltage, $V_{O, OUT}$	51 V
Output current, $I_{O, OUT}$	21 mA
Output peak current, $I_{O(peak), OUT}$	100 mA
Continuous total power dissipation	See Dissipation Rating Table
Operating ambient temperature range, T_A	-40°C to 85°C
Storage temperature range, T_{stg}	-65°C to 150°C
Lead temperature 1,6 mm (1/16 inch) from case for 10 seconds	260°C

† Stresses beyond those listed under “absolute maximum ratings” may cause permanent damage to the device. These are stress ratings only, and functional operation of the device at these or any other conditions beyond those indicated under “recommended operating conditions” is not implied. Exposure to absolute-maximum-rated conditions for extended periods may affect device reliability.

NOTE 1: All voltage values are with respect to network ground terminal.

DISSIPATION RATING TABLE

PACKAGE	$T_A \leq 25^\circ\text{C}$ POWER RATING	DERATING FACTOR ABOVE $T_A = 25^\circ\text{C}$	$T_A = 70^\circ\text{C}$ POWER RATING	$T_A = 85^\circ\text{C}$ POWER RATING	$T_A = 125^\circ\text{C}$ POWER RATING
D	725 mW	5.8 mW/°C	464 mW	377 mW	145 mW

recommended operating conditions

	MIN	MAX	UNIT
Supply voltage, V_{CC}	3.6	40	V
Amplifier input voltage, $V_{I(INV)}, V_{I(NI)}$	0.9	1.5	V
Output voltage, $V_{O, OUT}$		50	V
Output current, $I_{O, OUT}$		20	mA
COMP source current		45	μA
COMP dc load resistance	100		kΩ
Oscillator timing resistor, R_t	15	250	kΩ
Oscillator frequency, f_{osc}	20	500	kHz
Operating ambient temperature, T_A	-40	85	°C



TL5002

PULSE-WIDTH-MODULATION CONTROL CIRCUIT

SLVS304A – SEPTEMBER 2000 – REVISED AUGUST 2002

electrical characteristics over recommended operating free-air temperature range, $V_{CC} = 6\text{ V}$, $f_{osc} = 100\text{ kHz}$ (unless otherwise noted)

undervoltage lockout

PARAMETER	TEST CONDITIONS	TL5002C			UNIT
		MIN	TYP†	MAX	
Upper threshold voltage	$T_A = 25^\circ\text{C}$		3		V
Lower threshold voltage	$T_A = 25^\circ\text{C}$		2.8		V
Hysteresis	$T_A = 25^\circ\text{C}$	100	200		mV

† All typical values are at $T_A = 25^\circ\text{C}$.

oscillator

PARAMETER	TEST CONDITIONS	TL5002C			UNIT
		MIN	TYP†	MAX	
Frequency	$R_t = 100\text{ k}\Omega$		100		kHz
Standard deviation of frequency			15		kHz
Frequency change with voltage	$V_{CC} = 3.6\text{ V to }40\text{ V}$		1		kHz
Frequency change with temperature	$T_A = -40^\circ\text{C to }25^\circ\text{C}$	-4	-0.4	4	kHz
	$T_A = -20^\circ\text{C to }25^\circ\text{C}$	-4	-0.4	4	kHz
	$T_A = 25^\circ\text{C to }85^\circ\text{C}$	-4	-0.2	4	kHz
Voltage at RT			1		V

† All typical values are at $T_A = 25^\circ\text{C}$.

dead-time control

PARAMETER	TEST CONDITIONS	TL5002C			UNIT
		MIN	TYP†	MAX	
Output (source) current	TL5002 $V_{(DT)} = 1.5\text{ V}$	$0.9 \times I_{RT}^\ddagger$		$1.2 \times I_{RT}$	μA
Input threshold voltage	Duty cycle = 0%	0.5	0.7		V
	Duty cycle = 100%		1.3	1.5	

† All typical values are at $T_A = 25^\circ\text{C}$.

‡ Output source current at RT

error amplifier

PARAMETER	TEST CONDITIONS	TL5002C			UNIT
		MIN	TYP†	MAX	
Input voltage	$V_{CC} = 3.6\text{ V to }40\text{ V}$	0.3		1.5	V
Input bias current		-160		-500	nA
Output voltage swing	Positive	1.5	2.3		V
	Negative		0.3	0.4	V
Open-loop voltage amplification			80		dB
Unity-gain bandwidth			1.5		MHz
Output (sink) current	$V_{I(INV)} = 1.2\text{ V}, \text{ COMP} = 1\text{ V}$	100	600		μA
Output (source) current	$V_{I(INV)} = 0.8\text{ V}, \text{ COMP} = 1\text{ V}$	-45	-70		μA

† All typical values are at $T_A = 25^\circ\text{C}$.



TL5002 PULSE-WIDTH-MODULATION CONTROL CIRCUIT

SLVS304A – SEPTEMBER 2000 – REVISED AUGUST 2002

electrical characteristics over recommended operating free-air temperature range, $V_{CC} = 6\text{ V}$, $f_{osc} = 100\text{ kHz}$ (unless otherwise noted) (continued)

output

PARAMETER	TEST CONDITIONS	TL5002C			UNIT
		MIN	TYP†	MAX	
Output saturation voltage	$I_O = 10\text{ mA}$		1.5	2	V
Off-state current	$V_O = 50\text{ V}, V_{CC} = 0$			10	μA
	$V_O = 50\text{ V}$			10	
Short-circuit output current	$V_O = 6\text{ V}$		40		mA

† All typical values are at $T_A = 25^\circ\text{C}$.

total device

PARAMETER		TEST CONDITIONS	TL5002C			UNIT
			MIN	TYP†	MAX	
Standby supply current	Off state			1	1.5	mA
Average supply current		$R_t = 100\text{ k}\Omega$		1.4	2.1	mA

† All typical values are at $T_A = 25^\circ\text{C}$.

PARAMETER MEASUREMENT INFORMATION

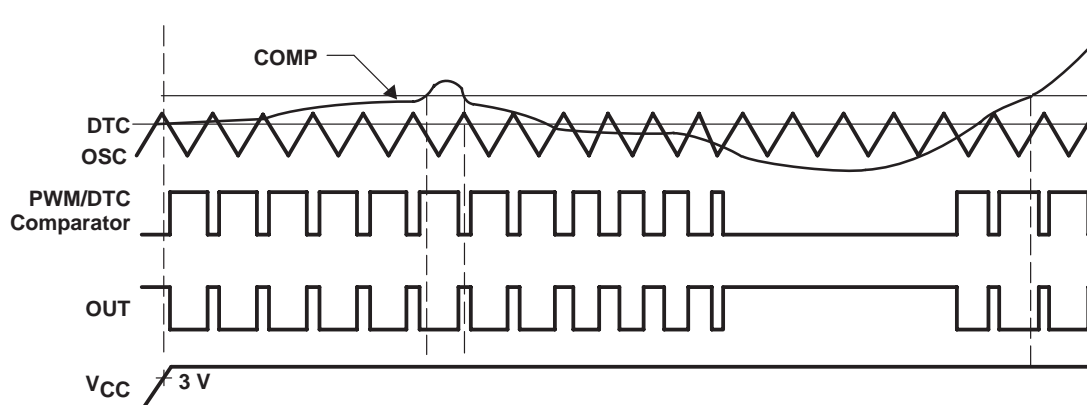

Figure 3. PWM Timing Diagram

TYPICAL CHARACTERISTICS

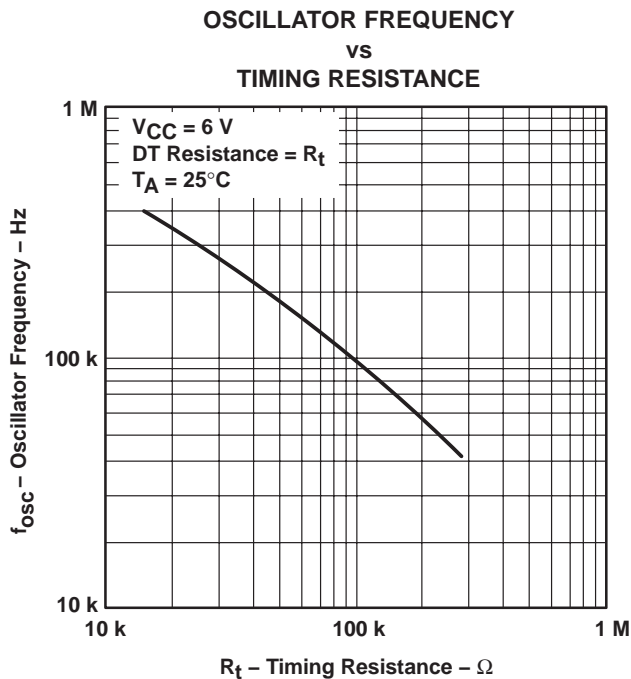

Figure 4

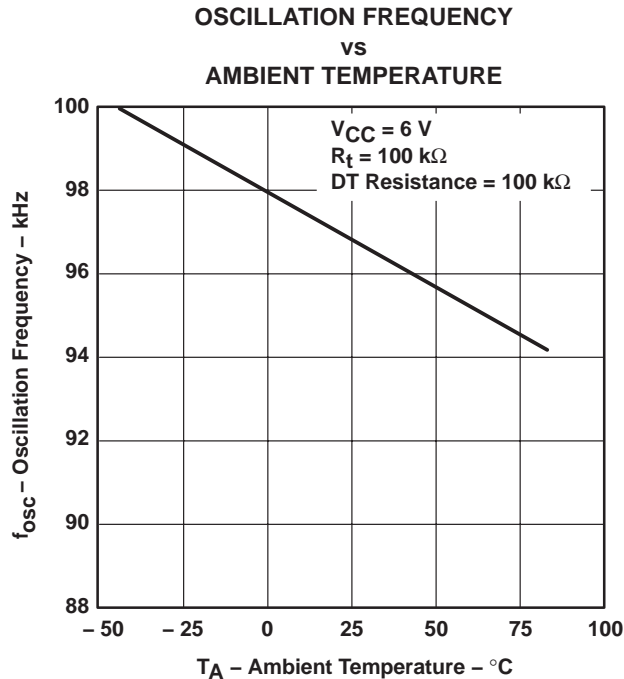

Figure 5

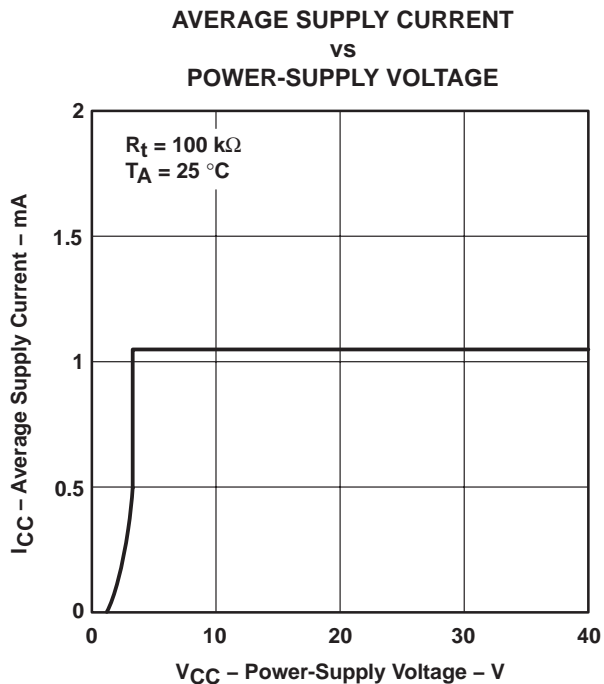

Figure 6

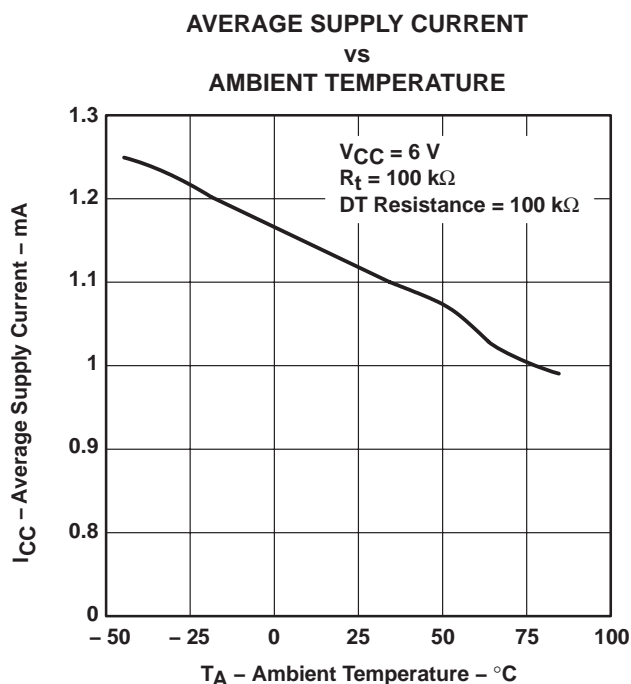

Figure 7

TL5002 PULSE-WIDTH-MODULATION CONTROL CIRCUIT

SLVS304A – SEPTEMBER 2000 – REVISED AUGUST 2002

TYPICAL CHARACTERISTICS

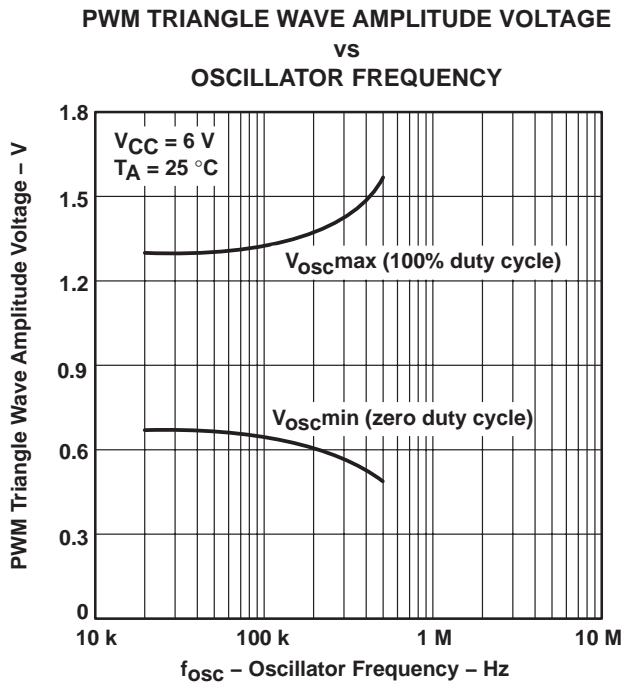

Figure 8

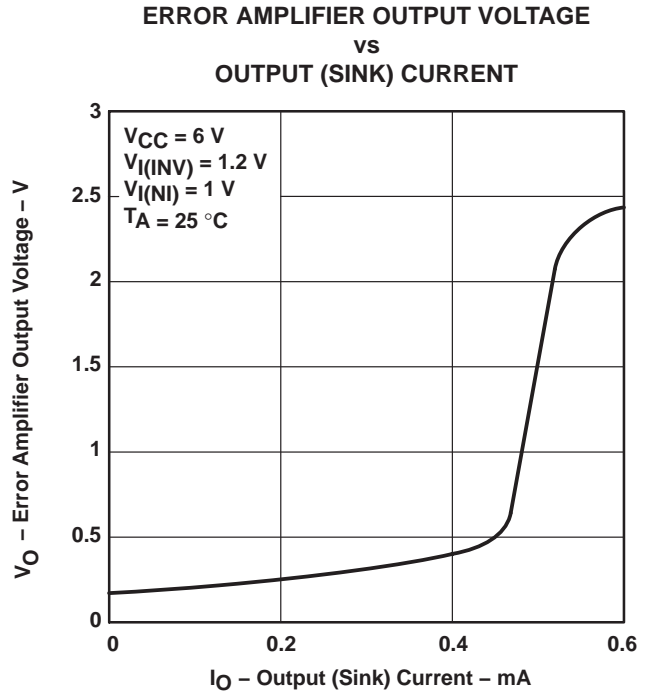

Figure 9

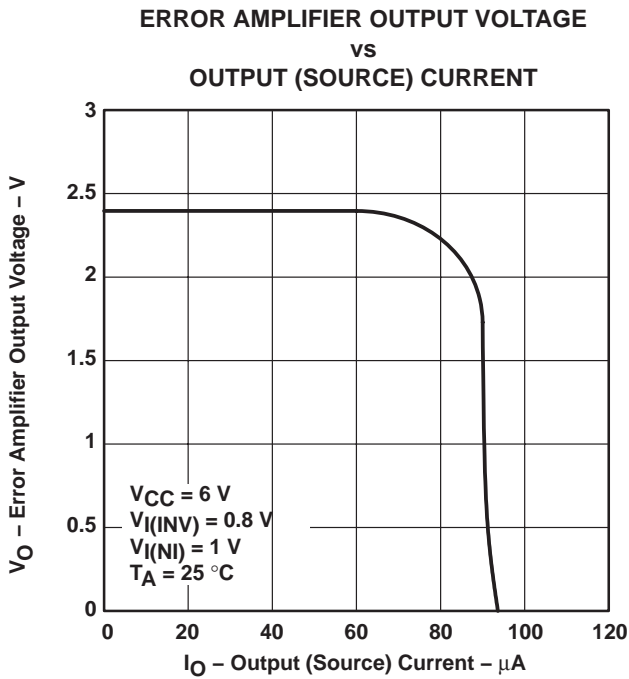

Figure 10

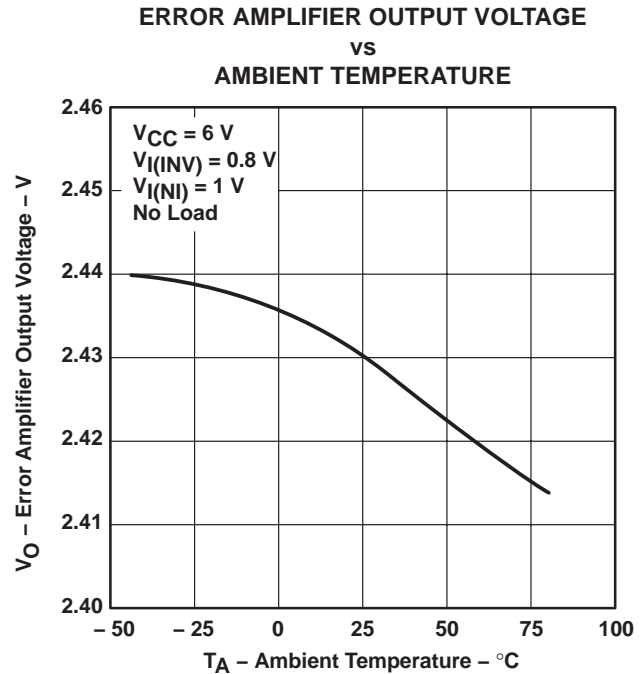

Figure 11

TYPICAL CHARACTERISTICS

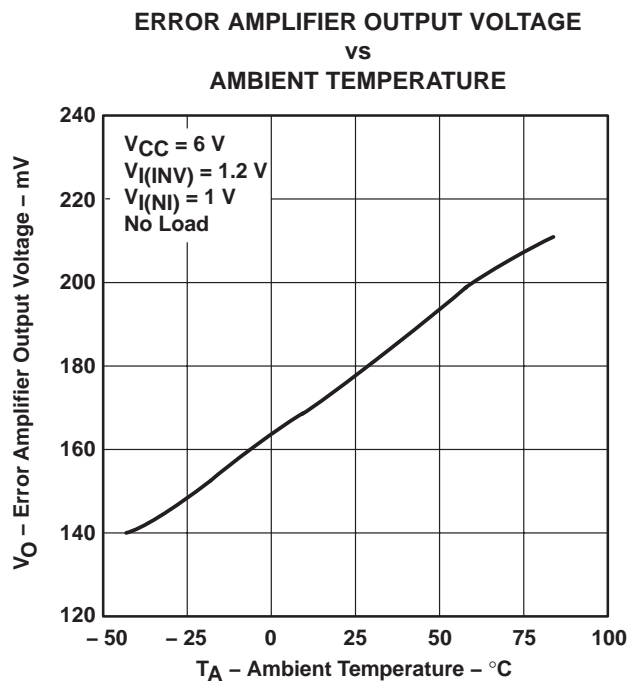

Figure 12

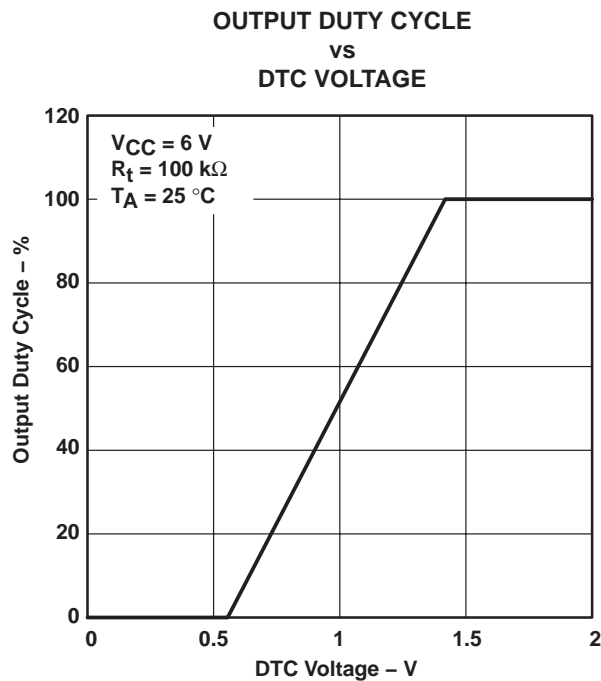

Figure 13

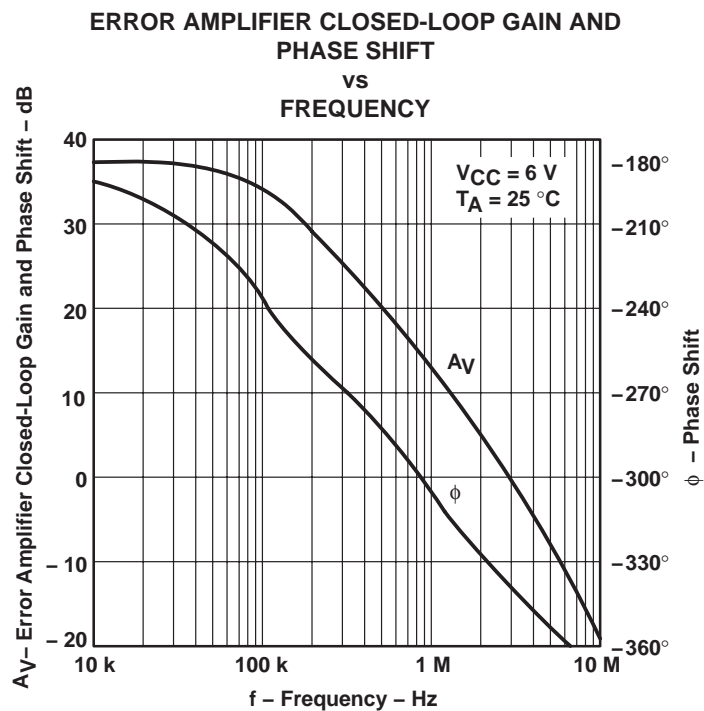

Figure 14

TL5002
PULSE-WIDTH-MODULATION CONTROL CIRCUIT

SLVS304A – SEPTEMBER 2000 – REVISED AUGUST 2002

TYPICAL CHARACTERISTICS

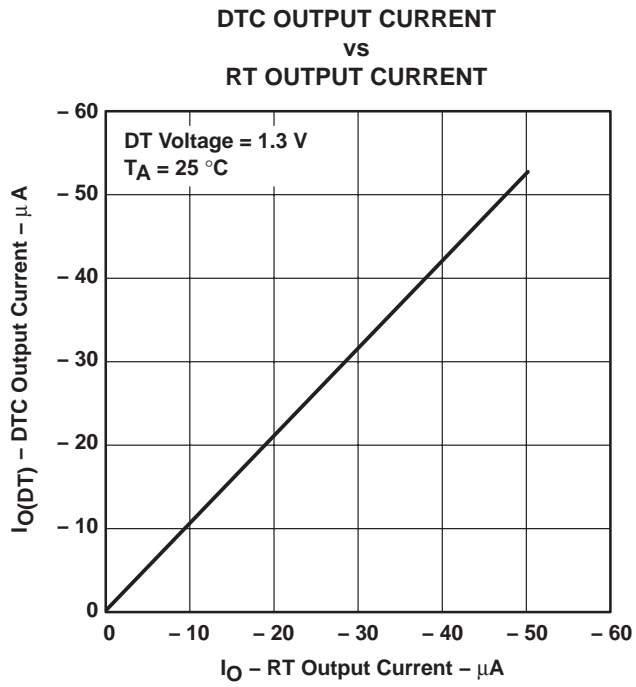

Figure 15

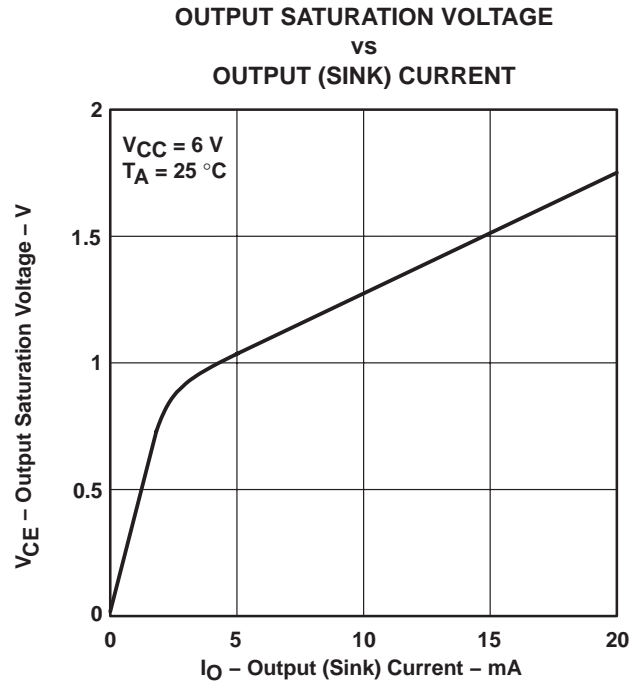

Figure 16

APPLICATION INFORMATION

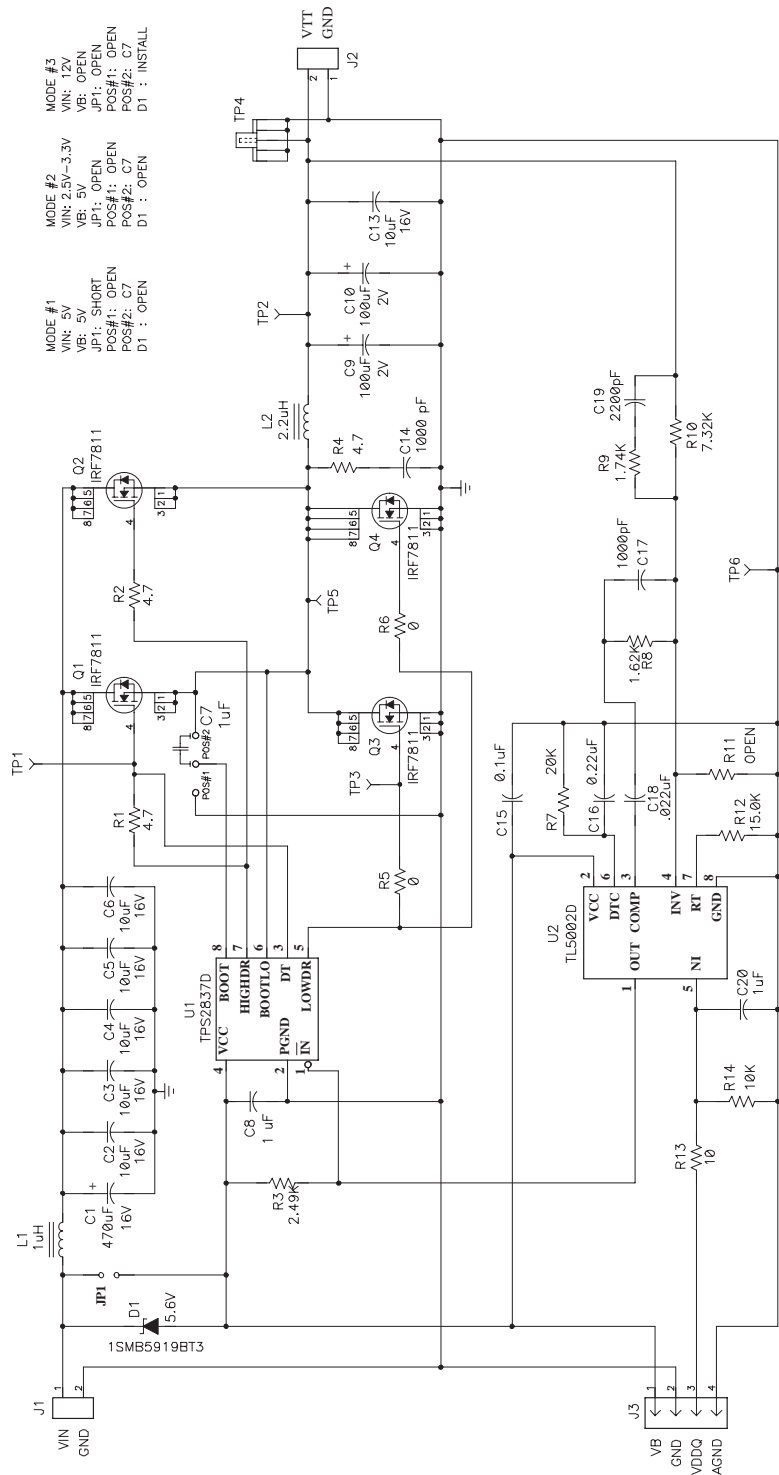

Figure 17. DDR1 Application

TL5002 PULSE-WIDTH-MODULATION CONTROL CIRCUIT

SLVS304A – SEPTEMBER 2000 – REVISED AUGUST 2002

APPLICATION INFORMATION

PARTIAL BILL OF MATERIALS

QUANTITY	REF DES	PART NUMBER	DESCRIPTION	MANUFACTURER	SIZE
1	C1	UUD1C471MNR1GS	Capacitor, aluminum	Nichicon	0.327 x 0.327
6	C2 – C6, C13	EMK325BJ106MN–B	Capacitor, ceramic	Taiyo Yuden	1210
3	C7, C8, C20	GRM40X7R105K16PT	Capacitor, ceramic, jumper	Murata	805
2	C9, C10	EEF–CD0D101R	Capacitor, aluminum	Panasonic	7343
1	C14	08055A102JAT2A	Capacitor, ceramic	AVX	805
1	C15	GRM39X7R104K016D	Capacitor, ceramic	Murata	603
1	C16	NMC0805X7R224K16TR	Capacitor, ceramic	NIP	603
1	C17	VJ0603Y222KXANT	Capacitor, ceramic	Murata	603
1	C18	C0603C223J3RACTU	Capacitor, ceramic	Kemet	603
1	C19	GRM39X7R223K16	Capacitor, ceramic	Murata	603
1	D1	1SMB5919BT3	Diode, zener, 5.6 V	On Semi	SMB
2	J1, J2	ED1609	Terminal block, 2-pin	OST	
1	J3	PTC36SAAN	Header, 4-pin	Sullins	
1	JP1	PTC36SAAN	Header, 2-pin	Sullins	
1	L1	UP2B–1R0	Inductor, SMT	Coiltronics	0.55 x 0.41
1	L2	UP4B–2R2	Inductor, SMT	Coiltronics	
4	Q1 – Q4	IRF7811	MOSFET, N–ch, 30 V	IR	SO8
3	R1, R2, R4	Std	Resistor, chip, 4.7 Ω	Std	603
1	R3	Std	Resistor, chip, 2.49 K Ω	Std	603
2	R5, R6	Std	Resistor, chip, 0 Ω	Std	603
1	R7	Std	Resistor, chip, 20 K Ω	Std	603
1	R8	Std	Resistor, chip, 162 K Ω	Std	603
1	R9	Std	Resistor, chip, 1.74 K Ω	Std	603
1	R10	Std	Resistor, chip, 7.32 K Ω	Std	603
1	R11	Std	Open	Std	603
1	R12	Std	Resistor, chip, 15 K Ω	Std	603
1	R13	Std	Resistor, chip, 10 Ω	Std	603
1	R14	Std	Resistor, chip, 10 K Ω	Std	603
4	TP1 – TP3, TP5	240-345	Test point, red, 1 mm	Farnell	0.038
1	TP4	131-4244-00 or 131-5031-00	Adaptor, 3.5 mm probe	Tektronix	0.200
1	TP6	1045-3-17-15-30-14-02-0	Post, wirewrap	Mill-Max	0.043
1	U1	TPS2837D	IC, MOSFET driver	Texas Instruments	SO8
1	U2	TL5002D	IC, low-cost PMW	Texas Instruments	SO8



POST OFFICE BOX 655303 • DALLAS, TEXAS 75265

PACKAGING INFORMATION

Orderable part number	Status (1)	Material type (2)	Package Pins	Package qty Carrier	RoHS (3)	Lead finish/ Ball material (4)	MSL rating/ Peak reflow (5)	Op temp (°C)	Part marking (6)
TL5002CD	Active	Production	SOIC (D) 8	75 TUBE	Yes	NIPDAU	Level-1-260C-UNLIM	-20 to 85	5002CD
TL5002CD.A	Active	Production	SOIC (D) 8	75 TUBE	Yes	NIPDAU	Level-1-260C-UNLIM	-20 to 85	5002CD
TL5002CDR	Active	Production	SOIC (D) 8	2500 LARGE T&R	Yes	NIPDAU	Level-1-260C-UNLIM	-20 to 85	5002CD
TL5002CDR.A	Active	Production	SOIC (D) 8	2500 LARGE T&R	Yes	NIPDAU	Level-1-260C-UNLIM	-20 to 85	5002CD
TL5002ID	Active	Production	SOIC (D) 8	75 TUBE	Yes	NIPDAU	Level-1-260C-UNLIM	-40 to 85	5002ID
TL5002ID.A	Active	Production	SOIC (D) 8	75 TUBE	Yes	NIPDAU	Level-1-260C-UNLIM	-40 to 85	5002ID
TL5002IDR	Active	Production	SOIC (D) 8	2500 LARGE T&R	Yes	NIPDAU	Level-1-260C-UNLIM	-40 to 85	5002ID
TL5002IDR.A	Active	Production	SOIC (D) 8	2500 LARGE T&R	Yes	NIPDAU	Level-1-260C-UNLIM	-40 to 85	5002ID

(1) **Status:** For more details on status, see our [product life cycle](#).

(2) **Material type:** When designated, preproduction parts are prototypes/experimental devices, and are not yet approved or released for full production. Testing and final process, including without limitation quality assurance, reliability performance testing, and/or process qualification, may not yet be complete, and this item is subject to further changes or possible discontinuation. If available for ordering, purchases will be subject to an additional waiver at checkout, and are intended for early internal evaluation purposes only. These items are sold without warranties of any kind.

(3) **RoHS values:** Yes, No, RoHS Exempt. See the [TI RoHS Statement](#) for additional information and value definition.

(4) **Lead finish/Ball material:** Parts may have multiple material finish options. Finish options are separated by a vertical ruled line. Lead finish/Ball material values may wrap to two lines if the finish value exceeds the maximum column width.

(5) **MSL rating/Peak reflow:** The moisture sensitivity level ratings and peak solder (reflow) temperatures. In the event that a part has multiple moisture sensitivity ratings, only the lowest level per JEDEC standards is shown. Refer to the shipping label for the actual reflow temperature that will be used to mount the part to the printed circuit board.

(6) **Part marking:** There may be an additional marking, which relates to the logo, the lot trace code information, or the environmental category of the part.

Multiple part markings will be inside parentheses. Only one part marking contained in parentheses and separated by a "-" will appear on a part. If a line is indented then it is a continuation of the previous line and the two combined represent the entire part marking for that device.

Important Information and Disclaimer:The information provided on this page represents TI's knowledge and belief as of the date that it is provided. TI bases its knowledge and belief on information provided by third parties, and makes no representation or warranty as to the accuracy of such information. Efforts are underway to better integrate information from third parties. TI has taken and continues to take reasonable steps to provide representative and accurate information but may not have conducted destructive testing or chemical analysis on incoming materials and chemicals. TI and TI suppliers consider certain information to be proprietary, and thus CAS numbers and other limited information may not be available for release.

In no event shall TI's liability arising out of such information exceed the total purchase price of the TI part(s) at issue in this document sold by TI to Customer on an annual basis.

TAPE AND REEL INFORMATION

QUADRANT ASSIGNMENTS FOR PIN 1 ORIENTATION IN TAPE

*All dimensions are nominal

Device	Package Type	Package Drawing	Pins	SPQ	Reel Diameter (mm)	Reel Width W1 (mm)	A0 (mm)	B0 (mm)	K0 (mm)	P1 (mm)	W (mm)	Pin1 Quadrant
TL5002CDR	SOIC	D	8	2500	330.0	12.4	6.4	5.2	2.1	8.0	12.0	Q1
TL5002IDR	SOIC	D	8	2500	330.0	12.4	6.4	5.2	2.1	8.0	12.0	Q1

TAPE AND REEL BOX DIMENSIONS



*All dimensions are nominal

Device	Package Type	Package Drawing	Pins	SPQ	Length (mm)	Width (mm)	Height (mm)
TL5002CDR	SOIC	D	8	2500	353.0	353.0	32.0
TL5002IDR	SOIC	D	8	2500	340.5	338.1	20.6

TUBE

*All dimensions are nominal

Device	Package Name	Package Type	Pins	SPQ	L (mm)	W (mm)	T (μm)	B (mm)
TL5002CD	D	SOIC	8	75	507	8	3940	4.32
TL5002CD.A	D	SOIC	8	75	507	8	3940	4.32
TL5002ID	D	SOIC	8	75	507	8	3940	4.32
TL5002ID.A	D	SOIC	8	75	507	8	3940	4.32



D0008A

PACKAGE OUTLINE

SOIC - 1.75 mm max height

SMALL OUTLINE INTEGRATED CIRCUIT



4214825/C 02/2019

NOTES:

- Linear dimensions are in inches [millimeters]. Dimensions in parenthesis are for reference only. Controlling dimensions are in inches. Dimensioning and tolerancing per ASME Y14.5M.
- This drawing is subject to change without notice.
- This dimension does not include mold flash, protrusions, or gate burrs. Mold flash, protrusions, or gate burrs shall not exceed $.006$ [0.15] per side.
- This dimension does not include interlead flash.
- Reference JEDEC registration MS-012, variation AA.

EXAMPLE BOARD LAYOUT

D0008A

SOIC - 1.75 mm max height

SMALL OUTLINE INTEGRATED CIRCUIT



LAND PATTERN EXAMPLE
 EXPOSED METAL SHOWN
 SCALE:8X



SOLDER MASK DETAILS

4214825/C 02/2019

NOTES: (continued)

- 6. Publication IPC-7351 may have alternate designs.
- 7. Solder mask tolerances between and around signal pads can vary based on board fabrication site.

EXAMPLE STENCIL DESIGN

D0008A

SOIC - 1.75 mm max height

SMALL OUTLINE INTEGRATED CIRCUIT



SOLDER PASTE EXAMPLE
BASED ON .005 INCH [0.125 MM] THICK STENCIL
SCALE:8X

4214825/C 02/2019

NOTES: (continued)

8. Laser cutting apertures with trapezoidal walls and rounded corners may offer better paste release. IPC-7525 may have alternate design recommendations.
9. Board assembly site may have different recommendations for stencil design.

IMPORTANT NOTICE AND DISCLAIMER

TI PROVIDES TECHNICAL AND RELIABILITY DATA (INCLUDING DATASHEETS), DESIGN RESOURCES (INCLUDING REFERENCE DESIGNS), APPLICATION OR OTHER DESIGN ADVICE, WEB TOOLS, SAFETY INFORMATION, AND OTHER RESOURCES "AS IS" AND WITH ALL FAULTS, AND DISCLAIMS ALL WARRANTIES, EXPRESS AND IMPLIED, INCLUDING WITHOUT LIMITATION ANY IMPLIED WARRANTIES OF MERCHANTABILITY, FITNESS FOR A PARTICULAR PURPOSE OR NON-INFRINGEMENT OF THIRD PARTY INTELLECTUAL PROPERTY RIGHTS.

These resources are intended for skilled developers designing with TI products. You are solely responsible for (1) selecting the appropriate TI products for your application, (2) designing, validating and testing your application, and (3) ensuring your application meets applicable standards, and any other safety, security, regulatory or other requirements.

These resources are subject to change without notice. TI grants you permission to use these resources only for development of an application that uses the TI products described in the resource. Other reproduction and display of these resources is prohibited. No license is granted to any other TI intellectual property right or to any third party intellectual property right. TI disclaims responsibility for, and you fully indemnify TI and its representatives against any claims, damages, costs, losses, and liabilities arising out of your use of these resources.

TI's products are provided subject to [TI's Terms of Sale](#), [TI's General Quality Guidelines](#), or other applicable terms available either on ti.com or provided in conjunction with such TI products. TI's provision of these resources does not expand or otherwise alter TI's applicable warranties or warranty disclaimers for TI products. Unless TI explicitly designates a product as custom or customer-specified, TI products are standard, catalog, general purpose devices.

TI objects to and rejects any additional or different terms you may propose.

Copyright © 2025, Texas Instruments Incorporated

Last updated 10/2025