

## TLV702 300-mA, Low- $I_Q$ , Low-Dropout Regulator

### 1 Features

- Very Low Dropout:
  - 37 mV at  $I_{OUT} = 50$  mA,  $V_{OUT} = 2.8$  V
  - 75 mV at  $I_{OUT} = 100$  mA,  $V_{OUT} = 2.8$  V
  - 220mV at  $I_{OUT} = 300$  mA,  $V_{OUT} = 2.8$  V
- 2% Accuracy
- Low  $I_Q$ : 35  $\mu$ A
- Fixed-Output Voltage Combinations Possible from 1.2 V to 4.8 V
- High PSRR: 68 dB at 1 kHz
- Stable With Effective Capacitance of 0.1  $\mu$ F<sup>(1)</sup>
- Thermal Shutdown and Overcurrent Protection
- Packages: 5-Pin SOT-23 and 1.5-mm x 1.5-mm, 6-Pin WSON

<sup>(1)</sup> See the [Input and Output Capacitor Requirements in Application Information](#).

### 2 Applications

- Wireless Handsets
- Smart Phones
- ZigBee<sup>®</sup> Networks
- Bluetooth<sup>®</sup> Devices
- Li-Ion Battery-Operated Handheld Products
- WLAN and Other PC Add-on Cards

### 3 Description

The TLV702 series of low-dropout (LDO) linear regulators are low quiescent current devices with excellent line and load transient performance. These LDOs are designed for power-sensitive applications. A precision bandgap and error amplifier provides overall 2% accuracy. Low output noise, very high power-supply rejection ratio (PSRR), and low-dropout voltage make this series of devices ideal for a wide selection of battery-operated handheld equipment. All device versions have thermal shutdown and current limit for safety.

Furthermore, these devices are stable with an effective output capacitance of only 0.1  $\mu$ F. This feature enables the use of cost-effective capacitors that have higher bias voltages and temperature derating. The devices regulate to specified accuracy with no output load.

The TLV702P series also provides an active pulldown circuit to quickly discharge the outputs.

The TLV702 series of LDO linear regulators are available in SOT23-5 and 1.5-mm x 1.5-mm WSON-6 packages.

#### Device Information<sup>(1)</sup>

PART NUMBER	PACKAGE	BODY SIZE (NOM)
TLV702	SOT-23 (5)	2.90 mm x 1.60 mm
	WSON (6)	1.50 mm x 1.50 mm

<sup>(1)</sup> For all available packages, see the orderable addendum at the end of the data sheet.

#### Typical Application Circuit



## Table of Contents

<b>1 Features</b> .....	<b>1</b>	<b>8 Application and Implementation</b> .....	<b>13</b>
<b>2 Applications</b> .....	<b>1</b>	8.1 Application Information.....	13
<b>3 Description</b> .....	<b>1</b>	8.2 Typical Application .....	13
<b>4 Revision History</b> .....	<b>2</b>	<b>9 Power Supply Recommendations</b> .....	<b>15</b>
<b>5 Pin Configuration and Functions</b> .....	<b>3</b>	9.1 Power Dissipation .....	15
<b>6 Specifications</b> .....	<b>4</b>	<b>10 Layout</b> .....	<b>15</b>
6.1 Absolute Maximum Ratings .....	4	10.1 Layout Guidelines .....	15
6.2 ESD Ratings .....	4	10.2 Layout Examples.....	16
6.3 Recommended Operating Conditions.....	4	<b>11 Device and Documentation Support</b> .....	<b>17</b>
6.4 Thermal Information .....	4	11.1 Device Support .....	17
6.5 Electrical Characteristics.....	5	11.2 Documentation Support .....	17
6.6 Typical Characteristics .....	6	11.3 Receiving Notification of Documentation Updates	17
<b>7 Detailed Description</b> .....	<b>10</b>	11.4 Community Resources.....	17
7.1 Overview .....	10	11.5 Trademarks .....	17
7.2 Functional Block Diagrams .....	10	11.6 Electrostatic Discharge Caution.....	17
7.3 Feature Description.....	11	11.7 Glossary .....	18
7.4 Device Functional Modes.....	12	<b>12 Mechanical, Packaging, and Orderable Information</b> .....	<b>18</b>

## 4 Revision History

NOTE: Page numbers for previous revisions may differ from page numbers in the current version.

<b>Changes from Revision C (March 2015) to Revision D</b>	<b>Page</b>
• Changed OUT pin number from 5 to 3 in WSON column of Pin Functions table .....	3
• Added footnote to maximum EN voltage specification .....	4
• Added parameter names to <i>Recommended Operating Conditions</i> table.....	4

<b>Changes from Revision B (February 2011) to Revision C</b>	<b>Page</b>
• Added <i>ESD Ratings</i> table, <i>Feature Description</i> section, <i>Device Functional Modes</i> , <i>Application and Implementation</i> section, <i>Power Supply Recommendations</i> section, <i>Layout</i> section, <i>Device and Documentation Support</i> section, and <i>Mechanical, Packaging, and Orderable Information</i> section .....	1
• Changed Pin Configuration and Functions section; updated table format .....	3
• Deleted <i>Ordering Information</i> table .....	3
• Changed "free-air temperature" to "junction temperature" in <i>Absolute Maximum Ratings</i> condition statement .....	4
• Changed <i>Thermal Information</i> table; updated thermal resistance values for all packages .....	4
• Deleted <i>Dissipation Ratings</i> table .....	4
• Changed $V_{DO}$ dropout voltage test conditions; deleted $I_{OUT} = 50$ mA and $I_{OUT} = 100$ mA with $V_{OUT} = 2.8$ V test parameters .....	5
• Deleted <i>EVM Dissipation Ratings</i> table .....	16

<b>Changes from Revision A (October 2010) to Revision B</b>	<b>Page</b>
• Added SON-6 (DSE) package and related references to data sheet.....	1

## 5 Pin Configuration and Functions



### Pin Functions

NAME	PIN		I/O	DESCRIPTION
	SOT-23	WSON		
IN	1	1	I	Input pin. A small, 1- $\mu$ F ceramic capacitor is recommended from this pin to ground to assure stability and good transient performance. See <a href="#">Input and Output Capacitor Requirements</a> in <a href="#">Application Information</a> for more details.
GND	2	2	—	Ground pin
EN	3	6	I	Enable pin. Driving EN over 0.9 V turns on the regulator. Driving EN below 0.4 V puts the regulator into shutdown mode and reduces operating current to 1 $\mu$ A, nominal. For TLV702P, output voltage is discharged through an internal 120- $\Omega$ resistor when device is shut down.
NC	4	4, 5	—	No connection. This pin can be tied to ground to improve thermal dissipation.
OUT	5	3	O	Regulated output voltage pin. A small, 1- $\mu$ F ceramic capacitor is needed from this pin to ground to assure stability. See <a href="#">Input and Output Capacitor Requirements</a> in <a href="#">Application Information</a> for more details.

## 6 Specifications

### 6.1 Absolute Maximum Ratings

over operating junction temperature range (unless otherwise noted)<sup>(1)</sup>

		MIN	MAX	UNIT
Voltage <sup>(2)</sup>	IN	-0.3	6	V
	EN	-0.3	6 <sup>(3)</sup>	
	OUT	-0.3	6	
Current (source)	OUT	Internally limited		
Output short-circuit duration		Indefinite		
Total continuous power dissipation		See <a href="#">Thermal Information</a>		
Temperature	Operating virtual junction, T <sub>J</sub>	-55	150	°C
	Storage, T <sub>stg</sub>	-55	150	

- (1) Stresses beyond those listed under *Absolute Maximum Ratings* may cause permanent damage to the device. These are stress ratings only, and functional operation of the device at these or any other conditions beyond those indicated under *Recommended Operating Conditions* is not implied. Exposure to absolute-maximum-rated conditions for extended periods may affect device reliability.
- (2) All voltages are with respect to network ground terminal.
- (3) The absolute maximum rating is V<sub>IN</sub> + 0.3 V or 6.0 V, whichever is smaller.

### 6.2 ESD Ratings

			VALUE	UNIT
V <sub>(ESD)</sub>	Electrostatic discharge	Human body model (HBM), per ANSI/ESDA/JEDEC JS-001, all pins <sup>(1)</sup>	±2000	V
		Charged device model (CDM), per JEDEC specification JESD22-C101, all pins <sup>(2)</sup>	±500	

- (1) JEDEC document JEP155 states that 500-V HBM allows safe manufacturing with a standard ESD control process.
- (2) JEDEC document JEP157 states that 250-V CDM allows safe manufacturing with a standard ESD control process.

### 6.3 Recommended Operating Conditions

over operating free-air temperature range (unless otherwise noted).

		MIN	NOM	MAX	UNIT
V <sub>IN</sub>	Input voltage	2		5.5	V
V <sub>OUT</sub>	Output voltage	1.2		4.8	V
I <sub>OUT</sub>	Output current	0		300	mA

### 6.4 Thermal Information

THERMAL METRIC <sup>(1)</sup>		TLV702		UNIT
		DBV (SOT-23)	DSE (WSON)	
		5 PINS	6 PINS	
R <sub>θJA</sub>	Junction-to-ambient thermal resistance	249.2	321.3	°C/W
R <sub>θJC(top)</sub>	Junction-to-case (top) thermal resistance	136.4	207.9	°C/W
R <sub>θJB</sub>	Junction-to-board thermal resistance	85.9	281.5	°C/W
ψ <sub>JT</sub>	Junction-to-top characterization parameter	19.5	42.4	°C/W
ψ <sub>JB</sub>	Junction-to-board characterization parameter	85.3	284.8	°C/W
R <sub>θJC(bot)</sub>	Junction-to-case (bottom) thermal resistance	N/A	142.3	°C/W

- (1) For more information about traditional and new thermal metrics, see the [Semiconductor and IC Package Thermal Metrics application report](#).

## 6.5 Electrical Characteristics

At  $V_{IN} = V_{OUT(nom)} + 0.5\text{ V}$  or  $2\text{ V}$  (whichever is greater);  $I_{OUT} = 10\text{ mA}$ ,  $V_{EN} = 0.9\text{ V}$ ,  $C_{OUT} = 1\text{ }\mu\text{F}$ , and  $T_J = -40^\circ\text{C}$  to  $+125^\circ\text{C}$ , unless otherwise noted. Typical values are at  $T_J = 25^\circ\text{C}$ .

PARAMETER		TEST CONDITIONS	MIN	TYP	MAX	UNIT
$V_{IN}$	Input voltage range		2		5.5	V
$V_{OUT}$	DC output accuracy	$-40^\circ\text{C} \leq T_J \leq 125^\circ\text{C}$	-2%	0.5%	2%	
$\Delta V_{OUT(\Delta V_{IN})}$	Line regulation	$V_{OUT(nom)} + 0.5\text{ V} \leq V_{IN} \leq 5.5\text{ V}$ , $I_{OUT} = 10\text{ mA}$		1	5	mV
$\Delta V_{OUT(\Delta I_{OUT})}$	Load regulation	$0\text{ mA} \leq I_{OUT} \leq 300\text{ mA}$		1	15	mV
$V_{DO}$	Dropout voltage <sup>(1)</sup>	$V_{IN} = 0.98 \times V_{OUT(nom)}$ , $I_{OUT} = 300\text{ mA}$		260	375	mV
$I_{CL}$	Output current limit	$V_{OUT} = 0.9 \times V_{OUT(nom)}$	320	500	860	mA
$I_{GND}$	Ground pin current	$I_{OUT} = 0\text{ mA}$		35	55	$\mu\text{A}$
		$I_{OUT} = 300\text{ mA}$ , $V_{IN} = V_{OUT} + 0.5\text{ V}$		370		$\mu\text{A}$
$I_{SHDN}$	Ground pin current (shutdown)	$V_{EN} \leq 0.4\text{ V}$ , $V_{IN} = 2\text{ V}$		400		nA
		$V_{EN} \leq 0.4\text{ V}$ , $2\text{ V} \leq V_{IN} \leq 4.5\text{ V}$ , $T_J = -40^\circ\text{C}$ to $+85^\circ\text{C}$		1	2	$\mu\text{A}$
PSRR	Power-supply rejection ratio	$V_{IN} = 2.3\text{ V}$ , $V_{OUT} = 1.8\text{ V}$ , $I_{OUT} = 10\text{ mA}$ , $f = 1\text{ kHz}$		68		dB
$V_n$	Output noise voltage	$BW = 100\text{ Hz}$ to $100\text{ kHz}$ , $V_{IN} = 2.3\text{ V}$ , $V_{OUT} = 1.8\text{ V}$ , $I_{OUT} = 10\text{ mA}$		48		$\mu\text{V}_{RMS}$
$t_{STR}$	Start-up time <sup>(2)</sup>	$C_{OUT} = 1\text{ }\mu\text{F}$ , $I_{OUT} = 300\text{ mA}$		100		$\mu\text{s}$
$V_{EN(high)}$	Enable pin high (enabled)		0.9		$V_{IN}$	V
$V_{EN(low)}$	Enable pin low (disabled)		0		0.4	V
$I_{EN}$	Enable pin current	$V_{IN} = V_{EN} = 5.5\text{ V}$		0.04		$\mu\text{A}$
UVLO	Undervoltage lockout	$V_{IN}$ rising		1.9		V
$R_{DISCHARGE}$	Active pulldown resistance (TLV702P only)	$V_{EN} = 0\text{ V}$		120		$\Omega$
$T_{sd}$	Thermal shutdown temperature	Shutdown, temperature increasing		165		$^\circ\text{C}$
		Reset, temperature decreasing		145		$^\circ\text{C}$
$T_J$	Operating junction temperature		-40		125	$^\circ\text{C}$

(1)  $V_{DO}$  is measured for devices with  $V_{OUT(nom)} \geq 2.35\text{ V}$ .

(2) Start-up time = time from EN assertion to  $0.98 \times V_{OUT(nom)}$ .

### 6.6 Typical Characteristics

Over operating temperature range ( $T_J = -40^{\circ}\text{C}$  to  $+125^{\circ}\text{C}$ ),  $V_{IN} = V_{OUT(nom)} + 0.5\text{ V}$  or  $2\text{ V}$ , whichever is greater;  $I_{OUT} = 10\text{ mA}$ ,  $V_{EN} = V_{IN}$ ,  $C_{OUT} = 1\text{ }\mu\text{F}$ , unless otherwise noted. Typical values are at  $T_J = 25^{\circ}\text{C}$ .

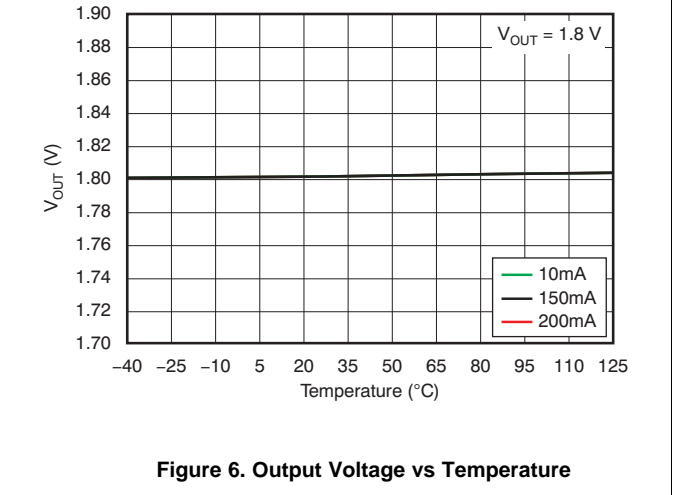
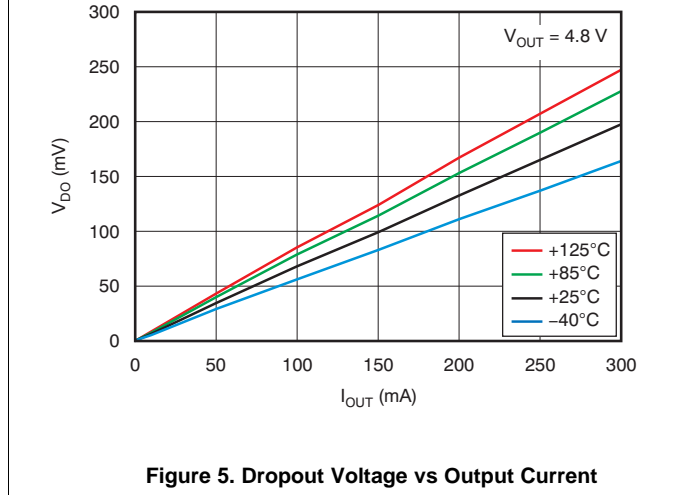
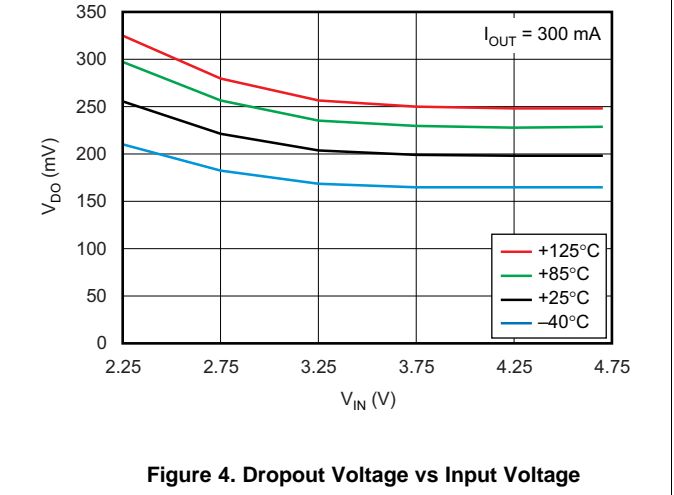
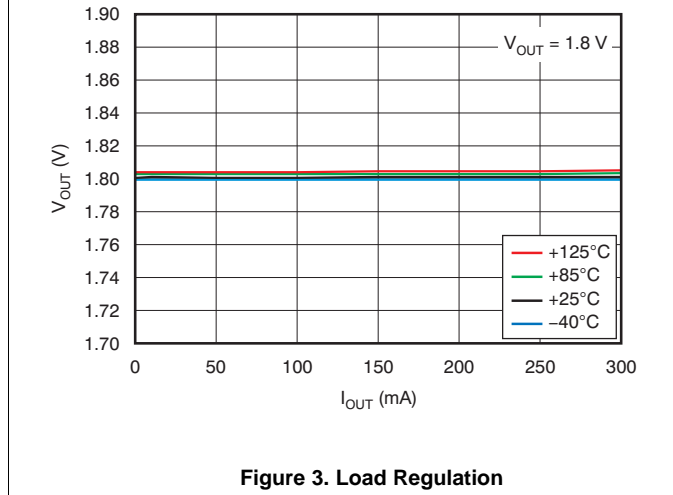
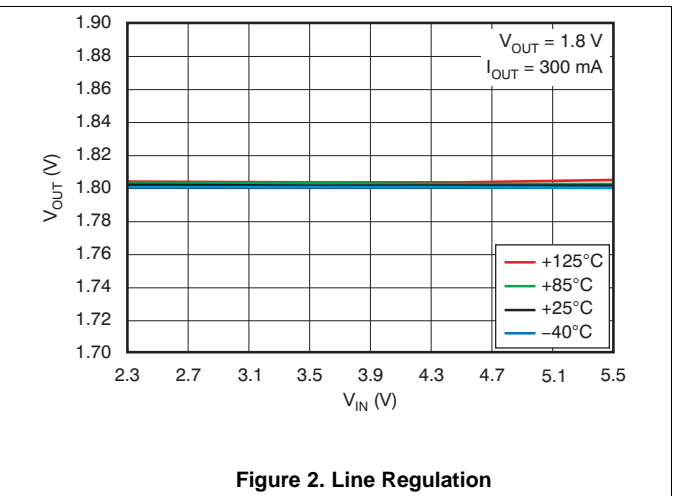

Typical Characteristics (continued)

Over operating temperature range ( $T_J = -40^\circ\text{C}$  to  $+125^\circ\text{C}$ ),  $V_{IN} = V_{OUT(nom)} + 0.5\text{ V}$  or  $2\text{ V}$ , whichever is greater;  $I_{OUT} = 10\text{ mA}$ ,  $V_{EN} = V_{IN}$ ,  $C_{OUT} = 1\text{ }\mu\text{F}$ , unless otherwise noted. Typical values are at  $T_J = 25^\circ\text{C}$ .



Figure 7. Ground Pin Current vs Input Voltage



Figure 8. Ground Pin Current vs Load



Figure 9. Ground Pin Current vs Temperature



Figure 10. Shutdown Current vs Input Voltage



Figure 11. Current Limit vs Input Voltage



Figure 12. Power-Supply Ripple Rejection vs Frequency

### Typical Characteristics (continued)

Over operating temperature range ( $T_J = -40^\circ\text{C}$  to  $+125^\circ\text{C}$ ),  $V_{IN} = V_{OUT(nom)} + 0.5\text{ V}$  or  $2\text{ V}$ , whichever is greater;  $I_{OUT} = 10\text{ mA}$ ,  $V_{EN} = V_{IN}$ ,  $C_{OUT} = 1\text{ }\mu\text{F}$ , unless otherwise noted. Typical values are at  $T_J = 25^\circ\text{C}$ .



Figure 13. Power-Supply Ripple Rejection vs Input Voltage



Figure 14. Output Spectral Noise Density vs Frequency



Figure 15. Load Transient Response



Figure 16. Load Transient Response



Figure 17. Load Transient Response



Figure 18. Load Transient Response

**Typical Characteristics (continued)**

Over operating temperature range ( $T_J = -40^{\circ}\text{C}$  to  $+125^{\circ}\text{C}$ ),  $V_{IN} = V_{OUT(nom)} + 0.5\text{ V}$  or  $2\text{ V}$ , whichever is greater;  $I_{OUT} = 10\text{ mA}$ ,  $V_{EN} = V_{IN}$ ,  $C_{OUT} = 1\text{ }\mu\text{F}$ , unless otherwise noted. Typical values are at  $T_J = 25^{\circ}\text{C}$ .



## 7 Detailed Description

### 7.1 Overview

The TLV702 series of low-dropout (LDO) linear regulators are low quiescent current devices with excellent line and load transient performance. These LDOs are designed for power-sensitive applications. A precision bandgap and error amplifier provides overall 2% accuracy. Low output noise, very high power-supply rejection ratio (PSRR), and low dropout voltage make this series of devices ideal for most battery-operated handheld equipment. All device versions have integrated thermal shutdown, current limit, and undervoltage lockout (UVLO).

### 7.2 Functional Block Diagrams



**Figure 23. TLV702 Block Diagram**

## Functional Block Diagrams (continued)



Figure 24. TLV702P Block Diagram

## 7.3 Feature Description

### 7.3.1 Internal Current Limit

The TLV702 internal current limit helps to protect the regulator during fault conditions. During current limit, the output sources a fixed amount of current that is largely independent of the output voltage. In such a case, the output voltage is not regulated, and is  $V_{OUT} = I_{CL} \times R_{LOAD}$ . The PMOS pass transistor dissipates  $(V_{IN} - V_{OUT}) \times I_{CL}$  until thermal shutdown is triggered and the device turns off. As the device cools, it is turned on by the internal thermal shutdown circuit. If the fault condition continues, the device cycles between current limit and thermal shutdown. See [Thermal Consideration](#) for more details.

The PMOS pass element in the TLV702 has a built-in body diode that conducts current when the voltage at OUT exceeds the voltage at IN. This current is not limited, so if extended reverse voltage operation is anticipated, external limiting to 5% of the rated output current is recommended.

### 7.3.2 Shutdown

The enable pin (EN) is active high. The device is enabled when voltage at EN pin goes above 0.9 V. The device is turned off when the EN pin is held at less than 0.4 V. When shutdown capability is not required, EN can be connected to the IN pin.

The TLV702P version has internal active pulldown circuitry that discharges the output with a time constant of:

$$\tau = \frac{(120 \cdot R_L)}{(120 + R_L)} \cdot C_{OUT}$$

where:

- $R_L$  = Load resistance
- $C_{OUT}$  = Output capacitor

(1)

## Feature Description (continued)

### 7.3.3 Dropout Voltage

The TLV702 uses a PMOS pass transistor to achieve low dropout. When  $(V_{IN} - V_{OUT})$  is less than the dropout voltage ( $V_{DO}$ ), the PMOS pass device is in the linear (triode) region of operation and the input-to-output resistance is the  $R_{DS(on)}$  of the PMOS pass element.  $V_{DO}$  scales approximately with output current because the PMOS device behaves as a resistor in dropout.

As with any linear regulator, PSRR and transient response are degraded as  $(V_{IN} - V_{OUT})$  approaches dropout. This effect is shown in [Figure 13](#).

### 7.3.4 Undervoltage Lockout

The TLV702 uses a UVLO circuit to keep the output shut off until internal circuitry is operating properly.

## 7.4 Device Functional Modes

### 7.4.1 Normal Operation

The device regulates to the nominal output voltage under the following conditions:

- The input voltage is greater than the nominal output voltage added to the dropout voltage.
- The output current is less than the current limit.
- The input voltage is greater than the UVLO voltage.

### 7.4.2 Dropout Operation

If the input voltage is lower than the nominal output voltage plus the specified dropout voltage, but all other conditions are met for normal operation, the device operates in dropout mode. In this condition, the output voltage is the same as the input voltage minus the dropout voltage. The transient performance of the device is significantly degraded because the pass device is in a triode state and no longer regulates the output voltage of the LDO. Line or load transients in dropout may result in large output voltage deviations.

[Table 1](#) lists the conditions that lead to the different modes of operation.

**Table 1. Device Functional Mode Comparison**

OPERATING MODE	PARAMETER	
	$V_{IN}$	$I_{OUT}$
Normal mode	$V_{IN} > V_{OUT(nom)} + V_{DO}$	$I_{OUT} < I_{CL}$
Dropout mode	$V_{IN} < V_{OUT(nom)} + V_{DO}$	$I_{OUT} < I_{CL}$
Current limit	$V_{IN} > UVLO$	$I_{OUT} > I_{CL}$

## 8 Application and Implementation

### NOTE

Information in the following applications sections is not part of the TI component specification, and TI does not warrant its accuracy or completeness. TI's customers are responsible for determining suitability of components for their purposes. Customers should validate and test their design implementation to confirm system functionality.

### 8.1 Application Information

The TLV702 belongs to a new family of next-generation value LDO regulators. These devices consume low quiescent current and deliver excellent line and load transient performance. These characteristics, combined with low noise and very good PSRR with little ( $V_{IN} - V_{OUT}$ ) headroom, make this family of devices ideal for portable RF applications. This family of regulators offers current limit and thermal protection, and is specified from  $-40^{\circ}\text{C}$  to  $+125^{\circ}\text{C}$ .

### 8.2 Typical Application



Figure 25. Typical Application Circuit

#### 8.2.1 Design Requirements

Table 2 lists the design parameters.

Table 2. Design Parameters

PARAMETER	DESIGN REQUIREMENT
Input voltage	2.5 V to 3.3 V
Output voltage	1.8 V
Output current	100 mA

#### 8.2.2 Detailed Design Procedure

##### 8.2.2.1 Input and Output Capacitor Requirements

1- $\mu\text{F}$  X5R- and X7R-type ceramic capacitors are recommended because these capacitors have minimal variation in value and equivalent series resistance (ESR) over temperature.

However, the TLV702 is designed to be stable with an *effective capacitance* of 0.1  $\mu\text{F}$  or larger at the output. Thus, the device is stable with capacitors of other dielectric types as well, as long as the effective capacitance under operating bias voltage and temperature is greater than 0.1  $\mu\text{F}$ . This effective capacitance refers to the capacitance that the LDO sees under operating bias voltage and temperature conditions; that is, the capacitance after taking both bias voltage and temperature derating into consideration. In addition to allowing the use of lower-cost dielectrics, this capability of being stable with 0.1- $\mu\text{F}$  effective capacitance also enables the use of smaller footprint capacitors that have higher derating in size- and space-constrained applications.

Using a 0.1- $\mu\text{F}$  rated capacitor at the output of the LDO does not ensure stability because the effective capacitance under the specified operating conditions must not be less than 0.1  $\mu\text{F}$ . Maximum ESR should be less than 200 m $\Omega$ .

Although an input capacitor is not required for stability, it is good analog design practice to connect a 0.1- $\mu\text{F}$  to 1- $\mu\text{F}$ , low ESR capacitor across the IN pin and GND pin of the regulator. This capacitor counteracts reactive input sources and improves transient response, noise rejection, and ripple rejection. A higher-value capacitor may be necessary if large, fast rise-time load transients are anticipated, or if the device is not located close to the power source. If source impedance is more than 2  $\Omega$ , a 0.1- $\mu\text{F}$  input capacitor may be necessary to ensure stability.

### 8.2.2.2 Transient Response

As with any regulator, increasing the size of the output capacitor reduces overshoot and undershoot magnitude but increases the duration of the transient response.

### 8.2.3 Application Curves

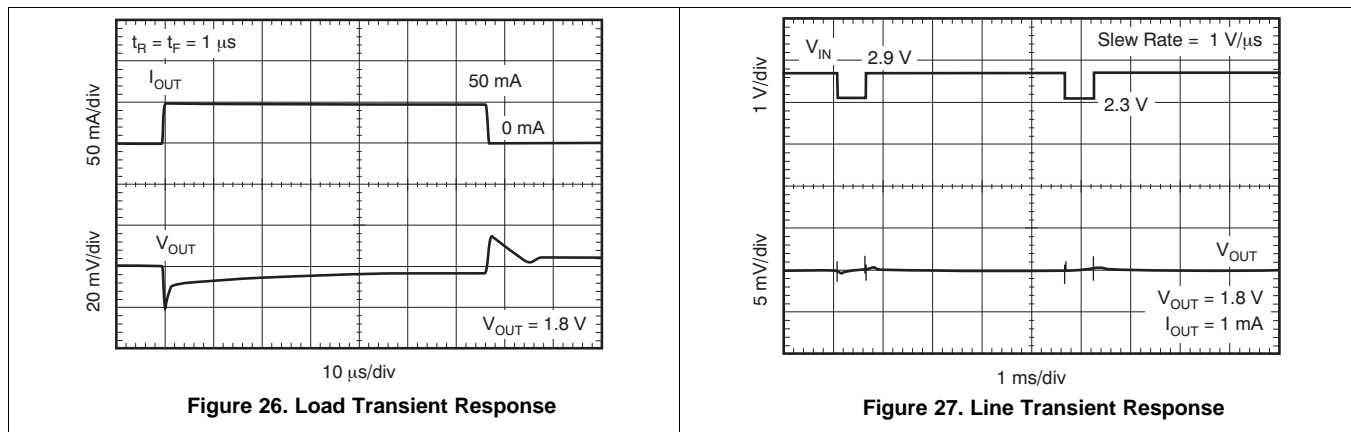

**Figure 26. Load Transient Response**

**Figure 27. Line Transient Response**

## 9 Power Supply Recommendations

Connect a low output impedance power supply directly to the INPUT pin of the TLV702. Inductive impedances between the input supply and the INPUT pin can create significant voltage excursions at the INPUT pin during start-up or load transient events.

### 9.1 Power Dissipation

The ability to remove heat from the die is different for each package type, presenting different considerations in the printed-circuit-board (PCB) layout. The PCB area around the device that is free of other components moves the heat from the device to the ambient air.

Refer to [Thermal Information](#) for thermal performance on the TLV702 evaluation module (EVM). The EVM is a two-layer board with two ounces of copper per side.

Power dissipation depends on input voltage and load conditions. Power dissipation ( $P_D$ ) is equal to the product of the output current and the voltage drop across the output pass element, as shown in [Equation 2](#).

$$P_D = (V_{IN} - V_{OUT}) \times I_{OUT} \quad (2)$$

## 10 Layout

### 10.1 Layout Guidelines

Input and output capacitors should be placed as close to the device pins as possible. To improve AC performance such as PSRR, output noise, and transient response, TI recommends designing the board with separate ground planes for  $V_{IN}$  and  $V_{OUT}$ , with the ground plane connected only at the GND pin of the device. In addition, the ground connection for the output capacitor should be connected directly to the GND pin of the device. High ESR capacitors may degrade PSRR performance.

#### 10.1.1 Thermal Consideration

Thermal protection disables the output when the junction temperature rises to approximately 165°C, allowing the device to cool. When the junction temperature cools to approximately 145°C, the output circuitry is again enabled. Depending on power dissipation, thermal resistance, and ambient temperature, the thermal protection circuit may cycle on and off. This cycling limits the dissipation of the regulator, protecting it from damage as a result of overheating.

Any tendency to activate the thermal protection circuit indicates excessive power dissipation or an inadequate heatsink. For reliable operation, junction temperature should be limited to 125°C maximum.

To estimate the margin of safety in a complete design (including heatsink), increase the ambient temperature until the thermal protection is triggered; use worst-case loads and signal conditions.

The internal protection circuitry of the TLV702 has been designed to protect against overload conditions. It was not intended to replace proper heatsinking. Continuously running the TLV702 into thermal shutdown degrades device reliability.

## Layout Guidelines (continued)

### 10.1.2 Package Mounting

Solder pad footprint recommendations for the TLV702 are available from the TI website at [www.ti.com](http://www.ti.com). The recommended land pattern for the DBV and DSE packages are shown in [Figure 28](#) and [Figure 29](#), respectively.

### 10.2 Layout Examples



**Figure 28. Layout Example for the DBV Package**



**Figure 29. Layout Example for the DSE Package**

## 11 Device and Documentation Support

### 11.1 Device Support

#### 11.1.1 Development Support

##### 11.1.1.1 Spice Models

Computer simulation of circuit performance using SPICE is often useful when analyzing the performance of analog circuits and systems. A SPICE model for the TLV702 is available through the product folders under *Tools & Software*.

#### 11.1.2 Device Nomenclature

**Table 3. Ordering Information<sup>(1)</sup>**

PRODUCT	V <sub>OUT</sub> <sup>(2)</sup>
TLV702xx yyyz	<b>XX</b> is nominal output voltage (for example, 28 = 2.8 V). <b>YYY</b> is the package designator. <b>Z</b> is tape and reel quantity (R = 3000, T = 250).

- (1) For the most current package and ordering information see the Package Option Addendum at the end of this document, or visit the device product folder at [www.ti.com](http://www.ti.com).  
 (2) Output voltages from 1.2 V to 4.8 V in 50-mV increments are available. Contact factory for details and availability.

### 11.2 Documentation Support

#### 11.2.1 Related Documentation

For related documentation see the following:

Texas Instruments, [Using the TLV700xxEVM-503 user's guide](#)

#### 11.3 Receiving Notification of Documentation Updates

To receive notification of documentation updates, navigate to the device product folder on ti.com. In the upper right corner, click on *Alert me* to register and receive a weekly digest of any product information that has changed. For change details, review the revision history included in any revised document.

#### 11.4 Community Resources

The following links connect to TI community resources. Linked contents are provided "AS IS" by the respective contributors. They do not constitute TI specifications and do not necessarily reflect TI's views; see TI's [Terms of Use](#).

**TI E2E™ Online Community** *TI's Engineer-to-Engineer (E2E) Community*. Created to foster collaboration among engineers. At [e2e.ti.com](http://e2e.ti.com), you can ask questions, share knowledge, explore ideas and help solve problems with fellow engineers.

**Design Support** *TI's Design Support* Quickly find helpful E2E forums along with design support tools and contact information for technical support.

#### 11.5 Trademarks

E2E is a trademark of Texas Instruments.

*Bluetooth* is a registered trademark of Bluetooth SIG.

ZigBee is a registered trademark of the ZigBee Alliance.

All other trademarks are the property of their respective owners.

#### 11.6 Electrostatic Discharge Caution



This integrated circuit can be damaged by ESD. Texas Instruments recommends that all integrated circuits be handled with appropriate precautions. Failure to observe proper handling and installation procedures can cause damage.

ESD damage can range from subtle performance degradation to complete device failure. Precision integrated circuits may be more susceptible to damage because very small parametric changes could cause the device not to meet its published specifications.

## 11.7 Glossary

[SLYZ022](#) — *TI Glossary*.

This glossary lists and explains terms, acronyms, and definitions.

## 12 Mechanical, Packaging, and Orderable Information

The following pages include mechanical, packaging, and orderable information. This information is the most current data available for the designated devices. This data is subject to change without notice and revision of this document. For browser-based versions of this data sheet, refer to the left-hand navigation.

**PACKAGING INFORMATION**

Orderable part number	Status (1)	Material type (2)	Package   Pins	Package qty   Carrier	RoHS (3)	Lead finish/ Ball material (4)	MSL rating/ Peak reflow (5)	Op temp (°C)	Part marking (6)
<a href="#">TLV70212DBVR</a>	Active	Production	SOT-23 (DBV)   5	3000   LARGE T&R	Yes	NIPDAU   SN	Level-1-260C-UNLIM	-40 to 125	QVN
TLV70212DBVR.A	Active	Production	SOT-23 (DBV)   5	3000   LARGE T&R	Yes	SN	Level-1-260C-UNLIM	-40 to 125	QVN
TLV70212DBVR.B	Active	Production	SOT-23 (DBV)   5	3000   LARGE T&R	Yes	SN	Level-1-260C-UNLIM	-40 to 125	QVN
TLV70212DBVRG4	Active	Production	SOT-23 (DBV)   5	3000   LARGE T&R	Yes	NIPDAU	Level-1-260C-UNLIM	-40 to 125	QVN
TLV70212DBVRG4.A	Active	Production	SOT-23 (DBV)   5	3000   LARGE T&R	Yes	NIPDAU	Level-1-260C-UNLIM	-40 to 125	QVN
TLV70212DBVRG4.B	Active	Production	SOT-23 (DBV)   5	3000   LARGE T&R	Yes	NIPDAU	Level-1-260C-UNLIM	-40 to 125	QVN
<a href="#">TLV70212DBVT</a>	Active	Production	SOT-23 (DBV)   5	250   SMALL T&R	Yes	NIPDAU   SN	Level-1-260C-UNLIM	-40 to 125	QVN
TLV70212DBVT.A	Active	Production	SOT-23 (DBV)   5	250   SMALL T&R	Yes	NIPDAU	Level-1-260C-UNLIM	-40 to 125	QVN
TLV70212DBVT.B	Active	Production	SOT-23 (DBV)   5	250   SMALL T&R	Yes	NIPDAU	Level-1-260C-UNLIM	-40 to 125	QVN
<a href="#">TLV70213DBVR</a>	Active	Production	SOT-23 (DBV)   5	3000   LARGE T&R	Yes	NIPDAU   SN	Level-1-260C-UNLIM	-40 to 125	12UW
TLV70213DBVR.A	Active	Production	SOT-23 (DBV)   5	3000   LARGE T&R	Yes	NIPDAU	Level-1-260C-UNLIM	-40 to 125	12UW
TLV70213DBVR.B	Active	Production	SOT-23 (DBV)   5	3000   LARGE T&R	Yes	NIPDAU	Level-1-260C-UNLIM	-40 to 125	12UW
<a href="#">TLV70213DBVT</a>	Active	Production	SOT-23 (DBV)   5	250   SMALL T&R	Yes	NIPDAU   SN	Level-1-260C-UNLIM	-40 to 125	12UW
TLV70213DBVT.A	Active	Production	SOT-23 (DBV)   5	250   SMALL T&R	Yes	NIPDAU	Level-1-260C-UNLIM	-40 to 125	12UW
TLV70213DBVT.B	Active	Production	SOT-23 (DBV)   5	250   SMALL T&R	Yes	NIPDAU	Level-1-260C-UNLIM	-40 to 125	12UW
<a href="#">TLV70215DBVR</a>	Active	Production	SOT-23 (DBV)   5	3000   LARGE T&R	Yes	NIPDAU   SN	Level-1-260C-UNLIM	-40 to 125	SIR
TLV70215DBVR.A	Active	Production	SOT-23 (DBV)   5	3000   LARGE T&R	Yes	NIPDAU	Level-1-260C-UNLIM	-40 to 125	SIR
TLV70215DBVR.B	Active	Production	SOT-23 (DBV)   5	3000   LARGE T&R	Yes	NIPDAU	Level-1-260C-UNLIM	-40 to 125	SIR
<a href="#">TLV70215DBVT</a>	Active	Production	SOT-23 (DBV)   5	250   SMALL T&R	Yes	NIPDAU   SN	Level-1-260C-UNLIM	-40 to 125	SIR
TLV70215DBVT.A	Active	Production	SOT-23 (DBV)   5	250   SMALL T&R	Yes	SN	Level-1-260C-UNLIM	-40 to 125	SIR
TLV70215DBVT.B	Active	Production	SOT-23 (DBV)   5	250   SMALL T&R	Yes	SN	Level-1-260C-UNLIM	-40 to 125	SIR
<a href="#">TLV70215PDBVR</a>	Active	Production	SOT-23 (DBV)   5	3000   LARGE T&R	Yes	NIPDAU   SN	Level-1-260C-UNLIM	-40 to 125	SLG
TLV70215PDBVR.B	Active	Production	SOT-23 (DBV)   5	3000   LARGE T&R	Yes	SN	Level-1-260C-UNLIM	-40 to 125	SLG
<a href="#">TLV70215PDBVT</a>	Active	Production	SOT-23 (DBV)   5	250   SMALL T&R	Yes	NIPDAU   SN	Level-1-260C-UNLIM	-40 to 125	SLG
TLV70215PDBVT.B	Active	Production	SOT-23 (DBV)   5	250   SMALL T&R	Yes	SN	Level-1-260C-UNLIM	-40 to 125	SLG
<a href="#">TLV70218DBVR</a>	Active	Production	SOT-23 (DBV)   5	3000   LARGE T&R	Yes	NIPDAU   SN	Level-1-260C-UNLIM	-40 to 125	QUW
TLV70218DBVR.A	Active	Production	SOT-23 (DBV)   5	3000   LARGE T&R	Yes	NIPDAU	Level-1-260C-UNLIM	-40 to 125	QUW
TLV70218DBVR.B	Active	Production	SOT-23 (DBV)   5	3000   LARGE T&R	Yes	NIPDAU	Level-1-260C-UNLIM	-40 to 125	QUW
<a href="#">TLV70218DBVRG4</a>	Active	Production	SOT-23 (DBV)   5	3000   LARGE T&R	Yes	NIPDAU	Level-1-260C-UNLIM	-40 to 125	QUW

Orderable part number	Status (1)	Material type (2)	Package   Pins	Package qty   Carrier	RoHS (3)	Lead finish/ Ball material (4)	MSL rating/ Peak reflow (5)	Op temp (°C)	Part marking (6)
TLV70218DBVRG4.A	Active	Production	SOT-23 (DBV)   5	3000   LARGE T&R	Yes	NIPDAU	Level-1-260C-UNLIM	-40 to 125	QUW
TLV70218DBVRG4.B	Active	Production	SOT-23 (DBV)   5	3000   LARGE T&R	Yes	NIPDAU	Level-1-260C-UNLIM	-40 to 125	QUW
<a href="#">TLV70218DBVT</a>	Active	Production	SOT-23 (DBV)   5	250   SMALL T&R	Yes	NIPDAU   SN	Level-1-260C-UNLIM	-40 to 125	QUW
TLV70218DBVT.A	Active	Production	SOT-23 (DBV)   5	250   SMALL T&R	Yes	NIPDAU	Level-1-260C-UNLIM	-40 to 125	QUW
TLV70218DBVT.B	Active	Production	SOT-23 (DBV)   5	250   SMALL T&R	Yes	NIPDAU	Level-1-260C-UNLIM	-40 to 125	QUW
<a href="#">TLV70220PDBVR</a>	Active	Production	SOT-23 (DBV)   5	3000   LARGE T&R	Yes	NIPDAU	Level-1-260C-UNLIM	-40 to 125	QXL
TLV70220PDBVR.B	Active	Production	SOT-23 (DBV)   5	3000   LARGE T&R	Yes	NIPDAU	Level-1-260C-UNLIM	-40 to 125	QXL
TLV70220PDBVRG4	Active	Production	SOT-23 (DBV)   5	3000   LARGE T&R	Yes	NIPDAU	Level-1-260C-UNLIM	-40 to 125	QXL
TLV70220PDBVRG4.B	Active	Production	SOT-23 (DBV)   5	3000   LARGE T&R	Yes	NIPDAU	Level-1-260C-UNLIM	-40 to 125	QXL
<a href="#">TLV70220PDBVT</a>	Active	Production	SOT-23 (DBV)   5	250   SMALL T&R	Yes	NIPDAU	Level-1-260C-UNLIM	-40 to 125	QXL
TLV70220PDBVT.B	Active	Production	SOT-23 (DBV)   5	250   SMALL T&R	Yes	NIPDAU	Level-1-260C-UNLIM	-40 to 125	QXL
<a href="#">TLV70225DBVR</a>	Active	Production	SOT-23 (DBV)   5	3000   LARGE T&R	Yes	NIPDAU   SN	Level-1-260C-UNLIM	-40 to 125	QVF
TLV70225DBVR.A	Active	Production	SOT-23 (DBV)   5	3000   LARGE T&R	Yes	NIPDAU	Level-1-260C-UNLIM	-40 to 125	QVF
TLV70225DBVR.B	Active	Production	SOT-23 (DBV)   5	3000   LARGE T&R	Yes	NIPDAU	Level-1-260C-UNLIM	-40 to 125	QVF
TLV70225DBVRG4	Active	Production	SOT-23 (DBV)   5	3000   LARGE T&R	Yes	NIPDAU	Level-1-260C-UNLIM	-40 to 125	QVF
TLV70225DBVRG4.A	Active	Production	SOT-23 (DBV)   5	3000   LARGE T&R	Yes	NIPDAU	Level-1-260C-UNLIM	-40 to 125	QVF
TLV70225DBVRG4.B	Active	Production	SOT-23 (DBV)   5	3000   LARGE T&R	Yes	NIPDAU	Level-1-260C-UNLIM	-40 to 125	QVF
<a href="#">TLV70225DBVT</a>	Active	Production	SOT-23 (DBV)   5	250   SMALL T&R	Yes	NIPDAU   SN	Level-1-260C-UNLIM	-40 to 125	QVF
TLV70225DBVT.B	Active	Production	SOT-23 (DBV)   5	250   SMALL T&R	Yes	NIPDAU	Level-1-260C-UNLIM	-40 to 125	QVF
<a href="#">TLV70225DSER</a>	Active	Production	WSON (DSE)   6	3000   LARGE T&R	Yes	NIPDAUAG	Level-1-260C-UNLIM	-40 to 125	SY
TLV70225DSER.A	Active	Production	WSON (DSE)   6	3000   LARGE T&R	Yes	NIPDAUAG	Level-1-260C-UNLIM	-40 to 125	SY
TLV70225DSER.B	Active	Production	WSON (DSE)   6	3000   LARGE T&R	Yes	NIPDAUAG	Level-1-260C-UNLIM	-40 to 125	SY
<a href="#">TLV70225DSET</a>	Active	Production	WSON (DSE)   6	250   SMALL T&R	Yes	NIPDAUAG	Level-1-260C-UNLIM	-40 to 125	SY
TLV70225DSET.A	Active	Production	WSON (DSE)   6	250   SMALL T&R	Yes	NIPDAUAG	Level-1-260C-UNLIM	-40 to 125	SY
TLV70225DSET.B	Active	Production	WSON (DSE)   6	250   SMALL T&R	Yes	NIPDAUAG	Level-1-260C-UNLIM	-40 to 125	SY
<a href="#">TLV70228DBVR</a>	Active	Production	SOT-23 (DBV)   5	3000   LARGE T&R	Yes	NIPDAU	Level-1-260C-UNLIM	-40 to 125	QUX
TLV70228DBVR.B	Active	Production	SOT-23 (DBV)   5	3000   LARGE T&R	Yes	NIPDAU	Level-1-260C-UNLIM	-40 to 125	QUX
TLV70228DBVRG4	Active	Production	SOT-23 (DBV)   5	3000   LARGE T&R	Yes	NIPDAU	Level-1-260C-UNLIM	-40 to 125	QUX
TLV70228DBVRG4.B	Active	Production	SOT-23 (DBV)   5	3000   LARGE T&R	Yes	NIPDAU	Level-1-260C-UNLIM	-40 to 125	QUX
<a href="#">TLV70228DBVT</a>	Active	Production	SOT-23 (DBV)   5	250   SMALL T&R	Yes	NIPDAU   SN	Level-1-260C-UNLIM	-40 to 125	QUX
TLV70228DBVT.B	Active	Production	SOT-23 (DBV)   5	250   SMALL T&R	Yes	NIPDAU	Level-1-260C-UNLIM	-40 to 125	QUX

Orderable part number	Status (1)	Material type (2)	Package   Pins	Package qty   Carrier	RoHS (3)	Lead finish/ Ball material (4)	MSL rating/ Peak reflow (5)	Op temp (°C)	Part marking (6)
<a href="#">TLV70228DSER</a>	Active	Production	WSON (DSE)   6	3000   LARGE T&R	Yes	NIPDAUAG	Level-1-260C-UNLIM	-40 to 125	VY
TLV70228DSER.B	Active	Production	WSON (DSE)   6	3000   LARGE T&R	Yes	NIPDAUAG	Level-1-260C-UNLIM	-40 to 125	VY
<a href="#">TLV70228DSET</a>	Active	Production	WSON (DSE)   6	250   SMALL T&R	Yes	NIPDAUAG	Level-1-260C-UNLIM	-40 to 125	VY
TLV70228DSET.B	Active	Production	WSON (DSE)   6	250   SMALL T&R	Yes	NIPDAUAG	Level-1-260C-UNLIM	-40 to 125	VY
<a href="#">TLV70228PDBVR</a>	Active	Production	SOT-23 (DBV)   5	3000   LARGE T&R	Yes	NIPDAU	Level-1-260C-UNLIM	-40 to 125	QVA
TLV70228PDBVR.B	Active	Production	SOT-23 (DBV)   5	3000   LARGE T&R	Yes	NIPDAU	Level-1-260C-UNLIM	-40 to 125	QVA
TLV70228PDBVRG4	Active	Production	SOT-23 (DBV)   5	3000   LARGE T&R	Yes	NIPDAU	Level-1-260C-UNLIM	-40 to 125	QVA
TLV70228PDBVRG4.B	Active	Production	SOT-23 (DBV)   5	3000   LARGE T&R	Yes	NIPDAU	Level-1-260C-UNLIM	-40 to 125	QVA
<a href="#">TLV70228PDBVT</a>	Active	Production	SOT-23 (DBV)   5	250   SMALL T&R	Yes	NIPDAU   SN	Level-1-260C-UNLIM	-40 to 125	QVA
TLV70228PDBVT.B	Active	Production	SOT-23 (DBV)   5	250   SMALL T&R	Yes	SN	Level-1-260C-UNLIM	-40 to 125	QVA
<a href="#">TLV70229DBVR</a>	Active	Production	SOT-23 (DBV)   5	3000   LARGE T&R	Yes	NIPDAU	Level-1-260C-UNLIM	-40 to 125	SJW
TLV70229DBVR.B	Active	Production	SOT-23 (DBV)   5	3000   LARGE T&R	Yes	NIPDAU	Level-1-260C-UNLIM	-40 to 125	SJW
TLV70229DBVRG4	Active	Production	SOT-23 (DBV)   5	3000   LARGE T&R	Yes	NIPDAU	Level-1-260C-UNLIM	-40 to 125	SJW
TLV70229DBVRG4.B	Active	Production	SOT-23 (DBV)   5	3000   LARGE T&R	Yes	NIPDAU	Level-1-260C-UNLIM	-40 to 125	SJW
<a href="#">TLV70229DBVT</a>	Active	Production	SOT-23 (DBV)   5	250   SMALL T&R	Yes	NIPDAU   SN	Level-1-260C-UNLIM	-40 to 125	SJW
TLV70229DBVT.B	Active	Production	SOT-23 (DBV)   5	250   SMALL T&R	Yes	NIPDAU	Level-1-260C-UNLIM	-40 to 125	SJW
<a href="#">TLV70229DSER</a>	Active	Production	WSON (DSE)   6	3000   LARGE T&R	Yes	NIPDAUAG	Level-1-260C-UNLIM	-40 to 125	SZ
TLV70229DSER.B	Active	Production	WSON (DSE)   6	3000   LARGE T&R	Yes	NIPDAUAG	Level-1-260C-UNLIM	-40 to 125	SZ
<a href="#">TLV70229DSET</a>	Active	Production	WSON (DSE)   6	250   SMALL T&R	Yes	NIPDAUAG	Level-1-260C-UNLIM	-40 to 125	SZ
TLV70229DSET.B	Active	Production	WSON (DSE)   6	250   SMALL T&R	Yes	NIPDAUAG	Level-1-260C-UNLIM	-40 to 125	SZ
<a href="#">TLV70230DBVR</a>	Active	Production	SOT-23 (DBV)   5	3000   LARGE T&R	Yes	NIPDAU   SN	Level-1-260C-UNLIM	-40 to 125	QUY
TLV70230DBVR.A	Active	Production	SOT-23 (DBV)   5	3000   LARGE T&R	Yes	NIPDAU	Level-1-260C-UNLIM	-40 to 125	QUY
TLV70230DBVR.B	Active	Production	SOT-23 (DBV)   5	3000   LARGE T&R	Yes	NIPDAU	Level-1-260C-UNLIM	-40 to 125	QUY
<a href="#">TLV70230DBVT</a>	Active	Production	SOT-23 (DBV)   5	250   SMALL T&R	Yes	NIPDAU   SN	Level-1-260C-UNLIM	-40 to 125	QUY
TLV70230DBVT.A	Active	Production	SOT-23 (DBV)   5	250   SMALL T&R	Yes	NIPDAU	Level-1-260C-UNLIM	-40 to 125	QUY
TLV70230DBVT.B	Active	Production	SOT-23 (DBV)   5	250   SMALL T&R	Yes	NIPDAU	Level-1-260C-UNLIM	-40 to 125	QUY
<a href="#">TLV70231DBVR</a>	Active	Production	SOT-23 (DBV)   5	3000   LARGE T&R	Yes	NIPDAU	Level-1-260C-UNLIM	-40 to 125	QUZ
TLV70231DBVR.A	Active	Production	SOT-23 (DBV)   5	3000   LARGE T&R	Yes	NIPDAU	Level-1-260C-UNLIM	-40 to 125	QUZ
TLV70231DBVR.B	Active	Production	SOT-23 (DBV)   5	3000   LARGE T&R	Yes	NIPDAU	Level-1-260C-UNLIM	-40 to 125	QUZ
<a href="#">TLV70231DBVT</a>	Active	Production	SOT-23 (DBV)   5	250   SMALL T&R	Yes	NIPDAU	Level-1-260C-UNLIM	-40 to 125	QUZ
TLV70231DBVT.A	Active	Production	SOT-23 (DBV)   5	250   SMALL T&R	Yes	NIPDAU	Level-1-260C-UNLIM	-40 to 125	QUZ

Orderable part number	Status (1)	Material type (2)	Package   Pins	Package qty   Carrier	RoHS (3)	Lead finish/ Ball material (4)	MSL rating/ Peak reflow (5)	Op temp (°C)	Part marking (6)
TLV70231DBVT.B	Active	Production	SOT-23 (DBV)   5	250   SMALL T&R	Yes	NIPDAU	Level-1-260C-UNLIM	-40 to 125	QUZ
<a href="#">TLV70233DBVR</a>	Active	Production	SOT-23 (DBV)   5	3000   LARGE T&R	Yes	NIPDAU   SN	Level-1-260C-UNLIM	-40 to 125	QVD
TLV70233DBVR.A	Active	Production	SOT-23 (DBV)   5	3000   LARGE T&R	Yes	NIPDAU	Level-1-260C-UNLIM	-40 to 125	QVD
TLV70233DBVR.B	Active	Production	SOT-23 (DBV)   5	3000   LARGE T&R	Yes	NIPDAU	Level-1-260C-UNLIM	-40 to 125	QVD
TLV70233DBVRG4	Active	Production	SOT-23 (DBV)   5	3000   LARGE T&R	Yes	NIPDAU	Level-1-260C-UNLIM	-40 to 125	QVD
TLV70233DBVRG4.A	Active	Production	SOT-23 (DBV)   5	3000   LARGE T&R	Yes	NIPDAU	Level-1-260C-UNLIM	-40 to 125	QVD
TLV70233DBVRG4.B	Active	Production	SOT-23 (DBV)   5	3000   LARGE T&R	Yes	NIPDAU	Level-1-260C-UNLIM	-40 to 125	QVD
<a href="#">TLV70233DBVT</a>	Active	Production	SOT-23 (DBV)   5	250   SMALL T&R	Yes	NIPDAU   SN	Level-1-260C-UNLIM	-40 to 125	QVD
TLV70233DBVT.A	Active	Production	SOT-23 (DBV)   5	250   SMALL T&R	Yes	NIPDAU	Level-1-260C-UNLIM	-40 to 125	QVD
TLV70233DBVT.B	Active	Production	SOT-23 (DBV)   5	250   SMALL T&R	Yes	NIPDAU	Level-1-260C-UNLIM	-40 to 125	QVD
<a href="#">TLV70233DSEB</a>	Active	Production	WSON (DSE)   6	3000   LARGE T&R	Yes	NIPDAUAG	Level-1-260C-UNLIM	-40 to 125	WK
TLV70233DSEB.B	Active	Production	WSON (DSE)   6	3000   LARGE T&R	Yes	NIPDAUAG	Level-1-260C-UNLIM	-40 to 125	WK
<a href="#">TLV70233DSEB</a>	Active	Production	WSON (DSE)   6	250   SMALL T&R	Yes	NIPDAUAG	Level-1-260C-UNLIM	-40 to 125	WK
TLV70233DSEB.B	Active	Production	WSON (DSE)   6	250   SMALL T&R	Yes	NIPDAUAG	Level-1-260C-UNLIM	-40 to 125	WK
<a href="#">TLV70233PDBVR</a>	Active	Production	SOT-23 (DBV)   5	3000   LARGE T&R	Yes	NIPDAU   SN	Level-1-260C-UNLIM	-40 to 125	SLH
TLV70233PDBVR.B	Active	Production	SOT-23 (DBV)   5	3000   LARGE T&R	Yes	SN	Level-1-260C-UNLIM	-40 to 125	SLH
TLV70233PDBVRG4	Active	Production	SOT-23 (DBV)   5	3000   LARGE T&R	Yes	NIPDAU	Level-1-260C-UNLIM	-40 to 125	SLH
TLV70233PDBVRG4.B	Active	Production	SOT-23 (DBV)   5	3000   LARGE T&R	Yes	NIPDAU	Level-1-260C-UNLIM	-40 to 125	SLH
<a href="#">TLV70233PDBVT</a>	Active	Production	SOT-23 (DBV)   5	250   SMALL T&R	Yes	NIPDAU   SN	Level-1-260C-UNLIM	-40 to 125	SLH
TLV70233PDBVT.B	Active	Production	SOT-23 (DBV)   5	250   SMALL T&R	Yes	SN	Level-1-260C-UNLIM	-40 to 125	SLH
<a href="#">TLV70235DBVR</a>	Active	Production	SOT-23 (DBV)   5	3000   LARGE T&R	Yes	NIPDAU   SN	Level-1-260C-UNLIM	-40 to 125	SDT
TLV70235DBVR.A	Active	Production	SOT-23 (DBV)   5	3000   LARGE T&R	Yes	SN	Level-1-260C-UNLIM	-40 to 125	SDT
TLV70235DBVR.B	Active	Production	SOT-23 (DBV)   5	3000   LARGE T&R	Yes	SN	Level-1-260C-UNLIM	-40 to 125	SDT
<a href="#">TLV70235DBVT</a>	Active	Production	SOT-23 (DBV)   5	250   SMALL T&R	Yes	NIPDAU   SN	Level-1-260C-UNLIM	-40 to 125	SDT
TLV70235DBVT.A	Active	Production	SOT-23 (DBV)   5	250   SMALL T&R	Yes	SN	Level-1-260C-UNLIM	-40 to 125	SDT
TLV70235DBVT.B	Active	Production	SOT-23 (DBV)   5	250   SMALL T&R	Yes	SN	Level-1-260C-UNLIM	-40 to 125	SDT
<a href="#">TLV70236DSEB</a>	Active	Production	WSON (DSE)   6	3000   LARGE T&R	Yes	NIPDAUAG	Level-1-260C-UNLIM	-40 to 125	VZ
TLV70236DSEB.B	Active	Production	WSON (DSE)   6	3000   LARGE T&R	Yes	NIPDAUAG	Level-1-260C-UNLIM	-40 to 125	VZ
<a href="#">TLV70236DSEB</a>	Active	Production	WSON (DSE)   6	250   SMALL T&R	Yes	NIPDAUAG	Level-1-260C-UNLIM	-40 to 125	VZ
TLV70236DSEB.B	Active	Production	WSON (DSE)   6	250   SMALL T&R	Yes	NIPDAUAG	Level-1-260C-UNLIM	-40 to 125	VZ
<a href="#">TLV70237DBVR</a>	Active	Production	SOT-23 (DBV)   5	3000   LARGE T&R	Yes	NIPDAU   SN	Level-1-260C-UNLIM	-40 to 125	QXR

Orderable part number	Status (1)	Material type (2)	Package   Pins	Package qty   Carrier	RoHS (3)	Lead finish/ Ball material (4)	MSL rating/ Peak reflow (5)	Op temp (°C)	Part marking (6)
TLV70237DBVR.A	Active	Production	SOT-23 (DBV)   5	3000   LARGE T&R	Yes	SN	Level-1-260C-UNLIM	-40 to 125	QXR
TLV70237DBVR.B	Active	Production	SOT-23 (DBV)   5	3000   LARGE T&R	Yes	SN	Level-1-260C-UNLIM	-40 to 125	QXR
<a href="#">TLV70237DBVT</a>	Active	Production	SOT-23 (DBV)   5	250   SMALL T&R	Yes	NIPDAU	Level-1-260C-UNLIM	-40 to 125	QXR
TLV70237DBVT.A	Active	Production	SOT-23 (DBV)   5	250   SMALL T&R	Yes	NIPDAU	Level-1-260C-UNLIM	-40 to 125	QXR
TLV70237DBVT.B	Active	Production	SOT-23 (DBV)   5	250   SMALL T&R	Yes	NIPDAU	Level-1-260C-UNLIM	-40 to 125	QXR
<a href="#">TLV70237DSE</a>	Active	Production	WSON (DSE)   6	3000   LARGE T&R	Yes	NIPDAUAG	Level-1-260C-UNLIM	-40 to 125	D8
TLV70237DSE.B	Active	Production	WSON (DSE)   6	3000   LARGE T&R	Yes	NIPDAUAG	Level-1-260C-UNLIM	-40 to 125	D8
<a href="#">TLV70237DSET</a>	Active	Production	WSON (DSE)   6	250   SMALL T&R	Yes	NIPDAUAG	Level-1-260C-UNLIM	-40 to 125	D8
TLV70237DSET.B	Active	Production	WSON (DSE)   6	250   SMALL T&R	Yes	NIPDAUAG	Level-1-260C-UNLIM	-40 to 125	D8
<a href="#">TLV70242PDSE</a>	Active	Production	WSON (DSE)   6	3000   LARGE T&R	Yes	NIPDAUAG	Level-1-260C-UNLIM	-40 to 125	B9
TLV70242PDSE.B	Active	Production	WSON (DSE)   6	3000   LARGE T&R	Yes	NIPDAUAG	Level-1-260C-UNLIM	-40 to 125	B9
<a href="#">TLV70242PDSET</a>	Active	Production	WSON (DSE)   6	250   SMALL T&R	Yes	NIPDAUAG	Level-1-260C-UNLIM	-40 to 125	B9
TLV70242PDSET.B	Active	Production	WSON (DSE)   6	250   SMALL T&R	Yes	NIPDAUAG	Level-1-260C-UNLIM	-40 to 125	B9
<a href="#">TLV70243DSE</a>	Active	Production	WSON (DSE)   6	3000   LARGE T&R	Yes	NIPDAUAG	Level-1-260C-UNLIM	-40 to 125	5Q
TLV70243DSE.B	Active	Production	WSON (DSE)   6	3000   LARGE T&R	Yes	NIPDAUAG	Level-1-260C-UNLIM	-40 to 125	5Q
<a href="#">TLV70243DSET</a>	Active	Production	WSON (DSE)   6	250   SMALL T&R	Yes	NIPDAUAG	Level-1-260C-UNLIM	-40 to 125	5Q
TLV70243DSET.B	Active	Production	WSON (DSE)   6	250   SMALL T&R	Yes	NIPDAUAG	Level-1-260C-UNLIM	-40 to 125	5Q
<a href="#">TLV70245DBVR</a>	Active	Production	SOT-23 (DBV)   5	3000   LARGE T&R	Yes	NIPDAU   SN	Level-1-260C-UNLIM	-40 to 125	SCK
TLV70245DBVR.A	Active	Production	SOT-23 (DBV)   5	3000   LARGE T&R	Yes	SN	Level-1-260C-UNLIM	-40 to 125	SCK
TLV70245DBVR.B	Active	Production	SOT-23 (DBV)   5	3000   LARGE T&R	Yes	SN	Level-1-260C-UNLIM	-40 to 125	SCK
<a href="#">TLV70245DBVT</a>	Active	Production	SOT-23 (DBV)   5	250   SMALL T&R	Yes	NIPDAU   SN	Level-1-260C-UNLIM	-40 to 125	SCK
TLV70245DBVT.A	Active	Production	SOT-23 (DBV)   5	250   SMALL T&R	Yes	SN	Level-1-260C-UNLIM	-40 to 125	SCK
TLV70245DBVT.B	Active	Production	SOT-23 (DBV)   5	250   SMALL T&R	Yes	SN	Level-1-260C-UNLIM	-40 to 125	SCK
TLV70245DBVTG4	Active	Production	SOT-23 (DBV)   5	250   SMALL T&R	Yes	NIPDAU	Level-1-260C-UNLIM	-40 to 125	SCK
TLV70245DBVTG4.A	Active	Production	SOT-23 (DBV)   5	250   SMALL T&R	Yes	NIPDAU	Level-1-260C-UNLIM	-40 to 125	SCK
TLV70245DBVTG4.B	Active	Production	SOT-23 (DBV)   5	250   SMALL T&R	Yes	NIPDAU	Level-1-260C-UNLIM	-40 to 125	SCK
<a href="#">TLV702475DBVR</a>	Active	Production	SOT-23 (DBV)   5	3000   LARGE T&R	Yes	NIPDAU   SN	Level-1-260C-UNLIM	-40 to 125	QWJ
TLV702475DBVR.A	Active	Production	SOT-23 (DBV)   5	3000   LARGE T&R	Yes	SN	Level-1-260C-UNLIM	-40 to 125	QWJ
TLV702475DBVR.B	Active	Production	SOT-23 (DBV)   5	3000   LARGE T&R	Yes	SN	Level-1-260C-UNLIM	-40 to 125	QWJ
<a href="#">TLV702475DBVT</a>	Active	Production	SOT-23 (DBV)   5	250   SMALL T&R	Yes	NIPDAU   SN	Level-1-260C-UNLIM	-40 to 125	QWJ
TLV702475DBVT.A	Active	Production	SOT-23 (DBV)   5	250   SMALL T&R	Yes	SN	Level-1-260C-UNLIM	-40 to 125	QWJ

Orderable part number	Status (1)	Material type (2)	Package   Pins	Package qty   Carrier	RoHS (3)	Lead finish/ Ball material (4)	MSL rating/ Peak reflow (5)	Op temp (°C)	Part marking (6)
TLV702475DBVT.B	Active	Production	SOT-23 (DBV)   5	250   SMALL T&R	Yes	SN	Level-1-260C-UNLIM	-40 to 125	QWJ

<sup>(1)</sup> **Status:** For more details on status, see our [product life cycle](#).

<sup>(2)</sup> **Material type:** When designated, preproduction parts are prototypes/experimental devices, and are not yet approved or released for full production. Testing and final process, including without limitation quality assurance, reliability performance testing, and/or process qualification, may not yet be complete, and this item is subject to further changes or possible discontinuation. If available for ordering, purchases will be subject to an additional waiver at checkout, and are intended for early internal evaluation purposes only. These items are sold without warranties of any kind.

<sup>(3)</sup> **RoHS values:** Yes, No, RoHS Exempt. See the [TI RoHS Statement](#) for additional information and value definition.

<sup>(4)</sup> **Lead finish/Ball material:** Parts may have multiple material finish options. Finish options are separated by a vertical ruled line. Lead finish/Ball material values may wrap to two lines if the finish value exceeds the maximum column width.

<sup>(5)</sup> **MSL rating/Peak reflow:** The moisture sensitivity level ratings and peak solder (reflow) temperatures. In the event that a part has multiple moisture sensitivity ratings, only the lowest level per JEDEC standards is shown. Refer to the shipping label for the actual reflow temperature that will be used to mount the part to the printed circuit board.

<sup>(6)</sup> **Part marking:** There may be an additional marking, which relates to the logo, the lot trace code information, or the environmental category of the part.

Multiple part markings will be inside parentheses. Only one part marking contained in parentheses and separated by a "~" will appear on a part. If a line is indented then it is a continuation of the previous line and the two combined represent the entire part marking for that device.

**Important Information and Disclaimer:** The information provided on this page represents TI's knowledge and belief as of the date that it is provided. TI bases its knowledge and belief on information provided by third parties, and makes no representation or warranty as to the accuracy of such information. Efforts are underway to better integrate information from third parties. TI has taken and continues to take reasonable steps to provide representative and accurate information but may not have conducted destructive testing or chemical analysis on incoming materials and chemicals. TI and TI suppliers consider certain information to be proprietary, and thus CAS numbers and other limited information may not be available for release.

In no event shall TI's liability arising out of such information exceed the total purchase price of the TI part(s) at issue in this document sold by TI to Customer on an annual basis.

#### OTHER QUALIFIED VERSIONS OF TLV702 :

- Automotive : [TLV702-Q1](#)

NOTE: Qualified Version Definitions:

- Automotive - Q100 devices qualified for high-reliability automotive applications targeting zero defects

**TAPE AND REEL INFORMATION**

**QUADRANT ASSIGNMENTS FOR PIN 1 ORIENTATION IN TAPE**

\*All dimensions are nominal

Device	Package Type	Package Drawing	Pins	SPQ	Reel Diameter (mm)	Reel Width W1 (mm)	A0 (mm)	B0 (mm)	K0 (mm)	P1 (mm)	W (mm)	Pin1 Quadrant
TLV70212DBVR	SOT-23	DBV	5	3000	180.0	8.4	3.2	3.2	1.4	4.0	8.0	Q3
TLV70212DBVRG4	SOT-23	DBV	5	3000	180.0	8.4	3.2	3.2	1.4	4.0	8.0	Q3
TLV70212DBVT	SOT-23	DBV	5	250	180.0	8.4	3.2	3.2	1.4	4.0	8.0	Q3
TLV70213DBVR	SOT-23	DBV	5	3000	180.0	8.4	3.2	3.2	1.4	4.0	8.0	Q3
TLV70213DBVT	SOT-23	DBV	5	250	180.0	8.4	3.2	3.2	1.4	4.0	8.0	Q3
TLV70215DBVR	SOT-23	DBV	5	3000	180.0	8.4	3.2	3.2	1.4	4.0	8.0	Q3
TLV70215DBVT	SOT-23	DBV	5	250	178.0	8.4	3.23	3.17	1.37	4.0	8.0	Q3
TLV70215DBVT	SOT-23	DBV	5	250	180.0	8.4	3.2	3.2	1.4	4.0	8.0	Q3
TLV70215PDBVR	SOT-23	DBV	5	3000	178.0	8.4	3.2	3.2	1.4	4.0	8.0	Q3
TLV70215PDBVT	SOT-23	DBV	5	250	180.0	8.4	3.2	3.2	1.4	4.0	8.0	Q3
TLV70215PDBVT	SOT-23	DBV	5	250	178.0	8.4	3.23	3.17	1.37	4.0	8.0	Q3
TLV70218DBVR	SOT-23	DBV	5	3000	180.0	8.4	3.2	3.2	1.4	4.0	8.0	Q3
TLV70218DBVR	SOT-23	DBV	5	3000	180.0	8.4	3.2	3.2	1.4	4.0	8.0	Q3
TLV70218DBVRG4	SOT-23	DBV	5	3000	180.0	8.4	3.2	3.2	1.4	4.0	8.0	Q3
TLV70218DBVRG4	SOT-23	DBV	5	3000	180.0	8.4	3.2	3.2	1.4	4.0	8.0	Q3
TLV70218DBVT	SOT-23	DBV	5	250	180.0	8.4	3.2	3.2	1.4	4.0	8.0	Q3

Device	Package Type	Package Drawing	Pins	SPQ	Reel Diameter (mm)	Reel Width W1 (mm)	A0 (mm)	B0 (mm)	K0 (mm)	P1 (mm)	W (mm)	Pin1 Quadrant
TLV70218DBVT	SOT-23	DBV	5	250	180.0	8.4	3.23	3.17	1.37	4.0	8.0	Q3
TLV70220PDBVR	SOT-23	DBV	5	3000	178.0	9.0	3.23	3.17	1.37	4.0	8.0	Q3
TLV70220PDBVRG4	SOT-23	DBV	5	3000	178.0	9.0	3.23	3.17	1.37	4.0	8.0	Q3
TLV70220PDBVT	SOT-23	DBV	5	250	178.0	8.4	3.23	3.17	1.37	4.0	8.0	Q3
TLV70225DBVR	SOT-23	DBV	5	3000	178.0	8.4	3.2	3.2	1.4	4.0	8.0	Q3
TLV70225DBVRG4	SOT-23	DBV	5	3000	180.0	8.4	3.2	3.2	1.4	4.0	8.0	Q3
TLV70225DBVT	SOT-23	DBV	5	250	180.0	8.4	3.2	3.2	1.4	4.0	8.0	Q3
TLV70225DSE	WSON	DSE	6	3000	179.0	8.4	1.8	1.8	1.0	4.0	8.0	Q2
TLV70225DSET	WSON	DSE	6	250	179.0	8.4	1.8	1.8	1.0	4.0	8.0	Q2
TLV70228DBVR	SOT-23	DBV	5	3000	180.0	8.4	3.2	3.2	1.4	4.0	8.0	Q3
TLV70228DBVRG4	SOT-23	DBV	5	3000	180.0	8.4	3.2	3.2	1.4	4.0	8.0	Q3
TLV70228DBVT	SOT-23	DBV	5	250	180.0	8.4	3.2	3.2	1.4	4.0	8.0	Q3
TLV70228DSE	WSON	DSE	6	3000	179.0	8.4	1.8	1.8	1.0	4.0	8.0	Q2
TLV70228DSET	WSON	DSE	6	250	179.0	8.4	1.8	1.8	1.0	4.0	8.0	Q2
TLV70228PDBVR	SOT-23	DBV	5	3000	180.0	8.4	3.23	3.17	1.37	4.0	8.0	Q3
TLV70228PDBVRG4	SOT-23	DBV	5	3000	180.0	8.4	3.23	3.17	1.37	4.0	8.0	Q3
TLV70228PDBVT	SOT-23	DBV	5	250	180.0	8.4	3.23	3.17	1.37	4.0	8.0	Q3
TLV70228PDBVT	SOT-23	DBV	5	250	180.0	8.4	3.2	3.2	1.4	4.0	8.0	Q3
TLV70229DBVR	SOT-23	DBV	5	3000	180.0	8.4	3.2	3.2	1.4	4.0	8.0	Q3
TLV70229DBVRG4	SOT-23	DBV	5	3000	180.0	8.4	3.2	3.2	1.4	4.0	8.0	Q3
TLV70229DBVT	SOT-23	DBV	5	250	180.0	8.4	3.2	3.2	1.4	4.0	8.0	Q3
TLV70229DSE	WSON	DSE	6	3000	180.0	8.4	1.83	1.83	0.89	4.0	8.0	Q2
TLV70229DSET	WSON	DSE	6	250	180.0	8.4	1.83	1.83	0.89	4.0	8.0	Q2
TLV70230DBVR	SOT-23	DBV	5	3000	178.0	8.4	3.2	3.2	1.4	4.0	8.0	Q3
TLV70230DBVT	SOT-23	DBV	5	250	180.0	8.4	3.2	3.2	1.4	4.0	8.0	Q3
TLV70231DBVR	SOT-23	DBV	5	3000	180.0	8.4	3.2	3.2	1.4	4.0	8.0	Q3
TLV70231DBVT	SOT-23	DBV	5	250	180.0	8.4	3.2	3.2	1.4	4.0	8.0	Q3
TLV70233DBVR	SOT-23	DBV	5	3000	178.0	8.4	3.2	3.2	1.4	4.0	8.0	Q3
TLV70233DBVRG4	SOT-23	DBV	5	3000	180.0	8.4	3.2	3.2	1.4	4.0	8.0	Q3
TLV70233DBVRG4	SOT-23	DBV	5	3000	180.0	8.4	3.2	3.2	1.4	4.0	8.0	Q3
TLV70233DBVT	SOT-23	DBV	5	250	180.0	8.4	3.2	3.2	1.4	4.0	8.0	Q3
TLV70233DSE	WSON	DSE	6	3000	179.0	8.4	1.8	1.8	1.0	4.0	8.0	Q2
TLV70233DSET	WSON	DSE	6	250	179.0	8.4	1.8	1.8	1.0	4.0	8.0	Q2
TLV70233PDBVR	SOT-23	DBV	5	3000	178.0	8.4	3.2	3.2	1.4	4.0	8.0	Q3
TLV70233PDBVRG4	SOT-23	DBV	5	3000	178.0	9.0	3.23	3.17	1.37	4.0	8.0	Q3
TLV70233PDBVT	SOT-23	DBV	5	250	178.0	8.4	3.23	3.17	1.37	4.0	8.0	Q3
TLV70233PDBVT	SOT-23	DBV	5	250	180.0	8.4	3.2	3.2	1.4	4.0	8.0	Q3
TLV70235DBVR	SOT-23	DBV	5	3000	178.0	8.4	3.2	3.2	1.4	4.0	8.0	Q3
TLV70235DBVT	SOT-23	DBV	5	250	180.0	8.4	3.2	3.2	1.4	4.0	8.0	Q3
TLV70236DSE	WSON	DSE	6	3000	179.0	8.4	1.8	1.8	1.0	4.0	8.0	Q2
TLV70236DSET	WSON	DSE	6	250	179.0	8.4	1.8	1.8	1.0	4.0	8.0	Q2

Device	Package Type	Package Drawing	Pins	SPQ	Reel Diameter (mm)	Reel Width W1 (mm)	A0 (mm)	B0 (mm)	K0 (mm)	P1 (mm)	W (mm)	Pin1 Quadrant
TLV70237DBVR	SOT-23	DBV	5	3000	180.0	8.4	3.2	3.2	1.4	4.0	8.0	Q3
TLV70237DBVT	SOT-23	DBV	5	250	180.0	8.4	3.2	3.2	1.4	4.0	8.0	Q3
TLV70237DSER	WSON	DSE	6	3000	180.0	8.4	1.83	1.83	0.89	4.0	8.0	Q2
TLV70237DSET	WSON	DSE	6	250	180.0	8.4	1.83	1.83	0.89	4.0	8.0	Q2
TLV70242PDSER	WSON	DSE	6	3000	180.0	8.4	1.83	1.83	0.89	4.0	8.0	Q2
TLV70242PDSET	WSON	DSE	6	250	180.0	8.4	1.83	1.83	0.89	4.0	8.0	Q2
TLV70243DSER	WSON	DSE	6	3000	180.0	8.4	1.83	1.83	0.89	4.0	8.0	Q2
TLV70243DSET	WSON	DSE	6	250	180.0	8.4	1.83	1.83	0.89	4.0	8.0	Q2
TLV70245DBVR	SOT-23	DBV	5	3000	178.0	8.4	3.2	3.2	1.4	4.0	8.0	Q3
TLV70245DBVT	SOT-23	DBV	5	250	180.0	8.4	3.2	3.2	1.4	4.0	8.0	Q3
TLV70245DBVT	SOT-23	DBV	5	250	180.0	8.4	3.23	3.17	1.37	4.0	8.0	Q3
TLV70245DBVT	SOT-23	DBV	5	250	178.0	8.4	3.3	3.2	1.4	4.0	8.0	Q3
TLV70245DBVTG4	SOT-23	DBV	5	250	178.0	8.4	3.3	3.2	1.4	4.0	8.0	Q3
TLV702475DBVR	SOT-23	DBV	5	3000	178.0	8.4	3.2	3.2	1.4	4.0	8.0	Q3
TLV702475DBVT	SOT-23	DBV	5	250	180.0	8.4	3.2	3.2	1.4	4.0	8.0	Q3
TLV702475DBVT	SOT-23	DBV	5	250	180.0	8.4	3.23	3.17	1.37	4.0	8.0	Q3
TLV702475DBVT	SOT-23	DBV	5	250	178.0	8.4	3.23	3.17	1.37	4.0	8.0	Q3

**TAPE AND REEL BOX DIMENSIONS**

\*All dimensions are nominal

Device	Package Type	Package Drawing	Pins	SPQ	Length (mm)	Width (mm)	Height (mm)
TLV70212DBVR	SOT-23	DBV	5	3000	210.0	185.0	35.0
TLV70212DBVRG4	SOT-23	DBV	5	3000	210.0	185.0	35.0
TLV70212DBVT	SOT-23	DBV	5	250	210.0	185.0	35.0
TLV70213DBVR	SOT-23	DBV	5	3000	210.0	185.0	35.0
TLV70213DBVT	SOT-23	DBV	5	250	210.0	185.0	35.0
TLV70215DBVR	SOT-23	DBV	5	3000	210.0	185.0	35.0
TLV70215DBVT	SOT-23	DBV	5	250	180.0	180.0	18.0
TLV70215DBVT	SOT-23	DBV	5	250	210.0	185.0	35.0
TLV70215PDBVR	SOT-23	DBV	5	3000	208.0	191.0	35.0
TLV70215PDBVT	SOT-23	DBV	5	250	210.0	185.0	35.0
TLV70215PDBVT	SOT-23	DBV	5	250	180.0	180.0	18.0
TLV70218DBVR	SOT-23	DBV	5	3000	210.0	185.0	35.0
TLV70218DBVR	SOT-23	DBV	5	3000	210.0	185.0	35.0
TLV70218DBVRG4	SOT-23	DBV	5	3000	210.0	185.0	35.0
TLV70218DBVRG4	SOT-23	DBV	5	3000	210.0	185.0	35.0
TLV70218DBVT	SOT-23	DBV	5	250	210.0	185.0	35.0
TLV70218DBVT	SOT-23	DBV	5	250	183.0	183.0	20.0
TLV70220PDBVR	SOT-23	DBV	5	3000	180.0	180.0	18.0

Device	Package Type	Package Drawing	Pins	SPQ	Length (mm)	Width (mm)	Height (mm)
TLV70220PDBVRG4	SOT-23	DBV	5	3000	180.0	180.0	18.0
TLV70220PDBVT	SOT-23	DBV	5	250	180.0	180.0	18.0
TLV70225DBVR	SOT-23	DBV	5	3000	208.0	191.0	35.0
TLV70225DBVRG4	SOT-23	DBV	5	3000	210.0	185.0	35.0
TLV70225DBVT	SOT-23	DBV	5	250	210.0	185.0	35.0
TLV70225DSE	WSON	DSE	6	3000	200.0	183.0	25.0
TLV70225DSET	WSON	DSE	6	250	200.0	183.0	25.0
TLV70228DBVR	SOT-23	DBV	5	3000	210.0	185.0	35.0
TLV70228DBVRG4	SOT-23	DBV	5	3000	210.0	185.0	35.0
TLV70228DBVT	SOT-23	DBV	5	250	210.0	185.0	35.0
TLV70228DSE	WSON	DSE	6	3000	200.0	183.0	25.0
TLV70228DSET	WSON	DSE	6	250	200.0	183.0	25.0
TLV70228PDBVR	SOT-23	DBV	5	3000	183.0	183.0	20.0
TLV70228PDBVRG4	SOT-23	DBV	5	3000	183.0	183.0	20.0
TLV70228PDBVT	SOT-23	DBV	5	250	183.0	183.0	20.0
TLV70228PDBVT	SOT-23	DBV	5	250	210.0	185.0	35.0
TLV70229DBVR	SOT-23	DBV	5	3000	210.0	185.0	35.0
TLV70229DBVRG4	SOT-23	DBV	5	3000	210.0	185.0	35.0
TLV70229DBVT	SOT-23	DBV	5	250	210.0	185.0	35.0
TLV70229DSE	WSON	DSE	6	3000	183.0	183.0	20.0
TLV70229DSET	WSON	DSE	6	250	183.0	183.0	20.0
TLV70230DBVR	SOT-23	DBV	5	3000	208.0	191.0	35.0
TLV70230DBVT	SOT-23	DBV	5	250	210.0	185.0	35.0
TLV70231DBVR	SOT-23	DBV	5	3000	210.0	185.0	35.0
TLV70231DBVT	SOT-23	DBV	5	250	210.0	185.0	35.0
TLV70233DBVR	SOT-23	DBV	5	3000	208.0	191.0	35.0
TLV70233DBVRG4	SOT-23	DBV	5	3000	210.0	185.0	35.0
TLV70233DBVRG4	SOT-23	DBV	5	3000	210.0	185.0	35.0
TLV70233DBVT	SOT-23	DBV	5	250	210.0	185.0	35.0
TLV70233DSE	WSON	DSE	6	3000	200.0	183.0	25.0
TLV70233DSET	WSON	DSE	6	250	200.0	183.0	25.0
TLV70233PDBVR	SOT-23	DBV	5	3000	208.0	191.0	35.0
TLV70233PDBVRG4	SOT-23	DBV	5	3000	180.0	180.0	18.0
TLV70233PDBVT	SOT-23	DBV	5	250	180.0	180.0	18.0
TLV70233PDBVT	SOT-23	DBV	5	250	210.0	185.0	35.0
TLV70235DBVR	SOT-23	DBV	5	3000	208.0	191.0	35.0
TLV70235DBVT	SOT-23	DBV	5	250	210.0	185.0	35.0
TLV70236DSE	WSON	DSE	6	3000	200.0	183.0	25.0
TLV70236DSET	WSON	DSE	6	250	203.0	203.0	35.0
TLV70237DBVR	SOT-23	DBV	5	3000	210.0	185.0	35.0
TLV70237DBVT	SOT-23	DBV	5	250	210.0	185.0	35.0
TLV70237DSE	WSON	DSE	6	3000	183.0	183.0	20.0
TLV70237DSET	WSON	DSE	6	250	183.0	183.0	20.0

Device	Package Type	Package Drawing	Pins	SPQ	Length (mm)	Width (mm)	Height (mm)
TLV70242PDSE	WSON	DSE	6	3000	183.0	183.0	20.0
TLV70242PDSET	WSON	DSE	6	250	183.0	183.0	20.0
TLV70243DSE	WSON	DSE	6	3000	183.0	183.0	20.0
TLV70243DSET	WSON	DSE	6	250	183.0	183.0	20.0
TLV70245DBVR	SOT-23	DBV	5	3000	208.0	191.0	35.0
TLV70245DBVT	SOT-23	DBV	5	250	210.0	185.0	35.0
TLV70245DBVT	SOT-23	DBV	5	250	183.0	183.0	20.0
TLV70245DBVT	SOT-23	DBV	5	250	180.0	180.0	18.0
TLV70245DBVTG4	SOT-23	DBV	5	250	180.0	180.0	18.0
TLV702475DBVR	SOT-23	DBV	5	3000	208.0	191.0	35.0
TLV702475DBVT	SOT-23	DBV	5	250	210.0	185.0	35.0
TLV702475DBVT	SOT-23	DBV	5	250	183.0	183.0	20.0
TLV702475DBVT	SOT-23	DBV	5	250	180.0	180.0	18.0



# EXAMPLE BOARD LAYOUT

DBV0005A

SOT-23 - 1.45 mm max height

SMALL OUTLINE TRANSISTOR



LAND PATTERN EXAMPLE  
EXPOSED METAL SHOWN  
SCALE:15X



SOLDER MASK DETAILS

4214839/K 08/2024

NOTES: (continued)

- 6. Publication IPC-7351 may have alternate designs.
- 7. Solder mask tolerances between and around signal pads can vary based on board fabrication site.

# EXAMPLE STENCIL DESIGN

DBV0005A

SOT-23 - 1.45 mm max height

SMALL OUTLINE TRANSISTOR



SOLDER PASTE EXAMPLE  
BASED ON 0.125 mm THICK STENCIL  
SCALE:15X

4214839/K 08/2024

NOTES: (continued)

8. Laser cutting apertures with trapezoidal walls and rounded corners may offer better paste release. IPC-7525 may have alternate design recommendations.
9. Board assembly site may have different recommendations for stencil design.

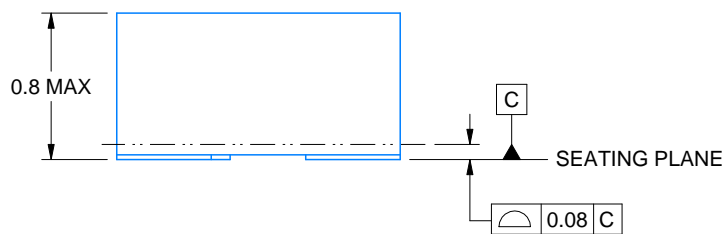
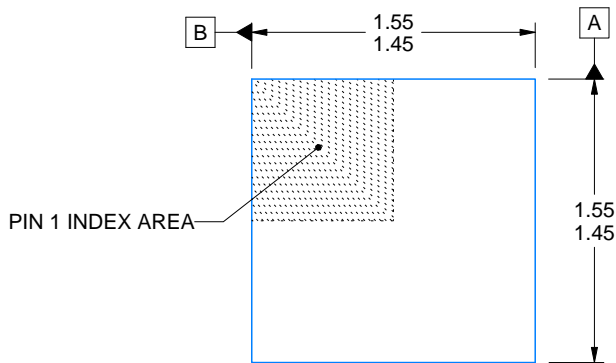

4220552/B 01/2024

NOTES:

1. All linear dimensions are in millimeters. Any dimensions in parenthesis are for reference only. Dimensioning and tolerancing per ASME Y14.5M.
2. This drawing is subject to change without notice.

# EXAMPLE BOARD LAYOUT

DSE0006A

WSON - 0.8 mm max height

PLASTIC SMALL OUTLINE - NO LEAD



LAND PATTERN EXAMPLE  
SCALE:40X

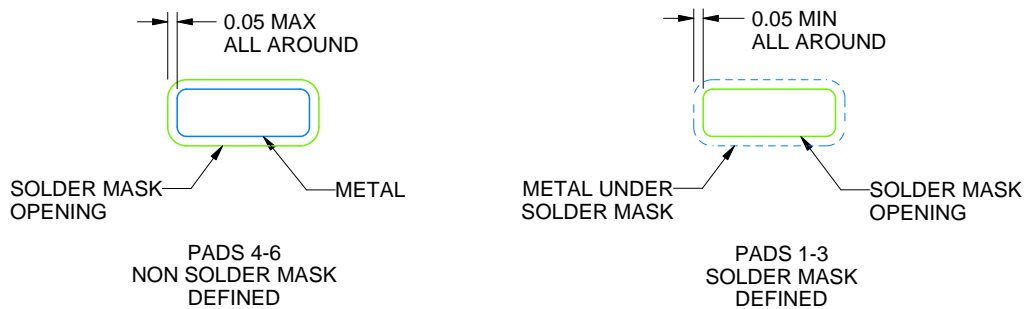

SOLDER MASK DETAILS

4220552/B 01/2024

NOTES: (continued)

3. For more information, see Texas Instruments literature number SLUA271 ([www.ti.com/lit/slua271](http://www.ti.com/lit/slua271)).

# EXAMPLE STENCIL DESIGN

DSE0006A

WSON - 0.8 mm max height

PLASTIC SMALL OUTLINE - NO LEAD



SOLDER PASTE EXAMPLE  
BASED ON 0.125 mm THICK STENCIL  
SCALE:40X

NOTES: (continued)

4. Laser cutting apertures with trapezoidal walls and rounded corners may offer better paste release. IPC-7525 may have alternate design recommendations.

## IMPORTANT NOTICE AND DISCLAIMER

TI PROVIDES TECHNICAL AND RELIABILITY DATA (INCLUDING DATASHEETS), DESIGN RESOURCES (INCLUDING REFERENCE DESIGNS), APPLICATION OR OTHER DESIGN ADVICE, WEB TOOLS, SAFETY INFORMATION, AND OTHER RESOURCES "AS IS" AND WITH ALL FAULTS, AND DISCLAIMS ALL WARRANTIES, EXPRESS AND IMPLIED, INCLUDING WITHOUT LIMITATION ANY IMPLIED WARRANTIES OF MERCHANTABILITY, FITNESS FOR A PARTICULAR PURPOSE OR NON-INFRINGEMENT OF THIRD PARTY INTELLECTUAL PROPERTY RIGHTS.

These resources are intended for skilled developers designing with TI products. You are solely responsible for (1) selecting the appropriate TI products for your application, (2) designing, validating and testing your application, and (3) ensuring your application meets applicable standards, and any other safety, security, regulatory or other requirements.

These resources are subject to change without notice. TI grants you permission to use these resources only for development of an application that uses the TI products described in the resource. Other reproduction and display of these resources is prohibited. No license is granted to any other TI intellectual property right or to any third party intellectual property right. TI disclaims responsibility for, and you fully indemnify TI and its representatives against any claims, damages, costs, losses, and liabilities arising out of your use of these resources.

TI's products are provided subject to [TI's Terms of Sale](#), [TI's General Quality Guidelines](#), or other applicable terms available either on [ti.com](http://ti.com) or provided in conjunction with such TI products. TI's provision of these resources does not expand or otherwise alter TI's applicable warranties or warranty disclaimers for TI products. Unless TI explicitly designates a product as custom or customer-specified, TI products are standard, catalog, general purpose devices.

TI objects to and rejects any additional or different terms you may propose.

Copyright © 2026, Texas Instruments Incorporated

Last updated 10/2025