

# TLV930x 40-V, 1-MHz, RRO Operational Amplifiers for Cost-Sensitive Systems

## 1 Features

- Low offset voltage:  $\pm 0.5$  mV
- Low offset voltage drift:  $\pm 2$   $\mu\text{V}/^\circ\text{C}$
- Low noise: 33 nV/ $\sqrt{\text{Hz}}$  at 1 kHz
- High common-mode rejection: 110 dB
- Low bias current:  $\pm 10$  pA
- Rail-to-rail output
- Wide bandwidth: 1-MHz GBW
- High slew rate: 3 V/ $\mu\text{s}$
- Low quiescent current: 150  $\mu\text{A}$  per amplifier
- Wide supply:  $\pm 2.25$  V to  $\pm 20$  V, 4.5 V to 40 V
- Robust EMI performance: 72 dB at 1 GHz
- MUX-friendly/comparator inputs:
  - Differential and common-mode input voltage range to supply rail
- Industry-standard packages:
  - Single in SOT-23-5 and SC70
  - Dual in SOIC-8, TSSOP-8, and VSSOP-8
  - Quad in SOIC-14 and TSSOP-14

## 2 Applications

- [Merchant network and server PSU](#)
- [Industrial AC-DC](#)
- [Merchant DC/DC](#)
- [Motor drives: AC and servo drive power supplies](#)
- [Building automation](#)

## 3 Description

The TLV930x family (TLV9301, TLV9302, and TLV9304) is a family of 40-V, cost-optimized operational amplifiers. These devices offer strong general-purpose DC and AC specifications, including rail-to-rail output, low offset ( $\pm 0.5$  mV, typ), low offset drift ( $\pm 2$   $\mu\text{V}/^\circ\text{C}$ , typ), and 1-MHz bandwidth.

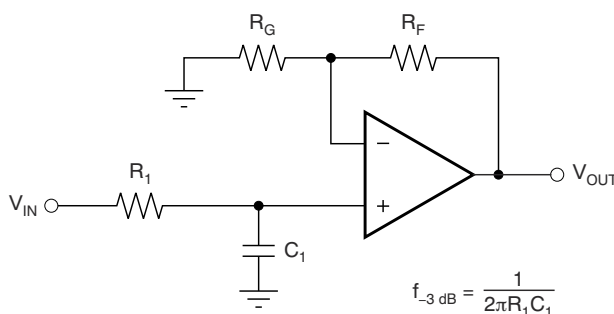
Convenient features such as wide differential input-voltage range, high output current ( $\pm 60$  mA), and high slew rate (3 V/ $\mu\text{s}$ ) make the TLV930x a robust operational amplifier for high-voltage, cost-sensitive applications.

The TLV930x family of op amps is available in standard packages and is specified from  $-40^\circ\text{C}$  to  $125^\circ\text{C}$ .

### Device Information

PART NUMBER <sup>(1)</sup>	PACKAGE	BODY SIZE (NOM)
TLV9301	SOT-23 (5)	2.90 mm $\times$ 1.60 mm
	SC70 (5)	2.00 mm $\times$ 1.25 mm
TLV9302	SOIC (8)	4.90 mm $\times$ 3.91 mm
	SOT-23-8	2.90 mm $\times$ 1.60 mm
	TSSOP (8)	4.40 mm $\times$ 3.00 mm
	VSSOP (8)	2.30 mm $\times$ 2.00 mm
TLV9304	SOIC (14)	8.65 mm $\times$ 3.91 mm
	TSSOP (14)	5.00 mm $\times$ 4.40 mm

(1) For all available packages, see the orderable addendum at the end of the data sheet.



$$f_{-3\text{dB}} = \frac{1}{2\pi R_1 C_1}$$

$$\frac{V_{\text{OUT}}}{V_{\text{IN}}} = \left(1 + \frac{R_F}{R_G}\right) \left(\frac{1}{1 + sR_1 C_1}\right)$$

### TLV930x in a Single-Pole, Low-Pass Filter



## Table of Contents

<b>1 Features</b> .....	1	7.4 Device Functional Modes.....	24
<b>2 Applications</b> .....	1	<b>8 Application and Implementation</b> .....	25
<b>3 Description</b> .....	1	8.1 Application Information.....	25
<b>4 Revision History</b> .....	2	8.2 Typical Applications.....	25
<b>5 Pin Configuration and Functions</b> .....	3	<b>9 Power Supply Recommendations</b> .....	27
<b>6 Specifications</b> .....	5	<b>10 Layout</b> .....	27
6.1 Absolute Maximum Ratings .....	5	10.1 Layout Guidelines.....	27
6.2 ESD Ratings .....	5	10.2 Layout Example.....	27
6.3 Recommended Operating Conditions .....	5	<b>11 Device and Documentation Support</b> .....	30
6.4 Thermal Information for Single Channel .....	5	11.1 Device Support.....	30
6.5 Thermal Information for Dual Channel .....	6	11.2 Documentation Support.....	30
6.6 Thermal Information for Quad Channel .....	6	11.3 Receiving Notification of Documentation Updates..	30
6.7 Electrical Characteristics .....	7	11.4 Support Resources.....	30
6.8 Typical Characteristics.....	9	11.5 Trademarks.....	30
<b>7 Detailed Description</b> .....	16	11.6 Electrostatic Discharge Caution.....	31
7.1 Overview.....	16	11.7 Glossary.....	31
7.2 Functional Block Diagram.....	16	<b>12 Mechanical, Packaging, and Orderable Information</b> .....	32
7.3 Feature Description.....	17		

## 4 Revision History

NOTE: Page numbers for previous revisions may differ from page numbers in the current version.

### Changes from Revision C (February 2021) to Revision D (August 2021) Page

- Removed preview note and added thermal data for VSSOP-8 (DGK) package in *Thermal Information for Dual Channel*..... 6

### Changes from Revision B (March 2020) to Revision C (February 2021) Page

- Updated the numbering format for tables, figures, and cross-references throughout the document..... 1
- Removed preview notation from TLV9302 SOT-23 (8) package from *Device Information* table..... 1
- Removed preview notation from TLV9302 VSSOP (8) package from *Device Information* table..... 1
- Removed Table of Graphs table from the *Specifications* section..... 9
- Removed *Related Links* section from the *Device and Documentation Support* section..... 30

### Changes from Revision A (April 2019) to Revision B (March 2020) Page

- Changed the TLV9301 and TLV9304 device statuses from *Advance Information* to *Production Data* ..... 1
- Removed preview notation from TLV9301 SOT-23 (5) package from *Device Information* table..... 1
- Removed preview notation from TLV9301 SC70 (5) package from *Device Information* table..... 1
- Removed preview notation from TLV9304 SOIC (14) package from *Device Information* table..... 1
- Removed preview notation from TLV9304 TSSOP (14) package from *Device Information* table..... 1
- Removed preview notation from TLV9301 DBV package (SOT-23) in the *Pin Configuration and Functions* section..... 3
- Removed preview notation from TLV9301 DCK package (SC70) in the *Pin Configuration and Functions* section..... 3
- Removed preview notation from TLV9304 D (SOIC) and TSSOP (PW) packages in the *Pin Configuration and Functions* section..... 3

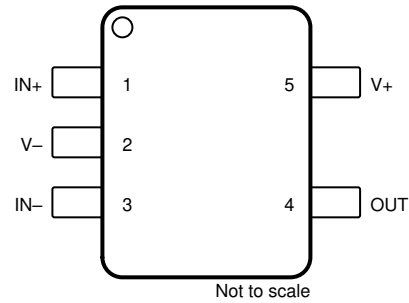
### Changes from Revision \* (February 2019) to Revision A (April 2019) Page

- Changed the TLV9302 device status from *Advance Information* to *Production Data* ..... 1

## 5 Pin Configuration and Functions



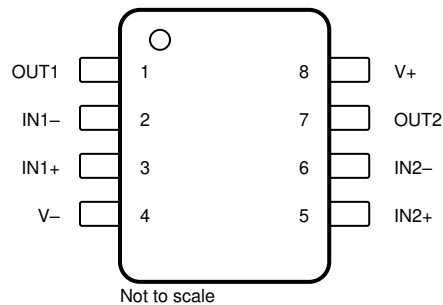
**Figure 5-1. TLV9301 DBV Package  
5-Pin SOT-23  
Top View**



**Figure 5-2. TLV9301 DCK Package  
5-Pin SC70  
Top View**

**Table 5-1. Pin Functions: TLV9301**

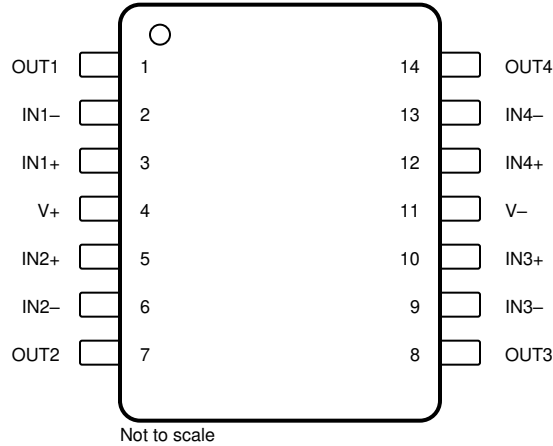
NAME	PIN		I/O	DESCRIPTION
	DBV	DCK		
+IN	3	1	I	Noninverting input
-IN	4	3	I	Inverting input
OUT	1	4	O	Output
V+	5	5	—	Positive (highest) power supply
V-	2	2	—	Negative (lowest) power supply



**Figure 5-3. TLV9302 D, DDF, DGK, and PW Package  
8-Pin SOIC, TSOT, TSSOP, and VSSOP  
Top View**

**Table 5-2. Pin Functions: TLV9302**

NAME	PIN		I/O	DESCRIPTION
	NO.			
+IN A	3		I	Noninverting input, channel A
+IN B	5		I	Noninverting input, channel B
-IN A	2		I	Inverting input, channel A
-IN B	6		I	Inverting input, channel B
OUT A	1		O	Output, channel A
OUT B	7		O	Output, channel B
V+	8		—	Positive (highest) power supply
V-	4		—	Negative (lowest) power supply



**Figure 5-4. TLV9304 D and PW Package  
14-Pin SOIC and TSSOP  
Top View**

**Table 5-3. Pin Functions: TLV9304**

PIN		I/O	DESCRIPTION
NAME	NO.		
+IN A	3	I	Noninverting input, channel A
+IN B	5	I	Noninverting input, channel B
+IN C	10	I	Noninverting input, channel C
+IN D	12	I	Noninverting input, channel D
-IN A	2	I	Inverting input, channel A
-IN B	6	I	Inverting input, channel B
-IN C	9	I	Inverting input, channel C
-IN D	13	I	Inverting input, channel D
OUT A	1	O	Output, channel A
OUT B	7	O	Output, channel B
OUT C	8	O	Output, channel C
OUT D	14	O	Output, channel D
V+	4	—	Positive (highest) power supply
V-	11	—	Negative (lowest) power supply

## 6 Specifications

### 6.1 Absolute Maximum Ratings

over operating ambient temperature range (unless otherwise noted)<sup>(1)</sup>

		MIN	MAX	UNIT
Supply voltage, $V_S = (V+) - (V-)$		0	42	V
Signal input pins	Common-mode voltage <sup>(3)</sup>	$(V-) - 0.5$	$(V+) + 0.5$	V
	Differential voltage <sup>(3) (4)</sup>		$V_S + 0.2$	V
	Current <sup>(3)</sup>	-10	10	mA
Output short-circuit <sup>(2)</sup>		Continuous		
Operating ambient temperature, $T_A$		-55	150	°C
Junction temperature, $T_J$			150	°C
Storage temperature, $T_{stg}$		-65	150	°C

- (1) Stresses beyond those listed under *Absolute Maximum Ratings* may cause permanent damage to the device. These are stress ratings only, which do not imply functional operation of the device at these or any other conditions beyond those indicated under *Recommended Operating Conditions*. Exposure to absolute-maximum-rated conditions for extended periods may affect device reliability.
- (2) Short-circuit to ground, one amplifier per package.
- (3) Input pins are diode-clamped to the power-supply rails. Input signals that may swing more than 0.5 V beyond the supply rails must be current limited to 10 mA or less.
- (4) Large differential voltages applied between IN+ and IN- for extended periods of time may cause a long-term shift to the input offset voltage. This effect increases as temperature rises above 25°C.

### 6.2 ESD Ratings

			VALUE	UNIT
$V_{(ESD)}$	Electrostatic discharge	Human-body model (HBM), per ANSI/ESDA/JEDEC JS-001 <sup>(1)</sup>	±2000	V
		Charged-device model (CDM), per JEDEC specification JESD22-C101 <sup>(2)</sup>	±1000	

- (1) JEDEC document JEP155 states that 500-V HBM allows safe manufacturing with a standard ESD control process.
- (2) JEDEC document JEP157 states that 250-V CDM allows safe manufacturing with a standard ESD control process.

### 6.3 Recommended Operating Conditions

over operating ambient temperature range (unless otherwise noted)

		MIN	MAX	UNIT
$V_S$	Supply voltage, $(V+) - (V-)$	4.5	40	V
$V_I$	Input voltage range	$(V-) - 0.1$	$(V+) - 2$	V
$T_A$	Specified temperature	-40	125	°C

### 6.4 Thermal Information for Single Channel

THERMAL METRIC <sup>(1)</sup>		TLV9301		UNIT
		DBV (SOT-23)	DCK (SC70)	
		5 PINS	5 PINS	
$R_{\theta JA}$	Junction-to-ambient thermal resistance	192.5	203.9	°C/W
$R_{\theta JC(top)}$	Junction-to-case (top) thermal resistance	113.3	116.2	°C/W
$R_{\theta JB}$	Junction-to-board thermal resistance	60.2	51.7	°C/W
$\psi_{JT}$	Junction-to-top characterization parameter	37.6	24.6	°C/W
$\psi_{JB}$	Junction-to-board characterization parameter	60.1	51.9	°C/W
$R_{\theta JC(bot)}$	Junction-to-case (bottom) thermal resistance	N/A	N/A	°C/W

- (1) For more information about traditional and new thermal metrics, see the *Semiconductor and IC Package Thermal Metrics* application report, [SPRA953](#).

## 6.5 Thermal Information for Dual Channel

THERMAL METRIC <sup>(1)</sup>		TLV9302				UNIT
		D (SOIC)	DDF (SOT-23-8)	DGK (VSSOP)	PW (TSSOP)	
		8 PINS	8 PINS	8 PINS	8 PINS	
R <sub>θJA</sub>	Junction-to-ambient thermal resistance	138.7	150.4	189.3	188.4	°C/W
R <sub>θJC(top)</sub>	Junction-to-case (top) thermal resistance	78.7	85.6	75.8	77.1	°C/W
R <sub>θJB</sub>	Junction-to-board thermal resistance	82.2	70.0	111.0	119.1	°C/W
ψ <sub>JT</sub>	Junction-to-top characterization parameter	27.8	8.1	15.4	14.2	°C/W
ψ <sub>JB</sub>	Junction-to-board characterization parameter	81.4	69.6	109.3	117.4	°C/W
R <sub>θJC(bot)</sub>	Junction-to-case (bottom) thermal resistance	N/A	N/A	N/A	N/A	°C/W

- (1) For more information about traditional and new thermal metrics, see the *Semiconductor and IC Package Thermal Metrics* application report, [SPRA953](#).

## 6.6 Thermal Information for Quad Channel

THERMAL METRIC <sup>(1)</sup>		TLV9304		UNIT
		D (SOIC)	PW (TSSOP)	
		14 PINS	14 PINS	
R <sub>θJA</sub>	Junction-to-ambient thermal resistance	105.5	134.5	°C/W
R <sub>θJC(top)</sub>	Junction-to-case (top) thermal resistance	61.4	55.4	°C/W
R <sub>θJB</sub>	Junction-to-board thermal resistance	61.0	79.2	°C/W
ψ <sub>JT</sub>	Junction-to-top characterization parameter	21.6	9.3	°C/W
ψ <sub>JB</sub>	Junction-to-board characterization parameter	60.3	78.4	°C/W
R <sub>θJC(bot)</sub>	Junction-to-case (bottom) thermal resistance	N/A	N/A	°C/W

- (1) For more information about traditional and new thermal metrics, see the *Semiconductor and IC Package Thermal Metrics* application report, [SPRA953](#).

## 6.7 Electrical Characteristics

For  $V_S = (V+) - (V-) = 4.5 \text{ V to } 40 \text{ V}$  ( $\pm 2.25 \text{ V to } \pm 20 \text{ V}$ ) at  $T_A = 25^\circ\text{C}$ ,  $R_L = 10 \text{ k}\Omega$  connected to  $V_S / 2$ ,  $V_{CM} = V_S / 2$ , and  $V_{OUT} = V_S / 2$ , unless otherwise noted.

PARAMETER		TEST CONDITIONS		MIN	TYP	MAX	UNIT
<b>OFFSET VOLTAGE</b>							
$V_{OS}$	Input offset voltage	$V_{CM} = V-$	$T_A = -40^\circ\text{C to } 125^\circ\text{C}$	$\pm 0.5$		$\pm 2.5$	mV
						$\pm 2.75$	
$dV_{OS}/dT$	Input offset voltage drift		$T_A = -40^\circ\text{C to } 125^\circ\text{C}$		$\pm 2$		$\mu\text{V}/^\circ\text{C}$
PSRR	Input offset voltage versus power supply	$V_{CM} = V-$	$T_A = -40^\circ\text{C to } 125^\circ\text{C}$		$\pm 2$	$\pm 5$	$\mu\text{V}/\text{V}$
	Channel separation			$f = 0 \text{ Hz}$		5	
<b>INPUT BIAS CURRENT</b>							
$I_B$	Input bias current				$\pm 10$		pA
$I_{OS}$	Input offset current				$\pm 10$		pA
<b>NOISE</b>							
$E_N$	Input voltage noise	$f = 0.1 \text{ Hz to } 10 \text{ Hz}$			6		$\mu\text{V}_{PP}$
					1		$\mu\text{V}_{RMS}$
$e_N$	Input voltage noise density	$f = 1 \text{ kHz}$ $f = 10 \text{ kHz}$			33		$\text{nV}/\sqrt{\text{Hz}}$
					30		
$i_N$	Input current noise	$f = 1 \text{ kHz}$			5		$\text{fA}/\sqrt{\text{Hz}}$
<b>INPUT VOLTAGE RANGE</b>							
$V_{CM}$	Common-mode voltage range			$(V-) - 0.2$		$(V+) - 2$	V
CMRR	Common-mode rejection ratio	$V_S = 40 \text{ V}, (V-) - 0.1 \text{ V} < V_{CM} < (V+) - 2 \text{ V}$	$T_A = -40^\circ\text{C to } 125^\circ\text{C}$	95	110		dB
		$V_S = 4.5 \text{ V}, (V-) - 0.1 \text{ V} < V_{CM} < (V+) - 2 \text{ V}$			90		
		$(V+) - 2 \text{ V} < V_{CM} < (V+) + 0.1 \text{ V}$		See <a href="#">Common-Mode Voltage Range</a>			
<b>INPUT CAPACITANCE</b>							
$Z_{ID}$	Differential				$110 \parallel 4$		$\text{M}\Omega \parallel \text{pF}$
$Z_{ICM}$	Common-mode				$6 \parallel 1.5$		$\text{T}\Omega \parallel \text{pF}$
<b>OPEN-LOOP GAIN</b>							
$A_{OL}$	Open-loop voltage gain	$V_S = 40 \text{ V}, V_{CM} = V- (V-) + 0.1 \text{ V} < V_O < (V+) - 0.1 \text{ V}$	$T_A = -40^\circ\text{C to } 125^\circ\text{C}$	120	130		dB
				116	127		
<b>FREQUENCY RESPONSE</b>							
GBW	Gain-bandwidth product				1		MHz
SR	Slew rate	$V_S = 40 \text{ V}, G = +1, C_L = 20 \text{ pF}$			3		$\text{V}/\mu\text{s}$
$t_s$	Settling time			$T_0 0.1\%, V_S = 40 \text{ V}, V_{STEP} = 10 \text{ V}, G = +1, C_L = 20 \text{ pF}$	5		$\mu\text{s}$
				$T_0 0.1\%, V_S = 40 \text{ V}, V_{STEP} = 2 \text{ V}, G = +1, C_L = 20 \text{ pF}$	2.5		
				$T_0 0.01\%, V_S = 40 \text{ V}, V_{STEP} = 10 \text{ V}, G = +1, C_L = 20 \text{ pF}$	6		
				$T_0 0.01\%, V_S = 40 \text{ V}, V_{STEP} = 2 \text{ V}, G = +1, C_L = 20 \text{ pF}$	3.5		
	Phase margin	$G = +1, R_L = 10 \text{ k}\Omega, C_L = 20 \text{ pF}$			60		$^\circ$
	Overload recovery time	$V_{IN} \times \text{gain} > V_S$			1		$\mu\text{s}$
THD+N	Total harmonic distortion + noise	$V_S = 40 \text{ V}, V_O = 1 \text{ V}_{RMS}, G = -1, f = 1 \text{ kHz}$			0.003%		

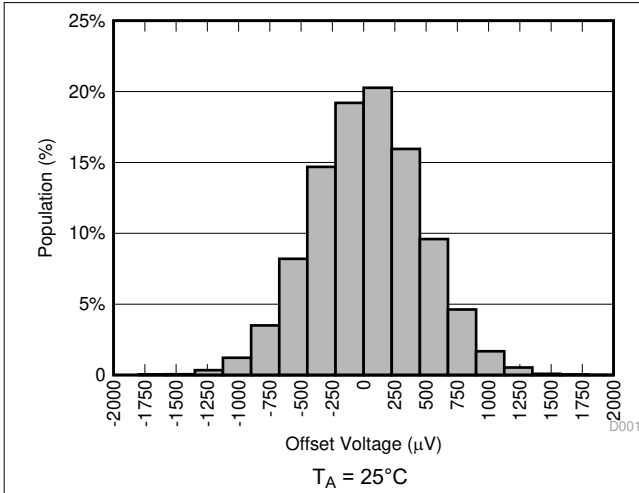
## 6.7 Electrical Characteristics (continued)

For  $V_S = (V+) - (V-) = 4.5\text{ V to }40\text{ V}$  ( $\pm 2.25\text{ V to } \pm 20\text{ V}$ ) at  $T_A = 25^\circ\text{C}$ ,  $R_L = 10\text{ k}\Omega$  connected to  $V_S / 2$ ,  $V_{CM} = V_S / 2$ , and  $V_{OUT} = V_S / 2$ , unless otherwise noted.

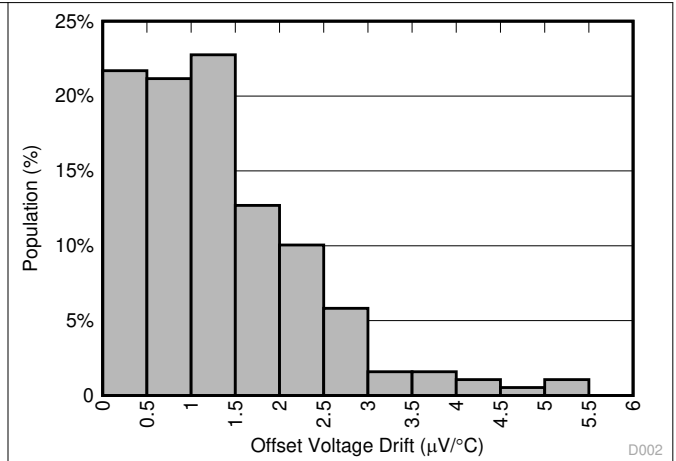
PARAMETER	TEST CONDITIONS		MIN	TYP	MAX	UNIT
<b>OUTPUT</b>						
Voltage output swing from rail	Positive and negative rail headroom	$V_S = 40\text{ V}, R_L = \text{no load}$		3		mV
		$V_S = 40\text{ V}, R_L = 10\text{ k}\Omega$		50	75	
		$V_S = 40\text{ V}, R_L = 2\text{ k}\Omega$		250	350	
		$V_S = 4.5\text{ V}, R_L = \text{no load}$		1		
		$V_S = 4.5\text{ V}, R_L = 10\text{ k}\Omega$		20	30	
		$V_S = 4.5\text{ V}, R_L = 2\text{ k}\Omega$		40	75	
$I_{SC}$	Short-circuit current			$\pm 60$		mA
$C_{LOAD}$	Capacitive load drive		See <a href="#">Typical Characteristics</a>			
$Z_O$	Open-loop output impedance	$f = 1\text{ MHz}, I_O = 0\text{ A}$		600		$\Omega$
<b>POWER SUPPLY</b>						
$I_Q$	Quiescent current per amplifier	$I_O = 0\text{ A}$		150	175	$\mu\text{A}$
			$T_A = -40^\circ\text{C to }125^\circ\text{C}$		175	

## 6.8 Typical Characteristics

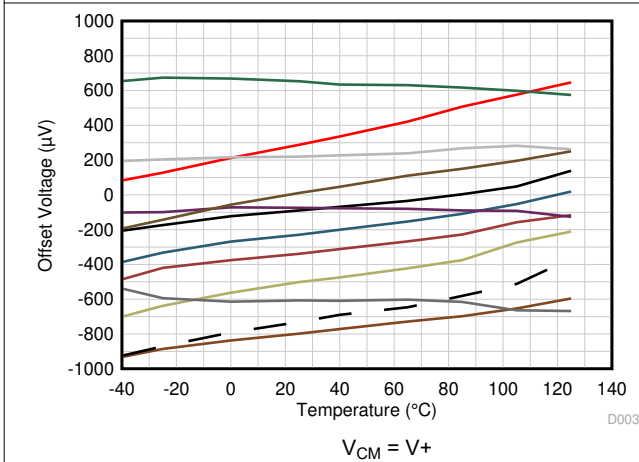
at  $T_A = 25^\circ\text{C}$ ,  $V_S = \pm 20\text{ V}$ ,  $V_{CM} = V_S / 2$ ,  $R_{LOAD} = 10\text{ k}\Omega$  connected to  $V_S / 2$ , and  $C_L = 100\text{ pF}$  (unless otherwise noted)



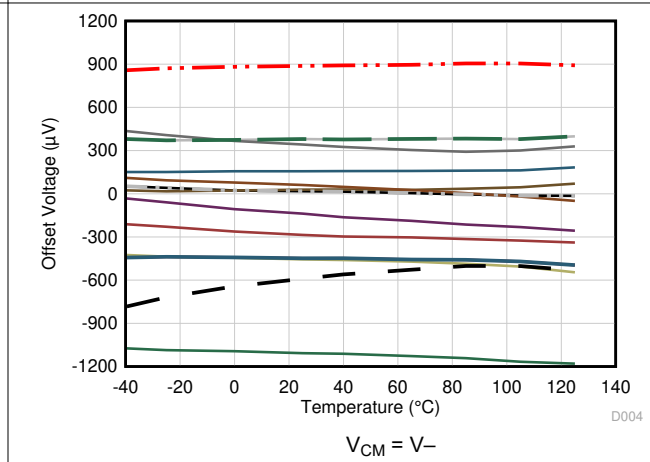
**Figure 6-1. Offset Voltage Production Distribution**



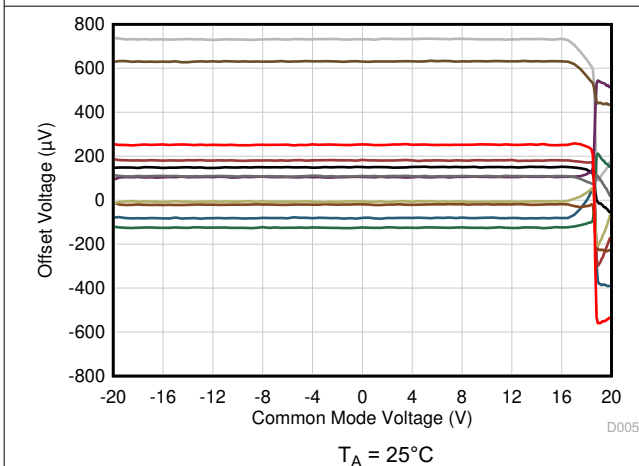
**Figure 6-2. Offset Voltage Drift Distribution**



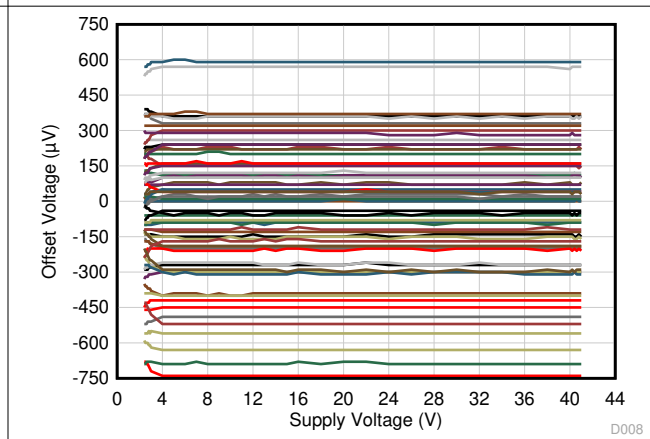
**Figure 6-3. Offset Voltage vs Temperature**



**Figure 6-4. Offset Voltage vs Temperature**



**Figure 6-5. Offset Voltage vs Common-Mode Voltage**



**Figure 6-6. Offset Voltage vs Power Supply**

### 6.8 Typical Characteristics (continued)

at  $T_A = 25^\circ\text{C}$ ,  $V_S = \pm 20\text{ V}$ ,  $V_{CM} = V_S / 2$ ,  $R_{LOAD} = 10\text{ k}\Omega$  connected to  $V_S / 2$ , and  $C_L = 100\text{ pF}$  (unless otherwise noted)

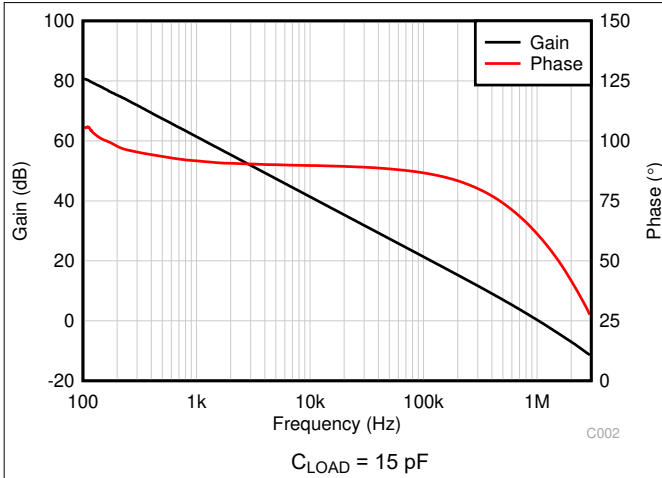


Figure 6-7. Open-Loop Gain and Phase vs Frequency

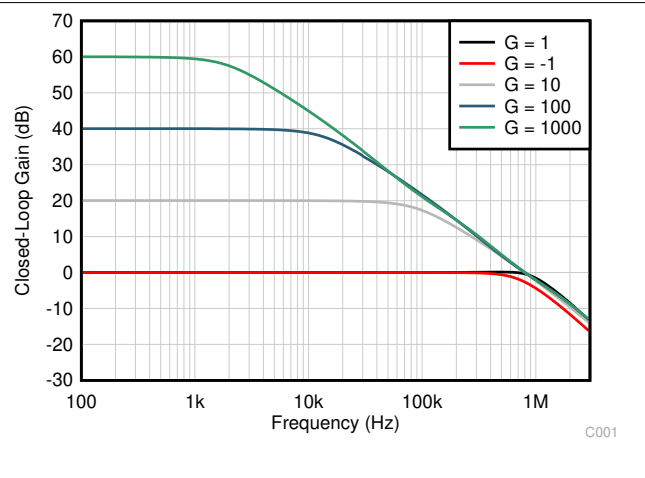


Figure 6-8. Closed-Loop Gain and Phase vs Frequency

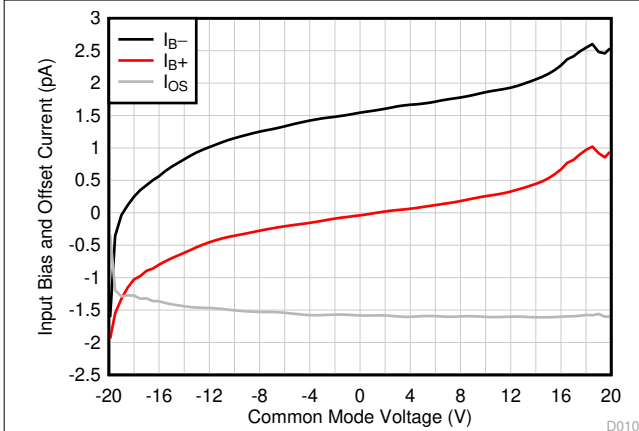


Figure 6-9. Input Bias Current vs Common-Mode Voltage

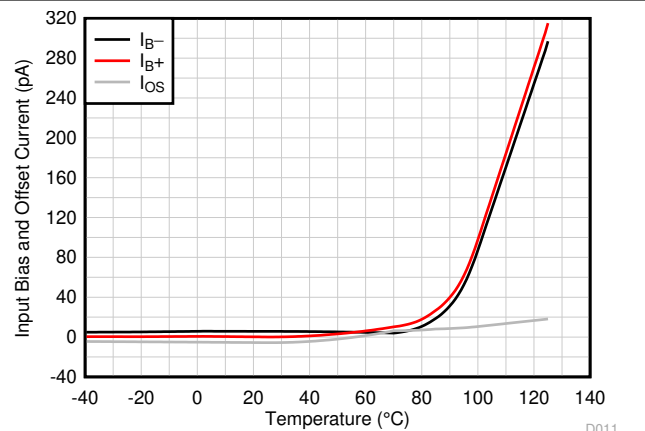


Figure 6-10. Input Bias Current vs Temperature

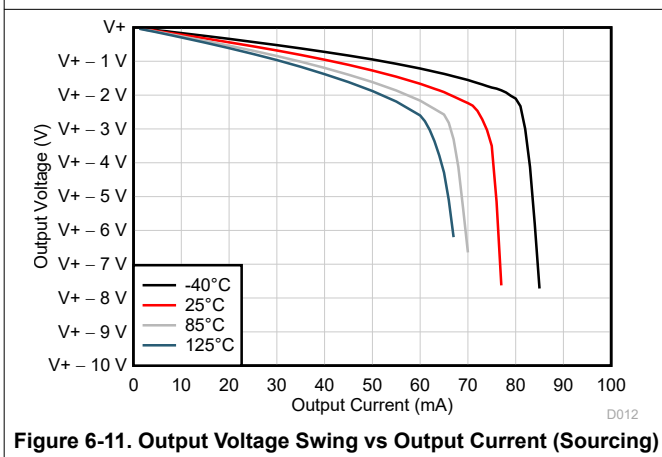


Figure 6-11. Output Voltage Swing vs Output Current (Sourcing)

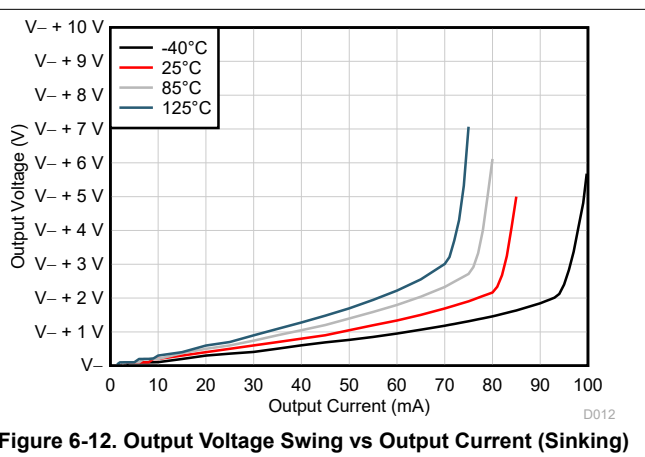


Figure 6-12. Output Voltage Swing vs Output Current (Sinking)

### 6.8 Typical Characteristics (continued)

at  $T_A = 25^\circ\text{C}$ ,  $V_S = \pm 20\text{ V}$ ,  $V_{CM} = V_S / 2$ ,  $R_{LOAD} = 10\text{ k}\Omega$  connected to  $V_S / 2$ , and  $C_L = 100\text{ pF}$  (unless otherwise noted)

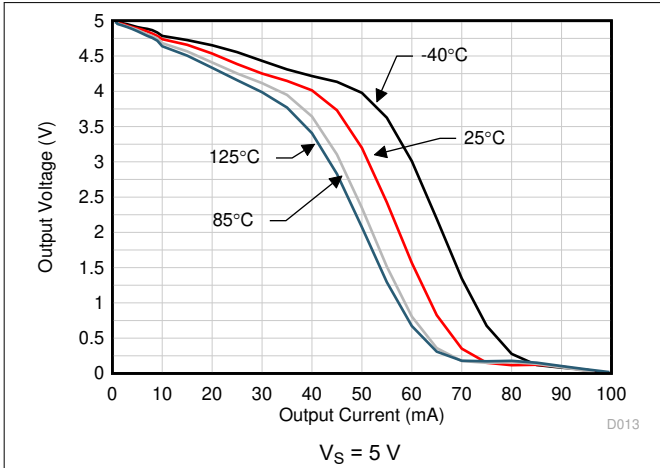


Figure 6-13. Output Voltage Swing vs Output Current (Sourcing)

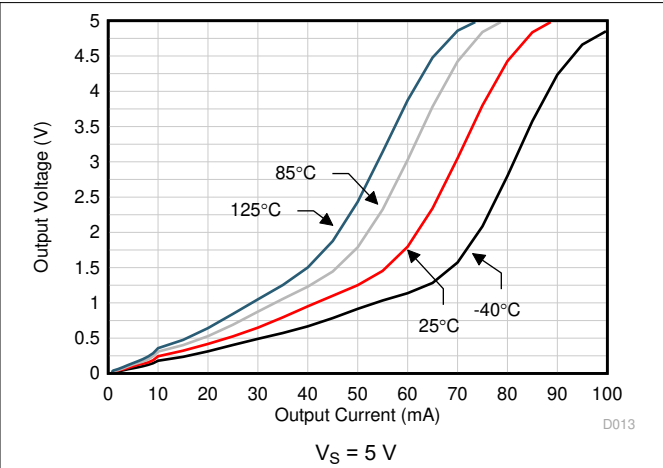


Figure 6-14. Output Voltage Swing vs Output Current (Sinking)

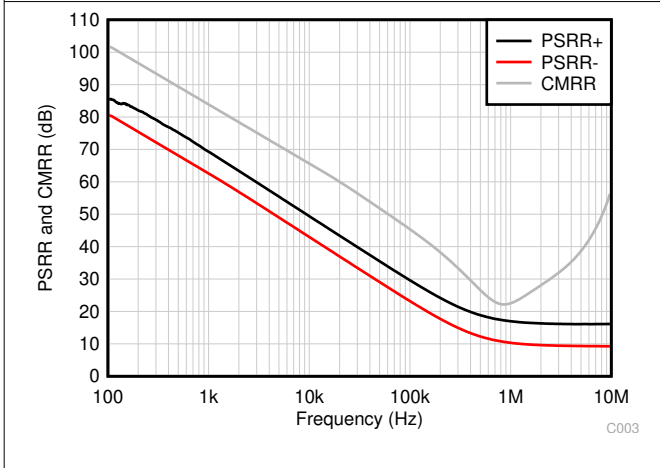


Figure 6-15. CMRR and PSRR vs Frequency

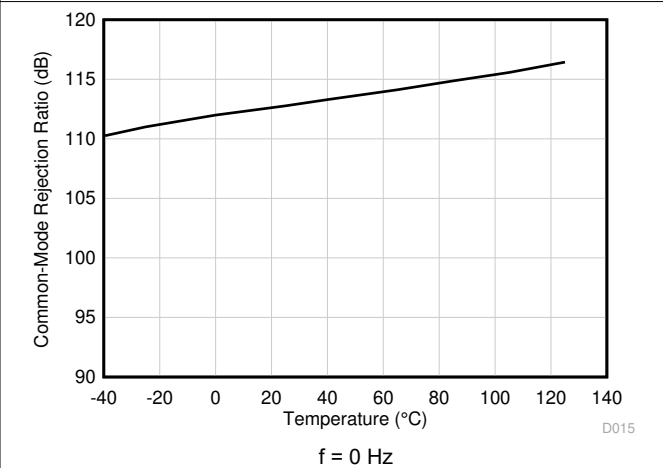


Figure 6-16. CMRR vs Temperature (dB)

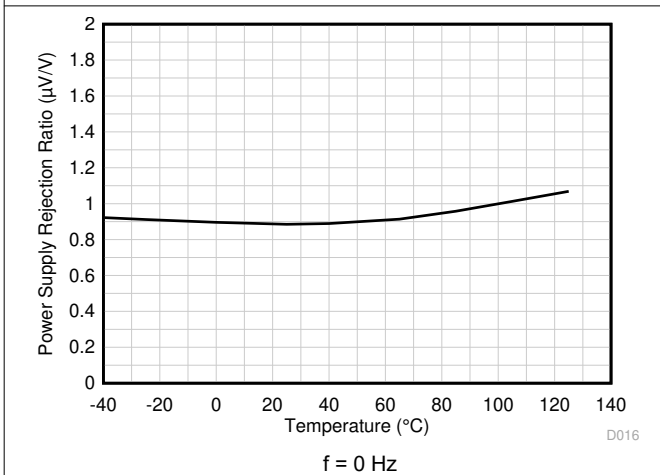


Figure 6-17. PSRR vs Temperature (dB)

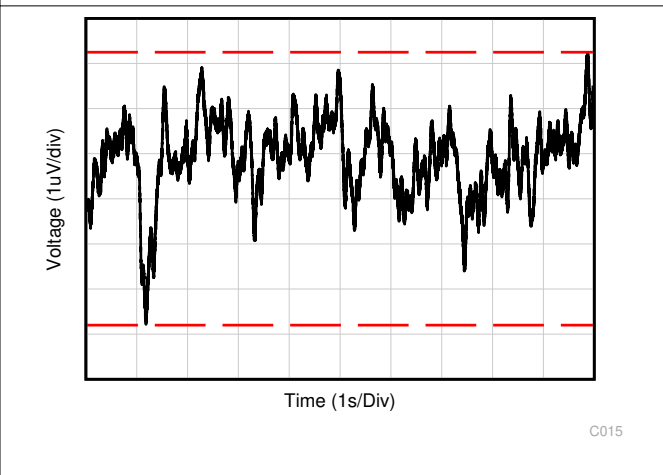


Figure 6-18. 0.1-Hz to 10-Hz Noise

### 6.8 Typical Characteristics (continued)

at  $T_A = 25^\circ\text{C}$ ,  $V_S = \pm 20\text{ V}$ ,  $V_{CM} = V_S / 2$ ,  $R_{LOAD} = 10\text{ k}\Omega$  connected to  $V_S / 2$ , and  $C_L = 100\text{ pF}$  (unless otherwise noted)

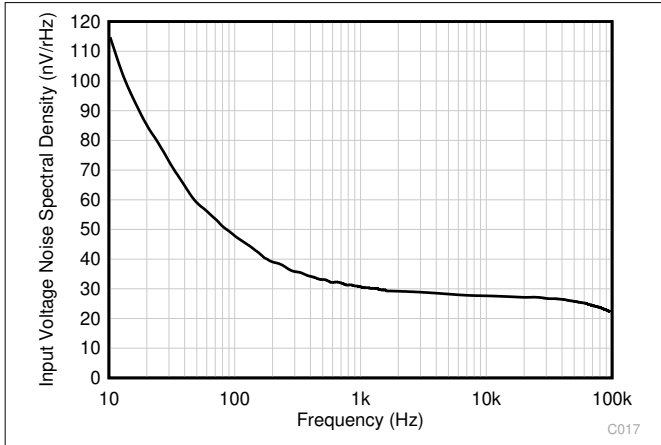
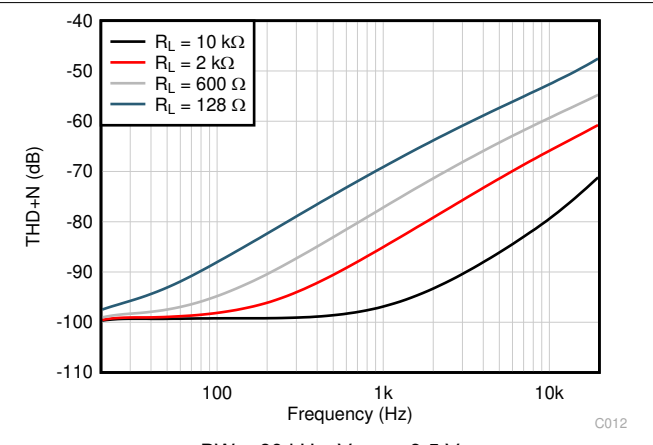
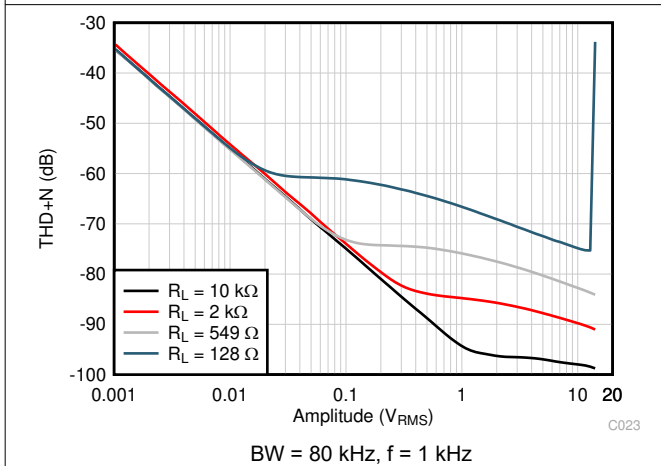


Figure 6-19. Input Voltage Noise Spectral Density vs Frequency



BW = 80 kHz,  $V_{OUT} = 3.5\text{ V}_{RMS}$

Figure 6-20. THD+N Ratio vs Frequency



BW = 80 kHz,  $f = 1\text{ kHz}$

Figure 6-21. THD+N vs Output Amplitude

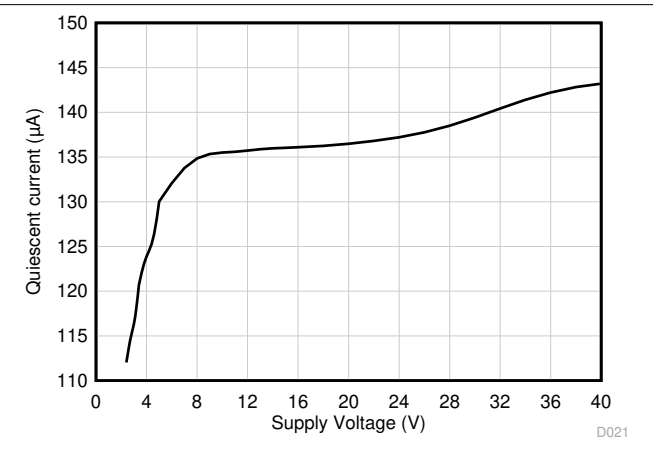


Figure 6-22. Quiescent Current vs Supply Voltage

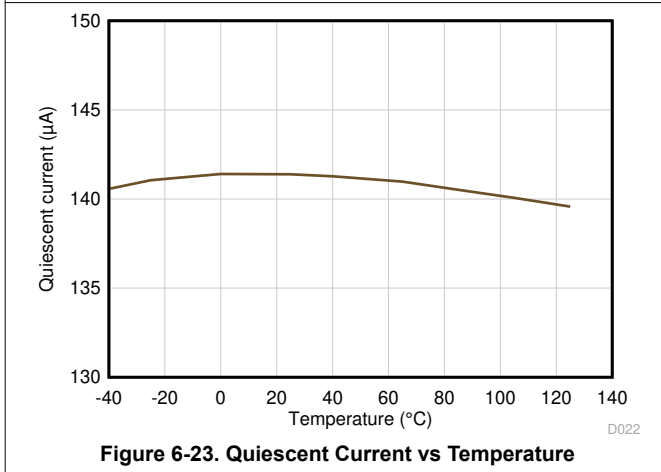


Figure 6-23. Quiescent Current vs Temperature

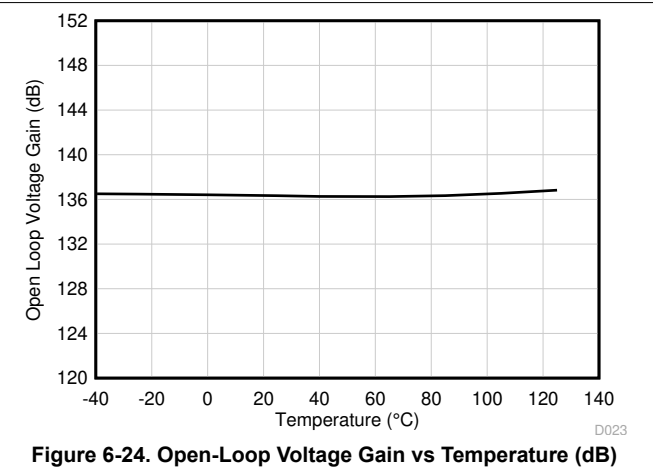
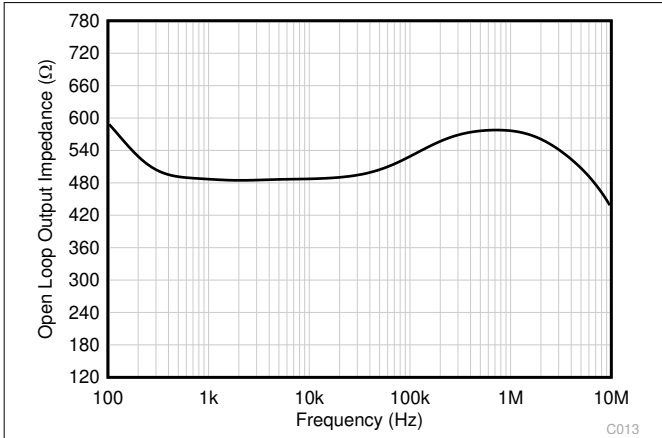


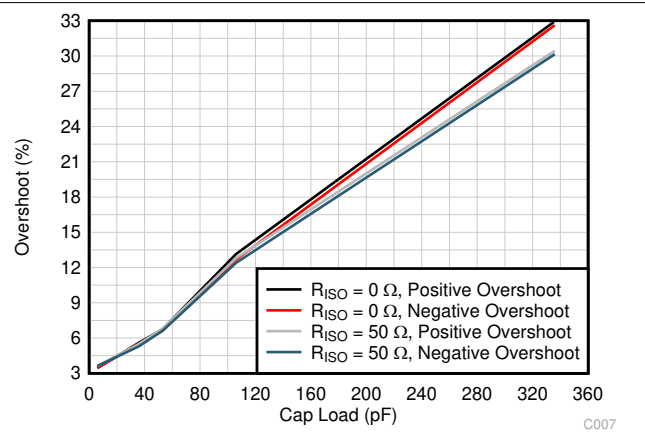
Figure 6-24. Open-Loop Voltage Gain vs Temperature (dB)

### 6.8 Typical Characteristics (continued)

at  $T_A = 25^\circ\text{C}$ ,  $V_S = \pm 20\text{ V}$ ,  $V_{CM} = V_S / 2$ ,  $R_{LOAD} = 10\text{ k}\Omega$  connected to  $V_S / 2$ , and  $C_L = 100\text{ pF}$  (unless otherwise noted)

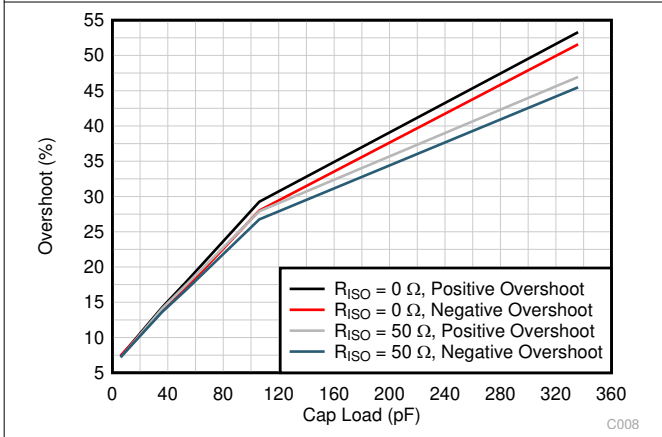


**Figure 6-25. Open-Loop Output Impedance vs Frequency**



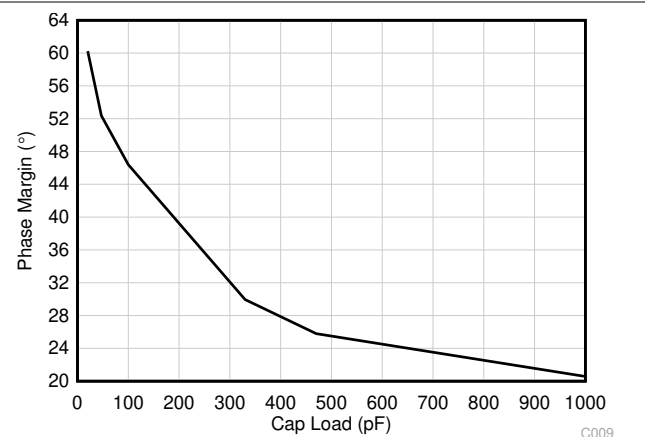
$G = -1$ , 100-mV output step

**Figure 6-26. Small-Signal Overshoot vs Capacitive Load**



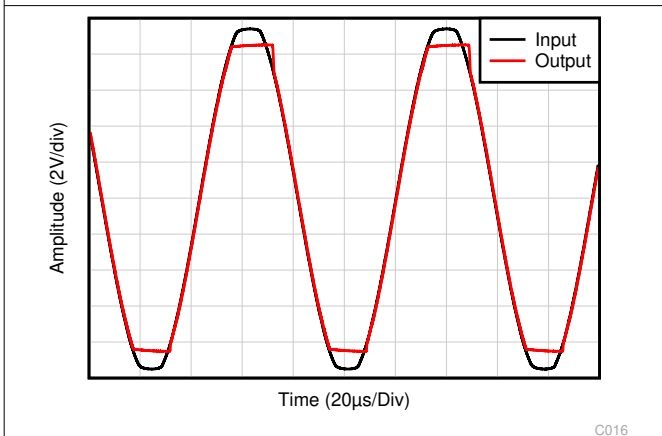
$G = 1$ , 100-mV output step

**Figure 6-27. Small-Signal Overshoot vs Capacitive Load**

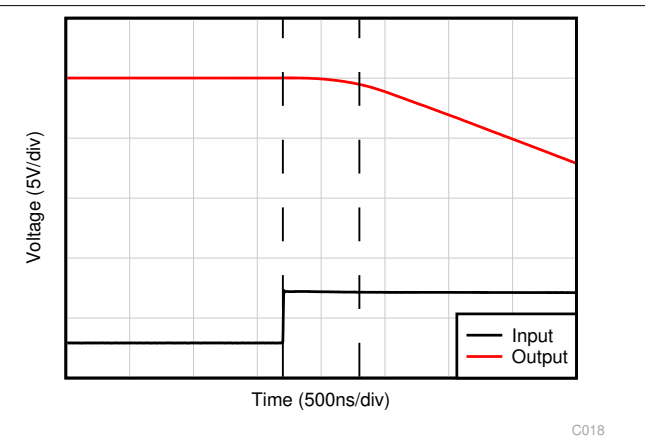


$G = -1$ , 100-mV output step

**Figure 6-28. Small-Signal Overshoot vs Capacitive Load**



**Figure 6-29. No Phase Reversal**

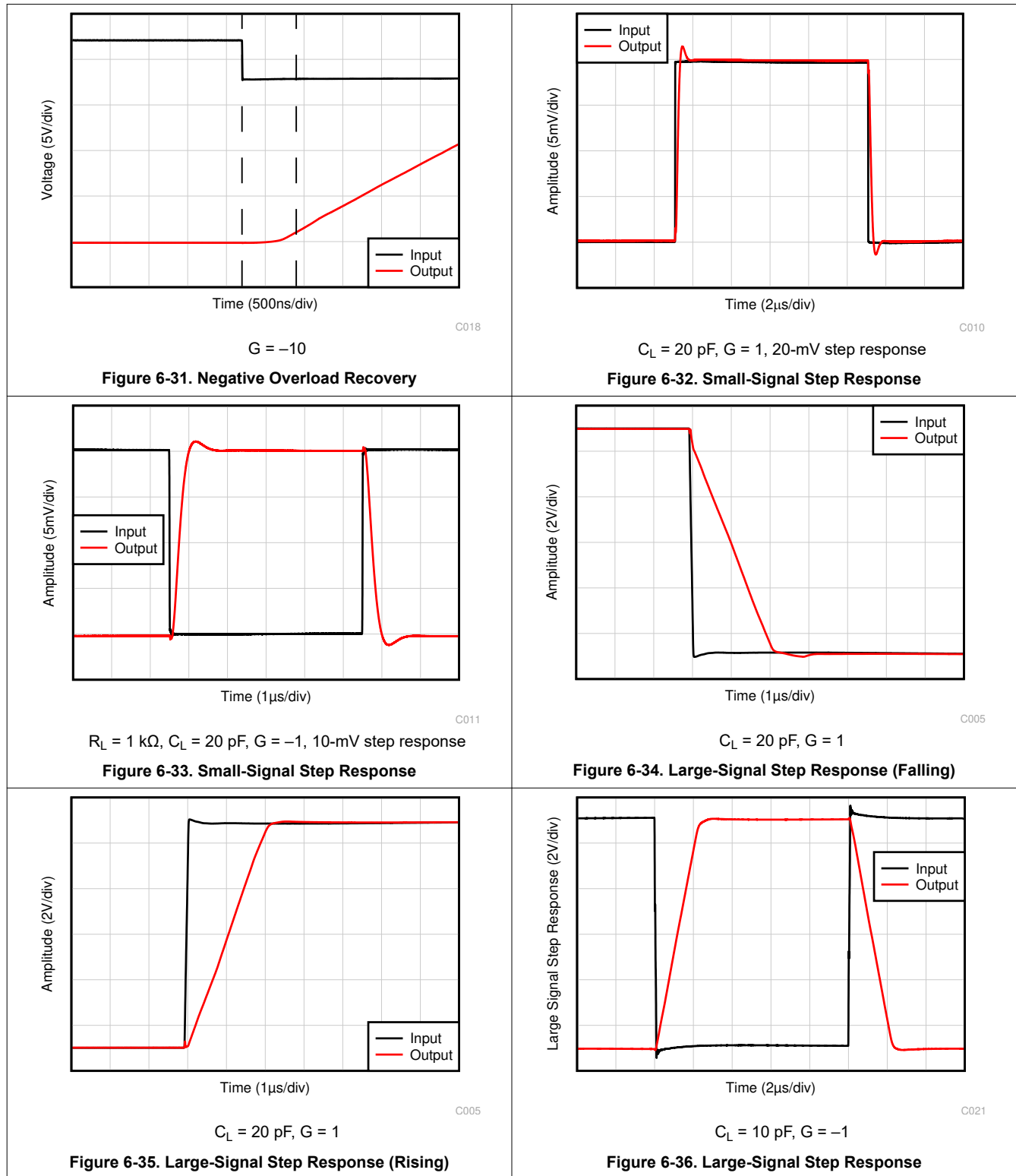


$G = -10$

**Figure 6-30. Positive Overload Recovery**

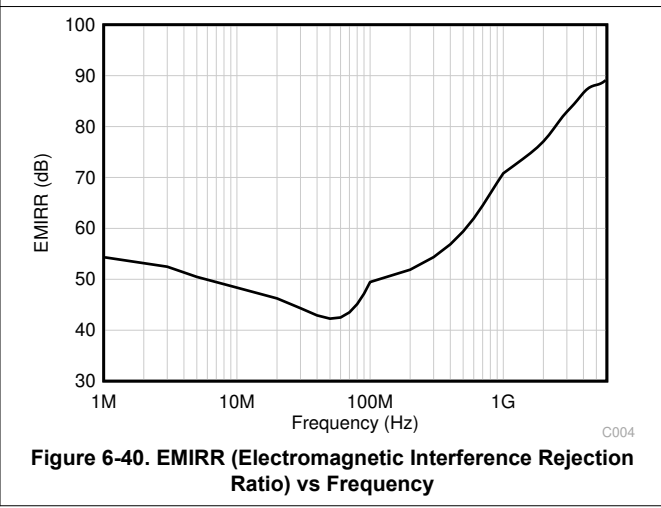
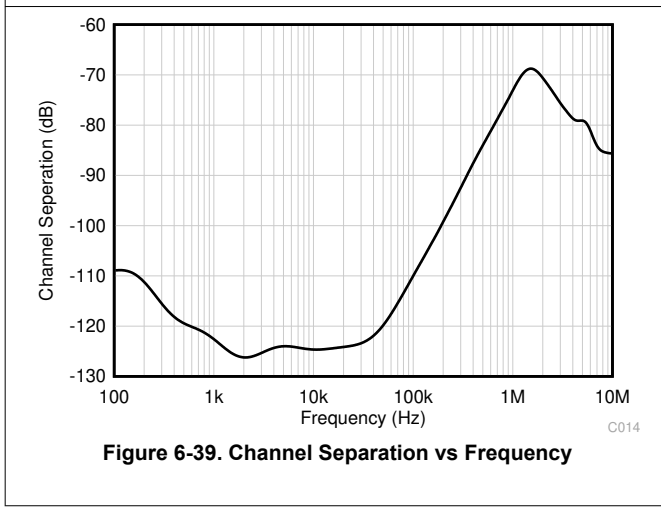
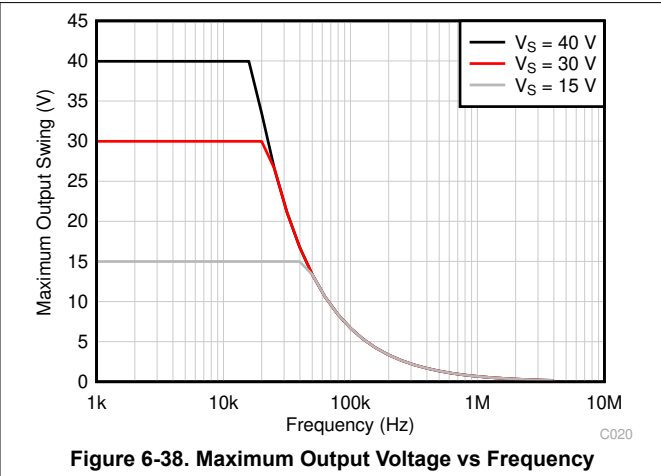
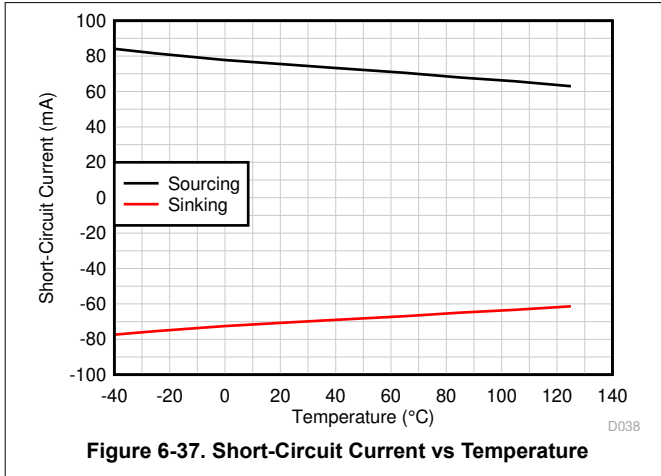
## 6.8 Typical Characteristics (continued)

at  $T_A = 25^\circ\text{C}$ ,  $V_S = \pm 20\text{ V}$ ,  $V_{CM} = V_S / 2$ ,  $R_{LOAD} = 10\text{ k}\Omega$  connected to  $V_S / 2$ , and  $C_L = 100\text{ pF}$  (unless otherwise noted)



### 6.8 Typical Characteristics (continued)

at  $T_A = 25^\circ\text{C}$ ,  $V_S = \pm 20\text{ V}$ ,  $V_{CM} = V_S / 2$ ,  $R_{LOAD} = 10\text{ k}\Omega$  connected to  $V_S / 2$ , and  $C_L = 100\text{ pF}$  (unless otherwise noted)



## 7 Detailed Description

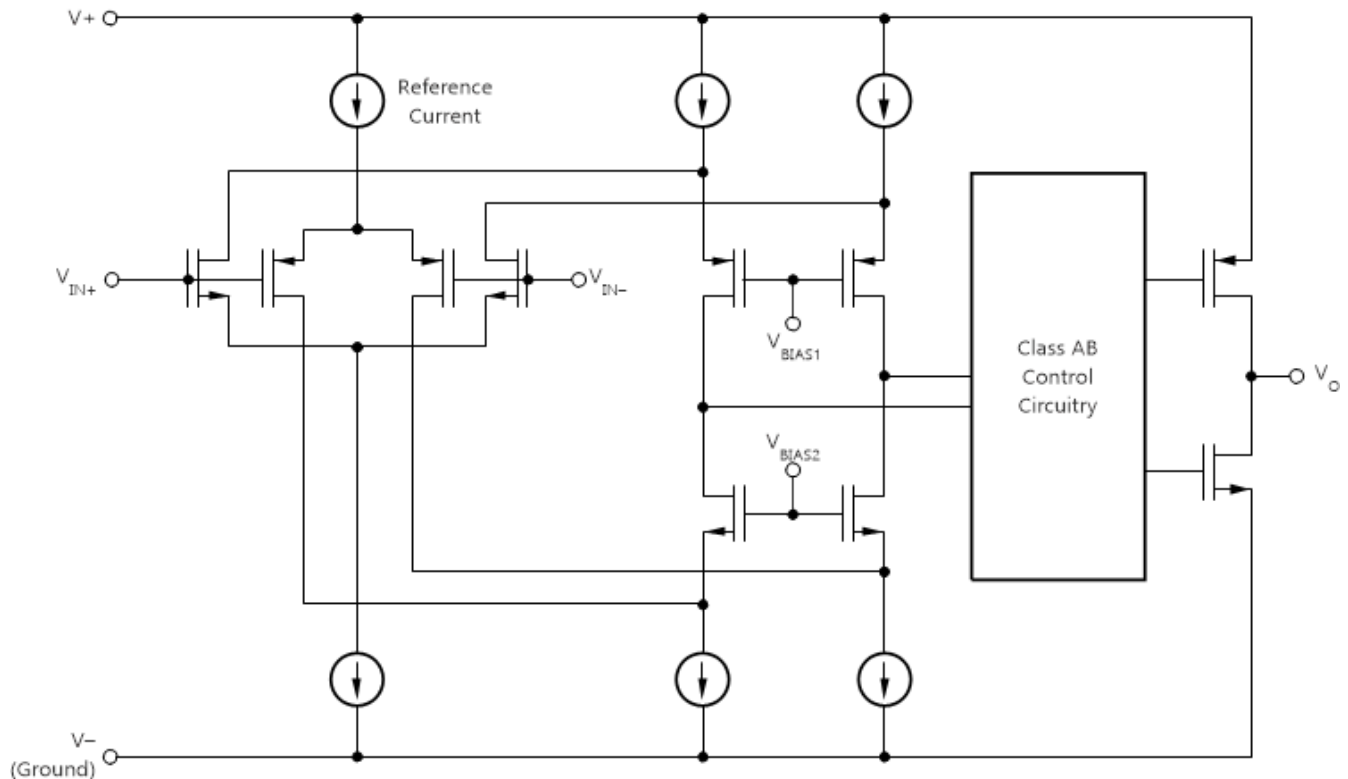
### 7.1 Overview

The TLV930x family (TLV9301, TLV9302, and TLV9304) is a family of 40-V, cost-optimized operational amplifiers. These devices offer strong general-purpose DC and AC specifications, including rail-to-rail output, low offset ( $\pm 0.5$  mV, typ), low offset drift ( $\pm 2$   $\mu\text{V}/^\circ\text{C}$ , typ), and 1-MHz bandwidth.

Convenient features such as wide differential input-voltage range, high output current ( $\pm 60$  mA), and high slew rate (3 V/ $\mu\text{s}$ ) make the TLV930x a robust operational amplifier for high-voltage, cost-sensitive applications.

The TLV930x family of op amps is available in standard packages and is specified from  $-40^\circ\text{C}$  to  $125^\circ\text{C}$ .

### 7.2 Functional Block Diagram



## 7.3 Feature Description

### 7.3.1 Input Protection Circuitry

The TLV930x uses a patented input architecture to eliminate the requirement for input protection diodes but still provides robust input protection under transient conditions. Figure 7-1 shows conventional input diode protection schemes that are activated by fast transient step responses and introduce signal distortion and settling time delays because of alternate current paths, as shown in Figure 7-2. For low-gain circuits, these fast-ramping input signals forward-bias back-to-back diodes, causing an increase in input current and resulting in extended settling time.

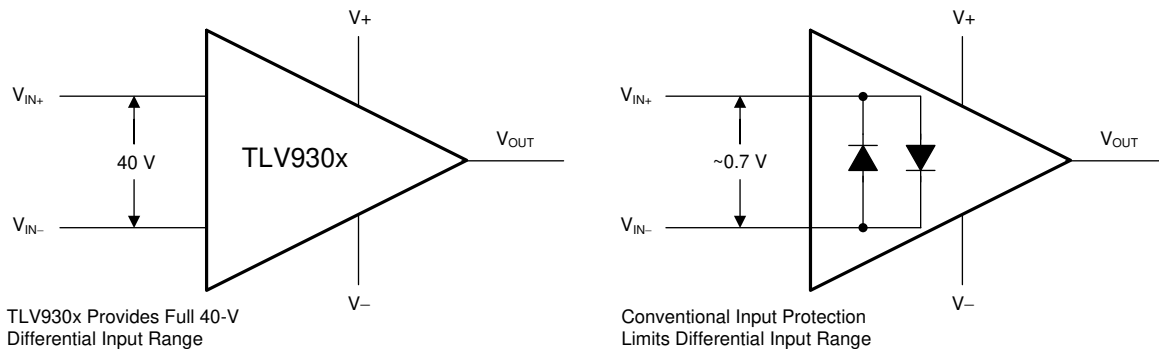


Figure 7-1. TLV930x Input Protection Does Not Limit Differential Input Capability

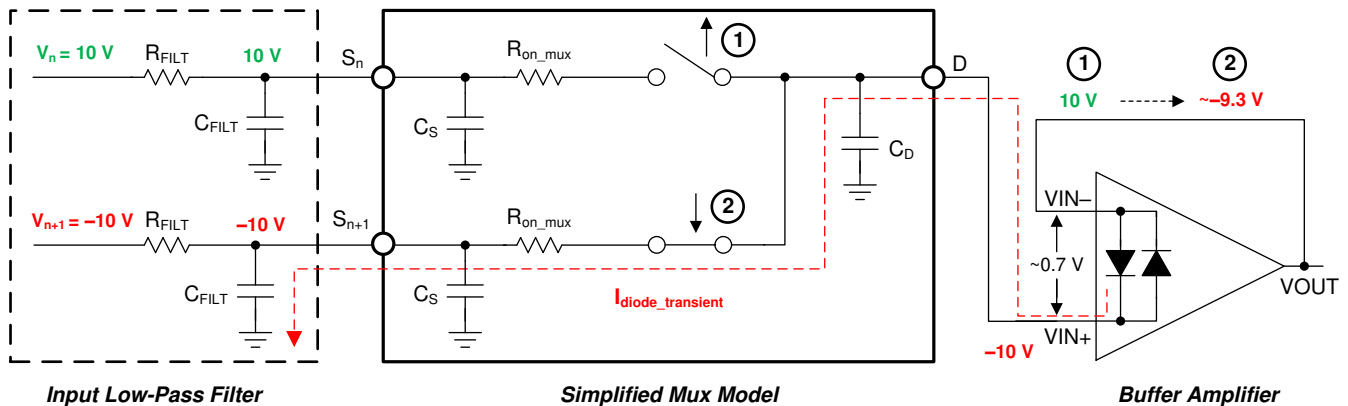
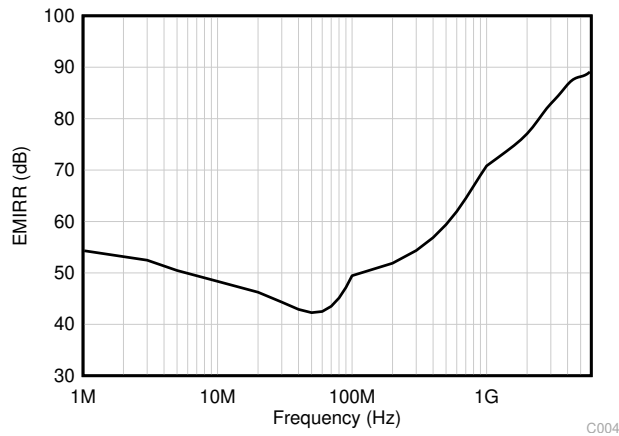


Figure 7-2. Back-to-Back Diodes Create Settling Issues

The TLV930x family of operational amplifiers provides a true high-impedance differential input capability for high-voltage applications. This patented input protection architecture does not introduce additional signal distortion or delayed settling time, making the device an optimal op amp for multichannel, high-switched, input applications. The TLV930x tolerates a maximum differential swing (voltage between inverting and noninverting pins of the op amp) of up to 40 V, making the device suitable for use as a comparator or in applications with fast-ramping input signals.

### 7.3.2 EMI Rejection

The TLV930x uses integrated electromagnetic interference (EMI) filtering to reduce the effects of EMI from sources such as wireless communications and densely-populated boards with a mix of analog signal chain and digital components. EMI immunity can be improved with circuit design techniques; the TLV930x benefits from these design improvements. Texas Instruments has developed the ability to accurately measure and quantify the immunity of an operational amplifier over a broad frequency spectrum extending from 10 MHz to 6 GHz. [Figure 7-3](#) shows the results of this testing on the TLV930x. [Table 7-1](#) shows the EMIRR IN+ values for the TLV930x at particular frequencies commonly encountered in real-world applications. [Table 7-1](#) lists applications that may be centered on or operated near the particular frequency shown. The [EMI Rejection Ratio of Operational Amplifiers](#) application report contains detailed information on the topic of EMIRR performance as it relates to op amps and is available for download from [www.ti.com](http://www.ti.com).



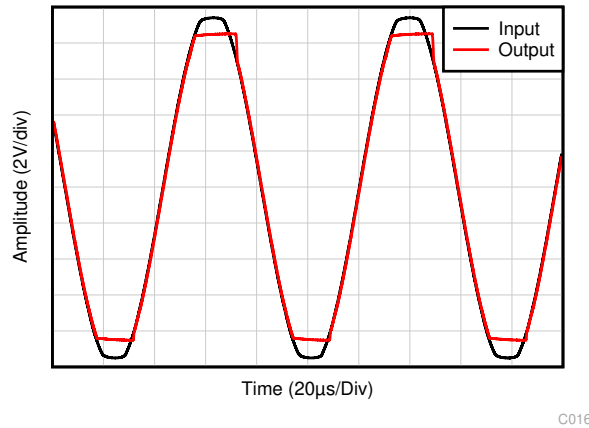
**Figure 7-3. EMIRR Testing**

**Table 7-1. TLV930x EMIRR IN+ for Frequencies of Interest**

FREQUENCY	APPLICATION OR ALLOCATION	EMIRR IN+
400 MHz	Mobile radio, mobile satellite, space operation, weather, radar, ultra-high frequency (UHF) applications	59.5 dB
900 MHz	Global system for mobile communications (GSM) applications, radio communication, navigation, GPS (to 1.6 GHz), GSM, aeronautical mobile, UHF applications	68.9 dB
1.8 GHz	GSM applications, mobile personal communications, broadband, satellite, L-band (1 GHz to 2 GHz)	77.8 dB
2.4 GHz	802.11b, 802.11g, 802.11n, Bluetooth®, mobile personal communications, industrial, scientific and medical (ISM) radio band, amateur radio and satellite, S-band (2 GHz to 4 GHz)	78.0 dB
3.6 GHz	Radiolocation, aero communication and navigation, satellite, mobile, S-band	88.8 dB
5 GHz	802.11a, 802.11n, aero communication and navigation, mobile communication, space and satellite operation, C-band (4 GHz to 8 GHz)	87.6 dB

### 7.3.3 Phase Reversal Protection

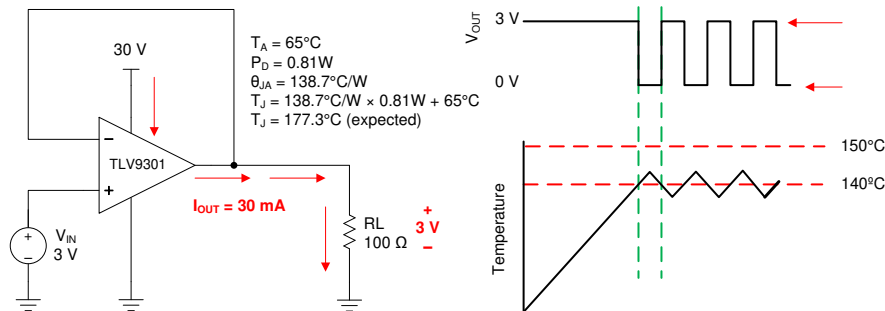
The TLV930x family has internal phase-reversal protection. Many op amps exhibit a phase reversal when the input is driven beyond its linear common-mode range. This condition is most often encountered in noninverting circuits when the input is driven beyond the specified common-mode voltage range, causing the output to reverse into the opposite rail. The TLV930x is a rail-to-rail input op amp; therefore, the common-mode range can extend up to the rails. Input signals beyond the rails do not cause phase reversal; instead, the output limits into the appropriate rail. This performance is shown in Figure 7-4.



**Figure 7-4. No Phase Reversal**

### 7.3.4 Thermal Protection

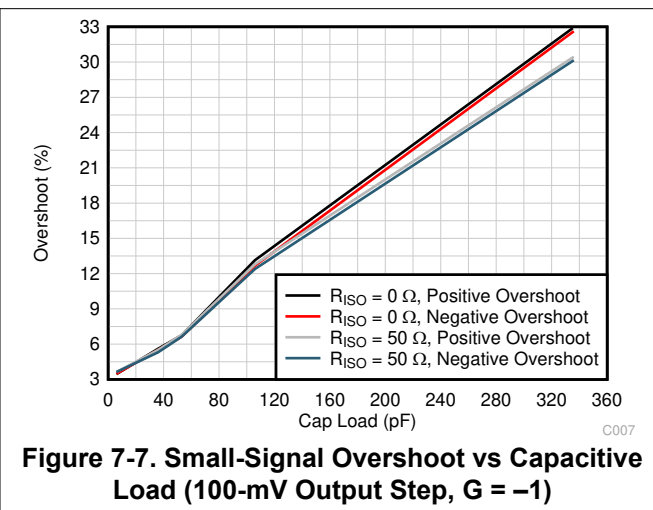
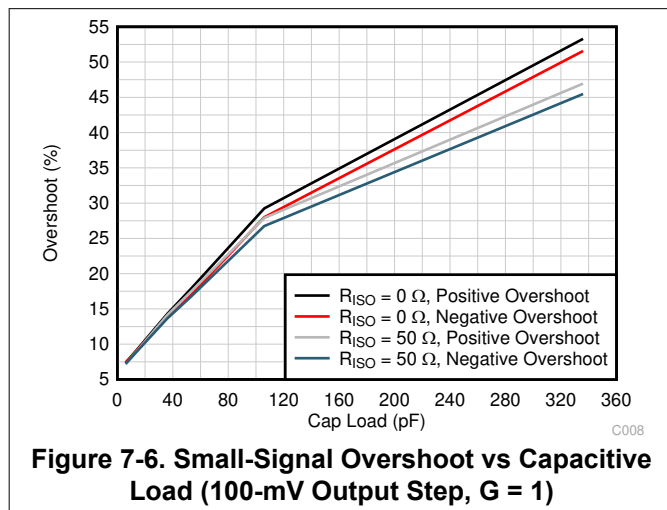
The internal power dissipation of any amplifier causes its internal (junction) temperature to rise. This phenomenon is called *self heating*. The absolute maximum junction temperature of the TLV930x is 150°C. Exceeding this temperature causes damage to the device. The TLV930x has a thermal protection feature that prevents damage from self heating. The protection works by monitoring the temperature of the device and turning off the op amp output drive for temperatures above 140°C. Figure 7-5 shows an application example for the TLV9301 that has significant self heating (159°C) because of its power dissipation (0.81 W). Thermal calculations indicate that for an ambient temperature of 65°C the device junction temperature must reach 187°C. The actual device, however, turns off the output drive to maintain a safe junction temperature. Figure 7-5 shows how the circuit behaves during thermal protection. During normal operation, the device acts as a buffer so the output is 3 V. When self heating causes the device junction temperature to increase above 140°C, the thermal protection forces the output to a high-impedance state and the output is pulled to ground through resistor RL.



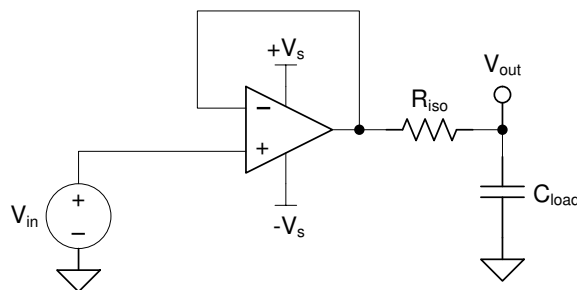
**Figure 7-5. Thermal Protection**

### 7.3.5 Capacitive Load and Stability

The TLV930x features a resistive output stage capable of driving smaller capacitive loads, and by leveraging an isolation resistor, the device can easily be configured to drive large capacitive loads. Increasing the gain enhances the ability of the amplifier to drive greater capacitive loads; see [Figure 7-6](#) and [Figure 7-7](#). The particular op amp circuit configuration, layout, gain, and output loading are some of the factors to consider when establishing whether an amplifier is stable in operation.



For additional drive capability in unity-gain configurations, improve capacitive load drive by inserting a small (10 Ω to 20 Ω) resistor,  $R_{ISO}$ , in series with the output, as shown in [Figure 7-8](#). This resistor significantly reduces ringing and maintains DC performance for purely capacitive loads. However, if a resistive load is in parallel with the capacitive load, then a voltage divider is created, thus introducing a gain error at the output and slightly reducing the output swing. The error introduced is proportional to the ratio  $R_{ISO} / R_L$ , and is generally negligible at low output levels. A high capacitive load drive makes the TLV930x well suited for applications such as reference buffers, MOSFET gate drives, and cable-shield drives. The circuit shown in [Figure 7-8](#) uses an isolation resistor,  $R_{ISO}$ , to stabilize the output of an op amp.  $R_{ISO}$  modifies the open-loop gain of the system for increased phase margin. For additional information on techniques to optimize and design using this circuit, TI Precision Design [TIDU032](#) details complete design goals, simulation, and test results.



**Figure 7-8. Extending Capacitive Load Drive With the TLV9301**

### 7.3.6 Common-Mode Voltage Range

The TLV930x is a 40-V, rail-to-rail output operational amplifier with an input common-mode range that extends 100 mV beyond  $V_-$  and within 2 V of  $V_+$  for normal operation. The device accomplishes this performance through a complementary input stage, using a P-channel differential pair. Additionally, a complementary N-channel differential pair has been included in parallel with the P-channel pair to eliminate common undesirable op amp behaviors, such as phase reversal.

The TLV930x can operate with common mode ranges beyond 100 mV of the top rail, but with reduced performance above  $(V_+) - 2$  V. The N-channel pair is active for input voltages close to the positive rail, typically  $(V_+) - 1$  V to 100 mV above the positive supply. The P-channel pair is active for inputs from 100 mV below the negative supply to approximately  $(V_+) - 2$  V. There is a small transition region, typically  $(V_+) - 2$  V to  $(V_+) - 1$  V in which both input pairs are on. This transition region can vary modestly with process variation, and within the transition region and N-channel region, many specifications of the op amp, including PSRR, CMRR, offset voltage, offset drift, noise and THD performance may be degraded compared to operation within the P-channel region.

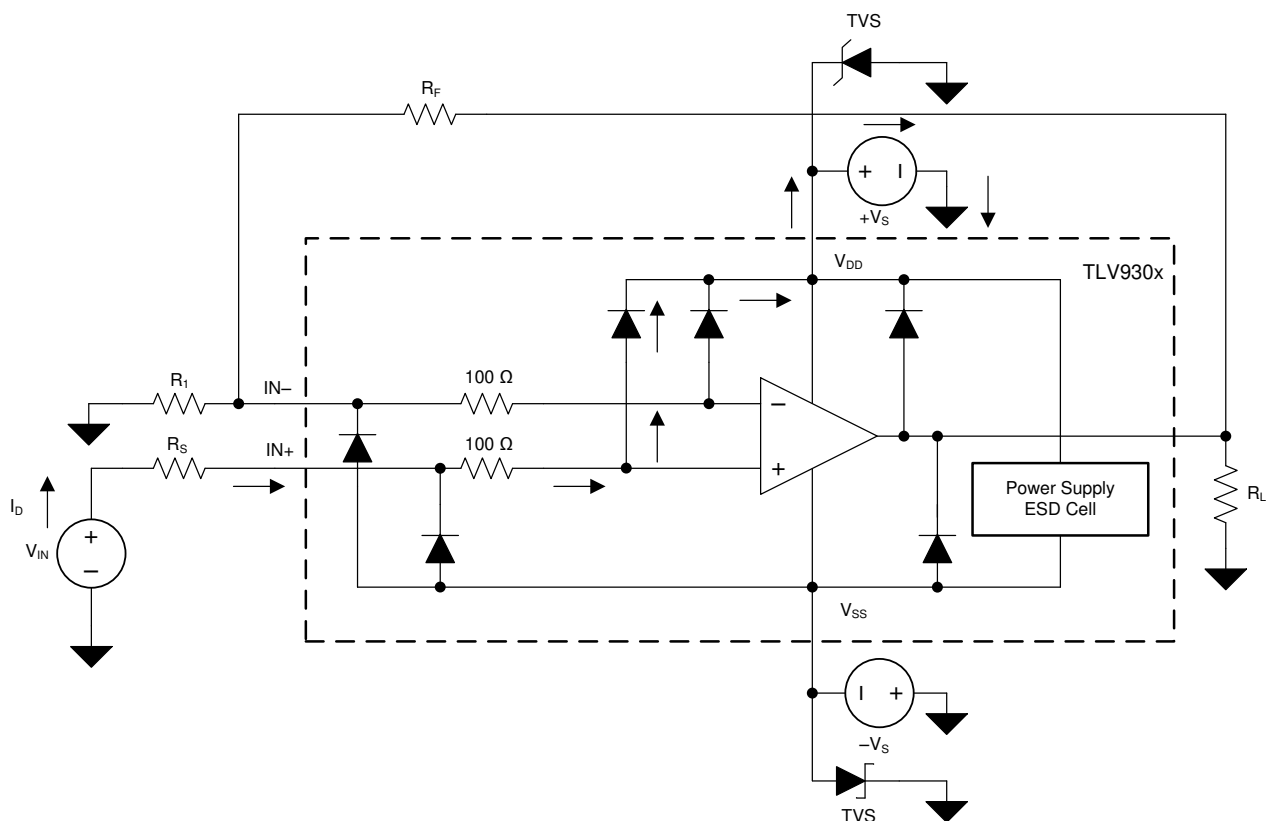
**Table 7-2. Typical Performance for Common-Mode Voltages Within 2 V of the Positive Supply**

PARAMETER	MIN	TYP	MAX	UNIT
Input common-mode voltage	$(V_+) - 2$		$(V_+) + 0.1$	V
Offset voltage		1.5		mV
Offset voltage drift		2		$\mu\text{V}/^\circ\text{C}$
Common-mode rejection		75		dB
Open-loop gain		75		dB
Gain-bandwidth product		0.7		MHz

### 7.3.7 Electrical Overstress

Designers often ask questions about the capability of an operational amplifier to withstand electrical overstress (EOS). These questions tend to focus on the device inputs, but may involve the supply voltage pins or even the output pin. Each of these different pin functions have electrical stress limits determined by the voltage breakdown characteristics of the particular semiconductor fabrication process and specific circuits connected to the pin. Additionally, internal electrostatic discharge (ESD) protection is built into these circuits to protect them from accidental ESD events both before and during product assembly.

Having a good understanding of this basic ESD circuitry and its relevance to an electrical overstress event is helpful. Figure 7-9 shows an illustration of the ESD circuits contained in the TLV930x (indicated by the dashed line area). The ESD protection circuitry involves several current-steering diodes connected from the input and output pins and routed back to the internal power-supply lines, where the diodes meet at an absorption device or the power-supply ESD cell, internal to the operational amplifier. This protection circuitry is intended to remain inactive during normal circuit operation.



**Figure 7-9. Equivalent Internal ESD Circuitry Relative to a Typical Circuit Application**

An ESD event is very short in duration and very high voltage (for example, 1 kV, 100 ns), whereas an EOS event is long duration and lower voltage (for example, 50 V, 100 ms). The ESD diodes are designed for out-of-circuit ESD protection (that is, during assembly, test, and storage of the device before being soldered to the PCB). During an ESD event, the ESD signal is passed through the ESD steering diodes to an absorption circuit (labeled ESD power-supply circuit). The ESD absorption circuit clamps the supplies to a safe level.

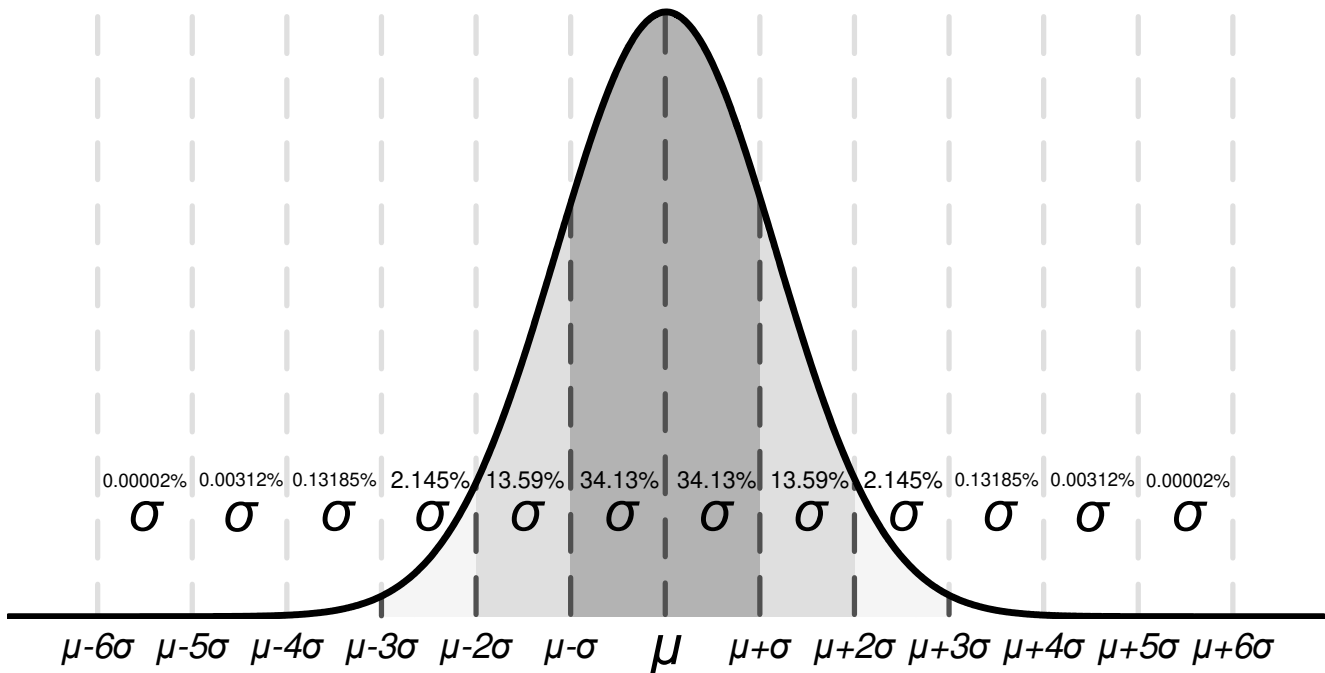
Although this behavior is necessary for out-of-circuit protection, excessive current and damage is caused if activated in-circuit. A transient voltage suppressors (TVS) can be used to prevent against damage caused by turning on the ESD absorption circuit during an in-circuit ESD event. Using the appropriate current limiting resistors and TVS diodes allows for the use of device ESD diodes to protect against EOS events.

### 7.3.8 Overload Recovery

Overload recovery is defined as the time required for the op amp output to recover from a saturated state to a linear state. The output devices of the op amp enter a saturation region when the output voltage exceeds the rated operating voltage, either due to the high input voltage or the high gain. After the device enters the saturation region, the charge carriers in the output devices require time to return back to the linear state. After the charge carriers return back to the linear state, the device begins to slew at the specified slew rate. Thus, the propagation delay in case of an overload condition is the sum of the overload recovery time and the slew time. The overload recovery time for the TLV930x is approximately 1  $\mu$ s.

### 7.3.9 Typical Specifications and Distributions

Designers often have questions about a typical specification of an amplifier in order to design a more robust circuit. Due to natural variation in process technology and manufacturing procedures, every specification of an amplifier will exhibit some amount of deviation from the ideal value, like an amplifier's input offset voltage. These deviations often follow *Gaussian* ("bell curve"), or *normal* distributions, and circuit designers can leverage this information to guardband their system, even when there is not a minimum or maximum specification in [Section 6.7](#).



**Figure 7-10. Ideal Gaussian Distribution**

[Figure 7-10](#) shows an example distribution, where  $\mu$ , or *mu*, is the mean of the distribution, and where  $\sigma$ , or *sigma*, is the standard deviation of a system. For a specification that exhibits this kind of distribution, approximately two-thirds (68.26%) of all units can be expected to have a value within one standard deviation, or one sigma, of the mean (from  $\mu - \sigma$  to  $\mu + \sigma$ ).

Depending on the specification, values listed in the *typical* column in [Section 6.7](#) are represented in different ways. As a general rule of thumb, if a specification naturally has a nonzero mean (for example, like gain bandwidth), then the typical value is equal to the mean ( $\mu$ ). However, if a specification naturally has a mean near zero (like input offset voltage), then the typical value is equal to the mean plus one standard deviation ( $\mu + \sigma$ ) in order to most accurately represent the typical value.

You can use this chart to calculate approximate probability of a specification in a unit; for example, for TLV930x, the typical input voltage offset is 500  $\mu\text{V}$ , so 68.2% of all TLV930x devices are expected to have an offset from  $-500 \mu\text{V}$  to  $+500 \mu\text{V}$ . At  $4 \sigma$  ( $\pm 2000 \mu\text{V}$ ), 99.9937% of the distribution has an offset voltage less than  $\pm 2000 \mu\text{V}$ , which means 0.0063% of the population is outside of these limits, which corresponds to about 1 in 15,873 units.

Specifications with a value in the minimum or maximum column are assured by TI, and units outside these limits will be removed from production material. For example, the TLV930x family has a maximum offset voltage of 2.5 mV at 125°C, and even though this corresponds to  $5 \sigma$  ( $\approx 1$  in 1.7 million units), which is extremely unlikely, TI assures that any unit with larger offset than 2.5 mV will be removed from production material.

For specifications with no value in the minimum or maximum column, consider selecting a sigma value of sufficient guardband for your application, and design worst-case conditions using this value. For example, the  $6\sigma$  value corresponds to about 1 in 500 million units, which is an extremely unlikely chance, and could be an option as a wide guardband to design a system around. In this case, the TLV930x family does not have a maximum or minimum for offset voltage drift, but based on [Figure 6-2](#) and the typical value of  $2 \mu\text{V}/^\circ\text{C}$  in [Section 6.7](#), it can be calculated that the  $6\text{-}\sigma$  value for offset voltage drift is about  $12 \mu\text{V}/^\circ\text{C}$ . When designing for worst-case system conditions, this value can be used to estimate the worst possible offset across temperature without having an actual minimum or maximum value.

However, process variation and adjustments over time can shift typical means and standard deviations, and unless there is a value in the minimum or maximum specification column, TI cannot assure the performance of a device. This information should be used only to estimate the performance of a device.

## 7.4 Device Functional Modes

The TLV930x has a single functional mode and is operational when the power-supply voltage is greater than 4.5 V ( $\pm 2.25$  V). The maximum power supply voltage for the TLV930x is 40 V ( $\pm 20$  V).

## 8 Application and Implementation

### Note

Information in the following applications sections is not part of the TI component specification, and TI does not warrant its accuracy or completeness. TI's customers are responsible for determining suitability of components for their purposes, as well as validating and testing their design implementation to confirm system functionality.

### 8.1 Application Information

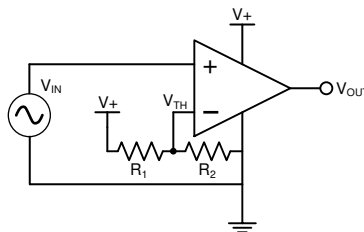
The TLV930x family offers excellent DC precision and DC performance. These devices operate up to 40-V supply rails and offer true rail-to-rail input/output, low offset voltage and offset voltage drift, as well as 1-MHz bandwidth and high output drive. These features make the TLV930x a robust, high-performance operational amplifier for high-voltage industrial applications.

### 8.2 Typical Applications

#### 8.2.1 High Voltage Precision Comparator

Many different systems require controlled voltages across numerous system nodes to ensure robust operation. A comparator can be used to monitor and control voltages by comparing a reference threshold voltage with an input voltage and providing an output when the input crosses this threshold.

The TLV930x family of op amps make excellent high voltage comparators due to their MUX-friendly input stage (see [Section 7.3.1](#)). Previous generation high-voltage op amps often use back-to-back diodes across the inputs to prevent damage to the op amp which greatly limits these op amps to be used as comparators, but the TLV930x's patented input stage allows the device to have a wide differential voltage between the inputs.



**Figure 8-1. Typical Comparator Application**

##### 8.2.1.1 Design Requirements

The primary objective is to design a 40-V precision comparator.

- System supply voltage ( $V_+$ ): 40 V
- Resistor 1 value: 100 k $\Omega$
- Resistor 2 value: 100 k $\Omega$
- Reference threshold voltage ( $V_{TH}$ ): 20 V
- Input voltage range ( $V_{IN}$ ): 0 V – 40 V
- Output voltage range ( $V_{OUT}$ ): 0 V – 40 V

### 8.2.1.2 Detailed Design Procedure

This noninverting comparator circuit applies the input voltage ( $V_{IN}$ ) to the noninverting terminal of the op amp. Two resistors ( $R_1$  and  $R_2$ ) divide the supply voltage ( $V_+$ ) to create a mid-supply threshold voltage ( $V_{TH}$ ) as calculated in Equation 1. The circuit is shown in Figure 8-1. When  $V_{IN}$  is less than  $V_{TH}$ , the output voltage transitions to the negative supply and equals the low-level output voltage. When  $V_{IN}$  is greater than  $V_{TH}$ , the output voltage transitions to the positive supply and equals the high-level output voltage.

In this example, resistor 1 and 2 have been selected to be 100 k $\Omega$ , which sets the reference threshold at 20 V. However, resistor 1 and 2 can be adjusted to modify the threshold using Equation 1. Resistor 1 and 2's values have also been selected to reduce power consumption, but these values can be further increased to reduce power consumption, or reduced to improve noise performance.

$$V_{TH} = \frac{R_2}{R_1 + R_2} \times V_+ \quad (1)$$

### 8.2.1.3 Application Curve

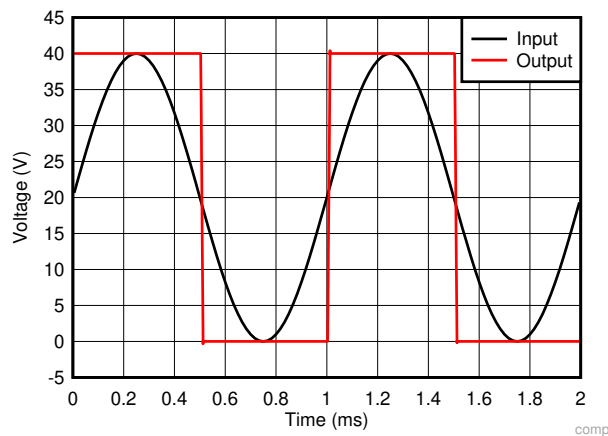


Figure 8-2. Comparator Output Response to Input Voltage

## 9 Power Supply Recommendations

The TLV930x is specified for operation from 4.5 V to 40 V ( $\pm 2.25$  V to  $\pm 20$  V); many specifications apply from  $-40^{\circ}\text{C}$  to  $125^{\circ}\text{C}$ . Parameters that can exhibit significant variance with regard to operating voltage or temperature are presented in [Section 6.7](#).

### CAUTION

Supply voltages larger than 40 V can permanently damage the device; see the [Absolute Maximum Ratings](#) table.

Place 0.1- $\mu\text{F}$  bypass capacitors close to the power-supply pins to reduce errors coupling in from noisy or high-impedance power supplies. For more detailed information on bypass capacitor placement, refer to [Section 10](#).

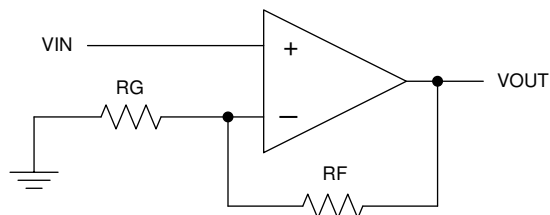
## 10 Layout

### 10.1 Layout Guidelines

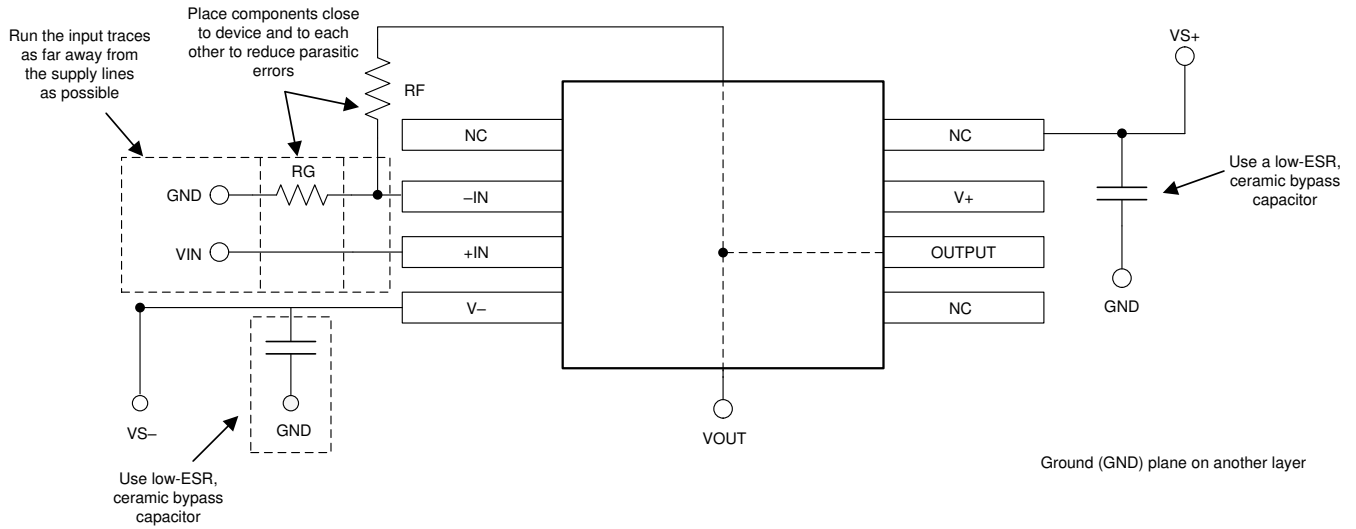
For best operational performance of the device, use good PCB layout practices, including:

- Noise can propagate into analog circuitry through the power pins of the circuit as a whole and op amp itself. Bypass capacitors are used to reduce the coupled noise by providing low-impedance power sources local to the analog circuitry.
  - Connect low-ESR, 0.1- $\mu\text{F}$  ceramic bypass capacitors between each supply pin and ground, placed as close to the device as possible. A single bypass capacitor from V+ to ground is applicable for single-supply applications.
- Separate grounding for analog and digital portions of circuitry is one of the simplest and most-effective methods of noise suppression. One or more layers on multilayer PCBs are usually devoted to ground planes. A ground plane helps distribute heat and reduces EMI noise pickup. Make sure to physically separate digital and analog grounds paying attention to the flow of the ground current.
- In order to reduce parasitic coupling, run the input traces as far away from the supply or output traces as possible. If these traces cannot be kept separate, crossing the sensitive trace perpendicular is much better as opposed to in parallel with the noisy trace.
- Place the external components as close to the device as possible. As illustrated in [Figure 10-2](#), keeping RF and RG close to the inverting input minimizes parasitic capacitance.
- Keep the length of input traces as short as possible. Always remember that the input traces are the most sensitive part of the circuit.
- Consider a driven, low-impedance guard ring around the critical traces. A guard ring can significantly reduce leakage currents from nearby traces that are at different potentials.
- Cleaning the PCB following board assembly is recommended for best performance.
- Any precision integrated circuit may experience performance shifts due to moisture ingress into the plastic package. Following any aqueous PCB cleaning process, baking the PCB assembly is recommended to remove moisture introduced into the device packaging during the cleaning process. A low temperature, post cleaning bake at  $85^{\circ}\text{C}$  for 30 minutes is sufficient for most circumstances.

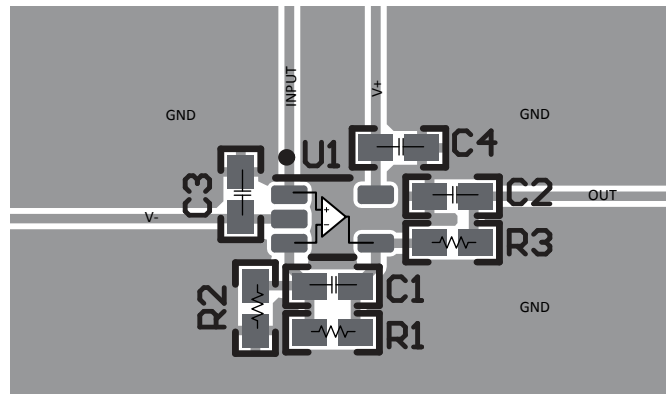
### 10.2 Layout Example



**Figure 10-1. Schematic Representation**



**Figure 10-2. Operational Amplifier Board Layout for Noninverting Configuration**



**Figure 10-3. Example Layout for SC70 (DCK) Package**

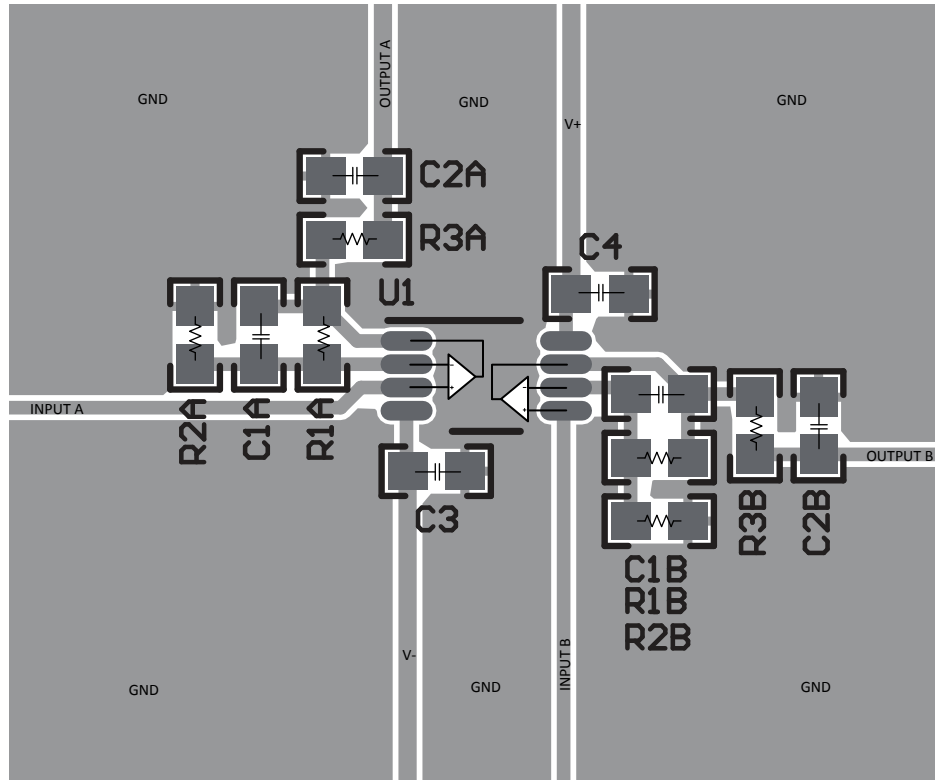


Figure 10-4. Example Layout for VSSOP-8 (DGK) Package

## 11 Device and Documentation Support

### 11.1 Device Support

#### 11.1.1 Development Support

##### 11.1.1.1 TINA-TI™ (Free Software Download)

TINA™ is a simple, powerful, and easy-to-use circuit simulation program based on a SPICE engine. TINA-TI is a free, fully-functional version of the TINA software, preloaded with a library of macro models in addition to a range of both passive and active models. TINA-TI provides all the conventional dc, transient, and frequency domain analysis of SPICE, as well as additional design capabilities.

Available as a [free download](#) from the Analog eLab Design Center, TINA-TI offers extensive post-processing capability that allows users to format results in a variety of ways. Virtual instruments offer the ability to select input waveforms and probe circuit nodes, voltages, and waveforms, creating a dynamic quick-start tool.

---

#### Note

These files require that either the TINA software (from DesignSoft™) or TINA-TI software be installed. Download the free TINA-TI software from the [TINA-TI folder](#).

---

##### 11.1.1.2 TI Precision Designs

The TLV930x is featured in several TI Precision Designs, available online at <http://www.ti.com/ww/en/analog/precision-designs/>. TI Precision Designs are analog solutions created by TI's precision analog applications experts and offer the theory of operation, component selection, simulation, complete PCB schematic and layout, bill of materials, and measured performance of many useful circuits.

### 11.2 Documentation Support

#### 11.2.1 Related Documentation

Texas Instruments, [EMI Rejection Ratio of Operational Amplifiers application report](#)

Texas Instruments, [Capacitive Load Drive Solution using an Isolation Resistor reference design](#)

### 11.3 Receiving Notification of Documentation Updates

To receive notification of documentation updates, navigate to the device product folder on [ti.com](#). Click on *Subscribe to updates* to register and receive a weekly digest of any product information that has changed. For change details, review the revision history included in any revised document.

### 11.4 Support Resources

[TI E2E™ support forums](#) are an engineer's go-to source for fast, verified answers and design help — straight from the experts. Search existing answers or ask your own question to get the quick design help you need.

Linked content is provided "AS IS" by the respective contributors. They do not constitute TI specifications and do not necessarily reflect TI's views; see TI's [Terms of Use](#).

### 11.5 Trademarks

TINA-TI™ are trademarks of Texas Instruments, Inc and DesignSoft, Inc.

TINA™ and DesignSoft™ are trademarks of DesignSoft, Inc.

TI E2E™ is a trademark of Texas Instruments.

Bluetooth® is a registered trademark of Bluetooth SIG, Inc.

All trademarks are the property of their respective owners.

## 11.6 Electrostatic Discharge Caution



This integrated circuit can be damaged by ESD. Texas Instruments recommends that all integrated circuits be handled with appropriate precautions. Failure to observe proper handling and installation procedures can cause damage.

ESD damage can range from subtle performance degradation to complete device failure. Precision integrated circuits may be more susceptible to damage because very small parametric changes could cause the device not to meet its published specifications.

## 11.7 Glossary

### [TI Glossary](#)

This glossary lists and explains terms, acronyms, and definitions.

## 12 Mechanical, Packaging, and Orderable Information

The following pages include mechanical, packaging, and orderable information. This information is the most current data available for the designated devices. This data is subject to change without notice and revision of this document. For browser-based versions of this data sheet, refer to the left-hand navigation.

**PACKAGING INFORMATION**

Orderable part number	Status (1)	Material type (2)	Package   Pins	Package qty   Carrier	RoHS (3)	Lead finish/ Ball material (4)	MSL rating/ Peak reflow (5)	Op temp (°C)	Part marking (6)
<a href="#">TLV9301IDBVR</a>	Active	Production	SOT-23 (DBV)   5	3000   LARGE T&R	Yes	NIPDAU   SN	Level-1-260C-UNLIM	-40 to 125	T93V
TLV9301IDBVR.A	Active	Production	SOT-23 (DBV)   5	3000   LARGE T&R	Yes	SN	Level-1-260C-UNLIM	-40 to 125	T93V
<a href="#">TLV9301IDCKR</a>	Active	Production	SC70 (DCK)   5	3000   LARGE T&R	Yes	SN	Level-2-260C-1 YEAR	-40 to 125	1FN
TLV9301IDCKR.A	Active	Production	SC70 (DCK)   5	3000   LARGE T&R	Yes	SN	Level-2-260C-1 YEAR	-40 to 125	1FN
<a href="#">TLV9302IDDFR</a>	Active	Production	SOT-23-THIN (DDF)   8	3000   LARGE T&R	Yes	NIPDAU	Level-1-260C-UNLIM	-40 to 125	T93F
TLV9302IDDFR.A	Active	Production	SOT-23-THIN (DDF)   8	3000   LARGE T&R	Yes	NIPDAU	Level-1-260C-UNLIM	-40 to 125	T93F
TLV9302IDDFRG4	Active	Production	SOT-23-THIN (DDF)   8	3000   LARGE T&R	Yes	NIPDAU	Level-1-260C-UNLIM	-40 to 125	T93F
TLV9302IDDFRG4.A	Active	Production	SOT-23-THIN (DDF)   8	3000   LARGE T&R	Yes	NIPDAU	Level-1-260C-UNLIM	-40 to 125	T93F
<a href="#">TLV9302IDGKR</a>	Active	Production	VSSOP (DGK)   8	2500   LARGE T&R	Yes	NIPDAU   SN	Level-1-260C-UNLIM	-40 to 125	(2HAT, T932)
TLV9302IDGKR.A	Active	Production	VSSOP (DGK)   8	2500   LARGE T&R	Yes	NIPDAU	Level-1-260C-UNLIM	-40 to 125	(2HAT, T932)
<a href="#">TLV9302IDR</a>	Active	Production	SOIC (D)   8	2500   LARGE T&R	Yes	NIPDAU	Level-1-260C-UNLIM	-40 to 125	T9302D
TLV9302IDR.A	Active	Production	SOIC (D)   8	2500   LARGE T&R	Yes	NIPDAU	Level-1-260C-UNLIM	-40 to 125	T9302D
TLV9302IDRG4	Active	Production	SOIC (D)   8	2500   LARGE T&R	Yes	NIPDAU	Level-1-260C-UNLIM	-40 to 125	T9302D
TLV9302IDRG4.A	Active	Production	SOIC (D)   8	2500   LARGE T&R	Yes	NIPDAU	Level-1-260C-UNLIM	-40 to 125	T9302D
<a href="#">TLV9302IPWR</a>	Active	Production	TSSOP (PW)   8	2000   LARGE T&R	Yes	NIPDAU	Level-1-260C-UNLIM	-40 to 125	T9302P
TLV9302IPWR.A	Active	Production	TSSOP (PW)   8	2000   LARGE T&R	Yes	NIPDAU	Level-1-260C-UNLIM	-40 to 125	T9302P
<a href="#">TLV9304IDR</a>	Active	Production	SOIC (D)   14	2500   LARGE T&R	Yes	NIPDAU	Level-1-260C-UNLIM	-40 to 125	TLV9304D
TLV9304IDR.A	Active	Production	SOIC (D)   14	2500   LARGE T&R	Yes	NIPDAU	Level-1-260C-UNLIM	-40 to 125	TLV9304D
<a href="#">TLV9304IPWR</a>	Active	Production	TSSOP (PW)   14	2000   LARGE T&R	Yes	SN	Level-2-260C-1 YEAR	-40 to 125	(PTL93PW, T9304PW)
TLV9304IPWR.A	Active	Production	TSSOP (PW)   14	2000   LARGE T&R	Yes	SN	Level-2-260C-1 YEAR	-40 to 125	(PTL93PW, T9304PW)

<sup>(1)</sup> **Status:** For more details on status, see our [product life cycle](#).

<sup>(2)</sup> **Material type:** When designated, preproduction parts are prototypes/experimental devices, and are not yet approved or released for full production. Testing and final process, including without limitation quality assurance, reliability performance testing, and/or process qualification, may not yet be complete, and this item is subject to further changes or possible discontinuation. If available for ordering, purchases will be subject to an additional waiver at checkout, and are intended for early internal evaluation purposes only. These items are sold without warranties of any kind.

<sup>(3)</sup> **RoHS values:** Yes, No, RoHS Exempt. See the [TI RoHS Statement](#) for additional information and value definition.

- (4) **Lead finish/Ball material:** Parts may have multiple material finish options. Finish options are separated by a vertical ruled line. Lead finish/Ball material values may wrap to two lines if the finish value exceeds the maximum column width.
- (5) **MSL rating/Peak reflow:** The moisture sensitivity level ratings and peak solder (reflow) temperatures. In the event that a part has multiple moisture sensitivity ratings, only the lowest level per JEDEC standards is shown. Refer to the shipping label for the actual reflow temperature that will be used to mount the part to the printed circuit board.
- (6) **Part marking:** There may be an additional marking, which relates to the logo, the lot trace code information, or the environmental category of the part.

Multiple part markings will be inside parentheses. Only one part marking contained in parentheses and separated by a "~" will appear on a part. If a line is indented then it is a continuation of the previous line and the two combined represent the entire part marking for that device.

**Important Information and Disclaimer:**The information provided on this page represents TI's knowledge and belief as of the date that it is provided. TI bases its knowledge and belief on information provided by third parties, and makes no representation or warranty as to the accuracy of such information. Efforts are underway to better integrate information from third parties. TI has taken and continues to take reasonable steps to provide representative and accurate information but may not have conducted destructive testing or chemical analysis on incoming materials and chemicals. TI and TI suppliers consider certain information to be proprietary, and thus CAS numbers and other limited information may not be available for release.

In no event shall TI's liability arising out of such information exceed the total purchase price of the TI part(s) at issue in this document sold by TI to Customer on an annual basis.

**OTHER QUALIFIED VERSIONS OF TLV9304 :**

- Automotive : [TLV9304-Q1](#)

NOTE: Qualified Version Definitions:

- Automotive - Q100 devices qualified for high-reliability automotive applications targeting zero defects

**TAPE AND REEL INFORMATION**

**QUADRANT ASSIGNMENTS FOR PIN 1 ORIENTATION IN TAPE**


\*All dimensions are nominal

Device	Package Type	Package Drawing	Pins	SPQ	Reel Diameter (mm)	Reel Width W1 (mm)	A0 (mm)	B0 (mm)	K0 (mm)	P1 (mm)	W (mm)	Pin1 Quadrant
TLV9301IDBVR	SOT-23	DBV	5	3000	178.0	8.4	3.2	3.2	1.4	4.0	8.0	Q3
TLV9301IDCKR	SC70	DCK	5	3000	178.0	8.4	2.25	2.45	1.2	4.0	8.0	Q3
TLV9301IDCKR	SC70	DCK	5	3000	180.0	8.4	2.3	2.5	1.2	4.0	8.0	Q3
TLV9302IDDFR	SOT-23-THIN	DDF	8	3000	180.0	8.4	3.2	3.2	1.4	4.0	8.0	Q3
TLV9302IDDFRG4	SOT-23-THIN	DDF	8	3000	180.0	8.4	3.2	3.2	1.4	4.0	8.0	Q3
TLV9302IDGKR	VSSOP	DGK	8	2500	330.0	12.4	5.3	3.4	1.4	8.0	12.0	Q1
TLV9302IDGKR	VSSOP	DGK	8	2500	330.0	12.4	5.3	3.4	1.4	8.0	12.0	Q1
TLV9302IDR	SOIC	D	8	2500	330.0	12.4	6.4	5.2	2.1	8.0	12.0	Q1
TLV9302IDRG4	SOIC	D	8	2500	330.0	12.4	6.4	5.2	2.1	8.0	12.0	Q1
TLV9302IPWR	TSSOP	PW	8	2000	330.0	12.4	7.0	3.6	1.6	8.0	12.0	Q1
TLV9304IDR	SOIC	D	14	2500	330.0	16.4	6.5	9.0	2.1	8.0	16.0	Q1
TLV9304IPWR	TSSOP	PW	14	2000	330.0	12.4	6.9	5.6	1.6	8.0	12.0	Q1

**TAPE AND REEL BOX DIMENSIONS**


\*All dimensions are nominal

Device	Package Type	Package Drawing	Pins	SPQ	Length (mm)	Width (mm)	Height (mm)
TLV9301IDBVR	SOT-23	DBV	5	3000	208.0	191.0	35.0
TLV9301IDCKR	SC70	DCK	5	3000	208.0	191.0	35.0
TLV9301IDCKR	SC70	DCK	5	3000	210.0	185.0	35.0
TLV9302IDDFR	SOT-23-THIN	DDF	8	3000	210.0	185.0	35.0
TLV9302IDDFRG4	SOT-23-THIN	DDF	8	3000	210.0	185.0	35.0
TLV9302IDGKR	VSSOP	DGK	8	2500	353.0	353.0	32.0
TLV9302IDGKR	VSSOP	DGK	8	2500	367.0	367.0	35.0
TLV9302IDR	SOIC	D	8	2500	353.0	353.0	32.0
TLV9302IDRG4	SOIC	D	8	2500	353.0	353.0	32.0
TLV9302IPWR	TSSOP	PW	8	2000	353.0	353.0	32.0
TLV9304IDR	SOIC	D	14	2500	353.0	353.0	32.0
TLV9304IPWR	TSSOP	PW	14	2000	366.0	364.0	50.0



# EXAMPLE BOARD LAYOUT

DCK0005A

SOT - 1.1 max height

SMALL OUTLINE TRANSISTOR



LAND PATTERN EXAMPLE  
EXPOSED METAL SHOWN  
SCALE:18X



SOLDER MASK DETAILS

4214834/G 11/2024

NOTES: (continued)

- 7. Publication IPC-7351 may have alternate designs.
- 8. Solder mask tolerances between and around signal pads can vary based on board fabrication site.

# EXAMPLE STENCIL DESIGN

DCK0005A

SOT - 1.1 max height

SMALL OUTLINE TRANSISTOR



SOLDER PASTE EXAMPLE  
BASED ON 0.125 THICK STENCIL  
SCALE: 18X

4214834/G 11/2024

NOTES: (continued)

9. Laser cutting apertures with trapezoidal walls and rounded corners may offer better paste release. IPC-7525 may have alternate design recommendations.
10. Board assembly site may have different recommendations for stencil design.

# DDF0008A



# PACKAGE OUTLINE

## SOT-23-THIN - 1.1 mm max height

PLASTIC SMALL OUTLINE



4222047/E 07/2024

### NOTES:

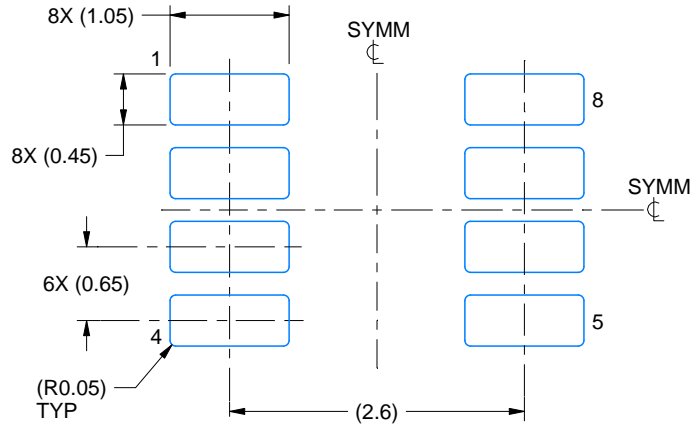
1. All linear dimensions are in millimeters. Any dimensions in parenthesis are for reference only. Dimensioning and tolerancing per ASME Y14.5M.
2. This drawing is subject to change without notice.
3. This dimension does not include mold flash, protrusions, or gate burrs. Mold flash, protrusions, or gate burrs shall not exceed 0.15 mm per side.

# EXAMPLE BOARD LAYOUT

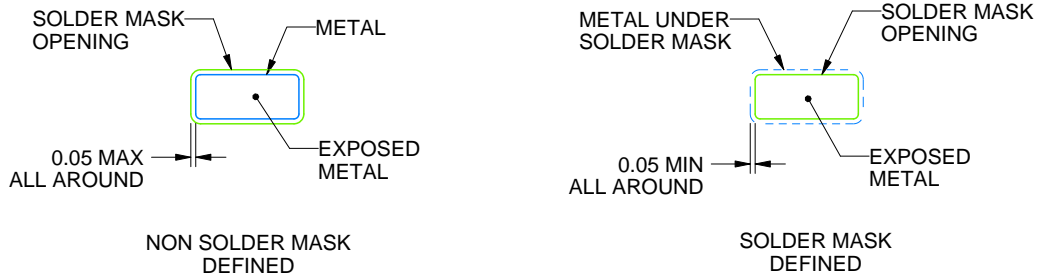
DDF0008A

SOT-23-THIN - 1.1 mm max height

PLASTIC SMALL OUTLINE



LAND PATTERN EXAMPLE  
EXPOSED METAL SHOWN  
SCALE:15X



SOLDER MASK DETAILS

4222047/E 07/2024

NOTES: (continued)

- 4. Publication IPC-7351 may have alternate designs.
- 5. Solder mask tolerances between and around signal pads can vary based on board fabrication site.

# EXAMPLE STENCIL DESIGN

DDF0008A

SOT-23-THIN - 1.1 mm max height

PLASTIC SMALL OUTLINE



SOLDER PASTE EXAMPLE  
BASED ON 0.125 mm THICK STENCIL  
SCALE:15X

4222047/E 07/2024

NOTES: (continued)

6. Laser cutting apertures with trapezoidal walls and rounded corners may offer better paste release. IPC-7525 may have alternate design recommendations.
7. Board assembly site may have different recommendations for stencil design.



D0008A

# PACKAGE OUTLINE

SOIC - 1.75 mm max height

SMALL OUTLINE INTEGRATED CIRCUIT



4214825/C 02/2019

### NOTES:

- Linear dimensions are in inches [millimeters]. Dimensions in parenthesis are for reference only. Controlling dimensions are in inches. Dimensioning and tolerancing per ASME Y14.5M.
- This drawing is subject to change without notice.
- This dimension does not include mold flash, protrusions, or gate burrs. Mold flash, protrusions, or gate burrs shall not exceed .006 [0.15] per side.
- This dimension does not include interlead flash.
- Reference JEDEC registration MS-012, variation AA.

# EXAMPLE BOARD LAYOUT

D0008A

SOIC - 1.75 mm max height

SMALL OUTLINE INTEGRATED CIRCUIT



LAND PATTERN EXAMPLE  
EXPOSED METAL SHOWN  
SCALE:8X



SOLDER MASK DETAILS

4214825/C 02/2019

NOTES: (continued)

6. Publication IPC-7351 may have alternate designs.

7. Solder mask tolerances between and around signal pads can vary based on board fabrication site.

# EXAMPLE STENCIL DESIGN

D0008A

SOIC - 1.75 mm max height

SMALL OUTLINE INTEGRATED CIRCUIT



SOLDER PASTE EXAMPLE  
BASED ON .005 INCH [0.125 MM] THICK STENCIL  
SCALE:8X

4214825/C 02/2019

NOTES: (continued)

8. Laser cutting apertures with trapezoidal walls and rounded corners may offer better paste release. IPC-7525 may have alternate design recommendations.
9. Board assembly site may have different recommendations for stencil design.

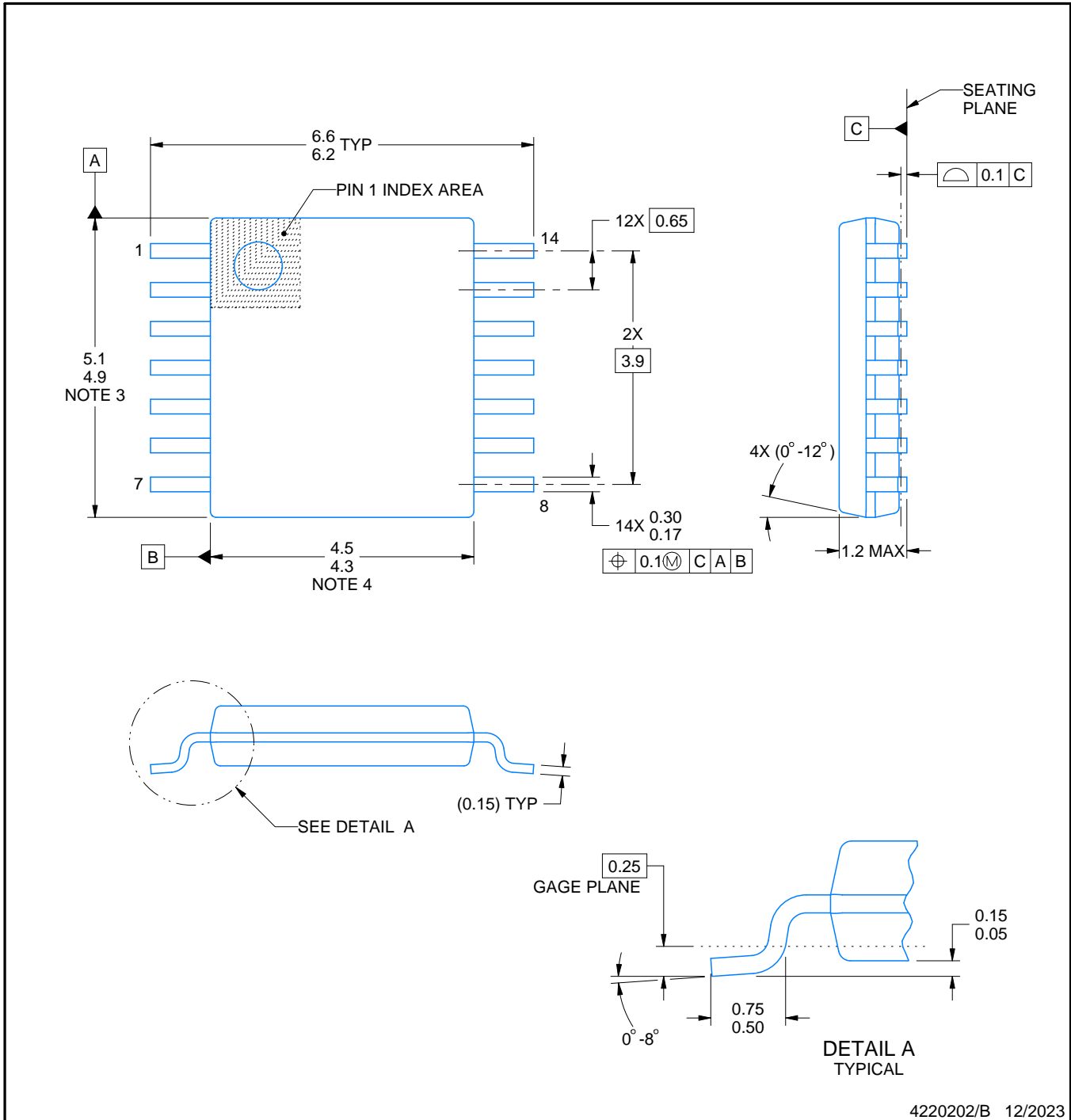
PW0014A



# PACKAGE OUTLINE

TSSOP - 1.2 mm max height

SMALL OUTLINE PACKAGE



**NOTES:**

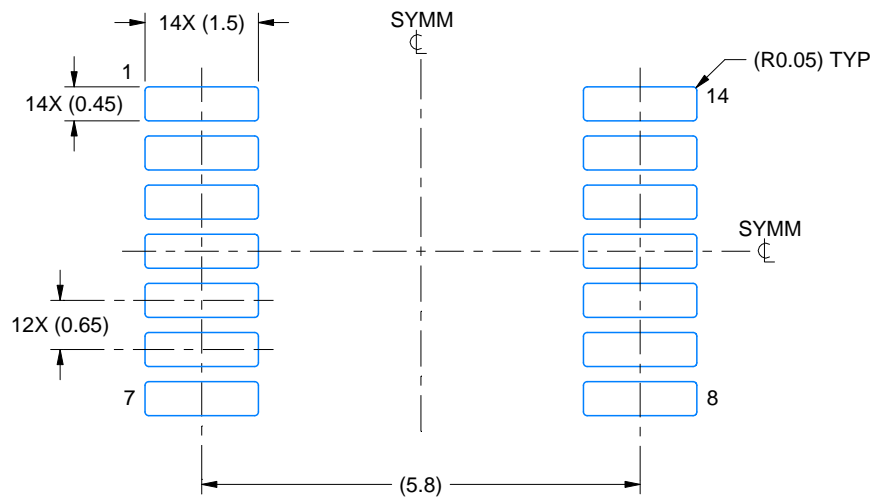
1. All linear dimensions are in millimeters. Any dimensions in parenthesis are for reference only. Dimensioning and tolerancing per ASME Y14.5M.
2. This drawing is subject to change without notice.
3. This dimension does not include mold flash, protrusions, or gate burrs. Mold flash, protrusions, or gate burrs shall not exceed 0.15 mm per side.
4. This dimension does not include interlead flash. Interlead flash shall not exceed 0.25 mm per side.
5. Reference JEDEC registration MO-153.

# EXAMPLE BOARD LAYOUT

PW0014A

TSSOP - 1.2 mm max height

SMALL OUTLINE PACKAGE



LAND PATTERN EXAMPLE  
EXPOSED METAL SHOWN  
SCALE: 10X



4220202/B 12/2023

NOTES: (continued)

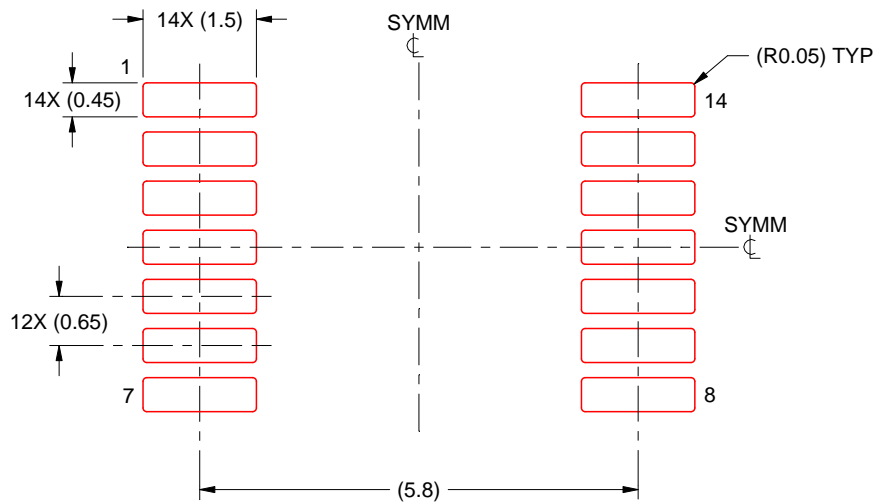
- 6. Publication IPC-7351 may have alternate designs.
- 7. Solder mask tolerances between and around signal pads can vary based on board fabrication site.

# EXAMPLE STENCIL DESIGN

PW0014A

TSSOP - 1.2 mm max height

SMALL OUTLINE PACKAGE



SOLDER PASTE EXAMPLE  
BASED ON 0.125 mm THICK STENCIL  
SCALE: 10X

4220202/B 12/2023

NOTES: (continued)

8. Laser cutting apertures with trapezoidal walls and rounded corners may offer better paste release. IPC-7525 may have alternate design recommendations.
9. Board assembly site may have different recommendations for stencil design.

PW0008A



# PACKAGE OUTLINE

## TSSOP - 1.2 mm max height

SMALL OUTLINE PACKAGE



4221848/A 02/2015

### NOTES:

1. All linear dimensions are in millimeters. Any dimensions in parenthesis are for reference only. Dimensioning and tolerancing per ASME Y14.5M.
2. This drawing is subject to change without notice.
3. This dimension does not include mold flash, protrusions, or gate burrs. Mold flash, protrusions, or gate burrs shall not exceed 0.15 mm per side.
4. This dimension does not include interlead flash. Interlead flash shall not exceed 0.25 mm per side.
5. Reference JEDEC registration MO-153, variation AA.

# EXAMPLE BOARD LAYOUT

PW0008A

TSSOP - 1.2 mm max height

SMALL OUTLINE PACKAGE



LAND PATTERN EXAMPLE  
SCALE:10X



SOLDER MASK DETAILS  
NOT TO SCALE

4221848/A 02/2015

NOTES: (continued)

- 6. Publication IPC-7351 may have alternate designs.
- 7. Solder mask tolerances between and around signal pads can vary based on board fabrication site.

# EXAMPLE STENCIL DESIGN

PW0008A

TSSOP - 1.2 mm max height

SMALL OUTLINE PACKAGE



SOLDER PASTE EXAMPLE  
BASED ON 0.125 mm THICK STENCIL  
SCALE:10X

4221848/A 02/2015

NOTES: (continued)

8. Laser cutting apertures with trapezoidal walls and rounded corners may offer better paste release. IPC-7525 may have alternate design recommendations.
9. Board assembly site may have different recommendations for stencil design.

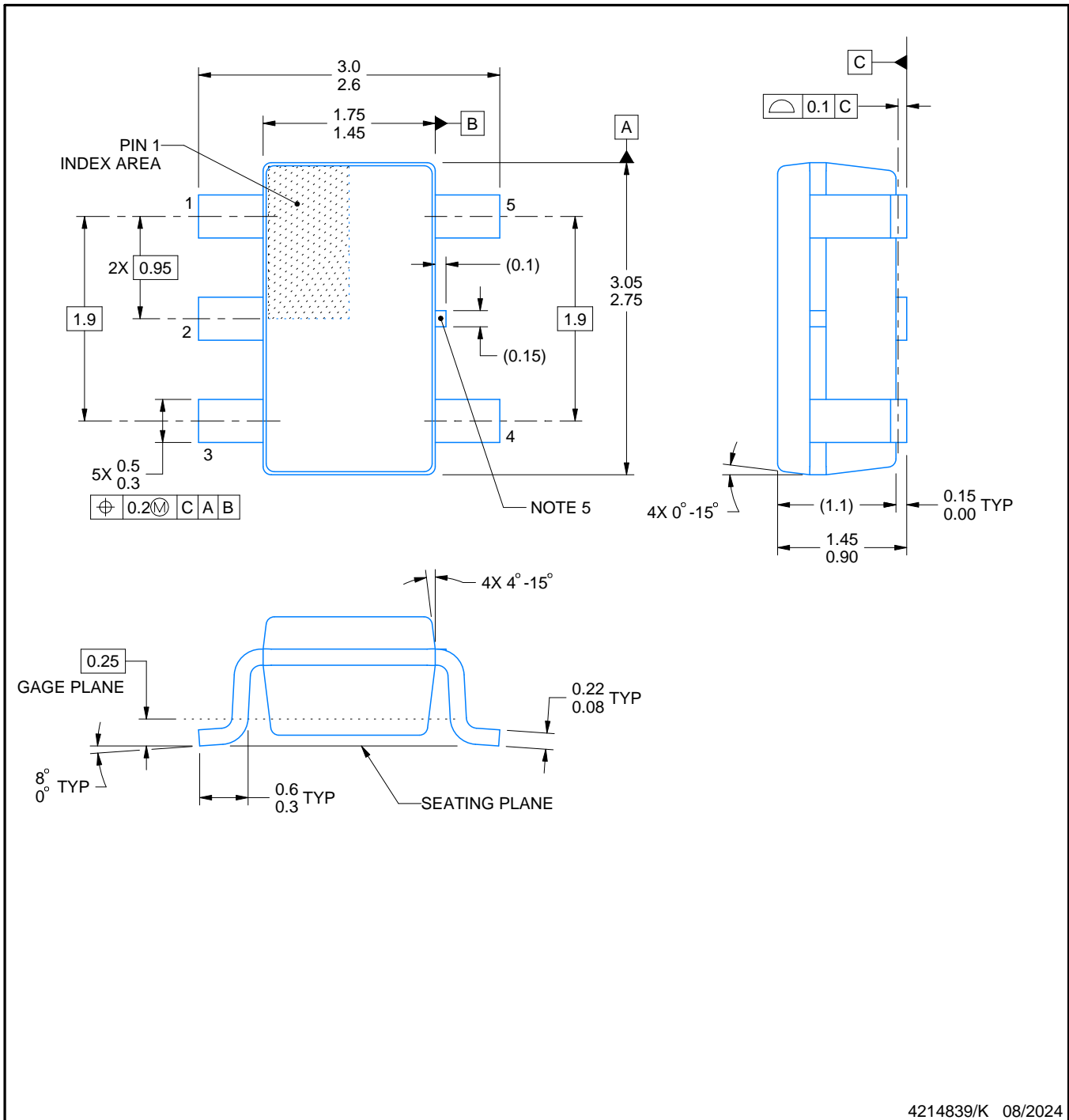
# DBV0005A



# PACKAGE OUTLINE

SOT-23 - 1.45 mm max height

SMALL OUTLINE TRANSISTOR



4214839/K 08/2024

## NOTES:

1. All linear dimensions are in millimeters. Any dimensions in parenthesis are for reference only. Dimensioning and tolerancing per ASME Y14.5M.
2. This drawing is subject to change without notice.
3. Reference JEDEC MO-178.
4. Body dimensions do not include mold flash, protrusions, or gate burrs. Mold flash, protrusions, or gate burrs shall not exceed 0.25 mm per side.
5. Support pin may differ or may not be present.

# EXAMPLE BOARD LAYOUT

DBV0005A

SOT-23 - 1.45 mm max height

SMALL OUTLINE TRANSISTOR



LAND PATTERN EXAMPLE  
EXPOSED METAL SHOWN  
SCALE:15X



SOLDER MASK DETAILS

4214839/K 08/2024

NOTES: (continued)

- 6. Publication IPC-7351 may have alternate designs.
- 7. Solder mask tolerances between and around signal pads can vary based on board fabrication site.

# EXAMPLE STENCIL DESIGN

DBV0005A

SOT-23 - 1.45 mm max height

SMALL OUTLINE TRANSISTOR



SOLDER PASTE EXAMPLE  
BASED ON 0.125 mm THICK STENCIL  
SCALE:15X

4214839/K 08/2024

NOTES: (continued)

8. Laser cutting apertures with trapezoidal walls and rounded corners may offer better paste release. IPC-7525 may have alternate design recommendations.
9. Board assembly site may have different recommendations for stencil design.

# DGK0008A



# PACKAGE OUTLINE

VSSOP - 1.1 mm max height

SMALL OUTLINE PACKAGE



4214862/A 04/2023

**NOTES:**

PowerPAD is a trademark of Texas Instruments.

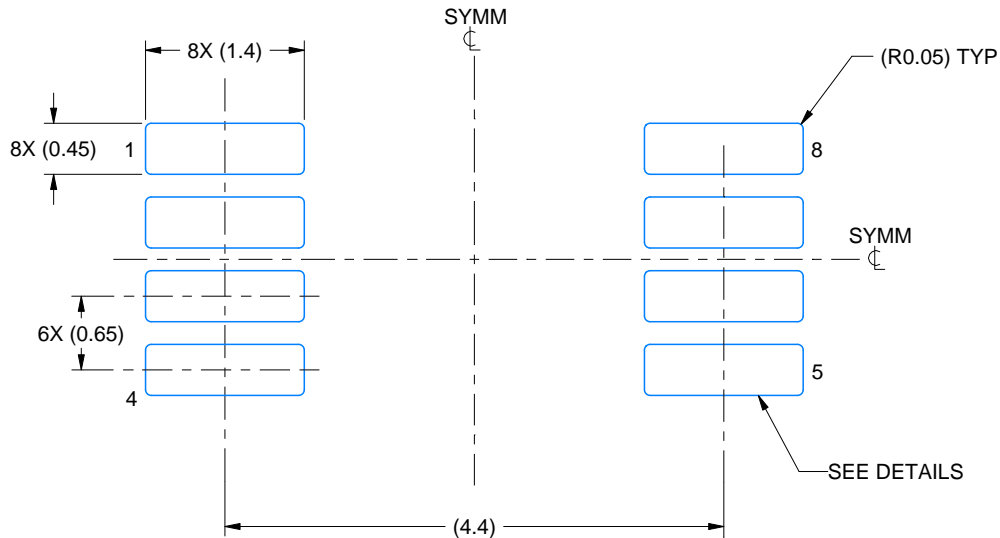
1. All linear dimensions are in millimeters. Any dimensions in parenthesis are for reference only. Dimensioning and tolerancing per ASME Y14.5M.
2. This drawing is subject to change without notice.
3. This dimension does not include mold flash, protrusions, or gate burrs. Mold flash, protrusions, or gate burrs shall not exceed 0.15 mm per side.
4. This dimension does not include interlead flash. Interlead flash shall not exceed 0.25 mm per side.
5. Reference JEDEC registration MO-187.

# EXAMPLE BOARD LAYOUT

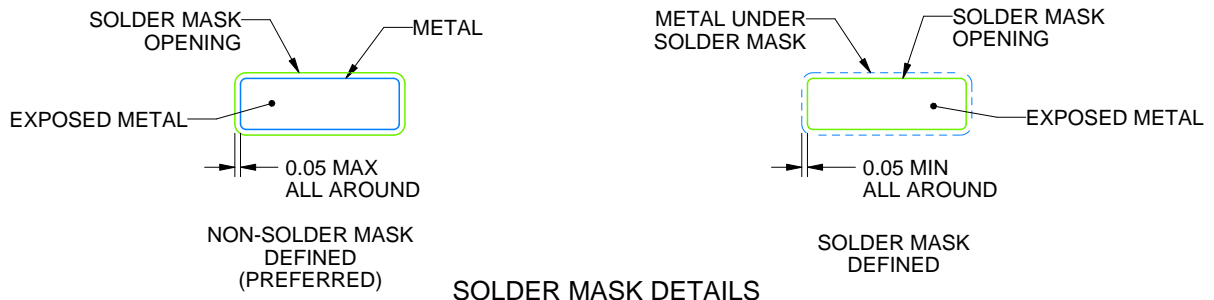
DGK0008A

™ VSSOP - 1.1 mm max height

SMALL OUTLINE PACKAGE



LAND PATTERN EXAMPLE  
EXPOSED METAL SHOWN  
SCALE: 15X



SOLDER MASK DETAILS

4214862/A 04/2023

NOTES: (continued)

6. Publication IPC-7351 may have alternate designs.
7. Solder mask tolerances between and around signal pads can vary based on board fabrication site.
8. Vias are optional depending on application, refer to device data sheet. If any vias are implemented, refer to their locations shown on this view. It is recommended that vias under paste be filled, plugged or tented.
9. Size of metal pad may vary due to creepage requirement.

# EXAMPLE STENCIL DESIGN

DGK0008A

<sup>TM</sup> VSSOP - 1.1 mm max height

SMALL OUTLINE PACKAGE



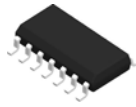
SOLDER PASTE EXAMPLE  
SCALE: 15X

4214862/A 04/2023

NOTES: (continued)

11. Laser cutting apertures with trapezoidal walls and rounded corners may offer better paste release. IPC-7525 may have alternate design recommendations.
12. Board assembly site may have different recommendations for stencil design.

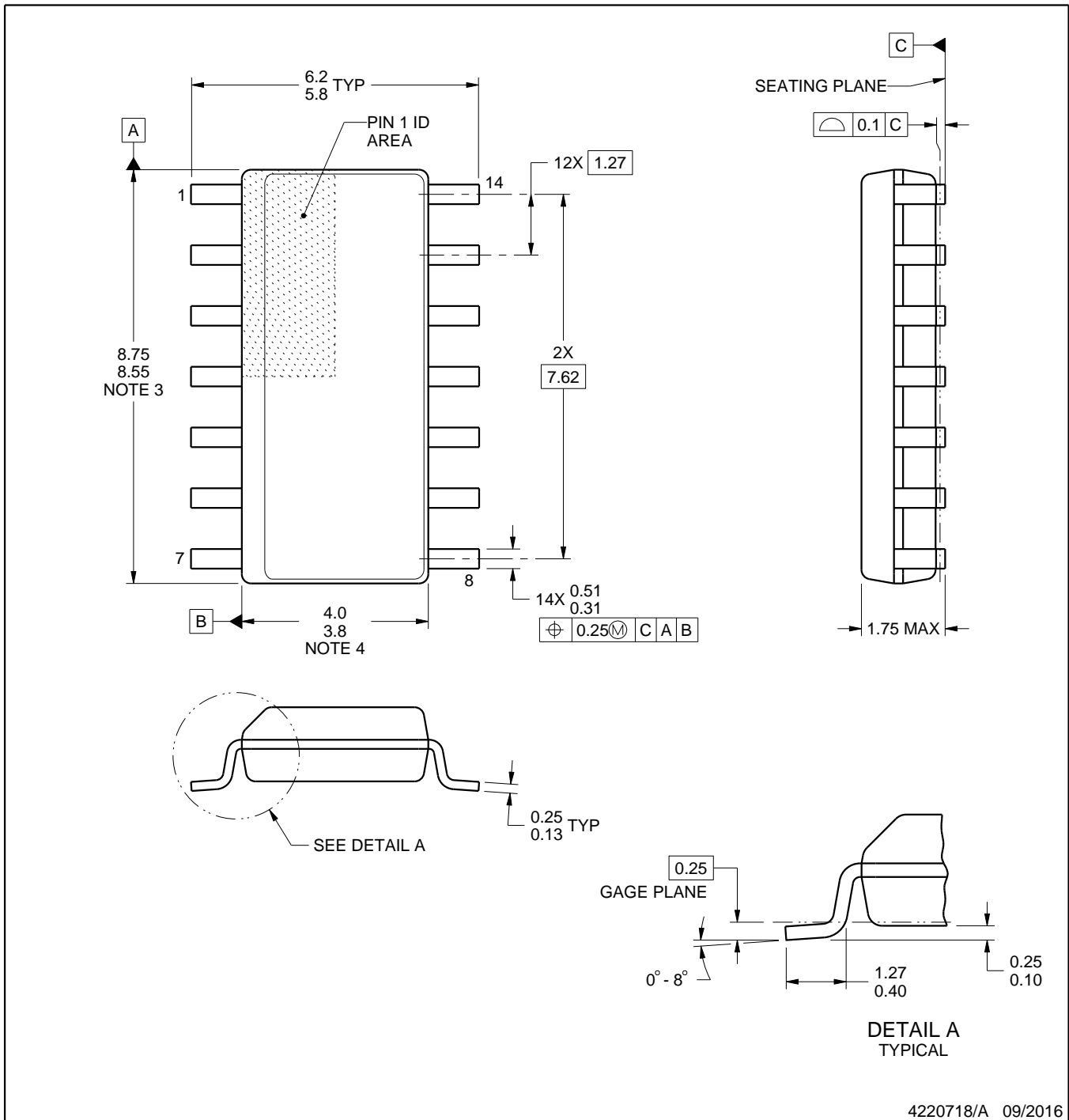
D0014A



# PACKAGE OUTLINE

## SOIC - 1.75 mm max height

SMALL OUTLINE INTEGRATED CIRCUIT



4220718/A 09/2016

NOTES:

1. All linear dimensions are in millimeters. Dimensions in parenthesis are for reference only. Dimensioning and tolerancing per ASME Y14.5M.
2. This drawing is subject to change without notice.
3. This dimension does not include mold flash, protrusions, or gate burrs. Mold flash, protrusions, or gate burrs shall not exceed 0.15 mm, per side.
4. This dimension does not include interlead flash. Interlead flash shall not exceed 0.43 mm, per side.
5. Reference JEDEC registration MS-012, variation AB.

# EXAMPLE BOARD LAYOUT

D0014A

SOIC - 1.75 mm max height

SMALL OUTLINE INTEGRATED CIRCUIT



LAND PATTERN EXAMPLE  
SCALE:8X



SOLDER MASK DETAILS

4220718/A 09/2016

NOTES: (continued)

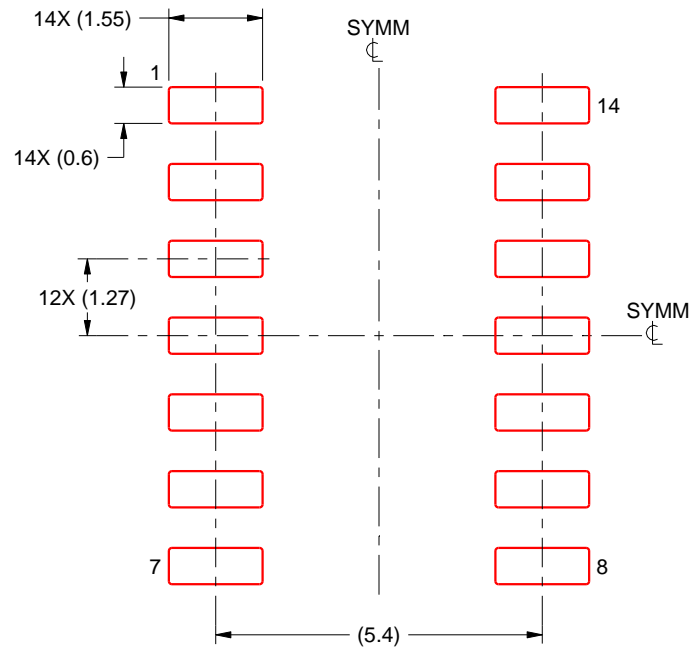
- 6. Publication IPC-7351 may have alternate designs.
- 7. Solder mask tolerances between and around signal pads can vary based on board fabrication site.

# EXAMPLE STENCIL DESIGN

D0014A

SOIC - 1.75 mm max height

SMALL OUTLINE INTEGRATED CIRCUIT



SOLDER PASTE EXAMPLE  
BASED ON 0.125 mm THICK STENCIL  
SCALE:8X

4220718/A 09/2016

NOTES: (continued)

8. Laser cutting apertures with trapezoidal walls and rounded corners may offer better paste release. IPC-7525 may have alternate design recommendations.
9. Board assembly site may have different recommendations for stencil design.

## IMPORTANT NOTICE AND DISCLAIMER

TI PROVIDES TECHNICAL AND RELIABILITY DATA (INCLUDING DATASHEETS), DESIGN RESOURCES (INCLUDING REFERENCE DESIGNS), APPLICATION OR OTHER DESIGN ADVICE, WEB TOOLS, SAFETY INFORMATION, AND OTHER RESOURCES "AS IS" AND WITH ALL FAULTS, AND DISCLAIMS ALL WARRANTIES, EXPRESS AND IMPLIED, INCLUDING WITHOUT LIMITATION ANY IMPLIED WARRANTIES OF MERCHANTABILITY, FITNESS FOR A PARTICULAR PURPOSE OR NON-INFRINGEMENT OF THIRD PARTY INTELLECTUAL PROPERTY RIGHTS.

These resources are intended for skilled developers designing with TI products. You are solely responsible for (1) selecting the appropriate TI products for your application, (2) designing, validating and testing your application, and (3) ensuring your application meets applicable standards, and any other safety, security, regulatory or other requirements.

These resources are subject to change without notice. TI grants you permission to use these resources only for development of an application that uses the TI products described in the resource. Other reproduction and display of these resources is prohibited. No license is granted to any other TI intellectual property right or to any third party intellectual property right. TI disclaims responsibility for, and you fully indemnify TI and its representatives against any claims, damages, costs, losses, and liabilities arising out of your use of these resources.

TI's products are provided subject to [TI's Terms of Sale](#), [TI's General Quality Guidelines](#), or other applicable terms available either on [ti.com](http://ti.com) or provided in conjunction with such TI products. TI's provision of these resources does not expand or otherwise alter TI's applicable warranties or warranty disclaimers for TI products. Unless TI explicitly designates a product as custom or customer-specified, TI products are standard, catalog, general purpose devices.

TI objects to and rejects any additional or different terms you may propose.

Copyright © 2026, Texas Instruments Incorporated

Last updated 10/2025