

TPS22810, 2.7-18-V, 79-mΩ On-Resistance Load Switch With Thermal Protection

1 Features

- Integrated Single Channel Load Switch
- Ambient Operating Temperature: -40°C to $+105^{\circ}\text{C}$
 - SOT23-6 (DBV): 2-A Maximum Continuous Current¹
 - WSON (DRV): 3-A Maximum Continuous Current¹
- Input Voltage Range: 2.7 V to 18 V
- Absolute Maximum Input Voltage: 20 V
- On-Resistance (R_{ON})
 - $R_{\text{ON}} = 79\text{ m}\Omega$ (typical) at $V_{\text{IN}} = 12\text{ V}$
- Quiescent Current
 - $62\text{ }\mu\text{A}$ (typical) at $V_{\text{IN}} = 12\text{ V}$
- Shutdown Current
 - 500 nA (typical) at $V_{\text{IN}} = 12\text{ V}$
- Thermal Shutdown
- Undervoltage Lock-Out (UVLO)
- Adjustable Quick Output Discharge (QOD)
- Configurable Rise Time With CT Pin
- SOT23-6 Package
 - 2.9-mm \times 2.8-mm, 0.95-mm Pitch
1.45-mm Height (DBV)
- WSON Package
 - 2-mm \times 2-mm, 0.65-mm Pitch
0.75-mm Height (DRV)
- ESD Performance Tested per JESD 22
 - $\pm 2\text{-kV}$ HBM and $\pm 1\text{-kV}$ CDM

(1) Thermal performance must be considered

2 Applications

- HD TV
- Industrial Systems
- Set Top Box
- Surveillance systems

3 Description

The TPS22810 is a single channel load switch with configurable rise time and with an integrated quick output discharge (QOD). In addition, the device features thermal shutdown to protect the device against high junction temperature. Because of this, safe operating area of the device is inherently ensured. The device contains an N-channel MOSFET that can operate over an input voltage range of 2.7 V to 18 V. SOT23-5 (DBV) package can support a maximum current of 2 A. WSON (DRV) package can support a maximum current of 3 A. The switch is controlled by an on and off input, which is capable of interfacing directly with low-voltage control signals.

The configurable rise time of the device greatly reduces inrush current caused by large bulk load capacitances, thereby reducing or eliminating power supply droop. Undervoltage lock-out is used to turn off the device if the VIN voltage drops below a threshold value, ensuring that the downstream circuitry is not damaged by being supplied by a voltage lower than intended. The configurable QOD pin controls the fall time of the device to allow design flexibility for power down.

The TPS22810 is available in a leaded, SOT-23 package (DBV) which allows to visually inspect solder joints, as well as a WSON package (DRV). The device is characterized for operation over the free-air temperature range of -40°C to $+105^{\circ}\text{C}$.

Device Information⁽¹⁾

PART NUMBER	PACKAGE	BODY SIZE (NOM)
TPS22810	SOT-23 (6)	2.90 mm \times 2.80 mm
	WSON (6)	2.00 mm \times 2.00 mm

(1) For all available packages, see the orderable addendum at the end of the data sheet.

Simplified Schematic

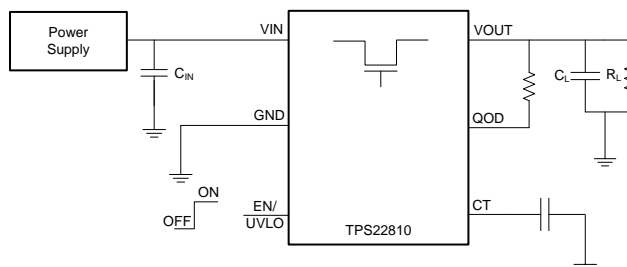

Copyright © 2016, Texas Instruments Incorporated



Table of Contents

1 Features	1	10 Application and Implementation	18
2 Applications	1	10.1 Application Information.....	18
3 Description	1	10.2 ON and OFF Control.....	18
4 Revision History	2	10.3 Input Capacitor (Optional).....	18
5 Device Comparison Table	3	10.4 Output Capacitor (Optional).....	18
6 Pin Configuration and Functions	3	10.5 Typical Application	18
7 Specifications	4	11 Power Supply Recommendations	23
7.1 Absolute Maximum Ratings	4	12 Layout	24
7.2 ESD Ratings	4	12.1 Layout Guidelines	24
7.3 Recommended Operating Conditions.....	4	12.2 Layout Example	24
7.4 Thermal Information	4	12.3 Thermal Considerations.....	24
7.5 Electrical Characteristics.....	5	13 Device and Documentation Support	25
7.6 Switching Characteristics	7	13.1 Device Support.....	25
7.7 Typical DC Characteristics	8	13.2 Documentation Support	25
7.8 Typical AC Characteristics.....	9	13.3 Receiving Notification of Documentation Updates	25
8 Parameter Measurement Information	11	13.4 Community Resources.....	25
9 Detailed Description	12	13.5 Trademarks	25
9.1 Overview	12	13.6 Electrostatic Discharge Caution.....	25
9.2 Functional Block Diagram	13	13.7 Glossary.....	25
9.3 Feature Description.....	13	14 Mechanical, Packaging, and Orderable	
9.4 Device Functional Modes.....	17	Information	25

4 Revision History

Changes from Revision B (May 2017) to Revision C	Page
• Changed Rise time can be calculated by multiplying to Rise time can be calculated by dividing in the <i>Feature Description</i> Section 9.3.4 <i>Adjustable Rise Time (CT)</i>	17

Changes from Revision A (December2016) to Revision B	Page
• Added WSON (DRV) current information in the <i>Features</i> , <i>Description</i> section and <i>Recommended Operating Conditions</i> table	1
• Added WSON (DRV) package	1

Changes from Original (December 2016) to Revision A	Page
• Deleted I_{MAX} and I_{PLS} from the <i>Absolute Maximum Ratings</i> table	1
• Deleted I_{MAX} and I_{PLS} from the <i>Absolute Maximum Ratings</i> table	4
• Changed the Quiescent current MAX value From: 70 μ A To: 80 μ A in the <i>Electrical Characteristics</i> table	5
• Changed the Quiescent current MAX value for $V_{IN} = 2.7$ V From: 60 μ A To: 70 μ A in the <i>Electrical Characteristics</i> table	5
• Changed the Shutdown current MAX value From: 2.25 μ A To: 2.3 μ A in the <i>Electrical Characteristics</i> table.....	5

5 Device Comparison Table

DEVICE	R _{ON} at 12 V	Package	QUICK OUTPUT DISCHARGE	T _A	MAXIMUM OUTPUT CURRENT	ENABLE
TPS22810	79 mΩ	DBV	Configurable	105°C	2 A	Active High
TPS22810	79 mΩ	DRV	Configurable	105°C	3 A	Active High

6 Pin Configuration and Functions

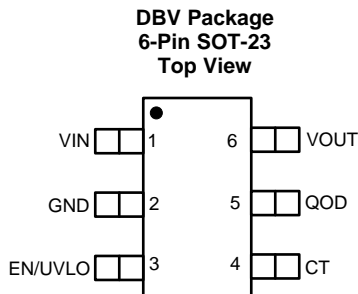

Pin Functions

NAME	PIN NO,		I/O	DESCRIPTION
	SOT23	WSON		
CT	4	3	O	Switch slew rate control. Can be left floating
EN/UVLO	3	5	I	Active high switch control input and UVLO adjustment. Do not leave floating
GND	2	4	—	Device ground
QOD	5	2	O	Quick Output Discharge pin. This functionality can be enabled in one of three ways. <ul style="list-style-type: none"> Placing an external resistor between VOUT and QOD Tying QOD directly to VOUT and using the internal resistor value (R_{PD}) Disabling QOD by leaving pin floating See the Quick Output Discharge (QOD) for more information
VIN	1	6	I	Switch input. Place ceramic bypass capacitor(s) between this pin and GND
VOUT	6	1	O	Switch output

7 Specifications

7.1 Absolute Maximum Ratings

Over operating free-air temperature range (unless otherwise noted) ⁽¹⁾ ⁽²⁾

		MIN	MAX	UNIT
V _{IN}	Input voltage	-0.3	20	V
V _{OUT}	Output voltage	-0.3	min(V _{IN} + 0.3, 20)	V
V _{EN/UVLO}	EN/UVLO voltage	-0.3	20	V
T _J	Maximum junction temperature		150	°C
T _{stg}	Storage temperature	-65	150	°C

- (1) Stresses beyond those listed under *Absolute Maximum Ratings* may cause permanent damage to the device. These are stress ratings only, which do not imply functional operation of the device at these or any other conditions beyond those indicated under *Recommended Operating Conditions*. Exposure to absolute-maximum-rated conditions for extended periods may affect device reliability.
- (2) All voltage values are with respect to network ground terminal.

7.2 ESD Ratings

			VALUE	UNIT
V _(ESD)	Electrostatic discharge	Human-body model (HBM), per ANSI/ESDA/JEDEC JS-001 ⁽¹⁾	±2000	V
		Charged-device model (CDM), per JEDEC specification JESD22-C101 ⁽²⁾	±1000	

- (1) JEDEC document JEP155 states that 500-V HBM allows safe manufacturing with a standard ESD control process. Manufacturing with less than 500-V HBM is possible with the necessary precautions.
- (2) JEDEC document JEP157 states that 250-V CDM allows safe manufacturing with a standard ESD control process. Manufacturing with less than 250-V CDM is possible with the necessary precautions.

7.3 Recommended Operating Conditions

Over operating free-air temperature range (unless otherwise noted)

		MIN	MAX	UNIT
V _{IN}	Input voltage	2.7	18	V
V _{EN/UVLO}	EN/UVLO voltage	0	18	V
V _{OUT}	Output voltage		V _{IN}	V
I _{MAX}	Maximum continuous switch current, T _A = 65°C (DBV)		2	A
	Maximum continuous switch current, T _A = 65°C (DRV)		3	
T _A	Operating free-air temperature ⁽¹⁾	-40	105	°C
C _{IN}	Input capacitor	1 ⁽²⁾		µF

- (1) In applications where high power dissipation and/or poor package thermal resistance is present, the maximum ambient temperature may have to be derated. Maximum ambient temperature [T_{A(MAX)}] is dependent on the maximum operating junction temperature [T_{J(MAX)}], the maximum power dissipation of the device in the application [P_{D(MAX)}], and the junction-to-ambient thermal resistance of the part/package in the application (θ_{JA}), as given by the following equation: T_{A(MAX)} = T_{J(MAX)} - (θ_{JA} × P_{D(MAX)}).
- (2) See the [Detailed Description](#) section.

7.4 Thermal Information

THERMAL METRIC ⁽¹⁾	TPS22810		UNIT	
	DBV (SOT23)	DRV (WSON)		
	6 PINS	6 PINS		
R _{θJA}	Junction-to-ambient thermal resistance	182	74.6	°C/W
R _{θJC(top)}	Junction-to-case (top) thermal resistance	127.2	80.3	°C/W
R _{θJB}	Junction-to-board thermal resistance	16.9	44.3	°C/W
ψ _{JT}	Junction-to-top characterization parameter	26.4	3.2	°C/W
ψ _{JB}	Junction-to-board characterization parameter	36.3	44.6	°C/W

- (1) For more information about traditional and new thermal metrics, see the [Semiconductor and IC Package Thermal Metrics](#) application report.

7.5 Electrical Characteristics

Unless otherwise noted, the specification in the following table applies over the following ambient operating temperature $-40^{\circ}\text{C} \leq T_A \leq +105^{\circ}\text{C}$. Typical values are for $T_A = 25^{\circ}\text{C}$.

PARAMETER	TEST CONDITIONS	T_A	MIN	TYP	MAX	UNIT
$I_{Q, VIN}$ Quiescent current	$V = 18\text{ V}, I = 0\text{ A}$	$V_{IN} = 18\text{ V}$	$-40^{\circ}\text{C to }+85^{\circ}\text{C}$	62	80	μA
			$-40^{\circ}\text{C to }+105^{\circ}\text{C}$		85	
		$V_{IN} = 12\text{ V}$	$-40^{\circ}\text{C to }+85^{\circ}\text{C}$	62	80	
			$-40^{\circ}\text{C to }+105^{\circ}\text{C}$		85	
		$V_{IN} = 5\text{ V}$	$-40^{\circ}\text{C to }+85^{\circ}\text{C}$	59	80	
			$-40^{\circ}\text{C to }+105^{\circ}\text{C}$		85	
		$V_{IN} = 3.3\text{ V}$	$-40^{\circ}\text{C to }+85^{\circ}\text{C}$	53	80	
			$-40^{\circ}\text{C to }+105^{\circ}\text{C}$		85	
		$V_{IN} = 2.7\text{ V}$	$-40^{\circ}\text{C to }+85^{\circ}\text{C}$	49	70	
			$-40^{\circ}\text{C to }+105^{\circ}\text{C}$		85	
$I_{SD, VIN}$ Shutdown current	$V_{ON} = 0\text{ V}, V_{OUT} = 0\text{ V}$	$V_{IN} = 18\text{ V}$	$-40^{\circ}\text{C to }+85^{\circ}\text{C}$	0.5	2.3	μA
			$-40^{\circ}\text{C to }+105^{\circ}\text{C}$		3.8	
		$V_{IN} = 12\text{ V}$	$-40^{\circ}\text{C to }+85^{\circ}\text{C}$	0.5	2.3	
			$-40^{\circ}\text{C to }+105^{\circ}\text{C}$		3.8	
		$V_{IN} = 5\text{ V}$	$-40^{\circ}\text{C to }+85^{\circ}\text{C}$	0.5	2.3	
			$-40^{\circ}\text{C to }+105^{\circ}\text{C}$		3.8	
		$V_{IN} = 3.3\text{ V}$	$-40^{\circ}\text{C to }+85^{\circ}\text{C}$	0.5	2.3	
			$-40^{\circ}\text{C to }+105^{\circ}\text{C}$		3.8	
		$V_{IN} = 2.7\text{ V}$	$-40^{\circ}\text{C to }+85^{\circ}\text{C}$	0.5	2.3	
			$-40^{\circ}\text{C to }+105^{\circ}\text{C}$		3.8	
$I_{EN/UVLO}$ EN/UVLO pin input leakage current	$V_{IN} = 18\text{ V}, I_{OUT} = 0\text{ A}$	$-40^{\circ}\text{C to }+105^{\circ}\text{C}$			0.1	μA
V_{UVR} VIN UVLO threshold, rising		$-40^{\circ}\text{C to }+105^{\circ}\text{C}$	2	2.54	2.62	V
V_{UVhyst} VIN UVLO hysteresis		$-40^{\circ}\text{C to }+105^{\circ}\text{C}$		5%		
V_{ENR} EN threshold voltage, rising		$-40^{\circ}\text{C to }+105^{\circ}\text{C}$	1.13	1.23	1.3	V
V_{ENF} EN threshold voltage, falling		$-40^{\circ}\text{C to }+105^{\circ}\text{C}$	1.08	1.13	1.18	V
V_{SHUTF} EN threshold voltage for low IQ shutdown		$-40^{\circ}\text{C to }+105^{\circ}\text{C}$	0.5	0.75	0.9	V

Electrical Characteristics (continued)

Unless otherwise noted, the specification in the following table applies over the following ambient operating temperature $-40^{\circ}\text{C} \leq T_A \leq +105^{\circ}\text{C}$. Typical values are for $T_A = 25^{\circ}\text{C}$.

PARAMETER		TEST CONDITIONS	T_A	MIN	TYP	MAX	UNIT	
R_{ON}	On-resistance	$V_{IN} = 18\text{ V}, I_{OUT} = -200\text{ mA}$	25°C		79	86	mΩ	
			-40°C to +85°C			105		
			-40°C to +105°C			115		
		$V_{IN} = 12\text{ V}, I_{OUT} = -200\text{ mA}$	25°C		79	86		
			-40°C to +85°C			105		
			-40°C to +105°C			115		
		$V_{IN} = 9\text{ V}, I_{OUT} = -200\text{ mA}$	25°C		79	86		
			-40°C to +85°C			105		
			-40°C to +105°C			115		
		$V_{IN} = 5\text{ V}, I_{OUT} = -200\text{ mA}$	25°C		79	86		
			-40°C to +85°C			105		
			-40°C to +105°C			115		
		$V_{IN} = 3.3\text{ V}, I_{OUT} = -200\text{ mA}$	25°C		83	92		
			-40°C to +85°C			115		
			-40°C to +105°C			125		
$V_{IN} = 2.7\text{ V}, I_{OUT} = -200\text{ mA}$	25°C		86	95				
	-40°C to +85°C			120				
	-40°C to +105°C			130				
R_{PD}	Output pull down resistance	$V_{IN} = V_{OUT} = 18\text{ V}, V_{EN/UVLO} = 0\text{ V}$	-40°C to +105°C		290	350	Ω	
			$V_{IN} = V_{OUT} = 12\text{ V}, V_{EN/UVLO} = 0\text{ V}$	-40°C to +105°C		265		350
			$V_{IN} = V_{OUT} = 5\text{ V}, V_{EN/UVLO} = 0\text{ V}$	-40°C to +105°C		250		400
TS	Thermal shutdown	Threshold, $V_{IN} = 18\text{ V}$	-40°C to +105°C		160		°C	
TSHDN Hyst	Thermal shutdown hysteresis	TSD hysteresis, $V_{IN} = 18\text{ V}$	-40°C to +105°C		30		°C	

7.6 Switching Characteristics

Refer to the timing test circuit in [Figure 16](#) (unless otherwise noted) for references to external components used for the test condition in the switching characteristics table. Switching characteristics shown below are only valid for the power-up sequence where VIN is already in steady state condition before the EN/UVLO pin is asserted high.

PARAMETER		TEST CONDITIONS	MIN	TYP	MAX	UNIT
V_{IN} = 18 V, V_{EN/UVLO} = 5 V, T_A = 25 °C (unless otherwise noted)						
t _{ON}	Turnon time	R _L = 10 Ω, C _{IN} = 1 μF, C _L = 0.1 μF, CT = 2200 pF		520		μs
t _{OFF}	Turnoff time	R _L = 10 Ω, C _{IN} = 1 μF, C _L = 0.1 μF, CT = 2200 pF		3.3		
t _R	V _{OUT} rise time	R _L = 10 Ω, C _{IN} = 1 μF, C _L = 0.1 μF, CT = 2200 pF		700		
t _F	V _{OUT} fall time	R _L = 10 Ω, C _{IN} = 1 μF, C _L = 0.1 μF, CT = 2200 pF		2		
t _D	Delay time	R _L = 10 Ω, C _{IN} = 1 μF, C _L = 0.1 μF, CT = 2200 pF		180		
V_{IN} = 12 V, V_{EN/UVLO} = 5 V, T_A = 25 °C (unless otherwise noted)						
t _{ON}	Turnon time	R _L = 10 Ω, C _{IN} = 1 μF, C _L = 0.1 μF, CT = 2200 pF		380		μs
t _{OFF}	Turnoff time	R _L = 10 Ω, C _{IN} = 1 μF, C _L = 0.1 μF, CT = 2200 pF		3.3		
t _R	V _{OUT} rise time	R _L = 10 Ω, C _{IN} = 1 μF, C _L = 0.1 μF, CT = 2200 pF		460		
t _F	V _{OUT} fall time	R _L = 10 Ω, C _{IN} = 1 μF, C _L = 0.1 μF, CT = 2200 pF		2		
t _D	ON delay time	R _L = 10 Ω, C _{IN} = 1 μF, C _L = 0.1 μF, CT = 2200 pF		150		
V_{IN} = 3.3 V, V_{EN/UVLO} = 5 V, T_A = 25 °C (unless otherwise noted)						
t _{ON}	Turnon time	R _L = 10 Ω, C _{IN} = 1 μF, C _L = 0.1 μF, CT = 2200 pF		185		μs
t _{OFF}	Turnoff time	R _L = 10 Ω, C _{IN} = 1 μF, C _L = 0.1 μF, CT = 2200 pF		3.3		
t _R	V _{OUT} rise time	R _L = 10 Ω, C _{IN} = 1 μF, C _L = 0.1 μF, CT = 2200 pF		120		
t _F	V _{OUT} fall time	R _L = 10 Ω, C _{IN} = 1 μF, C _L = 0.1 μF, CT = 2200 pF		2		
t _D	ON delay time	R _L = 10 Ω, C _{IN} = 1 μF, C _L = 0.1 μF, CT = 2200 pF		130		

7.7 Typical DC Characteristics

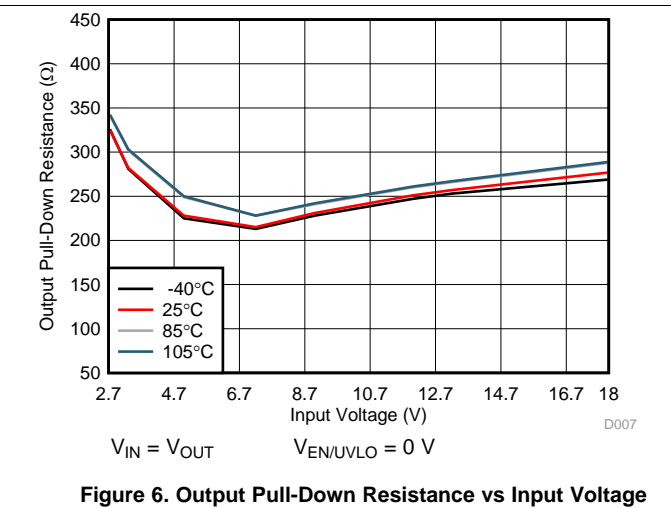
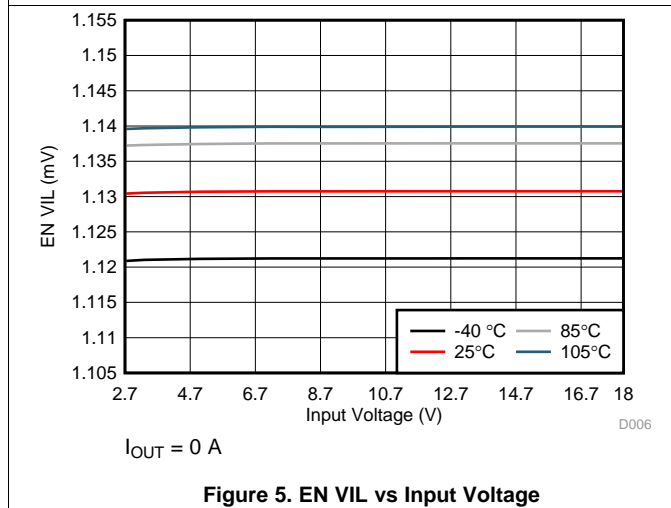
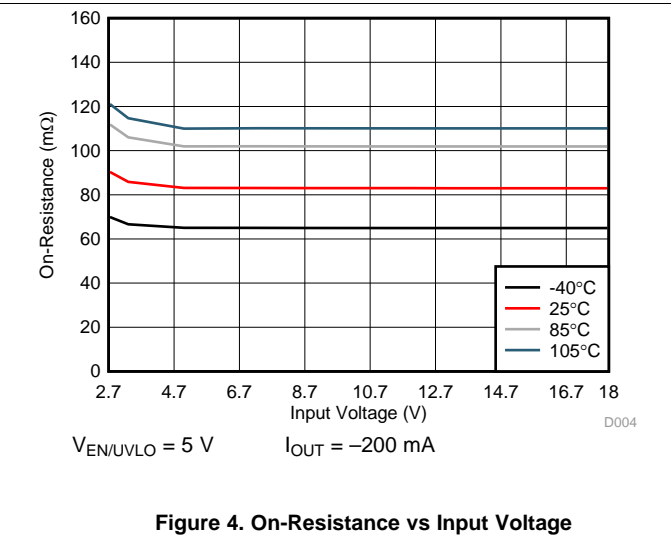
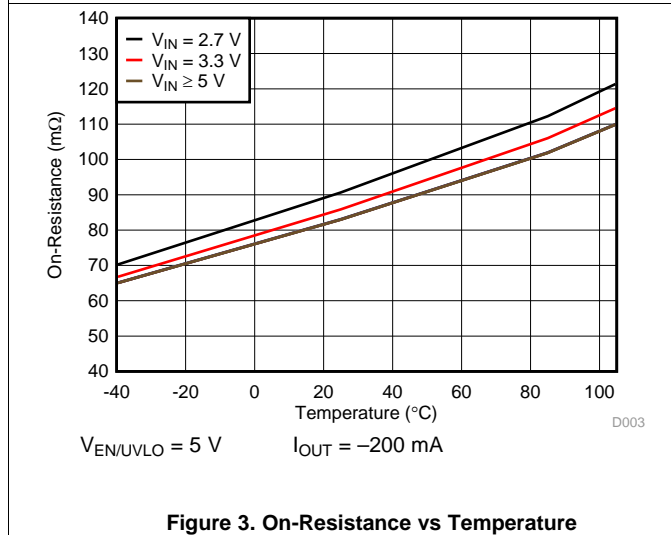

7.8 Typical AC Characteristics

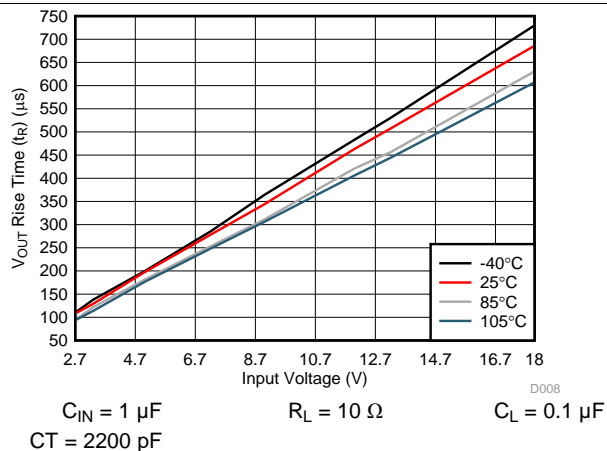

Figure 7. V_{OUT} Rise Time (t_R) vs Input Voltage

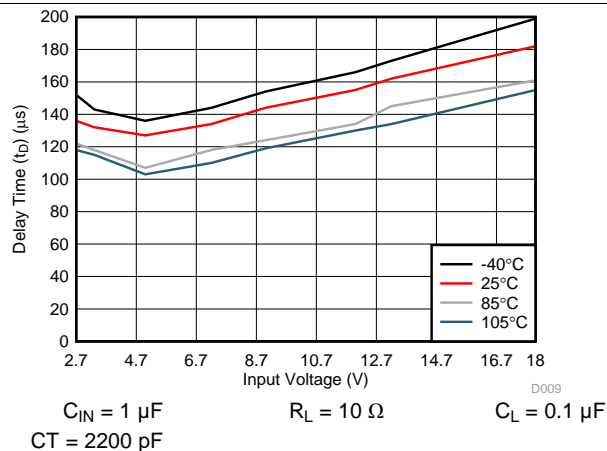

Figure 8. Delay Time (t_D) vs Input Voltage

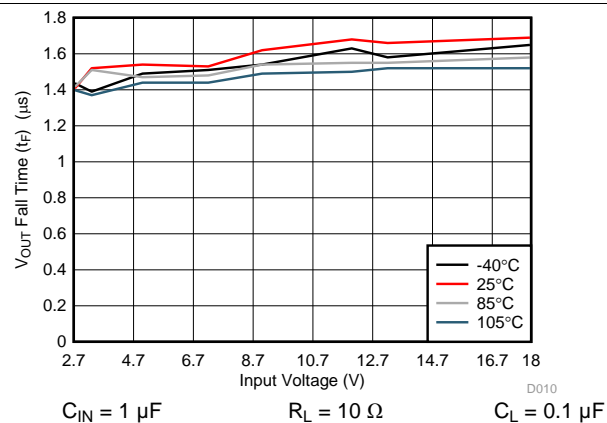

Figure 9. V_{OUT} Fall Time (t_F) vs Input Voltage

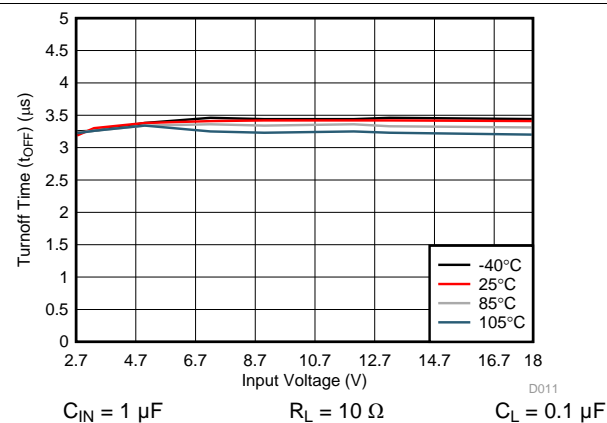

Figure 10. Turnoff Time (t_{OFF}) vs Input Voltage

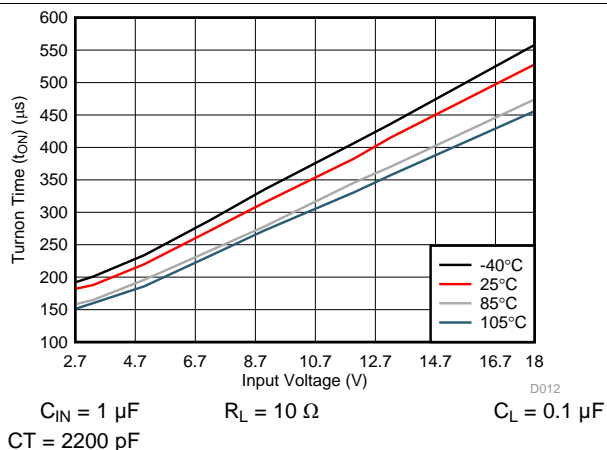

Figure 11. Turnon Time (t_{ON}) vs Input Voltage

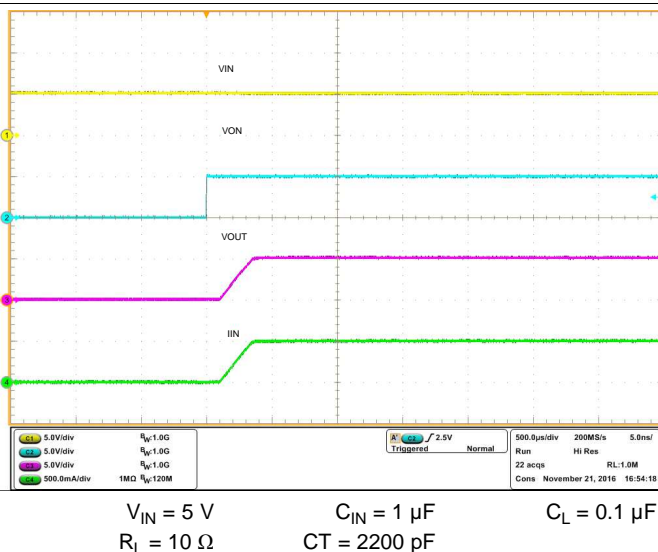
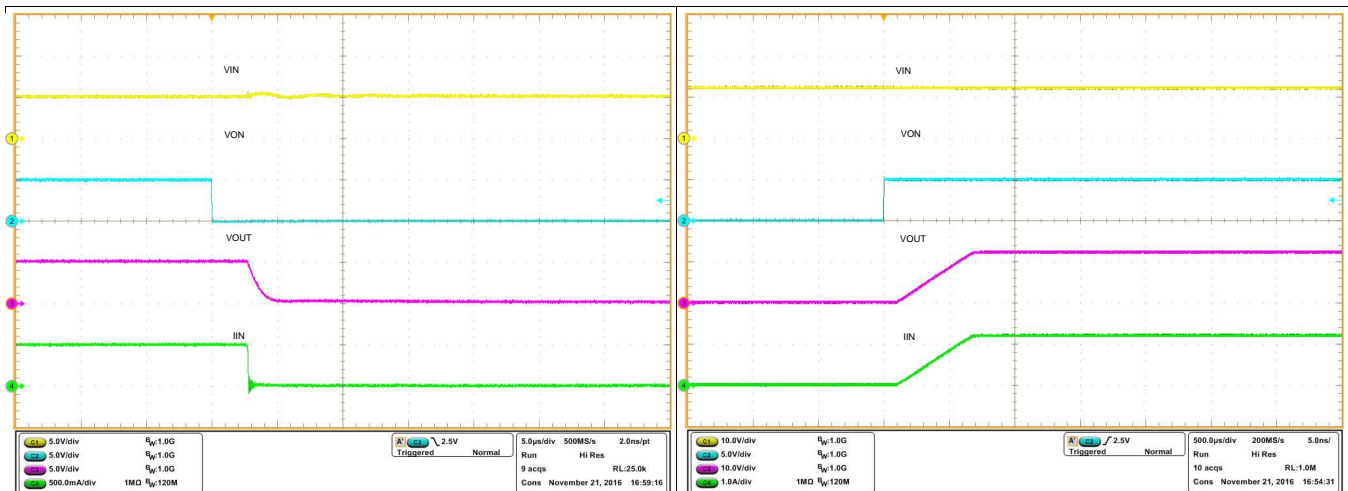

Figure 12. Rise Time t_R at $V_{IN} = 5\text{ V}$

Typical AC Characteristics (continued)



$V_{IN} = 5\text{ V}$ $C_{IN} = 1\text{ }\mu\text{F}$ $C_L = 0.1\text{ }\mu\text{F}$
 $R_L = 10\text{ }\Omega$ QOD = Open

Figure 13. Fall Time t_F at $V_{IN} = 5\text{ V}$

$V_{IN} = 12\text{ V}$ $C_{IN} = 1\text{ }\mu\text{F}$ $C_L = 0.1\text{ }\mu\text{F}$
 $R_L = 10\text{ }\Omega$ CT = 2200 pF

Figure 14. Rise Time t_R at $V_{IN} = 12\text{ V}$

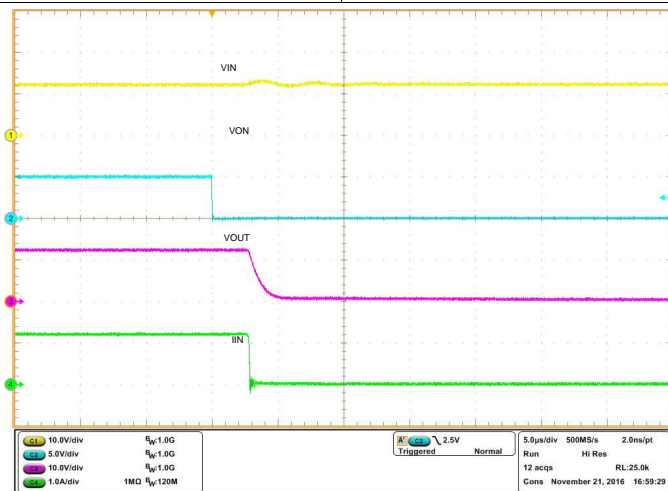

$V_{IN} = 12\text{ V}$ $C_{IN} = 1\text{ }\mu\text{F}$ $C_L = 0.1\text{ }\mu\text{F}$
 $R_L = 10\text{ }\Omega$ QOD = Open

Figure 15. Fall Time t_F at $V_{IN} = 12\text{ V}$

8 Parameter Measurement Information

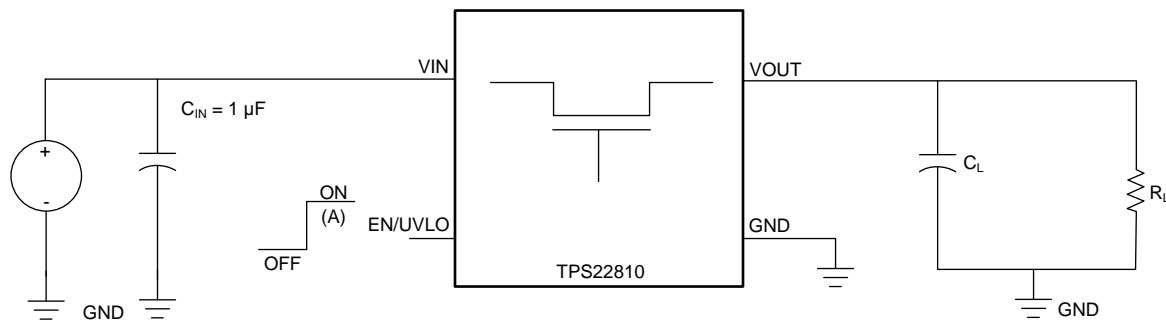

A. Rise and fall times of the control signal are 100 ns

Figure 16. Test Circuit

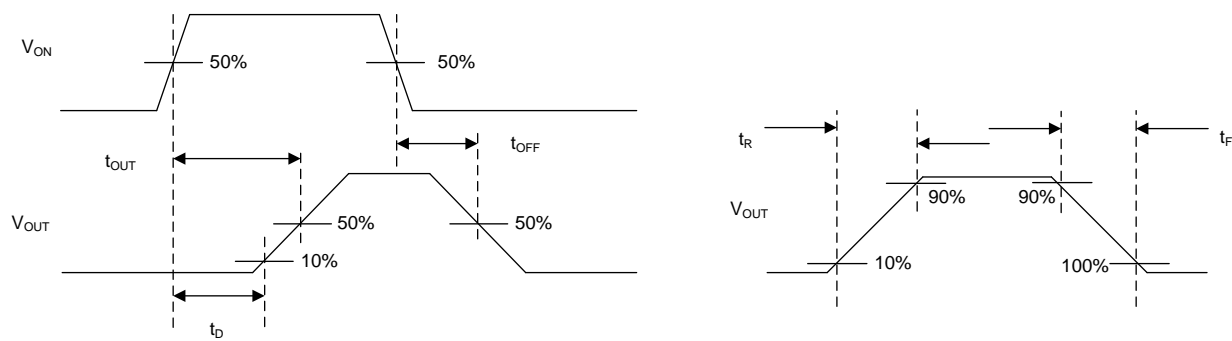

Figure 17. Timing Waveforms

9 Detailed Description

9.1 Overview

The TPS22810 is a 6-pin, 2.7-18-V load switch with thermal protection in two separate package options. To reduce voltage drop for low voltage and high current rails, the device implements a low resistance N-channel MOSFET which reduces the drop out voltage across the device.

The device starts its operation by monitoring the VIN bus. When VIN exceeds the undervoltage-lockout threshold (VUVR), the device samples the EN/UVLO pin. A high level on this pin enables the internal MOSFET. As VIN rises, the internal MOSFET of the device starts conducting and allow current to flow from VIN to VOUT. When EN/UVLO is held low (below V_{ENF}), internal MOSFET is turned off.

A voltage $V(\text{EN/UVLO}) < V(\text{ENF})$ on this pin turns off the internal FET, thus disconnecting VIN from VOUT, while voltage below V_(SHUTF) takes the device into shutdown mode, with I_Q less than 1 μA to ensure minimal power loss.

The device has a configurable slew rate which helps reduce or eliminate power supply droop because of large inrush currents. The device also features an internal RPD resistor, which discharges VOUT once the switch is disabled.

During shutdown, the device has very low leakage currents, thereby reducing unnecessary leakages for downstream modules during standby. Integrated control logic, driver, charge pump, and output discharge FET eliminates the need for any external components which reduces solution size and bill of materials (BOM) count.

The device also features a QOD pin, which allows the configuration of the discharge rate of VOUT once the switch is disabled.

The device has a thermal protection feature. Due to this device protects itself against thermal damage due to over-temperature and over-current conditions. Safe Operating Area (SoA) requirements are thus inherently met without any special design consideration by the board designer.

9.2 Functional Block Diagram

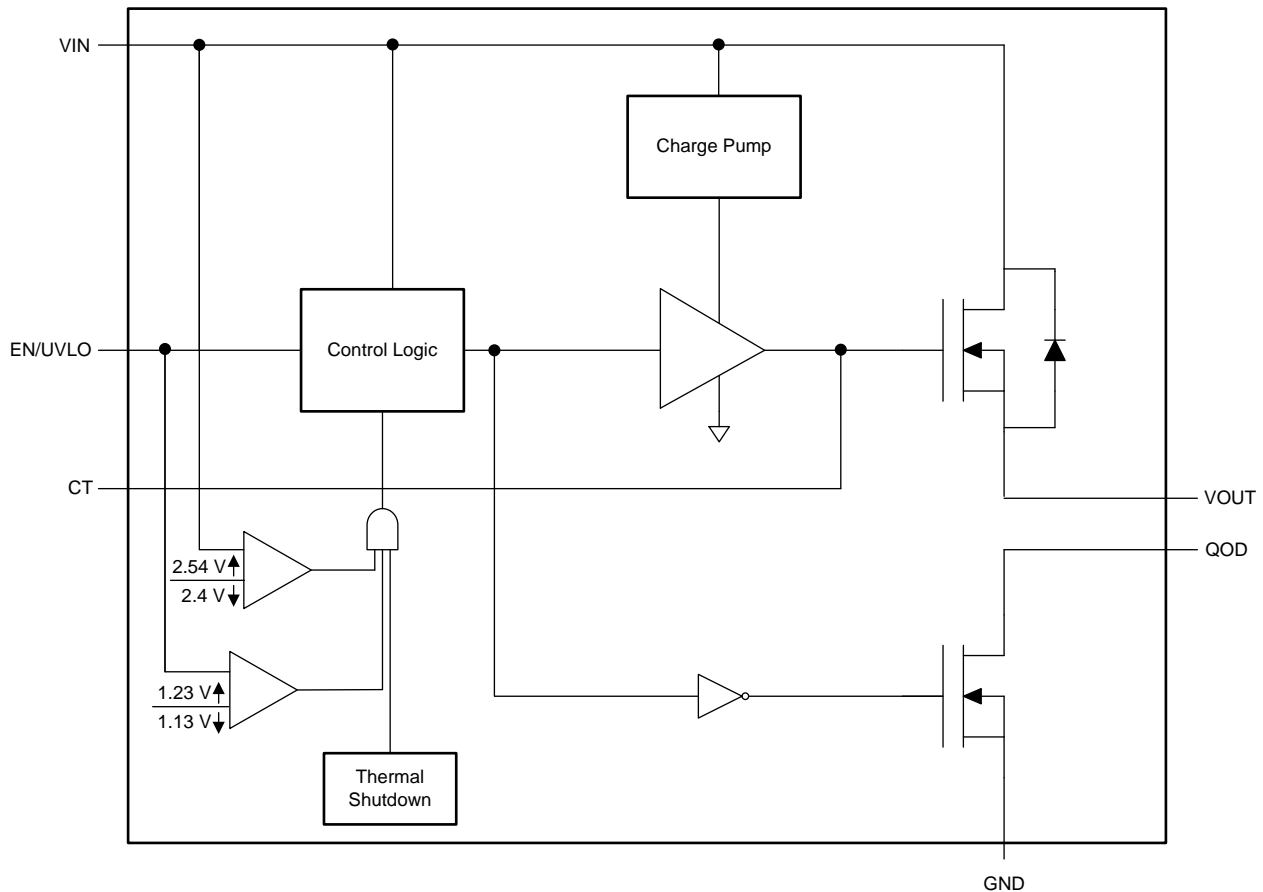

Copyright © 2016, Texas Instruments Incorporated

9.3 Feature Description

9.3.1 On and Off Control

The EN/UVLO pin controls the state of the switch. EN/UVLO is active high and has a low threshold, making it capable of interfacing with low-voltage signals. The EN/UVLO pin is compatible with standard GPIO logic threshold. It can be used with any microcontroller with 1.2 V or higher GPIO voltage. This pin cannot be left floating and must be driven either high or low for proper functionality.

9.3.2 Quick Output Discharge (QOD)

The TPS22810 includes a QOD feature. The QOD pin can be configured in one of three ways:

- QOD pin shorted to VOUT pin. Using this method, the discharge rate after the switch becomes disabled is controlled with the value of the internal resistance R_{PD} . The value of this resistance is listed in the [Electrical Characteristics](#) table.
- QOD pin connected to VOUT pin using an external resistor R_{EXT} . After the switch becomes disabled, the discharge rate is controlled by the value of the total resistance of the QOD. To adjust the total QOD resistance, [Equation 1](#) can be used.

$$R_{QOD} = R_{PD} + R_{EXT}$$

where

- R_{QOD} is the total output discharge resistance
- R_{PD} is the internal pulldown resistance
- R_{EXT} is the external resistance placed between the VOUT and QOD pin.

(1)

Feature Description (continued)

- QOD pin is unused and left floating. Using this method, there is no quick output discharge functionality, and the output remains floating after the switch is disabled.

Note that during thermal shutdown, the QOD functionality is not available. The device does not discharge the load as RPD does not become engaged.

The fall times of the device depend on many factors including the total resistance of the QOD, V_{IN} , and the output capacitance. When QOD is connected to VOUT, the fall time changes over V_{IN} as the internal R_{PD} varies over V_{IN} . To calculate the approximate fall time of V_{OUT} for a given R_{QOD} , use Equation 2 and Table 1.

$$V_{CAP} = V_{IN} \times e^{-t/\tau}$$

where

- V_{CAP} is the voltage across the capacitor (V)
- t is the time since power supply removal (s)
- τ is the time constant equal to $R_{QOD} \times C_L$ (2)

The fall times' dependency on V_{IN} becomes minimal as the QOD value increases with additional external resistance. See Table 1 for QOD fall times.

Table 1. QOD Fall Times

V_{IN} (V)	FALL TIME (μ s) 90% - 10%, $C_{IN} = 1 \mu$ F, $I_{OUT} = 0$ A, $V_{IN} = 0$ V, ON = 0 V ⁽¹⁾					
	$T_A = 25^\circ$ C			$T_A = 85^\circ$ C		
	$C_L = 1 \mu$ F	$C_L = 10 \mu$ F	$C_L = 100 \mu$ F	$C_L = 1 \mu$ F	$C_L = 10 \mu$ F	$C_L = 100 \mu$ F
18	470	4700	47000	470	4700	47000
12	450	4500	45000	450	4500	45000
9	440	4400	44000	440	4400	44000
5	500	5000	50000	480	4800	48000
3.3	600	6000	60000	570	5700	57000

(1) TYPICAL VALUES WITH QOD SHORTED TO VOUT

9.3.2.1 QOD when System Power is Removed

The adjustable QOD can be used to control the power down sequencing of a system even when the system power supply is removed. When the power is removed, the input capacitor, C_{IN} , discharges at V_{IN} . Past the set UVLO level, the pull-down resistance RPD becomes disabled and the output no longer becomes discharged. If there is still remaining charge on the output capacitor, this results in longer fall times. Care must be taken such that C_{IN} is large enough to meet the device UVLO settings.

9.3.2.2 Internal QOD Considerations

Special considerations must be taken when using the internal R_{PD} by shorting the QOD pin to the VOUT pin. The internal R_{PD} is a pulldown resistance designed to quickly discharge a load after the switch has been disabled. Care must be used to ensure that excessive current does not flow through R_{PD} during discharge so that the maximum T_J of 125° C is not exceeded. When using only the internal R_{PD} to discharge a load, the total capacitive load must not exceed 200 μ F. Otherwise, an external resistor, R_{EXT} , must be used to ensure the amount of current flowing through R_{PD} is properly limited and the maximum T_J is not exceeded. To ensure the device is not damaged, the remaining charge from C_L needs to decay naturally through the internal QOD resistance and must not be driven.

9.3.3 EN/UVLO

As an input pin, EN/UVLO controls the ON and OFF state of the internal MOSFET. In its high state, the internal MOSFET is enabled. A low on this pin turns off the internal MOSFET. High and Low levels are specified in the parametric table of the datasheet

A voltage $V(EN/UVLO < V(ENF))$ on this pin turns off the internal FET, thus disconnecting V_{IN} from V_{OUT} , while voltage below $V(SHUTF)$ takes the device into shutdown mode, with I_Q less than 1 μ A to ensure minimal power loss.

The EN/UVLO pin can be directly driven by a 1.8 V, 3.3 V or 5 V general purpose output pin.

The internal de-glitch delay on EN/UVLO falling edge is intentionally kept low (2.5 μ s typical) for quick detection of power failure. For applications where a higher de-glitch delay on EN/UVLO is desired, or when the supply is particularly noisy, it is recommended to use an external bypass capacitor from EN/UVLO to GND.

The undervoltage lock out can be programmed by using an external resistor divider from supply VIN terminal to EN/UVLO terminal to GND as shown in Figure 18. When an undervoltage or input power fail event is detected, the internal FET is quickly turned off. If the Under-Voltage Lock-Out function is not needed, the EN/UVLO terminal must be connected to the VIN terminal. EN/UVLO terminal must not be left floating.

The device also implements internal undervoltage-lockout (UVLO) circuitry on the VIN terminal. The device disables when the VIN terminal voltage falls below internal UVLO Threshold V(UVF). The internal UVLO threshold has a hysteresis of 125 mV (5% of V(UVR)). See Figure 19 and Figure 20.



Copyright © 2016, Texas Instruments Incorporated

Figure 18. Configuring UVLO with External Resistor Network

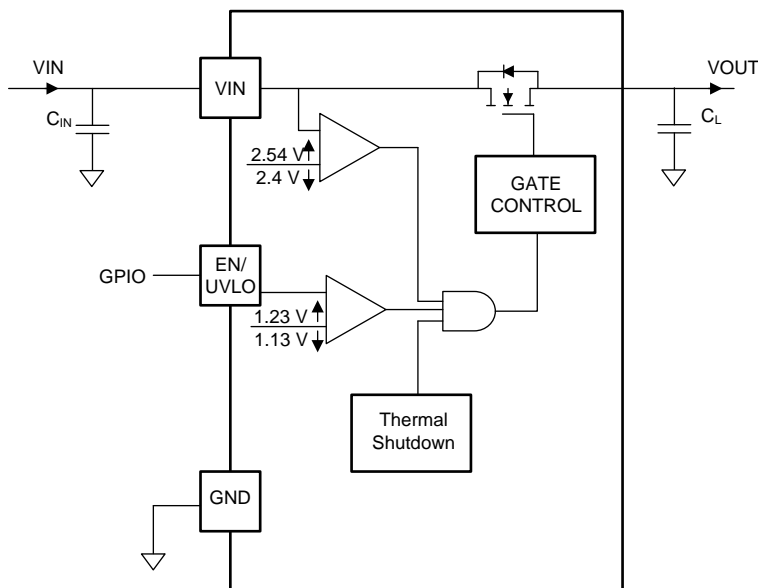

Copyright © 2016, Texas Instruments Incorporated

Figure 19. Using 1.8 V/3.3 V GPIO Signal Directly from Processor

Copyright © 2016, Texas Instruments Incorporated

Figure 20. Default UVLO Threshold V(UVR) Using No Additional External Components

9.3.4 Adjustable Rise Time (CT)

A capacitor to GND on the CT pin sets the slew rate. The voltage on the CT pin can be as high as 2.5 V. An approximate formula for the relationship between CT and slew rate is shown in [Equation 3](#). This equation accounts for 10% to 90% measurement on VOUT and does NOT apply for CT < 1 nF.

Use [Table 2](#) to determine rise times for when Ct ≥ 1 nF.

$$SR = 46.62 / Ct$$

where

- SR is the slew rate (in V/μs)

- CT is the the capacitance value on the CT pin (in pF)
- The units for the constant a are $\mu\text{s}/\text{V}$. The units for the constant b are $\mu\text{s}/(\text{V} \times \text{pF})$. (3)

Rise time can be calculated by dividing the input voltage by the slew rate. [Table 2](#) contains rise time values measured on a typical device. Rise times shown below are only valid for the power-up sequence where VIN is already in steady state condition before the EN/UVLO pin is asserted high.

Table 2. Rise Time Table

CT (pF)	RISE TIME (μs) 10% - 90%, $C_L = 0.1 \mu\text{F}$, $C_{IN} = 1 \mu\text{F}$, $R_L = 10 \Omega$				
	VIN = 18 V	VIN = 12 V	VIN = 9 V	VIN = 5 V	VIN = 3.3 V
0	115	91	78	60	98
470	136	94	80	63	98
1000	310	209	158	91	102
2200	688	464	345	198	135
4700	1430	957	704	397	265
10000	3115	2085	1540	864	550
27000	8230	5460	4010	2245	1430

9.3.5 Thermal Shutdown

The switch disables when the junction temperature (T_J) rises above the thermal shutdown threshold, T_{SD} . The switch re-enables once the temperature drops below the $T_{SD} - T_{SD,HYS}$ value.

9.4 Device Functional Modes

The features of the TPS22810 depend on the operating mode. [Table 3](#) summarizes the Device Functional Modes.

Table 3. Function Table

EN/UVLO	Device State
L	Disabled
H	Enabled

10 Application and Implementation

NOTE

Information in the following applications sections is not part of the TI component specification, and TI does not warrant its accuracy or completeness. TI's customers are responsible for determining suitability of components for their purposes. Customers should validate and test their design implementation to confirm system functionality.

10.1 Application Information

This section highlights some of the design considerations when implementing this device in various applications. A PSPICE model for this device is also available in the product page of this device on www.ti.com (See the [Device Support](#) section for more information).

10.2 ON and OFF Control

The EN/UVLO pin controls the state of the switch. Asserting EN/UVLO high enables the switch. EN/UVLO is active high and has a low threshold, making it capable of interfacing with low-voltage signals. The EN/UVLO pin is compatible with standard GPIO logic thresholds. It can be used with any microcontroller with 1.2 V or higher GPIO voltage. This pin cannot be left floating and must be driven either high or low for proper functionality.

10.3 Input Capacitor (Optional)

To limit the voltage drop on the input supply caused by transient inrush currents when the switch turns on into a discharged load capacitor, a capacitor needs to be placed between VIN and GND. A 1- μ F ceramic capacitor, C_{IN} , placed close to the pins, is usually sufficient. Higher values of C_{IN} can be used to further reduce the voltage drop during high current applications. When switching heavy loads, it is recommended to have an input capacitor about 10 times higher than the output capacitor to avoid excessive voltage drop.

10.4 Output Capacitor (Optional)

Due to the integrated body diode in the NMOS switch, a C_{IN} greater than C_L is highly recommended. A C_L greater than C_{IN} can cause VOUT to exceed VIN when the system supply is removed. This can result in current flow through the body diode from VOUT to VIN. A C_{IN} to C_L ratio of 10 to 1 is recommended for minimizing VIN dip caused by inrush currents during startup; however, a 10 to 1 ratio for capacitance is not required for proper functionality of the device. A ratio smaller than 10 to 1 (such as 1 to 1) can cause slightly more VIN dip upon turnon due to inrush currents.

This can be mitigated by increasing the capacitance on the CT pin for a longer rise time.

10.5 Typical Application

This typical application demonstrates how the TPS22810 can be used to power downstream modules.

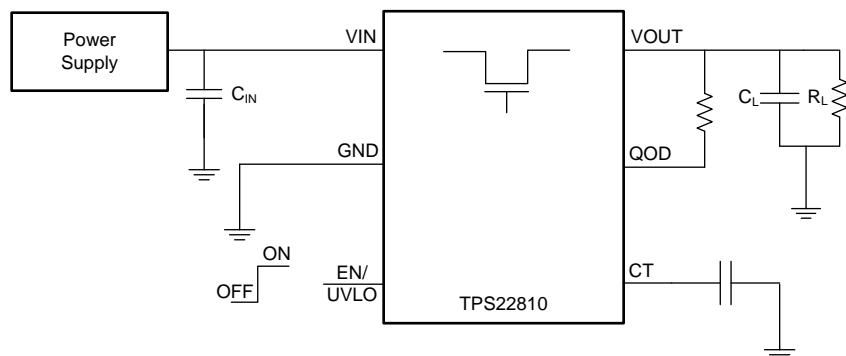

Copyright © 2016, Texas Instruments Incorporated

Figure 21. Typical Application Schematic

Typical Application (continued)

10.5.1 Design Requirements

For this design example, use the values listed in [Table 4](#) as the design parameters:

Table 4. Design Parameters

DESIGN PARAMETER	EXAMPLE VALUE
V_{IN}	12 V
Load current	2 A
C_L	22 μ F
Desired fall time	20 ms
Maximum acceptable inrush current	400 mA

10.5.2 Detailed Design Procedure

10.5.2.1 Shutdown Sequencing During Unexpected Power Loss

Using the adjustable Quick Output Discharge function of the TPS22810, adding a load switch to each power rail can be used to manage the power down sequencing in the event of an unexpected power loss (that is battery removal). To determine the QOD values for each load switch, first confirm the power down order of the device you wish to power sequence. Be sure to check if there are voltage or timing margins that must be maintained during power down. Next, consult [Table 1](#) to determine appropriate C_L and R_{QOD} values for each power rail's load switch so that the load switches' fall times correspond to the order in which they need to be powered down. In the above example, we must have this power rail's fall time to be 4 ms. Using [Equation 2](#), we can determine the appropriate R_{QOD} to achieve our desired fall time.

Since fall times are measured from 90% of V_{OUT} to 10% of V_{OUT} , using [Equation 2](#), we get [Equation 4](#) and [Equation 5](#).

$$1.2V = 10.8V \times e^{-(20ms)/(R_{QOD} \times (22\mu F))} \quad (4)$$

$$R_{QOD} = 413.7 \Omega \quad (5)$$

Consulting [Figure 6](#), R_{PD} at $V_{IN} = 12$ V is approximately 250 Ω . Using [Equation 1](#), the required external QOD resistance can be calculated as shown in [Equation 6](#) and [Equation 7](#).

$$413.7 \Omega = 250 \Omega + R_{EXT} \quad (6)$$

$$R_{EXT} = 163.7 \Omega \quad (7)$$

[Figure 22](#) through [Figure 25](#) are scope shots demonstrating an example of the QOD functionality when power is removed from the device (both ON and V_{IN} are disconnected simultaneously). In the scope shots, the $V_{IN} = 12$ V and correspond to when $R_{QOD} = 1000 \Omega$, $R_{QOD} = 500 \Omega$, and QOD = VOUT with two values of $C_L = 10 \mu$ F and 22 μ F.



Figure 22. Fall Time t_F at $V_{IN} = 12\text{ V}$, $R_{QOD} = 1000\ \Omega$



Figure 23. Fall Time t_F at $V_{IN} = 12\text{ V}$, $R_{QOD} = 500\ \Omega$



Figure 24. t_F at $V_{IN} = 12\text{ V}$, $QOD = V_{OUT}$



Figure 25. t_F at $V_{IN} = 12\text{ V}$, $R_{QOD} = 1000\ \Omega$



Figure 26. t_F at $V_{IN} = 12\text{ V}$, $R_{QOD} = 500\ \Omega$

Figure 27. t_F at $V_{IN} = 12\text{ V}$, $QOD = V_{OUT}$

10.5.2.2 VIN to VOUT Voltage Drop

The VIN to VOUT voltage drop in the device is determined by the R_{ON} of the device and the load current. The R_{ON} of the device depends upon the VIN conditions of the device. Refer to the R_{ON} specification of the device in the [Electrical Characteristics](#) table of this datasheet. Once the R_{ON} of the device is determined based upon the VIN conditions, use [Equation 8](#) to calculate the VIN to VOUT voltage drop.

$$\Delta V = I_{LOAD} \times R_{ON}$$

where

- ΔV is the voltage drop from VIN to VOUT
- I_{LOAD} is the load current
- R_{ON} is the On-resistance of the device for a specific V_{IN}

(8)

An appropriate I_{LOAD} must be chosen such that the I_{MAX} specification of the device is not violated.

10.5.2.3 Inrush Current

To determine how much inrush current is caused by the C_L capacitor, use [Equation 9](#).

$$I_{INRUSH} = C_L \times \frac{dV_{OUT}}{dt}$$

where

- I_{INRUSH} is the amount of inrush caused by C_L
- C_L is the capacitance on VOUT
- dt is the Output Voltage rise time during the ramp up of VOUT when the device is enabled
- dV_{OUT} is the change in V_{OUT} during the ramp up of VOUT when the device is enabled

(9)

The appropriate rise time can be calculated using the design requirements and the inrush current equation. As we calculate the rise time (measured from 10% to 90% of V_{OUT}), we account for this in our dV_{OUT} parameter (80% of $V_{OUT} = 9.6\text{ V}$) as shown in [Equation 10](#) and [Equation 11](#).

$$400\text{ mA} = 22\ \mu\text{F} \times 9.6\text{ V}/dt \tag{10}$$

$$dt = 528\ \mu\text{s} \tag{11}$$

To ensure an inrush current of less than 400 mA, choose a CT value that yields a rise time of more than 528 μs . Consulting [Table 2](#) at $V_{IN} = 12\text{ V}$, $CT = 4700\text{ pF}$ provides a typical rise time of 957 μs . Using this rise time and voltage into [Equation 9](#), yields [Equation 12](#) and [Equation 13](#).

$$I_{Inrush} = 22\ \mu\text{F} \times 9.6\text{ V}/957\ \mu\text{s} \tag{12}$$

$$I_{Inrush} = 220\text{ mA} \tag{13}$$

An appropriate C_L value must be placed on VOUT such that the I_{MAX} and I_{PLS} specifications of the device are not violated.

10.5.3 Application Curves

See the oscilloscope captures below for an example of how the CT capacitor can be used to reduce inrush current for $V_{IN} = 12\text{ V}$. See the [Adjustable Rise Time \(CT\)](#) section for rise times for corresponding CT values.

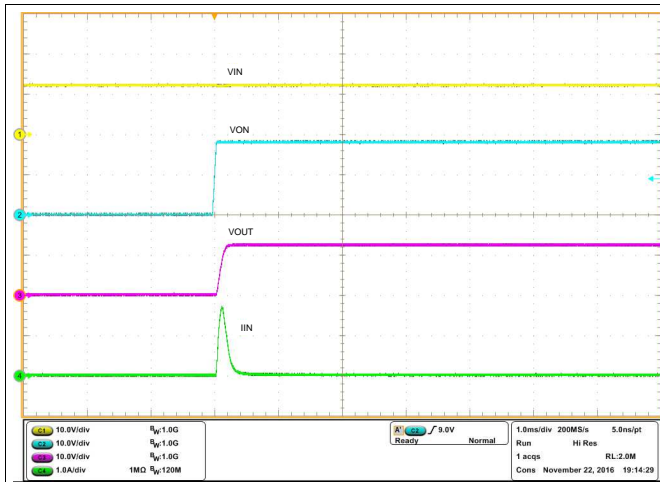

Figure 28. TPS22810 Inrush Current With $C_L = 22\ \mu\text{F}$, $CT = 0\ \text{pF}$

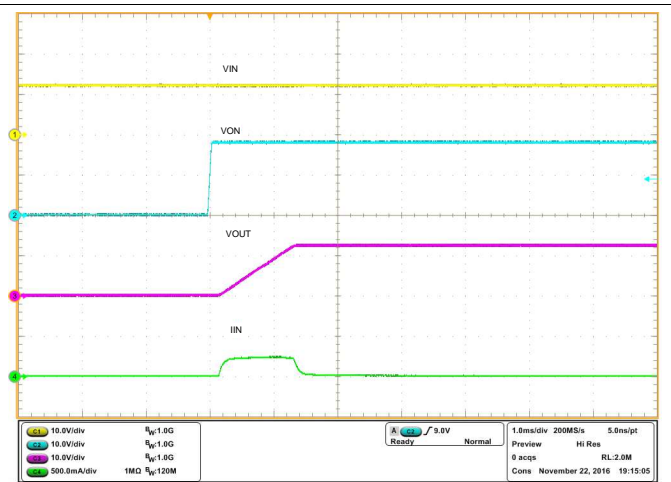

Figure 29. TPS22810 Inrush Current with $C_L = 22\ \mu\text{F}$, $CT = 4700\ \text{pF}$



Figure 30. TPS22810 Inrush Current With $C_L = 22\ \mu\text{F}$, $CT = 27000\ \text{pF}$



Figure 31. TPS22810 Inrush Current With $C_L = 100\ \mu\text{F}$, $CT = 0\ \text{pF}$



Figure 32. TPS22810 Inrush Current
With $C_L = 100 \mu\text{F}$, $C_T = 4700 \text{ pF}$



Figure 33. TPS22810 Inrush Current
With $C_L = 100 \mu\text{F}$, $C_T = 27000 \text{ pF}$

11 Power Supply Recommendations

The device is designed to operate from a V_{IN} range of 2.7 V to 18 V. This supply must be well regulated and placed as close to the device terminal as possible with the recommended 1- μF bypass capacitor. If the supply is located more than a few inches from the device terminals, additional bulk capacitance may be required in addition to the ceramic bypass capacitors. If additional bulk capacitance is required, an electrolytic, tantalum, or ceramic capacitor of 1 μF may be sufficient.

The TPS22810 operates regardless of power sequencing order. The order in which voltages are applied to V_{IN} and ON does not damage the device as long as the voltages do not exceed the absolute maximum operating conditions.

12 Layout

12.1 Layout Guidelines

- VIN and VOUT traces must be as short and wide as possible to accommodate for high current.
- The VIN pin must be bypassed to ground with low ESR ceramic bypass capacitors. The typical recommended bypass capacitance is 1- μ F ceramic with X5R or X7R dielectric. This capacitor must be placed as close to the device pins as possible.

12.2 Layout Example



Figure 34. Recommended Board Layout

12.3 Thermal Considerations

For best performance, all traces must be as short as possible. To be most effective, the input and output capacitors must be placed close to the device to minimize the effects that parasitic trace inductances may have on normal and short-circuit operation. Using wide traces for VIN, VOUT, and GND helps minimize the parasitic electrical effects along with minimizing the case to ambient thermal impedance.

The maximum IC junction temperature must be restricted to 150°C under normal operating conditions. To calculate the maximum allowable dissipation, $P_{D(max)}$ for a given output current and ambient temperature, use [Equation 14](#).

$$P_{D(MAX)} = \frac{T_{J(MAX)} - T_A}{\theta_{JA}}$$

where

- $P_{D(MAX)}$ is the maximum allowable power dissipation
- $T_{J(MAX)}$ is the maximum allowable junction temperature (150°C for the TPS22810)
- T_A is the ambient temperature of the device
- θ_{JA} is the junction to air thermal impedance. Refer to the [Thermal Information](#) table. This parameter is highly dependent upon board layout. (14)

13 Device and Documentation Support

13.1 Device Support

13.1.1 Developmental Support

For the TPS22810 PSpice Transient Model, see [TPS22810 PSpice Transient Model](#)

13.2 Documentation Support

13.2.1 Related Documentation

For related documentation see the following:

- [TPS22810 Load Switch Evaluation Module](#)
- [Selecting a Load Switch to Replace a Discrete Solution](#)
- [Timing of Load Switches](#)

13.3 Receiving Notification of Documentation Updates

To receive notification of documentation updates—including silicon errata—go to the product folder for your device on ti.com. In the upper right-hand corner, click the *Alert me* button. This registers you to receive a weekly digest of product information that has changed (if any). For change details, check the revision history of any revised document.

13.4 Community Resources

The following links connect to TI community resources. Linked contents are provided "AS IS" by the respective contributors. They do not constitute TI specifications and do not necessarily reflect TI's views; see TI's [Terms of Use](#).

TI E2E™ Online Community *TI's Engineer-to-Engineer (E2E) Community*. Created to foster collaboration among engineers. At e2e.ti.com, you can ask questions, share knowledge, explore ideas and help solve problems with fellow engineers.

Design Support *TI's Design Support* Quickly find helpful E2E forums along with design support tools and contact information for technical support.

13.5 Trademarks

E2E is a trademark of Texas Instruments.

All other trademarks are the property of their respective owners.

13.6 Electrostatic Discharge Caution



This integrated circuit can be damaged by ESD. Texas Instruments recommends that all integrated circuits be handled with appropriate precautions. Failure to observe proper handling and installation procedures can cause damage.

ESD damage can range from subtle performance degradation to complete device failure. Precision integrated circuits may be more susceptible to damage because very small parametric changes could cause the device not to meet its published specifications.

13.7 Glossary

[SLYZ022](#) — *TI Glossary*.

This glossary lists and explains terms, acronyms, and definitions.

14 Mechanical, Packaging, and Orderable Information

The following pages include mechanical, packaging, and orderable information. This information is the most current data available for the designated devices. This data is subject to change without notice and revision of this document. For browser-based versions of this data sheet, refer to the left-hand navigation.

PACKAGING INFORMATION

Orderable part number	Status (1)	Material type (2)	Package Pins	Package qty Carrier	RoHS (3)	Lead finish/ Ball material (4)	MSL rating/ Peak reflow (5)	Op temp (°C)	Part marking (6)
TPS22810DBVR	Active	Production	SOT-23 (DBV) 6	3000 LARGE T&R	Yes	NIPDAU SN	Level-1-260C-UNLIM	-40 to 105	19HF
TPS22810DBVR.A	Active	Production	SOT-23 (DBV) 6	3000 LARGE T&R	Yes	NIPDAU	Level-1-260C-UNLIM	-40 to 105	19HF
TPS22810DBVRG4	Active	Production	SOT-23 (DBV) 6	3000 LARGE T&R	Yes	NIPDAU	Level-1-260C-UNLIM	-40 to 105	19HF
TPS22810DBVRG4.A	Active	Production	SOT-23 (DBV) 6	3000 LARGE T&R	Yes	NIPDAU	Level-1-260C-UNLIM	-40 to 105	19HF
TPS22810DBVT	Active	Production	SOT-23 (DBV) 6	250 SMALL T&R	Yes	NIPDAU SN	Level-1-260C-UNLIM	-40 to 105	19HF
TPS22810DBVT.A	Active	Production	SOT-23 (DBV) 6	250 SMALL T&R	Yes	SN	Level-1-260C-UNLIM	-40 to 105	19HF
TPS22810DRV	Active	Production	WSON (DRV) 6	3000 LARGE T&R	Yes	NIPDAU	Level-1-260C-UNLIM	-40 to 105	1CRH
TPS22810DRV.A	Active	Production	WSON (DRV) 6	3000 LARGE T&R	Yes	NIPDAU	Level-1-260C-UNLIM	-40 to 105	1CRH
TPS22810DRVG4	Active	Production	WSON (DRV) 6	3000 LARGE T&R	Yes	NIPDAU	Level-1-260C-UNLIM	-40 to 105	1CRH
TPS22810DRVG4.A	Active	Production	WSON (DRV) 6	3000 LARGE T&R	Yes	NIPDAU	Level-1-260C-UNLIM	-40 to 105	1CRH
TPS22810DRVT	Active	Production	WSON (DRV) 6	250 SMALL T&R	Yes	NIPDAU	Level-1-260C-UNLIM	-40 to 105	1CRH
TPS22810DRVT.A	Active	Production	WSON (DRV) 6	250 SMALL T&R	Yes	NIPDAU	Level-1-260C-UNLIM	-40 to 105	1CRH

(1) **Status:** For more details on status, see our [product life cycle](#).

(2) **Material type:** When designated, preproduction parts are prototypes/experimental devices, and are not yet approved or released for full production. Testing and final process, including without limitation quality assurance, reliability performance testing, and/or process qualification, may not yet be complete, and this item is subject to further changes or possible discontinuation. If available for ordering, purchases will be subject to an additional waiver at checkout, and are intended for early internal evaluation purposes only. These items are sold without warranties of any kind.

(3) **RoHS values:** Yes, No, RoHS Exempt. See the [TI RoHS Statement](#) for additional information and value definition.

(4) **Lead finish/Ball material:** Parts may have multiple material finish options. Finish options are separated by a vertical ruled line. Lead finish/Ball material values may wrap to two lines if the finish value exceeds the maximum column width.

(5) **MSL rating/Peak reflow:** The moisture sensitivity level ratings and peak solder (reflow) temperatures. In the event that a part has multiple moisture sensitivity ratings, only the lowest level per JEDEC standards is shown. Refer to the shipping label for the actual reflow temperature that will be used to mount the part to the printed circuit board.

(6) **Part marking:** There may be an additional marking, which relates to the logo, the lot trace code information, or the environmental category of the part.

Multiple part markings will be inside parentheses. Only one part marking contained in parentheses and separated by a "-" will appear on a part. If a line is indented then it is a continuation of the previous line and the two combined represent the entire part marking for that device.

Important Information and Disclaimer:The information provided on this page represents TI's knowledge and belief as of the date that it is provided. TI bases its knowledge and belief on information provided by third parties, and makes no representation or warranty as to the accuracy of such information. Efforts are underway to better integrate information from third parties. TI has taken and continues to take reasonable steps to provide representative and accurate information but may not have conducted destructive testing or chemical analysis on incoming materials and chemicals. TI and TI suppliers consider certain information to be proprietary, and thus CAS numbers and other limited information may not be available for release.

In no event shall TI's liability arising out of such information exceed the total purchase price of the TI part(s) at issue in this document sold by TI to Customer on an annual basis.

OTHER QUALIFIED VERSIONS OF TPS22810 :

- Automotive : [TPS22810-Q1](#)

NOTE: Qualified Version Definitions:

- Automotive - Q100 devices qualified for high-reliability automotive applications targeting zero defects

TAPE AND REEL INFORMATION

QUADRANT ASSIGNMENTS FOR PIN 1 ORIENTATION IN TAPE

*All dimensions are nominal

Device	Package Type	Package Drawing	Pins	SPQ	Reel Diameter (mm)	Reel Width W1 (mm)	A0 (mm)	B0 (mm)	K0 (mm)	P1 (mm)	W (mm)	Pin1 Quadrant
TPS22810DBVR	SOT-23	DBV	6	3000	180.0	8.4	3.2	3.2	1.4	4.0	8.0	Q3
TPS22810DBVRG4	SOT-23	DBV	6	3000	180.0	8.4	3.2	3.2	1.4	4.0	8.0	Q3
TPS22810DBVT	SOT-23	DBV	6	250	180.0	8.4	3.2	3.2	1.4	4.0	8.0	Q3
TPS22810DRVR	WSON	DRV	6	3000	178.0	8.4	2.3	2.3	1.15	4.0	8.0	Q2
TPS22810DRVRG4	WSON	DRV	6	3000	180.0	8.4	2.3	2.3	1.15	4.0	8.0	Q2
TPS22810DRVT	WSON	DRV	6	250	180.0	8.4	2.3	2.3	1.15	4.0	8.0	Q2

TAPE AND REEL BOX DIMENSIONS

*All dimensions are nominal

Device	Package Type	Package Drawing	Pins	SPQ	Length (mm)	Width (mm)	Height (mm)
TPS22810DBVR	SOT-23	DBV	6	3000	210.0	185.0	35.0
TPS22810DBVRG4	SOT-23	DBV	6	3000	210.0	185.0	35.0
TPS22810DBVT	SOT-23	DBV	6	250	210.0	185.0	35.0
TPS22810DRVR	WSON	DRV	6	3000	208.0	191.0	35.0
TPS22810DRVRG4	WSON	DRV	6	3000	210.0	185.0	35.0
TPS22810DRVT	WSON	DRV	6	250	210.0	185.0	35.0

EXAMPLE BOARD LAYOUT

DBV0006A

SOT-23 - 1.45 mm max height

SMALL OUTLINE TRANSISTOR



LAND PATTERN EXAMPLE
EXPOSED METAL SHOWN
SCALE:15X

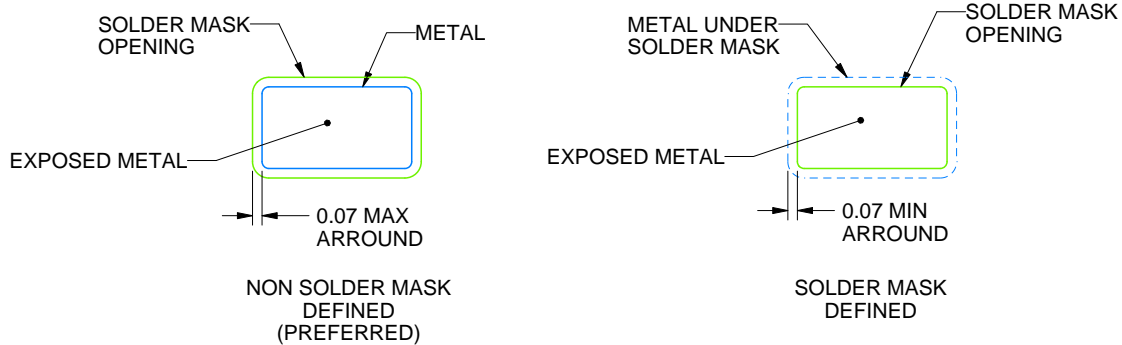

SOLDER MASK DETAILS

4214840/G 08/2024

NOTES: (continued)

6. Publication IPC-7351 may have alternate designs.
7. Solder mask tolerances between and around signal pads can vary based on board fabrication site.

EXAMPLE STENCIL DESIGN

DBV0006A

SOT-23 - 1.45 mm max height

SMALL OUTLINE TRANSISTOR



SOLDER PASTE EXAMPLE
BASED ON 0.125 mm THICK STENCIL
SCALE:15X

4214840/G 08/2024

NOTES: (continued)

8. Laser cutting apertures with trapezoidal walls and rounded corners may offer better paste release. IPC-7525 may have alternate design recommendations.
9. Board assembly site may have different recommendations for stencil design.

GENERIC PACKAGE VIEW

DRV 6

WSON - 0.8 mm max height

PLASTIC SMALL OUTLINE - NO LEAD



Images above are just a representation of the package family, actual package may vary.
Refer to the product data sheet for package details.

4206925/F



4222173/C 11/2025

NOTES:

1. All linear dimensions are in millimeters. Any dimensions in parenthesis are for reference only. Dimensioning and tolerancing per ASME Y14.5M.
2. This drawing is subject to change without notice.
3. The package thermal pad must be soldered to the printed circuit board for thermal and mechanical performance.
4. Minimum 0.1 mm solder wetting on pin side wall. Available for wettable flank version only.

EXAMPLE BOARD LAYOUT

DRV0006A

WSON - 0.8 mm max height

PLASTIC SMALL OUTLINE - NO LEAD

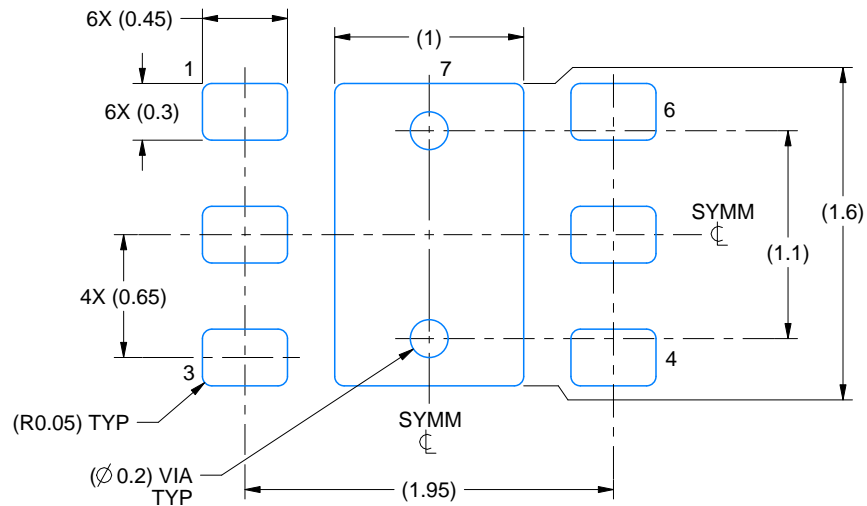

LAND PATTERN EXAMPLE
SCALE:25X



SOLDER MASK DETAILS

4222173/C 11/2025

NOTES: (continued)

5. This package is designed to be soldered to a thermal pad on the board. For more information, see Texas Instruments literature number SLUA271 (www.ti.com/lit/slua271).
6. Vias are optional depending on application, refer to device data sheet. If some or all are implemented, recommended via locations are shown.

EXAMPLE STENCIL DESIGN

DRV0006A

WSON - 0.8 mm max height

PLASTIC SMALL OUTLINE - NO LEAD



SOLDER PASTE EXAMPLE
BASED ON 0.125 mm THICK STENCIL

EXPOSED PAD #7
88% PRINTED SOLDER COVERAGE BY AREA UNDER PACKAGE
SCALE:30X

4222173/C 11/2025

NOTES: (continued)

7. Laser cutting apertures with trapezoidal walls and rounded corners may offer better paste release. IPC-7525 may have alternate design recommendations.

IMPORTANT NOTICE AND DISCLAIMER

TI PROVIDES TECHNICAL AND RELIABILITY DATA (INCLUDING DATASHEETS), DESIGN RESOURCES (INCLUDING REFERENCE DESIGNS), APPLICATION OR OTHER DESIGN ADVICE, WEB TOOLS, SAFETY INFORMATION, AND OTHER RESOURCES "AS IS" AND WITH ALL FAULTS, AND DISCLAIMS ALL WARRANTIES, EXPRESS AND IMPLIED, INCLUDING WITHOUT LIMITATION ANY IMPLIED WARRANTIES OF MERCHANTABILITY, FITNESS FOR A PARTICULAR PURPOSE OR NON-INFRINGEMENT OF THIRD PARTY INTELLECTUAL PROPERTY RIGHTS.

These resources are intended for skilled developers designing with TI products. You are solely responsible for (1) selecting the appropriate TI products for your application, (2) designing, validating and testing your application, and (3) ensuring your application meets applicable standards, and any other safety, security, regulatory or other requirements.

These resources are subject to change without notice. TI grants you permission to use these resources only for development of an application that uses the TI products described in the resource. Other reproduction and display of these resources is prohibited. No license is granted to any other TI intellectual property right or to any third party intellectual property right. TI disclaims responsibility for, and you fully indemnify TI and its representatives against any claims, damages, costs, losses, and liabilities arising out of your use of these resources.

TI's products are provided subject to [TI's Terms of Sale](#), [TI's General Quality Guidelines](#), or other applicable terms available either on ti.com or provided in conjunction with such TI products. TI's provision of these resources does not expand or otherwise alter TI's applicable warranties or warranty disclaimers for TI products. Unless TI explicitly designates a product as custom or customer-specified, TI products are standard, catalog, general purpose devices.

TI objects to and rejects any additional or different terms you may propose.

Copyright © 2026, Texas Instruments Incorporated

Last updated 10/2025